

APPENDIX 5  
USERS MANUAL

USER'S MANUAL (ELEVEN (11) PAGES) FOLLOWS THIS SHEET

USERS MANUAL  
FCC ID: MMA77255ESP  
APPENDIX 5

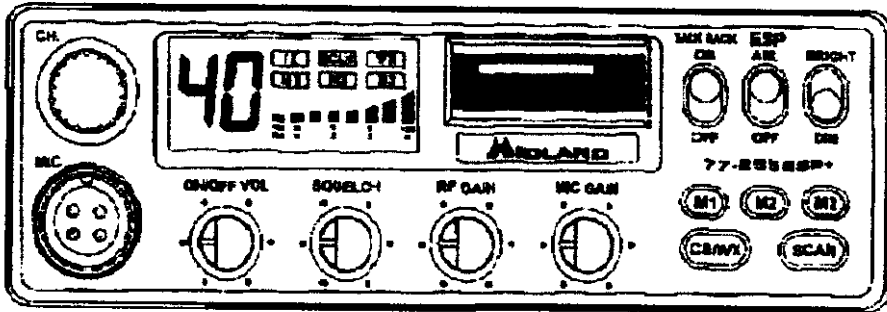

# 77-255ESP

40 Channel CB With Weather Receiver

Your 40 channel CB represents the state of the art in high tech engineering. This unit is not only a full feature CB transceiver but incorporates a high performance 10 channel NOAA weather bureau VHF receiver. The full 10-channel weather receiver allows use on all current and future NOAA weather bureau channels plus Canadian and international channels. The unit incorporates microprocessor controlled PLL circuitry for precise tuning and increased function. Receiver noise and interference can now be largely eliminated by the new ESP2™ noise reduction system. Also included is a backlighted Liquid Crystal Display (LCD) digital information center that out-dates CB's with LED readouts.

## **How to install your Midland mobile CB**

This transceiver may be installed in any **12 volt negative ground-system** car or truck. Almost all current U.S. and foreign vehicles use a negative system, but some older models and some newer large trucks may have a positive ground.

**Check the requirements for your vehicle before you begin installation.**

Generally, you have a **negative-ground** system if the minus ( - ) battery terminal is connected to the motor block. Contact your dealer in the event you are unable to determine your vehicle's polarity system.

### **Installation and operating accessories furnished with your Midland CB:**

1. Easy removal mounting bracket system.
2. Microphone bracket system.
3. All main-unit and microphone mounting hardware needed for normal installation.
4. Plug-in microphone with coil cord.
5. FCC part 95, Subpart D.
6. Owner's Manual.

## **Where to locate your CB transceiver.**

Your new Midland CB is designed to be installed under the dash or vertically on a console of your vehicle.

Safety and convenience are the primary considerations in deciding exactly where to locate your radio.

**Caution:** Be sure that the unit is located so that it does not interfere with the driver or impair access to any controls. Connecting cables must be routed and secured in such a manner as not to interfere with the operation of the brake, accelerator or other controls. Interference from either the unit or connecting cables may contribute to the loss of control of the vehicle.

### **Mechanical mounting**

**Note:** Extreme care should be exercised when drilling into dash to avoid damage to under-dash electronic ignition, cruise control, instrument and / or accessory wiring. Your unit must be mounted so as not to interfere with air bag (SRS) operation.

Step 1: Heeding the caution, use the mounting bracket as a template for marking the location of screw holes under the dash. Use an awl, nail or other sharp pointed object to mark the metal.

Step 2: Drill a 1/8" hole for each screw hole in the mounting bracket. Attach the bracket to the dash with the 3/8" Phillips machine screws provided.

Step 3: Locate and secure the radio into the mounting bracket allowing working space for later power connections.

### **Power wiring (negative ground only).**

Step 1: If you have not determined whether your vehicle has a negative or positive ground, do so now. Then disconnect the negative lead from the battery to prevent short circuits that can occur during wiring.

Step 3: With negative ground, connect the red wire (the one with in-line fuse holder) to either the ( a ) fuse block radio circuit (filtered), ( b ) cigarette lighter (unfiltered for noise), or ( c ) directly to the positive post on your battery.

(Usually, the fuse block is the most convenient connecting point. It is also possible to connect to the Accessory terminal on the fuse block, so that your CB automatically goes off when the ignition goes off, preventing accidental battery drainage.)

The orange wire supplies power for the memory retention feature. For the memory retention circuit to operate the orange wire must be connected to power that is not switched off by the ignition switch. The connection point can be directly to the battery or an unswitched fuse on the fuse block.

(Usually, the fuse block is the most convenient connecting point. It is also possible to connect the red wire to the Accessory terminal on the fuse block or ignition switch so that your CB automatically goes off when the ignition goes off, preventing a battery drain.)

**Note:** In many new vehicles the only circuit that has noise filtering is the radio circuit.

Then tightly connect the black wire directly to the vehicle's metal frame. A good direct metal - to - metal ground is essential for optimum performance. Installations using the cigarette lighter socket for power require an extra ground wire from the radio chassis to the vehicle if the radio is not fastened to a grounded part of the vehicle.

**Step 3:** Plug - in the power cord to the receptacle provided on the back of the transceiver.

### **Mounting the main unit.**

**Step 1:** Position the main unit between the bracket arms in line with the retention knobs. Set the angle for optimum operating comfort and accessibility.

**Step 2:** Tighten the retention knobs.

### **Installation of microphone hanger.**

Mounting holes are provided on the microphone hanger bracket. The bracket can be attached to the vehicle dash, or other convenient location.

## **Antenna: How to select, position install and tune the right one for you.**

Basically, you have two types of mobile CB antennas - full-length whip and loaded whip - and a variety of types of mounts (depending on where you locate your antenna) to choose from.

Midland markets a broad line of high-performance antennas. The dealer who sold you your Midland CB can advise which type is best for you.

### **Where you locate your antenna does make a difference.**

Some general rules for antenna location that can aid CB performance:

1. Put your antenna mount as high on the vehicle as possible.
2. The higher the proportion of antenna length that is above the roof, the better.
3. If possible, mount the antenna in the center of whatever surface you choose.
- 3
4. Keep antenna cables away from noise sources, such as the ignition system, gauges, electric fuel pumps, etc.
5. Make sure you have a solid metal - to - metal ground.
6. Exercise care to prevent cable damage.

Essentially, you have five location choices: the roof, gutter, rear deck, front cowl or rear bumper. Where you decide to locate your antenna will determine the type of antenna you install. Again consult your Midland CB dealer for advice and guidance, and measure your needs against the attributes of the various Midland antenna models he carries.

### **Antenna installation.**

Follow the manufacturer's installation instructions carefully.

Warning: Never operate your CB radio without attaching an antenna or with a broken antenna cable. This can result in damage to transmitter circuitry.

### Tuning your antenna.

Some antennas are factory tuned. However, performance can usually be improved by slightly lengthening or shortening its length, using a Standing Wave Ratio (SWR) meter. For the exact procedures to be used refer to the antenna manufacturer's installation manual.

You can buy an SWR meter separately or have your antenna checked by your Midland CB Dealer's service department or a two-way comm shop.

## 77-255ESP

### FUNCTION AND LOCATION OF CONTROLS

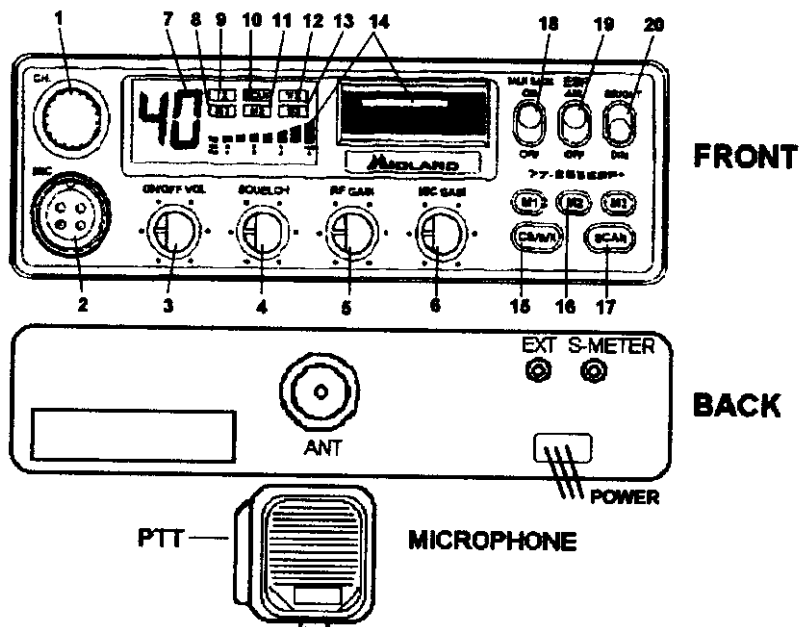

## FRONT PANEL CONTROLS

1. **ROTARY CHANNEL SELECTOR:** This easy to operate control allows changing of weather or CB channel, either up or down. This control will not operate when the channel "LOCK" function has been activated.
2. **MICROPHONE CONNECTOR:** Plug in the supplied microphone to this connector. The collar ring has a screw on locking ring. Push the ring onto the units collar and screw on until it is tight.
3. **ON/OFF VOLUME:** In the off position your transceiver's power is off. Turn this control clockwise to switch on the unit and adjust the volume.
4. **SQUELCH CONTROL:** Adjust this control until background noise just disappears. If the control is adjusted too far clockwise it may cause muting of weaker signals.
5. **RF GAIN CONTROL:** This control adjusts the receiver sensitivity. Adjust the control for best reception of distant or local stations. Begin with control fully clockwise. To reduce reception of unwanted distant stations, turn control counter-clockwise until only desired stations are heard.
6. **MIC GAIN CONTROL:** Rotating this control fully clockwise will result in the greatest microphone output. /rotating the control counter-clockwise reduces the microphone output, improving the sound in high noise environments. This control can also be used to control optional power microphone output.
7. **CHANNEL DISPLAY:** LCD (liquid crystal display) read-out of selected CB or weather channel.
- 8,11,13. **M1, M2, M3 INDICATOR:** These LCD boxes are illuminated when a memory button has been used to select the CB channel.
9. **TX INDICATOR:** LCD indicator for showing the unit is transmitting.
10. **SCAN INDICATOR:** This indicates channel scanning is operating.
12. **WX INDICATOR:** When this indicator is illuminated it indicates your unit is in the weather receive mode. Weather channels are displayed.
14. **S/RF DISPLAY:** LCD read-out of received signal strength and relative transmitter power output.



**15. CB/WX:** This button causes your unit to change modes between NOAA weather bureau receiver and CB operation.

**16. M1, M2, M3 BUTTONS:** These buttons select CB channels previously

set by the operator for quick recall. To store channels to memory:

- a. Select the desired channel using the rotary channel selector knob.
- b. Press and hold the memory button to be set for two seconds. Two beeps will sound when the channel is memorized.
- c. To recall a channel for use, press the desired memory button. The memorized channel will be selected and displayed.

**17. SCAN BUTTON:** This button when pressed and when the squelch is closed causes the channels to be scanned until a signal opens the squelch. Pressing the button again cancels scanning.

**18. TALK BACK SWITCH:** This switch allows the user to hear the transmitted audio as it is transmitted when it is set to "ON". This provides the operator with a means to monitor the effects of microphone gain adjustment and the sound of special audio effects units.

**19. ESP SWITCH:** Pressing this button controls the ESP2™ audio system. Channel noises are reduced and voices enhanced when ESP2™ is active.

**20. BRIGHT/DIM SWITCH:** Pressing this button causes the backlighting of the display to switch between dimmed and full brightness.

## **BACK PANEL**

**ANTENNA CONNECTOR:** Connect a standard 50-ohm CB antenna to this connector.

**S-METER JACK:** A DC voltmeter may be connected to this jack for precision monitoring of received signal strength.

**EXT SPEAKER JACK:** When a speaker is connected to this jack the internal speaker is by-passed. All received signals will be heard through the external speaker when it is connected. The speaker connected to the "EXT" jack should be rated at 8 ohms and 5 watts or more.

## **HOW TO OPERATE YOUR TRANSCEIVER FOR CB USE**

You should become familiar with the controls and complete the preceding installation instructions before attempting operation of your CB.

1. Adjust the squelch control fully counter-clockwise
2. Rotate the on/off volume control clockwise to turn the unit on. Adjust the volume for a normal listening level.
3. Select the desired channel by the rotary channel selector. Rotate the squelch control until the background noise is just quieted. You are now in the receive mode.

**NOTE:** If the channel will not change, check that the “

4. To transmit press the PTT bar on the side of the microphone. Hold the microphone 2 to 3 inches from your lips and speak in a normal voice.
5. To receive simply release the PTT bar.

## **TO OPERATE YOUR TRANSCEIVER FOR WEATHER RECEIVE**

1. Follow steps 1 and 2 above.
2. Press the “WX” button.
3. Using the rotary channel selector select the active channel in your area.

### **How ESP2™ works to make your CB sound better.**

The ESP2™ noise reduction system constantly monitors the signal strength and the type of noise present. When the signal strength is too low for good reception, the receiver sound is automatically adjusted to dramatically reduce the noise that comes through the speaker. While the noise is decreased the actual sounds you need to hear are increased.

Skip interference can cause whistles and howling sounds. Electrical interference from power lines, ignition systems or other sources can produce low humming and buzzing noise. These high and low sounds are not needed for communications. ESP2™ can determine the difference between undesired noises and sounds you want to hear and filter the noises out.

These results ESP2™ can accomplish without decreasing receiver range (it usually increases range). Most importantly, ESP2™ works by itself and does not need to be listening to other ESP2™ equipped CB's to be 100% effective.

## TECHNICAL SPECIFICATIONS

### GENERAL

Frequency range ..... 26.965-27.405 MHz  
Channels ..... 40  
Modulation type ..... AM  
Antenna impedance ..... 50 Ohm  
Loudspeaker ..... 8 Ohm  
Microphone ..... Electret  
Power Supply ..... 13.8 VDC negative ground

### RECEIVER ( CB, 26.965-27.405 MHz )

Sensitivity at 10db S/N ..... 0.6  $\mu$ V  
Selectivity ..... 6 db @ 5 KHz  
Squelch range ..... 0.5  $\mu$ V-500  $\mu$ V  
Audio output power ..... 3.0 W @ 8 Ohm ( 10% distortion)  
Distortion at 1000 mV ..... 3%  
Audio frequency response ..... 400-2400 Hz  
Intermediate frequency ..... I ° 10.695 MHz II ° 455 KHz  
Spurious response ..... more than 45 db

### TRANSMITTER

RF Output Power ..... 4.0 W  
Frequency Tolerance ..... 0.005%  
Harmonic Suppression ..... More than 60 db  
Modulation ..... AM 90% (  $\pm$  5%)

### SPECIFICATION - WEATHER RECEIVER

#### CHANNELS

00	163.275	05	162.450
01	162.550	06	162.500
02	162.400	07	162.525
03	162.475	08	161.650
04	162.425	09	161.775

Sensitivity ..... 1.0  $\mu$ V for 20 db  
Audio Power ..... 3.0 W  
Audio Load ..... 8 ohms  
Intermediate Frequency ..... 455 KHz

## LIMITED WARRANTY.

Midland Consumer Radio will repair or replace, at its option without charge, any Midland Mobile, Base Station, or full power Hand-Held Citizens Band transceiver which fails due to a defect in material or workmanship within one year following the initial consumer purchase.

This warranty does not include any carrying cases, earphones, or telescoping antennas which may be a part of or included with the warranted product, or the cost of labor for removal or re-installation of the product in a vehicle or other mounting.

Performance of any obligation under this warranty may be obtained by returning the warranted product, freight prepaid, along with proof of purchase date, to Midland Consumer Radio, Warranty Service Department 1670 North Topping, Kansas City, Missouri 64120, or to any "Midland Authorized Warranty Service Station," or to the place of purchase (if a participating dealer).

Warranty information and the location of the nearest "Midland Authorized Warranty Service Station," may be obtained by writing Midland Consumer Radio, Warranty Service Department.

This warranty gives you specific legal rights, and you may also have other rights which vary from state to state.

**Note:** The above warranty applies only to merchandise purchased in the United States of America or any of the territories or possessions or from U.S. military exchange. For warranty coverage on merchandise purchased elsewhere, consult the supplemental warranty information included with this product or ask your dealer.

## SERVICE

If it ever becomes necessary to return your unit for service:

Pack the unit in its original box and packing. Improper packing may result in damage during shipment. Include \$7.50 for return postage and handling. (Note: Some states do not require you to pay for postage and handling).

Include a full description of any problems. Include your telephone number.

You do not need to return accessory items (brackets, screws, power cord, antenna, etc.) unless they may be directly related to the problem.

Include a photocopy of the bill of sale or other proof of purchase showing the date of sale. This information must be included before warranty service can be considered.

A flat rate of \$45.00 will apply to repairs not covered by warranty. Send only cashiers check, money order or Master Card or Visa card number.

## MIDLAND CONSUMER RADIO

1670 N. Topping  
Kansas City, Mo. 64120

Phone 816-241-8500. Fax 816-241-5713 E-mail: [midlndcb@midlandradio.com](mailto:midlndcb@midlandradio.com)

Printed in China

APPENDIX 6  
ALIGNMENT INSTRUCTIONS

SIX (6) PAGES OF ADJUSTMENT PROCEDURES FOLLOW

ALIGNMENT INSTRUCTIONS  
FCC ID: MMA77255ESP

APPENDIX 6

## A. PLL SECTION

1. Test Equipment Required
  - a. Frequency Counter
  - b. DC Voltmeter (about 100K ohm)
  - c. DC Power Supply (13.8V, 2.5Amp.)

NOTE : Figure 1 provides test point and all alignment location information.

### 2. Test Set-Up

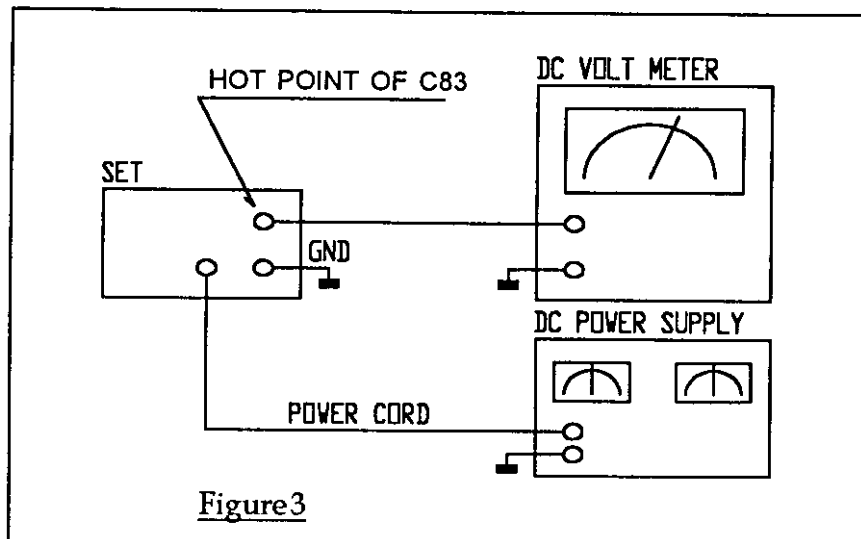
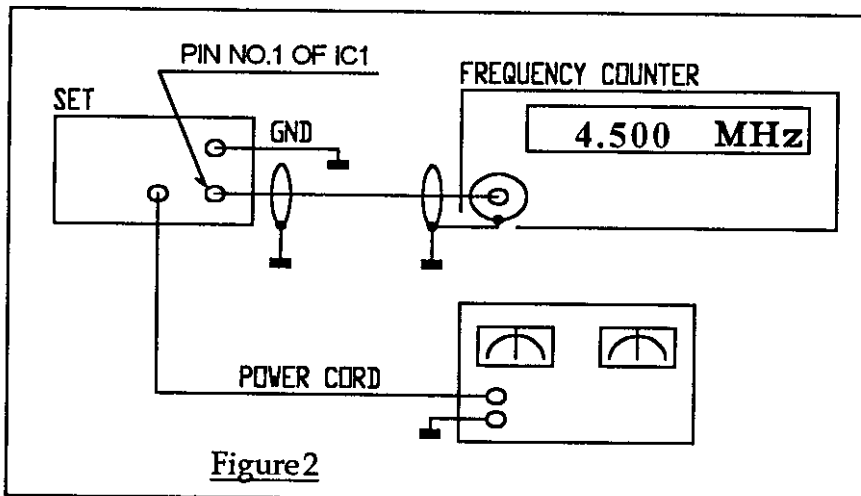

Document Number :  
Revision Number : 0  
Issue Date : 9 October, 1998.  
Page : Page 2 of 6

### 3. Alignment Procedure (VCO)

STEP	CONTROL SETTING	OUTPUT INDICATOR CONNECTION	ADJUST	ADJUST FOR
1.	Alignment of Ref. Osc.			
	Mic :Receive POWER :On VOLUME :Optional SQUELCH :Optional Channel Selector : optional	Connect frequency counter to PIN NO.1 of IC1 .(Figure 2)	TC1	Adjust for 4.500 MHz $\pm$ 20Hz indication on frequency counter
2.	Alignment of VCO			
	MIC :Tx or Rx POWER :On VOLUME :Optional SQUELCH :Optional Channel Selector : Channel 40	Connect DC voltmeter to hot point of C83. (Figure 3)	T7	Adjust for 3.8V indication on DC voltmeter. (Before adjust T7 must select high VCO voltage mode.)
3.	MIC :Tx or Rx POWER :On VOLUME :Optional SQUELCH :Optional Channel Selector : Channel 1	Same as step 2.	Check the indication on DC voltmeter (must be over 2.0V). If DC voltmeter under 2.0V, readjust T7 and return to step 2.	

## B. TRANSMITTER SECTION

1. Test Equipment Required
  - a. RF Power Meter
  - b. 50 ohm dummy w/ attenuator
  - c. RF Voltmeter
  - d. DC Power Supply (13.8V, 2.5Amp)

NOTE : Figure 1 provides test point and all alignment location information.

### 2a. Test Set-Up

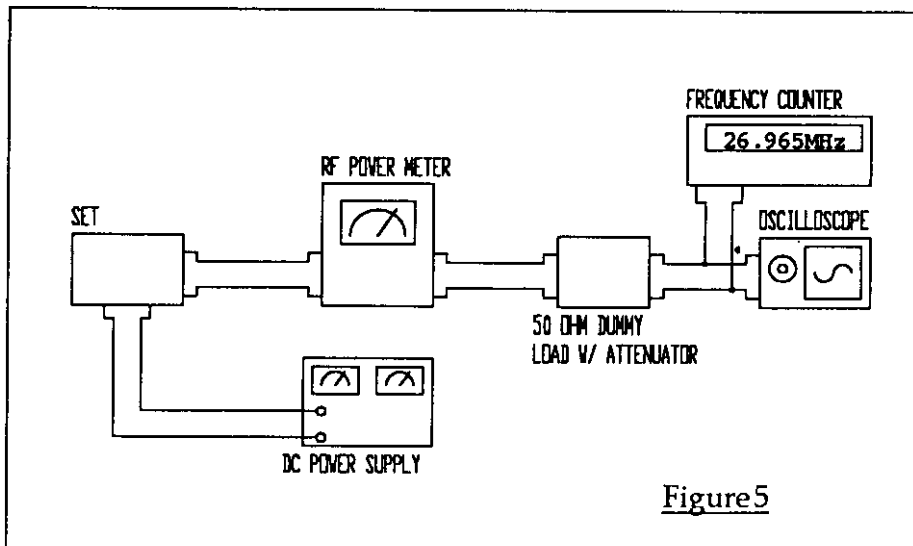
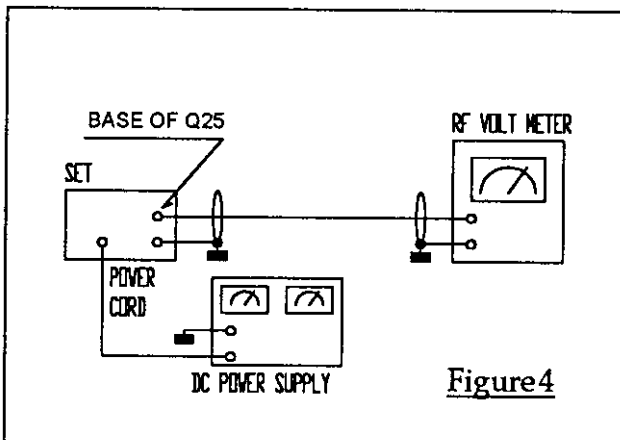



2b. Test Set-up

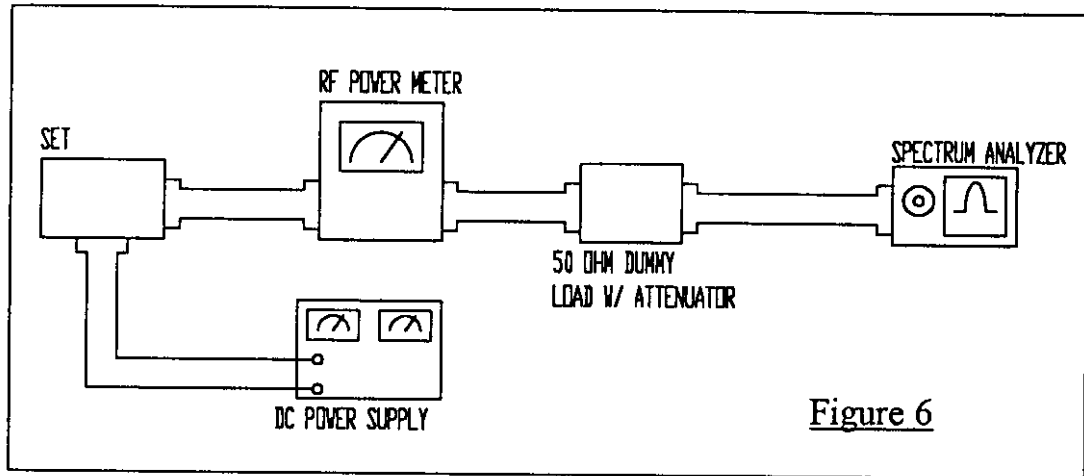

Figure 6

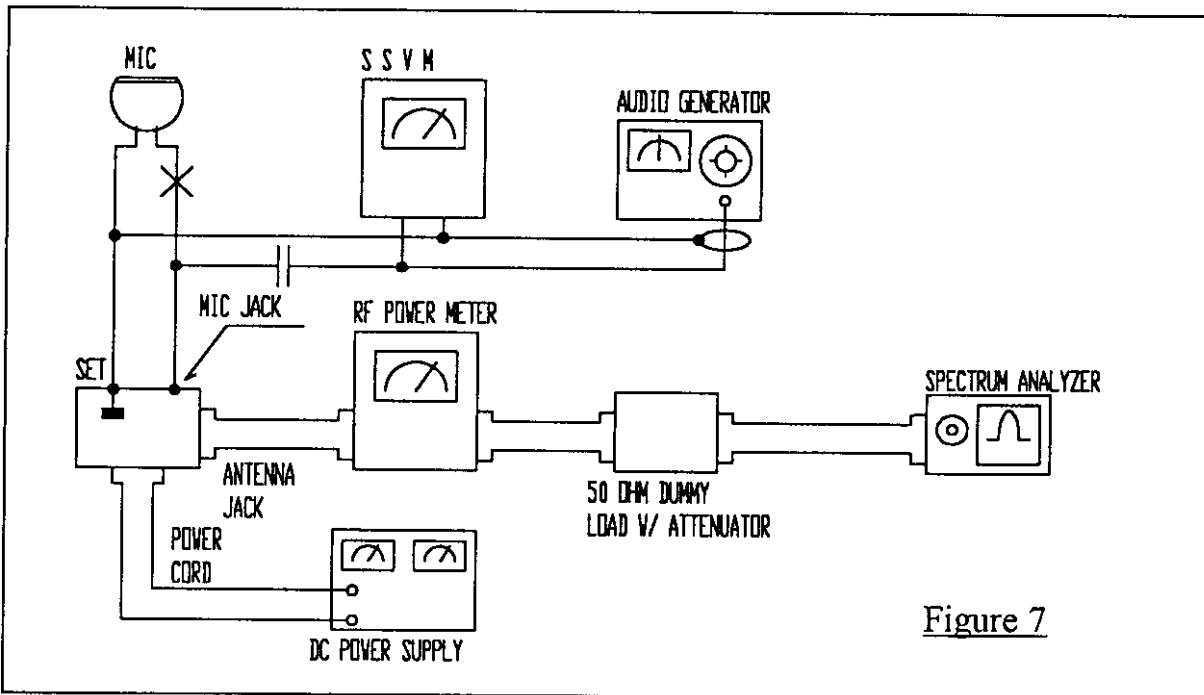

Figure 7

Document Number :  
Revision Number : 0  
Issue Date : 9 October, 1998.  
Page : Page 5 of 6

### 3. ALIGNMENT PROCEDURE (TX)

STEP	CONTROL SETTING	OUTPUT INDICATOR CONNECTION	ADJUST	ADJUST FOR
1.	Set channel selector to channel 19			
2.	Disconnect R134.			
3.	Alignment of Pre-driver stage			
		Connect RF voltmeter to base of Q25. (Figure 4)	T8, T9	Adjust for maximum indication on RF voltmeter.
4.	Be sure that the level difference among all channels are within 30mV on RF voltmeter. Be sure that the levels on all channels are above 650mV on RF voltmeter. If the level difference is over 30mV or the level is below 650mV, repeat step 3 as necessary to obtain maximum output.			
5.	Re-connect R134.			
6.	Set Channel selector to channel 19.			
7.	Alignment of driver and final stage.			
		Connect frequency counter and oscilloscope through 50 ohm dummy w/attenuator to RF power meter. Connect RF power-meter to ANT. Jack on the unit. (Figure 5)	T10, T11 L4	Adjust for maximum indication on RF power meter.
8.	Alignment of RF output Power.		R134	Choose the value combination of R134 to obtain 3.6W ~ 3.9W RF output power.
9.	Check that the RF output power difference among channels & each band is below 0.2W on RF output Power Meter. If the level difference is above 0.2W, repeat step 7 as necessary to obtain maximum output.			
10.		same as step 7.	Check that RF output power is 3.6 to 3.9W on all channels & each band. If it is not within the above range, go back to steps 3 through 8 and read just.	

Document Number :  
Revision Number : 0  
Issue Date : 9 October, 1998.  
Page : Page 6 of 6

11.	Alignment of Transmitter Frequency		
Set to channel 19.	Same as step 7.	TC1	Make sure that the transmitter frequency is 27.185MHz $\pm$ 100Hz on frequency counter. If not, readjust TC1.
12.	Check to spurious		
	Connect spectrum analyzer through 50ohm dummy w/ attenuator to RF power meter. Connect RF power meter to ANT. Jack on the unit. (Figure 6)		Check suppression of harmonic frequency level (2nd,4th...to1000MHz). Compared to fundamental : must be better than -62dB
13.	Check to occupied bandwidth		
Connector Audio Generator ( 2500Hz ) and SSVM through capacitor 1 uF to Microphone connector Pin 3. Disconnect condenser microphone. (Fig.7) Adjust audio signal level to 50% modulation +20dB.	Connector Spectrum Analyzer through 50 ohm dummy w/ attenuator to RF power meter. Connect RF power meter to ANT. Jack on the unit. (Fig. 7).		Check the below frequency level whether it is within the FCC spec. $\pm$ 2.5KHz $\pm$ 5.0KHz . . . . $\pm$ 22.5KHz

APPENDIX 7

CIRCUITS AND DEVICES TO STABILIZE FREQUENCY

All 40 channels of transmitting, and receiving, frequencies are provided by PLL (Phase Locked Loop) circuitry.

The purpose of the PLL is to provide a multiple number of frequencies from a VCO (Voltage Controlled Oscillator) with quartz crystal accuracy and stability locked to crystal oscillator reference frequency.

The reference crystal oscillator frequency is 4.5 MHz.

CIRCUITS AND DEVICES TO  
STABILIZE FREQUENCY  
FCC ID: MMA77255ESP

APPENDIX 7

## APPENDIX 8

1. Circuits For Suppression Of Spurious Radiation

The tuning circuit between the final amp and antenna jack JK402 stage "PI" network C110, C112, L4, C113, L5, C114, C115, L6 and C117 in the Q27 output circuit serve to suppress radiation. This Network serves to impedance match Q27 to the antenna and to reduce the spurious content to an acceptable level. In-band spurious is reduced to acceptable levels by filtering and layout in the frequency synthesizer.

2. Circuits For Limiting Modulation

The mic input is fed to the mic amp IC2 (1/2) and then to the audio power amp IC3 which feeds the signal to the modulation transformer T6. The audio output at the tap of T6 is fed in series with the B+ voltage through diode D6 to the collector of Q26 and the final Q27 to collector modulate at both stages.

A portion of the modulation voltage is fed to Q13 and Q14 and turn on and at the same time, Q14 attenuates the mic, input to the mic amp IC2 (1/2). The resulting feedback loop keeps the modulation from exceeding 100% for input approximately 40 dB greater than that required to produce 50% modulation. The attack time is about 18 ms and the release time is about 350 ms.

3. Circuits For Limiting Power

During factory alignment, the series base resistor R134 of Q27 is selected to limit the available power to slightly less than 4 watts. The tuning is adjusted so that the actual power is from 3.6 to 3.9 watts at 13.8 Vdc power supply, and there are no other controls for adjusting power.

DEVICES AND CIRCUITS TO SUPPRESS  
SPURIOUS RADIATION; LIMIT  
MODULATION AND POWER  
FCC ID: MMA77255ESP

APPENDIX 9  
PLL DATA SHEETS

THIRTEEN (13) PAGES FOR LC72322 FOLLOW THIS SHEET

COPY OF PLL DATA SHEETS  
FCC ID: MMA77255ESP

APPENDIX 9

C.C. = MIR SIT

CMOS LSI

LC72322

**SANYO**

No. 4797A

# Single-Chip Microcontroller with PLL and LCD Driver

-56.86  
Received

## Overview

The LC72322 is a single-chip microcontroller for use in electronic tuning applications. It includes on chip both LCD drivers and a PLL circuit that can operate at up to 150 MHz. It features a large-capacity ROM, a highly efficient instruction set, and powerful hardware.

## Functions

- Stack: Eight levels
- Fast programmable divider
- General-purpose counters: HCTR for frequency measurement and LCTR for frequency or period measurement
- LCD driver for displays with up to 56 segments (1/2 duty, 1/2 bias)
- Program memory (ROM): 4 k words by 16 bits
- Data memory (RAM): 256 4-bit digits
- All instructions are single-word instructions
- Cycle time: 2.67  $\mu$ s, 13.33  $\mu$ s, or 40.00  $\mu$ s (option)
- Unlock FF: 0.55  $\mu$ s detection, 1.1  $\mu$ s detection
- Timer FF: 1 ms, 5ms, 25ms, 125ms
- Input ports\*: One dedicated key input port and one high-breakdown voltage port
- Output ports\*: Two dedicated key output ports, one high-breakdown voltage open-drain port  
Two CMOS output ports (of which one can be switched to be used as LCD driver outputs)  
Seven CMOS output ports (mask option switchable to use as LCD ports)
- I/O ports\*: One switchable between input and output in four-bit units and one switchable between input and output in one-bit units

Note: \* Each port consists of four bits.

- Program runaway can be detected and a special address set (Programmable watchdog timer).
- Voltage detection type reset circuit
- One 6-bit A/D converter
- Two 8-bit D/A converters (PWM)
- One external interrupt
- Hold mode for RAM backup
- Sense FF for hot/cold startup determination
- PLL: 4.5 to 5.5 V
- CPU: 3.5 to 5.5 V
- RAM: 1.3 to 5.5 V

## Package Dimensions

unit: mm

3174-QFP80E

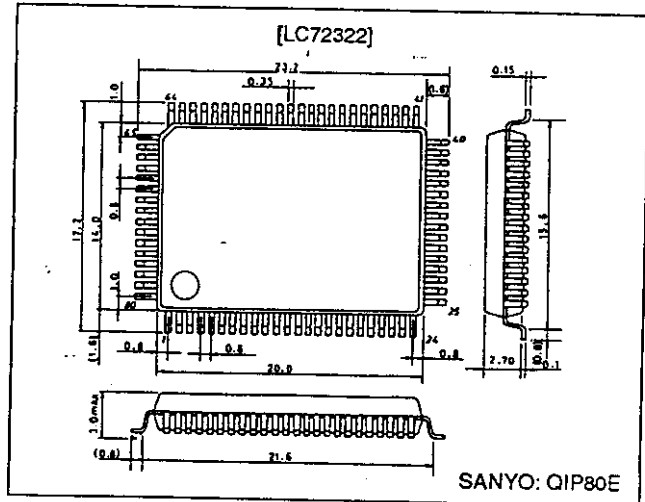

This LSI can easily use CCB that is SANYO's original bus format.



- CCB is a trademark of SANYO ELECTRIC CO., LTD.
- CCB is SANYO's original bus format and all the bus

**SANYO Electric Co., Ltd. Semiconductor Business Headquarters**

TOKYO OFFICE Tokyo Bldg., 1-10, 1 Chome, Ueno, Taito-ku, TOKYO, 110 JAPAN

Pin Assignment

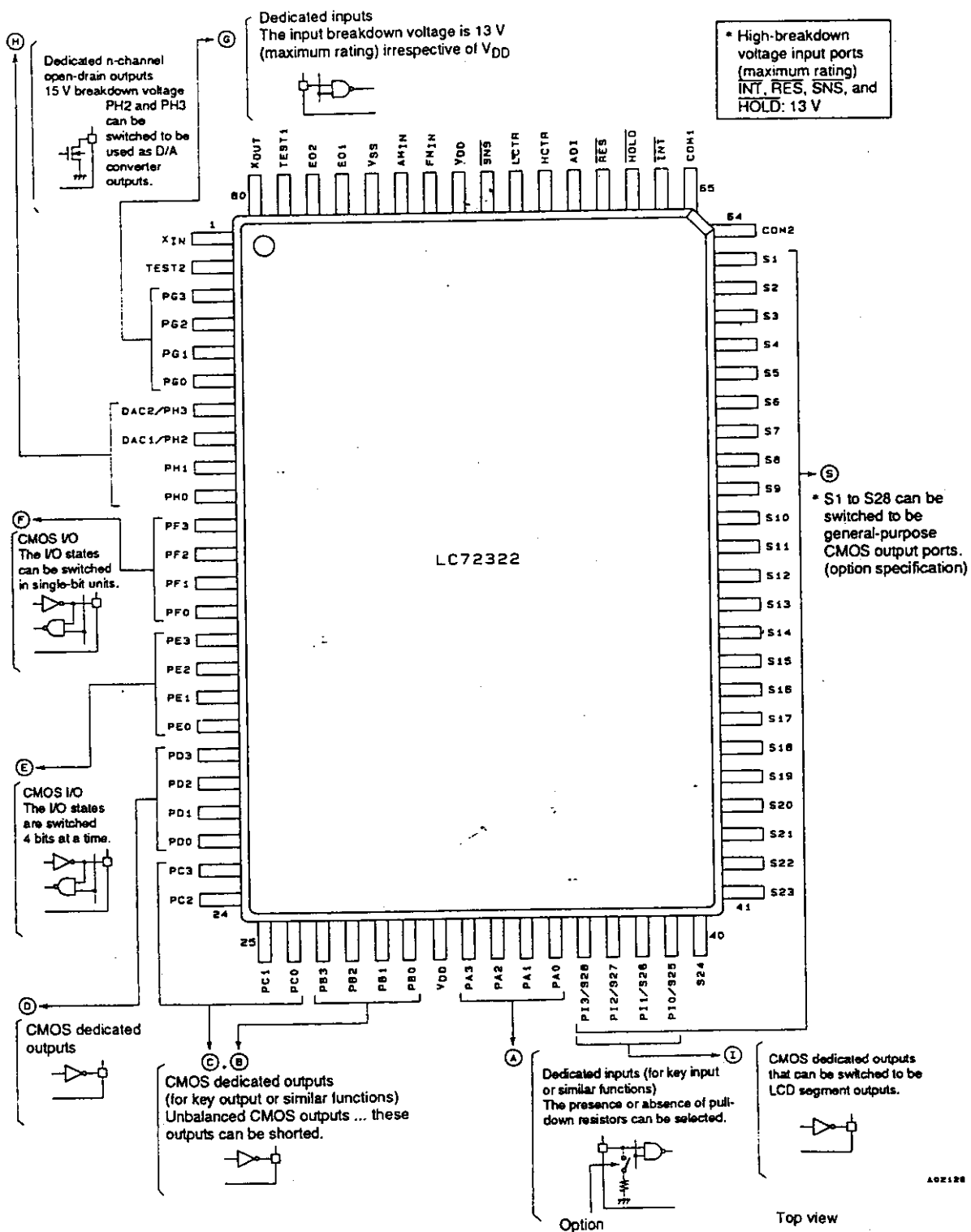



Block Diagram

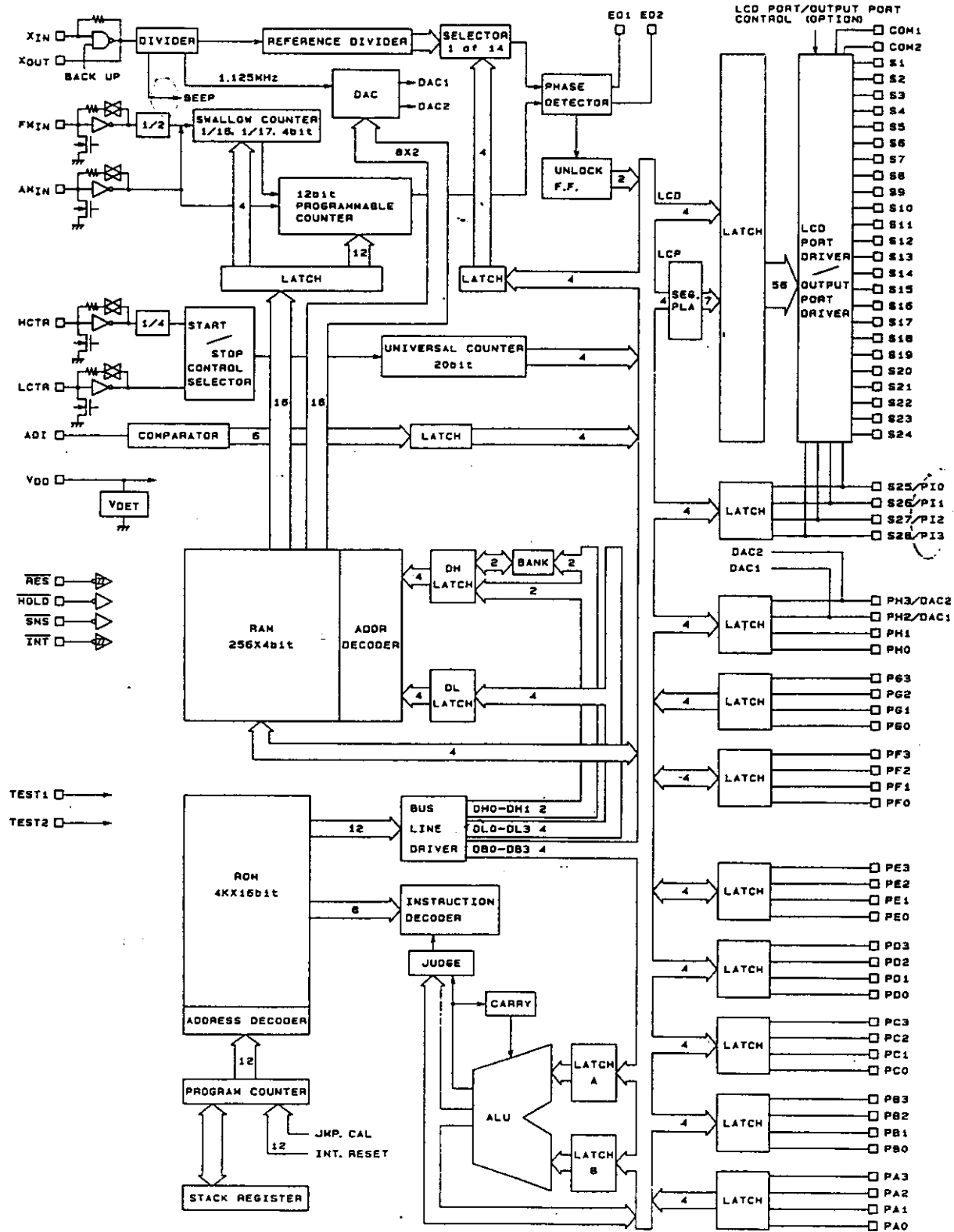

408127

# Specifications

Absolute Maximum Ratings at  $T_a = 25^\circ\text{C}$ ,  $V_{SS} = 0\text{ V}$

Parameter	Symbol	Conditions	Ratings	Unit
Maximum supply voltage	$V_{DD\text{ max}}$		-0.3 to +6.5	V
Input voltage	$V_{IN1}$	HOLD, INT, RES, ADI, SNS, and the G port	-0.3 to +13	V
	$V_{IN2}$	Inputs other than $V_{IN1}$	-0.3 to $V_{DD} + 0.3$	V
Output voltage	$V_{OUT1}$	H port	-0.3 to +15	V
	$V_{OUT2}$	Outputs other than $V_{OUT1}$	-0.3 to $V_{DD} + 0.3$	V
Output current	$I_{OUT1}$	All D and H port pins	0 to 5	mA
	$I_{OUT2}$	All E and F port pins	0 to 3	mA
	$I_{OUT3}$	All B and C port pins	0 to 1	mA
	$I_{OUT4}$	S1 to S28 and all I port pins	0 to 1	mA
Allowable power dissipation	$P_d\text{ max}$	$T_a = -40$ to $+85^\circ\text{C}$	300	mW
Operating temperature	$T_{opr}$		-40 to +85	$^\circ\text{C}$
Storage temperature	$T_{stg}$		-45 to +125	$^\circ\text{C}$

Allowable Operating Ranges at  $T_a = -40$  to  $+85^\circ\text{C}$ ,  $V_{DD} = 3.5$  to  $5.5\text{ V}$

Parameter	Symbol	Conditions	Ratings			Unit
			min	typ	max	
Supply voltage	$V_{DD1}$	CPU and PLL operating	4.5		5.5	V
	$V_{DD2}$	CPU operating	3.5		5.5	V
	$V_{DD3}$	Memory retention voltage	1.3		5.5	V
Input high level voltage	$V_{IH1}$	G port	$0.7 V_{DD}$		8.0	V
	$V_{IH2}$	RES, INT, HOLD	$0.8 V_{DD}$		8.0	V
	$V_{IH3}$	SNS	2.5		8.0	V
	$V_{IH4}$	A port	$0.6 V_{DD}$		$V_{DD}$	V
	$V_{IH5}$	E, F port	$0.7 V_{DD}$		$V_{DD}$	V
	$V_{IH6}$	LCTR (period measurement), $V_{DD1}$ , PE1, PE3	$0.8 V_{DD}$		$V_{DD}$	V
Input low level voltage	$V_{IL1}$	G port	0		$0.3 V_{DD}$	V
	$V_{IL2}$	RES, INT, PE1, PE3	0		$0.2 V_{DD}$	V
	$V_{IL3}$	SNS	0		1.3	V
	$V_{IL4}$	A port	0		$0.2 V_{DD}$	V
	$V_{IL5}$	PE0, PE2, F port	0		$0.3 V_{DD}$	V
	$V_{IL6}$	LCTR (period measurement), $V_{DD1}$	0		$0.2 V_{DD}$	V
	$V_{IL7}$	HOLD	0		$0.4 V_{DD}$	V
Input frequency	$f_{IN1}$	XIN	4.0	4.5	5.0	MHz
	$f_{IN2}$	FMIN, $V_{IN2}$ , $V_{DD1}$	10		130	MHz
	$f_{IN3}$	FMIN, $V_{IN3}$ , $V_{DD1}$	10		150	MHz
	$f_{IN4}$	AMIN (L), $V_{IN4}$ , $V_{DD1}$	0.5		10	MHz
	$f_{IN5}$	AMIN (H), $V_{IN5}$ , $V_{DD1}$	2.0		40	MHz
	$f_{IN6}$	HCTR, $V_{IN6}$ , $V_{DD1}$	0.4		12	MHz
	$f_{IN7}$	LCTR (frequency), $V_{IN7}$ , $V_{DD1}$	100		500	kHz
	$f_{IN8}$	LCTR (frequency), $V_{IH6}$ , $V_{IL6}$ , $V_{DD1}$	1		$20 \times 10^3$	Hz
Input amplitude	$V_{IN1}$	XIN	0.50		1.5	Vrms
	$V_{IN2}$	FMIN	0.10		1.5	Vrms
	$V_{IN3}$	FMIN	0.15		1.5	Vrms
	$V_{IN4, 5}$	AMIN	0.10		1.5	Vrms
	$V_{IN6, 7}$	LCTR, HCTR	0.10		1.5	Vrms
Input voltage range	$V_{IN8}$	ADI	0		$V_{DD}$	V

Electrical Characteristics for the Allowable Operating Ranges

Parameter	Symbol	Conditions	Ratings			Unit
			min	typ	max	
Hysteresis	$V_H$	LCTR (period), RES, INT, PE1, PE3	0.1 $V_{DD}$			V
Rejected pulse width	$P_{REJ}$	SNS			50	$\mu s$
Power-down detection voltage	$V_{DET}$		2.7	3.0	3.3	V
Input high level current	$I_{IH1}$	INT, HOLD, RES, ADI, SNS, and the G port: $V_I = 5.5 V$			3.0	$\mu A$
	$I_{IH2}$	A, E, and F ports: E and F ports with outputs off, A port with no $R_{PD}$ , $V_I = V_{DD}$			3.0	$\mu A$
	$I_{IH3}$	XIN: $V_I = V_{DD} = 5.0 V$	2.0	5.0	15	$\mu A$
	$I_{IH4}$	FMIN, AMIN, HCTR, LCTR: $V_I = V_{DD} = 5.0 V$	4.0	10	30	$\mu A$
	$I_{IH5}$	A port: With an $R_{PD}$ , $V_I = V_{DD} = 5.0 V$		50		$\mu A$
Input low level current	$I_{IL1}$	INT, HOLD, RES, ADI, SNS, and the G port: $V_I = V_{SS}$			3.0	$\mu A$
	$I_{IL2}$	A, E, and F ports: E and F ports with outputs off, A port with no $R_{PD}$ , $V_I = V_{SS}$			3.0	$\mu A$
	$I_{IL3}$	XIN: $V_{IN} = V_{SS}$	2.0	5.0	15	$\mu A$
	$I_{IL4}$	FMIN, AMIN, HCTR, LCTR: $V_I = V_{SS}$	4.0	10	30	$\mu A$
Input floating voltage	$V_{IF}$	A port: With an $R_{PD}$			0.05 $V_{DD}$	V
Pull-down resistance	$R_{PD}$	A port: With an $R_{PD}$ , $V_{DD} = 5.0 V$	75	100	200	$k\Omega$
Output high level off leakage current	$I_{OFFH1}$	EO1, EO2: $V_O = V_{DD}$		0.01	10	nA
	$I_{OFFH2}$	B, C, D, E, F, and I ports: $V_O = V_{DD}$			3.0	$\mu A$
	$I_{OFFH3}$	H port: $V_O = 13 V$			5.0	$\mu A$
Output low level off leakage current	$I_{OFFL1}$	EO1, EO2: $V_O = V_{SS}$		0.01	10	nA
	$I_{OFFL2}$	B, C, D, E, F, and I ports: $V_O = V_{SS}$			3.0	$\mu A$
Output high level voltage	$V_{OH1}$	B and C ports: $I_O = 1 mA$	$V_{DD} - 2.0$	$V_{DD} - 1.0$	$V_{DD} - 0.5$	V
	$V_{OH2}$	E and F ports: $I_O = 1 mA$	$V_{DD} - 1.0$			V
	$V_{OH3}$	EO1, EO2: $I_O = 500 \mu A$	$V_{DD} - 1.0$			V
	$V_{OH4}$	XOUT: $I_O = 200 \mu A$	$V_{DD} - 1.0$			V
	$V_{OH5}$	S1 to S28 and the I port: $I_O = -0.1 mA$	$V_{DD} - 1.0$			V
	$V_{OH6}$	D port: $I_O = 5 mA$	$V_{DD} - 1.0$			V
	$V_{OH7}$	COM1, COM2: $I_O = 25 \mu A$	$V_{DD} - 0.75$	$V_{DD} - 0.5$	$V_{DD} - 0.3$	V
Output low level voltage	$V_{OL1}$	B and C ports: $I_O = 50 \mu A$	0.5	1.0	2.0	V
	$V_{OL2}$	E and F ports: $I_O = 1 mA$			1.0	V
	$V_{OL3}$	EO1, EO2: $I_O = 500 \mu A$			1.0	V
	$V_{OL4}$	XOUT: $I_O = 200 \mu A$			1.0	V
	$V_{OL5}$	S1 to S28 and the I port: $I_O = 0.1 mA$			1.0	V
	$V_{OL6}$	D port: $I_O = 5 mA$			1.0	V
	$V_{OL7}$	COM1, COM2: $I_O = 25 \mu A$	0.3	0.5	0.75	V
	$V_{OL8}$	H port: $I_O = 5 mA$ , $V_{DD1}$	(150 $\Omega$ ) 0.75		(400 $\Omega$ ) 2.0	V
Output middle level voltage	$V_M1$	COM1, COM2: $V_{DD} = 5.0 V$ , $I_O = 25 \mu A$	2.0	2.5	3.0	V
A/D conversion error		ADI: $V_{DD1}$	-1/2		1/2	LSB
Current drain	$I_{DD1}$	$V_{DD1}$ , $f_{IN2} = 130 MHz$		15	20	mA
	$I_{DD2}$	$V_{DD1}$ , PLL stopped, CT = 2.67 $\mu s$ (HOLD mode, Figure 1)		1.5		mA
	$I_{DD3}$	$V_{DD1}$ , PLL stopped, CT = 13.33 $\mu s$ (HOLD mode, Figure 1)		1.0		mA
	$I_{DD4}$	$V_{DD1}$ , PLL stopped, CT = 40.00 $\mu s$ (HOLD mode, Figure 1)		0.7		mA
	$I_{DD5}$	$V_{DD} = 5.5 V$ , oscillator stopped, $T_a = 25^\circ C$ (BACK UP mode, Figure 2)			5	$\mu A$
	$V_{DD} = 2.5 V$ , oscillator stopped, $T_a = 25^\circ C$ (BACK UP mode, Figure 2)			1	$\mu A$	

Test Circuits

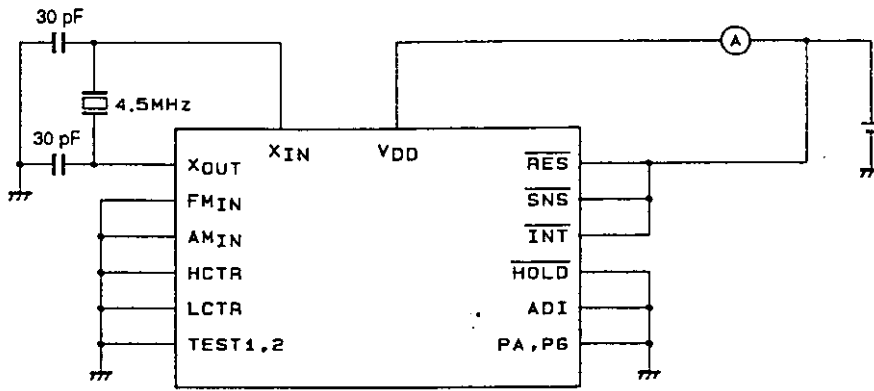

A02105

Note: PB to PF, PH, and PI are all open. However, PE and PF are output selected.

Figure 1  $I_{DD2}$  to  $I_{DD4}$  in HOLD Mode

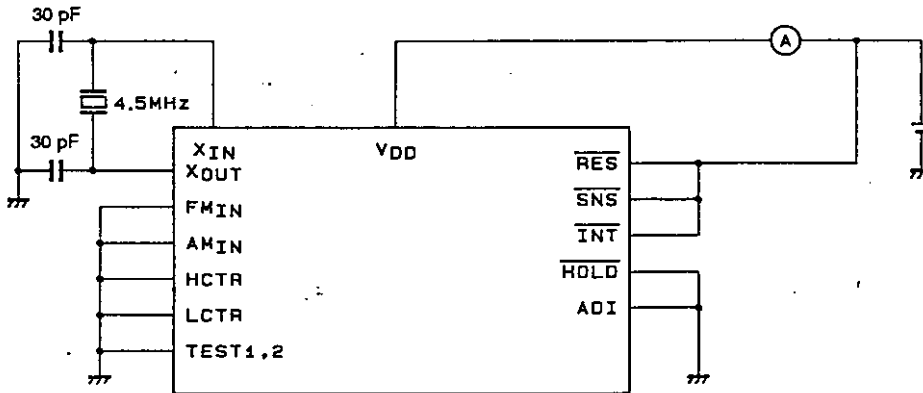

A02106

Note: PA to PI, S1 to S4, COM1, and COM2 are all open.

Figure 2  $I_{DD5}$  in BACK UP Mode

Pin Functions

Pin	Pin No.	Functions	I/O	I/O circuit type
PA0 PA1 PA2 PA3	35 34 33 32	<p>Low-threshold type dedicated input port</p> <p>These pins can be used, for example, for key data acquisition.</p> <p>Built-in pull-down resistors can be specified as an option. This option is in 4-pin units, and cannot be specified for individual pins.</p> <p>Input through these pins is disabled in BACK UP mode.</p>	Input	<p>Option</p> <p>A02107</p>
PB0 PB1 PB2 PB3 PC0 PC1 PC2 PC3	30 29 28 27 26 25 24 23	<p>Dedicated output ports</p> <p>Since the output transistor impedances are unbalanced CMOS, these pins can be effectively used for functions such as key scan timing. These pins go to the output high-impedance state in BACK UP mode.</p> <p>These pins go to the low level during a reset, i.e., when the <math>\overline{RES}</math> pin is low.</p>	Output	<p>A02108</p>
PD0 PD1 PD2 PD3	22 21 20 19	<p>Dedicated output ports</p> <p>These are normal CMOS outputs. These pins go to the output high-impedance state in BACK UP mode.</p> <p>These pins go to the low level during a reset, i.e., when the <math>\overline{RES}</math> pin is low.</p>		<p>A02108</p>
PE0 PE1 PE2 PE3	18 17 16 15	<p>I/O port</p> <p>These pins are switched between input and output as follows: Once an input instruction (IN, TPT, or TPF) is executed, these pins latch in the input mode. Once an output instruction (OUT, SPB, or RPB) is executed, they latch in the output mode.</p> <p>These pins go to the input mode during a reset, i.e., when the <math>\overline{RES}</math> pin is low.</p> <p>In BACK UP mode these pins go to the input mode with input disabled.</p>	I/O	<p>PE1, PE3</p> <p>A02109</p>
PF0 PF1 PF2 PF3	14 13 12 11	<p>I/O port</p> <p>These pins are switched between input and output by the FPC instruction.</p> <p>The I/O states of this port can be specified for individual pins.</p> <p>These pins go to the input mode during a reset, i.e., when the <math>\overline{RES}</math> pin is low.</p> <p>In BACK UP mode these pins go to the input mode with input disabled.</p>		<p>Others</p> <p>A02110</p>
PG0 PG1 PG2 PG3	6 5 4 3	<p>Dedicated input port</p> <p>Input through these pins is disabled in BACK UP mode.</p>	Input	<p>A02111</p>

Continued from preceding page.

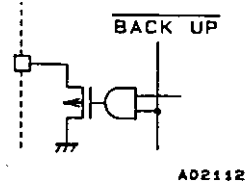
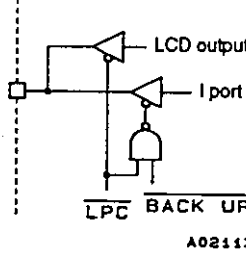
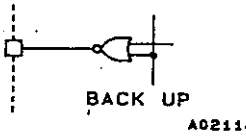
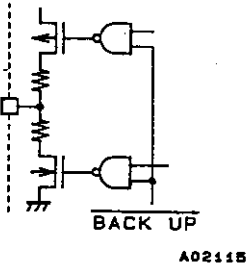
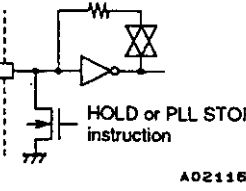
Pin	Pin No.	Functions	I/O	I/O circuit type
PH0 PH1 PH2/DAC1 PH3/DAC2	10 9 8 7	Dedicated output port Since these pins are high-breakdown voltage n-channel transistor open-drain outputs, they can be effectively used for functions such as band power supply switching. Note that PH2 and PH3 also function as the DAC1 and DAC2 outputs. These ports go to the high impedance state during a reset, i.e., when the RES pin is low, and in BACK UP mode.	Output	 A02112
PI0/S25 PI1/S26 PI2/S27 PI3/S28	39 38 37 36	Dedicated output port While these pins have a CMOS output circuit structure, they can be switched to function as LCD drivers. Their function is switched by the SS and RS instructions. These pins cannot be switched individually. The LCD driver function is selected and a segment-off signal is output when power is first applied or when RES is low. These pins are held at the low level in BACK UP mode. Note that when the general-purpose port use option is specified, these pins output the contents of IPORT when LPC is 1, and the contents of the general-purpose output port LATCH when LPC is 0.	Output	 A02113
S1 to S24	63 to 40	LCD driver segment outputs A frame frequency of 100 Hz and a 1/2 duty, 1/2 bias drive type are used. A segment-off signal is output when power is first applied or when RES is low. These pins are held at the low level in BACK UP mode. The use of these pins as general-purpose output ports can be specified as an option.	Output	 A02114
COM1 COM2	65 64	LCD driver common outputs A 1/2 duty, 1/2 bias drive type is used. The output when power is first applied or when RES is low is identical to the normal operating mode output. These pins are held at the low level in BACK UP mode.	Output	 A02115
FMIN	74	FM VCO (local oscillator) input The input must be capacitor coupled. The input frequency range is from 10 to 130 MHz.	Input	 A02116
AMIN	75	AM VCO (local oscillator) input The band supported by this pin can be selected using the PLL instruction. High (2 to 40 MHz) → SW Low (0.5 to 10 MHz) → LW and MW		

Continued on next page.

Continued from preceding page.

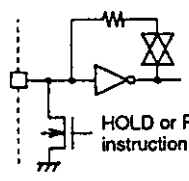
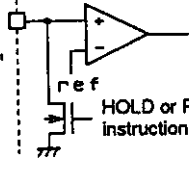
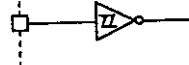
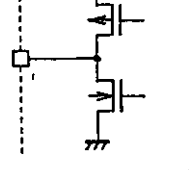
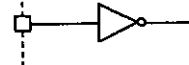
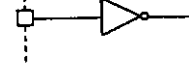
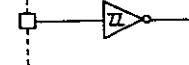
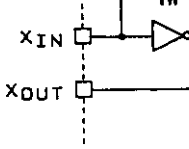
Pin	Pin No.	Functions	IO	I/O circuit type
HCTR	70	Universal counter input The input should be capacitor coupled. The input frequency range is from 0.4 to 12 MHz. This input can be effectively used for FM IF or AM IF counting.	Input	 <p>HOLD or PLL STOP instruction</p> <p>A02116</p>
LCTR	71	Universal counter input The input should be capacitor coupled for input frequencies in the range 100 to 150 kHz. Capacitor coupling is not required for input frequencies from 1 to 20 Hz. This input can be effectively used for AM IF counting. This pin can also be used as a normal input port.		
ADI	69	A/D converter input A 1.28 ms period is required for a 6-bit sequential comparison conversion. The full scale input is $((63/96) \cdot V_{DD})$ for a data value of 3FH.	Input	 <p>HOLD or PLL STOP instruction</p> <p>A02117</p>
INT	66	External interrupt request input An interrupt is generated when the INTEN flag is set (by an SS instruction) and a falling edge is input. This pin can also be used as a normal input port.	Input	 <p>A02118</p>
EO1 EO2	77 78	Reference frequency and programmable divider phase comparison error outputs Charge pump circuits are built in. EO1 and EO2 are the same.	Output	 <p>A02119</p>
SNS	72	Input pin used to determine if a power outage has occurred in BACK UP mode This pin can also be used as a normal input port.	Input	 <p>A02120</p>
HOLD	67	Input pin used to force the LC72322 to HOLD mode The LC72322 goes to HOLD mode when the HOLDEN flag is set (by an SS instruction) and the HOLD input goes low. A high-breakdown voltage circuit is used so that this input can be used in conjunction with the normal power switch.	Input	 <p>A02120</p>
RES	68	System reset input This signal should be held low for 75 ms after power is first applied to effect a power-up reset. The reset starts when a low level has been input for at least six reference clock cycles.	Input	 <p>A02118</p>
XIN XOUT	1 80	Crystal oscillator connections (4.5 MHz) A feedback resistor is built in.	Input Output	 <p>A02121</p>
TEST1 TEST2	2 79	LSI test pins. These pins must be connected to V <sub>SS</sub> .	—	—
V <sub>DD</sub> V <sub>SS</sub>	31, 73 76	Power supply	—	—

## Mask Options

No.	Description	Selections
1	WDT (watchdog timer) inclusion selection	WDT included
		No WDT
2	Port A pull-down resistor inclusion selection	Pull-down resistors included
		No pull-down resistors
3	Cycle time selection	2.67 $\mu$ s
		13.33 $\mu$ s
		40.00 $\mu$ s
4	LCD port/general-purpose port selection	LCD ports
		General-purpose output ports

## Development Environment

- The LC72P321 is used for OTP.
- The LC72EV321 is used as the evaluation chip.
- A total debugging system is available in which the TB-72EV32 evaluation chip board and the RE32 multi-function emulator are controlled by a personal computer.

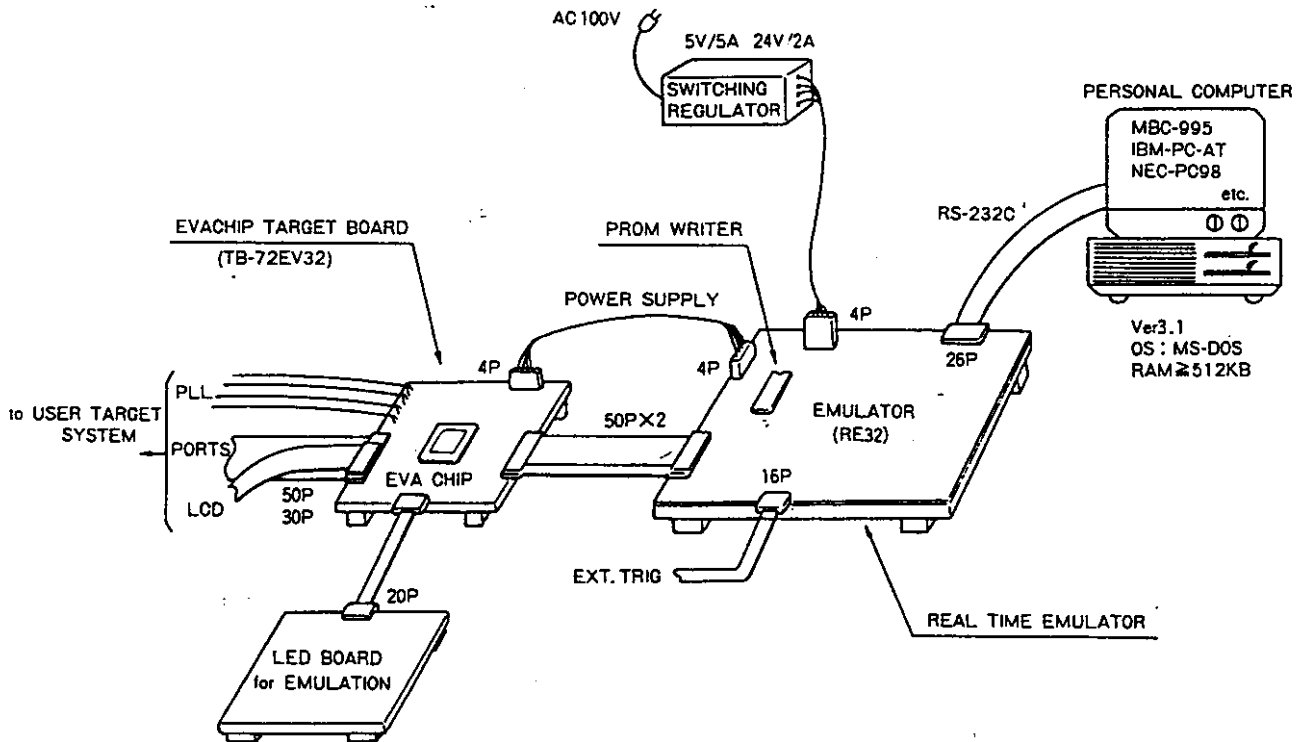



## LC72321 Instruction Table

## Abbreviations:

ADDR: Program memory address [12 bits]

b: Borrow

B: Bank number [2 bits]

C: Carry

DH: Data memory address high (row address) [2 bits]

DL: Data memory address low (column address) [4 bits]

I: Immediate data [4 bits]

M: Data memory address

N: Bit position [4 bits]

Pn: Port number [4 bits]

r: General register (one of the locations 00 to 0FH in bank 0)

( ): Contents of register or memory

( )N: Contents of bit N of register or memory

Instruction Group	Mnemonic	Operand		Function	Operation	Machine code												
		1st	2nd			D15	14	13	12	11	10	9	8	7	6	5	4	3
Addition instructions	AD	r	M	Add M to r	$r \leftarrow (r) + (M)$	0	1	0	0	0	0	DH	DL	Rn				
	ADS	r	M	Add M to r, then skip if carry	$r \leftarrow (r) + (M)$ skip if carry	0	1	0	0	0	1	DH	DL	Rn				
	AC	r	M	Add M to r with carry	$r \leftarrow (r) + (M) + C$	0	1	0	0	1	0	DH	DL	Rn				
	ACS	r	M	Add M to r with carry, then skip if carry	$r \leftarrow (r) + (M) + C$ skip if carry	0	1	0	1	0	0	DH	DL	Rn				
	AI	M	I	Add I to M	$M \leftarrow (M) + I$	0	1	0	1	0	0	DH	DL	I				
	AIS	M	I	Add I to M, then skip if carry	$M \leftarrow (M) + I$ skip if carry	0	1	0	1	0	1	DH	DL	I				
	AIC	M	I	Add I to M with carry	$M \leftarrow (M) + I + C$	0	1	0	1	1	0	DH	DL	I				
	AICS	M	I	Add I to M with carry, then skip if carry	$M \leftarrow (M) + I + C$ skip if carry	0	1	0	1	1	1	DH	DL	I				
Subtraction instructions	SU	r	M	Subtract M from r	$r \leftarrow (r) - (M)$	0	1	1	0	0	0	DH	DL	Rn				
	SUS	r	M	Subtract M from r, then skip if borrow	$r \leftarrow (r) - (M)$ skip if borrow	0	1	1	0	0	1	DH	DL	Rn				
	SB	r	M	Subtract M from r with borrow	$r \leftarrow (r) - (M) - b$	0	1	1	0	1	0	DH	DL	Rn				
	SBS	r	M	Subtract M from r with borrow, then skip if borrow	$r \leftarrow (r) - (M) - b$ skip if borrow	0	1	1	0	0	0	DH	DL	Rn				
	SI	M	I	Subtract I from M	$M \leftarrow (M) - I$	0	1	1	1	0	0	DH	DL	I				
	SIS	M	I	Subtract I from M, then skip if borrow	$M \leftarrow (M) - I$ skip if borrow	0	1	1	1	0	1	DH	DL	I				
	SIB	M	I	Subtract I from M with borrow	$M \leftarrow (M) - I - b$	0	1	1	1	1	0	DH	DL	I				
	SIBS	M	I	Subtract I from M with borrow, then skip if borrow	$M \leftarrow (M) - I - b$ skip if borrow	0	1	0	1	1	1	DH	DL	I				
Comparison instructions	SEQ	r	M	Skip if r equals M	$r - M$ skip if zero	0	0	0	0	0	1	DH	DL	Rn				
	SGE	r	M	Skip if r is greater than or equal to M	$r - M$ skip if not borrow ( $r \geq (M)$ )	0	0	0	0	1	1	DH	DL	Rn				
	SEQI	M	I	Skip if M equal to I	$M - I$ skip if zero	0	0	1	1	0	1	DH	DL	I				
	SGEI	M	I	Skip if M is greater than or equal to I	$M - I$ skip if not borrow ( $M \geq I$ )	0	0	1	1	1	1	DH	DL	I				

Continued on next page.

Continued from preceding page.

Instruction Group	Mnemonic	Operand		Function	Operation	Machine code															
		1st	2nd			D15	14	13	12	11	10	9	8	7	6	5	4	3	2	1	D0
Logical operation instructions	AND	M	I	AND I with M	$M \leftarrow (M) \wedge I$	0	0	1	1	0	0	DH		DL		I					
	OR	M	I	OR I with M	$M \leftarrow (M) \vee I$	0	0	1	1	1	0	DH		DL		I					
	EXL	r	M	Exclusive OR M with r	$r \leftarrow (r) \oplus (M)$	0	0	1	0	0	0	DH		DL		Rn					
Transfer instructions	LD	r	M	Load M to r	$r \leftarrow (M)$	1	0	0	0	0	0	DH		DL		Rn					
	ST	M	r	Store r to M	$M \leftarrow (r)$	1	0	0	0	0	1	DH		DL		Rn					
	MVRD	r	M	Move M to destination M referring to r in the same row	$[DH, Rn] \leftarrow (M)$	1	0	0	0	1	0	DH		DL		Rn					
	MVRS	M	r	Move source M referring to r to M in the same row	$M \leftarrow [DH, Rn]$	1	0	0	0	1	1	DH		DL		Rn					
	MVSR	M1	M2	Move M to M in the same row	$[DH, DL1] \leftarrow [DH, DL2]$	1	0	0	1	0	0	DH		DL1		DL2					
	MVI	M	I	Move I to M	$M \leftarrow I$	1	0	0	1	0	1	DH		DL		I					
	PLL	M	r	Load M to PLL registers	$PLL\ r \leftarrow PLL\ DATA$	1	0	0	1	1	0	DH		DL		Rn					
Bit test instructions	TMT	M	N	Test M bits, then skip if all bits specified are true	if $M(N) = \text{all } 1$ , then skip	1	0	1	0	0	1	DH		DL		N					
	TMF	M	N	Test M bits, then skip if all bits specified are false	if $M(N) = \text{all } 0$ , then skip	1	0	1	0	1	1	DH		DL		N					
Jump and subroutine call instructions	JMP	ADDR		Jump to the address	$PC \leftarrow ADDR$	1	0	1	1	ADDR (12 bits)											
	CAL	ADDR		Call subroutine	$Stack \leftarrow (PC) + 1$	1	1	0	0	ADDR (12 bits)											
	RT			Return from subroutine	$PC \leftarrow Stack$	1	1	0	1	0	1	0	0	0	0	0	0	0	0	0	0
	RTI			Return from interrupt	$PC \leftarrow Stack$	1	1	0	1	0	1	0	1	0	0	0	0	0	0	0	0
F/F test instructions	TTM	N		Test timer F/F then skip if it has not been set	if timer $F/F = 0$ , then skip	1	1	0	1	0	1	1	0	0	0	0	0	N			
	TUL	N		Test unlock F/F then skip if it has not been set	if UL $F/F = 0$ , then skip	1	1	0	1	0	1	1	1	0	0	0	0	N			
Status register instructions	SS	N		Set status register	(Status register 1) $N \leftarrow 1$	1	1	0	1	1	1	0	0	0	0	0	0	N			
	RS	N		Reset status register	(Status register 1) $N \leftarrow 0$	1	1	0	1	1	1	0	1	0	0	0	0	N			
	TST	N		Test status register true	if (Status register 2) $N = \text{all } 1$ , then skip	1	1	0	1	1	1	1	0	0	0	0	0	N			
	TSF	N		Test status register false	if (Status register 2) $N = \text{all } 0$ , then skip	1	1	0	1	1	1	1	1	0	0	0	0	N			
Bank switching instructions	BANK	B		Select bank	$BANK \leftarrow B$	1	1	0	1	0	0	B		0	0	0	0	0	0	0	0

Continued on next page.

Instruction Group	Mnemonic	Operand		Function	Operation	Machine code															
		1st	2nd			D15 14 13 12				11 10 9 8			7 6 5 4				3 2 1 D0				
I/O Instructions	LCD	M	I	Output segment pattern to LCD digit direct	LCD (DIGIT) ← M	1	1	1	0	0	0	DH		DL				DIGIT			
	LCP	M	I	Output segment pattern to LCD digit through PLA	LCD (DIGIT) ← PLA ← M	1	1	1	0	0	1	DH		DL				DIGIT			
	IN	M	P	Input port data to M	M ← (Port (P))	1	1	1	0	1	0	DH		DL				P			
	OUT	M	P	Output contents of M to port	(Port (P)) ← M	1	1	1	0	1	1	DH		DL				P			
	SPB	P	N	Set port bits	(Port (P)) N ← 1	1	1	1	1	0	0	0 0		P				N			
	RPB	P	N	Reset port bits	(Port (P)) N ← 0	1	1	1	1	0	1	0 1		P				N			
	TPT	P	N	Test port bits, then skip if all bits specified are true	if (Port (P)) N = all 1, then skip	1	1	1	1	1	0	1 0		P				N			
	TPF	P	N	Test port bits, then skip if all bits specified are false	if (Port (P)) N = all 0, then skip	1	1	1	1	1	1	1 1		P				N			
Universal counter Instructions	UCS	I		Set I to UCCW1	UCCW1 ← I	0	0	0	0	0	0	0 1		0 0 0 0				I			
	UCC	I		Set I to UCCW2	UCCW2 ← I	0	0	0	0	0	0	1 1		0 0 0 0				I			
Other Instructions	FPC	N		F port I/O control	FPC latch ← N	0	0	0	1	0	0	0 0		0 0 0 0				N			
	CKSTP			Clock stop	Stop clock if HOLD = 0	0	0	0	1	0	0	0 1		0 0 0 0				0 0 0 0			
	DAC	I		Load M to D/A registers	DAreg ← DAC DATA	0	0	0	0	0	0	1 0		0 0 0 0				I			
	NOP			No operation		0	0	0	0	0	0	0 0		0 0 0 0				0 0 0 0			

■ No products described or contained herein are intended for use in surgical implants, life-support systems, aerospace equipment, nuclear power control systems, vehicles, disaster/crime-prevention equipment and the like, the failure of which may directly or indirectly cause injury, death or property loss.

■ Anyone purchasing any products described or contained herein for an above-mentioned use shall:

- ① Accept full responsibility and indemnify and defend SANYO ELECTRIC CO., LTD., its affiliates, subsidiaries and distributors and all their officers and employees, jointly and severally, against any and all claims and litigation and all damages, cost and expenses associated with such use;
- ② Not impose any responsibility for any fault or negligence which may be cited in any such claim or litigation on SANYO ELECTRIC CO., LTD., its affiliates, subsidiaries and distributors or any of their officers and employees jointly or severally.

■ Information (including circuit diagrams and circuit parameters) herein is for example only; it is not guaranteed for volume production. SANYO believes information herein is accurate and reliable, but no guarantees are made or implied regarding its use or any infringements of intellectual property rights or other rights of third parties.

This catalog provides information as of March, 1996. Specifications and information herein are subject to change without notice.

APPENDIX 10  
FINAL RF AMPLIFIER DATA SHEETS

THREE (3) PAGES FOR 2SC2078 FOLLOW THIS SHEET

FINAL RF AMP DATA SHEET  
FCC ID: MMA77255ESP

APPENDIX 10

ws\mid77255

# 2SC2078

031-232078-04 TRANSISTOR 2SC2078D  
 VENDOR : SANYO ELECTRIC CO. LTD.  
 DATE 19-5-93



2010A

NPN Epitaxial Planar Silicon Transistor

## 27MHz High Frequency Power Amp Applications

©4620

### Absolute Maximum Ratings at Ta=25°C

Parameter	Symbol	Value	Unit
Collector to Base Voltage	V <sub>CBO</sub>	80	V
Collector to Emitter Voltage	V <sub>CER</sub>	75	V
Emitter to Base Voltage	V <sub>EBO</sub>	5	V
Collector Current	I <sub>C</sub>	3	A
Peak Collector Current	i <sub>cp</sub>	5	A
Collector Dissipation	P <sub>C</sub>	1.2	W
Junction Temperature	T <sub>J</sub>	10	W
Storage Temperature	T <sub>stg</sub>	150	°C

R<sub>BE</sub> = 150ohm  
 T<sub>c</sub> = 50°C  
 -55 to +150 °C

### Electrical Characteristics at Ta=25°C

Parameter	Symbol	Value	min	typ	max	Unit
Collector Cutoff Current	I <sub>CBO</sub>	V <sub>CB</sub> =40V, I <sub>E</sub> =0			10	μA
Emitter Cutoff Current	I <sub>EBO</sub>	V <sub>EB</sub> =4V, I <sub>C</sub> =0			10	μA
DC Current Gain	h <sub>FE</sub>	V <sub>CE</sub> =5V, I <sub>C</sub> =0.5A	25*		200*	
Gain Bandwidth Product	f <sub>T</sub>	V <sub>CE</sub> =10V, I <sub>C</sub> =0.1A	100	150		MHz
Output Capacitance	c <sub>ob</sub>	V <sub>CB</sub> =10V, f=1MHz		45	60	pF
C-E Saturation Voltage	V <sub>CE(sat)</sub>	I <sub>C</sub> =1A, I <sub>B</sub> =0.1A		0.15	0.6	V
B-E Saturation Voltage	V <sub>BE(sat)</sub>	I <sub>C</sub> =1A, I <sub>B</sub> =0.1A		0.9	1.2	V
C-B Saturation Voltage	V <sub>(BR)CBO</sub>	I <sub>C</sub> =100μA, I <sub>B</sub> =0		80		V
C-E Saturation Voltage	V <sub>(BR)CER</sub>	I <sub>C</sub> =1mA, R <sub>BE</sub> =150ohm		75		V
E-B Saturation Voltage	V <sub>(BR)EBO</sub>	I <sub>E</sub> =100μA, I <sub>C</sub> =0		5		V
[At specified test circuit]						
Output Power	P <sub>o</sub>	V <sub>CC</sub> =12V, f=27MHz, P <sub>i</sub> =0.2W	4.0			W
Power Efficiency	η			60		%

\*: The 2SC2078 is classified by 0.5A h<sub>FE</sub> as follows:

25	B	50	40	C	80	60	D	120	100	E	200
----	---	----	----	---	----	----	---	-----	-----	---	-----

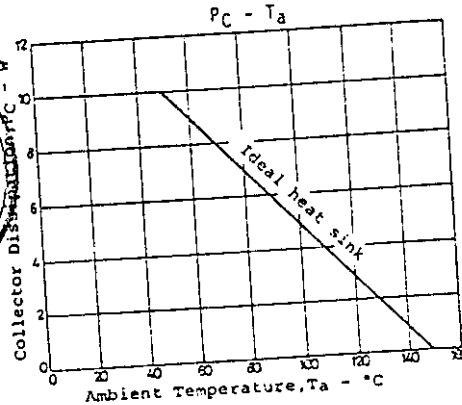
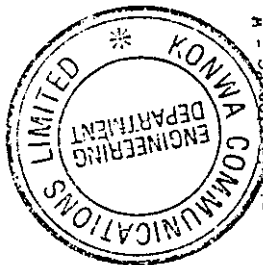

Case Outline 2010A  
(unit:mm)

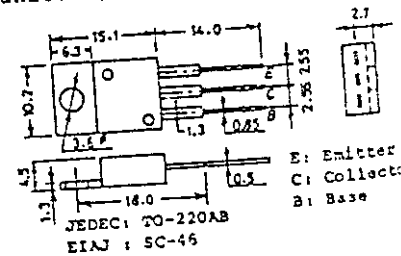

4147KI/3145XI/2274ki No.462

2SC2078 27MHz Output Power Test Circuit

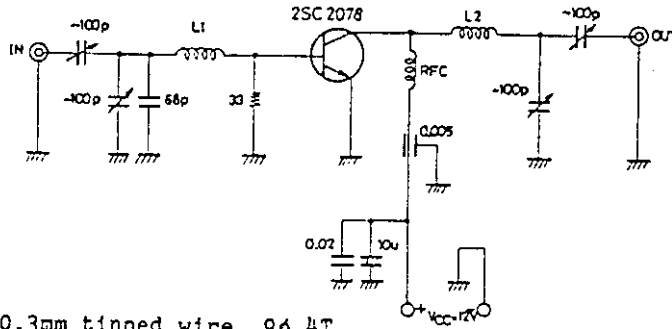

Coil data L1: 0.3mm tinned wire, 9Ø 4T  
 L2: 0.6mm tinned wire, 9Ø 4T  
 RFC 2.2uH

