

Midland

Syn-Tech III P25

Mobile Radio

OPERATION MANUAL

PREFACE

Thank you for purchasing a Midland Syn-Tech III P25 Mobile Radio. Properly used, this product will give you many years of reliable service. To get the most out of your purchase, be sure to carefully read this manual and keep it on hand for later reference when needed.



Before installing and using your radio, please read this operation manual.

CUSTOMER ASSISTANCE

Should you encounter any problems with this product, or are unable to use its features, please review this operation manual. If you require further assistance after reading this manual, please contact your local dealer.

FOR WARRANTY, PRODUCT SERVICE AND ACCESSORY INFORMATION

Please contact your local dealer or distributor.



Do not attempt to service any internal parts yourself. This radio should be opened by authorized personnel only.

Your radio is packed and labeled according to the commercial packaging standards.

IMPORTANT SAFETY INFORMATION



Before installing and using your radio, please read this operation manual.



GENERAL PRECAUTIONS

Always use only Midland authorized accessories.

Unauthorized accessories have the risk of fire hazard, explosion, personal injury or damage to the radio.



CAUTION

Changes or modifications to your radio may void its compliance with government laws/rules and make it illegal to use.

Avoid using the radio at temperatures below -30°C or above 60°C .

Avoid storing the radio at temperatures below -40°C or above 85°C .



WARNINGS

Your Midland Syn-Tech III P25 Mobile Radio generates electromagnetic RF energy when it is transmitting. To ensure that you and those around you are not exposed to excessive amounts of that energy (beyond recommended allowable limits for occupational use):

DO NOT operate your radio without a proper antenna. Otherwise, you can seriously damage your radio.

DO NOT touch the antenna when you are transmitting.

NEVER connect the transceiver to any AC power source. This may cause an electric shock or fire hazard and will damage your radio.

NEVER connect the transceiver to a DC power source either greater than 16 volts or with reverse polarity. Doing so will damage the transceiver.

DO NOT attempt to service any internal parts yourself. Please ask your dealer for necessary service. This radio should be opened by authorized personnel only.

Please read the installation and operating instructions carefully.

FCC EXPOSURE STATEMENTS



Restricted to occupational use to satisfy FCC RF energy exposure limits.

The FCC has adopted a safety standard for human exposure to RF energy. Proper operation of this radio under normal conditions results in user exposure to RF energy below the Occupational Safety and Health Act and Federal Communication Commission limits.

Mandatory Safety Instructions to Installers and Users:

This radio is **NOT** approved for use by the general population in an uncontrolled environment. This radio is restricted to occupational use and work related operations only. Radio operators must have the knowledge to control their exposure conditions and the exposure conditions of bystanders and/or passengers to satisfy the lower exposure limit allowed for General Population.

To comply with FCC RF exposure limits, **DO NOT** operate the transmitter of this mobile radio when a person outside the vehicle is within 22 inches (56 centimeters) of the antenna.

The antenna supplied by the manufacturer or radio dealer must be mounted at a location such that during radio transmission, no person or persons can come closer than the above indicated minimum safe distance to the antenna, i.e. 22 inches. To comply with current FCC RF exposure limits, the antenna must be installed at or exceeding the minimum safe distance stated above, and in accordance with the requirements of the antenna manufacturer or supplier.

Vehicle Installation Instructions:

The antenna used for this transmitter must be mounted on the center of the roof **ONLY** and must be installed in vehicle having the following characteristics in order to prevent bystanders and passengers from being exposed to levels exceeding the limits for General Population/Uncontrolled Exposure environment:

1. All passengers must be sitting under a solid metal roof.
2. For rear deck trunk and roof top installations, the antenna must be located at least 22 inches (56 centimeters) away from rear-seat passengers and bystanders in order to comply with the FCC RF exposure requirements.

DO NOT operate the radio without the proper antenna installed. Do not substitute any antenna for the one supplied or recommended by the manufacturer or radio dealer. Antennas used for this transmitter must not exceed an antenna gain of 3 dBi. By not following the antenna recommendations you may be exposing person(s) to excess radio frequency radiation. You may contact your radio dealer or the manufacturer for further instructions.

DO NOT transmit more than 50% of total radio use time (50% duty cycle). Transmitting for more than 50% of the time can cause FCC RF exposure compliance requirements to be exceeded. This radio is transmitting whenever the Transmit/Receive LED is red. Pressing the PTT switch on the side of the microphone normally causes the radio to transmit.



The preceding information is provided to make you aware of RF exposure and how to ensure that this radio is operated within FCC RF exposure limits.

You, as the qualified end-user of this radio device must control the exposure conditions of bystanders to ensure the minimum separation distance, stated above for satisfying FCC RF exposure compliance, is maintained between the antenna and nearby persons. Transmit only when all person(s) are at least the minimum distance from the properly installed, externally mounted antenna.

PATENT AND COPYRIGHT STATEMENTS



The AMBE+2™ voice coding Technology embodied in this product is protected by intellectual property rights including patent rights, copyrights and trade secrets of Digital Voice Systems, Inc. This voice coding Technology is licensed solely for use within this Communications Equipment. The user of this Technology is explicitly prohibited from attempting to extract, remove, decompile, reverse engineer or disassemble the Object Code, or in any other way convert the Object Code into a human readable form. U.S. Patents Nos. #5,870,405, #5,826,222, #5,754,974, #5,701,390, #5,715,365, #5,649,050, #5,630,011, #5,581,656, #5,517,511, #5,491,772, #5,247,579, #5,226,084, and #5,195,166

PRODUCT FEATURES

Your Midland Syn-Tech III P25 Mobile Radio has the following features:

- 136-174 MHz VHF and 380-470 MHz UHF bands
- Mixed analog and digital mode operation
- Easy installation
- Low maintenance
- Tri-color LCD display
- Full keypad
- High quality audio
- User friendly interface
- Extensive user prompts, alerts and warnings
- Flexible accessory connections
- Microprocessor controlled
- DSP based audio
- Flash memory
- Synthesized frequency control
- Extensive use of surface mount technology
- PC controlled testing and alignment
- CTCSS/CDCSS sub-audible signaling
- 2-Tone / 5-Tone analog signaling
- Analog DTMF encoding
- Conforms with TIA/EIA-603-A standard in Analog Mode
- Conforms with TIA/EIA-102-CAAB standard in Digital Mode
- Conforms with APCO25 EIA / TIA 102 standards
- Conforms with MIL-STD-810E standards



Full technical specifications are given near the back of this manual.

ABBREVIATIONS AND ACRONYMS

ACK	: Acknowledge
AES	: Advanced Encryption Standard
ALG	: Algorithm
ANI	: Automatic Number Identification
dBm	: Decibel Milliwatt
CIK	: Crypto Ignition Key Identity
CDCSS	: Continuous Digital Coded Squelch System
CTCSS	: Continuous Tone Controlled Squelch System
DCS	: Digital Coded Squelch
DES	: Data Encryption Standard
DSP	: Digital Signal Processing
GPS	: Global Positioning System
ID	: Identity
LCD	: Liquid Crystal Display
MSG	: Message
NAC	: Network Access Code
RF	: Radio Frequency
RSSI	: Received Signal Strength Indicator
RX	: Receive
SC	: Selective Call
TCS	: Tone Coded Squelch
TBX	: Telephone Branch Exchange
TX	: Transmit
WACN	: Wide Area Communication Network

TABLE OF CONTENTS

1	INTRODUCTION.....	1
1.1	Package Contents.....	1
2	INSTALLATION.....	2
3	RADIO CONTROLS AND INDICATORS.....	3
3.1	Front and Rear Views.....	3
3.2	Button and Key Functions.....	4
3.2.1	Alpha-Numeric keypad.....	4
3.2.2	Up/Down keys.....	4
3.2.3	Left soft key (Menu).....	4
3.2.4	Right soft key (Index).....	4
3.2.5	Power Adjust (long press)/Mode Change (short press) key.....	5
3.2.6	Monitor (long press)/Call Wait Option (short press) key.....	5
3.2.7	Keypad Lock (short press)/Emergency Reset (long press) key.....	5
3.2.8	Scan key.....	5
3.2.9	Star key.....	6
3.2.10	Pound key.....	7
3.3	Display Icons.....	9
3.4	Alpha-numeric Keypad Entry.....	11
4	OPERATION.....	12
4.1	Basic Operation.....	12
4.1.1	Turning the Radio On and Off.....	12
4.1.2	Selecting Zones.....	13
4.1.3	Selecting Channels.....	15
4.1.4	Receiving Signals.....	16
4.1.5	Transmitting to Other Radios.....	17
4.1.6	Selecting Transmit Power.....	20
4.1.7	Selecting Digital Talk Group.....	21
4.1.8	Selecting Talkaround Transmit Mode.....	23
4.1.9	Monitoring Channels.....	24
4.1.10	Selecting Digital Call Wait Option.....	26
4.1.11	Scanning Channels.....	27
4.1.12	Locking the Keypad.....	30
4.1.13	Switching to the Home Zone and Channel.....	31
4.2	Advanced Operation.....	32
4.2.1	Receiving Emergency Calls.....	32
4.2.2	Transmitting Emergency Calls.....	33
4.2.3	Receiving Digital Individual Calls.....	34
4.2.4	Transmitting Digital Individual Calls.....	36
4.2.5	Transmitting Digital Unaddressed Calls.....	38
4.2.6	Transmitting Digital Telephone Interconnect Calls.....	39
4.2.7	Receiving a Digital Call Alert.....	40
4.2.8	Transmitting a Digital Call Alert.....	40
4.2.9	Receiving and Sending Non-voice Messages.....	41



4.2.10	Channel Programming	49
4.3	Menu Operation	50
4.3.1	Analog Mode Menu Tree	50
4.3.2	Digital Mode Menu Tree.....	52
5	ACCESSORIES	55
6	STORAGE AND CLEANING PRECAUTIONS	56
7	TROUBLESHOOTING.....	57
8	SPECIFICATIONS	58
8.1	Receiver Technical Specifications.....	60
8.2	Transmitter Technical Specifications.....	61
9	WARRANTY STATEMENT	62

1 INTRODUCTION

1.1 Package Contents

The following items are in your Midland Syn-Tech III P25 Mobile Radio package:

Transceiver Assembly



Microphone



Operation Manual



Microphone Hanger



Power Cord



Loudspeaker



Mounting Bracket

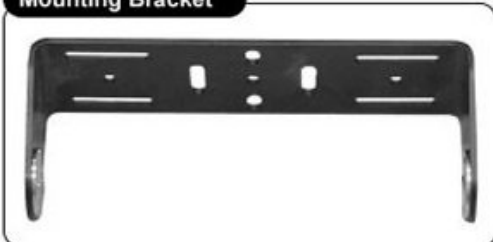



2 Installation

Installation should be performed by an Authorized Midland LMR Dealer only.

Radio installation should be performed by qualified and trained personnel, familiar with automotive electronics installation, and FCC RF exposure guidelines. This transceiver should be installed in 12V negative ground vehicles only. Installation instructions are available in the corresponding radio service manual.

Antenna selection, installation and positioning requires knowledge of RF radiation and exposure conditions and should be performed by qualified personnel only. Please consult your dealer or communications coordinator for more information.

3 Radio Controls and Indicators

3.1 Front and Rear Views

Mobile Radio Front View

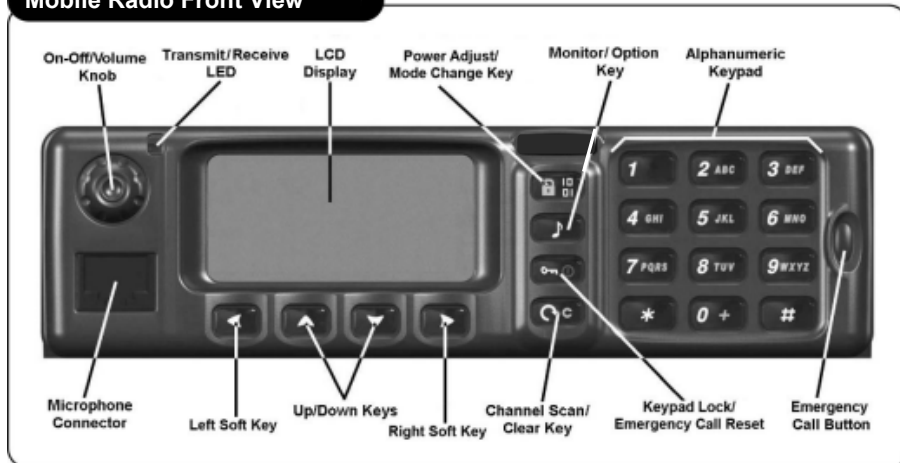

Mobile Radio Rear View

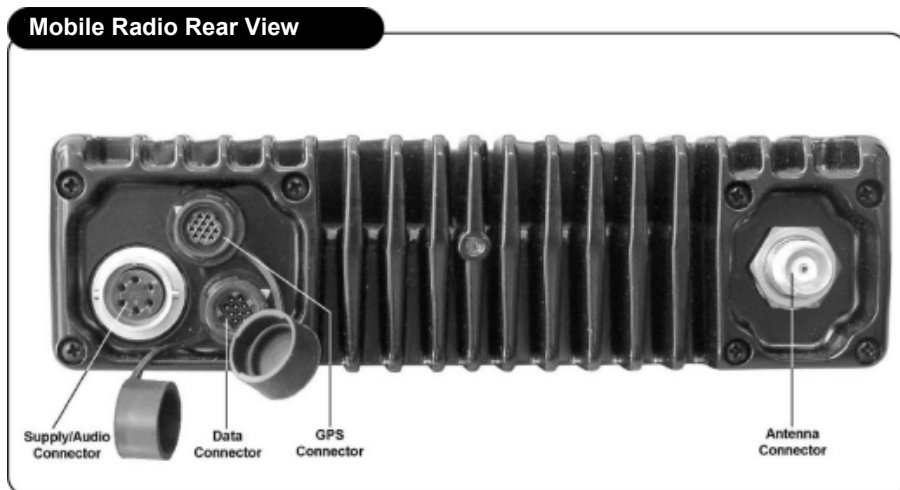

3.2 Button and Key Functions

Below is a brief description of each button or key. For more details of each function refer to the operation section of this manual. Many of the functions may be disabled by radio programming or unavailable because of the current analog/digital mode selection. Many of the buttons have a short press, or press and release function, and a long press, or press and hold function. The short press is function is performed if the button is pressed for less than one second, and the long press function is performed if the button is pressed for more than one second.



3.2.1.1 Emergency Call Button

The emergency button initiates emergency mode. The emergency function is only available in digital mode. The emergency key must be pressed for five seconds to activate the emergency function. Once emergency mode is activated, the radio will switch to emergency channel and initiate five SBC emergency transmissions. The emergency bit will be set on all user initiated digital transmissions until the emergency is cleared by a long press of the keypad lock key or the radio is turned off.



3.2.2 Alpha-Numeric keypad

The alpha-numeric keypad provides direct channel select from standby mode. The alpha-numeric keypad also generates DTMF tones while PTT is pressed on analog channels and enters alpha-numeric characters within other functions.



3.2.3 Up/Down keys

The up/down keys provide up/down channel select from standby mode. The up/down keys are generally used to scroll through lists within other functions.



3.2.4 Left soft key (Menu)

The left soft key enters the menus from standby mode. The left soft key is generally used as SELECT or OK within other functions.



3.2.5 Right soft key (Index)

The right soft key accesses the index (20 unit ID address book) from standby mode. Once the appropriate ID is displayed, press SELECT to edit the entry or # to initiate an acknowledged individual call to the displayed unit. Up to six of the first entries may be

predefined in radio programming and may not be editable. Individual call initiation may be disabled by radio programming.

The right soft key is generally used as EXIT within other functions. The right soft key is used a nuisance channel delete during scan.



3.2.6 **Power Adjust (long press)/Mode Change (short press) key**

A long press of this key changes the transmit power level. The selections are high, medium and low power. A default power level is set each time the channel is selected.

A short press of this key changes the transmit mode on multi-mode and digital channels. The selections may include analog, digital clear, and digital encrypted transmit modes. A default mode is set each time the channel is selected.



3.2.7 **Monitor (long press)/Call Wait Option (short press) key**

A long press of this key turns monitor on. The function of the monitor button depends on digital/analog/mixed mode and the radio programming. If monitor is enabled the monitor function may disable the squelch on analog and mixed channels. The monitor function may allow all NACs and talk groups to be received on digital and mixed channels. While monitor is on, a long press of the Monitor/Call Wait key turns monitor off.

A short press of this key turns the call wait option on. The call wait option is available only on digital channels. When the call wait option is on, group calls will be muted. If an individual call (addressed to the radio) or all call is received, the call will be heard and the call wait option will be canceled. While call wait is on, a short press of the Monitor/Call Wait key turns call wait off.



3.2.8 **Keypad Lock (short press)/Emergency Reset (long press) key**

A short press of this key initiates keypad lock. While the keypad is locked, a short press of the Keypad Lock/Emergency Reset key will initiate keypad unlock mode.

While the emergency function is active, a long press of the Keypad Lock/Emergency Reset key will cancel the emergency mode.



3.2.9 **Scan key**

A short press of this key turns on selectable priority scan. Selectable priority scan assigns the selected channel as the high priority channel. A second, lower priority channel may be assigned in radio programming. All channels in the selected zone's

scan list will be scanned. If PTT is pressed while scanning, the radio will transmit on the high priority channel. If PTT is pressed while scan is paused on a channel the radio will transmit on the pause channel. If MENU is pressed scan is canceled. While scan is on, a short press of the Scan key cancels scan.

The Scan key is also used as a clear (long press) or backspace (short press) key during alpha-numeric keypad entry.

3.2.10 Star key

The * key is a multi-function key allowing selection of several functions with successive presses. The available functions depend on analog/digital mode. In digital mode the talk group select, all call, talkaround and home functions may be available. In analog mode the talkaround and home functions may be available.

3.2.10.1 Switching Talk Group

The first press of the * key may prompt "GROUP:" to enter a new talk group. This function is only available in digital mode and the entered talk group must be in the selected zone's talk group list.

3.2.10.2 Entering/Exiting Unaddressed Voice Call Mode

Successive presses of the * key may prompt "ENTER TO UNADDRESSED VOICE CALL?" or "EXIT UNADDRESSED VOICE CALL?" to enter/exit unaddressed voice call mode. This function is only available in digital mode. Unaddressed Voice Call mode implements an all call function to all talk groups using the channel.



Transmitting unaddressed calls may be disabled by radio programming.

3.2.10.3 Entering/Exiting Talkaround Mode

Successive presses of the * key may prompt "ENTER TO TALKAROUND MODE?" or "EXIT TALKAROUND MODE?" to enter/exit talkaround mode. This option is not available on simplex (direct) channels. The talkaround function sets the transmitter to the programmed receive frequency/CTCSS/DCS/NAC.

3.2.10.4 Switching to Home Zone and Channel

Successive presses of the * key may prompt "GO TO HOME?" to switch to the home zone and channel.

3.2.11 Pound key

The # key is a multi-function key allowing selection of several functions with successive presses. The available functions depend on analog/digital mode. In digital mode the zone select, status set, individual call, telephone call and call alert functions may be available. In analog mode the zone select, selective call and two tone call functions may be available.

3.2.11.1 Switching Zones

The first press of the # key may prompt “ZONE NO:” to switch zones. The up/down keys will scroll through the available zones. The left soft key selects the displayed zone and the right soft key exits without changing zones.

3.2.11.2 Setting Current Status

Successive presses of the # key may prompt “CUR. STATUS:” to set the current status. This function is only available in digital mode. The current status is used when sending status to other users, or when other users request the current status. The current status may also be set under MENU | STATUS | PRESENT STATUS.



Sending current status and requesting status from other users may be disabled in radio programming. You may still set current status and receive status messages from other users.

3.2.11.3 Entering Unacknowledged Individual Call Mode

Successive presses of the # key may prompt “INDIVIDUAL:” to enter unacknowledged individual call mode. This function is only available in digital mode. A unit ID may be entered or selected from the index list. Once a unit ID is selected, the radio will enter individual call mode. The radio will transmit unit to unit calls to the entered unit ID each time PTT is pressed. If PTT is not pressed and no signal is received the individual call mode will time out after ten seconds.



Individual calling may be disabled by radio programming.

3.2.11.4 Initiating a Telephone Interconnect Request

Successive presses of the # key may prompt “TELEPHONE:” to initiate a telephone call. This function is only available in digital mode. This function initiates a telephone interconnect request on the RF subsystem.



Telephone calling may be disabled or the number of dial digits may be limited by radio programming.

3.2.11.5 Sending a Call Alert

Successive presses of the # key may prompt “CALL ALERT:” to initiate a call alert transmission. This function is only available in digital mode.



Call alert transmissions may be disabled by radio programming.

3.2.11.6 Transmitting a Selective Call

Successive presses of the # key may prompt “SELECTIVE CALL” to transmit a selective call. This function is only available in analog mode.



Selective calling may be disabled by radio programming.

3.2.11.7 Transmitting a 2-Tone Call

Successive presses of the # key may prompt “TWO-TONE CALL” to transmit a 2-tone call. This function is only available in analog mode.



Two-tone calling may be disabled by radio programming.

3.3 Display Icons

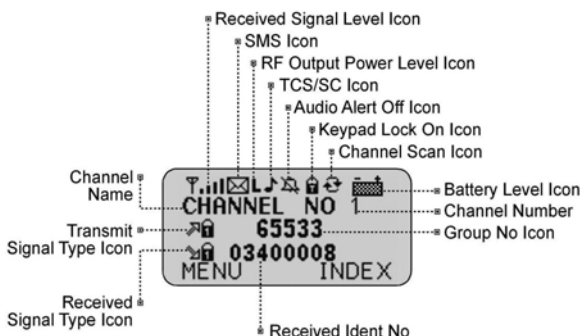

























Table 1: Display Icons

	This Digital Receive icon appears when a clear (unencrypted) digital signal is received.
	This Digital Talkaround Receive icon appears when a clear digital signal is received in direct or talkaround mode.
	This Digital Encryption 1 Receive icon appears when an encrypted digital signal using the first encryption algorithm is received.
	This Digital Encryption 2 Receive icon appears when an encrypted digital signal using the second encryption algorithm is received.
	This Analog Transmit icon appears when the radio is set to transmit in analog mode.
	This CTCSS Transmit icon appears when the radio is set to transmit in analog mode with CTCSS.
	This CDCSS Transmit icon appears when the radio is set to transmit in analog mode with CDCSS.
	This Analog Talkaround Transmit icon appears when the radio is set to transmit in analog talkaround mode.
	This Digital Transmit icon appears when the radio is set to transmit in clear digital mode.
	This Digital Talkaround Transmit icon appears when the radio is set to transmit in digital talkaround mode.
	This Digital Encryption 1 Transmit icon appears when the radio is set to transmit in digital encrypted mode using the first encryption algorithm.
	This Digital Encryption 2 Transmit icon appears when the radio is set to transmit in digital encrypted mode using the second encryption algorithm.
	This Received Signal Level icon appears when a signal is being received. The number of bars indicates the relative signal strength.
	This SMS icon appears after an SMS is received and remains on until the message is read.

	This High Power icon appears when high transmit power level is selected.
	This Mid Power icon appears when medium transmit power level is selected.
	This Low Power icon appears when low transmit power level is selected.
	This Tone Squelch icon appears when channel is set to receive a CTCSS or CDCSS signal.
	This Call Wait icon appears when digital call wait mode is selected.
	This Alert Tones Off icon appears when alert tones are disabled.
	This Keypad Lock icon appears when keypad lock is selected.
	This Scan icon appears when scan is selected.
	This Low Battery icon appears when a low voltage condition is detected.

3.4 Alpha-numeric Keypad Entry

The keypad is used to enter alpha-numeric characters within many functions. When the radio is in alpha-numeric mode, successive presses (less than one second apart) of the keys will step through the available characters. Pausing for more than a second will accept the displayed character and move the cursor right one space. A short press of the Scan/Clear key deletes the previous character and move the cursor left one space. A long press of the Scan/Clear key returns the radio to standby mode.

Table 2: Alpha-numeric Keypad Entry

Keys	Number of Key Presses										
	1	2	3	4	5	6	7	8	9	10	11
1	Space	1									
2	A	B	C	2	a	b	c	Ç	ç		
3	D	E	F	3	d	e	f				
4	G	H	I	4	g	h	i	Ğ	ğ	İ	ı
5	J	K	L	5	j	k	l				
6	M	N	O	6	m	n	o	Ö	ö		
7	P	Q	R	S	7	p	q	r	s	Ş	ş
8	T	U	V	8	t	u	v	Ü	ü		
9	W	X	Y	Z	9	w	x	y	z		
0	0	+	.	,	:	;	!	"	'		
*	*	/	\	-	()	@				
#	#	?	€	\$	%	&	<	=	>		

4 OPERATION

4.1 Basic Operation

Despite the radio's advanced feature set, the basic receive and transmit operations can still be quite simple. The radio is capable of distinguishing between analog and digital signals, and the channel may be configured to receive both signal types with no user intervention. The radio channel may also be configured to allow users to transmit analog signals, digital signals, or choose the appropriate transmit mode.

4.1.1 Turning the Radio On and Off



Figure 4.1 – On/Off

Press and release the On/Off Volume Knob to turn the mobile radio on. Press and hold the On/Off Volume Knob at least two seconds to turn the mobile radio off. Rotate the knob clockwise to increase the speaker volume. Rotate the knob counter-clockwise to decrease the speaker volume.



Figure 4.2 – Increase volume

While the radio is performing power-on self-tests, it will display the greeting message and the current zone selection. The radio will power-on to the last selected channel.



Figure 4.3 – Decrease volume

If a power-on password has been set, the radio will prompt for password entry when it is turned on. Use the numeric keypad to enter the correct password then press the left soft key (OK). If the password is entered incorrectly five times, the radio will lock and must be reprogrammed to reset the password.

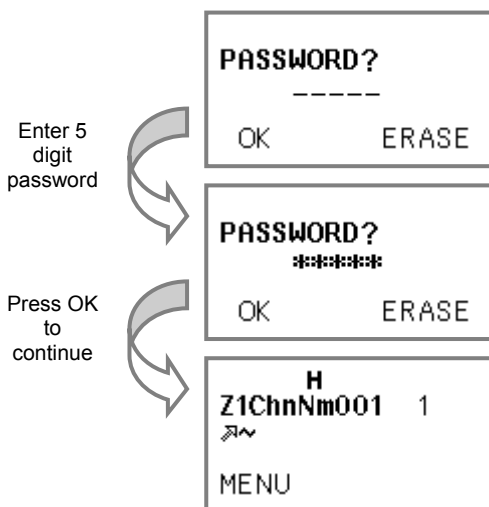



Figure 4.4 – Power-on password entry

4.1.2 Selecting Zones

The radio channels may be organized into zones or channel groupings to sort and organize the channels. To

select a new zone, press the  (pound) key, then use the Up/Down keys to scroll through the available zones. The new zone number may also be entered using the keypad. Press the left soft key (OK) to switch to the new zone. The first channel in the new zone will be displayed.

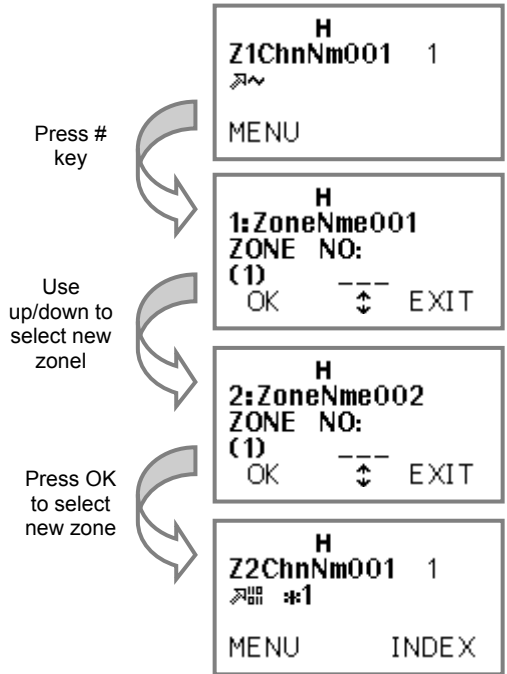

Figure 4.5 – Zone selection using # key

A new zone may also be selected using MENU | CHANNEL PARAMETERS | ZONES.

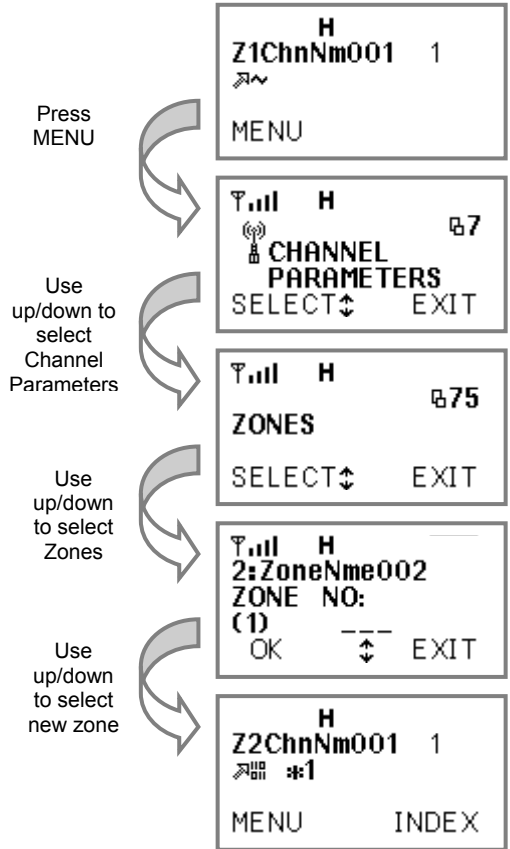



Figure 4.6 – Zone selection using Menu

4.1.3 Selecting Channels

The  (up/down) keys may be used to increment or decrement the channel selection.



The  (alpha-numeric keypad) may be used to enter a channel number for direct channel selection.

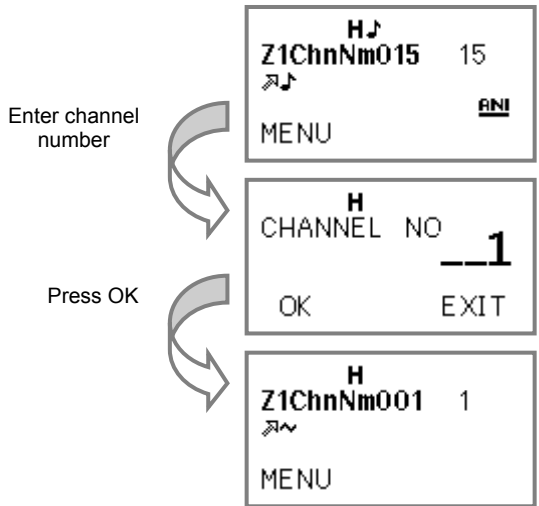



Figure 4.7 – Direct channel number entry

4.1.4 Receiving Signals

The radio channel may be configured to receive only analog transmissions, only digital transmissions or both. If the channel is programmed to receive both analog and digital signals (mixed mode receive), the radio will automatically switch to the appropriate mode when receiving the signal.

4.1.4.1 Analog Reception

An analog signal exceeding the squelch threshold is indicated by a green Transmit/Receive LED. A relative value of signal strength is also indicated by the Received Signal Level icon (). If the channel's analog reception parameters are met, the received audio is heard over the speaker.

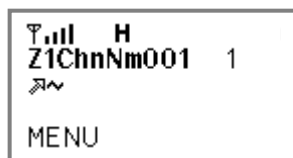



Figure 4.8 – Analog receive display

4.1.4.2 Digital Reception

A decoded digital signal is indicated by a green Transmit/Receive LED and the digital Received Signal Type icon (). A relative value of signal strength is also indicated by the Receive Signal Strength icon (). If the channel's digital reception parameters are met, the received audio is heard over the speaker.

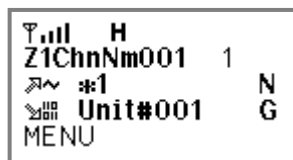





Figure 4.9 – Digital receive display

More information is displayed about the digital receive signal. While receiving, the talk group ID is displayed in decimal format on the third line (***1**), and the source ID is displayed in decimal format on the fourth line (**00000002**). If the received source ID is in the radio's address book, the name associated with the source ID will be displayed (**Unit#001**). If the received signal has status bits set to 0, the direct or Digital Talkaround icon is displayed to the left of the source ID (), otherwise the Digital Receive icon is displayed (). To the right of the talk group ID is a single letter indicating the emergency bit is normal (**N**) or emergency (**E**). To the right of the source ID is a single letter indicating the link control format is set for group call (**G**) or individual call (**I**).

4.1.5 Transmitting to Other Radios

The radio channel may be configured to transmit in analog mode, digital mode or to allow you to select either analog or digital mode. A default mode is chosen by radio programming. The default mode is used each time the channel is selected or radio is turned on with the channel selected. The other available modes may be chosen by successive short presses of the Power Adjust/Mode Change key.

4.1.5.1 Analog Transmissions

1. Press the  (Power Adjust/Mode Change) key repeatedly until analog transmit mode is displayed. Depending on channel programming, the analog transmit mode may display as carrier squelch (🔊), CTCSS squelch (🔊🎵) or CDCSS squelch (🔊🎵).
2. Ensure that the channel is clear.
3. Press and hold the push to talk key (PTT). The Transmit/Receive LED will light red while transmitting.
4. Hold the microphone approximately two inches from your mouth and speak in a clear, normal voice. Keep the PTT switch pressed until you have finished speaking.
5. Release the PTT switch to return to standby mode and receive any reply.

Short press of Mode Change key selects digital mode

Short press of Mode Change key selects analog mode

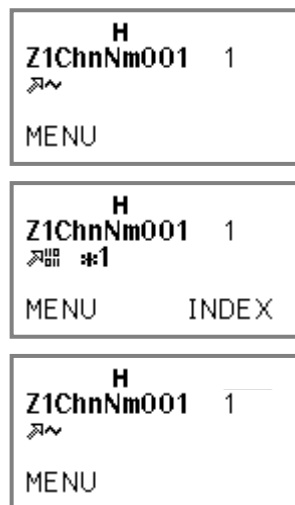

Figure 4.10 – Transmit mode selection

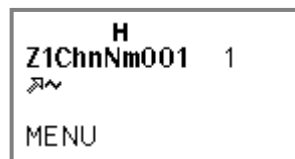

Figure 4.11 – Carrier transmit display

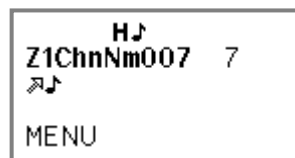

Figure 4.12 – CTCSS transmit display

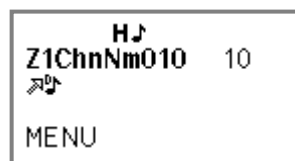



Figure 4.13 – CDCSS transmit display

4.1.5.2 Digital Transmissions

1. Press the  (Power Adjust/Mode Change) key repeatedly until digital transmit mode is displayed ().
2. Check that the correct talk group ID is selected.
3. Ensure that the channel is clear.
4. Press and hold the push to talk key (PTT). The Transmit/Receive LED will light red while transmitting.
5. Hold the microphone approximately two inches from your mouth and speak in a clear, normal voice. Keep the PTT switch pressed until you have finished speaking.
6. Release the PTT switch to return to standby mode and receive any reply.

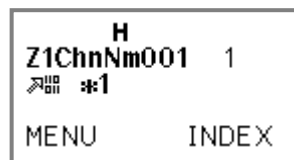

Figure 4.14 – Digital transmit display

4.1.5.3 Time Out Time

A Time Out Time may be programmed to limit the length of continuous transmissions. If the Time Out Time is exceeded, release PTT and wait for the channel to be available again. The Time Out Time may be set from 15-225 seconds in radio programming.

4.1.5.4 Busy Channel Lockout

The radio may be programmed to inhibit transmission while the channel is busy. Wait until the channel is clear before transmitting.

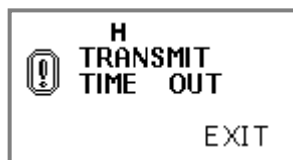



Figure 4.15 – Transmit time out



Figure 4.16 – Busy channel lockout

4.1.6 Selecting Transmit Power

To minimize interference with others, use the lowest transmit power that will provide adequate range. The radio has three transmit power levels which are selected with successive long presses of the Power Adjust/Mode Change key. The actual transmit power associated with each level is set in radio programming. To switch to the next power level, press and hold

the  (Power Adjust/Mode Change) key for more than one second.

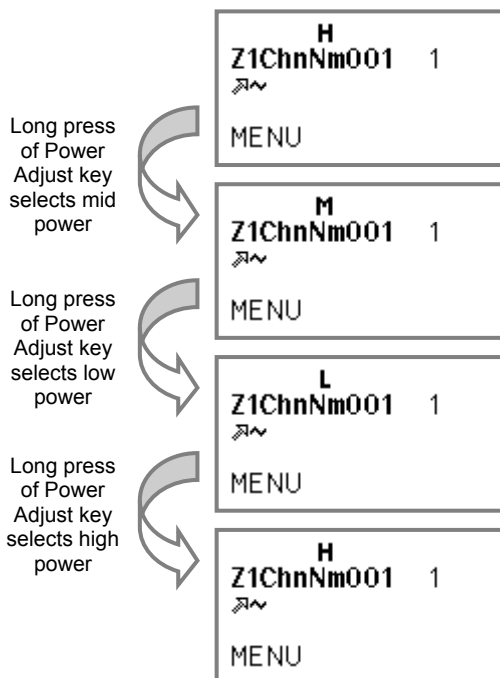



Figure 4.17 – Transmit power selection

4.1.7 Selecting Digital Talk Group

The default talk group may be set for the channel in radio programming. When the channel is selected, the default talk group is used. If a default talk group has not been set for the channel, the radio will use the talk group last selected and displayed.

Each zone in the radio may have a list of allowed talk groups. When the radio is in digital transmit mode, you may select a new talk group from this list by repeatedly

pressing the  (star) key until "GROUP:" is displayed. Then use the alpha-numeric keypad to enter the new talk group. Then press the left soft key (OK) to use the entered talk group. If the entered talk group is not in the zone's talk group list, the radio will not allow the talk group selection.

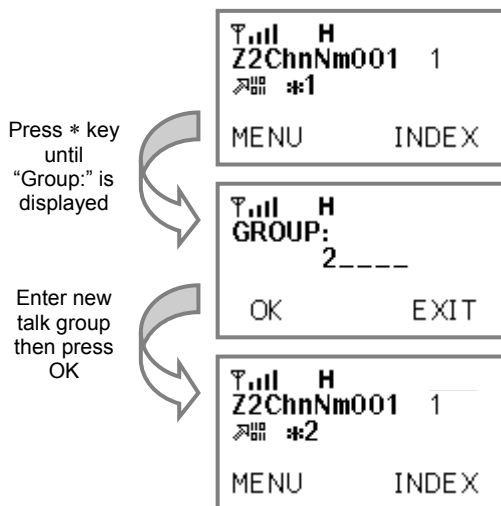



Figure 4.18 – Talk group selection using * key

Each zone in the radio may have all valid talk groups assigned to it. This allows any talk group to be selected by the by repeatedly pressing the  (star) key until "GROUP:" is displayed. Then use the alpha-numeric keypad to enter the new talk group. Then press the left soft key (OK) to use the entered talk group.

The radio has a talk group scan feature which is on by default. When a signal is received from any talkgroup in the list, the radio will switch to the received talkgroup for the duration of the receive signal and then start the scan delay timer. You may reply using the received talk group during the scan delay time, by pressing PTT. After the scan delay time expires the radio will switch back to the selected talk group. Use MENU | CHANNEL PARAMETERS | GROUP SCAN to turn talk group scan on/off.

The zone's talk group list may be viewed and a new talk group may also be selected from MENU | CHANNEL PARAMETERS | GROUPS.

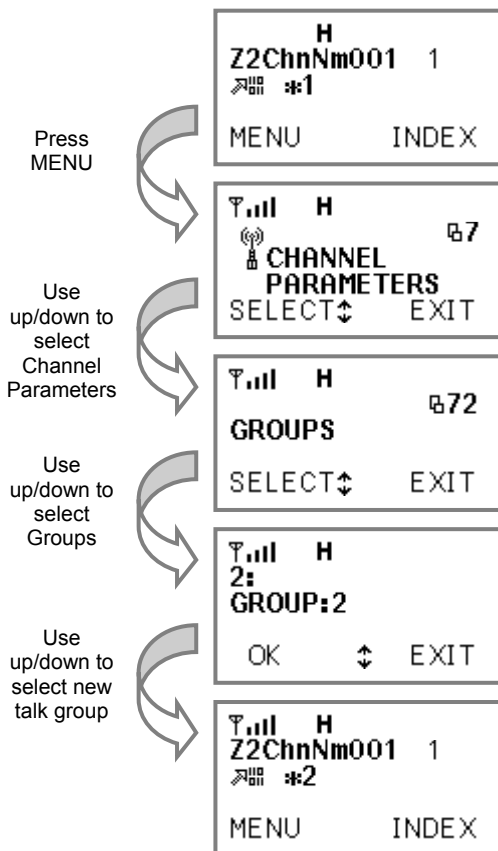





Figure 4.19 – Talk group selection using Menu

4.1.8 Selecting Talkaround Transmit Mode

On channels programmed for repeater operation, the radio may be set to talkaround mode. Talkaround mode allows direct mobile to mobile communication without accessing the repeater. Repeatedly press the  (star) key until “ENTER TO TALKAROUND MODE?” is displayed then press the left soft key (YES). The radio will switch it’s transmit frequency parameters to those programmed for receive. The Analog Talkaround icon () or Digital Talkaround icon () is displayed while talkaround mode is active

The radio will remain in talkaround mode until it is canceled, the channel is changed, the radio is turned off, or a new zone is selected. To cancel talkaround mode,

repeatedly press the  (star) key until “EXIT TALKAROUND MODE?” is displayed, then press the left soft key (YES).

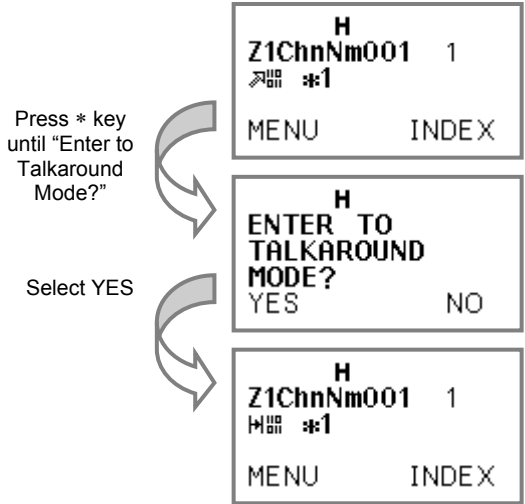

Figure 4.20 – Entering talkaround mode

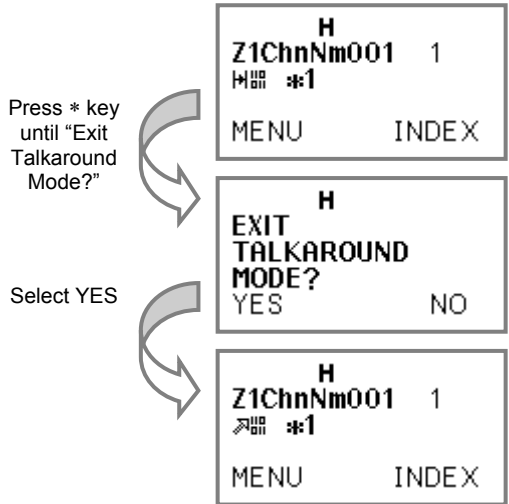



Figure 4.21 – Exiting talkaround mode

4.1.9 Monitoring Channels

Press and hold the  (Monitor/Call Wait Option) key for more than one second to turn the monitor function on. The function of the monitor button depends on radio programming. If Monitor Channel is enabled, the monitor function will disable the squelch on analog and mixed channels.

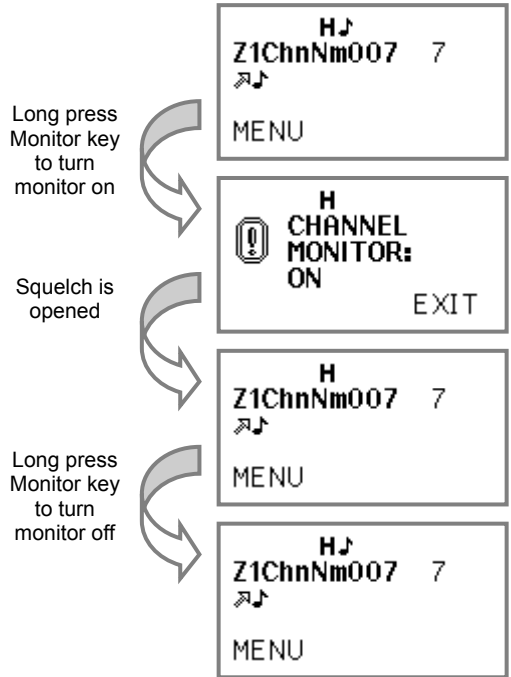

Figure 4.22 – Monitoring channel

If Monitor All NACs & T.Groups is enabled, the monitor function allows all NACs and talk groups to be received on digital and mixed channels. While monitor is on, a long press of the



(Monitor/Call Wait Option) key turns monitor off.

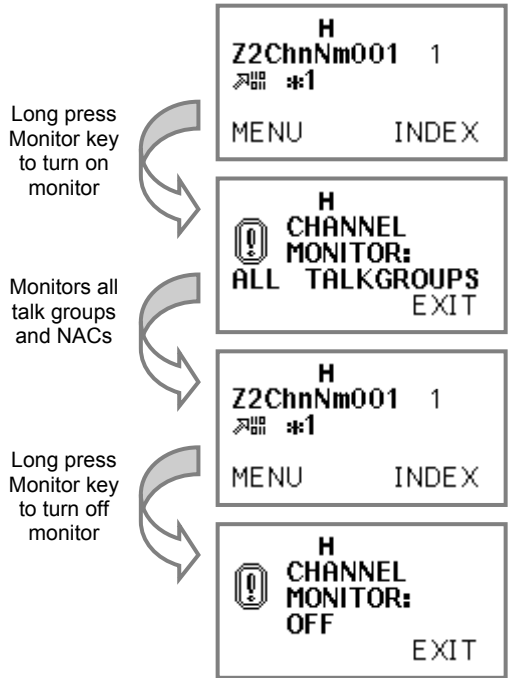





Figure 4.23 – Monitoring all talk groups and NACs

4.1.10 Selecting Digital Call Wait Option

A short press of the  (Monitor/Call Wait Option) key turns the call wait option on. The Call Wait icon () is displayed while call wait mode is on. While the call wait option is on, all normal group calls will be muted. If an individual call (with matching destination ID) or all call is received, the call will be heard and the call wait option will be canceled. While call wait is on, a short press of the  (Monitor/Call Wait Option) key turns call wait off.

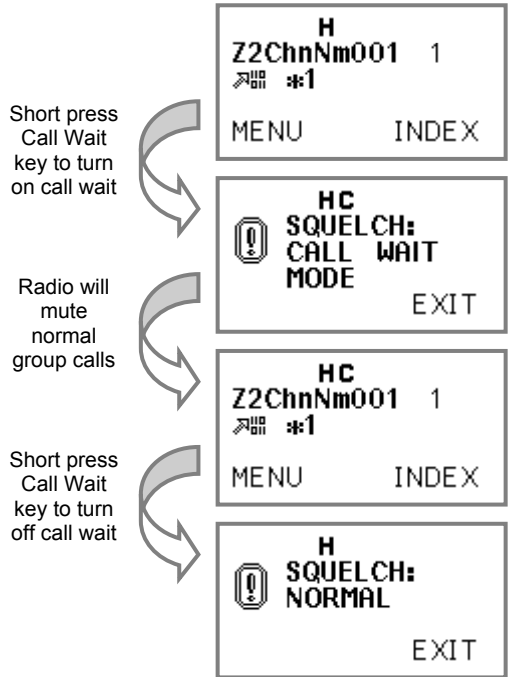





Figure 4.24 – Selecting call wait option

4.1.11 Scanning Channels

A short press of the  (Scan) key turns on selectable priority scan. The Scan icon () is displayed while scan is active. Selectable priority scan assigns the selected channel as the high priority channel. A second, lower priority channel may be assigned to each zone in radio programming. All channels in the selected zone's scan list will be scanned. If MENU is pressed or the portable channel knob is changed, scan is

canceled. While scan is on, a short press of the  (Scan) key cancels scan.

4.1.11.1 Transmitting While Scanning

If PTT is pressed while scanning the radio will transmit on the high priority channel.

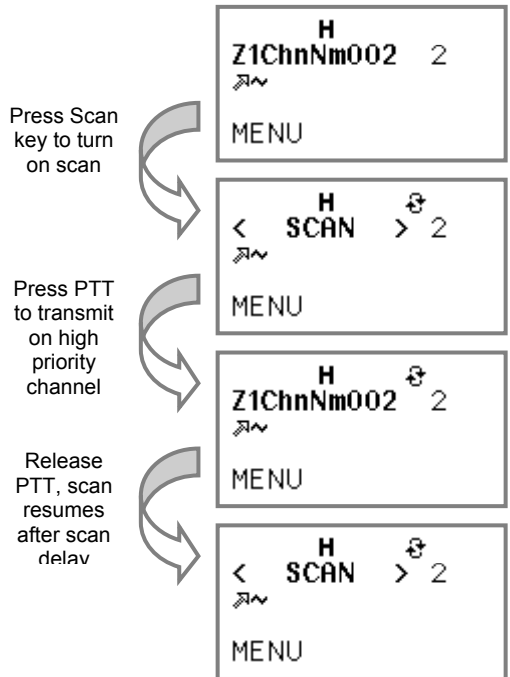

Figure 4.25 – Pressing PTT while scanning

If PTT is pressed while scan is paused on a channel the radio will transmit on the pause channel.

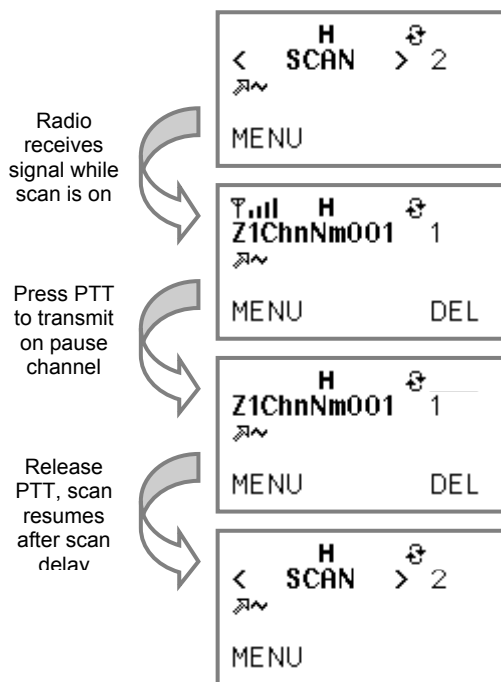

Figure 4.26 – Pressing PTT while scan is paused

4.1.11.2 Editing the Scan List

You can add and delete channels from the selected zone's scan list using MENU | CHANNEL PARAMETERS | CHANNEL SCAN. If a "+" is displayed above the channel name, the channel is currently in the scan list. If "-" is displayed above the channel name, the channel is not in the scan list. A "1" or "2" indicate priority channel selections.

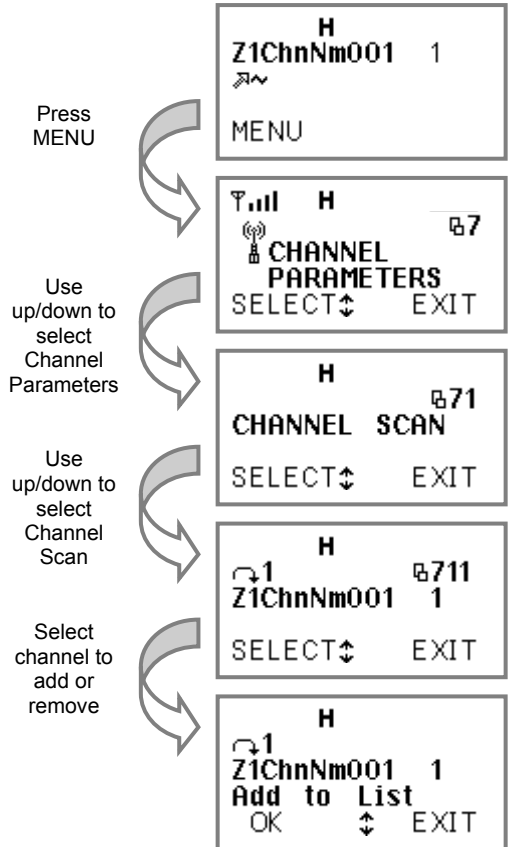



Figure 4.27 – Editing the zone's scan list

4.1.12 Locking the Keypad

Press the  (Keypad Lock) key to lock the alpha-numeric, up/down, scan, and left and right soft keys. While the keypad is

locked, press the  (Keypad Lock) key, then press the left soft key (UNLOCK) to unlock the keypad.

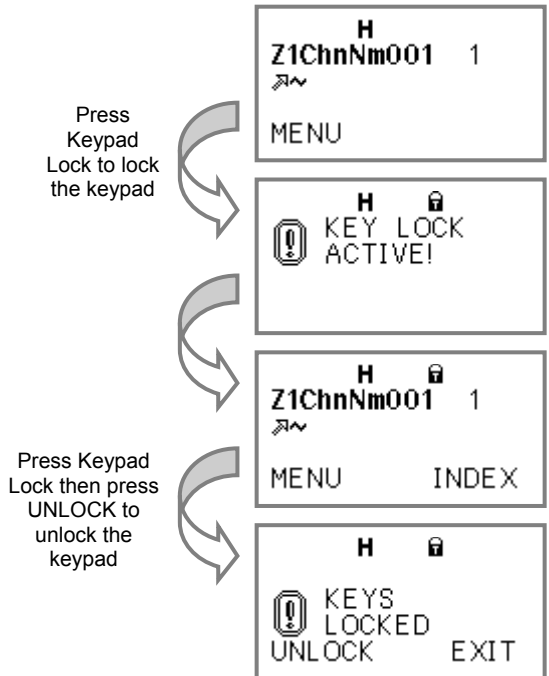



Figure 4.28 – Locking the keypad

4.1.13 Switching to the Home Zone and Channel

Press the  (star) key repeatedly until the "Go to Home?" is displayed. Then press the left soft key (OK) to switch to the home zone and channel. The home zone and channel are set in radio programming.

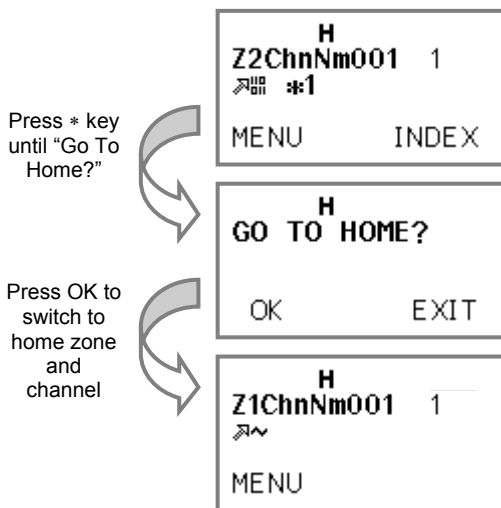

Figure 4.29 – Switching to the home zone and channel

4.2 Advanced Operation

Some of the radio's more advanced operations are listed in this section. Most of these advanced features may be disabled in radio programming. In this case, the feature being described may not appear, or may have a reduced, view only function.

4.2.1 Receiving Emergency Calls

When an emergency alert transmission is received, the radio sounds and displays the emergency alert and displays the unit ID of the sender. Pressing any key will silence the alert tone. Press the right soft key to exit the emergency display mode. When a call with the emergency bit set is received the radio displays the call with emergency bit indicator (E).

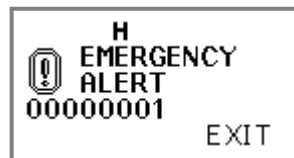

Figure 4.30 – Emergency alert display

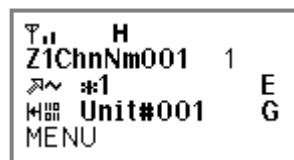

Figure 4.31 – Emergency call display

4.2.2 Transmitting Emergency Calls



Press and hold the (emergency) key for five seconds to activate the emergency function. Once emergency mode is activated, the radio switches to the emergency channel set for the selected zone in radio programming or initiates the emergency transmissions on the current channel.

The radio will automatically transmit five emergency alert transmissions and set the emergency bit on all user initiated transmissions until the emergency is cleared. The emergency is cleared by a long



press of the (Keypad Lock) key or by turning the radio off.

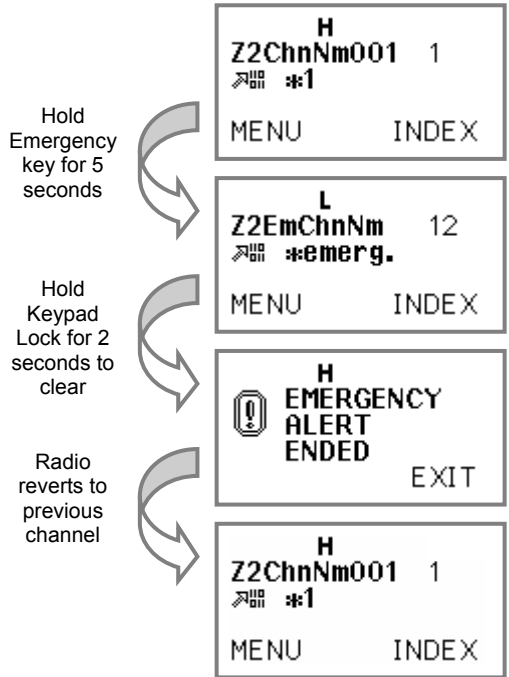

Figure 4.32 – Transmitting in emergency mode



Emergency calls may be disabled in radio programming. When emergency calls are disabled the emergency button will not function.

4.2.3 Receiving Digital Individual Calls

Individual calls are addressed to a single unit ID rather than a talk group. This radio is capable of receiving both unacknowledged and acknowledged individual calls.

4.2.3.1 Receiving Unacknowledged Individual Calls

When an unacknowledged individual call is received, the radio will enter individual call mode. The radio will automatically use the received source ID as the destination ID in individual call replies.

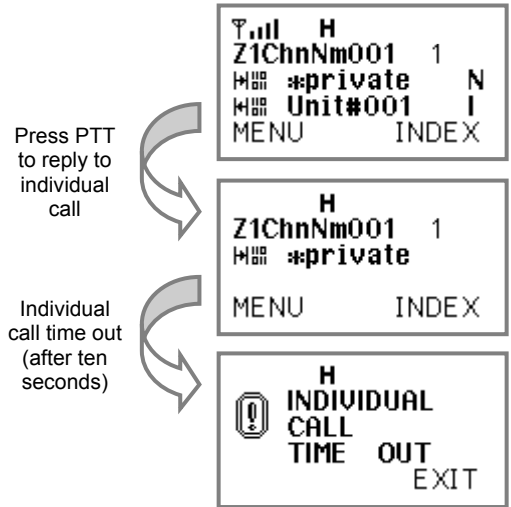

Figure 4.34 – Receiving unacknowledged individual call



If no signal is received and PTT is not pressed for ten seconds, individual call mode will time out.

4.2.3.2 Receiving Acknowledged Individual Calls

When an acknowledged individual call request is received, you may accept or reject the call. The initiating radio will receive the accepted or rejected response. If the call is unanswered the display will show the missed call.

If the call is accepted the radio will enter individual call mode and use the received source ID as the destination ID in individual call replies.

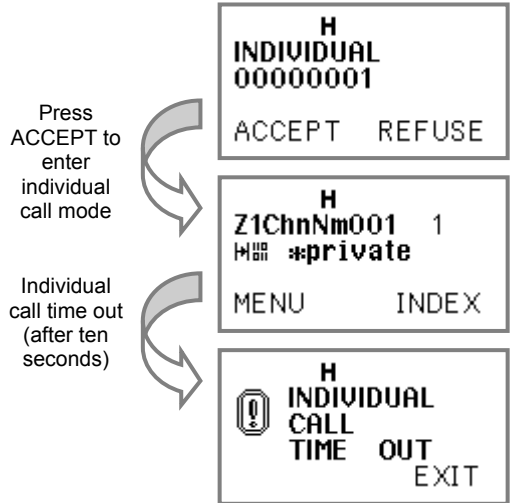

Figure 4.34 – Receiving acknowledged individual call

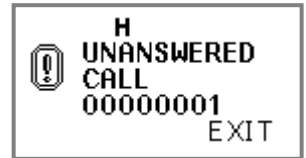

Figure 4.35 – Missed individual call



If no signal is received and PTT is not pressed for ten seconds, individual call mode will time out.

4.2.4 Transmitting Digital Individual Calls

Individual calls are addressed to a single unit ID rather than a talk group. This radio is capable of transmitting both unacknowledged and acknowledged individual calls. Most digital radios are capable of receiving unacknowledged individual calls, but some may not be able to respond to an acknowledged individual call.

4.2.4.1 Transmitting Unacknowledged Individual Calls

Repeatedly press the

 (pound) key until "INDIVIDUAL:" is displayed. Enter the unit ID or press the left soft key (INDEX) to select from the address book. Press the left soft key (OK) to enter unacknowledged individual call mode.

Then press PTT to initiate an individual call to the selected unit ID.



If no signal is received and PTT is not pressed for ten seconds, individual call mode will time out.

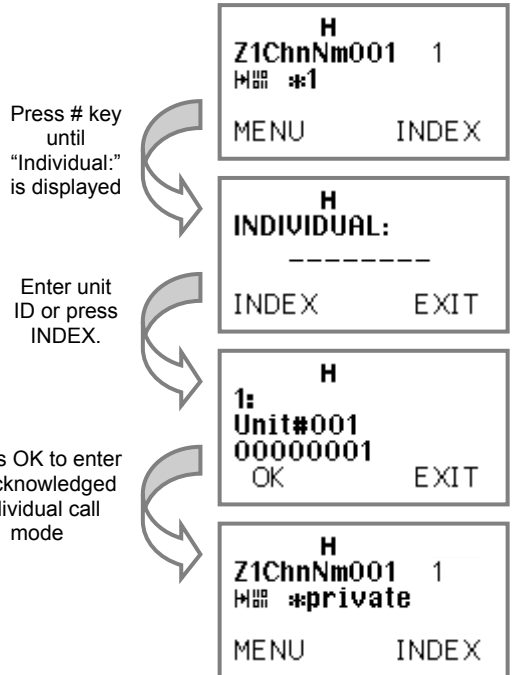



Figure 4.36 – Unacknowledged individual call mode



Individual call initiation may be disabled in radio programming.

4.2.4.2 Transmitting Acknowledged Individual Calls

The radio may also initiate an acknowledged individual call. This type of call may not be supported by other radios. To initiate an acknowledged individual call, press INDEX then scroll to the desired unit ID. While the unit ID is displayed, press the  (pound) key.

The radio will send up to four individual call requests. If the receiving radio accepts the call, the initiating radio will enter individual call mode.

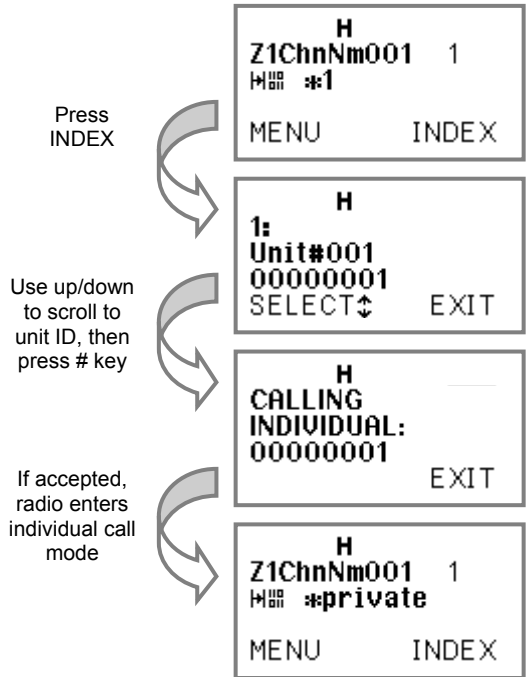

Figure 4.37 – Transmitting acknowledged individual call





Individual call initiation may be disabled in radio programming.

4.2.5 Transmitting Digital Unaddressed Calls

A digital unaddressed call is similar to a group call, except no talk group is specified (reserved talk group \$FFFF is used). Any digital radio with matching receive frequency and NAC should receive the unaddressed call.

To enter unaddressed call mode,

repeatedly press the  (star) key until "ENTER TO UNADDRESSED VOICE CALL?" is displayed, then press the left soft key (YES). The radio will now transmit with reserved talk group \$FFFF. To exit unaddressed call

mode, repeatedly press the  (star) key until "EXIT UNADDRESSED VOICE CALL?" is displayed then press the left soft key (YES).



Unaddressed call initiation may be disabled in radio programming.

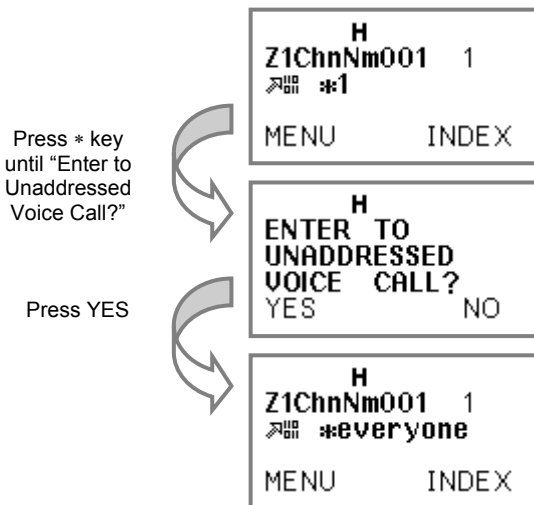

Figure 4.38 – Entering unaddressed call mode

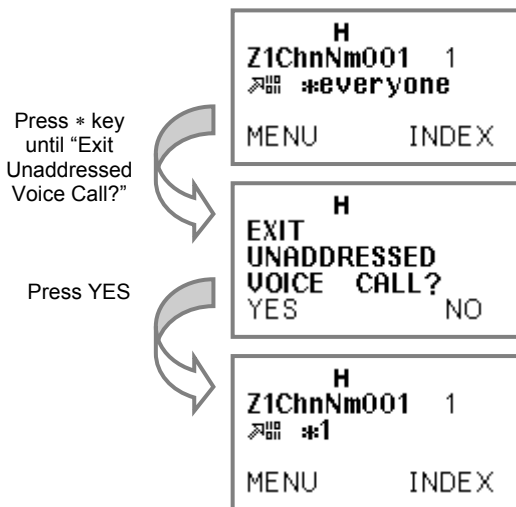



Figure 4.39 – Exiting unaddressed call mode

4.2.6 Transmitting Digital Telephone Interconnect Calls

Repeatedly press the

 (pound) key until "TELEPHONE:" is displayed. Enter the telephone dialing digits then press the left soft key (CALL). The radio will send up to four telephone interconnect requests. If the telephone interconnect request is successful, the radio will enter telephone call mode.

Press # key until "Telephone:" is displayed

Enter dial digits then press CALL



Figure 4.40 – Initiating telephone interconnect request



Telephone interconnect calls may be disabled or the number of dial digits may be limited in radio programming.

4.2.7 Receiving a Digital Call Alert

A call alert is normally used as a low priority request to return the call when it's more convenient. When a call alert is received the radio will display the unit ID of the initiator.

4.2.8 Transmitting a Digital Call Alert

Repeatedly press the  (pound) key until "CALL ALERT:" is displayed. Enter the destination ID or press the left soft key for INDEX. Press the left soft key (SEND) to send the call alert. The radio will send up to four call alert requests.



Call alert transmissions may be disabled in radio programming.



Figure 4.41 – Receiving a call alert

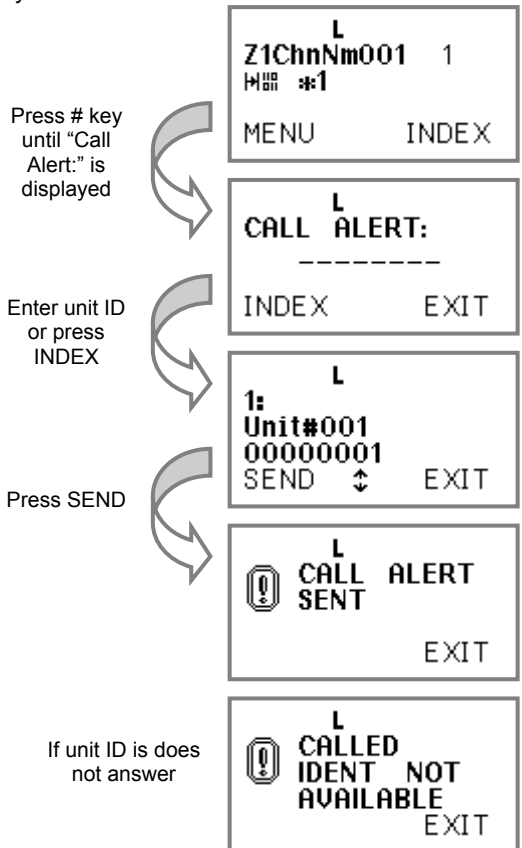

Figure 4.42 – Initiating a call alert request

4.2.9 Receiving and Sending Non-voice Messages

The radio can receive and send three types of non-voice messages when operating in digital mode. SMS messages are free text messages sent from one radio to another. With SMS messages, the message (up to 160 characters maximum) is entered using the alpha-numeric keypad and transmitted to the other radio. Predefined messages are common messages among all radios.

A predefined message is selected from the predefined message list (of 20 messages of maximum 20 characters) and the message pointer is transmitted to the other radio.

Status messages are common status settings among all radios. A current status is selected by the radio user (of 30 status settings of maximum 20 characters), and may be sent to another radio. Your current status may also be queried by another user.



Both status and predefined messages rely on the receiving radio's database to determine the message displayed. The message characters are not sent, instead only a pointer of which message should be displayed is sent. For proper status and predefined messaging operation, both the receiving and transmitting radios should be using the same message database.

4.2.9.1 Receiving SMS Messages

When an SMS message is received, the radio will display the SMS Message icon (✉). You may view the last twenty received SMS messages from MENU | SMS | RECEIVED MESSAGES.



Figure 4.43 – SMS message received



The ✉ icon indicates unread messages and will remain on until all new messages have been viewed. Within the Received Messages menu unread messages are preceded by a *.

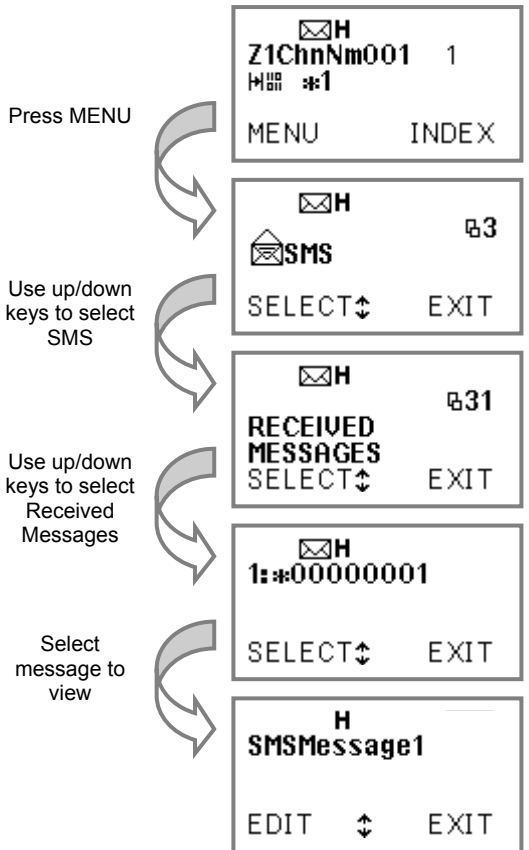

Figure 4.44 – Viewing received SMS message

4.2.9.2 Sending SMS Messages

SMS messages are sent from MENU | SMS | MSG EDIT. Use the alph-numeric keypad to enter the desired text, then enter the destination ID or select it from the index.



Sending SMS messages may be disabled by radio programming. When SMS is disabled, SENT MESSAGES and MSG EDIT will not appear on the SMS menu. The radio will still receive SMS and you can view received messages.

Press MENU

Use up/down keys to select SMS

Use up/down keys to select Msg Edit

Key in message and press OK

Enter destination ID or use INDEX then press SEND

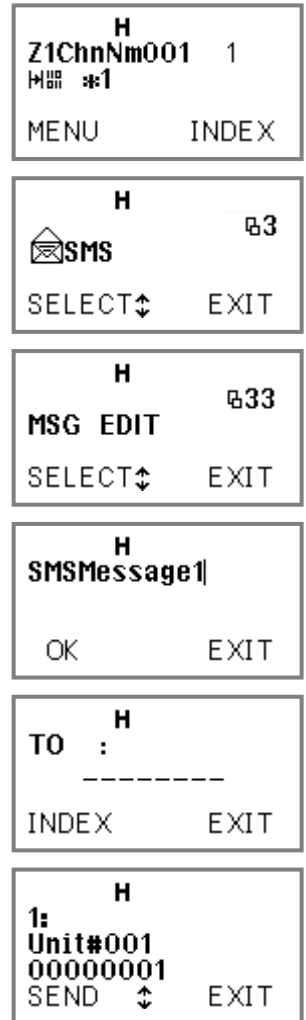

Figure 4.45 – Sending SMS message

4.2.9.3 Receiving Predefined Messages

When a predefined message is received, the corresponding text is pulled from the database and displayed along with the source ID. You may also view the last ten received predefined messages from MENU | PREDEFINED MESSAGES | RECEIVED MESSAGES.

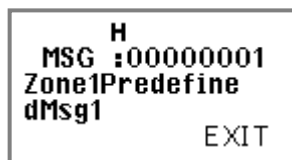

Figure 4.46 – Received predefined message

4.2.9.4 Sending Predefined Messages

Predefined messages are sent from MENU | PREDEFINED MESSAGES | MESSAGE LIST. Select the desired message from the list then enter the destination ID or select it from the index.



Sending predefined messages may be disabled in radio programming. When predefined messages are disabled, the message list may still be viewed, but predefined messages can't be sent.

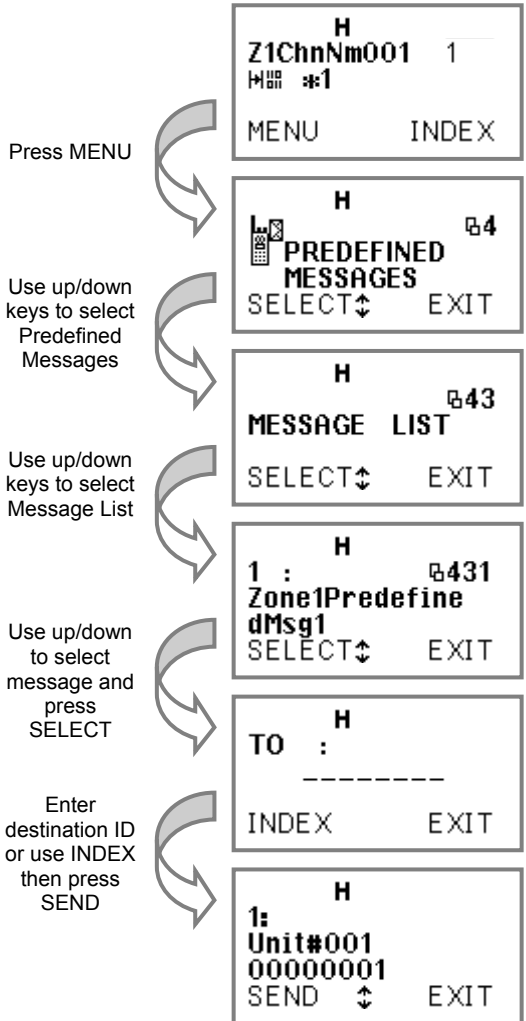



Figure 4.47 – Sending predefined message

4.2.9.5 Setting Current Status

The radio's current status may be set from MENU | STATUS | PRESENT STATUS or by pressing

the  (pound) key repeatedly until "CUR. STATUS:" is prompted.



When the radio is turned on, the present status will be reset to the first status option in the list.

4.2.9.6 Receiving Status

When a status message is received, the corresponding text is pulled from the database and displayed along with the source ID. You may also view the last ten received status messages from MENU | STATUS | RECEIVED STATUS.

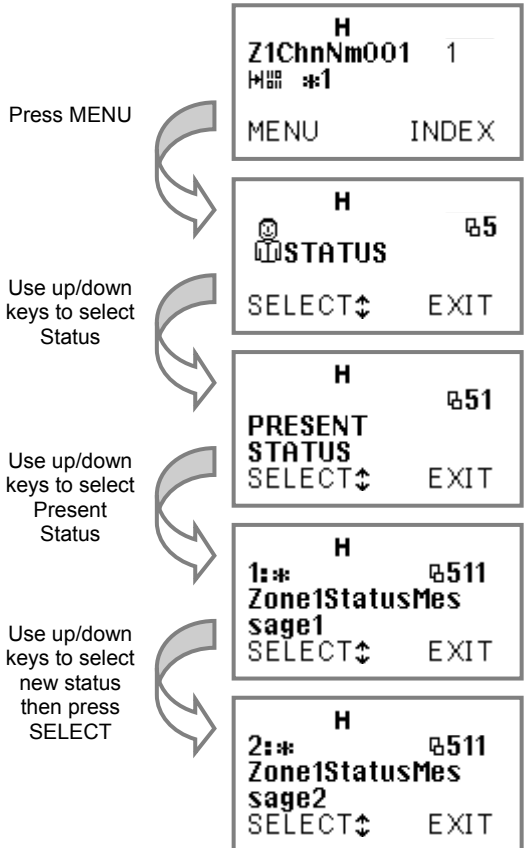

Figure 4.48 – Selecting current status

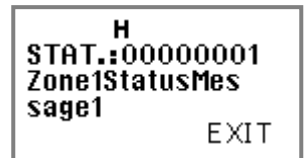

Figure 4.49 – Receiving status

4.2.9.7 Sending Status

Your current status may be sent from MENU | STATUS | SEND STATUS. Enter the destination ID or use the index to select it, then press SEND to transmit your current status.



Transmitting status may be disabled in radio programming. When status transmissions are disabled, SEND STATUS and STATUS REQUEST will not appear on the STATUS menu.

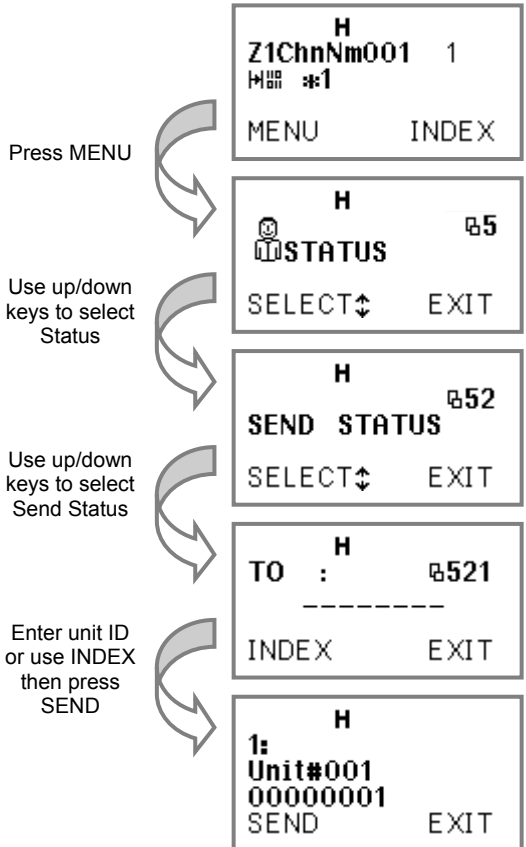

Figure 4.50 – Sending status

4.2.9.8 Requesting Status

You may request the current status of another radio from MENU | STATUS | STATUS REQUEST. Enter the destination ID or select it from the index, then press SEND to request another radio's status.



Transmitting status may be disabled in radio programming. When status transmissions are disabled, SEND STATUS and STATUS REQUEST will not appear on the STATUS menu.

Press MENU

Use up/down keys to select Status

Use up/down keys to select Status Request

Enter unit ID or use INDEX then press SEND

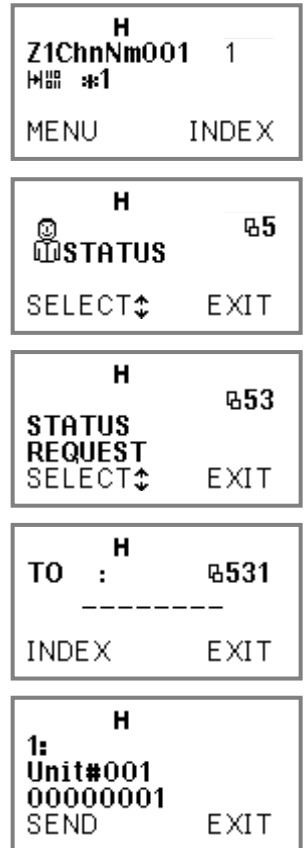

Figure 4.51 – Requesting status

4.2.10 Channel Programming

Front panel channel programming is an option offered to some customers. Radios must be purchased with channel programming capability or returned to the factory to have the capability added.

On channel programming capable radios, the channel parameters may be edited or created from the radio's alpha-numeric keypad. Channel programming may be chosen from MENU | CHANNEL PARAMETERS | CHANNELS. Enter the channel edit password then press OK. Choose the appropriate channel then press SELECT. Then change the appropriate parameters.

The channel programming access password is set in radio programming. This password is independent of the power-on password.



Channel programming may be disabled in radio programming. When channel programming is disabled, CHANNEL will not appear on the CHANNEL PARAMETERS menu.

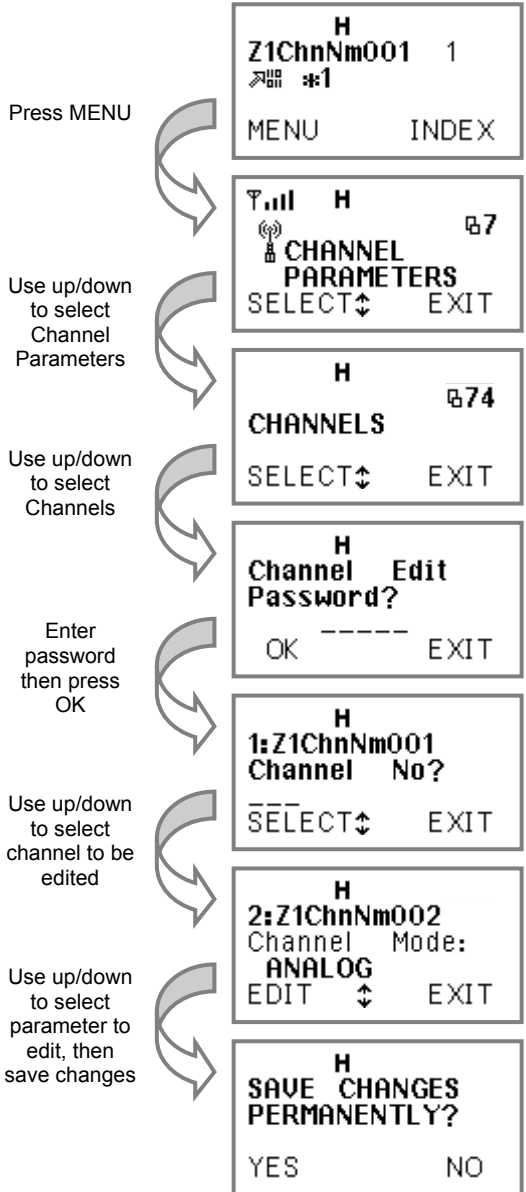
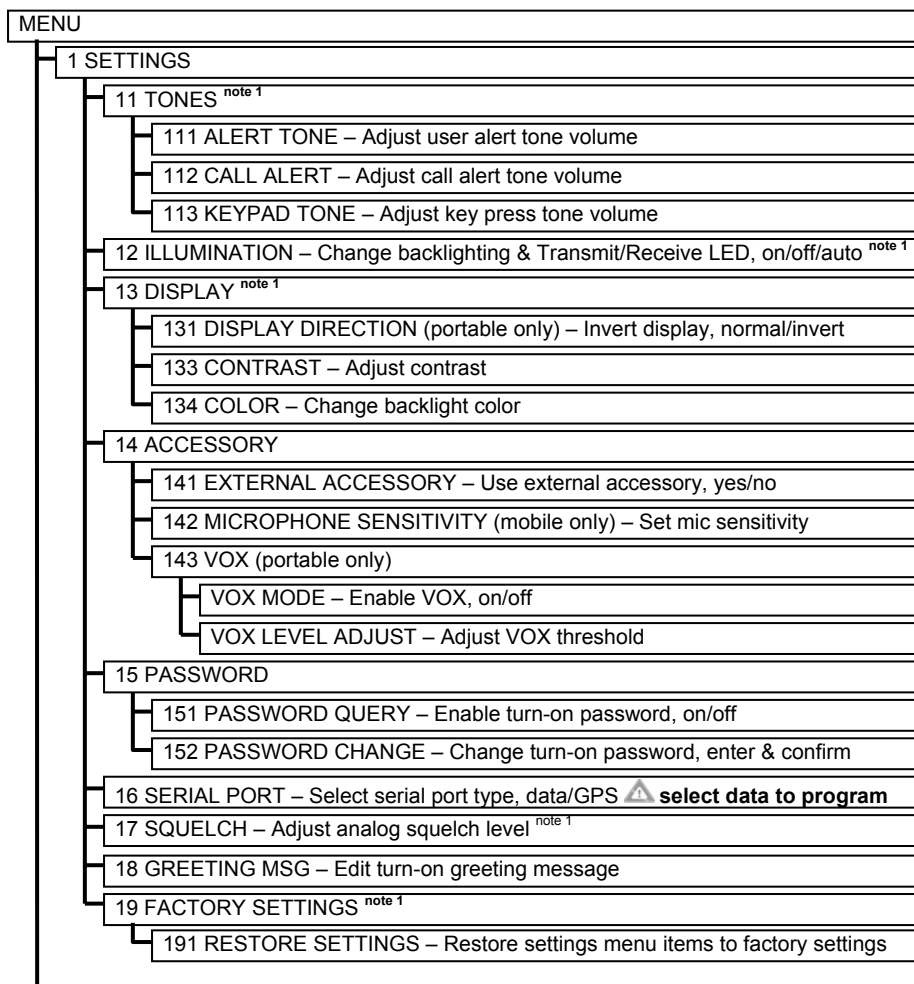

Figure 4.52 – Channel programming

4.3 Menu Operation

The menu function is used to access many features in the radio and also provides information about each radio. The features available from the menu depend on the analog/digital mode selection and the radio programming. The following menu trees depict the available menu selections, but some may not be accessible on your radio because of radio programming. The numbers shown may be used as keypad shortcuts to the menu option.

4.3.1 Analog Mode Menu Tree



6 RADIO INFO
61 IDENTS
SERIAL NO – View radio serial number
ANI, SC, ACK – View analog IDs
IDENT – View digital unit ID
RADIO NAME
TERMINAL IP-ID – View IP address
SYSTEM NO – View system ID
WACN – View wide area communication network ID
62 SOFTWARE
VERSION – View microcontroller flash version
DSP VERSION – View DSP flash version
63 HARDWARE
UNIT, RF CARD, FRONT – View PCB assembly versions
DSP, ENCRYPT, BAND – View PCB assembly & encryption versions & band
64 BATTERY INFO (portable only) (for OEM rechargeable batteries)
CHARGE, COUNT – View remaining battery capacity & charge cycle count
VOLT, CURR, TEMP – View battery voltage, current & temperature
TYPE – View battery type
65 MEASUREMENT
651 RSSI – Measure receive signal strength
652 GPS – View present GPS data
653 POWER SUPPLY – Measure supply voltage
7 CHANNEL PARAMETERS
71 CHANNEL SCAN – View & edit current zone's scan list
72 GROUPS – View & select new talk group from list
73 GROUP SCAN – Enable talk group scan (receive any talk group in list), on/off
74 CHANNELS – View & edit channel programming ^{note 6}
75 ZONES – View & select zone
76 CLONER – Clone channel parameters to another radio

4.3.2 Digital Mode Menu Tree

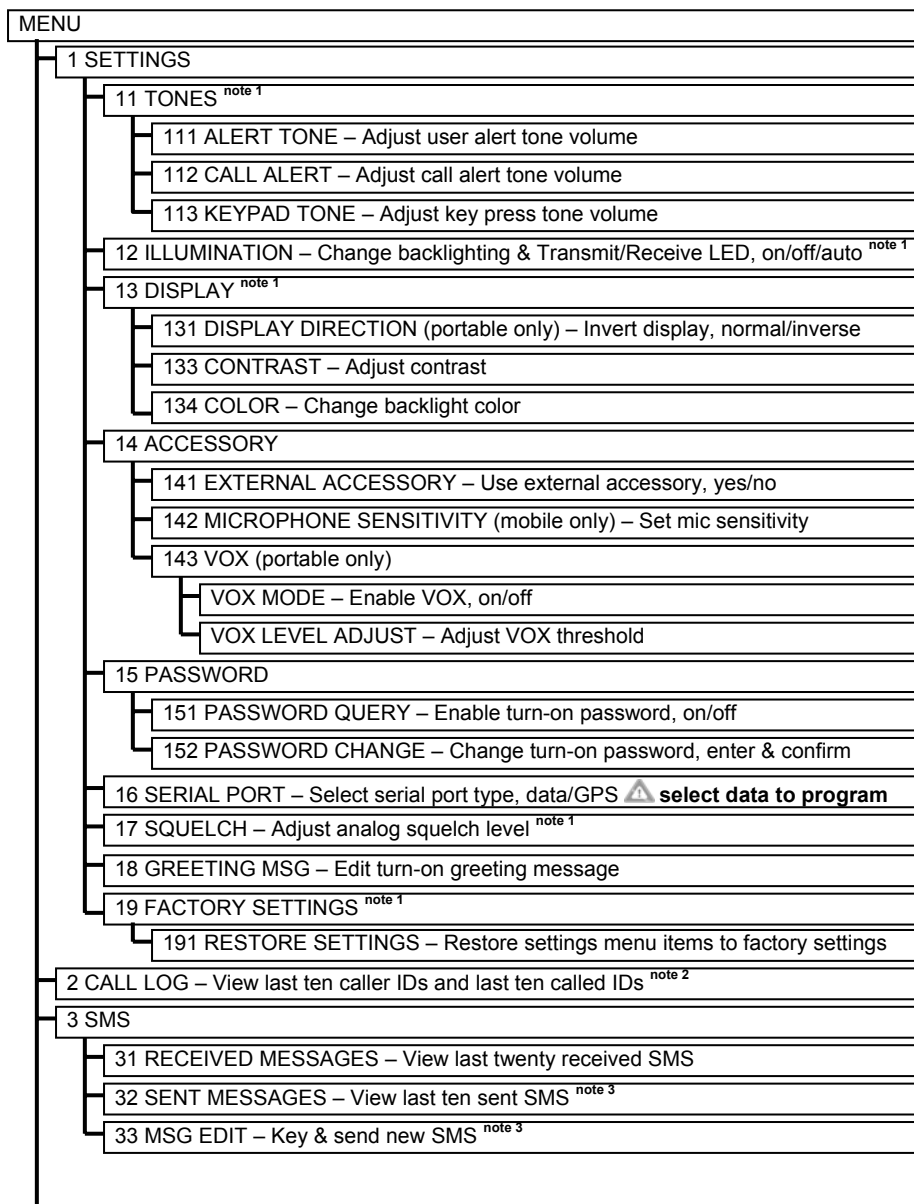

4	PREDEFINED MESSAGES
41	RECEIVED MESSAGES – View last ten received messages
42	SENT MESSAGES – View last ten sent messages ^{note 4}
43	MESSAGE LIST – View and send predefined message ^{note 4}
5	STATUS
51	PRESENT STATUS – View and set present status
52	SEND STATUS – Send present status to another radio ^{note 5}
53	STATUS REQUEST – Request another radio's present status ^{note 5}
54	RECEIVED STATUS – View last ten received status messages
6	RADIO INFO
61	IDENTS
	SERIAL NO – View electronic serial number
	ANI, SC, ACK – View analog IDs
	IDENT – View digital unit ID
	RADIO NAME
	TERMINAL IP-ID – View IP address
	SYSTEM NO – View system ID
	WACN – View wide area communication network ID
62	SOFTWARE
	VERSION – View microcontroller flash version
	DSP VERSION – View DSP flash version
63	HARDWARE
	UNIT, RF CARD, FRONT – View PCB assembly versions
	DSP, ENCRYPT, BAND – View PCB assembly & encryption versions & band
64	BATTERY INFO (portable only) (for OEM rechargeable batteries)
	CHARGE, COUNT – View remaining battery capacity & charge cycle count
	VOLT, CURR, TEMP – View batter voltage, current and temperature
	TYPE – View battery type
65	MEASUREMENT
	651 RSSI – Measure receive signal strength
	652 GPS – View present GPS data
	653 POWER SUPPLY – Measure supply voltage

7 CHANNEL PARAMETERS	
71	CHANNEL SCAN – View & edit current zone’s scan list
72	GROUPS – View& select new talk group from list
73	GROUP SCAN – Enable talk group scan (recieve any talk group in list), on/off
74	CHANNELS – View & edit channel programming ^{note 6}
75	ZONES – View & select zone
76	CLONER – Clone channel parameters to another radio
8 ENCRYPTION ^{note 7}	
81	ALGORITHM – View and select available encryption types
82	ENCRYPTION INFO – View encryption information, Algorithm ID and Key ID

note 1 These selections are unavailable when the *Settings* option is disabled in radio programming.

note 2 This selection is unavailable when the *Call Log* option is disabled in radio programming.

note 3 These selections are unavailable when the *SMS* option is disabled in radio programming.

note 4 These selections are limited or unavailable when the *Predefined Messages* option is disabled in radio programming.

note 5 These selections are unavailable when the *Status* option is disabled in radio programming.

note 6 This selection is unavailable when the *Channel Programming* option is disabled in radio programming.

note 7 This selection is only available when encryption option is purchased.

5 ACCESSORIES

Original Midland accessories give you operational efficiency, flexibility and reliability in difficult working conditions.

ACCESSORY	MIDLAND P/N
Microphone	ACC4425
Loudspeaker	ACC1425
Under dash mounting kit	560-090-0091
Trunk mounting kit	
Power cable assembly	90-0042
Programming software	
Programming cable	ACC2600
Cloning kit	ACC2305
Test and alignment adaptor	ACC2205

6 STORAGE AND CLEANING PRECAUTIONS



Keep the radio clean and away from dust, humidity, dense sunlight, extreme heat sources and liquids.



Avoid exposing the radio and accessories to cleaning solvents, aerosol sprays, adhesive agents, paints etc. Chemical reactions with such agents will destroy seals, case, display and finish.



If the radio is exposed to dirt, wipe with a soft and moist cloth at least once a week to prevent build-up of dirt and dust deposits.



Your radio does not require any periodic maintenance.

7 TROUBLESHOOTING

PROBLEM	POSSIBLE CAUSE(s)	SOLUTION(s)
No display on LCD when radio is turned on.	Fuse is blown or connections are insecure.	Check fuse and connections.
No sound from Loudspeaker	Volume level is too low. or Squelch level is too high. or Radio is set for external accessory.	Adjust volume level. or Adjust squelch level. or Turn off external acc. or Check speaker connections
No response to key press.	Key lock is on.	Unlock the keypad.
No answer to calls.	Out of range of other stations or signal is blocked by terrain.	Switch to H (High) output power. or Move closer until you have a "line-of-sight" to the other station.
Radio to PC connection fails.	Serial port is set for GPS receiver.	Change serial port selection to "DATA".

8 SPECIFICATIONS

GENERAL SPECIFICATIONS	
Modulation	16K0F3E, 11K0F3E , 8K0D1E, 8K0F1E
Data Rate	P25 : 9.6 kb/s
Symbol Rate	P25 : 4.8 kb/s
Protocol	Project 25-CAI : 4.4 kb/s IMBE
Encryption Algorithms	DES-OFB, AES
Channel Capacity	999
Operating Voltage Range	13.6 Vdc \pm % 20 (10.88-16.32 Vdc)
Standby Current Drain (backlight off)	\leq 0.4 A
RX Current Drain	\leq 1.5
TX Current Drain	\leq 8.5 A
Display	64x128 pixel LCD
Keypad	20 key, back lit
Dimensions (HxWxL) (projections not included)	1.8x6.5x6.5 in (46x165x165 mm)
Weight	1.50 kg

ENVIROMENTAL SPECIFICATIONS	
Operating Temperature Range	-30°C / +60°C
Storage Temperature Range	-40°C / +85°C
Humidity	% 95, 50°C
ESD	IEC 801- 2KV
Water and Dust Protection	IP65, MIL-STD

MILITARY STANDARDS 810C/D/E/F								
	MIL-STD 810C		MIL-STD 810D		MIL-STD 810E		MIL-STD 810F	
	Method	Proc./ Cat.	Method	Proc./ Cat.	Method	Proc./ Cat.	Method	Proc./ Cat.
Low Pressure	500.1	I	500.2	II	500.3	II	500.4	II
High Temperature	501.1	I, II	501.2	I/A1, II/A1	501.3	I/A1, II/A1	501.4	I/Hot, II/Hot
Low Temperature	502.1	I	502.2	I/C1, II/C2	502.3	I/C1, II/C2	502.4	I/C1, II/C2
Temperature Shock	503.1	–	503.2	I/A1-C2	503.3	I/A1-C2	503.4	I/Hot-C2
Solar Radiation	505.1	II	505.2	I	505.3	I	505.4	I
Rain	506.1	I, II	506.2	I, II	506.3	I, II	506.4	I, III
Humidity	507.1	II	507.2	II	507.3	II	507.4	–
Salt Fog	509.1	–	509.2	–	509.3	–	509.4	–
Sand and Dust	510.1	I	510.2	I, II	510.3	I, II	510.4	I, II
Vibration	514.2	VIII/F, XI/H	514.3	I/10, II/3	514.4	I/10, II/3	514.5	I/24, II/5
Shock	516.2	I, II, V	516.3	I, V, VI	516.4	I, V, VI	516.5	I, V, VI

8.1 Receiver Technical Specifications

RECEIVER SPECIFICATIONS		
	VHF	UHF
Frequency Range	136-174 MHz	380-470 MHz
Frequency Separation	Full Bandsplit	Full Bandsplit
Channel Spacing	12.5 / 20 / 25 / 30 kHz	12.5 / 20 / 25 / 30 kHz
Frequency Step	2.5 / 3.125 kHz	2.5 / 3.125 kHz
Rated Audio Output Power *	7.5 W / 8 Ω	7.5 W / 8 Ω
Frequency Stability * (-30°C / +60°C; 25°C ref)	± 2.5 ppm	± 1.5 ppm
Analog Sensitivity * 12 dB SINAD	≤ -119 dBm	≤ -118 dBm
Digital Sensitivity ** 5% BER	≤ -120 dBm	≤ -119 dBm
1% BER	≤ -117 dBm	≤ -116 dBm
Adjacent Channel Rejection Analog 25 kHz channel *	≥ 75 dB	≥ 75 dB
Analog 12.5 kHz channel *	≥ 63 dB	≥ 63 dB
Digital 12.5 kHz channel **	≥ 63 dB	≥ 63 dB
Intermodulation Rejection *	≥ 75 dB	≥ 75 dB
Spurious Response Rejection*	≥ 85 dB	≥ 85 dB
Hum and Noise Ratio Analog 25 kHz channel *	≥ 48 dB	≥ 42 dB
Analog 12.5 kHz channel *	≥ 42 dB	≥ 36 dB
Digital 12.5 kHz channel **	≥ 50 dB	≥ 50 dB
Audio Distortion *	≤ 3 %	≤ 3 %

* Measured in the analog mode per EIA-603 under nominal conditions.

** Measured in the digital mode per TIA-102.CAAA under nominal conditions.

8.2 Transmitter Technical Specifications

TRANSMITTER SPECIFICATIONS		
	VHF	UHF
Frequency Range	136-174 MHz	380-470 MHz
Frequency Separation	Full Bandsplit	Full Bandsplit
Channel Spacing	12.5 / 20 / 25 / 30 kHz	12.5 / 20 / 25 / 30 kHz
Frequency Step	2.5 / 3.125 kHz	2.5 / 3.125 kHz
Rated RF Output Power *	5-50 W	5-40 W
Frequency Stability * (-30°C / +60°C; 25°C ref)	± 2.5 ppm	± 1.5 ppm
Modulation Limiting *		
Analog 25 kHz channel	± 5.0 kHz	± 5.0 kHz
Analog 12.5 kHz channel	± 2.5 kHz	± 2.5 kHz
C4FM Modulation Fidelity **		
RMS Error	≤ 2 %	≤ 2 %
C4FM Deviation	1800 ±100 Hz	1800 ±100 Hz
Spurious Emissions * (Conducted and Radiated)	≤ -70 dBc	≤ -70 dBc
Audio Frequency Response * (6 dB/Octave Pre-emphasis from 300 to 3000 Hz)	+1, -3 dB	+1, -3 dB
Hum and Noise Ratio		
Analog 25 kHz channel *	≥ 52 dB	≥ 46 dB
Analog 12.5 kHz channel *	≥ 46 dB	≥ 40 dB
Audio Distortion *	≤ 1 %	≤ 1 %

* Measured in the analog mode per EIA-603 under nominal conditions.

** Measured in the digital mode per TIA-102.CAAA under nominal conditions.

9 WARRANTY STATEMENT

Midland Radio Corporation (herein, Midland) warrants each new radio product manufactured or supplied by it to be free from defects in material and workmanship under normal use and service for a period listed below, provided that the user has complied with the requirements stated herein.

The Warranty period begins on the date of purchase from an Authorized Midland Sales and Service Outlet. This Warranty is offered to the original end user and is not assignable or transferable. Midland is not responsible for any ancillary equipment attached to or used in conjunction with Midland products.

Midland offers to the original end user a Two (2) Year Limited Warranty on Midland Business and Industrial radio products. Accessories carry a One (1) Year Limited Warranty.

During this period, if the product fails to function under normal use because of manufacturing defect(s) or workmanship, it should be returned to the Authorized Midland Sales and Service Outlet from which it was purchased. The Sales and Service Outlet will repair the product or return the product for repair to Midland or its Authorized Repair Depot. The user is responsible for the payment of any charges or expenses incurred for the removal of the defective product from the vehicle or other site of its use; for the transportation of the product to the Sales and Service Outlet; for the return of the repaired / replacement product to the site of its use and for the reinstallation of the product.

Midland shall have no obligation to make repairs or to cause replacement required, which results from normal wear and tear or is necessitated in whole or in part by catastrophe, fault or negligence of the user, improper or unauthorized alterations or repairs to the Product, incorrect wiring, use of the Product in a manner for which it was not designed or by causes external to the Product. This Warranty is void if the product serial number is altered, defaced or removed.

Midland's sole obligation hereunder shall be to replace or repair the Product covered in this Warranty. Replacement, at Midland's option, may include a similar or higher-featured product. Repair may include the replacement of parts or boards with functionally equivalent reconditioned or new parts or boards. Replaced parts, accessories, batteries or boards are warranted for the balance of the original time period. All replaced parts, accessories, batteries or boards become the property of Midland.

THE EXPRESS WARRANTIES CONTAINED HEREIN ARE IN LIEU OF ALL OTHER WARRANTIES, EITHER EXPRESSED OR IMPLIED OR STATUTORY, INCLUDING, WITHOUT LIMITATION, ANY WARRANTY OF MERCHANTABILITY OR FITNESS FOR A PARTICULAR PURPOSE.

FOR ANY PRODUCT WHICH DOES NOT COMPLY WITH THE WARRANTY SPECIFIED, THE SOLE REMEDY WILL BE REPAIR OR REPLACEMENT. IN NO EVENT WILL MIDLAND BE LIABLE TO THE BUYER OR ITS CUSTOMERS FOR ANY DAMAGES, INCLUDING ANY SPECIAL, INCIDENTAL, INDIRECT OR CONSEQUENTIAL DAMAGES, OR FOR THE LOSS OF PROFIT, REVENUE OR DATA ARISING OUT OF THE USE OF OR THE INABILITY TO USE THE PRODUCT.

This warranty is void for sales and deliveries outside of the U. S. A. and Canada.



5900 Parretta Drive
Kansas City, MO. 64120
<http://www.Midlandradio.com>