

**maxon®**

MX-1111









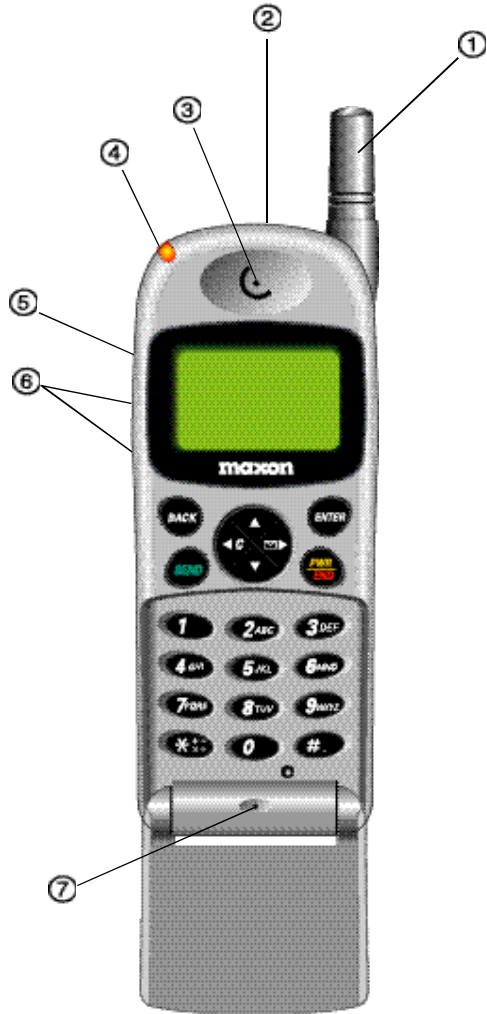

800Mhz Cellular  
Dual Mode

- *automatic digital/analog network mode*
- *199 name and number memory*
- *56 X 105 full graphic display*
- *easy to use feature menu*
- *supports voice mail alert and calling number identification*
- *call timers*
- *one - touch dialing*
- *scratch pad*
- *in call budget timer*
- *call list and missed call indicator*
- *own number display*
- *SMS ( short message service ) support*
- *DTMF tones*
- *dimensions 115 X 45 X 17.8mm*
- *flip type design*









# Contents



(Flip not shown for clarity)

- ① Antenna.
- ② Buzzer for ringing signal.
- ③ Ear piee.
- ④ Visual Alert indicator.
- ⑤ Hands free jack.
- ⑥ Volume adjustment.
- ⑦ Micropone
-  Go back to previous menu or Clear entry or exit a feature.
-  Select menu or set current feature and exit.
-  Dial a displayed number.
-  Power On/Off plus End a call and exit feature menu.
-  Clear entry or Go back to previous menu or Exit a feature.
-  Select menu or access Mails.
-  Scroll up or Upward search.
-  Scroll down or Downward search.

Display Icon's:

-  Digital mode indicator.
-  Analog Mode indicator.
-  Service available.
-  No service.
-  Battery power level.
-  Signal strength indicator.
-  Mail indicator.
-  Roam indicator.
-  Alarm mode indicator.

Introduction	1
Security	2
Safety	3
The Networks	4
Getting Started	5
Making Calls	6
Customizing	7
The Feature Menu	8
The Phone Book	9
The Data/Fax Services	10
Network Features	11
Troubleshooting	12
Glossary	13
Accessories	14
Index	15

# Introduction

Congratulations on choosing the Maxon MX-1111 dual Mode Cellular mobile phone.

The MX-1111 Phone has been designed to operate on both the digital CDMA Cellular network and the analog AMPS network.

To help you understand the features of the MX-1111 and how it operates on a cellular networks, we have included a glossary of common terms in Section 13 of this guide and have provided information about the cellular networks on pages 4.1 and 5.7.

Your mobile phone is intended for use with the supplied rechargeable battery, charger and any of the approved accessories shown in section 14 of this user guide. Usage of devices and accessories not approved for this unit may invalidate any approval given to this equipment and may be dangerous.

The MX-1111 conforms to IS-95A, IS-96A and IS-98 A standards for cellular dual mode mobile phones.

Maxon reserves the right to make changes and improvements to any of the products described in this guide without prior notice.

# Security

If your phone is lost or stolen, you must report it to your network operator or service provider so that they can restrict the phone from use.

This is important, as you may be liable for the cost of unauthorized calls until the equipment is restricted.

You can help prevent mobile phone crime by taking the following precautions:

- set the phone in lock mode.
- set call restrictions.
- don't leave your phone visible in a vehicle when you leave it. Take the phone with you or lock it in the trunk or glove compartment of your car.

# Safety

## Personal

- Operation of any radio equipment including mobile phones, may interfere with the function of inadequately shielded medical devices such as hearing aids and pacemakers. You must consult the manufacturer of these device or your physician, before use
- Do not switch on your mobile phone in hospitals (unless areas where mobiles can be used are clearly marked) as mobile phone can cause interference to medical equipment.
- Observe restrictions on the use of radio equipment in fuel depots, chemical plants, in areas where explosive gases are present or where blasting operations are in progress. Your mobile phone will continue to transmit call responses if left in stand-by mode. You must switch off when requested to do so
- Do not move the antenna close to, or touching any exposed part of the body when making a call, a damaged antenna may cause a minor burn

## Mobile Phone Use

- Your mobile phone produces magnetic fields. Do not place next to magnetic storage media such as computer diskettes, credit cards.
- Operating your mobile phone close to other electrical equipment such as televisions, phones, radios and personal computers, may cause interference
- Do not expose your mobile phone to strong sunlight, direct heat or liquids (such as water)

## Battery Use

- Do not short-circuit the battery terminals. This will damage the battery, produce heat and may cause a fire
- Never dispose of batteries in a fire as it can cause them to explode. Return dead batteries to your supplier or an approved recycling centre. DO NOT dispose along with household waste

**WARNING:** *If the battery case breaks, avoid contact with the contents. Wash contaminated skin with lots of water and seek medical attention.*

## On the Road

- Before making or receiving calls acquaint yourself thoroughly with the applicable local laws and guidelines regarding the use of mobile radio telephones and observe them at all times
- Air safety bags, anti-lock brakes, speed control and fuel injection systems are normally immune to radio transmissions but if you experience problems, consult your vehicle dealer.
- Switch off your mobile phone when refueling or where there are signs restricting the use of 2-way radio equipment. Do not store or carry flammable or explosive materials in the same compartment as your mobile phone, internal sparks could cause ignition.

## Inside Aircraft

- Switch off your mobile phone when in an aircraft. The use of mobile phones in an aircraft may be dangerous to the operation of the aircraft, disrupt the cellular network and is illegal.

# Getting Started

*Read this section before attempting to use your phone. It tells you how to attach, charge and care for the phone's battery. We have also included information about the wake-up and stand-by screen displays, how to turn the phone ON and OFF, and what to do if you are having difficulty in connecting to a network.*

<b>The Battery</b>	<b>5.1</b>
Fully Charge The Battery	5.1
Attaching and Removing the Battery	5.1
Charging the Battery	5.1
Battery Performance	5.3
Battery Power Level	5.3
Usable Time for Battery	5.3
<b>Switching ON and OFF</b>	<b>5.4</b>
Switching ON	5.4
Wake-up Screen	5.4
Stand-by Screen	5.5
Switching OFF	5.6
<b>Network Connection</b>	<b>5.7</b>

# The Networks

Your phone can operate on two different cellular systems(networks) and will automatically switch between the two to provide you with the best service.

## The Analog AMPS Network

■ This is the original cellular system for mobile phones which provides excellent call quality in areas of good coverage. However, at peak times and in high user areas, the network can become 'overloaded' and you may have to wait before you can get a 'line' to make a call. Dropped calls can also be a problem in hilly terrains and where there are a number of large structures.

## The Digital CDMA Network

■ CDMA is a new system that takes advantage of digital technology to provide superior management of the available radio spectrum. Unlike analog and other digital systems, CDMA assigns a unique code to each call then spreads it across a wide segment of the cellular band, enabling a large numbers of calls to be transmitted at the same time. You are therefore more likely to make a successful call first time, there is less interference and all your conversations are encrypted to prevent 'eavesdropping' CDMA also offers advanced features such as:

- text messaging
- digital paging
- Caller number identifications
- Low power transmission significantly increasing talk and stand-by times
- soft hand-off

# The Battery

5

5.1

## Fully Charge The Battery

Failure to do this will affect the life of the battery and reduced operating times between recharges. Best battery performance will be achieved after fully charging and discharging the battery two or three times.

## Attaching and Removing the Battery

- To remove battery, switch the phone OFF, press the release catch in ① and slide battery downwards ②.
- To fit place battery as shown ③ and slide upwards until the battery clicks into position.

## Charging the Battery

- Connecting the TRC(Traveler Charger) plug in to charger jack of phone.
- While the phone is under charging mode, the red LED light on the TRC will be on.
- Battery charging time takes approximately 1-3hours depending on battery size and type .

Charge times as follows:

- |                             |            |
|-----------------------------|------------|
| - Slim Li-Ion (MBL0600)     | : 1 hour.  |
| - Standard NiMH (MBN0600)   | : 1 hour.  |
| - Standard Li-Ion (MBL0930) | : 2 hours. |
| - Extended Li-Ion (MBL1450) | : 3 hours. |

**WARNING:** Charge the battery in a well-ventilated area between 0°C and +45°C using the supplied or approved charger. The use of a non approved chargers could result in a fire or injury through an electrical shock.

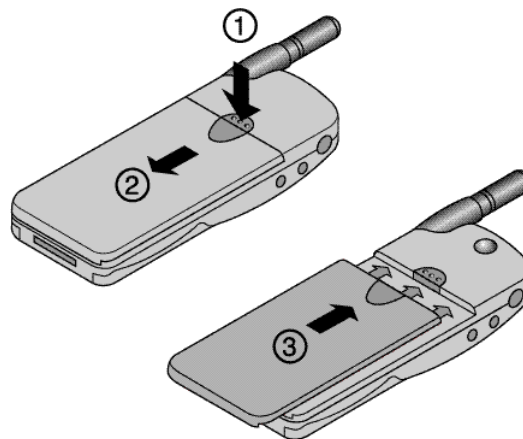

5

5.2

# Switching ON and OFF

When the phone is switched ON, the phone will wake-up and a stand-by screen will be displayed. Following pages explain the displayed message and symbols.

## Switching ON

- hold  until the back light lamps come on also you'll hear a beep if the key beep volume setting is active).

## Wake-up Screen

- after power-up, the wake-up screen appears briefly and will last about a seconds.



- ① **Banner** - you can change the top line message using the "Banner" menu feature. Refer to Customizing for instructions
- ② **Network Name** - an abbreviation of your current network operator.
- ③ **Mobile telephone number including area code.**

## Battery Performance

Any quoted stand-by or talk times are subject to network conditions.

## Battery Power Level

The battery power level is shown in the top right corner of the display when you switch the phone ON. Four levels are displayed from full (all black) to empty.



■ fully charged



■ fully discharged

## Usable Time for Battery

Conditions Types	Continuous Talk Time	Continuous Stand-by Time
MBL0600 (Slim Li-Ion)	Approx. 1.5 hours.	Approx. 50 hours
MBN0600 (STD. NiMH)	Approx. 1.5 hours.	Approx. 50 hours
MBL0930 (STD. Li-Ion)	Approx. 2.5 hours	Approx. 80 hours
MBL1450(EXT.Li-Ion)	Approx. 3.5 hours	Approx. 130 hours

(Talk time and stand-by times are based on use of digital mode and slot cycle index 2 without voice activity).

- Above times are talk only and stand-by times in normal use the time shall be lower because a large amount of battery power shall be consumed by initiating and receiving calls between standby.
- Times may vary, depending on the system condition set by base station.
- Usable time of battery may vary, depending on usage circumstances such as charge conditions, temperature, user's habit or the location's radio wave conditions.
- Usable time of battery shall decrease over time as they aged.





## Switching OFF

- press and hold  button until the screen clears (approximately 1.5 seconds)
- the phone must be switched OFF before removing the battery

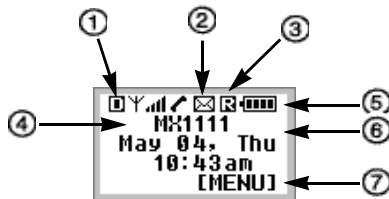
## Stand-by Display

- when the stand-by display appears the phone is ready to make and receive call subject to network coverage (see below). It also provides a starting point to enter the feature menu and phone book



- 1 Network Indicator** - if  icon appears, you are connected to the CDMA digital network. If  icon appears, you are connected to the AMPS analog network.
- 2 Mail Indicator** -  icon appears if there is a voice/text/email message that needs to be checked by the owner of the phone.
- 3 Roaming Indicator** -  icon appears and blinks if the phone is operating on an out-of-home area (Roaming area). Additional charges may apply.
- 4 Banner** - this is a same message that appears on the wake-up screen
- 5 Battery Power Level** - battery level indicator.
- 6 Date and Time display** - appears when the phone connects to the CDMA network and remains displayed until power is switched OFF, even if the phone switches to the AMPS network.
- 7 Menu key indicator** - the button right under this icon  " will act as the MENU button.



# Calls

*After setting up the phone and understanding the stand-by screen, you'll want to make and receive calls. This section gives you all the basic information you will need.*

# Network Connection





The MX-1111 Phone is initially programmed to search for the digital CDMA network each time it is switched ON. If you are in an area of poor CDMA coverage, it will automatically search for the analog AMPS network to enable you to continue to making and receive calls.

While the phone is connected to the AMPS network, the phone periodically searches for CDMA coverage and will switch networks as soon as there is sufficient CDMA signal strength.









In areas of known good coverage, you can lock the phone to either network (CDMA or AMPS), overriding the automatic feature, although this is not recommended.

If you are having difficulties in making or receiving calls, it could be caused by the phone locking on to a network with poor coverage in your present location.

- to check for the Automatic network connect mode setting;

 [menu] +  [setup] +  [system]  
+  [force call]

- to change settings

 [menu] +  [setup] +  [system]  
+  [force call] +  /  [choose one]  
+  [select and exit] or  [select without exit]

<b>Making Calls</b>	<b>6.1</b>
Manual Calls	6.1
Last Number Redial	6.1
Auto Redial	6.1
Call List	6.2
Set Call	6.2
Privacy Mode	6.3

<b>Emergency Calls</b>	<b>6.3</b>
------------------------	------------

<b>Answering Calls</b>	<b>6.4</b>
Auto Answering	6.4
Missed Calls	6.4

<b>In Call Features</b>	<b>6.5</b>
Ear Piece Volume	6.5
Send Own Number	6.5
Scratch Pad	6.5
Microphone Mute	6.6
Storage of Phone Number	6.6
Call Hold	6.6
Call Waiting	6.6



# Making Calls

Before making a call, **FULLY EXTEND THE ANTENNA** then check the stand-by screen for signal strength. If the Antenna Icon not appear in the top left corner of the display, you cannot make or receive calls.

Call quality can be affected by physical obstructions, so moving only a few metres (or a foot) may significantly improve signal strength.

## Manual Calls

- if the country you are operating in uses area codes, they must be included even when making local calls.
- Hyphens are automatically inserted (refer to section 7.5) to make the number easier to read and conform to telephone number patterns used in some countries.



Use  or  keys to clear an error.

**AREA CODE (if used) + Telephone number + **

 Icon appears during dialing and the call time is displayed on LCD screen.







- to hang up at the end of the call, press 

## Last Number Redial

- press  to recall the last number dialed, if correct,
- press  again to dial the number.

## Auto Redial





- the phone can be set to make up to 5 redial attempts of an engaged (busy) number at a specified time delay between each retry. A tone sounds at each redial and when the call is connected.

 [menu] +  [set up] +  [auto redial]  
+  /  [choose one] +  [select and exit]  
or  [select without exit]

**There are choices from “OFF” to 60 seconds.**

- to stop re-dialing at any time, press 

## Call List



- calls made and received from scratch pad numbers are stored in a list with the last entered number appearing at the first. Old numbers are automatically deleted when the list is full (10 entries).
- to recall the list, view number details and make a call using the number that displayed on the LCD screen;
  -  button to get in to call list retrieve mode
  - + continue to depress  or  to explore desired numbers that you looking for
  - and depress  [view] for view it's contents or depress  for make a call
- each number is identified by its type when viewed

**CALLED BY** - Incoming call number if available (refer to section 10 for details)

**CALLED TO** - Outgoing dialed number

**ADDED** - number entered during a call. (refer to scratch pad page 6.6)

**MISSED** - Missed (unanswered) incoming call if number available (refer to section 11.2 for details)

- to dial a displayed number on the list press 
- to copy a displayed number into the phone book press  [save]

*Please refer to section 9 for instructions on how to dial numbers stored in the phone book.*

## Answering Calls

- when an incoming call is received the phone rings, visual alert LED flashes, “Incoming Call” appears on the display and vibrator (if fitted and enabled) intermittently turns on.
- to answer the call, fully extend the antenna for best performance then open the Flip to answer.
- during the ring tone, the caller’s number and name may be displayed if supported by the network (refer section 11.2 for details)
- to hang up at the end of the call, press or close to Flip

### Auto Call Answering

- you can set the phone to automatically answer to incoming calls after a specified numbers of rings.

[menu] + [setup] + [AutoAnswer]  
+ [choose one] + [select and exit]  
or [select without exit]

**There are choices from “OFF” to 1.3.5 rings**

**WARNING:** *If you use this feature when the ringer is switched off (set to “silent”) you may receive a call without your knowledge.*

### Missed Calls

- missed (unanswered) incoming calls are entered onto the Call List if the caller’s number is available. The phone also displays the message ‘Missed (number) Call’ and the time of the last missed call if connected to the CDMA network
- to clear the message on screen, press or

## Privacy Mode

- if supported by your service provider, this feature will further encrypt calls made on the CDMA network(when ‘Enhanced’ is selected)

[menu] + [security]

**\*Phone will ask for LOCK CODE.**

press + + + or

the **four digit lock code** if you programmed into the phone.

that you programmed on to the phone.

press [privacy] + [choose setting]

+ [select and exit] or [select without exit]

## Emergency Calls

- your national emergency services numbers are stored in a special memory in the phone to enable the calls to be made even when the phone is locked or the restrict feature is set.
- ignore any phone locked or restricted messages and dial as normal. The call should be successful if you are within network coverage and there is sufficient signal strength

**Dial Emergency Number and press send button.**

For example if the Emergency number is 911;

+ + +

# In Call Features



During a call, you have following options;

## Ear piece Volume





- to adjust the ear piece volume, press the buttons on a side of the phone or  /  on the keypad

## Send Own Telephone Number.

- call own number automatically.

 [menu] + 

## Scratch Pad

- if you press any button from 0 ~ 9, \*, # while your phone is in conversation mode, the number will stay on display screen even after the call has ended unless another key is pressed.
- scratch pad numbers are automatically entered on the Call list and are identified by the word 'ADDED'. Also refer to page 6.2 to view the Call list
  -  button to get in to call list retrieve mode
  - + continue to depress  or  to explore desired numbers that you looking for
  - and depress  [view] for view it's contents or depress  for make a call
- also you can save the number after you select [view].

## Send My Number

- you can send your phone number including area code while you are in conversation mode.

 [menu] +  [Send My Number] +  [send]

## Storage of Phone No.

- you can store up to 199 scratch pad messages and telephone numbers in menu memory while you are in conversation mode.

 [menu] +  [Scratch Pad]

+ Enter Numbers up to 32 digits +  [save]

## Microphone Mute

- you can switch the phone's microphone off (mute voice) during a call to enable a private 'out of call' conversation.

 [menu] +  [mute MIC]

(the LCD screen will display "MIC MUTE")

- to cancel the Microphone Mute,

 [menu] +  [Unmute MIC]



## Call Hold

- if the feature is supported by the network, your phone gives you the facility to put the current call on hold, make a seconds call then switch between the two.

 [first call hold]

+ Dial a telephone number you wish to reach]

+  [make a call for dialed number]

- to switch between the two calls, press 
- to end both calls press  . If one caller ends their call from their end, you will be automatically connected to the other call.

## Call Waiting

- if the feature is supported by the network, you will hear a soft ringing tone in the ear piece when a second caller is trying to contact you. You can put the current call on hold, answer the new call then switch between the two by press  each time.

# Customizing

*This section shows you how to customize your phone for your own use.*

<b>Customizing</b>	<b>7.1</b>
Ringer Volume	7.1
Ringer Mode	7.1
Ringer Type	7.1
Key Beep Volume	7.1
Ear Piece Volume	7.2
Minute Alert	7.2
Service Area Alert	7.2
Roam Alert	7.2
SMS/E-mail Alert	7.3
Call Start Alert	7.3
Call End Alert	7.3
DTMF Beep Length	7.3
Display Contrast	7.3
Back light	7.4
Menu Type	7.4
Auto Hyphen	7.4
Banner	7.4
Show Time	7.5
Language	7.5
Security	7.5

# Customizing

## Ringer Volume

- you can change the volume of the ringer volume or switch it off, by choosing the silent or vibration option.

**-When the phone is in Standby Mode:**

/ for adjust ringer volume.

Silent < > Vibrator < > low < > med < > high < > max.

**-Using feature menu:**

[menu] + [sound] + [volume]

+ [ringer] + / [volume up/down]

Silent < > Vibrator < > low < > med < > high < > max.

## Ringer Mode

- you can change the ringer mode to one of the following;

**Bell / Vibrator / LED Lamp / Vibrator & Bell**

[menu] + [sound] + [Ring Mode]

+ / [choose one] + [select and exit]

or [select without exit]

## Ringer Type

- you can change the type of incoming call alert to one of 20 different Ringer sounds and musical incoming call alerts.

[menu] + [sound] + [Ring Type]

+ / [choose one] + [select and exit]

or [select without exit]

## Key Beep Volume

- the volume of the keypad press tones can be changed or switched off (silent)

[menu] + [sound] + [volume]

+ [key beep] + / [volume up/down]

+ [select and exit] or [select without exit]

## Ear Piece Volume

- to adjust the ear piece volume level out of call,

[menu] + [sound] + [volume]

+ [key beep] + / [volume up/down]

+ [select and exit] or [select without exit]

**OR**

- you also can use the volume keys on the side of the handset during a call.

/ to for adjust ear piece volume

(in conversation mode only).

## Minute Alert

- to help budget your calls, the minute alert can be set to sound a tone 10 seconds before the end of each minute of conversation.

[menu] + [sound] + [alerts]

+ [minute] + / [on/off]

+ [select and exit] or [select without exit]

## Service Area Alert

- when this feature is switched on, the phone will sound two short tones when the phone moves into another service area or is connecting to a different cellular system(i.e. switch from CDMA service area to AMPS service area for instance)

[menu] + [sound] + [alerts]

+ [alert] + / [on/off]

+ [select and exit] or [select without exit]

## Roam Alert

- when this feature is switched on, the phone will sound two short tones when moving into, or out of, a roaming area

[menu] + [sound] + [alerts]

+ [Roam Alert] + / [on/off]

+ [select and exit] or [select without exit]

## SMS/E-mail Alert.

- when this feature is switched on, the phone will sound four short tones upon a reception of SMS text message or E-mail.

[ENTER] [menu] + [4] [sound] + [4] [alerts]  
 + [4] [SMS/Email] + [▲/▼] [on/off]  
 + [ENTER] [select and exit] or [ESC] [select without exit]

## Call Start Alert.

- when this feature is switched on, the phone will sound a call start tone.

[ENTER] [menu] + [4] [sound] + [4] [alerts]  
 + [5] [call start] + [▲/▼] [on/off]  
 + [ENTER] [select and exit] or [ESC] [select without exit]

## Call End Alert

- when this feature is switched on, the phone will sound a call end tone.

[ENTER] [menu] + [4] [sound] + [4] [alerts]  
 + [6] [call end] + [▲/▼] [on/off]  
 + [ENTER] [select and exit] or [ESC] [select without exit]

## DTMF Beep Length

- to change the DTMF beep length(normal or long),

[ENTER] [menu] + [4] [sound] + [5] [Beep Length]  
 + [▲/▼] [normal/long]  
 + [ENTER] [select and exit] or [ESC] [select without exit]

## Display Contrast

- to change the LCD screen contrast(dark or light),

[ENTER] [menu] + [7] [setup] + [4] [display]  
 + [1] [contrast] + [▲/▼] [darker/lighter]  
 + [ENTER] [select and exit] or [ESC] [select without exit]

## Back light

- to change the LCD back light control,

[ENTER] [menu] + [7] [setup] + [4] [display]  
 + [3] [back light] + [▲/▼] [choose one]  
 + [ENTER] [select and exit] or [ESC] [select without exit]  
 10s <> 30s <> on with flip open <> always on <> always off

## Menu Type

- you can choose the main menu screen display type("icon" ans "list")

[ENTER] [menu] + [7] [setup] + [4] [display]  
 + [2] [menu type] + [▲/▼] [icons/list]  
 + [ENTER] [select and exit] or [ESC] [select without exit]



Icon main menu

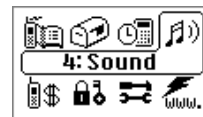

List main menu

## Auto Hyphen

- hyphens appear when you input a number onto the display. This makes long numbers easier to see and also conforms to telephone number patterns in some countries. The feature can be switched on and off.

[ENTER] [menu] + [7] [setup] + [4] [display]  
 + [4] [auto hyphen] + [▲/▼] [on/off]  
 + [ENTER] [select and exit] or [ESC] [select without exit]

## Banner

- you can enter your own top line wake-up and stand-by screen display message.

[ENTER] [menu] + [7] [setup] + [4] [display]  
 + [5] [banner] + [BACK] [edit] + **Enter Your Banner**  
 + [ENTER] [select and exit] or [ESC] [select without exit]

# The Feature Menu

*This section will help you to get to know the phone's feature menu and shows you how to use the basic operating features.*

## The Feature Menu 8.1

Menu Controls	8.1
Selecting a Feature by Number	8.2
Selecting a Feature by Navigation	8.2
Feature Menu Structure	8.3
Scheduler Function	8.7
View Calender	8.7
Calculator Function	8.7
Setting Alarm Funtion	8.7
World Time Function	8.7
International Country Code	8.8

## Call Info Menu 8.9

Last Call	8.9
Home Calls	8.9
Roam Calls	8.9
All Calls	8.9









## Security Menu 8.10

Lock Mode	8.10
Restrict	8.10
Send PIN	8.11
Change Code	8.11
Clear Call	8.11
Privacy	8.11
Emergency #	8.12

- refer to the "Phone Book" section for help with entering words.









## Show Time

- the time and date automatically appear on the display screen when your phone connects to the CDMA network. You can choose not to have this information displayed.

 [menu] +  [setup] +  [display]  
 +  [show time] +  /  [on/off]  
 +  [select and exit] or  [select without exit]

## Language

- you can change a language option between English/Portuguese/Spanish

 [menu] +  [setup] +  [display]  
 +  [language] +  /  [choose one]  
 +  [select and exit] or  [select without exit]

## Security

- your phone has several security features to prevent or restrict dialling. Please refer to section 8 for details.



# The Feature Menu

All the operating features of the MX-1111 is stored in the easy to use menu. A feature can be selected directly by it's feature number or you can work through the menu.

Press the number of the feature you want at each level or navigate using the four directional switch.



## Menu controls

[menu] -enter the feature menu, also serves as soft key (key function will be displayed on lower right corner of the LCD, mostly [ok], save and exit the feature menu)

-search though the groups, features and feature options

-move one step forward or select current setting without exiting from the feature menu

-go back one step or cancel

-same as above in menu screen but also acts as soft key (key function will be displayed on lower left corner of the LCD)

-exit the feature menu without saving



## Selecting a Feature by Number

- [menu] + **FEATURE NUMBER**
- + / [choose one]
- + [select and exit] or [select without exit] (example: increase ringer volume by one step)
- [menu] + [sound] + [volume]
- + [ringer] + [volume up]
- + [ok-select and exit-]

## Selecting a Feature by Navigation

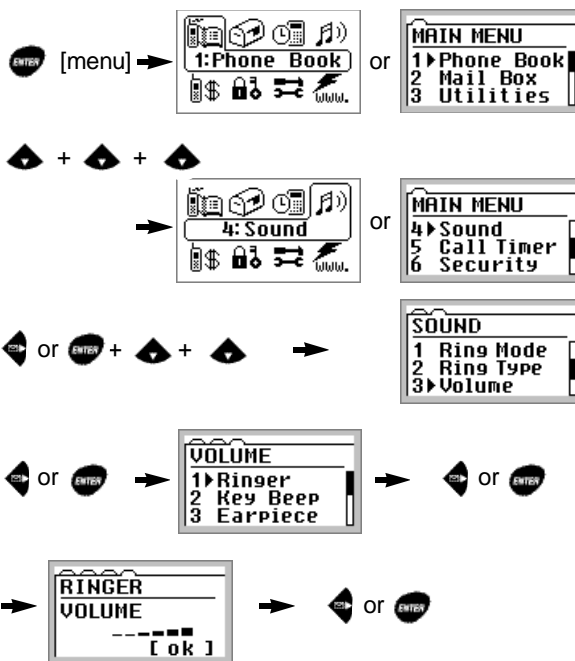

# Feature Menu Structure

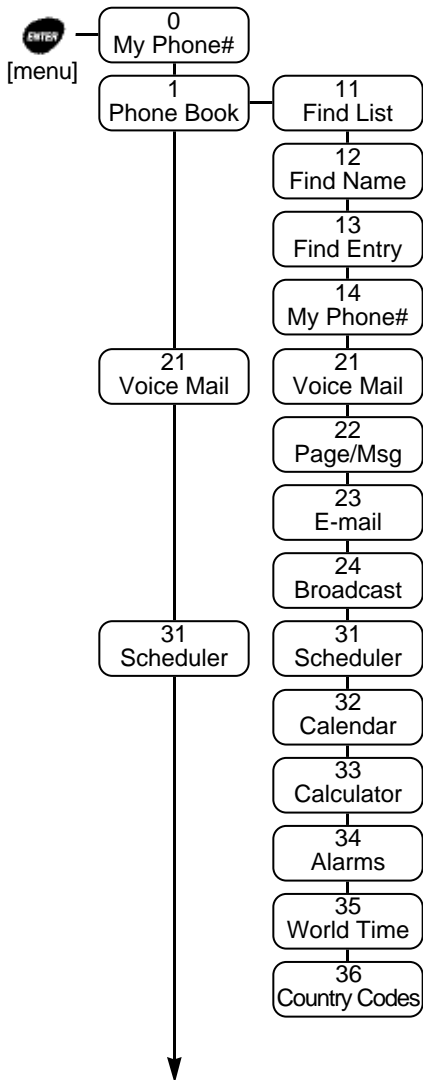

# Feature Menu Structure

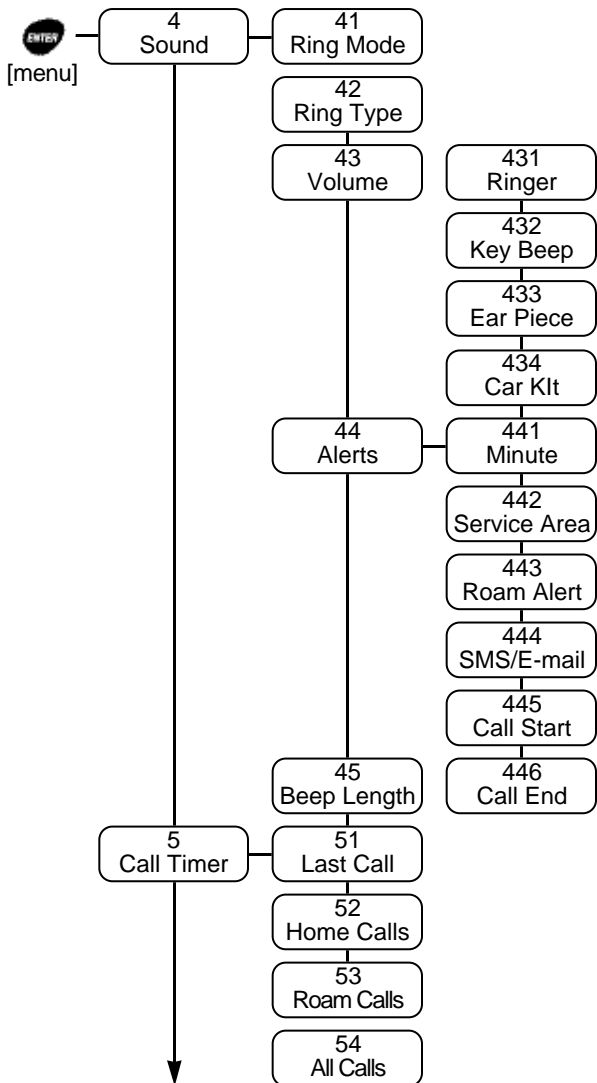

# Feature Menu Structure

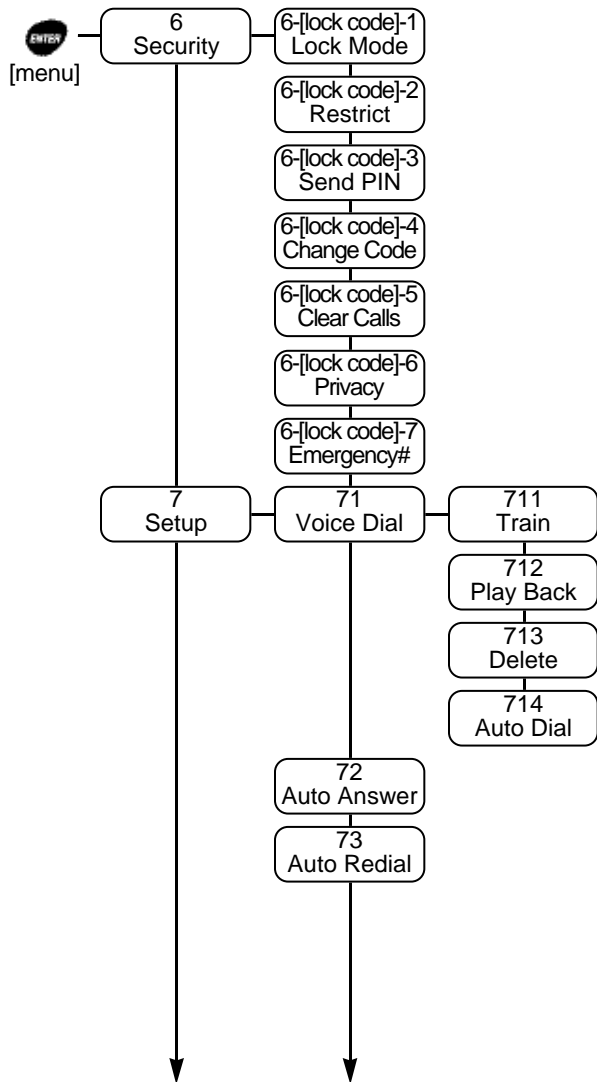

# Feature Menu Structure

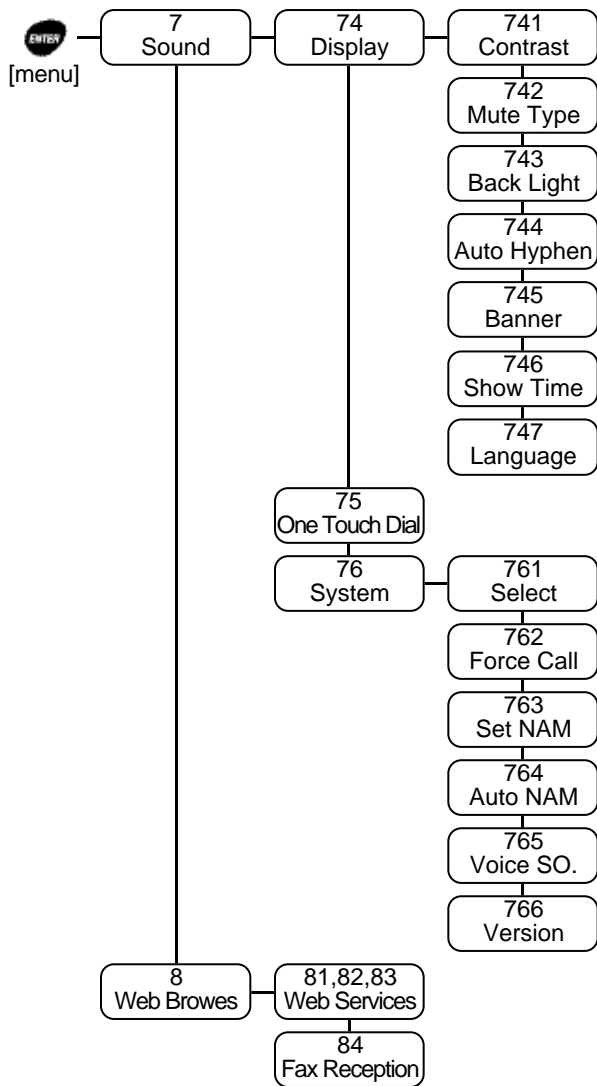

## Scheduler Function

- manage your future schedule
  - [menu] + [Utilities] + [scheduler]
  - + ENTER YOUR SCHEDULE and MARK ALARM
  - [ok]

## View Calendar

- [menu] + [Utilities] + [calendar]
- use / for previous and next months

## Calculator Function

- can do simple four rules of arithmetic up to 9 digits including a decimal point.

[menu] + [Utilities] + [calendar]

- input figures for calculation.

Example)  $8,500 \div 55 = 154.545454$

① enter 8500

② press button 4 times to select

③ enter 55

④ press [=] to get answer

- to terminate calculator function, press

## Setting Alarm Function

- after setting the alarm clock, the alarm will ring at the designated alarm time. The directions below illustrates the alarm time set procedure.

[menu] + [Utilities] + [Alarms]

+ Enter a Time for Alarm + [set]

## World Time Function

- This function is available for checking the time in 33 major cities around the world.

[menu] + [Utilities] + [world time]

use / for browse different cities.

## Country Codes for International Dialling

- The telephone shows country codes for 29 major countries around the world



[menu] + [utilities] + [country code]

use / for browse different country.

## Call Info Menu

### Last Call

- to display the duration of the last outgoing call in minutes and seconds

 [menu] +  [Call Timer] +  [last call]

### Home Calls

- the phone has a resettable timer which displays the total number of calls and the cumulative call time on the home network since the last reset

 [menu] +  [Call Timer] +  [home calls]

### Roam Calls

- the phone has a second resettable timer which will display the total number of calls and the cumulative total for calls made on a second (roam) network

 [menu] +  [Call Timer] +  [roam calls]

### All Calls

- to display the total number of calls and the total call time since the phone was registered on the network

 [menu] +  [Call Timer] +  [all calls]







## Security Menu

The security features of your phone are protected by a lock code which is initially set to 0000 or the last four digits of your phone number. To prevent other people using the security features, you should change the code to a four digit number of your choice.

*Emergency calls can still be made when the phone is locked or the restrict feature is set.*

### Lock Mode







- set the phone lock to prevent unauthorized calls. You can choose to lock the phone now (remains locked until the lock code is entered), at power up (locks each time the phone is switched on until the feature is cancelled) or never. When locked, the phone can only make emergency calls and calls to two other 'emergency' numbers of your choice (refer to Emergency feature)

 [menu] +  [security] + **Lock Code**  
+  [lock mode] +  /  [choose one]  
+  [select and exit] or  [select without exit]

- to unlock the phone, enter the lock code at the display prompt

### Restrict

- when set, this feature only allows calls to numbers stored in locations 1 to 9 in the phone book

 [menu] +  [security] + **Lock Code**  
+  [restrict] +  /  [choose no/yes]  
+  [select and exit] or  [select without exit]

## Send PIN

- as a security check, your operator or service provider may ask you to send the phone's PIN before allowing calls. Switching the 'Send PIN' prompt ON allows you to send the PIN at the right time by simply pressing key

[menu] + [security] + **Lock Code**  
 + [lock mode] + / [choose one]  
 + [select and exit] or [select without exit]

## Changing Code

- to change the lock code (4 digit number)

[menu] + [security] + **Lock Code**  
 + [change code] + New Lock Code  
 + [ok] + Re- Enter New Lock Code  
 + [select and exit] or [select without exit]

## Clear Call

- for security, you may wish to clear the call list(refer to page 6.2)

[menu] + [security] + **Lock Code**  
 + [clear calls]  
 + [select and exit] or [select without exit]

## Privacy

- if it is supported by the network, you can encrypt your voice even further by enabling this option.

[menu] + [security] + **Lock Code**  
 + [privacy] + / [choose one]  
 + [select and exit] or [select without exit]

## Emergency #

- the phone is pre-programmed with three emergency numbers for your country which can be changed by the end user.

- to change the emergency number

[menu] + [security] + **Lock Code**  
 + [emergency#] + / [choose one]  
 + [edit]  
 + or to erase existing number if necessary.  
**+Enter new Emergency #**  
 + [save and exit]



# The Phone Book

The MX-1111 has a large phone book memory. It can store 199 telephone numbers of up to 32 digits, each with a 16 character long name. Recalling of entries is by location number, by name, or by browsing through the phone book one by one

## Storing Information

- each keypad number is also used to enter several alpha characters (see below). For name entry, repeatedly press the key that shows the character that you want until it appears on display. Wait for the cursor to move before entering the next character
- the telephone number can include \* and #, and numbers can be used in the name
- when you need a space in a name, press once
- to change from upper (A) to lower (a) case characters press for **upper case** and press for **lower case** after you place cursor under a character that you wish to change the case by using [move cursor to right column] or [move cursor to left column]
- use for clearing errors, a short press for the last character clear and a press and hold to cancel entry and return to standby screen.

	1		PQRS	7
	1		pqrs	7
	ABC	2	TUV	8
	abc	2	tuv	8
	DEF	3	WXYZ	9
	def	3	wxyz	9
	GHI	4	0	0
	ghi	4	0	0
	JKL	5	Punct	*
	jkl	5	uation	*
	MNO	6	. - , / @	#
	mno	6	#	#

- if you need . - , / @, during name entry, press #
- if you need extended special characters(punctuation) during name entry, press \*

## Storing a Number and Name

- to store a telephone number  
**Telephone Number** + [save]  
**+ Enter Name** + [ok]
  - ➔ accept displayed location and save [ok]  
 Or enter own location[1-199]  
 Or find empty location using /
  - ➔ accept displayed secrete option and save [ok]  
 Or change secrete option using /
  - ➔ accept displayed secrete option and save [ok]

an acceptance message to confirm storage will briefly appear followed by the status of the memory then the phone returns to stand-byscreen

Press to cancel number and name storage at anytime before the last [ok] press.

## Help with Storing

- **name:** if you don't want to include a name, press save twice after entering the telephone number
- **overwrite protection:** if you choose a location which is already used, phone will display 'Overwrite?' and the exiting entry appears.  
 press [ok] to overwrite (store new entry) or  
 press [quit] or then enter a new location.
- **secret numbers:** if you make an entry 'secret' the telephone number won't be displayed when recalled, only the name appears. You can make a maximum of 10 secret entries.





## Recalling a Number and Name

there are 3 recall options

### ■ browse phone book one by one(easiest)

you can use this feature only when the phone is in standby screen.

press  to get in to the browse phone book mode and press  again to browse the next telephone numbers

### ■ recall by location number

if you know the memory location number, you can find the telephone number by entering the memory location number.



#### -use short key

press  to get in to browse phone book mode and enter location number to find the telephone number.

you also can use  /  to browse phone number if the memory location that you entered is empty.



OR

#### -use feature menu



press  [menu] +  [phone book]

+  [find entry]

then enter location number to find the telephone number that you wish to find.

you also can use  /  to browse phone number if the memory location that you entered is empty.

### ■ recall by name

press  [menu] +  [phone book]

+  [find name]

then enter first few characters of the name you wish to find.

the character count can be as small as one character.

Press  to exit recall at any time.

## Helps with Recalling

■ **name:** when you recalling by name, you only need to enter enough letters to identify the name.

for example; if you only have one entry with the initial letter 'J', just enter 'J' to look up John

■ **memory location:** when you are recalling phone numbers using memory location number, you must enter 0 in front of the location number 1-9.

for example: if you wish to recall a telephone number that is stored in memory location '2', you have to enter '02'

■ **options:** after recalling a telephone number, you have the choices to:

-edit, press  [edit]

-erase, press  [erase]

-end or exit, press  [end]

## To Edit

■ recall the entry, press  [edit] then follow the storage instructions (refer to page 9.2 Storing a Number and Name).

■ press  [end] at each option if you don't want to make changes.

## To Erase

■ recall the entry, press  [erase] +  [ok]

■ you have to enter the phone's lock code before you can erase a 'Secret' entry. If you don't know what the lock code is, refer to section 8.10

# The Data/Fax Services

There are mainly three types of data services available with MX-1111 phone.

## Mini Web Browser

- You can browse text versions of certain Web sites using the built-in phone.com mini browser if your system provider supports it.

 [menu] +  [web browse]  
+  /  for select one of following





1. Surf WEB
2. Surf Cache
3. Bookmarks

+  [select] or  [select] to start Web surfing.

## Receive Fax using your computer(note book)

- Connect the phone to your computer's serial port(usually DB-9, RS-232 port) using the data cable accessory (see section 14, Accessories for detail)
- You have to know when to expect an incoming fax.

If you know the next incoming call will be a fax,

 [menu] +  [web browse] +  [fax]  
+  /  for select one of following

1. 1 Fax Call
2. 10 Fax Calls
3. Fax Always

+  [select] or  [select] to start Web surfing

## To Add a Prefix

- when a number is recalled, you can add area code to the beginning of the telephone number if they are saved without proper area code but you are out of your home town.
- the prefix is temporary and does not add to the stored number.

**Recall the stored number + enter the area code +** 







## Speed Dialling

- if you know a stored location number of a telephone number you wish to dial,

**Enter Location Number (i.e. 12) +**

## One-Touch Dialling

- if you enable this feature, you can dial a stored number by simply entering the location number (press and hold the second digit until '  ' icon appears)
- to activate the feature

 [menu] +  [setup] +  [one-touch]  
+  /  [enable/disable] +  [ok]

## Web surfing, E-mail, and send Fax using your computer(note book)

- You can treat the MX-1111 phone like an external modem for these purposes.
- Hook up the phone with your computer's serial port (usually DB-9, RS-232 port) using the data cable accessory (see section 14, Accessories for detail)
- Make a data or fax call using your computer's dial-up network or Fax software.

# Network Features

*In addition to making and receiving calls, the digital CDMA network offers other advanced benefits detailed in this section. Some of the features may not be supported by your network operator or by a foreign network when roaming.*

<b>DTMF Signaling</b>	<b>11.1</b>
Constructing a Pause Dial Sequence	11.1
Normal and Long DTMF Tones	11.2
<b>Caller Identification Number</b>	<b>11.2</b>
<b>Text and Voice Mail Message in General</b>	<b>11.3</b>
Receiving Messages	11.3
Memory Capacity	11.3
<b>Text Messa</b>	<b>11.4</b>
Reading Messages	11.4
<b>Voice Mail Messages</b>	<b>11.5</b>
Reading Messages	11.5
Deleting Message	11.6
<b>System Selection</b>	<b>11.7</b>
Preferred Service Provide	11.7
Auto NAM	11.7
<b>Network Selection</b>	<b>11.8</b>
Preferred Mode	11.8

# DTMF Signaling

The 1-9, \*, and # keys on your phone generate a unique tone when pressed. These are known as DTMF tones and are used to operate advanced facilities such as home banking, voice mail and paging services. A series of numbers are normally required to operate the facility, for example; a contact number, security PIN and option code. You can construct a pause dial sequence on the display then send the numbers at once or automatically. A sequence can be up to 32 digits long (a pause counts as one digit) and can be stored in the phone book as a normal number.

## Constructing a Pause Dial Sequence

- each number in a sequence must be separated by one of the following:

**hard pause 'H'** - this stops dialling after the first number, you'll need to press  at the facility request to send each number in the sequence

**time pause 'T'** - the phone will insert a 2 second pause between dialling all the numbers in the sequence. This setting is particularly useful if you regularly dial the same facility since you won't need to hear the facility prompts

- you also have an option to insert hyphens in long numbers to make them easier to read. The hyphens are ignored during dialling so you still need to input pause commands if you need pause(s).
- to construct a sequence

Enter number(s) + 

+  [H] or  [T] or  [-]

+Continue to enter number(s)

Do not end the sequence with a pause





## Normal and Long DTMF Tones

- the phone can generate tones of different duration according to the needs of the facility

**normal** - a short burst tone of about one tenth of a second which is sufficient to operate most devices

**long** - a tone that lasts for as long as the key is pressed (use when you have trouble with **normal**)

- if you regularly use a paging service, we recommend that you leave the phone on the normal setting
- to change settings

 [menu] +  [sound] +  [Beep Length]  
+  [normal / long] +  [ok]

# Caller Identification Number

This feature enables you to see a caller's telephone number on the display during the ringing tone. You'll then have the option to answer or reject the call. The caller's name will also appear if the name and number are stored in the phone book.

Caller Identification Number only works when the caller is using a network supporting Caller ID service. They may also have asked the facility to withhold their number from being transmitted.

## Text Messages

Text messages are sent directly to your phone (subject to network support) and may contain a time stamp, a callback number and the name of the caller (if the callback number matches a phone number that is stored in the phone book).

### Reading Messages

- to read new text messages

Press + select Voice or Page/Msg using or then press or [ok] read message (also you can browse the message with / )

select [next] or [erase]

- upon select [next] or [erase] the phone will display saved message on the display.

browse them with / , press [view] or [erase] if needed.

- you always exit message menu by press anytime.
- if you want to call back to the message while you are reading a text message, press .

## Text and Voice Mail Messages in General

Your phone has an ability to receive short text messages when switched ON. The messages are automatically stored in the phone's memory and are retained even when the phone is switched OFF. While reading a message, you can dial any callback number by simply pressing .

The text and voice mail services are normally subject to a subscription charge, check with your service provider regarding the cost and availability.

### Receiving Messages

- when a new message is received, '**Message!**' appears in a middle of the display. You'll hear 5 short beeps and the message stays until cleared.
- if a message is marked '**Urgent**' by the sender, '**Message!**' will flash with an asterisk ( \* ) appearing on both sides of message header

### Memory Capacity

- your phone can store up to 20 messages, each containing on average of 80 characters.
- the phone will alert you when the amount of available message memory is low. You should erase older messages that are no longer needed to avoid running out of memory.

# Voice Mail Messages

If you have a voice mailbox, the service will send a message to your phone each time a new message is received. You must call your voice mail service to listen to these messages (airtime charges may apply).

## Reading Messages

- to read a new voice mail alert message  
Press + select Voice or Page/Msg using or then press or [ok]  
read message (also you can browse the message with / )
- at the end of the message, you have the choice of [calling] or [quit]
- you also can access your voice mail system by press and holding for 2 seconds if you are in standby mode (stand-by screen) and the display shows icon
- depending on the system setup, you may have to dial a specific number to access your voice mail such as (your own number +            +            )

*Voice mail message indicator shows you that you have a voice message. The actual voice message is at the service provider's message center (not in the phone). As the provider will periodically send a "voice mail" indication, the number of voice message indications does not necessarily correspond to the actual number of voice messages. This is because one voice mail indication may include more than one voice message.*

## Deleting Message

- to erase a new voice mail alert message

Press + select Voice or Page/Msg using   
or then press or [ok]  
+ [erase] + [yes]

*This will erase the voice message indication to the phone only. In order to erase the voice message stored on your service provider's message center you have to access the voice mail and follow their instructions.*

## Network Selection

Your phone is designed to operate on the Digital CDMA and analog AMPS networks. While connected to the preferred CDMA network, you can force the phone to stay on an analog AMPS network. This feature can be useful if you are operating in an area of low digital signal strength (ie you have difficulty in making calls or a call has been dropped) and you want to try the other network without changing the phone's settings permanently.

As an alternative to a forced call, you can change the preferred network mode if you have services from two different system providers.







### Preferred Mode (Forcing a call)

- the preferred mode is factory set to **Automatic**. You can change this to one of the other options listed below but this is not recommended as you may lose the advantages of the CDMA network and experience difficulty in making and receiving calls.

- The preferred operating mode options are:

Automatic (CDMA then Analog)  
 CDMA only  
 Analog only  
 Temp Analog

- to change the preferred mode







 [menu] +  [setup] +  [system]  
 +  [force call] +  [choose one]  
 +  [select and exit] or  [select without exit]

## System Selection

You may have the option to use your phone on two different cellular systems. If this is the case, you can specify which system and which service provider to use in a particular area or situation.







### Preferred Service Provider

- each service provider assigns a unique mobile number for your phone (this is known as the NAM). You can specify which mobile number (NAM) your phone will use

 [menu] +  [setup] +  [system]  
 +  [Set NAM] +  [choose NAM#1 or NAM#2] +  [ok]

### Auto NAM

- switching this feature ON will enable your phone to change service providers if the phone loses service in the current cellular areas

 [menu] +  [setup] +  [system]  
 +  [Autot NAM] +  [on/off] +  [ok]

# Glossary

- CDMA** - Code Division Multiple Access, preferred digital cellular system
- AMPS** - Advanced Mobile Phone System (an analog cellular system)
- NAM** - Number Assignment Module. The system identification for your mobile number. Some countries may allow you to have more than one mobile number, in which case they would be identified by NAM1, NAM2 etc
- HOME Network** - the service provider that issues your mobile number (NAM 1)
- ROAM Network** - a second service provider that offers service when you are away from the home home network
- SMS** - Short Message Service(also known as text message service)
- VMS** - Voice Mail Service

# Troubleshooting

## The Phone Will Not Switch ON

- the phone has shut down because the battery power level is too low to make calls. Fully recharge the battery

## Dialled Calls Are Not Processed

- the phone is locked, the restrict feature is set or you have not pressed the  key

## Display Messages

During use of your phone, the phone may display an error message as follows:

### 'FEATURE CURRENTLY UNAVAILABLE'

- you are attempting to select a feature that is only available during a call or the feature is not supported by your network operator/service provider or by the phone.

### 'ENTER THE LOCK CODE'

- the phone lock has been set, you must enter the four digit lock code before you can proceed with your call attempt (refer to page 8.10)



# Accessories

## Hands Free Car Kit

- provides for Hands Free operation of the MX-1111 phone in your vehicle.
- consist of a cradle, hands free system unit that plugs on to your cigarette lighter port.

## Quick Travel Charger

- charges an extended MBL-1450 Li-Ion battery to its full capacity in approximately 3 hours.
- extraordinarily light and compact battery charger.
- available with four different wall plugs.

## Cigarette Lighter Chargers

- suitable for 12 Volts operation.
- available in two different designs, suitable for a wide variety of automobiles.

## Spare Batteries

- MBL0600 : 600mAH Li-Ion slim battery
- MBN0600 : 600mAH Ni-MH standard battery
- MBL0930 : 930mAH Li-Ion standard battery
- MBL1450 : 1450mAH Li-Ion standard battery

### Usable Time for Batteries

Conditions Types	Continuous Talk Time	Continuous Stand-by Time
MBL0600 (Slim Li-Ion)	Approx. 1.5 hours.	Approx. 50 hours
MBN0600 (STD. NiMH)	Approx. 1.5 hours.	Approx. 50 hours
MBL0930 (STD. Li-Ion)	Approx. 2.5 hours	Approx. 80 hours
MBL1450(EXT.Li-Ion)	Approx. 3.5 hours	Approx. 130 hours

## Data Cable

- connects the phone to your computer serial port for data services (i.e. web surfing, PC Fax and etc.)

## Leather Carry Case

- elegant case which protects the phone from scratches, knocks, water stains etc
- built-in belt clip

# Index

<b>Accessories</b>	14.1	<b>Calculator</b>	8.7	<b>Network Connection</b>	5.7	<b>Show Time</b>	7.5
<b>Alerts</b>	7.2	<b>Calender</b>	8.7	<b>One-Touch Dialing</b>	9.5	<b>SMS</b>	13.1
- minute alert	7.2	<b>Caller Identification</b>	11.2			<b>Speed Dialing</b>	9.5
- service area alert	7.2	<b>Number</b>				<b>Stand-by Screen</b>	5.5
- Roam alert	7.2			<b>Phone book</b>	9	<b>Storage of Phone</b>	6.6
- SMS/E-mail	7.3	<b>Change Code</b>	8.11	<b>Preferred Mode</b>	11.8	<b>Number</b>	
- call start alert	7.3	<b>Clear Call</b>	8.11	<b>Restrict</b>	8.10	<b>Switching OFF</b>	5.6
- call end alert	7.3	<b>Customizing</b>	7	<b>Ringer</b>	7.1	<b>Switching ON</b>	5.4
<b>All Calls</b>	8.9			- Ringer Mode	7.1	<b>Text messages</b>	11.4
<b>Auto Answer</b>	6.4	<b>Display Contrast</b>	7.3	- Ringer Type	7.1	<b>To Add a Prefix</b>	9.5
<b>Auto Hyphen</b>	7.4			- Ringer	7.1	<b>To Edit</b>	9.4
<b>Auto NAM</b>	10.6	<b>DTMF Beep Length</b>	7.3	<b>Roam Calls</b>	8.9	<b>To Erase</b>	9.4
<b>Auto Redial</b>	6.1			<b>Scratch pad</b>	6.5	<b>VMS</b>	13.1
<b>Back Light</b>	7.4	<b>DTMF signaling</b>	11.1	<b>Scheduler</b>	8.7	<b>Voice Message</b>	11.5
<b>Banner</b>	7.4			<b>Security</b>	8.10	<b>Wake-up Screen</b>	5.4
<b>Battery</b>	5.1	<b>Ear Piece volume</b>	6.5	<b>Send Own Number</b>	6.5	<b>World Time</b>	8.7
- attaching	5.1			<b>Send PIN</b>	8.11		
- charging	5.1	<b>Emergency #</b>	8.12				
- performance	5.3	<b>Home Calls</b>	8.9				
- power level	5.3						
- removing	5.1	<b>International</b>	8.8				
<b>Calls</b>	6	<b>Country Code</b>					
- answering	6.4			<b>Key Beep Volume</b>	7.2		
- emergency	6.3	<b>Language</b>	7.5				
- call hold	6.6	<b>Last Call</b>	8.9				
- call waiting	6.6	<b>Lock Mode</b>	8.10				
- caller identification	11.2	<b>Lock Code</b>	8.11				
- call list	6.2	<b>Menu Type</b>	7.4				
- last number redial	6.1	<b>NAM</b>	13.1				
- manual calls	6.1						
- making calls	6.1						
- missed calls	6.4						
- privacy mode	6.3						
- re-dialing	6.1						
- call timer	8.9						

Maxon Electronics. Reserve the right to make changes and improvements to any products described in this guide without prior notice.

In the event of a product recall, the manufacturer will not be liable for any claims for loss, damage whether arising directly or indirectly. Your statutory rights are not affected.