

80-106
VHF Handheld Transceiver

80-406
UHF Handheld Transceiver

User's Manual



Note: Change ALAN logo to Midland logo or just leave logo area blank.

Copyright © 2004 by Midland Radio Corporation; all rights reserved.

PN: 80-106406

**FCC RF EXPOSURE COMPLIANCE REQUIREMENTS FOR
OCCUPATIONAL USE ONLY**

The Federal Communications Commission (FCC), within its action in General Docket 93-62, November 7, 1997, has adopted a safety standard for human exposure to Radio Frequency (RF) electromagnetic energy emitted by FCC regulated equipment. Midland Radio Corporation subscribes to the same safety standard for the use of its products. Proper operation of this radio will result in user exposure far below the Occupational Safety and Health Act (OSHA) and FCC limits.

DO NOT transmit for more than 50% of total use time (50% duty cycle). Transmitting more than 50% of the time can cause FCC RF exposure compliance requirements to be exceeded.

- This radio is NOT approved for use by the general population in an uncontrolled environment. This radio is restricted to occupational use, work related operations only where the radio operator must have the knowledge to control the user's exposure conditions for satisfying the higher exposure limit allowed for occupational use.
- When transmitting, hold the radio in a vertical position with its microphone 2 inches (5cm) away from your mouth.
- The radio is transmitting when the red LED on the front of the radio is illuminated. You can cause the radio to transmit by pressing the PTT bar on the radio.
- When using VOX mode the radios transmitter is automatically activated with your voice by speaking into the microphone. Use caution when using VOX mode.
- These are required operating configurations for meeting FCC RF exposure compliance. Failure to observe these restrictions means violation.

This device complies with Part 15 of the FCC Rules. Operation is subject to the condition that this device does not cause harmful interference.

In this book...

FCC RF EXPOSURE COMPLIANCE REQUIREMENTS FOR OCCUPATIONAL USE ONLY	2
INTRODUCTION.....	4
WARNING NOTES.....	4
SAFETY.....	4
FCC RF EXPOSURE COMPLIANCE REQUIREMENTS FOR OCCUPATIONAL USE ONLY	5
CONVENTIONS AND SYMBOLS IN THIS BOOK.....	6
PART NAMES AND THEIR FUNCTIONS.....	7
TOP	7
FRONT	7
SIDE (LEFT AND RIGHT)	8
SETUP	9
UNPACKING.....	9
ATTACHING/REMOVING THE ANTENNA.....	10
INSTALLING/REMOVING THE BATTERY PACK	10
INSTALLING/REMOVING THE BELT CLIP	11
CHARGING THE BATTERY PACK	11
BASIC OPERATIONS	12
SWITCHING THE RADIO ON/OFF	12
ADJUSTING VOLUME.....	12
CHANNEL SELECTION	12
RECEPTION	12
MONITOR	13
TRANSMISSION	13
TRANSMISSION POWER.....	14
6 CTCSS/DCS AND SELECTIVE CALL OPERATION.....	14
SCANNING CHANNELS	15
List scan.....	15
Priority Scan.....	15
ADVANCED OPERATIONS.....	16
HANDS-FREE TRANSMISSION (VOX).....	16
7.3 CONFIDENTIAL COMMUNICATIONS (SCRAMBLER).....	16
CARE AND MAINTENANCE	17
BATTERY PACKS	17
Information on rechargeable batteries.....	17
Proper charging of battery packs.....	17
Memory effect.....	17
Erasing memory effect.....	18
Warnings for battery and chargers use.....	18
RADIO MAINTENANCE	19
Cleaning battery packs.....	19
Cleaning the radio.....	19
Connectors.....	19
OPTIONAL ACCESSORIES.....	20
Microphone connector.....	20
QUICK REFERENCE.....	21
OPERATION RESUME.....	21
SERVICE:.....	23
LIMITED WARRANTY	24
INDEX	25

Introduction

Congratulations. The Midland 80-106/80-406 is a Professional Radio. Its rugged design allows it to be your reliable partner during hard working days.

The transceiver is designed to be easy to use, but is featured with advanced functions.

We state the most important ones:

- **Easy to use** – just only five commands to control all the transceiver's functions.
- **Channel scanning** – it allows to automatically search the radio signals on the programmed channels.
- **VOX (Voice operated transmit)** – it allows to enable the transmission by simply speaking, in full hands-free condition, by the optional headset/microphone.
- **CTCSS/DCS** – to share more radio networks on the same frequency and safely access to your radio repeaters.
- **Selective call** – for more advanced radio network management. You can individually call a user inside a network or make group calls.
- **Emergency selective call** – you can send it, when needed, with a simple command protected against accidental switching.
- **Analog scrambler** – for confidential communications. Radio communications are encoded and decoded from every 80-106 and 80-406 in order to reduce the risk of tapping from third parties who are watching your frequency.
- **Wide range of optional accessories** which allow to extend the flexibility of use.

Transceiver's specifications of 80-106 and 80-406 are compliant with FCC Part 90, moreover its top level design and weather resistance are compliant with MIL STD 810 F which supercedes MIL STD 810 C,D,E.

Midland Radio is committed to continuous quality improvements, for this reason specifications may vary without prior notice.

Warning notes

Every effort has been made to ensure that the information in this document is complete, accurate, and up-to-date. Midland assumes no responsibility for the results of errors beyond its control. The manufacturer of this equipment also cannot guarantee that changes in the equipment made by non authorized people will not affect the performance or functions in it.

Safety

Your 80-106/80-406 handheld transceiver has been carefully designed to give you years of safe, reliable performance. As with all electrical equipment, however, there are a few basic precautions you should take to avoid hurting yourself or damaging the radio:

- **Read the instructions** in this handbook carefully. Be sure to save it for future reference.
- **Read and follow** all warning and instruction labels on the radio itself.
- **Do not carry the transceiver by the antenna.** This may damage the antenna or antenna terminal. Grasp it by its base (not the tip!) when you need to attach or remove the antenna.
- **Do not hold the radio with the antenna very close** to, or touching exposed parts of the body, while transmitting. The radio will perform best if the microphone is 2-4 inches away from the mouth and the radio is vertical.
- **Be sure** the PTT key is not pressed when you do not need to transmit.
- **Do not** operate the radio near unshielded electrical blasting caps or in an explosive atmosphere.
- **Do not transmit without the antenna attached to the radio.** Though it is provided with a protection, it may damage the TX output final stage.

- **Respect the environment conditions.** The radio is designed to be used in heavy environments, however avoid exposing it to extremely hot or cold temperature (outside the range of -22 to $+156^{\circ}\text{F}$). Do not expose the transceiver to excessive vibrations as well as dusty or rainy conditions.
- **Never try to disassemble or service the radio by yourself** (aside from the routine maintenance described in this handbook). It will immediately void the warranty and you may cause damage requiring extensive repair work. Always contact your local dealer for assistance.
- **Grasp your radio firmly.** Otherwise it may fall and be damaged.
- **Use only genuine accessories.** Non original accessories could seriously damage your handheld transceiver.
- **Do not use your radio near water, or spill liquid of any kind into it.** If the transceivers get wet immediately dry it with a soft and clean cloth.
- **Switch the radio off before you clean it.** Strictly follow the directions reported in the paragraph "Care and maintenance".
- **Handle the battery properly.** Strictly follow the directions reported in "Care and maintenance".
- Ensure that your power source matches the rating listed for the supplied battery charger AC adapter.
- To avoid damaging the power cable of the battery charger, do not put anything on it or place it where it will be walked on.

FCC RF EXPOSURE COMPLIANCE REQUIREMENTS FOR OCCUPATIONAL USE ONLY

The Federal Communications Commission (FCC), within its action in General Docket 93-62, November 7, 1997, has adopted a safety standard for human exposure to Radio Frequency (RF) electromagnetic energy emitted by FCC regulated equipment. Midland Radio Corporation subscribes to the same safety standard for the use of its products. Proper operation of this radio will result in user exposure far below the Occupational Safety and Health Act (OSHA) and FCC limits.

DO NOT transmit for more than 50% of total use time (50% duty cycle). Transmitting more than 50% of the time can cause FCC RF exposure compliance requirements to be exceeded.

- This radio is NOT approved for use by the general population in an uncontrolled environment. This radio is restricted to occupational use, work related operations only where the radio operator must have the knowledge to control the user's exposure conditions for satisfying the higher exposure limit allowed for occupational use.
- When transmitting, hold the radio in a vertical position with its microphone 2 inches (5cm) away from your mouth.
- The radio is transmitting when the red LED on the front of the radio is illuminated. You can cause the radio to transmit by pressing the PTT bar on the radio.
- When using VOX mode the radios transmitter is automatically activated with your voice by speaking into the microphone. Use caution when using VOX mode.
- These are required operating configurations for meeting FCC RF exposure compliance. Failure to observe these restrictions means violation.

Conventions and Symbols in this Book

 This symbol marks a 'note'. Notes are hints or tips which offer additional information to help you.

 **This symbol marks a 'caution'. Cautions are special notices which you should read and follow carefully to avoid possible damage to your equipment and to avoid potential danger to yourself or other people.**

Key names will be highlighted in **bold**.

Important sentences and words are highlighted in *Italic*.

Part Names and their functions

The following parts description will familiarize you with the transceiver's main parts and controls. Numbers in brackets refer to the illustration.

Top

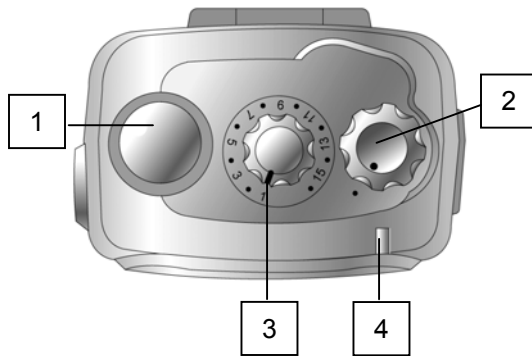

- [1] **Antenna connector.** Attach the antenna to this connector (MX thread type).
- [2] **Power ON/OFF knob.** Rotate this knob to turn the transceiver on and off.
- [3] **Channel selector knob.** Rotate this knob to select the operating channel.
- [4] **Status LED.** Glows in different colors to show the current radio's status.

Front

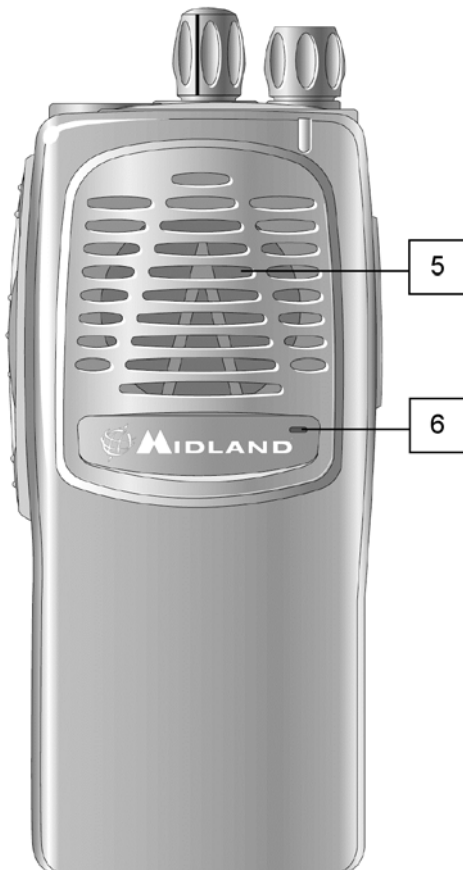

- [5] **Speaker.** The built in speaker located in this area emits the received audio.
- [6] **Microphone.** The microphone located here detects your voice.

Side (left and right)

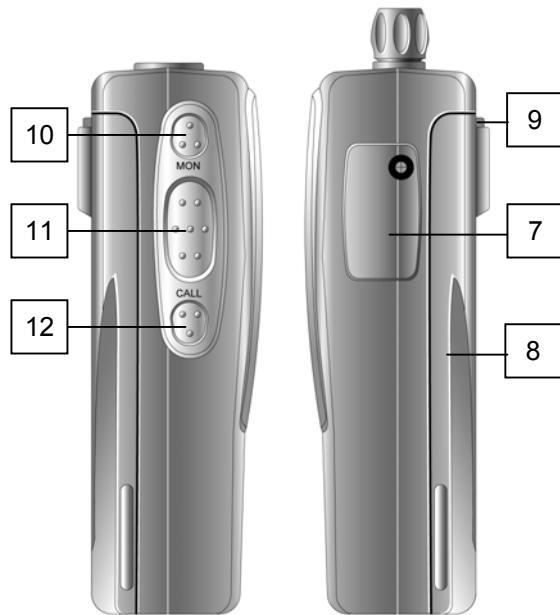

[7] **Microphone connector.** For remote speaker/microphone, headsets for VOX use and other accessories. It must be protected with the supplied cap when not in use. For the related pin connections please see "Microphone Connection".

[8] **Battery pack.** This NiMH battery pack supplies energy to your radio.

[9] **Release button** (located on the battery's body). Allows you to remove the battery pack

[10] **MON (monitor) button.** This button carries out different functions. The main ones are the following:

- If you briefly press it, you will enable/disable the audio monitoring of the radio traffic on the selected channel (if enabled). For details please see the paragraph 5.5.
- If you keep it pressed, the selective call #1 (if enabled) will be sent. For details please see the paragraph 6.2.b

[11] **PTT (Push To Talk) button.** When pressed, it switches the transceiver from reception to transmission. For details please see the paragraph 5.6.

[12] **FUNC (Function) button.** This button carries out different functions. The main ones are the following:

- If you briefly press it, you can adjust the VOX sensitivity by switching one of two available levels. For details please see the paragraph 7.2.c
- If you keep it pressed, the selective call #2 (if enabled) will be sent. For details please see the paragraph 6.2.b

Setup

Unpacking

The following items are in the package:

- (a) Transceiver's main body
- (b) Rubber antenna
- (c) Battery pack NiMH 1,300 mAh
- (d) Slow-rate battery charger with AC adapter.
- (e) Belt clip
- (f) User's guide (this book!)

If something is missing please promptly advise your supplier.

Attaching/removing the antenna

To attach the antenna:

- 1) Locate the antenna terminal (thread MX connector) on transceiver's top.
- 2) Hold the transceiver with one hand and the base (the thicker part) of the antenna with the other one.
- 3) Attach the included rubber antenna to the antenna terminal by turning it clockwise until it is firmly seated. Do not overtighten.

To remove the antenna do the same described procedure. At step 3 turn the antenna base counterclockwise.

 **Leave the antenna attached to the radio. You cannot communicate without it. Moreover, transmitting without the antenna may damage the TX output final stage. For the same reason use only the supplied antenna.**

 The supplied antenna is broadband type and covers the whole spectrum, so it does not need any alignment procedure.

Installing/removing the battery pack

To install the battery pack:

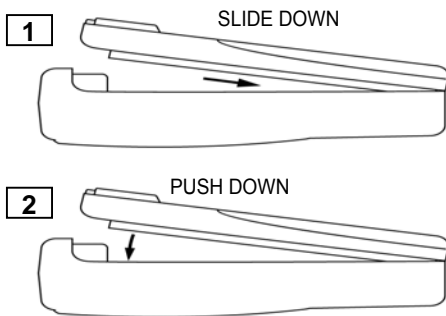

Hold the transceiver's body with one hand and the battery pack with the other. Put the battery pack onto the bottom of the transceiver.

Gently push the battery pack toward the transceiver's back edge.

At the end you will hear a click: the battery pack will snap into place and should be firmly locked.

To remove the battery pack:

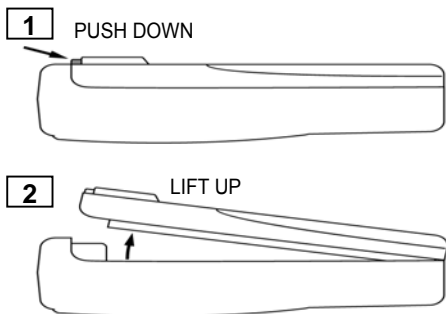

Press the battery release button located in the back of the battery pack.

Keep the button pressed and gently pull the battery pack away from the transceiver back edge (the opposite operation of the previous step 2).

Remove the battery pack by separating it from the transceiver's body.

Installing/removing the belt clip

The supplied belt clip allows you to hang the transceiver from your belt or jacket when you are not using the radio and you are just in stand-by condition (ready to receive calls).

To fit the belt clip onto the battery pack's body:

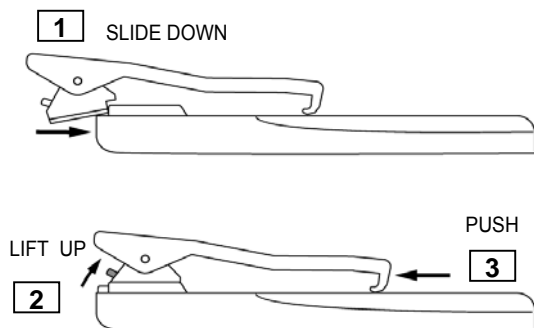

- 1) Gently slide the clip into the appropriate guides located in the transceiver's back until it firmly locks.

To remove the belt clip:

- 2) Press the belt clip spring;
- 3) Reverse the order stated in step 1.

Charging the battery pack

To charge the supplied battery pack you have to setup the standard charger and connect the radio as follows:

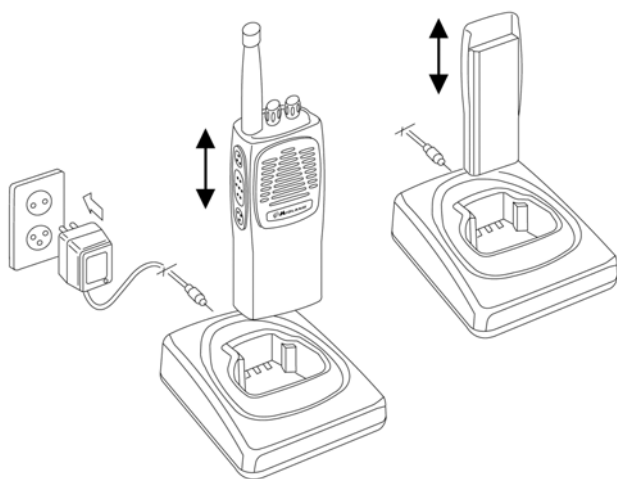

- 1) Connect the jack coming from the AC adapter to the cradle's socket.
- 4) Connect the AC plug of the AC adapter's power cable into grounded AC power outlet.
- 5) Ensure that the radio is switched off.
- 6) Insert the radio into the cradle with the front of the radio toward you (the three metallic contacts of the battery pack must touch with the three contacts inside the cradle). The LED indicator will glow red while the battery is charging.
- 7) Wait 10-12 hours with the standard charger 2 hours with the rapid charger and remove the radio. The LED of the standard charger does not signal a fully charged battery state.

 Do not remove the radio before the specified time, otherwise the battery's duty could be temporarily reduced.

 **Do not forget to remove the radio from the slow charger after 10 to 12 hours.**

 **The battery charger is for indoor use only.**

 **For the next charges, best duty and battery life please see the chapter "Battery Packs".**

Basic Operations

This section describes how the standard operations work. Standard operation can be changed by programming; moreover the functions the radio includes can be modified via an IBM compatible PC. For this reason the way your radio operates may be upgraded and may slightly differ from what is described here.

 **IMPORTANT:** Due to the full programmability of the radio, certain commands could be unavailable. If in doubt please contact your dealer/radio network administrator for further details.

Switching the radio ON/OFF

To switch the radio on:

1) Rotate the PWR/VOL knob clockwise until the radio is switched on: the CPU will start an autotest showing in sequence:

- LED will light GREEN, then RED and finally OFF.
- A beep confirms that the autotest is passed

 *The self-test goes very fast, therefore the LED may not be seen.*

To switch the radio off, rotate the PWR/VOL knob counterclockwise.

Adjusting volume

The PWR/VOL knob is used to adjust the RX volume: rotate clockwise to increase or counterclockwise to decrease the volume.

Channel selection

If your radio has been programmed with more than one channel you can easily change it. To select a channel, turn the channel selector knob clockwise or counterclockwise until the channel indicator on the knob matches the desired channel. If the selected channel has not previously been programmed, the green status LED remains permanently lit and a low error tone is produced.

Reception

Your radio could be programmed to work, channel by channel, in “Open traffic” or “GROUP MODE (CTCSS/DCS)”. Please look at each description and ask your radio network manager or dealer which mode your radio channels are set to work.

- **OPEN TRAFFIC:** in this case you will hear any communication which is transmitted on the selected channel.
- **GROUP MODE:**
 - **CTCSS/DCS** (Continuous Tone Code Squelch System - Digital Coded Squelch): these are systems which use particular TX signaling (a continuous sub audio tone for CTCSS or a digital code for DCS) as an access “key” to work a repeater (encoder) or to unlock the party’s signaling sensitive squelch. This condition allows sharing more radio networks in the same frequency. In this case you will receive only messages coming from parties sending a proper TX signal. During CTCSS/DCS operation the radio may be set-up so that the appropriate CTCSS/DCS decoder enables the speaker. Speaker will remain muted until the correct CTCSS tone or the correct DCS

code is received. In case of unmuted speaker, the message will be heard and the status LED will glow amber.

- **SELECTIVE CALL:** It is a signaling system that uses audio tones in sequence (usually “5 tones” selective calls) to call a specific station or group(s). In this case you will only receive calls that have your selective call identification code (a number) or calls sent to the group you belong. For further details please refer to the chapter 6.

 *The CTCSS/DCS and Selective Call can be combined together.*

 ***CTCSS/DCS allows more than one radio network to share the same frequency. However they are only useful to avoid disturbing stations not of the same network with messages not related to them. If more than one station is transmitting at the same time, this will cause interference. Do not transmit if the status LED is glowing. Wait until the channel is clear before transmitting.***

Monitor

The **MON** (monitor) button is mainly useful for two purposes:

- *If the channel you have tuned has been programmed in the Open Traffic mode, briefly pressing the **MON** button temporarily disables the squelch in order to allow you the reception of extremely weak signals that can't steadily open the squelch and are therefore received “chopped”.*
- *If the channel you have tuned has been programmed with CTCSS/DCS and/or Selective Call, a brief pressure of the **MON** button temporarily disables the CTCSS/DCS and/or Selective Call to allow you to monitor all the communications on the tuned channel, even the ones that are not belonging to your network. Practically, you are able to temporarily receive in Open Traffic just briefly pressing the **MON** button. In any case, if the **MON** button is enabled on your transceiver, press it briefly to temporarily monitor the signals on the tuned channel and repeat this operation to return to the normal condition.*

Monitor button can enable / disable “GROUP MODE (CTCSS/DCS) and Selective Call”.

- 1) Every time the **MON** button is pressed, a high or low acoustic tone will be produced to notify respectively the monitor function enabled (open squelch or disabled CTCSS/selective call) or disabled (closed squelch or enabled CTCSS/selective call)
- 2) Depending on the programming, the **MON** button could not be active or work in order to disable the CTCSS/DCS only or the selective call only. Please refer to your dealer/radio network manager for details.





 **NOTE:** if CTCSS/DCS tone is not programmed, GROUP MODE function is not available.

- 3) Press and Hold **MON** button for 5 seconds: internal squelch is disabled and your speaker is unmuted. Press and release the **MON** button to return to normal operation.

Transmission

When you need to transmit please remember to follow these steps:

- 1) *Ensure that the channel is not busy* (otherwise you will create interference, please wait for the channel to clear).
- 2) Press and hold the **PTT** key: the status LED will glow red.
- 3) Start talking *at a normal voice level* at approximately 4 inches (10 cm) from the microphone. When your message is completed, release the **PTT** key.

-  Do not shout! It will not increase the distance, but rather will make you sound distorted.
-  Do not release the **PTT** before your message is completed or start talking before pressing the **PTT** button.
-  A handheld radio doesn't normally allow you to talk and receive simultaneously, for this reason make your messages short. When you are talking the other parties can not, so do not occupy the channel too much. Use common sense.
-  The radio might be programmed with a **timeout timer** which will automatically put your radio in reception (after a preset time) if you talk too much. In this case release the **PTT** and wait for few seconds: the radio TX features will be automatically restored. Ask the network administrator or your dealer for further details.
-  The radio might be programmed with a **busy channel lock out**, which automatically disables transmission if your channel is busy. In this event wait until the channel is clear.

Transmission Power

Your 80-106/80-406 can transmit with two power levels. This option is programmed via PC. We do recommend, when possible, to use the Low power option. This will conserve the battery power and will reduce the risk of causing interference with stations not belonging to your radio network that may share the same channel with you.

-  If the red LED is "blinking" when you are transmitting, this is an indication the battery is need of charging. The Unit will then automatically revert to Low RF Power when transmitting in order to help prolong the Battery's operational life. In this case, two short beeps will be heard before transmission.

6 CTCSS/DCS and Selective Call operation

6.1 Reception

The radio may be set-up so that, during the operation with the CTCSS/DCS and/or Selective Call, audio is enabled only when you receive the appropriate CTCSS/DCS tone and/or Selective Call. Speaker will then remain muted until the correct CTCSS tone, the correct DCS code and/or the appropriate selective call is received. As soon as this condition takes place, the speaker will be unmuted allowing you to hear the message and the status LED will glow amber. In case of reception of signals without the correct tone, the speaker will remain muted and the status LED will glow green.

-  Depending on the programming, you can temporarily disable the CTCSS/DCS and the selective call in order to monitor the radio traffic. For details please refer to the paragraph 5.5.

6.2 Transmission

6.2.a CTCSS/DCS transmission

If your transceiver has been programmed to transmit a CTCSS tone or a DCS code, it is not necessary to do anything. The CTCSS tone or the DCS code is automatically sent every time you transmit (the device does not show this condition).

6.2.b Sending a normal selective call

On your transceiver the **MON** and **FUNC** buttons could have been programmed to send, respectively, the selective call Nr.1 and Nr.2.

To send a selective call:

1) Ensure that the channel is not busy (otherwise you will cause an interference), verifying that the status LED is not Glowing green or amber.

If the channel is not free, please wait until that condition takes place (LED turned-off)

2) Keep the **MON** or **FUNC** button pressed until the device will produce a beep (about 3 seconds), then release the button. The default address of every button is automatically recalled.

-  During a call, the transceiver transmits automatically (the status LED glows red), so it is not necessary to press the **PTT** button.

6.2.c Sending an emergency selective call

If your transceiver has been programmed to send an emergency selective call, you can send it by simultaneously pressing for a long time both the **MON** and **FUNC** buttons until you will hear a beep and the status LED will glow red, then release the buttons. The transceiver will send the emergency selective call.

Please use the emergency selective call only if a real condition requires its use. Coordinate its use with your radio network manager.

Scanning channels

If you have more than one channel programmed, your 80-106/80-406 can scan them: in other words it can cycle through them and stop when a signal is detected.

The advanced scan functions of the radio allow to optionally look for carrier or carrier with CTCSS or DCS.

- 1) To activate the scan *Switch Off* and then *Switch ON* the radio holding *MON and FUNC* buttons. Release the buttons when a long beep is heard.

During scanning the LED will blink amber. Only the channels in the Scan List will be monitored for activity. The Scan List is programmed via PC. The action of the radio after it stops on a busy channel can also be changed by PC programming.

- 2) To stop scanning *Switch Off* and then *Switch ON* the radio holding *MON and FUNC* buttons. Release the buttons when a long beep is heard. Switching off and on the radio does not stop the scanning.
- 3) A channel can be removed temporarily from the scan list if it becomes a nuisance. While the nuisance channel is active, press **FUNC+MON** keys. A beep will confirm the action. The channel will be restored when the radio is switched off and on again.

 **NOTE:** *If the Scan List has no channels, a low tone (error beep) will be heard when you switch On the radio while holding MON + FUNC buttons. The radio will not start the Scan Mode. At least two channels must be in the Scan List for the Unit to be put in the SCAN Mode.*

 *When a proper signal is received on a channel, the radio will stop scanning and audio will be heard. When the activity on that channel ceases, the unit will automatically resume scanning.*

 *If CTCSS/DCS have been previously programmed, the scanning will stop only if the received carrier has the appropriate signaling.*

Two modes of scanning are available, List Scan and Priority Scan. Either scan mode is selected by PC program.

List scan

The unit scans all channels in the scan list. The scan stops on a busy channel for the time it is busy unless an attack time has been selected. When the scan has stopped on a channel, the radio will transmit on that channel. If the scan is running, the radio will transmit on the channel selected by the channel knob. The scan waits for a preprogrammed time after the transmission stops on the busy channel before resuming the scan.

Priority Scan

One channel among the programmed channels can be assigned as Priority Channel. The scan function will look back at the priority channel more often. If activity is detected on the priority channel while listening to another channel, the radio will switch to the priority channel until that activity stops.

To select Priority channel (if previously enabled by the programming):

- 1) Before starting the Scan Mode and before switching on the radio, select the priority channel using the selector knob. The priority channel must be programmed as a transmit channel for the unit to transmit.

2) Activate scanning as described above. The channel you selected is now your priority channel.

 *If PTT is pressed during scanning, the radio will transmit on the last received channel if traffic is within the last 15 seconds. Otherwise the radio will transmit on the priority channel. In case of no activity, the Unit will automatically resume scanning.*

Advanced Operations

Hands-free transmission (VOX)

VOX (Voice Operated transmit) is an automatic system that allows you to automatically switch the transmission in hands-free mode just by speaking in the built-in microphone of a headset (not provided with the unit). Please ensure that the headset is suitable for your transceiver as reported in the paragraph "Microphone connection". To activate the VOX and adjust sensitivity:

- 1) Press and hold the **FUNC** button while turning the radio on. Release the button when a long beep is heard.
- 2) Connect the optional headset with built-in microphone to the microphone connector located on the transceiver's side. Ensure that the headset's built-in microphone is located close to the side of your mouth.
- 3) Press the **FUNC** key briefly to toggle VOX sensitivity from HIGH to LOW and vice versa. Adjust the VOX sensitivity in order to ensure a stable transmission when speaking with a normal voice level. There is no visual or audible indication that the sensitivity has changed.

 ***We recommend to set the sensitivity as low as possible. A too high value could cause accidental transmissions, especially in high noise environments.***

 ***PTT button is disabled during VOX.***

7.3 Confidential Communications (scrambler)

Your transceiver could have been programmed to use the scrambler when necessary. This is a device that makes your communications unintelligible to normal receivers/transceivers, but perfectly clear to the other radios of your network equipped of the same type of scrambler.

To enable the scrambler:

- 1) Ensure that the other party enables his/her scrambler too.
- 2) *Simultaneously and briefly* press the **MON** and **FUNC** buttons. The device will send a high-pitched beep to confirm that the scrambler is enabled.

To disable the scrambler:

- 1) Ensure that the other party disables his scrambler too
- 2) Follow the above-mentioned step 2. The device will produce a low-pitched beep to confirm that the scrambler is disabled.

If the scrambler is enabled, you can't receive unencrypted communications. In any case, in order to guarantee the communication, all the radios that have to communicate with each other must have the scrambler enabled or disabled.

The scrambler can be disabled during the programming. If in doubt please contact your dealer/radio network manager. As any coding device, your transceiver's scrambler cannot guarantee 100% communication security.

Care and Maintenance

Battery Packs

Information on rechargeable batteries

- When the battery pack is new it will not provide 100% of its efficiency. To reach the full battery life you have to cycle the battery with at least 3-4 deep charging/discharging cycles. Please see “Proper charging of battery packs” for further details.
- Should you properly use the battery pack, you will obtain at least 400 charging/discharging cycles with slow charger or 300 with the rapid charger. The battery capacity will progressively reduce after 2/3 of its life (approx.).
- Rechargeable battery packs lose their charge with time if left unused (self-discharge). This is normal. A NiMH (Nickel Metal Hydride) battery can reduce 10 to 20% of its stored energy in few days.

Proper charging of battery packs

- 1) Ensure that the radio is switched off.
- 4) Insert the radio into the cradle as explained in the paragraph “Charging the battery pack”
- 5) Wait the necessary time to provide a full charge. If the pack isn't completely discharged you will need less than 10-12 hours (using slow charger).

 ***Do not overcharge the battery: always remember to remove the radio after the necessary time.***

 ***The battery charger is for indoor use only.***

 *When possible, charge the battery when it is fully discharged or, at least, you have used it for the major part of its capacity. Otherwise the battery's capacity could be temporarily reduced. Please see the paragraph “Memory effect”.*

 *Do not remove the radio before the necessary time, otherwise the battery's duty could be temporarily reduced. Please see the paragraph “Memory effect”.*

Memory effect

The supplied NiMH (Nickel Metal Hydrate) battery pack is made with a more advanced technology than a normal NiCd (Nickel Cadmium) battery. For this reason it is virtually free of what is called “memory effect”, which affects NiCd batteries. Memory effect is a temporary capacity reduction that reduces the battery duty cycle time. Memory effect may occur if you *regularly* charge the battery when you haven't discharged it at least at 50-70%. Memory effect can be easily avoided by following these simple rules:

- When possible charge battery packs only when they are completely discharged.
- Do not remove the battery from the charger before the necessary time to provide a full charge.
- Provide at least two deep charge/discharge cycles per month.
- The best way to avoid memory effect is to use two battery packs and alternate their use with the radio. This will allow you to keep your transceiver in operation by replacing the battery pack when it is fully discharged. At the end of your working day you will charge the discharged pack for 10-12 hours.

Erasing memory effect











Just applying 3-4 deeper charge/discharge cycles can easily erase memory effect:

- 1) Use the battery attached to the radio and wait until the radio will no longer operate.
- 6) Wait at least one hour and then try to switch on the radio: you will note that some energy has restored in the battery, because the radio can be switched on.
- 7) Leave the radio in RX until the radio switches off again.
- 8) Repeat steps 2 and 3 three times.
- 9) Fully charge the battery for 10-12 hours and check the battery capacity. If some memory effect still exists go back to step 1.

 *If the battery capacity does not improve after three cycles, your battery pack is faulty or has reached the end of its life (please see "Information on rechargeable batteries").*

Warnings for battery and charger use

Please use these cautions to avoid damaging battery packs or the transceiver:

-  **Before using the battery charger carefully read any related warning or caution.**
-  **Do not short battery terminals: this may cause fire, burns or explosions.**
-  **Never dispose batteries into fire as they may explode. Strictly follow any disposal regulation of your area.**
-  **Use only authorized batteries and chargers. The use of non-authorized accessories may cause burns, fire or explosions as well as causing serious damage to the radio/battery or serious injuries to people.**
-  **Battery chargers are for indoor use only.**
-  **Ensure that your power source matches the rating listed for the supplied battery charger AC Adapter.**
-  **To avoid damaging the power cable of the battery charger, do not put anything on it or place it where it will be walked on.**
-  **Avoid strong shocks. Do not use the charger if it received a strong shock, has fallen down or it appears damaged; immediately contact an authorized service station.**
-  **Never try to disassemble or service the charger by yourself. Always contact your local dealer for assistance.**
-  **To reduce the risk of electric shocks disconnect the plug before providing any cleaning or maintenance.**

 **Battery performance will be degraded when exposed to temperatures below -20°C (-4°F) or greater than 35°C (95°F) during their use. Also do not charge them outside the range of +5°C (41°F) to +55°C (149°F).**

Radio maintenance

Cleaning battery packs

Wipe the battery contacts with a clean and lint free cloth to remove dirt, grease or any other material which may prevent a good electrical contact. If contacts are very dirty you can also wipe them using a *soft pencil rubber* (not hard erasers for ink). If you feel that battery contacts aren't still working properly, please contact your authorized dealer.

 **Do not use liquid, alcohol or aerosol cleaners.**

Cleaning the radio

- Wipe the radio with a clean cloth to remove dust. If it is very dirty, you can use a damp (*slightly moistened with water*) cloth.

 **Do not use liquid, alcohol or aerosol cleaners.**

Connectors

When the accessory connectors are not being used, the radio should be fitted with the supplied cover cap.

 **Only suitable accessories must be connected to the related connectors.**

Optional accessories

These optional approved accessories can be used with your radio:

- Spare battery pack (Model 18-B02). It extends the duty time and minimizes the possibility of memory effect (please see “Memory effect”).
- Slow charger (Model 81-392). It recharges the battery packs in 10 to 12 hours
- Rapid charger (Model 81-390). It recharges the battery packs in 2 hours and provides trickle charge when they have reached their full charge.

Microphone connector

The microphone connector is designed for the connection of two pin accessories (not supplied as standard):

Any kind of accessory for external listening and speaking can be connected to the microphone connector, provided that they meet the following requirements:

- Jack connectors for Speaker (SPK) and Microphone (MIC) must be respectively standard type 3.5 mm and 2.5 mm. and connected as follows:

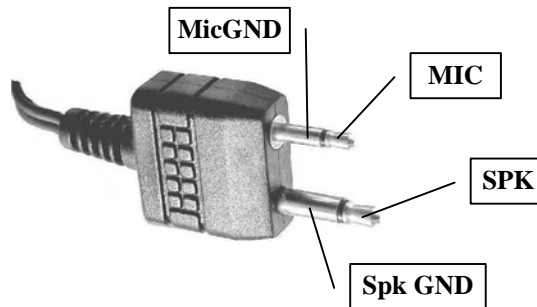

- The suggested speaker input impedance is 8 Ohms
- The microphone should be condenser low-impedance type.
- Any accessory should be of high quality suitable for professional use.

⚠ Please do not connect any accessory that you are not sure of meeting the above stated requirements. You could create serious damage to your radio. If in doubt please contact your authorized dealer.

Quick reference

Operation resume

Once you are familiar with your transceiver you will know that it's very easy to use any one of its functions by doing the following:

- 1) Press and release the **MON** to enable/disable GROUP MODE (CTCSS or DCS).
- 2) Press and Hold **MON** button to enable/disable the squelch.
- 3) Press and hold the **MON + FUNC** keys while the switching ON radio to enter the SCAN.
- 4) Before entering the SCAN MODE, use the channel selector knob to select the priority channel.
- 5) Hold the **FUNC** key and switch on the radio to enable/disable VOX.
- 6) When VOX function is enabled, press and release the **FUNC** key to set *HIGH* or *LOW* VOX sensitivity.

FUNCTION	CONTROL	MODE	RIF.
Switching on/off	PWR/VOL	Clockwise/counterclockwise rotation beyond the mechanical click	5.1
Adjusting volume	PWR/VOL	Clockwise/counterclockwise rotation	5.2
Operating channel selection	Channel selector	Rotation on the desired channel	5.3
Monitor of the communications in progress (enabling/disabling)	MON	Briefly pressed	5.5
Transmission	PTT	Pressed from the start to the end of the message	5.6
Sending the selective call #1	MON	Held pressed	6.2.b
Sending the selective call #2	FUNC	Held pressed	6.2.b
Sending the emergency selective call	MON+FUNC	Both held pressed simultaneously	6.2.c
Channel scanning (enabling/disabling)	MON+FUNC	Turn on the radio holding the buttons pressed	7.1.a
Priority channel scanning selection	Channel selector	Enable the scanning with the selector on the desired channel	7.1.b
VOX (enabling/disabling)	FUNC	Turn on the radio by holding the button pressed	7.2.b
VOX sensitivity adjustment (two levels)	FUNC	Briefly pressed	7.2.c
Scrambler (enabling/disabling)	MON+FUNC	Both simultaneously briefly pressed	7.3

 **Press the MON key and switch on the unit. The unit enters the PROGRAMMING MODE. This operation is only allowed to an authorized person.**

11 Technical specifications

11.1 Test methods

- TIA/EIA-603 Standards
- MIL STD 810F which supersedes MIL STD 810 C/D/E

11.2 Specifications table

Characteristic Units Value/Measurements conditions

General

Frequency MHz 80-106: from 148 to 174
80-406: from 440 to 470
Operating Band MHz 26
Number of – 16 Programmable Channels
Channel Spacing kHz 12.5 / 20 / 25
Frequency Steps kHz 5 / 6.25
Rated Power Supply Vdc 7.5
Battery Capacity mAh Ni-MH 1300
Duty Cycle hours 5% on TX at the maximum power
5% on RX at 60 % of the maximum rated AF power 8 hours
90% on RX with closed squelch in power save mode
Antenna Impedance Ohm 50
Speaker Impedance Ohm 8
Frequency Stability PPM ± 2.5
Operating Temperature Range °C from –30 to +60

Transmitter

Output Power (± 1 dB) W 1 / 5
Spurious Emissions μ W from 9 kHz to 1 GHz < 0,25
from 1 to 4 GHz < 1
Modulation System - F3E (FM)
Modulation kHz $\pm 2.5 / 5$
Audio Distortion - 5 % or less
Maximum Deviation kHz $\pm 2.5 / 5$
Adjacent Channel dB < -60 / -70
Power Attenuation

Receiver

Configuration - Double Conversion Superheterodyne
Sensitivity (at 12 dB SINAD) μ V < 0.35
Squelch Sensitivity (SINAD) dB 10
Selectivity (Adjacent Channel) dB At least -65 / -75
Spurious Response Rejection dB > 70
Intermodulation dB > 65
Hum & Noise Suppression dB < -45 / < -40
Audio Output mW 500 (1 kHz at 5% T.H.D.)

Mechanical Specifications

Size (Battery Pack Included) mm 130 x 42 x 60
Weight (Battery Pack Included) g 355
Battery - Back slide battery
Accessories - 2.5 and 3.5 mm standard monophonic
Connector/Programming jacks
Moisture & Dust Resistance - According to MIL STD 810F

SERVICE:

If it ever becomes necessary to return your unit for warranty service:

1. Pack the unit in its original box and packing.
2. Pack the original box in a suitable shipping carton. Improper packing will result in damage during shipment.
3. Include a photocopy of the bill of sale showing the date of purchase.
4. Include a brief description of the problem you are having.
5. Include a DAYTIME telephone number.
6. Include a money order or Visa or Master Card credit card number to cover shipping and handling. No personal checks please.
7. You do not need to return accessory unless they may be directly related to the problem.
8. This information must be included before Warranty Service can be considered. Failure to include these items will delay the repair of the radio until these items are received.

Ship to:
Service Department
Midland Radio
1120 Clay
North Kansas City, Mo. 64116

LIMITED WARRANTY

Midland Radio Corporation Inc. will repair or replace, at its option without charge, any Midland handheld transceiver which fails due to a defect in material or workmanship within ONE YEAR following the initial consumer purchase.

This warranty does not include any carrying cases, earphones, or antennas, which may be a part of or included with the warranted product.

Performance of any obligation under this warranty may be obtained by returning the warranted product, freight prepaid, along with proof of purchase date, to Midland Radio Corporation, Warranty Service Department, 1120 Clay St., N. Kansas City, Missouri 64116, or to any or to the place of purchase (if a participating dealer).

Warranty information may be obtained by writing Midland Radio Corporation, Warranty Service Department at the above address.

This warranty gives you specific legal rights, and you may also have other rights which vary from state to state.

Note: The above warranty applies only to merchandise purchased in the United States of America or any of the territories or possessions thereof, or from a U.S. Military exchange.

Midland Radio Corporation
1120 Clay St.
N. Kansas City, Mo. 64116
Ph: 816-241-8500

Printed in Thailand

E-mail: mail@midlandradio.com
URL: www.midlandradio.com

Index

A

Adjusting	
Volume	11
Antenna	
attaching/removing	9

B

Battery charger	
rapid (optional)	18
standard	10
Battery packs	
Charging	10
cleaning	17
Erasing memory effect	16
Information on rechargeable batteries	15
Memory effect	15
Proper changing	15
Warnings for battery and chargers use	16
Belt clip	10

C

Care and Maintenance	15
Channel selection	11
Charger	<i>See</i> Battery charger
Cleaning the radio	17
Connectors	17
Conventions and Symbols	5

H

Handsfree transmission (VOX)	14
------------------------------	----

M

Memory effect	15
Microphone connector	18

O

Optional accessories	18
Rapid charger	18
Spare battery pack	18
Output power	12

P

Part Names and their functions	6
Power	
button	11
ON/OFF	11
TX output	12

Q

Quick reference	19
Operation resume	19

R

Radio maintenance	17
Rapid charger	18
Reception	11, 12

S

Safety	3
Scanning channels	13
Setup	
Attaching antenna	9
Battery pack	9
Belt clip	10
Charging the battery pack	10
Package contents	8
Unpacking	8
Switching the radio ON/OFF	11

T

Transmission	12
Transmission Power	12
Transmission Power	12

V

VOX	14
-----	----

W

Warning notes	3
Warnings for battery and chargers use	16