

HANDHELD COMPUTER

DF7A

USER'S GUIDE
(Preliminary Version)

Notice

Copyright© 2014, MilDef Crete Inc. All rights reserved.

No part of this publication may be reproduced and modified without the written permission of MilDef Crete Inc.

MilDef Crete Inc. reserves the right to make changes in the products or the product specifications without any prior notice. Customers are advised to contact MilDef Crete for updated product information.

MilDef Crete makes no representations or warranties, either expressed or implied, with respect to the contents hereof and specifically disclaims any warranties for the correctness of this book, nor any license grant of MilDef Crete's patents or intellectual properties. MilDef Crete assumes no liability for customer's loss or damage caused by using this document.

Trademarks

Android is a registered trademark of Google Inc.

Qualcomm MSM8225Q Processor is a registered trademark of Qualcomm Inc.

All other brands and product names are trademarks or registered trademarks of their respective holders.

Revision History:

Revision	Date	Changes	Author
----------	------	---------	--------

Regulatory Information/ Disclaimers

Installation and use of this computer must be in strict accordance with the instructions included in the user documentation provided with the product. Any changes or modifications (including the antennas) made to this device that are not expressly approved by the manufacturer may void the user's authority to operate the equipment.

The manufacturer is not responsible for any radio or television interference caused by unauthorized modification of this device, or the substitution of the connecting cables and equipment other than manufacturer specified. It is the responsibility of the user to correct any interference caused by such unauthorized modification, substitution or attachment. Manufacturer and its authorized resellers or distributors will assume no liability for any damage or violation of government regulations arising from failing to comply with these guidelines.

FCC (Federal Communications Commission) Statement

This equipment has been tested and found to comply with the limits for a Class-B digital device pursuant part 15 of the FCC Rules. These limits are designed to provide reasonable protection against harmful interference in a residential installation.

This equipment generates, uses, and radiates radio frequency energy. If not being installed and used in accordance with the instructions, it may cause harmful interference to radio communications. However, there is no guarantee that interference will not occur in a particular installation. If this equipment does cause harmful interference to radio or television reception, which can be determined by turning the equipment off and on, the user is encouraged to try to correct the interference by one or more of the following measures:

- Re-orient or relocate the receiving antenna.
- Increase the separation between the equipment and receiver.
- Connect the equipment into an outlet on a circuit different from that to which the receiver is connected.
- Consult the dealer or an experienced radio/TV technician for help.

Radiation Exposure Statement

This equipment complies with FCC RF radiation exposure limits set forth for an uncontrolled environment.

This transmitter must not be co-located or operating in conjunction with any other antenna or transmitter.

This device complies with Part 15 of the FCC Rules. Operation is subject to the following two conditions:

- This device may not cause harmful interference.
- This device must accept any interference received, including interference that may cause undesired operation.

FCC Caution

To assure continued compliance, any changes or modifications not expressly approved by the party responsible for compliance could void the user's authority to operate this equipment. (Example: use only shielded interface cables when connecting to computer or peripheral devices).

CE

Products with the CE Marking comply with both the EMC Directive (2004/108/EC) and the Low Voltage Directive (2006/95/EC) issued by the Commission of the European Community.

Compliance with these directives implies conformity to the following European Norms:

EN55022	CISPR 22 Radio Frequency Interference
EN55024	EN61000-4-2, EN61000-4-3, EN61000-4-4, EN61000-4-5, EN61000-4-6, EN61000-4-8, EN61000-4-11, EN61000-3-2, EN61000-3-3, Generic Immunity Standard
LVD	EN 60950-1:2006+A11:2009+A1:2010+A12 :2011+A2:2013

R&TTE (CE) Manual Regulatory Requirement

WLAN - IEEE 802.11 b/g/n

802.11 b/g/n Restrictions:

European standards dictate maximum radiated transmit power of 100 mW EIRP and frequency range 2.400-2.4835 GHz.

CE Declaration of Conformity



It is confirmed to comply with the requirements set out in the Council Directive on the approximation of the laws of the member states relating to Electromagnetic Compatibility Directive (2004/108/EC), Low-voltage Directive (2006/95/EC) and the procedures given in R&TTE Directive (99/5/EC).

The equipment was passed, and the equipment test was performed according to the following European standards:

EN 300 328 V1.7.1 (2006)

EN 301 489-1 V1.9.2 (2011) / EN 301 489-3 V1.6.1 (2013) /

EN 301 489-17 V2.2.1 (2012)

EN 62311:2008

EN 62209-2:2010

EN 300 440 V1.6.1 (2010)

EN 300 440-2: V 1.4.1 (2010)

UL, TÜV

AC Adapter (TÜV includes **LVD EN60950-1**)

Power Conservation

This handheld computer consumes less power compared to conventional consumer computers. The power consumption may be further reduced by properly configuring the Power Management Setup.

It is recommended that the power saving features be enabled even when not running on battery power. Power Management features can conserve power without degrading system performance.

Power Safety

There are specific power requirements for your handheld computer:

- Only use an approved AC adapter designed for this handheld computer.
- There is a 3-prong grounded plug for the AC adapter. The 3rd prong is an important mechanism for ensuring product safety. Please do not neglect the importance of this mechanism. If you are unable to access a compatible outlet, please hire a qualified electrician to install a compatible outlet for you.
- When unplugging the AC power cord, please make sure to disconnect the cord by pulling from the plug head instead of pulling from the wire to prevent wire damage.
- Make sure the power outlet and any other extension cord(s) you use can support the total current load of all the connected devices.
- Before cleaning the handheld computer, please make sure it is disconnected from any external power source.



Warning

Before any upgrade procedures, make sure the power is turned off, and all the cables are disconnected. Also, it is advisable to remove your battery to prevent your handheld computer from accidentally turning on.

Battery Precautions

- Only use batteries designed for this handheld computer. Using incompatible battery types may cause explosion, leakage or damage to the computer.
- Do not remove the battery from the computer while the computer is powered on.
- Do not continuously use a battery that has been dropped, or that appears damaged (e.g. bent or twisted) in any way. Even if the computer is able to continuously work with a damaged battery, the circuit damage may occur and possibly cause fire.
- Always use the charger designed for this computer to recharge the battery. Incorrect recharging may cause the battery to explode.
- Do not try to service a battery by yourself. For battery service or replacement, please contact your service representatives.
- Please dispose of damaged battery promptly and carefully. Explosion or leakage may occur, if the battery is exposed to fire, improperly handled or discarded.



Battery Disposal & Caution

The product that you have purchased contains a rechargeable battery. The battery is recyclable. At the end of its service life, under various state and local laws, it may be illegal to dispose of this battery into the municipal waste stream. Check with your local solid waste officials for details in your area for recycling options or proper disposal. Danger of explosion may possibly occur, if the battery is incorrectly replaced. Replace only with the same or the equivalent battery recommended by the manufacturer. Discard the used battery according to the manufacturer's instructions.

Environmental Information, Material Safety & Recycling

All materials used in the manufacturing of this equipment are recyclable or environmentally friendly. Please recycle the packing materials in accordance with local regulations at the end of the product's service life.

Notice:

- The equipment may contain insignificant amount of hazardous substances for health and environment below control level.
- To avoid spreading such substances into the eco system and to minimize the pressure on the natural environment, you are encouraged to reuse or recycle most of the materials in a safe way after the product's service life.
- For more information on collection, reuse and recycle of materials, please consult local or regional waste administrations for more information. You can also contact your dealer for more information on the environmental details of the equipment.
- The symbol of the crossed out wheeled bin indicates that the product (electrical and electronic equipment) should not be placed in municipal waste. Please check local regulations for disposal of electronic products.



TABLE OF CONTENTS

Chapter 1 - Getting Started	1
Unpacking.....	1
Workplace.....	2
Environmental Ratings	2
Ruggedness	2
Appearance Overview	3
Ready for Use	7
Chapter 2 - Operating Information	10
Start Using Your Handheld Computer	10
Suspend / Stop Using Your Handheld Computer	12
Using the Touchscreen	14
Using Application Keys	15
Audio Features	16
Manage Micro SD Card.....	17
Device Connectivity	20
Wi-Fi (Option).....	21
Bluetooth (Option)	22
GPS (Option).....	23
Chapter 3 - Managing Power	24
AC Adapter	24
Battery	26
Chapter 4 - Specifications	29
Processor.....	29
Memory	29

External Storage	29
OS	29
Audio	29
Display	30
Wireless Communication Devices	30
I/O Ports	31
Battery	32
Double Capacity Battery (Option)	32
20W AC Adapter	32
Dimensions & Weight	32
Case Materials and Color	33
Certification	33
Accessories	34
Multi-Charger MCDF (Option)	35

Chapter 5 - Maintenance and Service..... 36

Cleaning	36
Troubleshooting	36
RMA Service	38

Appendix: 39

Chapter 1 - Getting Started

Unpacking

The following list of items are packaged and shipped along with your handheld computer. If any of these items is missing or damaged, please notify your dealer immediately.

- Handheld Computer Unit
- 20W AC Adapter
- 1M USB Cable (LEMO to USB)
- Quick Guide

Workplace

A clean and moisture-free environment is preferred. Make room for air circulation. Remember to avoid areas from:

- Sudden or extreme changes in temperature.
- Extreme heat.
- Strong electromagnetic fields (Near television set, motor rotation area, etc.).
- Dust or high humidity.

If this handheld computer is required to work in a hostile environment, please maintain your handheld computer regularly by cleaning dust, water, and etc. to keep it in an optimal operating condition.

Environmental Ratings

Operating Temperature: -20 °C ~ +55 °C
Operating Altitude: 0 meter ~ 4,572 meters
Operating Humidity: Up to 95% (non-condensing)

Ruggedness

This handheld computer is designed with rugged features, such as vibration, shock, dust, and rain/water protection. However, it is still necessary to provide appropriate protection while operating in hostile environments.

Appearance Overview

Before starting to use your handheld computer, it is advisable that you take a quick glance to familiarize yourself with the locations of your device’s external buttons and components. Note, the following illustrations show optional devices which may not on your device.

Front View

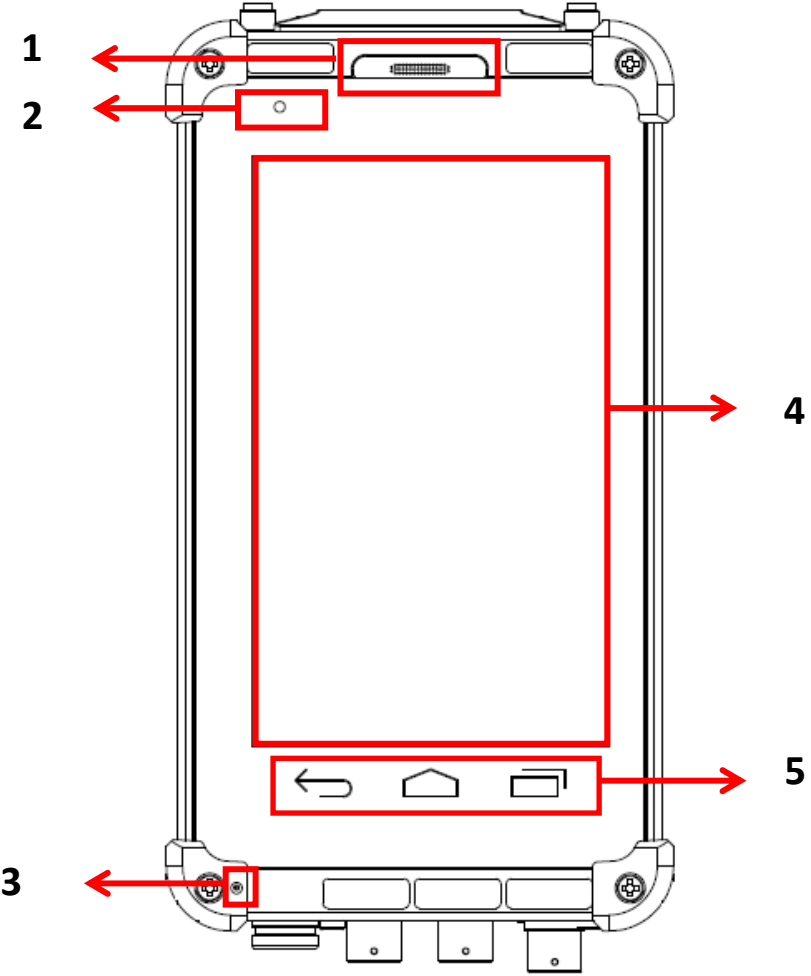

No.	Feature	Functional Description	Remark
1	Receiver	To hear the sound from the other end of the phone	
2	Charge Indicator	LED lights up (orange) when charging begins and off when charging is finished.	
3	Built-in Mic	Microphone for recording	
4	Touch Screen	LCD Resolution: 480 x 800. Capacitive Multi-touch touch + Sunlight	

		readable screen.	
5	Function Keys	Back/Home/Menu	

Rear View

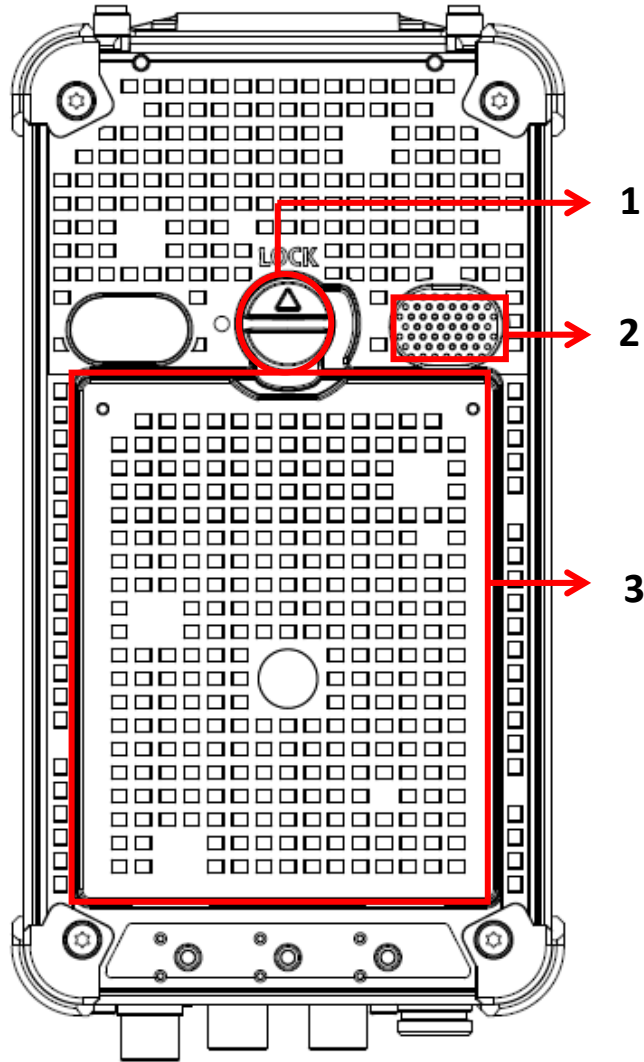

No.	Feature	Functional Description	Remark
1	Battery Lock	Slot-type head for locking the battery.	
2	Speaker	Mono Speaker for audio output.	
3	Battery Pack	Provides power source to your device.	

Right View

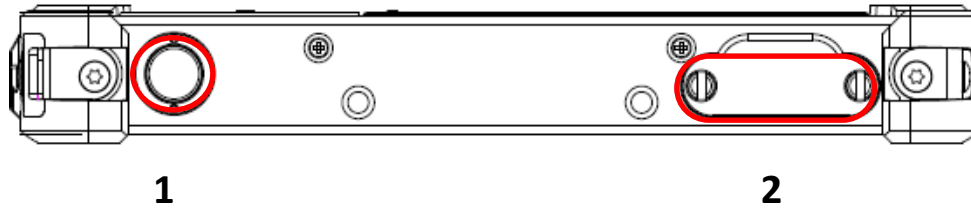

No.	Feature	Functional Description	Remark
1	Power Button	Turns the device ON/OFF. Put the device to suspend mode.	
2	Micro SD Card Slot	Removable mass storage media.	

Left View

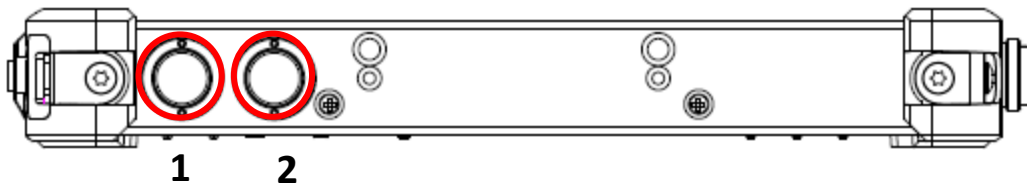

No.	Feature	Functional Description	Remark
1	Volume up control	Increases device audio volume.	
2	Volume down control	Decreases device audio volume.	

Top View

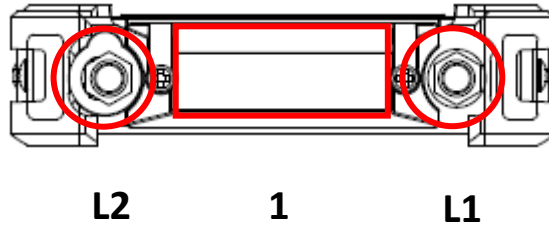

No.	Feature	Functional Description	Remark
1	Embedded ANT.	Optional Embedded ANT. for GPS	
L1	SMA ANT.	Optional SMA ANT. function: WiFi & Bluetooth, GPS	Refer to Appendix
L2	SMA ANT.	Optional SMA ANT. function: WiFi & Bluetooth, GPS	Refer to Appendix

Bottom View

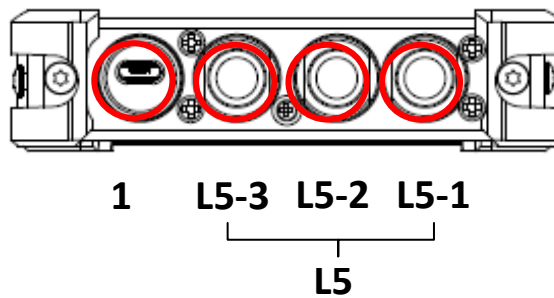

No.	Feature	Functional Description	Remark
1	DC-in/USB client	Standard: Sealed DC-in 5V with LEMO 8 pin Connectors Optional: Sealed Micro USB	Refer to Appendix
L5	Optional Fischer connector	Choose 1 out of 5 for each connector: RS232, USB, 100M LAN, Headset, VGA	Refer to Appendix

Ready for Use

After taking a quick look at your handheld computer, the following illustrations will help you setup your handheld computer ready for operations.

Mounting the Battery

- A. Mount the battery into the battery bay. B. Turn clockwise and lock firmly with a slot screwdriver or a coin.



Connecting the AC Adapter

1. Insert the end of LEMO connector to the micro USB client.
2. Plug the AC cord into the AC adapter.

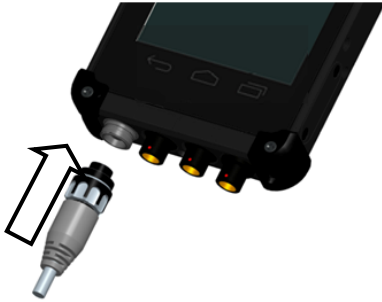

3. Plug the AC power plug into an electrical outlet.

Turning ON the Power

- A. Make sure the battery is securely mounted. Connect all power cords properly.
- B. Turn on the power of your handheld computer by pressing the “**Power Button**”.

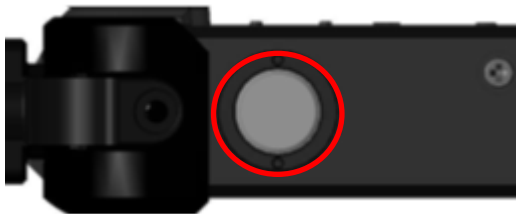

Press the button to turn on the power of your handheld computer.

Note:

- *You can turn on the power of your handheld computer without a mounted battery if your handheld computer is directly attached to an external power source.*

Turning Off the Power

To turn off the power of your handheld computer, press the power button once and wait for the Power Menu to be displayed onscreen. From the Power Menu, tap the “**Power Off**” button to turn off the power of your handheld computer.

Note:

- *If you lose power during operation (i.e. running out of battery), all unsaved work and data will be lost.*

Chapter 2 - Operating Information

Start Using Your Handheld Computer

Turn on your handheld computer by pressing the power button few seconds **until you feel vibration**. After turning on the power of your handheld computer, the device will boot up with Android system.

Boot Up

When turning on the power, you will see “LOADING” on the screen and your handheld computer will start to load the required boot up files and processes for operation. This start-up procedure is called “boot up”. Your handheld computer requires approximately 30 seconds of Boot Up time before the OS is fully loaded.

After boot up, you will be presented with the desktop screen as below. You can create application short-cuts of to your desktop, change the background wallpaper, as well as modify the display font size, etc., in a similar fashion.

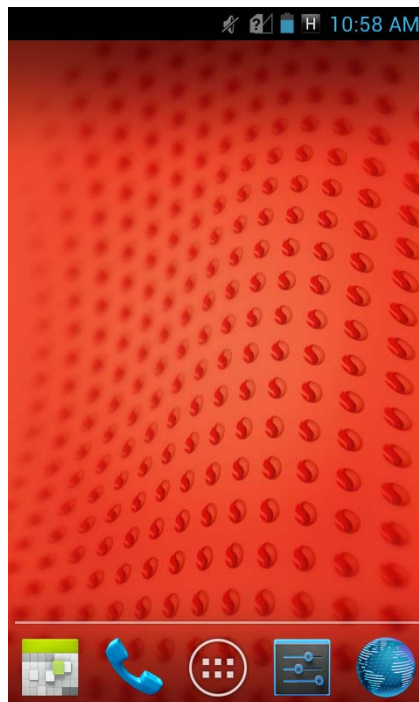

Main Dock

The Main Dock, which is located at the bottom of your desktop, allows you to easily launch programs and applications installed within your handheld computer. Users can set and customize the Main Dock by their preference. A sample image of Main Dock is provided as below.



Suspend / Stop Using Your Handheld Computer

Suspend

In order to conserve your device battery life, you may place your device into suspend mode. By pressing the power button, the display of your handheld computer will be turned off, entering into suspend mode.

Suspend is an ideal state for your device when you want to conserve more battery life, do not need to stop wireless connectivity, and keep your device ready to resume back to work on a moment's notice.

You can change your handheld computer to different mode anytime by pressing the power button for about 2 seconds along with a vibration to open up the Phone options as below.

Power Off

To power off your handheld computer, you can open up the Phone options as below by pressing the power button for about 2 seconds along with a vibration,.

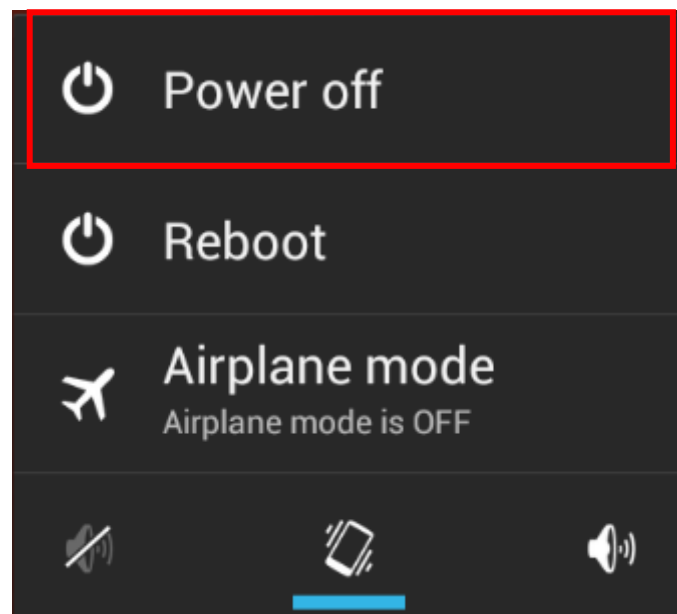

In Power Off state, your handheld device is completely turned off. All applications are

terminated, no wireless connectivity is established and all unsaved data are lost.

Power Off is an ideal state for your handheld device when you do not need to operate your device for an extended period of time.

Hardware Reset

If you press the power button for more than 8 seconds, the hardware of the device will reset. Note that this will cause time zone setting to change and you may have to set the appropriate time zone for your own location.

Using the Touchscreen

Basic Operation

Your handheld computer is equipped with a highly sensitive touch screen, allowing you to navigate on the touch screen easily without using other external devices. A list of operating tips is provided below to help you operate the touch screen more effectively.

Desired Operation	Action
Tap	Tap the screen with your finger when you want to select onscreen items such as application, icons, or onscreen buttons.
Press and hold	To open the available options for an item (for example, a contact or link in a webpage), just press and hold the item.
Flick and swipe	Flicking the screen is similar to swiping, except that you need to swipe your finger in light, quicker strokes, such as when moving right and left on the Home screen, or flicking through a contacts or message list.

Using Application Keys

The following table shows basic functions of using application keys.

Application Keys	Functions
Back	Press to return to the previous screen.
Home	<ul style="list-style-type: none">- Press to return to the Home screen.- Press and hold to show applications recently used.
Menu	<ul style="list-style-type: none">- Press to open the menu.- Press and hold to turn on onscreen keyboard.

Audio Features

Your handheld computer is equipped with an audio codec for sound playback. To adjust the volume of your device, please use the volume up/down button located at the upper left side of your device.

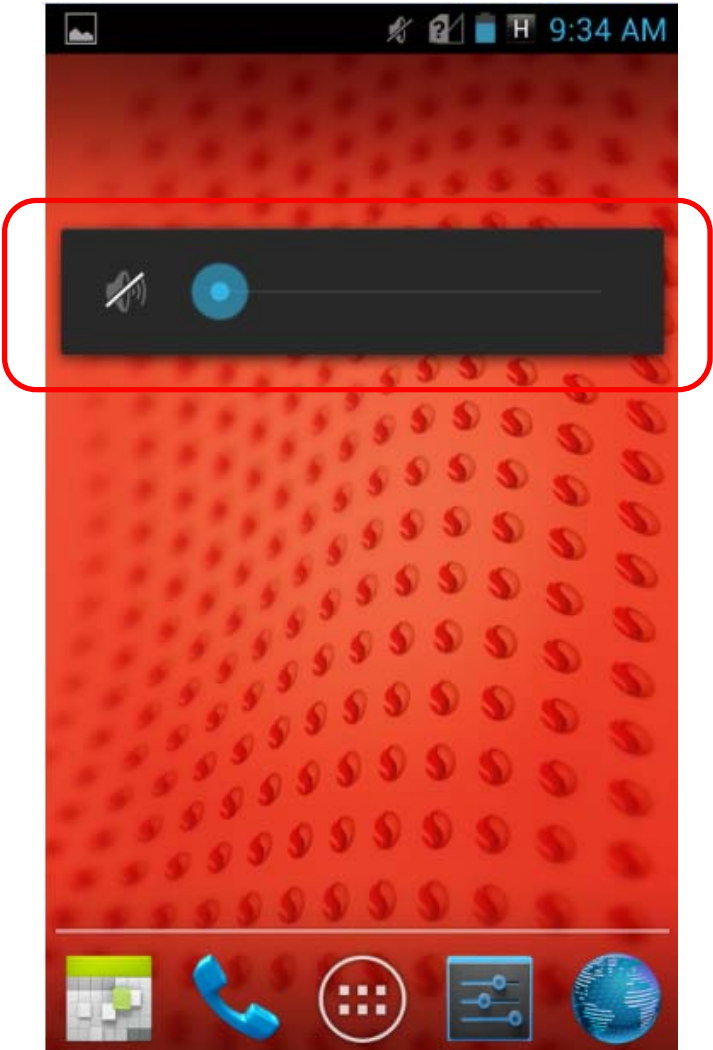
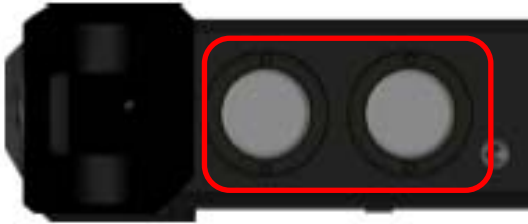

Manage Micro SD Card

Your handheld computer has a Micro SD card slot for storage expansion. The Micro SD card slot supports SDHC format, which supports card capacity up to 32 GB.

The card slots are located at the bottom-right side of your handheld computer. To remove the card slot cover, please use a slot head screwdriver or a suitable sized coin. Turn counterclockwise to unlock.

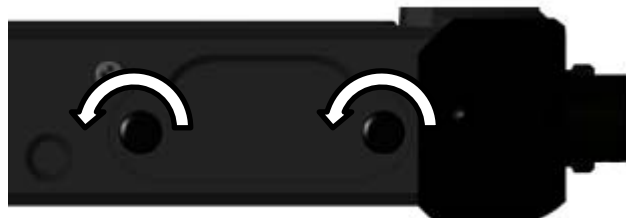

The micro SD card slot is located at the bottom side.

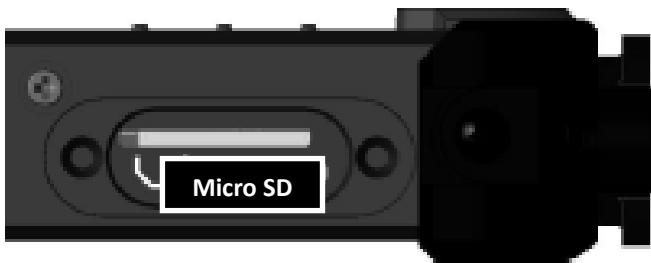

Note:

Image shown with LCD facing down

Please take note of the card slot differences to prevent insertion of incompatible card types, and do not attempt to force the cards into wrong card slots to prevent damage to your handheld computer.

The design of micro SD card slots are foolproof; if you encounter difficulty in inserting the cards, please turn/reverse the cards and try again. When insert micro SD card, the connector pins of your cards should be **facing the center** (the white bar in the image above).

Inserting Micro SD Card

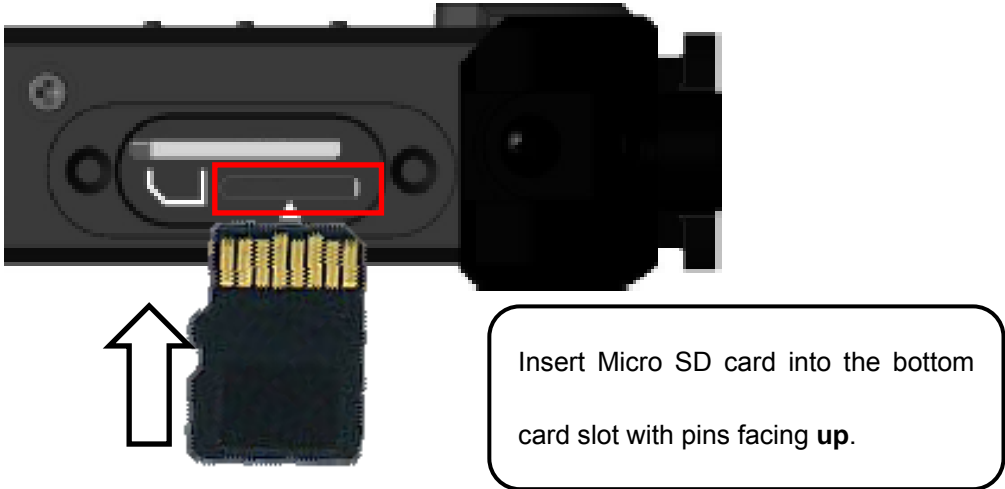

Removing Micro SD Card

To remove micro SD card, it is suggested to safely remove it by *Tap Menu key*  => *Settings => Storage => Unmount SD card*, as the following illustration shows.

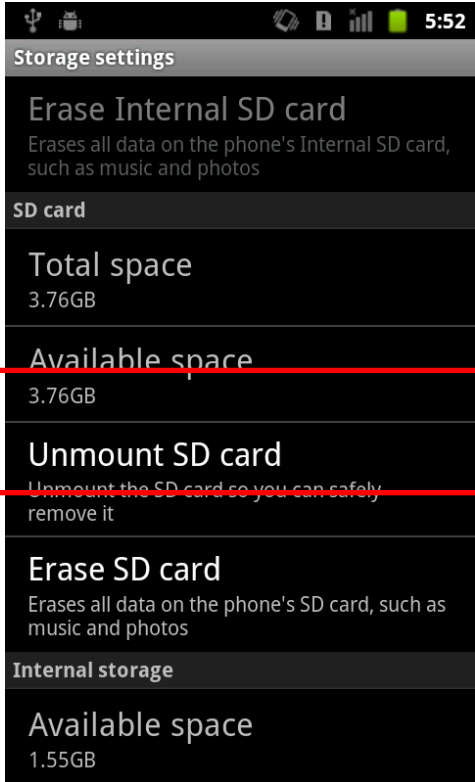

Note:

- *Do not have a sudden removal of SD cards when the device is turned on. Such an action may cause data loss.*

Device Connectivity

For your ease of operations, you can turn on/off your wireless devices through Setting Menu. The following image is an example of wireless and networks connection.

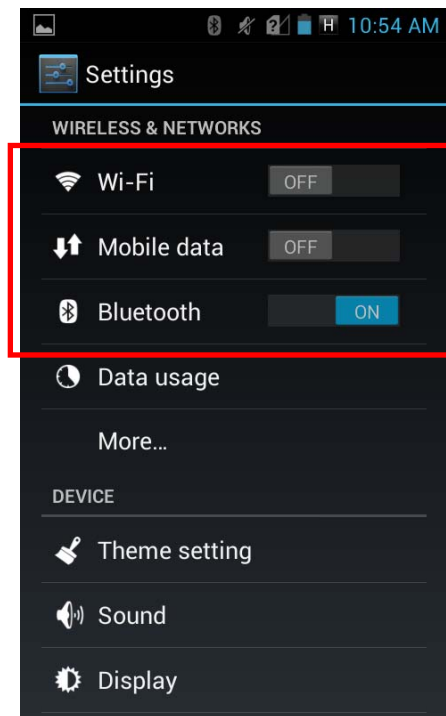

Wi-Fi (Option)

Wi-Fi is an optional wireless communication module for your handheld computer for Wi-Fi connectivity. The Wi-Fi module of your handheld computer supports IEEE 802.11 b/g/n. To activate your Wi-Fi function, please follow the steps below:

1. Tap the Setting icon .

2. Swipe the bar to the ON position to turn on WLAN connection.

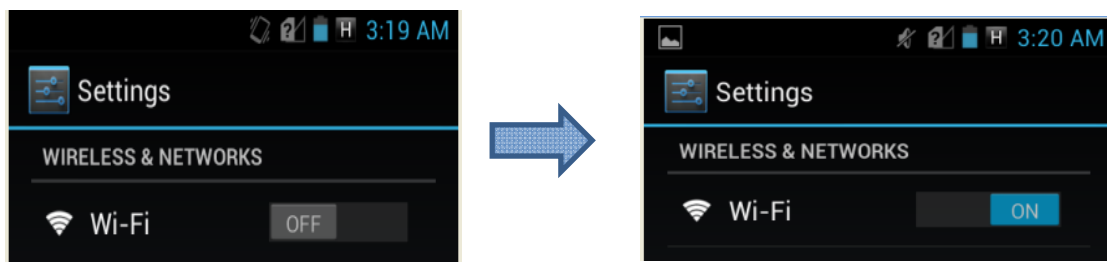

3. Establish Wi-Fi Connections

You may have to insert passwords to set up and enable the connection.

Bluetooth (Option)

A Class 2, Bluetooth® v2.1 + EDR system with A2DP is an optional device for your handheld computer. This module is backward compatible with v1.1/1.2/2.0 devices and provides your handheld computer with a short-range wireless communication protocol to connect with other compatible devices. To activate your Bluetooth functions, please follow the instructions below.

1. Tap the Setting icon .

2. Tap Bluetooth to turn on the function.

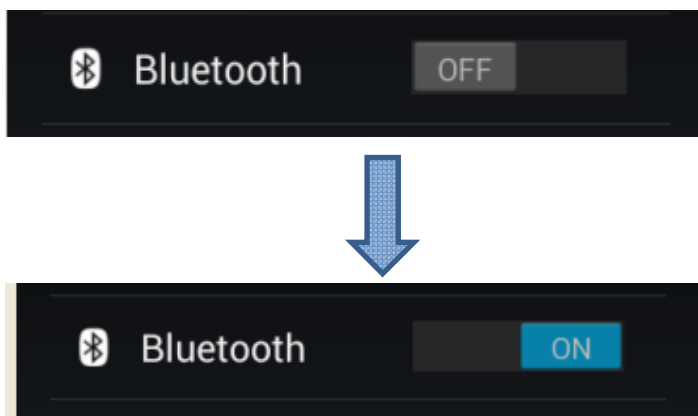

3. Establish Bluetooth Connections

The device can normally scan the devices that can be paired. However, you can manage which device you want to pair or the discoverability of your device.

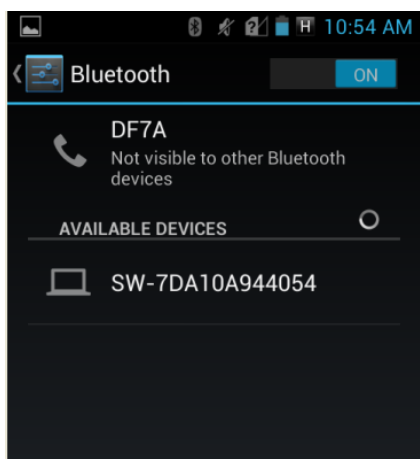

GPS (Option)

GPS is an optional module for your handheld computer. The GPS module allows you to locate your position through satellites. To make sure that it can function normally, please use the device outside with a clear view of the sky and do not cover the antenna. To activate your GPS functions, please tap the GPS APP, and the device will search the satellite automatically. Please follow the instructions below.

1. Tap u-center APP.

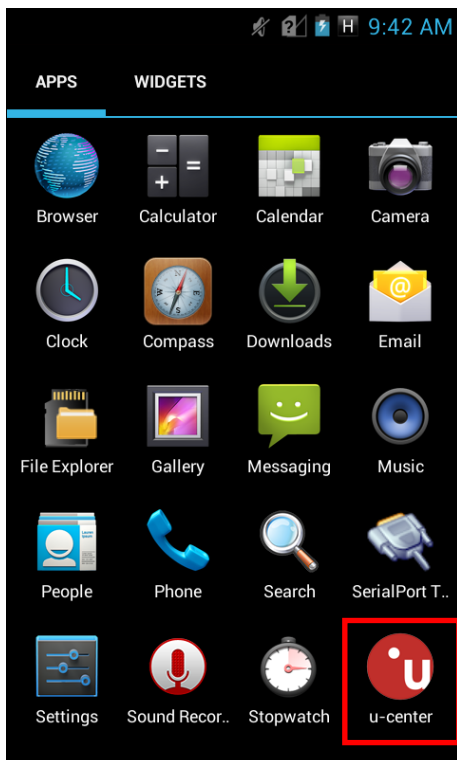

2. The device will search the satellite automatically.

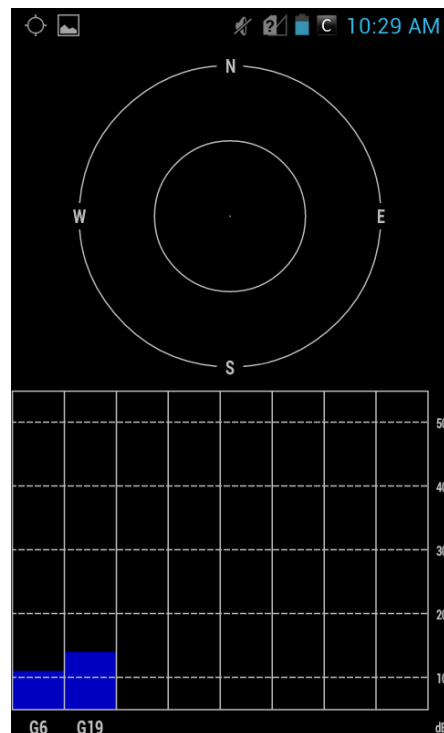

Chapter 3- Managing Power

AC Adapter

The AC adapter performs two functions:

- It powers the computer from an external AC source.
- It charges the computer battery.

The adapter automatically detects the AC line voltage (100V or 240V) and adjusts accordingly.

The following are recommended when using the AC adapter:

- Use a properly grounded AC outlet.
- Use one AC outlet exclusively for the computer. Having other appliances on the same line may cause interference.
- Use a power strip with built-in surge protection.

Connecting the AC adapter:

Standard:

- Insert the end of micro USB to the micro USB client.
- Connect the end of the AC cord to the AC adapter.
- Plug the AC cord into an electrical outlet.

Optional:

- Insert the end of LEMO to the LEMO CONN.
- Connect the end of the AC cord to the AC adapter.
- Plug the AC cord into an electrical outlet.

Please see the following illustrations for the connection of AC adapters.

AC Adapter Indicator:

The green LED indicates that AC power is ready.

Standard: LEMO Conn.

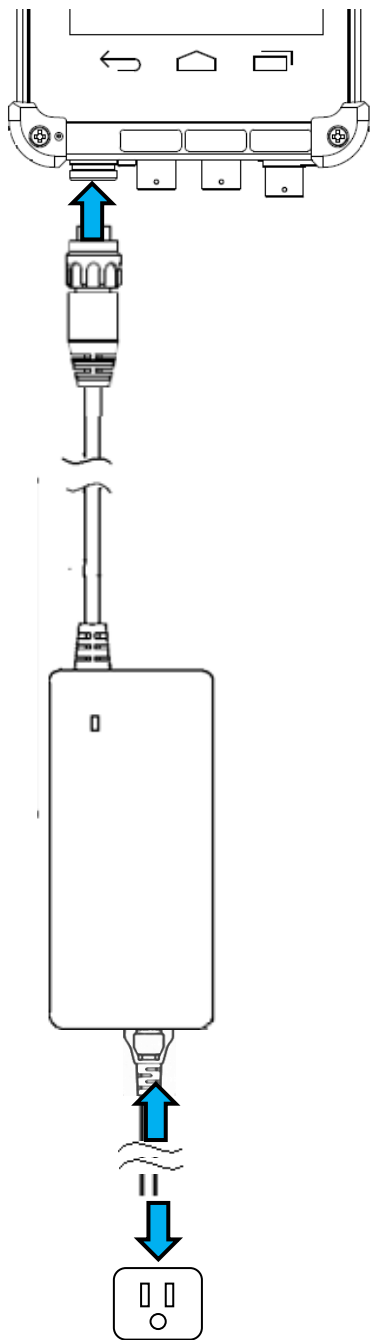

Optional: Micro USB Conn.

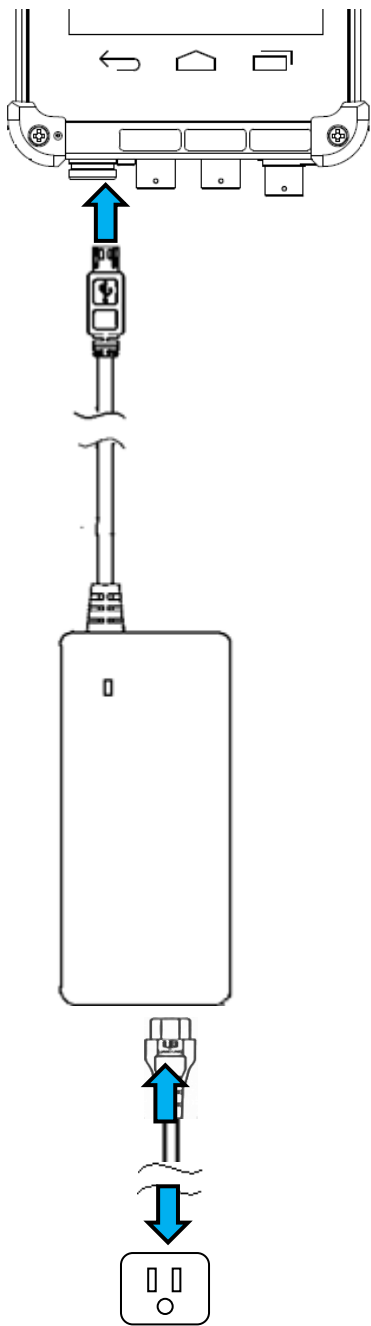

Note:

- To ensure system stability, please connect your computer to an external power source when operating at -20 °C ambient temperature.

Battery

The power source of your handheld computer will automatically switch to battery when external power source (such as AC adapter or optional vehicle adapter) is disconnected. The following section provides battery related information, operation, as well as power-saving tips.

Battery Low

When the battery is nearly exhausted, “Battery Low” warning message will be shown. Once the Battery Low warning occurs, please:

- Save and close the files you are currently working on
- Plug in the USB AC adapter to recharge the battery

Charging the Battery

Plug in the AC adapter (or optional vehicle adapter) to start battery charging. If the battery is at full capacity, the internal sensing circuitry will stop high current charge within several minutes.

Battery Gauge

For checking battery status, please do the following step:

Tap Settings => About phone => Status

Then, the remainig

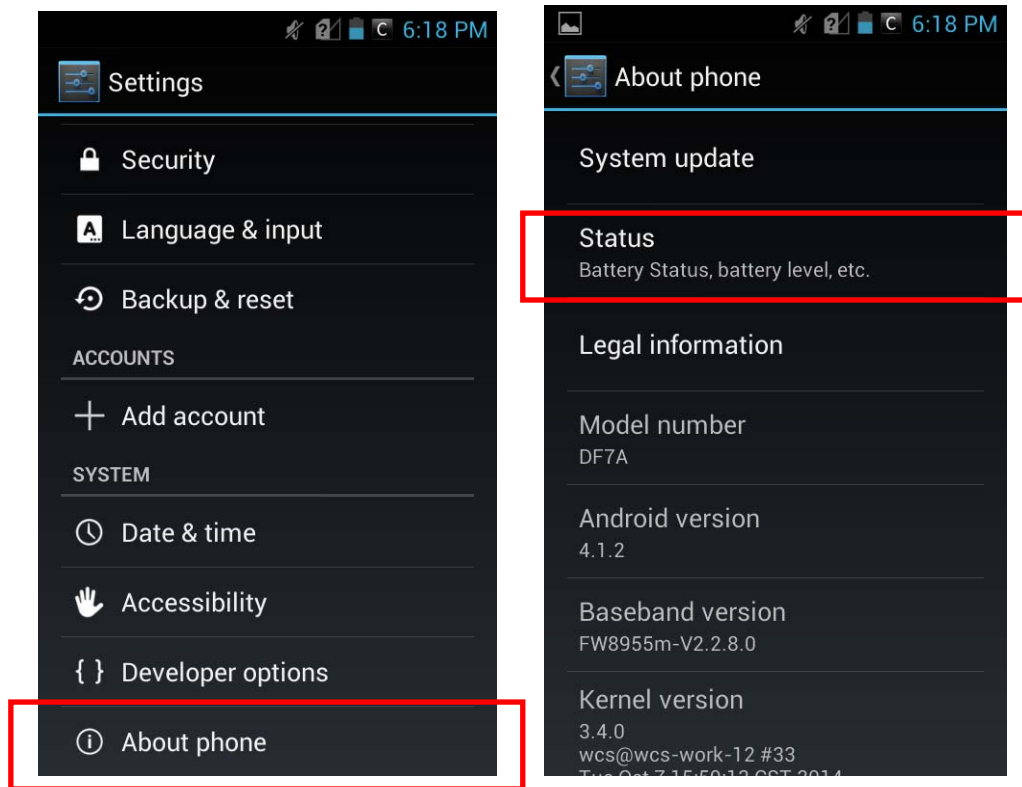

Battery Power Saving Tips

You may extend the battery life of your handheld computer by:

- Lower the LCD display brightness using backlight control.
- Put your device into lock by pressing the power button to conserve battery life.
- Power off the handheld computer when the device will not be used for an extended period of time.

Changing Battery

When the battery is nearly exhausted, you can continue operation by either connecting your handheld computer to an external power source (such as AC adapter), or replacing the battery.

Note:

- *Always remember to turn OFF the power of your handheld computer before changing the battery.*

Chapter 4- Specifications

Processor

- Qualcomm MSM8225Q™
- Quad-Core Cortex™-A5 1.2GHz

Memory

- RAM: 1GB Mobile RAM
- ROM: 8 GB

External Storage

Micro SD Card (support SDHC up to 32G)

OS

Android 4.1.2 (Jelly Bean)

Audio

- Mono Speaker (Back Side)
- Built-in Microphone for sound recording
- Receiver
- Headset

Display

- 5" WVGA (480 x 800 pixel) with LED B/L
- Capacitive Multi Touch +Sunlight Readable screen
- Anti-glare screen treatments
- Optical bonding
- Brightness (min.~typ.): 320~384 nits

Wireless Communication Devices

- IEEE 802.11b/g/n Wi-Fi (2.4GHz)
- Bluetooth 2.1/3.0 support A2DP
- Optional GPS ublox Neo-M8N

I/O Ports

Right:

- Micro SD card slot
- Optional Expansion POGO 20 pin (L3)

Left:

Optional Cradle POGO 20 pin (L4)

Top:

- Optional SMA ANT.

Bottom:

- DC-in/USB client:
 - Standard: Sealed DC-in 5V with LEMO Conn. (8 pin)
 - Optional: Sealed Micro USB
- L5: Optional Sealed Fischer Connector L5-1~L5-3 .

Choose 1 out of 5 for each connector

- RS232 x 1
- USB x 1
- 100M LAN x 1
- Headset x 1
- VGA x 1

Note:

- *For sealed fischer connectors, each function can only be chosen once.*
- *Connectors are no foolproof design.*
- *L3, L4, L5 trade-off with each other.*

Battery

- 3.7V 3520 mAh Lithium-ion Battery (BD61A)
- 4.5 hours Battery life (Depends on your usage and device settings)

Double Capacity Battery (Option)

- 3.7V, 7040mAh Li-ion battery pack (BD61B)
- 9 hours Battery life (Depends on your usage and device settings)

20W AC Adapter

- Input: AC 100V-240V 50/60 Hz
- Output: 5V/4A

Dimensions & Weight

- 169 mm (W) x 90 mm (D) x 23 mm (H) (w/o bumpers)
- Weight: 420 g (Weight varies by configuration and manufacturing process)

Case Materials and Color

Antenna Cover:	Recyclable UL grade PC + ABS GE C2800 or C6200
Body:	Magnesium Alloy AZ91D + Recyclable UL grade PC + ABS GE C2800 or C6200
Buttons:	Silicon Rubber
PCB:	FR-4, UL 94V-0
Battery:	Rechargeable Lithium Ion (Electrochemistry system: $\text{LiCoO}_2 + \text{C} = \text{Li}_1\text{-XCoO}_2 + \text{CLiX}$)
Packing:	Carton: Recycled/Recyclable Paper (unbleached) Cushion: Recyclable EPE Carrying Bag: Recyclable PE Fiber Quick Guide: Recycled/Recyclable Paper
Color:	Black

Certification

- CE
- FCC
- WEEE
- REACH
- IP66
- MIL-STD-810G
- MIL-STD-461F

Accessories

- 20W AC Adapter
- 1M USB Cable (LEMO 8p to USB)
- Optional Carry Bag (Same as DB6)
- Optional 1M USB Cable (Micro USB to USB)
- Optional 1M VGA Test Cable (Fischer 9p to DB15)
- Optional 1M RS232 Test Cable (Fischer 9p to DB9)
- Optional 1M MLAN Test Cable (Fischer 5p to RJ45)
- Optional 20cm USB Test Cable (Fischer 5p to USB)
- Optional 10cm Headset Test Cable (Fischer 5p to Audio Jack 3.5Φ)

Multi-Charger MCDF (Option)**INDICATORS AND PORTS**

- Indicators:
- Power Indicator: Show green light when attaching 90W AC Adapter.
- Charger Indicator: Show orange light when charging battery, or OFF for fully charged.
- Battery Charging Ports x 4
- Applicable Batteries:
 - BD61A: 3.7V, 3520mAh Li-ion battery pack
 - BD61B: 3.7V, 7040mAh Li-ion battery pack

PHYSICAL CHARACTERISTICS

- Dimension: 250(L) x 250(W) x 132(H) mm
- Weight: 795 g

ELECTRONIC CHARACTERISTICS

- DC Input Range: 12 ~ 32V
- DC Power Jack: DC-in 2-pin
- Charging Time:
 - 3 hours for BD61A
 - 7~8 hours for BD61B

CE/FCC Certified**ENVIRONMENTAL RATINGS**

- Battery Charging Temperature: 0 ~ 40 °C

Chapter 5 - Maintenance and Service

Cleaning

ALWAYS turn off the power, unplug the power cord and remove the battery before cleaning.

The exterior of the device and display may be wiped with a clean, soft, and lint-free cloth. If there is difficulty removing dirt, apply non-ammonia, non-alcohol based glass cleaner to the cloth and wipe clean.

An air gun is recommended for cleaning water and dust. For salty water please clean with fresh water then blow-dry with an air gun. Be sure not to turn the computer up-side down while there is water being applied.

Troubleshooting

Should the computer fail to function properly, this section presents common problems and the solutions. If troubleshooting solutions are unsuccessful, please refer to RMA Service section below.

Power Problems

Power Problems	<p>When I turn on the Handheld computer, it does not respond.</p> <ul style="list-style-type: none"> - If you are using battery power, check if the battery is charged - If you are using AC power, ensure that the connection of AC adapter is correct. <p>I cannot return from Hibernation while on battery power</p> <ul style="list-style-type: none"> - The battery might be drained. Please plug the Handheld into AC power.
-----------------------	---

Networking Problems

Wi-Fi	<p>I cannot connect to a wireless Wi-Fi network</p> <ul style="list-style-type: none"> • Make sure that: <ul style="list-style-type: none"> - Your handheld computer is within the range of a wireless access point.. - Check if the Wi-Fi has been turned on.
Bluetooth	<p>I cannot connect to another device with Bluetooth network</p> <ul style="list-style-type: none"> • Ensure that: <ul style="list-style-type: none"> - Both devices have Bluetooth turned on. - The distance between the two devices is not over 10 meters/32 feet and that there are no large obstructions between the devices. - Both devices are compatible.
GPS	<p>I cannot connect to a mobile broadband network</p> <ul style="list-style-type: none"> • Do the following: <ul style="list-style-type: none"> - Check if GPS has been turned on. - If you are outdoors, please move away from buildings or obstructions, and expose your device to open sky. - If you are indoors, please move closer to a window.

RMA Service

1. If troubleshooting steps are unsuccessful, consult your dealer for RMA.
2. Shipping instructions:
3. Remove any personal data.
4. Use the original shipping container and packing materials, if possible.
5. If the original packing materials are not available, wrap the equipment with soft material (e.g. PU/PE form) then put the wrapped equipment into a hard cardboard shipping box.
6. Include a sheet with the following information: (Note: Please keep a copy of this sheet for your records)
 - Name
 - Address
 - Unit serial number
 - Place and date of purchase or the original invoice number
 - Date of failure
7. A DETAILED Description of the problems you have encountered
8. A list of the hardware/software configuration, if applicable.
9. Clearly mark the outside of the shipping box with the RMA #. If RMA # is not present on the shipping box, receiving will be unable to identify it and it might be returned.
10. Unless prior arrangements have been made, the customer is responsible for all shipping costs. Unauthorized use of the company's shipping accounts is not permitted.

Appendix:

Options and CDP (custom design project) for the expansion of your handheld computer

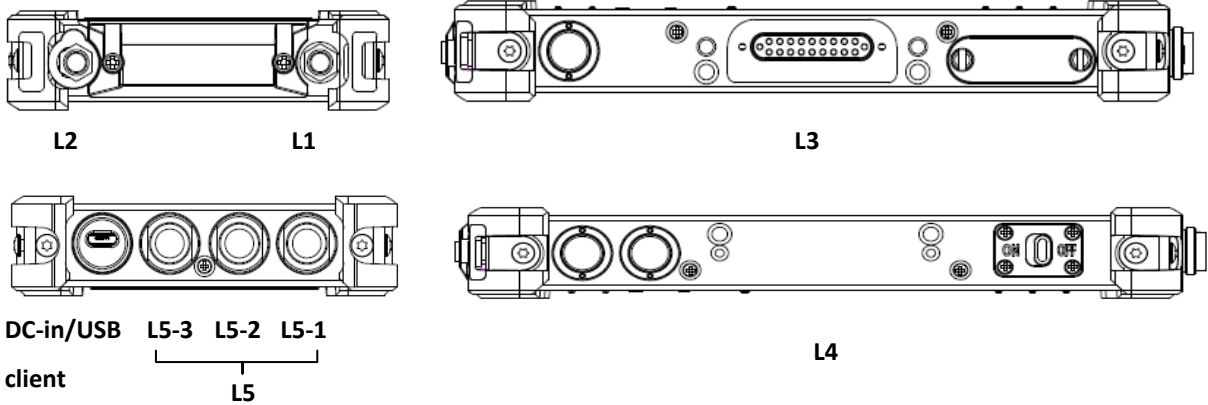

Location	Feature	Functional Description
	DC-in/USB client	<input type="checkbox"/> Standard sealed DC-in 5V with LEMO <input type="checkbox"/> Optional sealed Micro USB
L1	SMA	Select one: <input type="checkbox"/> WiFi & BT <input type="checkbox"/> GPS
L2	SMA	Select one: <input type="checkbox"/> WiFi & BT <input type="checkbox"/> GPS
L3	POGO conn.	<input type="checkbox"/> POGO 20pin
L4	POGO conn.	<input type="checkbox"/> POGO 20pin
L5-1	Fischer connector (8 pin)	The following choices are for L5-1, L5-2, and L5-3 Fischer Connectors. Choose 1 out of 5 for each connector. Note, one function can only be chosen once. <input type="checkbox"/> RS232 <input type="checkbox"/> USB <input type="checkbox"/> 100M LAN <input type="checkbox"/> Headset <input type="checkbox"/> VGA
L5-2	Fischer connector (8 pin)	
L5-3	Fischer connector (8 pin)	

Note:

- *If Fischer Connector is chosen for L5-1, .it will be a little extended than the other two Fischer Connectors, as the following illustration shows.*

