

MILANTM
TECHNOLOGY



48 10/100 Ports
+ 2 Combo SFP Gigabit Ports
+ 2 10/100/1000 Gigabit Ports
Multi-Layer Stackable Management Switch

MIL-SM4804G

Quick Installation Guide

Quick Installation Guide

48 10/100 Ports + 2 Combo SFP + 2 Gigabit Copper Multi-Layer Stackable Management Switch

*Layer 2 Stackable Switch with
50 100BASE-TX (RJ-45) Ports,
and 2 Gigabit Combination Ports (RJ-45/SFP)*

MIL-SM4804G
90000444 REV A

Regulatory Approval

- FCC Class A
- UL 60950
- CSA C22.2 No. 60950
- EN60950
- CE
- EN55022 Class A
- EN55024

Canadian EMI Notice

This Class A digital apparatus meets all the requirements of the Canadian Interference-Causing Equipment Regulations

Cet appareil numérique de la classe A respecte toutes les exigences du Règlement sur le matériel brouilleur du Canada.

European Notice

Products with the CE Marking comply with both the EMC Directive (89/336/EEC) and the Low Voltage Directive (73/23/EEC) issued by the Commission of the European Community. Compliance with these directives imply conformity to the following European Norms:

- EN55022 (CISPR 22) - Radio Frequency Interference
- EN61000-X - Electromagnetic Immunity
- EN60950 (IEC950) - Product Safety

Five-Year Limited Warranty

MiLAN Technology warrants to the original consumer or purchaser that each of its products, and all components thereof, will be free from defects in material and/or workmanship for a period of five years from the original factory shipment date. Any warranty hereunder is extended to the original consumer or purchaser and is not assignable.

MiLAN Technology makes no express or implied warranties including, but not limited to, any implied warranty of merchantability or fitness for a particular purpose, except as expressly set forth in this warranty. In no event shall MiLAN Technology be liable for incidental or consequential damages, costs, or expenses arising out of or in connection with the performance of the product delivered hereunder.

MiLAN Technology will in no case cover damages arising out of the product being used in a negligent fashion or manner.

Trademarks

The MiLAN logo and MiLAN Technology trademarks are registered trademarks of MiLAN Technology in the United States and/or other countries.

To Contact MiLAN Technology

For prompt response when calling for service information, have the following information ready:

- Product serial number and revision
- Date of purchase
- Vendor or place of purchase

You can reach MiLAN Technology technical support at:

E-mail: support@milan.com
Telephone: +1.408.744.2751
Fax: +1.408.744.2771
MiLAN Technology
1329 Moffett Park Drive
Sunnyvale, CA 94089
United States of America
Telephone: +1.408.744.2775
Fax: +1.408.744.2793
<http://www.milan.com>
info@milan.com

© Copyright 2005 MiLAN Technology P/N: 90000433 Rev. A

Compliances and Safety Warnings

CE Mark Declaration of Conformance for EMI and Safety (EEC)

This information technology equipment complies with the requirements of the Council Directive 89/336/EEC on the Approximation of the laws of the Member States relating to Electromagnetic Compatibility and 73/23/EEC for electrical equipment used within certain voltage limits and the Amendment Directive 93/68/EEC. For the evaluation of the compliance with these Directives, the following standards were applied:

- RFI Emission:
- Limit class A according to EN 55022:1998
 - Limit class A for harmonic current emission according to EN 61000-3-2/1995
 - Limitation of voltage fluctuation and flicker in low-voltage supply system according to EN 61000-3-3/1995
- Immunity:
- Product family standard according to EN 55024:1998
 - Electrostatic Discharge according to EN 61000-4-2:1995 (Contact Discharge: ± 4 kV, Air Discharge: ± 8 kV)
 - Radio-frequency electromagnetic field according to EN 61000-4-3:1996 (80 - 1000 MHz with 1 kHz AM 80% Modulation: 3 V/m)
 - Electrical fast transient/burst according to EN 61000-4-4:1995 (AC/DC power supply: ± 1 kV, Data/Signal lines: ± 0.5 kV)
 - Surge immunity test according to EN 61000-4-5:1995 (AC/DC Line to Line: ± 1 kV, AC/DC Line to Earth: ± 2 kV)
 - Immunity to conducted disturbances, Induced by radio-frequency fields: EN 61000-4-6:1996 (0.15 - 80 MHz with 1 kHz AM 80% Modulation: 3 V/m)
 - Power frequency magnetic field immunity test according to EN 61000-4-8:1993 (1 A/m at frequency 50 Hz)
 - Voltage dips, short interruptions and voltage variations immunity test according to EN 61000-4-11:1994 (>95% Reduction @10 ms, 30% Reduction @500 ms, >95% Reduction @5000 ms)
- LVD:
- EN 60950-1:2001

Caution: Do not plug a phone jack connector in the RJ-45 port. This may damage this device.

Attention: Les raccordeurs ne sont pas utilisés pour le système téléphonique!

Safety Compliance

Warning: Fiber Optic Port Safety

**CLASS I
LASER DEVICE**

When using a fiber optic port, never look at the transmit laser while it is powered on. Also, never look directly at the fiber TX port and fiber cable ends when they are powered on.

Avertissement: Ports pour fibres optiques - sécurité sur le plan optique

**DISPOSITIF LASER
DE CLASSE I**

Ne regardez jamais le laser tant qu'il est sous tension. Ne regardez jamais directement le port TX (Transmission) à fibres optiques et les embouts de câbles à fibres optiques tant qu'ils sont sous tension.

Warnhinweis: Faseroptikanschlüsse - Optische Sicherheit

**LASERGERÄT
DER KLASSE I**

Niemals ein Übertragungslaser betrachten, während dieses eingeschaltet ist. Niemals direkt auf den Faser-TX-Anschluß und auf die Faserkabelenden schauen, während diese eingeschaltet sind.

Please read the following safety information carefully before installing the switch:

WARNING: Installation and removal of the unit must be carried out by qualified personnel only.

- The unit must be connected to an earthed (grounded) outlet to comply with international safety standards.
- Do not connect the unit to an A.C. outlet (power supply) without an earth (ground) connection.
- The appliance coupler (the connector to the unit and not the wall plug) must have a configuration for mating with an EN 60320/IEC 320 appliance inlet.
- The socket outlet must be near to the unit and easily accessible. You can only remove power from the unit by disconnecting the power cord from the outlet.
- This unit operates under SELV (Safety Extra Low Voltage) conditions according to IEC 60950. The conditions are only maintained if the equipment to which it is connected also operates under SELV conditions.

France and Peru only

This unit cannot be powered from IT† supplies. If your supplies are of IT type, this unit must be powered by 230 V (2P+T) via an isolation transformer ratio 1:1, with the secondary connection point labelled Neutral, connected directly to earth (ground).

† Impédance à la terre

Power Cord Set	
U.S.A. and Canada	The cord set must be UL-approved and CSA certified.
	The minimum specifications for the flexible cord are: - No. 18 AWG - not longer than 2 meters, or 16 AWG. - Type SV or SJ - 3-conductor
	The cord set must have a rated current capacity of at least 10 A
	The attachment plug must be an earth-grounding type with NEMA 5-15P (15 A, 125 V) or NEMA 6-15P (15 A, 250 V) configuration.
Denmark	The supply plug must comply with Section 107-2-D1, Standard DK2-1a or DK2-5a.
Switzerland	The supply plug must comply with SEV/ASE 1011.
U.K.	The supply plug must comply with BS1363 (3-pin 13 A) and be fitted with a 5 A fuse which complies with BS1362.
	The mains cord must be <HAR> or <BASEC> marked and be of type HO3VVF3GO.75 (minimum).
Europe	The supply plug must comply with CEE7/7 ("SCHUKO").
	The mains cord must be <HAR> or <BASEC> marked and be of type HO3VVF3GO.75 (minimum).
	IEC-320 receptacle.

Veillez lire à fond l'information de la sécurité suivante avant d'installer le Switch:

AVERTISSEMENT: L'installation et la dépose de ce groupe doivent être confiés à un personnel qualifié.

- Ne branchez pas votre appareil sur une prise secteur (alimentation électrique) lorsqu'il n'y a pas de connexion de mise à la terre (mise à la masse).
- Vous devez raccorder ce groupe à une sortie mise à la terre (mise à la masse) afin de respecter les normes internationales de sécurité.
- Le coupleur d'appareil (le connecteur du groupe et non pas la prise murale) doit respecter une configuration qui permet un branchement sur une entrée d'appareil EN 60320/IEC 320.
- La prise secteur doit se trouver à proximité de l'appareil et son accès doit être facile. Vous ne pouvez mettre l'appareil hors circuit qu'en débranchant son cordon électrique au niveau de cette prise.
- L'appareil fonctionne à une tension extrêmement basse de sécurité qui est conforme à la norme IEC 60950. Ces conditions ne sont maintenues que si l'équipement auquel il est raccordé fonctionne dans les mêmes conditions.

France et Pérou uniquement:

Ce groupe ne peut pas être alimenté par un dispositif à impédance à la terre. Si vos alimentations sont du type impédance à la terre, ce groupe doit être alimenté par une tension de 230 V (2 P+T) par le biais d'un transformateur d'isolement à rapport 1:1, avec un point secondaire de connexion portant l'appellation Neutre et avec raccordement direct à la terre (masse).

Cordon électrique - Il doit être agréé dans le pays d'utilisation	
Etats-Unis et Canada:	Le cordon doit avoir reçu l'homologation des UL et un certificat de la CSA.
	Les spécifications minimales pour un câble flexible sont AWG No. 18, ou AWG No. 16 pour un câble de longueur inférieure à 2 mètres. - type SV ou SJ - 3 conducteurs
	Le cordon doit être en mesure d'acheminer un courant nominal d'au moins 10 A.
	La prise femelle de branchement doit être du type à mise à la terre (mise à la masse) et respecter la configuration NEMA 5-15P (15 A, 125 V) ou NEMA 6-15P (15 A, 250 V).
Danemark:	La prise mâle d'alimentation doit respecter la section 107-2 D1 de la norme DK2 1a ou DK2 5a.
Suisse:	La prise mâle d'alimentation doit respecter la norme SEV/ASE 1011.
Europe	La prise secteur doit être conforme aux normes CEE 7/7 ("SCHUKO") LE cordon secteur doit porter la mention <HAR> ou <BASEC> et doit être de type HO3VVF3GO.75 (minimum).

Bitte unbedingt vor dem Einbauen des Switches die folgenden Sicherheitsanweisungen durchlesen:

WARNUNG: Die Installation und der Ausbau des Geräts darf nur durch Fachpersonal erfolgen.

- Das Gerät sollte nicht an eine ungeerdete Wechselstromsteckdose angeschlossen werden.
- Das Gerät muß an eine geerdete Steckdose angeschlossen werden, welche die internationalen Sicherheitsnormen erfüllt.
- Der Gerätestecker (der Anschluß an das Gerät, nicht der Wandsteckdosenstecker) muß einen gemäß EN 60320/IEC 320 konfigurierten Geräteeingang haben.
- Die Netzsteckdose muß in der Nähe des Geräts und leicht zugänglich sein. Die Stromversorgung des Geräts kann nur durch Herausziehen des Gerätenetzkabels aus der Netzsteckdose unterbrochen werden.
- Der Betrieb dieses Geräts erfolgt unter den SELV-Bedingungen (Sicherheitskleinstspannung) gemäß IEC 60950. Diese Bedingungen sind nur gegeben, wenn auch die an das Gerät angeschlossenen Geräte unter SELV-Bedingungen betrieben werden.

Stromkabel. Dies muss von dem Land, in dem es benutzt wird geprüft werden:	
Schweiz	Dieser Stromstecker muß die SEV/ASE 1011Bestimmungen einhalten.
Europe	Das Netzkabel muß vom Typ HO3VVVF3GO.75 (Mindestanforderung) sein und die Aufschrift <HAR> oder <BASEC> tragen. Der Netzstecker muß die Norm CEE 7/7 erfüllen ("SCHUKO").

Warnings and Cautionary Messages

- Warning:** This product does not contain any serviceable user parts.
- Warning:** Installation and removal of the unit must be carried out by qualified personnel only.
- Warning:** When connecting this device to a power outlet, connect the field ground lead on the tri-pole power plug to a valid earth ground line to prevent electrical hazards.
- Warning:** This switch uses lasers to transmit signals over fiber optic cable. The lasers are compliant with the requirements of a Class 1 Laser Product and are inherently eye safe in normal operation. However, you should never look directly at a transmit port when it is powered on.
- Caution:** Wear an anti-static wrist strap or take other suitable measures to prevent electrostatic discharge when handling this equipment.
- Caution:** Do not plug a phone jack connector in the RJ-45 port. This may damage this device. Les raccordeurs ne sont pas utilisé pour le système téléphonique!
- Caution:** Use only twisted-pair cables with RJ-45 connectors that conform to FCC standards.

Warnings (in German)

- Achtung:** Dieses Produkt enthält keine Teile, die eine Wartung vom Benutzer benötigen.
- Achtung:** Installation und Deinstallation des Gerätes müssen von qualifiziertem Servicepersonal durchgeführt werden.
- Achtung:** Wenn das Gerät an eine Steckdose angeschlossen wird, muß der Masseanschluß am dreipoligen Netzstecker mit Schutz Erde verbunden werden, um elektrische Gefahren zu vermeiden.
- Achtung:** Dieses Gerät nutzt Laser zur Signalübertragung über Glasfasern. Die Laser entsprechen den Anforderungen an eine Lasereinrichtung der Klasse 1 und sind durch ihre Bauart im normalen Betrieb sicher für die Augen. Trotzdem sollte niemals direkt in den einen Übertragungskanal geblickt werden, wenn er eingeschaltet ist.

Environmental Statement

The manufacturer of this product endeavours to sustain an environmentally-friendly policy throughout the entire production process. This is achieved through the following means:

- Adherence to national legislation and regulations on environmental production standards.
- Conservation of operational resources.
- Waste reduction and safe disposal of all harmful un-recyclable by-products.
- Recycling of all reusable waste content.
- Design of products to maximize recyclables at the end of the product's life span.
- Continual monitoring of safety standards.

End of Product Life Span

This product is manufactured in such a way as to allow for the recovery and disposal of all included electrical components once the product has reached the end of its life.

Manufacturing Materials

There are no hazardous nor ozone-depleting materials in this product.

Documentation

All printed documentation for this product uses biodegradable paper that originates from sustained and managed forests. The inks used in the printing process are non-toxic.

Purpose

This guide details the hardware features of the switch, including its physical and performance-related characteristics, and how to install the switch.

Audience

This guide is for system administrators with a working knowledge of network management. You should be familiar with switching and networking concepts.

Zielgruppe Dieser Anleitung ist fuer Systemadministratoren mit Erfahrung im Netzwerkmanagement. Sie sollten mit Switch- und Netzwerkkonzepten vertraut sein.

Related Publications

The following publication gives specific information on how to operate and use the management functions of the switch:

The *Stackable Fast Ethernet Switch Management Guide*

Also, as part of the switch's firmware, there is an online web-based help that describes all management related features.

Contents

Chapter 1: Introduction	1-1
Overview	1-1
Switch Architecture	1-2
Network Management Options	1-2
Description of Hardware	1-2
10BASE-T/100BASE-TX Ports	1-2
1000BASE-T/SFP Ports	1-3
Stacking Ports	1-4
Port and System Status LEDs	1-5
Power Supply Receptacles	1-7
Features and Benefits	1-7
Connectivity	1-7
Expandability	1-7
Performance	1-8
Management	1-8

Chapter 2: Network Planning	2-1
Introduction to Switching	2-1
Application Examples	2-2
Collapsed Backbone	2-2
Network Aggregation Plan	2-3
Remote Connections with Fiber Cable	2-4
Making VLAN Connections	2-5
Application Notes	2-6

Chapter 3: Installing the Switch	3-1
Selecting a Site	3-1
Ethernet Cabling	3-1
Equipment Checklist	3-2
Package Contents	3-2
Optional Rack-Mounting Equipment	3-2
Mounting	3-3
Rack Mounting	3-3
Desktop or Shelf Mounting	3-5
Installing an Optional SFP Transceiver	3-6
Connecting Switches in a Stack	3-6
Connecting to a Power Source	3-8
Connecting to the Console Port	3-9
Wiring Map for Serial Cable	3-9

Chapter 4: Making Network Connections	4-1
Connecting Network Devices	4-1
Twisted-Pair Devices	4-1
Cabling Guidelines	4-1
Connecting to PCs, Servers, Hubs and Switches	4-2
Network Wiring Connections	4-2
Fiber Optic SFP Devices	4-4
Connectivity Rules	4-5
1000BASE-T Cable Requirements	4-5
1000 Mbps Gigabit Ethernet Collision Domain	4-6
100 Mbps Fast Ethernet Collision Domain	4-6
10 Mbps Ethernet Collision Domain	4-6
Cable Labeling and Connection Records	4-7

Appendix A: Troubleshooting A-1

Diagnosing Switch Indicators	A-1
Diagnosing Power Problems with the LEDs	A-1
Power and Cooling Problems	A-2
Installation	A-2
In-Band Access	A-2
Stack Troubleshooting	A-2

Appendix B: Cables B-1

Twisted-Pair Cable and Pin Assignments	B-1
10BASE-T/100BASE-TX Pin Assignments	B-1
Straight-Through Wiring	B-2
Crossover Wiring	B-2
1000BASE-T Pin Assignments	B-3
Fiber Standards	B-4

Appendix C: Specifications C-1

Switch Features	C-2
Management Features	C-2
Standards	C-3
Compliances	C-3

Glossary**Index**

Tables

Table 1-1	Port Status LEDs	1-5
Table 1-2	System Status LEDs	1-6
Table 3-1	Serial Cable Wiring	3-9
Table 4-1	Maximum 1000BASE-T Gigabit Ethernet Cable Length	4-6
Table 4-2	Maximum 1000BASE-SX Gigabit Ethernet Cable Lengths	4-6
Table 4-3	Maximum 1000BASE-LX Gigabit Ethernet Cable Length	4-6
Table 4-4	Maximum 1000BASE-LH Gigabit Ethernet Cable Length	4-6
Table 4-5	Maximum Fast Ethernet Cable Length	4-6
Table 4-6	Maximum Ethernet Cable Length	4-6
Table A-1	Troubleshooting Chart	A-1
Table A-2	Power/RPS LEDs	A-1
Table B-1	10/100BASE-TX MDI and MDI-X Port Pinouts	B-2
Table B-2	1000BASE-T MDI and MDI-X Port Pinouts	B-3

Figures

Figure 1-1	Front and Rear Panels	1-1
Figure 1-2	Stacking Ports	1-4
Figure 1-3	Port LEDs	1-5
Figure 1-4	System LEDs	1-6
Figure 1-5	Power Supply Receptacles	1-7
Figure 2-1	Collapsed Backbone	2-2
Figure 2-2	Network Aggregation Plan	2-3
Figure 2-3	Remote Connections with Fiber Cable	2-4
Figure 2-4	Making VLAN Connections	2-5
Figure 3-1	RJ-45 Connections	3-2
Figure 3-2	Attaching the Brackets	3-3
Figure 3-3	Installing the Switch in a Rack	3-4
Figure 3-4	Attaching the Adhesive Feet	3-5
Figure 3-5	Installing an SFP Transceiver into a slot	3-6
Figure 3-6	Connecting Switches in a Ring-topology Stack	3-7
Figure 3-7	Power Receptacles	3-8
Figure 3-8	Serial Port (DB-9 DTE) Pin-Out	3-9
Figure 4-1	Making Twisted-Pair Connections	4-2
Figure 4-2	Network Wiring Connections	4-3
Figure 4-3	Making Fiber Port Connections	4-5
Figure B-1	RJ-45 Connector Pin Numbers	B-1
Figure B-2	Straight-through Wiring	B-2
Figure B-3	Crossover Wiring	B-3

Chapter 1: Introduction

Overview

The MIL-SM4804G switch is a stackable Fast Ethernet switch with 48 10BASE-T/100BASE-TX ports, and two 1000BASE-T ports¹ that operate in combination with two Small Form Factor Pluggable (SFP) transceiver slots. These switches also provide two 1 Gbps built-in stacking ports for connecting up to four MIL-SM4804G units in a stack. The stacking ports can also be used as normal Ethernet ports in standalone mode. The switch also includes an SNMP-based management agent, which provides both in-band and out-of-band access for managing the switch.

The MIL-SM4804G provides a broad range of powerful features for Layer 2 switching, delivering reliability and consistent performance for your network traffic. They bring order to poorly performing networks by segregating them into separate broadcast domains with IEEE 802.3Q compliant VLANs, and empowers multimedia applications with multicast switching and CoS services.

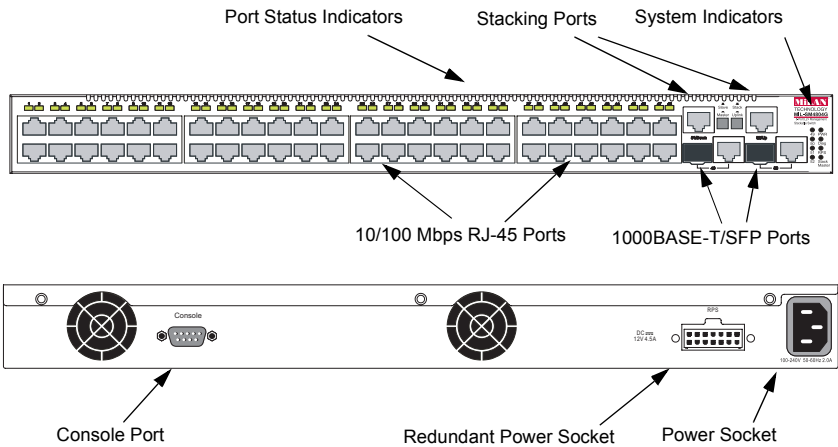

Figure 1-1 Front and Rear Panels

1. If an SFP transceiver is plugged in, the corresponding RJ-45 port (25-26 or 49-50) is disabled.

Switch Architecture

The MIL-SM4804G employs a wire-speed, non-blocking switching fabric². This permits simultaneous wire-speed transport of multiple packets at low latency on all ports. The switches also features full-duplex capability on all ports, which effectively doubles the bandwidth of each connection.

The switches uses store-and-forward switching to ensure maximum data integrity. With store-and-forward switching, the entire packet must be received into a buffer and checked for validity before being forwarded. This prevents errors from being propagated throughout the network.

The switches include built-in stacking ports that allow multiple units to connected together through a 4 Gbps stack backplane. The switch stack can be managed from a master unit using a single IP address.

Network Management Options

With a comprehensive array of LEDs, the MIL-SM4804G switch provides “at a glance” monitoring of network and port status. The switches can be managed over the network with a web browser or Telnet application, or via a direct connection to the console port. The switches includes a built-in network management agent that allows them to be managed in-band using SNMP or RMON (Groups 1, 2, 3, 9) protocols. They also have an RS-232 serial port (DB-9 connector) on the front panel for out-of-band management. A PC may be connected to this port for configuration and monitoring out-of-band via a null-modem serial cable. (See Appendix B for wiring options.)

For a detailed description of the advanced features, refer to the Management Guide.

Description of Hardware

10BASE-T/100BASE-TX Ports

The MIL-SM4804G switch contains 48 10BASE-T/100BASE-TX RJ-45 ports. All ports support automatic MDI/MDI-X operation, so you can use straight-through cables for all network connections to PCs or servers, or to other switches or hubs. (See “10BASE-T/100BASE-TX Pin Assignments” on page B-1.)

Each of these ports support auto-negotiation, so the optimum transmission mode (half or full duplex), and data rate (10 or 100 Mbps) can be selected automatically. If a device connected to one of these ports does not support auto-negotiation, the communication mode of that port can be configured manually.

2. Non-blocking switching is used for traffic crossing ports attached to the same switch ASIC; while blocking is employed for traffic passing between different switch chips. The MIL-SM4804G has two switch chips – ASIC#1: Ports 1-12, 25-36, 49, 51 and ASIC#2: Ports 13-24, 37-48, 50, 52.

Each port also supports IEEE 802.3x auto-negotiation of flow control³, so the switch can automatically prevent port buffers from becoming saturated.

1000BASE-T/SFP Ports

These are combination Gigabit RJ-45 ports with shared Small Form Factor Pluggable (SFP) transceiver slots (See Figure 1-1, Ports 25-26/49-50). If an SFP transceiver (purchased separately) is installed in a slot and has a valid link on the port, the associated RJ-45 port is disabled.

The 1000BASE-T RJ-45 ports support automatic MDI/MDI-X operation, so you can use straight-through cables for all network connections to PCs or servers, or to other switches or hubs. (See “1000BASE-T Pin Assignments” on page B-3.)

3. Flow control is only supported for ports attached to the same switch ASIC. The MIL-SM4804G has two switch chips— ASIC#1: Ports 1-12, 25-36, 49, 51 and ASIC#2: Ports 13-24, 37-48, 50, 52.

Stacking Ports

The unit provides two stacking ports that provide a 4 Gbps stack backplane connection. You can stack up to four MIL-SM4804G units using Category 5 Ethernet cables (purchased separately). The Master button enables one switch in the stack to be selected as the master. This is the unit through which you manage the entire stack.

The stacking ports can also be used as normal Ethernet ports in standalone mode by pressing the Uplink button.

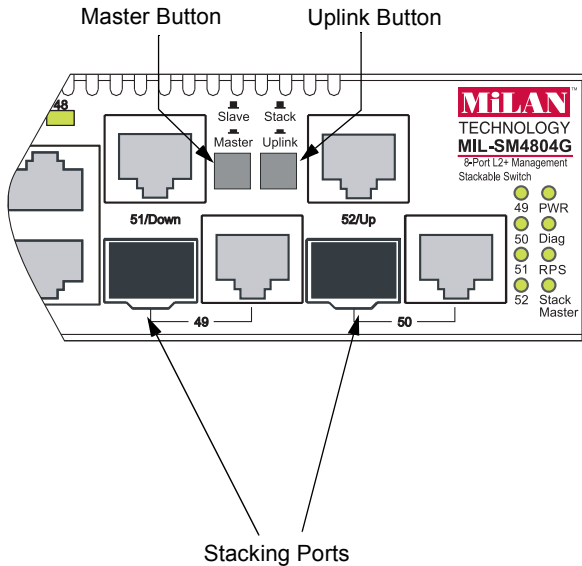

Figure 1-2 Stacking Ports

Port and System Status LEDs

The MIL-SM4804G includes a display panel for key system and port indications that simplify installation and network troubleshooting. The LEDs, which are located on the front panel for easy viewing, are shown below and described in the following tables.

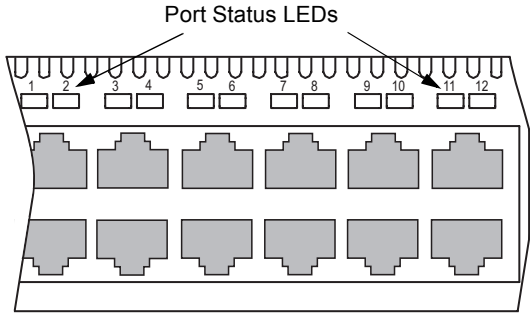

Figure 1-3 Port LEDs

Table 1-1 Port Status LEDs

LED	Condition	Status
Fast Ethernet Ports MIL-SM4804G: Ports 1-48		
(Link/Activity)	On/Flashing Amber	Port has established a valid 10 Mbps network connection. Flashing indicates activity.
	On/Flashing Green	Port has established a valid 100 Mbps network connection. Flashing indicates activity.
	Off	There is no valid link on the port.
	Flashing Green	When the "light unit" command is entered in the Command Line Interface, the LED corresponding to the switch's ID will flash for about 15 seconds.
Gigabit Ethernet Ports MIL-SM4804G: Ports 49-50, and Ports 51-52 when stacking is not implemented		
(Link/Activity)	On/Flashing Amber	Port has established a valid 10/100 Mbps network connection. Flashing indicates activity.
	On/Flashing Green	Port has established a valid 1000 Mbps network connection. Flashing indicates activity.
	Off	There is no valid link on the port.

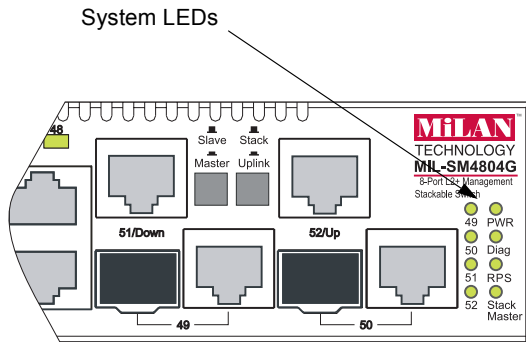

Table 1-2 System Status LEDs

LED	Condition	Status
PWR	On Green	The unit's internal power supply is operating normally.
	On Amber	The unit's internal power supply has failed.
	Off	The unit has no power connected.
Diag	On Green	The system diagnostic test has completed successfully.
	Flashing Green	The system diagnostic test is in progress.
	On Amber	The system diagnostic test has detected a fault.
RPS	Green	A redundant power supply is attached and is active.
	Amber	A redundant power supply is attached but not active.
	Off	There is no redundant power supply currently attached.
Stack Master	Flashing Amber	An initial power-on state during which the stack configuration is detected.
	Green	This switch is acting as the Master unit in the stack.
	Amber	This switch is acting as a Slave unit in the stack.
	Off	Switch is operating in standalone mode.

Power Supply Receptacles

There are two power receptacles on the rear panel of the switch. The standard power receptacle is for the AC power cord. The receptacle labeled “RPS” is for the optional Redundant Power Supply (RPS).

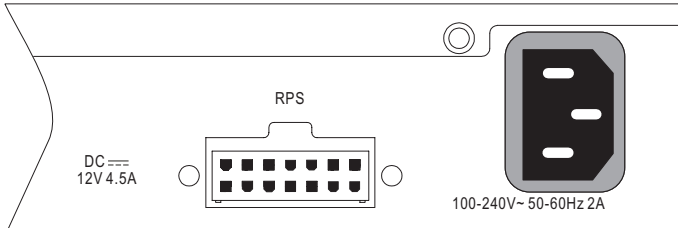

Figure 1-5 Power Supply Receptacles

Features and Benefits

Connectivity

- 48 (MIL-SM4804G) 100BASE-TX ports, 2 1000BASE-T ports, and 2 combination 1000BASE-T/SFP ports for easy integration and for protection of your investment in legacy LAN equipment.
- Auto-negotiation enables each RJ-45 port to automatically select the optimum speed (10, 100 or 1000 Mbps), and the communication mode (half or full duplex) if this feature is supported by the attached device; otherwise the port can be configured manually.
- 100BASE-TX and 1000BASE-T RJ-45 ports support auto MDI/MDI-X pinout configuration.
- Unshielded (UTP) cable supported on all RJ-45 ports: Category 3 or better for 10 Mbps connections, Category 5 or better for 100 Mbps connections, and Category 5, 5e or 6 for 1000 Mbps connections.
- IEEE 802.3-2002 Ethernet, Fast Ethernet, Gigabit Ethernet compliance ensures compatibility with standards-based hubs, network cards and switches from any vendor.
- Provides stacking capability via RJ-45 ports with 4 Gbps stacking bandwidth. You can connect up to four MIL-SM4804G units in a stack.

Expandability

- 2 Small Form Factor Pluggable (SFP) transceiver slots (shared with 1000BASE-T ports)
- Supports 1000BASE-SX, 1000BASE-LX, and 1000BASE-LH SFP transceivers.

Performance

- Transparent bridging
- Aggregate duplex bandwidth of 17.6 Gbps (MIL-SM4804G)
- Switching table with a total of 8K MAC address entries
- Provides store-and-forward switching
- Wire-speed filtering and forwarding
- Supports flow control, using back pressure for half duplex and IEEE 802.3x for full duplex
- Broadcast storm control

Management

- “At-a-glance” LEDs for easy troubleshooting
- Network management agent:
 - Manages switch in-band or out-of-band
 - Supports SSH, Telnet, SNMP, RMON (4 groups) and web-based interface

Chapter 2: Network Planning

Introduction to Switching

A network switch allows simultaneous transmission of multiple packets via non-crossbar switching. This means that it can partition a network more efficiently than bridges or routers. The switch has, therefore, been recognized as one of the most important building blocks for today's networking technology.

When performance bottlenecks are caused by congestion at the network access point (such as the network card for a high-volume file server), the device experiencing congestion (server, power user, or hub) can be attached directly to a switched port. And, by using full-duplex mode, the bandwidth of the dedicated segment can be doubled to maximize throughput.

When networks are based on repeater (hub) technology, the distance between end stations is limited by a maximum hop count. However, a switch turns the hop count back to zero. So subdividing the network into smaller and more manageable segments, and linking them to the larger network by means of a switch, removes this limitation.

A switch can be easily configured in any Ethernet, Fast Ethernet, or Gigabit Ethernet network to significantly boost bandwidth while using conventional cabling and network cards.

Application Examples

The MIL-SM4804G switch is not only designed to segment your network, but also to provide a wide range of options in setting up network connections. Some typical applications are described below.

Collapsed Backbone

The MIL-SM4804G is an excellent choice for mixed Ethernet, Fast Ethernet, and Gigabit Ethernet installations where significant growth is expected in the near future. You can easily build on this basic configuration, adding direct full-duplex connections to workstations or servers. When the time comes for further expansion, just connect to another hub or switch using one of the Fast Ethernet or Gigabit Ethernet ports.

In the figure below, the switch is operating as a collapsed backbone for a small LAN. It is providing dedicated 10 Mbps full-duplex connections to workstations, 100 Mbps full-duplex connections to power users, and 1 Gbps full-duplex connections to servers.

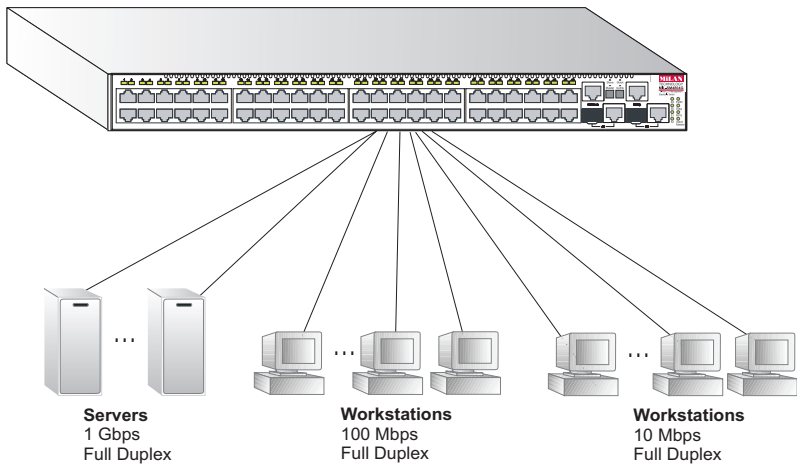

Figure 2-1 Collapsed Backbone

Network Aggregation Plan

When used in standalone mode, the MIL-SM4804G provides 52 parallel bridging ports (i.e., 52 distinct collision domains), which can be used to collapse a complex network down into a single efficient bridged node, increasing overall bandwidth and throughput.

You can stack up to four MIL-SM4804G switch units together, forming a single “virtual” switch containing up to 200 ports. The whole stack can be managed through the Master unit using a single IP address.

In the figure below, the 10BASE-T/100BASE-TX ports on the MIL-SM4804G switch are providing 100 Mbps connectivity for up to 24 segments. In addition, the switch is also connecting several servers at 1000 Mbps.

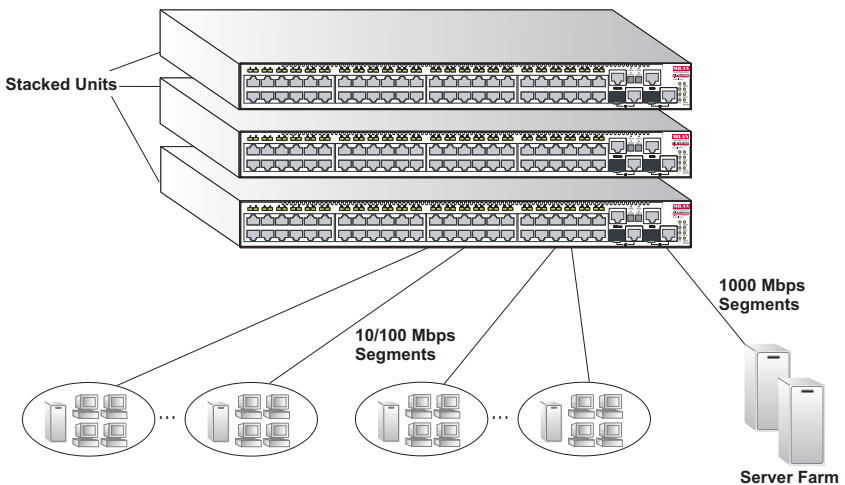

Figure 2-2 Network Aggregation Plan

Remote Connections with Fiber Cable

Fiber optic technology allows for longer cabling than any other media type. A 1000BASE-SX (MMF) link can connect to a site up to 550 meters away, a 1000BASE-LX (SMF) link up to 5 km, and a 1000BASE-LH link up to 70 km. This allows a Gigabit Ethernet Switch to serve as a collapsed backbone, providing direct connectivity for a widespread LAN.

The figure below illustrates this switch connecting multiple segments with fiber cable.

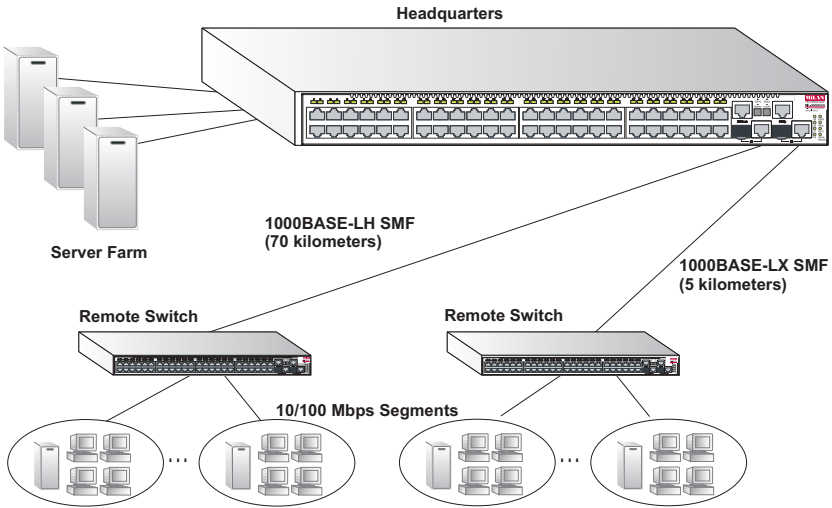

Figure 2-3 Remote Connections with Fiber Cable

Making VLAN Connections

This switch supports VLANs which can be used to organize any group of network nodes into separate broadcast domains. VLANs confine broadcast traffic to the originating group, and can eliminate broadcast storms in large networks. This provides a more secure and cleaner network environment.

VLANs can be based on untagged port groups, or traffic can be explicitly tagged to identify the VLAN group to which it belongs. Untagged VLANs can be used for small networks attached to a single switch. However, tagged VLANs should be used for larger networks, and all the VLANs assigned to the inter-switch links.

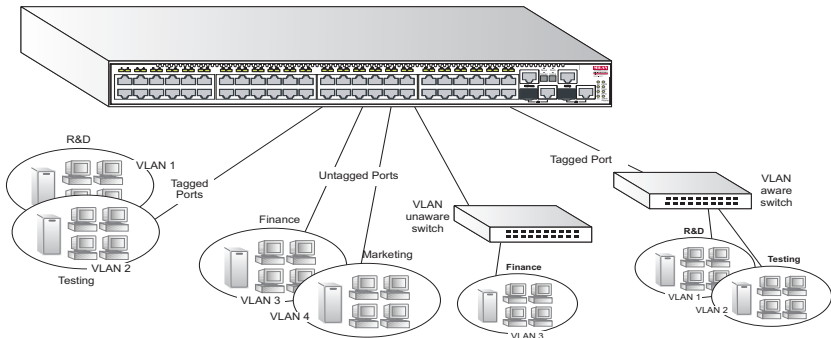

Figure 2-4 Making VLAN Connections

Note: When connecting to a switch that does not support IEEE 802.1Q VLAN tags, use untagged ports.

Application Notes

1. Full-duplex operation only applies to point-to-point access (such as when a switch is attached to a workstation, server or another switch). When the switch is connected to a hub, both devices must operate in half-duplex mode.
2. Avoid using flow control on a port connected to a hub unless it is actually required to solve a problem. Otherwise back pressure jamming signals may degrade overall performance for the segment attached to the hub.
3. As a general rule the length of fiber optic cable for a single switched link should not exceed:
 - 1000BASE-SX: 550 m (1805 ft) for multimode fiber.
 - 1000BASE-LX: 5 km (3.1 miles) for singlemode fiber.
 - 1000BASE-LH: 70 km (43.5 miles) for singlemode fiber.However, power budget constraints must also be considered when calculating the maximum cable length for your specific environment.
4. The maximum number of units that can be stacked together are:
 - 4 MIL-SM4804G units

Chapter 3: Installing the Switch

Selecting a Site

Switch units can be mounted in a standard 19-inch equipment rack or on a flat surface. Be sure to follow the guidelines below when choosing a location.

- The site should:
 - be at the center of all the devices you want to link and near a power outlet.
 - be able to maintain its temperature within 0 to 50 °C (32 to 122 °F) for the MIL-SM4804G, and its humidity within 5% to 95%, non-condensing
 - provide adequate space (approximately two inches) on all sides for proper air flow
 - be accessible for installing, cabling and maintaining the devices
 - allow the status LEDs to be clearly visible
- Make sure twisted-pair cable is always routed away from power lines, fluorescent lighting fixtures and other sources of electrical interference, such as radios and transmitters.
- Make sure that the unit is connected to a separate grounded power outlet that provides 100 to 240 VAC, 50 to 60 Hz, is within 2 m (6.6 feet) of each device and is powered from an independent circuit breaker. As with any equipment, using a filter or surge suppressor is recommended.

Ethernet Cabling

To ensure proper operation when installing the switch into a network, make sure that the current cables are suitable for 10BASE-T, 100BASE-TX or 1000BASE-T operation. Check the following criteria against the current installation of your network:

- Cable type: Unshielded twisted pair (UTP) or shielded twisted pair (STP) cables with RJ-45 connectors; Category 3 or better for 10BASE-T, Category 5 or better for 100BASE-TX, and Category 5, 5e or 6 for 1000BASE-T.
- Protection from radio frequency interference emissions
- Electrical surge suppression
- Separation of electrical wires (switch related or other) and electromagnetic fields from data based network wiring
- Safe connections with no damaged cables, connectors or shields

3 Installing the Switch

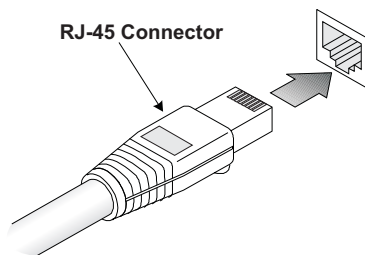

Figure 3-1 RJ-45 Connections

Equipment Checklist

After unpacking this switch, check the contents to be sure you have received all the components. Then, before beginning the installation, be sure you have all other necessary installation equipment.

Package Contents

- Stackable Fast Ethernet Switch (MIL-SM4804G)
- Four adhesive foot pads
- Bracket Mounting Kit containing two brackets and eight screws for attaching the brackets to the switch
- Power Cord—either US, Continental Europe or UK
- RS-232 console cable
- Stacking cable
- This Installation Guide
- Management Guide

Optional Rack-Mounting Equipment

If you plan to rack-mount the switch, be sure to have the following equipment available:

- Four mounting screws for each device you plan to install in a rack—these are not included
- A screwdriver (Phillips or flathead, depending on the type of screws used)

3 Installing the Switch

2. Mount the device in the rack, using four rack-mounting screws (not provided).

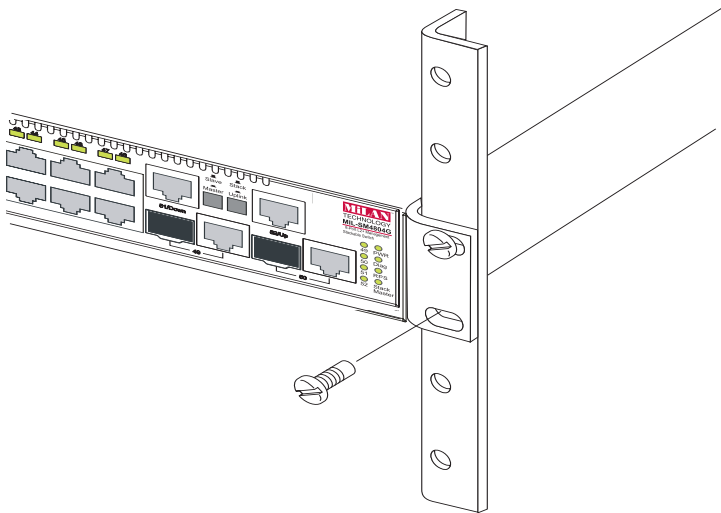

Figure 3-3 Installing the Switch in a Rack

3. If installing a single switch only, turn to “Connecting to a Power Source” at the end of this chapter.
4. If installing multiple switches, mount them in the rack, one below the other, in any order.
5. If also installing an RPS, mount it in the rack below the other devices.

Montage (Rack Mounting Instructions - German)

MIL-SM4804G Switch-Einheiten können an ein standardmäßiges 19-Zoll Einrichtungsrack, einen Arbeitstisch oder ein Regal montiert werden. Folgend finden Sie die Montageanweisungen für jeden Positionstyp.

Rack-Montage

Beachten Sie die folgenden Faktoren, bevor Sie die Rack-Montage beginnen:

- Temperatur: Da die Temperatur innerhalb einer Rackeinheit höher als die Raumumgebungstemperatur sein kann, stellen Sie bitte sicher, dass die Rackumgebungstemperatur innerhalb des angegebenen Betriebstemperaturbereichs liegt. (Siehe "Temperatur" auf Seite C-1.)
- Mechanische Last: Stellen Sie kein Gerät auf eine Rack-Montageeinheit.
- Stromüberlastung: Stellen Sie sicher, dass der Netzkreis der Rackeinheit nicht überlastet wird.
- Erdung: Die Rack-Montageeinheit muss richtig geerdet werden. Besondere Acht sollten Sie bei Verbindungen geben, die nicht direkt zum Netz führen.

So montieren Sie Geräte an ein Rack:

1. Befestigen Sie die Metallwinkel mit den im Metallwinkel-Montageset erhältlichen Schrauben an dem Gerät.
2. Befestigen Sie das Gerät mit vier Rackmontageschrauben (nicht beigelegt) an dem Rack.
3. Wenn Sie nur einen Switch installieren, dann springen Sie bitte über zu "Verbinden mit einer Stromquelle" auf Seite 3-8 am Ende dieses Kapitels.
4. Wenn Sie mehrere Switches installieren möchten, dann montieren Sie sie untereinander in einer beliebigen Reihenfolge.

Desktop or Shelf Mounting

1. Attach the four adhesive feet to the bottom of the first switch.

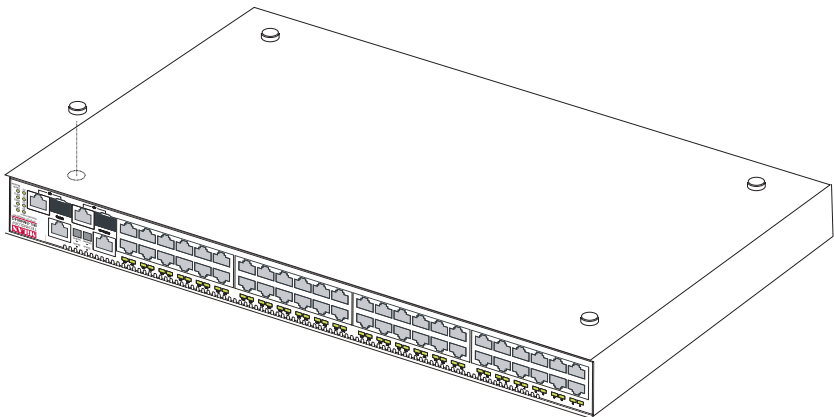

Figure 3-4 Attaching the Adhesive Feet

2. Set the device on a flat surface near an AC power source, making sure there are at least two inches of space on all sides for proper air flow.
3. If installing a single switch only, go to "Connecting to a Power Source" at the end of this chapter.
4. If installing multiple switches, attach four adhesive feet to each one. Place each device squarely on top of the one below, in any order.
5. If also installing an RPS, place it close to the stack.

Installing an Optional SFP Transceiver

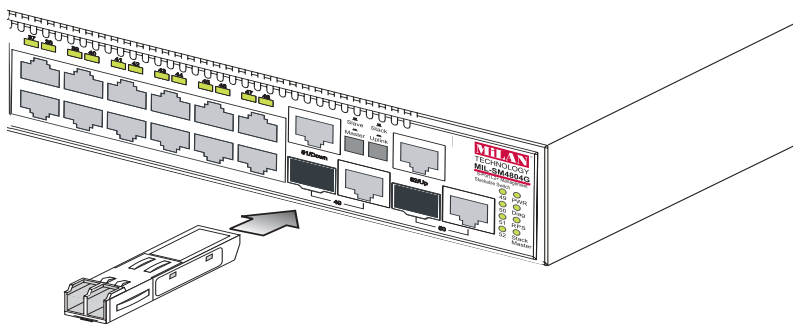

Figure 3-5 Installing an SFP Transceiver into a slot

This switch supports 1000BASE-SX, 1000BASE-LX, and 1000BASE-LH SFP transceivers. To install an SFP transceiver, do the following:

1. Consider network and cabling requirements to select an appropriate SFP transceiver type.
2. Insert the transceiver with the optical connector facing outward and the slot connector facing down. Note that SFP transceivers are keyed so they can only be installed in one orientation.
3. Slide the SFP transceiver into the slot until it clicks into place.

Note: SFP transceivers are hot-swappable. The switch does not need to be powered off before installing or removing a transceiver. However, always first disconnect the network cable before removing a transceiver.

Note: SFP transceivers are not provided in the switch package.

Connecting Switches in a Stack

Figure 3-6 shows how the stack cables are connected between switches in a stack. The connection is based on Gigabit Ethernet, using Category 5 or better cables. The switch supports a line- and ring-topology stacking configuration, or can be used stand alone.

In line-topology stacking there is a single stack cable connection between each switch that carries two-way communications across the stack. In ring-topology stacking, an extra cable is connected between the top and bottom switches forming a “ring” or “closed-loop.” The closed-loop cable provides a redundant path for the stack link, so if one link fails, stack communications can be maintained. Figure 3-6 illustrates a ring-topology stacking configuration.

You can form a stack containing up to four MIL-SM4804G units. To connect switches in a stack, perform the following steps:

1. Enable the stacking ports on each unit (i.e., the Stack button pushed out)
Note: Pressing the Stack button during normal operation will cause the system to reboot.
2. Plug one end of a stack cable (ordered separately) into the Down (left) port of the top unit.
3. Plug the other end of the stack cable into the Up (right) port of the next unit.
4. Repeat steps 1 and 2 for each unit in the stack. Form a simple chain starting at the Down port on the top unit and ending at the Up port on the bottom unit (stacking up to 4 units).
5. (Optional) To form a wrap-around topology, plug one end of a stack cable into the Down port on the bottom unit and the other end into the Up port on the top unit.

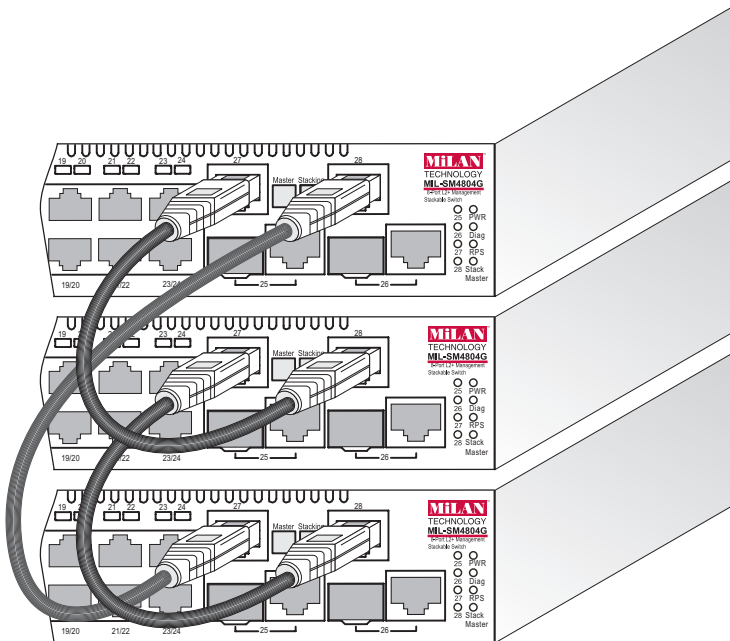

Figure 3-6 Connecting Switches in a Ring-topology Stack

3 Installing the Switch

6. Select the Master unit in the stack by pressing in the Master button on only one of the switches. Only one switch in the stack can operate as the Master, all other units operate in slave mode. If more than one switch in the stack is selected as Master, or if no switches are selected, the stack will not function.

Connecting to a Power Source

To connect a switch to a power source:

1. Insert the power cable plug directly into the AC receptacle located at the back of the switch.

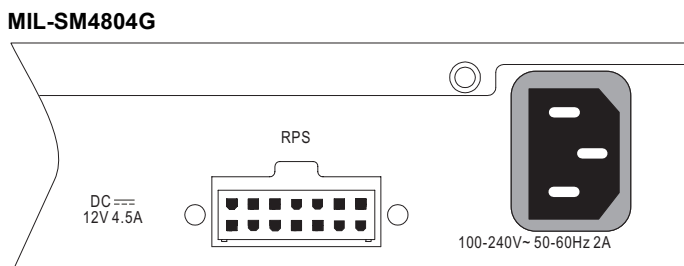

Figure 3-7 Power Receptacles

2. Plug the other end of the cable into a grounded, 3-pin, AC power source.
Note: For International use, you may need to change the AC line cord. You must use a line cord set that has been approved for the receptacle type in your country.
3. Check the front-panel LEDs as the device is powered on to be sure the PWR LED is lit. If not, check that the power cable is correctly plugged in.
4. If you have purchased a Redundant Power Unit, connect it to the switch and to an AC power source now, following the instructions included with the package.

Connecting to the Console Port

The DB-9 serial port on the switch's back panel is used to connect to the switch for out-of-band console configuration. The command-line-driven configuration program can be accessed from a terminal or a PC running a terminal emulation program. The pin assignments used to connect to the serial port are provided in the following table.

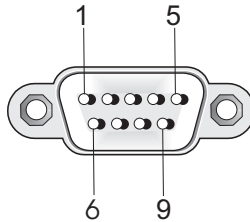

Figure 3-8 Serial Port (DB-9 DTE) Pin-Out

Wiring Map for Serial Cable

Table 3-1 Serial Cable Wiring

Switch's 9-Pin Serial Port	Null Modem	PC's 9-Pin DTE Port
2 RXD (receive data)	<-----	3 TXD (transmit data)
3 TXD (transmit data)	----->	2 RXD (receive data)
5 SGND (signal ground)	-----	5 SGND (signal ground)

No other pins are used.

The serial port's configuration requirements are as follows:

- Default Baud rate—9,600 bps
- Character Size—8 Characters
- Parity—None
- Stop bit—One
- Data bits—8

3 Installing the Switch

Chapter 4: Making Network Connections

Connecting Network Devices

These switches are designed to be connected to 10, 100 or 1000 Mbps network cards in PCs and servers, as well as to other switches and hubs. They may also be connected to remote devices using optional 1000BASE-SX, 1000BASE-LX, or 1000BASE-LH SFP transceivers.

Twisted-Pair Devices

Each device requires an unshielded twisted-pair (UTP) cable with RJ-45 connectors at both ends. Use Category 5, 5e or 6 cable for 1000BASE-T connections, Category 5 or better for 100BASE-TX connections, and Category 3 or better for 10BASE-T connections.

Cabling Guidelines

The RJ-45 ports on these switches support automatic MDI/MDI-X pinout configuration, so you can use standard straight-through twisted-pair cables to connect to any other network device (PCs, servers, switches, routers, or hubs).

See Appendix B for further information on cabling.

Caution: Do not plug a phone jack connector into an RJ-45 port. This will damage the switch. Use only twisted-pair cables with RJ-45 connectors that conform to FCC standards.

Connecting to PCs, Servers, Hubs and Switches

1. Attach one end of a twisted-pair cable segment to the device's RJ-45 connector.

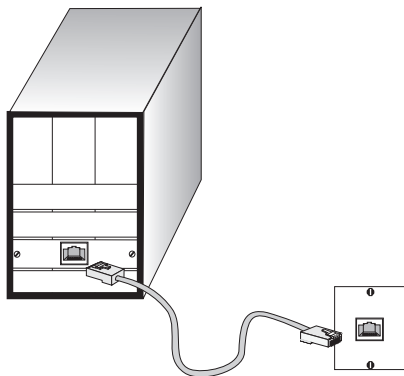

Figure 4-1 Making Twisted-Pair Connections

2. If the device is a network card and the switch is in the wiring closet, attach the other end of the cable segment to a modular wall outlet that is connected to the wiring closet. (See the section “Network Wiring Connections.”) Otherwise, attach the other end to an available port on the switch.

Make sure each twisted pair cable does not exceed 100 meters (328 ft) in length.

- Note:** Avoid using flow control on a port connected to a hub unless it is actually required to solve a problem. Otherwise back pressure jamming signals may degrade overall performance for the segment attached to the hub.
3. As each connection is made, the Link LED (on the switch) corresponding to each port will light to indicate that the connection is valid.

Network Wiring Connections

Today, the punch-down block is an integral part of many of the newer equipment racks. It is actually part of the patch panel. Instructions for making connections in the wiring closet with this type of equipment follows.

1. Attach one end of a patch cable to an available port on the switch, and the other end to the patch panel.
2. If not already in place, attach one end of a cable segment to the back of the patch panel where the punch-down block is located, and the other end to a modular wall outlet.

3. Label the cables to simplify future troubleshooting. See “Cable Labeling and Connection Records” on page 4-7.

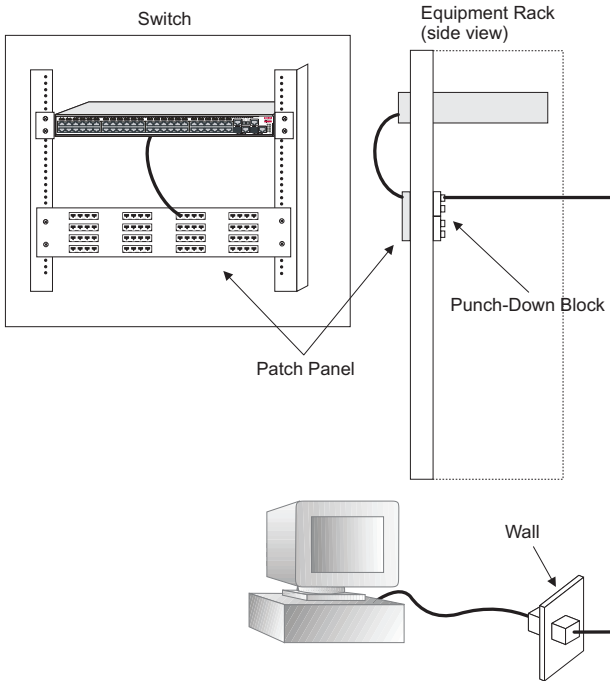

Figure 4-2 Network Wiring Connections

Fiber Optic SFP Devices

An optional Gigabit SFP transceiver (1000BASE-SX, 1000BASE-LX, or 1000BASE-LH) can be used for a backbone connection between switches, or for connecting to a high-speed server.

Each single-mode fiber port requires 9/125 micron single-mode fiber optic cable with an LC connector at both ends. Each multimode fiber optic port requires 50/125 or 62.5/125 micron multimode fiber optic cabling with an LC connector at both ends.

Warning: This switch uses lasers to transmit signals over fiber optic cable. The lasers are compliant with the requirements of a Class 1 Laser Product and are inherently eye safe in normal operation. However, you should never look directly at a transmit port when it is powered on.

Note: When selecting a fiber SFP device, considering safety, please make sure that it can function at a temperature that is not less than the recommended maximum operational temperature of the product. You must also use an approved Laser Class 1 SFP transceiver.

Hinweis: Bei der Wahl eines Glasfasertransceivers muß für die Beurteilung der Gesamtsicherheit beachtet werden, das die maximale Umgebungstemperatur des Transceivers für den Betrieb nicht niedriger ist als die für dieses Produkts. Der Glasfasertransceiver muß auch ein überprüftes Gerät der Laser Klasse 1 sein.

1. Remove and keep the LC port's rubber plug. When not connected to a fiber cable, the rubber plug should be replaced to protect the optics.
2. Check that the fiber terminators are clean. You can clean the cable plugs by wiping them gently with a clean tissue or cotton ball moistened with a little ethanol. Dirty fiber terminators on fiber optic cables will impair the quality of the light transmitted through the cable and lead to degraded performance on the port.

4 Making Network Connections

Category 5 cabling for running 1000BASE-T is a simple test of the cable installation to be sure that it complies with the IEEE 802.3-2002 standards.

1000 Mbps Gigabit Ethernet Collision Domain

Table 4-1 Maximum 1000BASE-T Gigabit Ethernet Cable Length

Cable Type	Maximum Cable Length	Connector
Category 5, 5e, or 6 100-ohm UTP or STP	100 m (328 ft)	RJ-45

Table 4-2 Maximum 1000BASE-SX Gigabit Ethernet Cable Lengths

Fiber Size	Fiber Bandwidth	Maximum Cable Length	Connector
62.5/125 micron multimode fiber	160 MHz/km	2-220 m (7-722 ft)	LC
	200 MHz/km	2-275 m (7-902 ft)	LC
50/125 micron multimode fiber	400 MHz/km	2-500 m (7-1641 ft)	LC
	500 MHz/km	2-550 m (7-1805 ft)	LC

Table 4-3 Maximum 1000BASE-LX Gigabit Ethernet Cable Length

Fiber Size	Fiber Bandwidth	Maximum Cable Length	Connector
9/125 micron single-mode fiber	N/A	2 m - 5 km (7 ft - 3.2 miles)	LC

Table 4-4 Maximum 1000BASE-LH Gigabit Ethernet Cable Length

Fiber Size	Fiber Bandwidth	Maximum Cable Length	Connector
9/125 micron single-mode fiber	N/A	2 m - 70 km (7 ft - 43.5 miles)	LC

100 Mbps Fast Ethernet Collision Domain

Table 4-5 Maximum Fast Ethernet Cable Length

Type	Cable Type	Max. Cable Length	Connector
100BASE-TX	Category 5 or better 100-ohm UTP or STP	100 m (328 ft)	RJ-45

10 Mbps Ethernet Collision Domain

Table 4-6 Maximum Ethernet Cable Length

Type	Cable Type	Max. Cable Length	Connector
10BASE-T	Category 3 or better 100-ohm UTP	100 m (328 ft)	RJ-45

Cable Labeling and Connection Records

When planning a network installation, it is essential to label the opposing ends of cables and to record where each cable is connected. Doing so will enable you to easily locate inter-connected devices, isolate faults and change your topology without need for unnecessary time consumption.

To best manage the physical implementations of your network, follow these guidelines:

- Clearly label the opposing ends of each cable.
- Using your building's floor plans, draw a map of the location of all network-connected equipment. For each piece of equipment, identify the devices to which it is connected.
- Note the length of each cable and the maximum cable length supported by the switch ports.
- For ease of understanding, use a location-based key when assigning prefixes to your cable labeling.
- Use sequential numbers for cables that originate from the same equipment.
- Differentiate between racks by naming accordingly.
- Label each separate piece of equipment.
- Display a copy of your equipment map, including keys to all abbreviations at each equipment rack.

4 Making Network Connections

Appendix A: Troubleshooting

Diagnosing Switch Indicators

Table A-1 Troubleshooting Chart

Symptom	Action
PWR LED is Off	<ul style="list-style-type: none">• Check connections between the switch, the power cord and the wall outlet.• Contact your dealer for assistance
PWR LED is Amber	<ul style="list-style-type: none">• Internal power supply has failed. Contact your local dealer for assistance.
Diag LED is Amber	<ul style="list-style-type: none">• Power cycle the switch to try and clear the condition• If the condition does not clear, contact your dealer for assistance
Stack Master LED is Flashing Amber	<ul style="list-style-type: none">• The stack has not completed its initial configuration. Wait a few minutes for the process to complete.• If flashing continues, check that the Master Select button is pressed in on only one switch.• Check that all stacking cables are properly connected.
Link LED is Off	<ul style="list-style-type: none">• Verify that the switch and attached device are powered on.• Be sure the cable is plugged into both the switch and corresponding device.• If the switch is installed in a rack, check the connections to the punch-down block and patch panel.• Verify that the proper cable type is used and its length does not exceed specified limits.• Check the adapter on the attached device and cable connections for possible defects. Replace the defective adapter or cable if necessary.

Diagnosing Power Problems with the LEDs

The Power and RPS LEDs work in combination to indicate power status as follows.

Table A-2 Power/RPS LEDs

Power LED	RPS LED	Status
Green	Amber	Internal power functioning normally; RPS plugged in.
Green	Off	Internal power functioning normally; RPS not plugged in.
Amber	Green	Internal power faulty; RPS delivering power.
Off	Off	Both internal power and RPS unplugged or not functioning.

Power and Cooling Problems

If the power indicator does not turn on when the power cord is plugged in, you may have a problem with the power outlet, power cord, or internal power supply. However, if the unit powers off after running for a while, check for loose power connections, power losses or surges at the power outlet. If you still cannot isolate the problem, the internal power supply may be defective.

Installation

Verify that all system components have been properly installed. If one or more components appear to be malfunctioning (such as the power cord or network cabling), test them in an alternate environment where you are sure that all the other components are functioning properly.

In-Band Access

You can access the management agent in the switch from anywhere within the attached network using Telnet, a web browser, or other network management software tools. However, you must first configure the switch with a valid IP address, subnet mask, and default gateway. If you have trouble establishing a link to the management agent, check to see if you have a valid network connection. Then verify that you entered the correct IP address. Also, be sure the port through which you are connecting to the switch has not been disabled. If it has not been disabled, then check the network cabling that runs between your remote location and the switch.

Note: The management agent accepts up to four simultaneous Telnet sessions. If the maximum number of sessions already exists, an additional Telnet connection will not be able to log into the system.

Stack Troubleshooting

If a stack fails to initialize or function, first check the following items:

- Check that all stacking cables are properly connected.
- Check if any stacking cables appear damaged.
- Check that the Master select button is pressed in on only one unit in the stack.
- Check that each unit has the stacking ports enabled (the Stack button pushed out).
- Check that all switches in the stack are powered on.

After checking all items, reboot all the switches in the stack.

Appendix B: Cables

Twisted-Pair Cable and Pin Assignments

For 10/100BASE-TX connections, the twisted-pair cable must have two pairs of wires. For 1000BASE-T connections the twisted-pair cable must have four pairs of wires. Each wire pair is identified by two different colors. For example, one wire might be green and the other, green with white stripes. Also, an RJ-45 connector must be attached to both ends of the cable.

Caution: DO NOT plug a phone jack connector into any RJ-45 port. Use only twisted-pair cables with RJ-45 connectors that conform with FCC standards.

Caution: Each wire pair must be attached to the RJ-45 connectors in a specific orientation. (See "Straight-Through Wiring" and "Crossover Wiring" on the next page for an explanation.)

The figure below illustrates how the pins on the RJ-45 connector are numbered. Be sure to hold the connectors in the same orientation when attaching the wires to the pins.

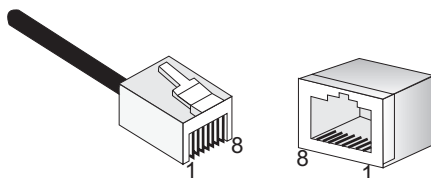

Figure B-1 RJ-45 Connector Pin Numbers

10BASE-T/100BASE-TX Pin Assignments

Use unshielded twisted-pair (UTP) or shielded twisted-pair (STP) cable for RJ-45 connections: 100-ohm Category 3 or better cable for 10 Mbps connections, or 100-ohm Category 5 or better cable for 100 Mbps connections. Also be sure that the length of any twisted-pair connection does not exceed 100 meters (328 feet).

The RJ-45 ports on the switch base unit support automatic MDI/MDI-X operation, so you can use straight-through cables for all network connections to PCs or servers, or to other switches or hubs. In straight-through cable, pins 1, 2, 3, and 6, at one end of the cable, are connected straight through to pins 1, 2, 3, and 6 at the other end of the cable. When using any RJ-45 port on this switch, you can use either straight-through or crossover cable.

Table B-1 10/100BASE-TX MDI and MDI-X Port Pinouts

Pin	MDI Signal Name	MDI-X Signal Name
1	Transmit Data plus (TD+)	Receive Data plus (RD+)
2	Transmit Data minus (TD-)	Receive Data minus (RD-)
3	Receive Data plus (RD+)	Transmit Data plus (TD+)
6	Receive Data minus (RD-)	Transmit Data minus (TD-)
4,5,7,8	Not used	Not used

Note: The “+” and “-” signs represent the polarity of the wires that make up each wire pair.

Straight-Through Wiring

If the twisted-pair cable is to join two ports and only one of the ports has an internal crossover (MDI-X), the two pairs of wires must be straight-through. (When auto-negotiation is enabled for any RJ-45 port on this switch, you can use either straight-through or crossover cable to connect to any device type.)

You must connect all four wire pairs as shown in the following diagram to support Gigabit Ethernet.

EIA/TIA 568B RJ-45 Wiring Standard
10/100BASE-TX Straight-through Cable

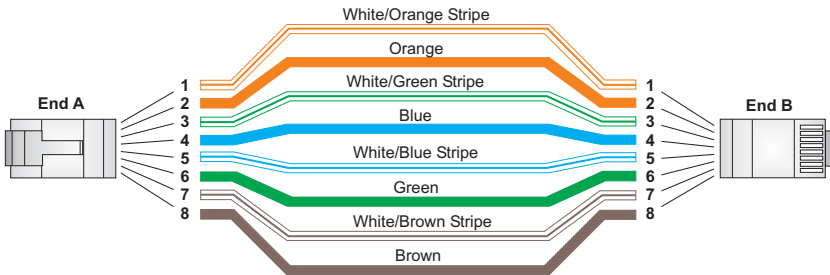

Figure B-2 Straight-through Wiring

Crossover Wiring

If the twisted-pair cable is to join two ports and either both ports are labeled with an “X” (MDI-X) or neither port is labeled with an “X” (MDI), a crossover must be implemented in the wiring. (When auto-negotiation is enabled for any RJ-45 port on this switch, you can use either straight-through or crossover cable to connect to any device type.)

You must connect all four wire pairs as shown in the following diagram to support Gigabit Ethernet.

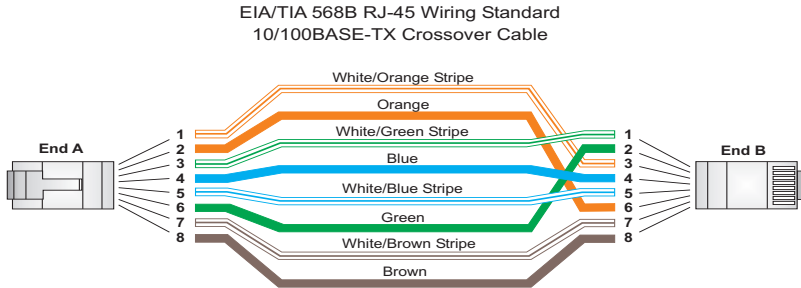

Figure B-3 Crossover Wiring

1000BASE-T Pin Assignments

All 1000BASE-T ports support automatic MDI/MDI-X operation, so you can use straight-through cables for all network connections to PCs or servers, or to other switches or hubs.

The table below shows the 1000BASE-T MDI and MDI-X port pinouts. These ports require that all four pairs of wires be connected. Note that for 1000BASE-T operation, all four pairs of wires are used for both transmit and receive.

Use 100-ohm Category 5, 5e or 6 unshielded twisted-pair (UTP) or shielded twisted-pair (STP) cable for 1000BASE-T connections. Also be sure that the length of any twisted-pair connection does not exceed 100 meters (328 feet).

Table B-2 1000BASE-T MDI and MDI-X Port Pinouts

Pin	MDI Signal Name	MDI-X Signal Name
1	Bi-directional Data One Plus (BI_D1+)	Bi-directional Data Two Plus (BI_D2+)
2	Bi-directional Data One Minus (BI_D1-)	Bi-directional Data Two Minus (BI_D2-)
3	Bi-directional Data Two Plus (BI_D2+)	Bi-directional Data One Plus (BI_D1+)
4	Bi-directional Data Three Plus (BI_D3+)	Bi-directional Data Four Plus (BI_D4+)
5	Bi-directional Data Three Minus (BI_D3-)	Bi-directional Data Four Minus (BI_D4-)
6	Bi-directional Data Two Minus (BI_D2-)	Bi-directional Data One Minus (BI_D1-)
7	Bi-directional Data Four Plus (BI_D4+)	Bi-directional Data Three Plus (BI_D3+)
8	Bi-directional Data Four Minus (BI_D4-)	Bi-directional Data Three Minus (BI_D3-)

Cable Testing for Existing Category 5 Cable

Installed Category 5 cabling must pass tests for Attenuation, Near-End Crosstalk (NEXT), and Far-End Crosstalk (FEXT). This cable testing information is specified in the ANSI/TIA/EIA-TSB-67 standard. Additionally, cables must also pass test parameters for Return Loss and Equal-Level Far-End Crosstalk (ELFEXT). These tests are specified in the ANSI/TIA/EIA-TSB-95 Bulletin, "The Additional Transmission Performance Guidelines for 100 Ohm 4-Pair Category 5 Cabling."

Note that when testing your cable installation, be sure to include all patch cables between switches and end devices.

Adjusting Existing Category 5 Cabling to Run 1000BASE-T

If your existing Category 5 installation does not meet one of the test parameters for 1000BASE-T, there are basically three measures that can be applied to try and correct the problem:

1. Replace any Category 5 patch cables with high-performance Category 5e or Category 6 cables.
2. Reduce the number of connectors used in the link.
3. Reconnect some of the connectors in the link.

Fiber Standards

The current TIA (Telecommunications Industry Association) 568-A specification on optical fiber cabling consists of one recognized cable type for horizontal subsystems and two cable types for backbone subsystems.

Horizontal 62.5/125 micron multimode (two fibers per outlet).

Backbone 62.5/125 micron multimode or single-mode.

TIA 568-B will allow the use of 50/125 micron multimode optical fiber in both the horizontal and backbone in addition to the types listed above. All optical fiber components and installation practices must meet applicable building and safety codes.

Appendix C: Specifications

Physical Characteristics

Ports

- 48 10/100BASE-TX, with auto-negotiation
- Two 10/100/1000BASE-T shared with two SFP transceiver slots
- Two 10/100/1000BASE-T or Stacking Ports (button selection)

Network Interface

- Ports 1-48: RJ-45 connector, auto MDI/X
 - 10BASE-T: RJ-45 (100-ohm, UTP cable; Category 3 or better)
 - 100BASE-TX: RJ-45 (100-ohm, UTP cable; Category 5 or better)
- Ports 49-52: RJ-45 connector, auto MDI/X
 - 10BASE-T: RJ-45 (100-ohm, UTP cable; Category 3 or better)
 - 100BASE-TX: RJ-45 (100-ohm, UTP cable; Category 5 or better)
 - 1000BASE-T: RJ-45 (100-ohm, UTP or STP cable; Category 5, 5e or 6)

Buffer Architecture

- 4 Mbits

Aggregate Bandwidth

- 17.6 Gbps

Switching Database

- 8K MAC address entries

LEDs

- System: PWR (Power Supply), Diag (Diagnostic), RPS (Redundant Power Supply), Stack Master
- Port: status (link, speed, and activity)

Weight

- 3.09 kg (6.81 lbs)

Size

- 44.0 x 23 x 4.4 cm (17.32 x 9.06 x 1.73 in.)

Temperature

- Operating: 0°C to 50°C (32°F to 122°F)
- Storage: -40°C to 70°C (-40°F to 158°F)



Humidity

Operating: 5% to 95% (non-condensing)

Power Supply

Internal, auto-ranging transformer: 100 to 240 VAC, 50 to 60 Hz, 2A

External, supports a 14-pin connection for a redundant power supply

Power Consumption

54 Watts maximum

Maximum Current

2.0 A @ 100 VAC

1.0 A @ 240 VAC

Switch Features

Forwarding Mode

Store-and-forward

Throughput

Wire speed

Flow Control

Full Duplex: IEEE 802.3x

Half Duplex: Back pressure

Management Features

In-Band Management

SSH, Telnet, SNMP, RMON (4-group), or HTTP

Out-of-Band Management

RS-232 DB-9 console port

Software Loading

TFTP in-band, or XModem out-of-band

Standards

IEEE 802.3-2002
Ethernet, Fast Ethernet, Gigabit Ethernet
Full-duplex flow control
Link Aggregation Control Protocol
IEEE 802.1D Spanning Tree Protocol
IEEE 802.1w Rapid Spanning Tree Protocol
IEEE 802.1X Port Access Authentication
IEEE 802.1Q VLANs
ISO/IEC 8802-3

Compliances

Emissions

Industry Canada Class A
EN55022 (CISPR 22) Class A
EN 61000-3-2/3
FCC Class A
VCCI Class A
C-Tick - AS/NZS 3548 (1995) Class A

Immunity

EN 61000-4-2/3/4/5/6/8/11

Safety

CSA/CUS (CSA60950 & UL60950)
TÜV/GS (EN60950-1)
CB (IEC60950)

Glossary

10BASE-T

IEEE 802.3 specification for 10 Mbps Ethernet over two pairs of Category 3, 4, or 5 UTP cable.

100BASE-FX

IEEE 802.3 specification for 100 Mbps Ethernet over two strands of 50/125, 62.5/125 micron, or 9/125 micron core fiber cable.

100BASE-TX

IEEE 802.3u specification for 100 Mbps Ethernet over two pairs of Category 5 UTP cable.

1000BASE-LH

Specification for long-haul Gigabit Ethernet over two strands of 9/125 micron core fiber cable.

1000BASE-LX

IEEE 802.3z specification for Gigabit Ethernet over two strands of 50/125, 62.5/125 or 9/125 micron core fiber cable.

1000BASE-SX

IEEE 802.3z specification for Gigabit Ethernet over two strands of 50/125 or 62.5/125 micron core fiber cable.

1000BASE-T

IEEE 802.3ab specification for Gigabit Ethernet over 100-ohm Category 5, 5e or 6 twisted-pair cable (using all four wire pairs).

Auto-Negotiation

Signalling method allowing each node to select its optimum operational mode (e.g., speed and duplex mode) based on the capabilities of the node to which it is connected.

Bandwidth

The difference between the highest and lowest frequencies available for network signals. Also synonymous with wire speed, the actual speed of the data transmission along the cable.

Collision

A condition in which packets transmitted over the cable interfere with each other. Their interference makes both signals unintelligible.

Collision Domain

Single CSMA/CD LAN segment.

CSMA/CD

CSMA/CD (Carrier Sense Multiple Access/Collision Detect) is the communication method employed by Ethernet, Fast Ethernet, and Gigabit Ethernet.

End Station

A workstation, server, or other device that does not forward traffic.

Ethernet

A network communication system developed and standardized by DEC, Intel, and Xerox, using baseband transmission, CSMA/CD access, logical bus topology, and coaxial cable. The successor IEEE 802.3 standard provides for integration into the OSI model and extends the physical layer and media with repeaters and implementations that operate on fiber, thin coax and twisted-pair cable.

Fast Ethernet

A 100 Mbps network communication system based on Ethernet and the CSMA/CD access method.

Full Duplex

Transmission method that allows two network devices to transmit and receive concurrently, effectively doubling the bandwidth of that link.

Gigabit Ethernet

A 1000 Mbps network communication system based on Ethernet and the CSMA/CD access method.

IEEE

Institute of Electrical and Electronic Engineers.

IEEE 802.3

Defines carrier sense multiple access with collision detection (CSMA/CD) access method and physical layer specifications.

IEEE 802.3ab

Defines CSMA/CD access method and physical layer specifications for 1000BASE-T Gigabit Ethernet. (Now incorporated in IEEE 802.3-2002.)

IEEE 802.3u

Defines CSMA/CD access method and physical layer specifications for 100BASE-TX Fast Ethernet. (Now incorporated in IEEE 802.3-2002.)

IEEE 802.3x

Defines Ethernet frame start/stop requests and timers used for flow control on full-duplex links. (Now incorporated in IEEE 802.3-2002.)

IEEE 802.3z

Defines CSMA/CD access method and physical layer specifications for 1000BASE Gigabit Ethernet. (Now incorporated in IEEE 802.3-2002.)

LAN Segment

Separate LAN or collision domain.

LED

Light emitting diode used for monitoring a device or network condition.

Local Area Network (LAN)

A group of interconnected computer and support devices.

Media Access Control (MAC)

A portion of the networking protocol that governs access to the transmission medium, facilitating the exchange of data between network nodes.

MIB

An acronym for Management Information Base. It is a set of database objects that contains information about the device.

Modal Bandwidth

Bandwidth for multimode fiber is referred to as modal bandwidth because it varies with the modal field (or core diameter) of the fiber. Modal bandwidth is specified in units of MHz per km, which indicates the amount of bandwidth supported by the fiber for a one km distance.

Network Diameter

Wire distance between two end stations in the same collision domain.

Redundant Power Supply (RPS)

A backup power supply that automatically takes over in case the primary power supply should fail.

RJ-45 Connector

A connector for twisted-pair wiring.

Switched Ports

Ports that are on separate collision domains or LAN segments.

TIA

Telecommunications Industry Association

Transmission Control Protocol/Internet Protocol (TCP/IP)

Protocol suite that includes TCP as the primary transport protocol, and IP as the network layer protocol.

UTP

Unshielded twisted-pair cable.

Virtual LAN (VLAN)

A Virtual LAN is a collection of network nodes that share the same collision domain regardless of their physical location or connection point in the network. A VLAN serves as a logical workgroup with no physical barriers, allowing users to share information and resources as though located on the same LAN.

Index

Numerics

- 10 Mbps connectivity rules 4-6
- 100 Mbps connectivity rules 4-6
- 1000 Mbps connectivity rules 4-6
- 1000BASE-LH fiber cable length 4-6
- 1000BASE-LX fiber cable length 4-6
- 1000BASE-SX fiber cable length 4-6
- 1000BASE-T
 - pin assignments B-3
 - ports 1-3
- 100BASE-TX
 - cable length 4-6
 - ports 1-2
- 10BASE-T
 - cable length 4-6
 - ports 1-2

A

- adhesive feet, attaching 3-5
- air flow requirements 3-1
- applications
 - central wiring closet 2-3
 - collapsed backbone 2-2
 - remote connections with fiber 2-4
 - VLAN connections 2-5

B

- brackets, attaching 3-3
- buffer size C-1
- buffers, saturation of 1-3

C

- cable
 - Ethernet cable compatibility 3-1
 - fiber standards B-4
 - labeling and connection records 4-7
 - lengths 4-6
- cleaning fiber terminators 4-4
- compliances
 - EMC C-3
 - safety C-3

- connectivity rules
 - 10 Mbps 4-6
 - 100 Mbps 4-6
 - 1000 Mbps 4-6
- console port, pin assignments 3-9
- contents of package 3-2
- cooling problems A-2
- cord sets, international 3-8

D

- desktop mounting 3-5
- device connections 4-1

E

- electrical interference, avoiding 3-1
- equipment checklist 3-2
- Ethernet connectivity rules 4-6

F

- Fast Ethernet connectivity rules 4-6
- features C-2
 - management 1-8
 - switch 1-7
- fiber cables 4-4
- flow control, IEEE 802.3x 1-3
- front panel of switch 1-1
- full duplex connectivity 2-1

G

- Gigabit Ethernet cable lengths 4-6
- grounding for racks 3-3

I

- IEEE 802.3x flow control 1-3
- indicators, LED 1-5
- installation
 - connecting devices to the switch 4-2
 - desktop or shelf mounting 3-5
 - network wiring connections 4-2
 - port connections 4-1, 4-4
 - power requirements 3-1
 - problems A-2

rack mounting 3-3
site requirements 3-1

L

laser safety 4-4
LC port connections 4-4
LED indicators
 Diag 1-6
 Power 1-6
 problems A-1
 Stack 1-6
location requirements 3-1

M

management
 agent 1-2
 features 1-8, C-2
 out-of-band 1-2
 SNMP 1-2
 web-based 1-2
Maximum Fast Ethernet Cable
 Distance 4-6
mounting the switch
 in a rack 3-3
 on a desktop or shelf 3-5
multimode fiber optic cables 4-4

N

network
 connections 4-1, 4-4
 examples 2-2

O

out-of-band management 1-2

P

package contents 3-2
pin assignments B-1
 1000BASE-T B-3
 10BASE-T/100BASE-TX B-1
 console port 3-9
 DB-9 3-9
port saturation 1-3
ports, connecting to 4-1, 4-4
power, connecting to 3-8

problems, troubleshooting A-1

R

rack mounting 3-3
rear panel of switch 1-1
rear panel receptacles 1-7
RJ-45 port
 connections 4-1
 pinouts B-3
RMON 1-2
RS-232 port 1-2
rubber foot pads, attaching 3-5

S

screws for rack mounting 3-2
serial
 cable 1-2
 port 1-2
single-mode fiber optic cables 4-4
site selection 3-1
SNMP agent 1-2
specifications
 compliances C-2
 environmental C-1
 physical C-1
 power C-2
standards
 compliance C-2
 IEEE C-3
status LEDs 1-5
surge suppressor, using 3-1
switch architecture 1-2
switching
 introduction to 2-1
 method 1-2

T

Telnet A-2
temperature within a rack 3-3
troubleshooting
 in-band access A-2
 power and cooling problems A-2
 switch indicators A-1
twisted-pair connections 4-1

V

VLANs

tagging 2-5

W

web-based management 1-2

