

Laser Distance Meter

P7 Series Quick Start

Product Overview

Thank you for using MileSeey handheld laser distance meter, please read the instruction carefully before operation.

P7 will be one of milestone products in laser distance history developed by MileSeey.

Thanks to creative skeleton design, robust housing, compact inner structure, P7 offers the perfect features of IP65 waterproof, drop-resistance and super long lifespan. With 2-inch colored touch display and tempered glass cover on the surface, it enables user to operate freely. P7 has been approved by international authorized lab that water and dust proof could reach IP65.

P7 integrated 4xZoom camera, which could help find the target in sunshine or long distance, as well as enables user to measure more accurate within the extended range of 200 meters. It also introduces smart Bluetooth connectivity to App, tilt sensor and rechargeable NI-MH batteries.

MileSeey is the original developer of P2P measurement in laser distance meter industry. What's more, P7 also offers comprehensive measuring functions of Area, Volume, Pythagoras, Auto Level, Auto Height etc. which can meet the measurement needs of most people and provide high-quality

measurement experience for your try.

Appearance

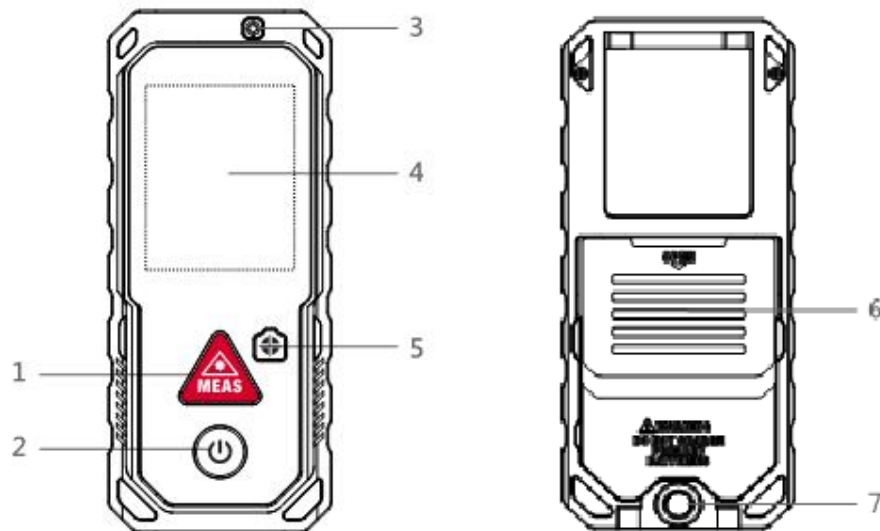

1. Measure Button

Activate the measuring mode, press button to measure.

2.ON/OFF/Clear/Return Button

Long press to switch ON/OFF, short press to clear the previous operations or return to main menu.

3. Laser Emitter Indication

4. Touch Screen

5. Pointfinder

Capture and locate the target in long range.

6. Battery Compartment

7.Tripod Screw Hole

Safety Instructions

The safety instructions should be read through carefully before the product is used for the first time.



if the equipment is used in a manner not specified by the manufacturer, the protection provided by the equipment may be impaired.



Warning

a . The device is categorized into Class 2 laser product. DO NOT stare at laser directly or shoot at others or it will cause damage to eyes.

b.The product is in accordance with strict standards and regulations through the development and manufacturing, but still can't entirely exclude the possibility of interference to other devices, may cause discomfort to human and animals.

Please DO NOT use this product under explosive or corrosive environment.

Please DO NOT use this product near medical devices.

Please DO NOT use this product on the plane.



FCC Warning:

This equipment has been tested and found to comply with the limits for a Class B digital device, pursuant to part 15 of the FCC Rules. These limits are designed to provide reasonable protection against harmful interference in a residential installation. This equipment generates, uses and can radiate radio frequency energy and, if not installed and used in accordance with the instructions, may cause harmful interference to radio communications. However, there is no guarantee that interference will not occur in a particular installation. If this equipment does cause

harmful interference to radio or television reception, which can be determined by turning the equipment off and on, the user is encouraged to try to correct the interference by one or more of the following measures:

- Reorient or relocate the receiving antenna.
- Increase the separation between the equipment and receiver.
- Connect the equipment into an outlet on a circuit different from that to which the receiver is connected.
- Consult the dealer or an experienced radio/TV technician for help.

MODIFICATION: Any changes or modifications not expressly approved by the grantee of this device could void the user's authority to operate the device.

This device complies with part 15 of the FCC Rules. Operation is subject to the following two conditions:

- (1) This device may not cause harmful interference, and
- (2) this device must accept any interference received, including interference that may cause undesired operation.



1, Disposal

Everyone is responsible for environmental protection.

It's prohibited to dispose used batteries together with household waste, please collect used batteries to designated waste station.

This product must not be recycled with household waste. Dispose of the product appropriately in accordance with the national regulations in your country.

2, Scope of Responsibility

MileSeey will not be responsible for the damages caused by improper use below:

- *Using the product without instruction;
- *Use of accessories from other manufacturers without approval from MileSeey ;
- *Carrying out modification or conversion of the product.

Battery Installation and Instructions

Press and slide the cover toward the rear of the body to open the battery door.



Insert 3* AAA rechargeable NI-MH batteries, observing correct polarity.

*TPE sealing ring has been adopted inside of the cover to prevent water and dust.

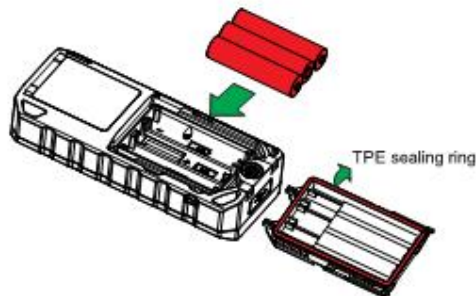

After the battery is placed, cover and hold the battery door, press and slide to the top, the cover can be sealed.



The product uses rechargeable NI-MH batteries. Please use provided USB cable while charging. The computer can also be used to charge, but this takes more time.



Warning:

When use dry batteries, please DO NOT use USB to charge. DO NOT mix rechargeable batteries with dry batteries at the same time to avoid accidents. Any damage caused by improper use of charging dry battery is not covered by the warranty, MileSeey will not beresponsible for it. While charging, the device may heat up, this normal, and will not affect the product performance and lifetime.

Please unplug the charger and take off the batteries when not in use.



Warning:

Do not use aggressive cleaning agents or solutions. Use only a clean, soft cloth for cleaning.

Specification

Specification	P7
Measuring Range	0.2-200
Measuring Accuracy	$\pm (2.0\text{mm}+5\times 10^{-5}\text{D})$
Single Distance Measurement	√
Continuous Measurement	√
Area Measurement	√
Volume Measurement	√
Pythagoras (2-point)	√
Pythagoras (3-point) ①	√
Pythagoras (3-point) ②	√
Auto Level	√
Auto Height	√
Point to Point (P2P)	√
Add/Subtract	√
Bluetooth4.0	√
Screen Rotation	√
Tilt Sensor	√
USB Data Export	√
Screen Setting	√
Screen Display	2-inch colored touch display
Pointfinder	4x zoom
Measuring Reference	Top/Tripod screw/Bottom
Measuring Units	m/ft/in/ft+in
Memory	20sets
Auto Power Switch-off	After 180s
Ingress Protection	IP65
Laser Class	Class II
Class Type	630-670nm, <1mW
Battery Type	5VDC through USB port or 3.6VDC by rechargeable batteries(size AAA 1.2Vx3) or 4.5VDC by non-rechargeable batteries(size AAA 1.5Vx3)
Operating Temperature	0°C ~ +40°C (32° F ~ +104° F)
Altitude	up to 2000m
Humidity	0-95%

Dimension	115*49*26mm
-----------	-------------

1. Measuring Range

The Maximum range shall be different according to different models. The actual range refers to the package.

2. Measuring Accuracy("D" stands for measured distance)If measuring under favorable conditions, such as smooth surface, proper temperature and indoor lighting, the device is able to work within certain range as indicated.

Maximum deviation occurs under unfavorable conditions such as bright sunlight or when measuring to poorly reflecting or very rough surfaces.

Tips: In case of bright sunlight and bad reflection of the object, please use the target plate or reflector.

Touchscreen Operations

① Display Screen

Touch screen, Mode selection display; Slide right to setup menu, slide up and down to select measuring mode accordingly.

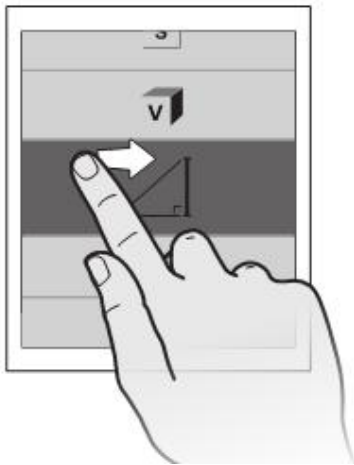

Slide left to Add/Subtract mode, Add/Subtract calculation can be made to Distance, Area and Volume measurement;

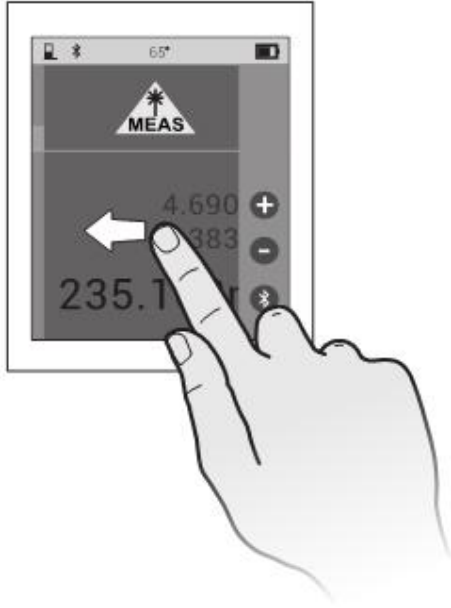

Slide down to setup menu, pull up to retract it.

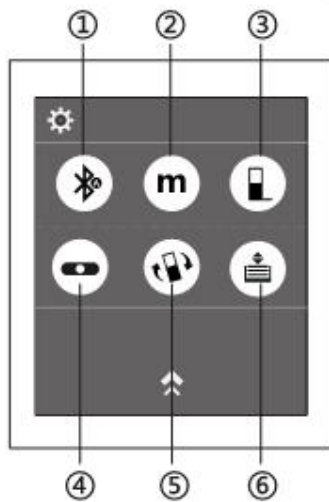
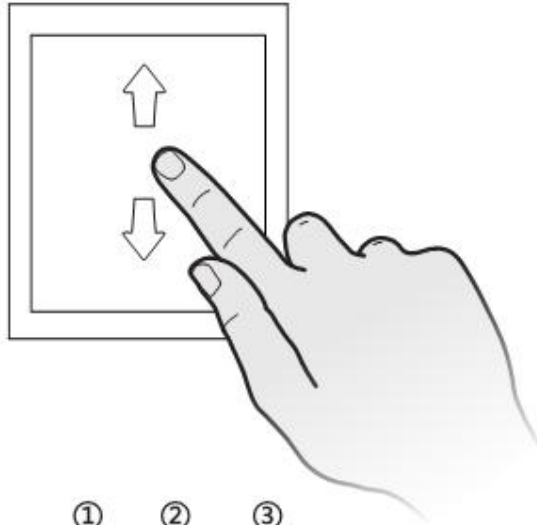

① Bluetooth

Press to activate or de-activate the Bluetooth to remotely control the measurement by connecting with App, 3 modes can be selected.

1. Automatic Bluetooth Transfer Mode: Upload the measurement data to App automatically.

2. Manual Bluetooth Transfer Mode: Press to select , in any measurement mode, click Bluetooth icon on status bar to transfer current data to App.

3. When the icon turns grey, the Bluetooth shut off.

② Measuring Unit

Press to change the measuring units (m/ft/in/ft+in)

② Measuring Reference

Press to change the reference (Front/Tripod/Rear) , Rear is the default reference.

③ Digital Level

Digital level Press to activate d , the electronic tilt sensor makes it easier to achieve horizontal alignment with the real-time measuring angle.

④ R Screen rotation

Activate screen orientation setting; it will automatically switch to LANDSCAPE display when the device placed horizontally.

⑥Memory

Press or Press to recall memory values.slide to view history values, press to delete the selected records.

A Measuring interface

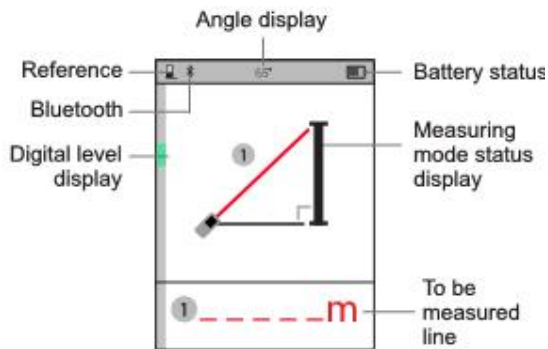

B Summary line

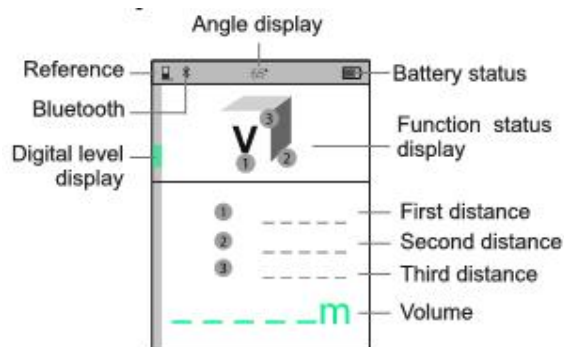

Operation Instructions

The Single distance measurement prompt when it is switched ON. Slide right to function menu, dragging to view all the icons; the latest measuring line and distance data are displayed in Red, Measured data marked in Gray, the summary line displayed in Green.

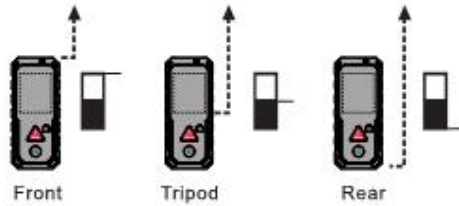

The measuring data should be different due to different reference settings.



Power on the device, measure in the certain distance within $\pm 2\text{mm}$ accuracy, it can work properly.

Single Distance Measurement

The device will come to Single distance measurement when it is switched ON.

Press  after aiming at target to get result in summary line.

Continuous Measurement

The Continuous measurement allows the user to measure the Maximum or Minimum distance from a fixed measuring point. Press and sweep slowly the laser back and forth and up and down over the desired target point.



The value for Maximum and Minimum distances are indicated in the display as well as the last measured value marked in green.

You can choose Max or Min value according to your needs.

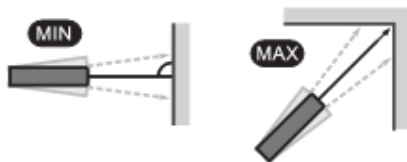
*This function will be stopped automatically after 5 minutes of inactivity.



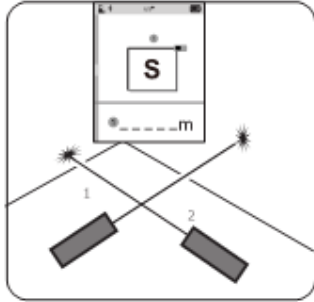

Area Measurement

According to reminding of the red line, press  to get the distance for 1st line (e.g. Length), press  again for 2nd line (e.g. Width), the Area is calculated and displayed in the summary line.



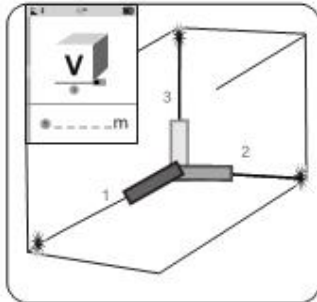

Volume Measurement

According to reminding of the red line, press  to get the distance for 1st line (e.g Length), press  again for 2nd line (e.g Width), press  third time for 3rd line (e.g Height), the Volume is calculated and displayed in the summary line.



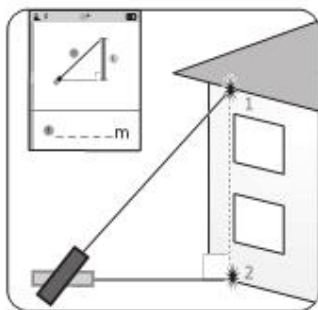

Pythagoras (2-point)

According to reminding of the red line, press  to get the distance of 1st line, change to the horizontal direction of the object from the fixed measuring point, press  again to get the distance of 2nd line, the result is displayed in the summary line.



Pythagoras (3-point) ①

According to reminding of the red line, aiming at 1st target point, press  to get the distance of 1st line, change to the horizontal direction of the object from the fixed measuring point, press  again to get the distance of 2nd Line, move to the 3rd target point, press  to get the distance of 3rd line, the result is displayed in the summary line.

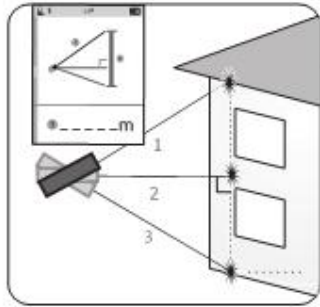

Auto Level Measurement

According to reminding of the red line, press  to get the distance of hypotenuse, vertical and horizontal lines, the result is displayed in line accordingly.

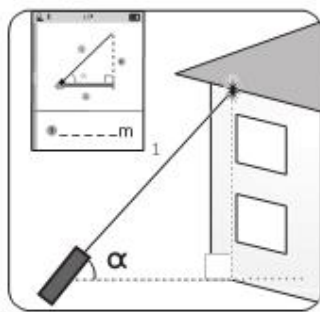

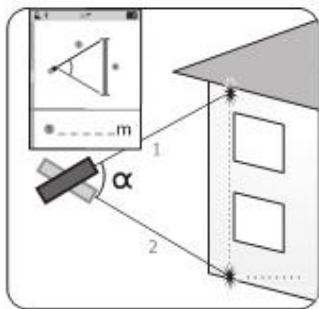

Auto Height Measurement

According to reminding of the red line, press  to get the distance for 1st line; press  again for 2nd line, then you can get vertical height displayed in summary line.



Point to Point (P2P) Measurement

Follow the instruction: "To set the measuring reference for the center point of rotation, wait for stable performance before operating", hold the device still and wait until the instruction icon disappear. According to reminding of the red line, press  to get the distance to 1st laser point, move the device from the fixed measuring point, press  again to get the distance to 2nd laser point, the distance between two points is displayed in the summary line.

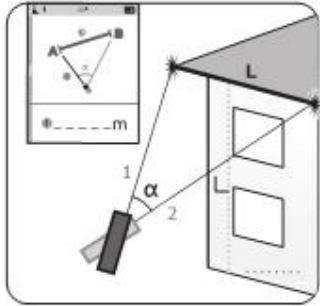

Add/Subtract

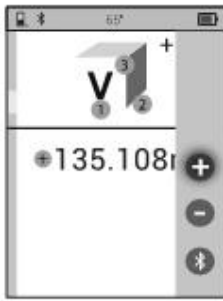

Under the mode of Distance, Area and Volume measurement, slide to left to

Add/subtract Menu, press "+" or "-" to make add/subtraction calculations on the basis of previous record, the result is displayed in the summary line.



Point-finder

No matter under any measuring

circumstances, when the laser dot can't be confirmed, press  to locate the target on the screen. Press  to zoom in/out 2x or 4x the image. Once target confirmed, press  to get the distance result on the screen.

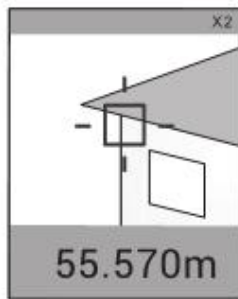

Trouble Shooting

All errors or failures will be shown as codes.

The following table explains the meaning of codes and solutions.

Code	Cause	Corrective Measure
------	-------	--------------------

204	Calculation error	Refer to user manual, repeat the procedures.
208	Excessive current	Please contact your distributor
220	Low battery	Replace new batteries.
252	Temperature too high	Let device cool down
253	Temperature too low	Warm device up
255	Received signal, too weak or Measuring time too long	Change target surface
256	Change target surface	Change target surface
261	Out of the range of measurement	Select the measurement distance within the range of measurement.
500	Hardware error	Switch on/off the device several times. If the symbol still appears, please contact your dealer for assistance

App Download



iOS download



Android download

Contact Us

Shenzhen Mileseey Technology Co., LTD.

Email: info@mileseey.net

Tel: +86 755 86329055

Fax: +86 755 86701592

Website: www.mileseey.net

Add.: 6/F, Building 9, Zhongguan Honghualing, Industrial South Park II, 1213, Liuxian Ave, Taoyuan Street, Nanshan District, Shenzhen, 518055, P.R. China.

Copyrights

The product specifications are subject to change without notice, all final interpretation rights were reserved by Mileseey Technology Co., Ltd. All trademarks, product images, technical parameters are properties of Mileseey Technology Co., Ltd. All rights reserved.

