

MINOLTA

The essentials of imaging

www.minoltaeurope.com

DiMAGE 7

DiMAGE 5



9224-2773-11 H-A106

E INSTRUCTION MANUAL

BEFORE YOU BEGIN

Thank you for purchasing this Minolta digital camera. Please take the time to read through this instruction manual so you can enjoy all the features of your new camera.

This manual contains information regarding products introduced before June, 2001. To obtain compatibility information for products released after this date, contact a Minolta Service Facility.

Check the packing list before using this product. If any items are missing, immediately contact your local camera dealer.

Minolta DiMAGE digital camera
AA alkaline batteries (set of four)
Neck strap for DiMAGE 7/5 NS-DG7
Lens shade for DiMAGE 7/5 DLS-7
16MB CompactFlash card
Video cable for DiMAGE 7/5 VC-100
USB cable for DiMAGE 7/5 USB-100
DiMAGE software CD-ROM
DiMAGE Image Viewer Utility version 1.1 instruction manual
Camera manual
Quick Reference Guide
Warranty card

Because the low performance of alkaline batteries with digital cameras, the use of Ni-MH batteries is recommended.

FOR PROPER AND SAFE USE

Read and understand all warnings and cautions before using this product.

WARNING

Using batteries improperly can cause them to leak harmful solutions, overheat, or explode which may damage property or cause personal injury. Do not ignore the following warnings.

- Only use the batteries specified in this instruction manual.
 - Do not install the batteries with the polarity (+/-) reversed.
 - Do not use batteries which show wear or damage.
 - Do not expose batteries to fire, high temperatures, water, or moisture.
 - Do not attempt to short or disassemble batteries.
 - Do not store batteries near or in metallic products.
 - Do not mix batteries of different types, brands, ages, or charge levels.
 - Do not charge alkaline batteries.
 - When recharging rechargeable batteries, only use the recommended charger.
 - Do not use leaking batteries. If fluid from the batteries enters your eye, immediately rinse the eye with plenty of fresh water and contact a doctor. If fluid from the batteries makes contact with your skin or clothing, wash the area thoroughly with water.
-
- Use only the specified AC adaptor within the voltage range indicated on the adaptor unit. An inappropriate adaptor or current may cause damage or injury through fire or electric shock.
 - Do not disassemble this product. Electric shock may cause injury if a high voltage circuit inside the product is touched.
 - Immediately remove the batteries or unplug the AC adaptor and discontinue use if the camera is dropped or subjected to an impact in which the interior, especially the flash unit, is exposed. The flash has a high voltage circuit which may cause an electric shock resulting in injury. The continued use of a damaged product or part may cause injuries or fire.

FOR PROPER AND SAFE USE

- Keep batteries or small parts that could be swallowed away from infants. Contact a doctor immediately if an object is swallowed.
- Store this product out of reach of children. Be careful when around children, not to harm them with the product or parts.
- Do not fire the flash directly into the eyes. It may damage eyesight.
- Do not fire the flash at vehicle operators. It may cause a distraction or temporary blindness which may lead to an accident.
- Do not use the monitor while operating a vehicle or walking. It may result in injury or an accident.
- Do not use this product in a humid environment, or operate this product with wet hands. If liquid enters the product, immediately remove the batteries or unplug the AC adaptor and discontinue use. The continued use of a product exposed to liquids may cause damage or injury through fire or electric shock.
- Do not use the product near inflammable gases or liquids such as gasoline, benzine, or paint thinner. Do not use inflammable products such as alcohol, benzine, or paint thinner to clean the product. The use of inflammable cleaners and solvents may cause an explosion or fire.
- When unplugging the AC adaptor, do not pull on the power cord. Hold the adaptor unit when removing it from an outlet.
- Do not damage, twist, modify, heat, or place heavy objects on the AC adaptor cord. A damaged cord may cause damage or injury through fire or electric shock.
- If the product emits a strange odor, heat, or smoke, discontinue use. Immediately remove the batteries taking care not to burn yourself as the batteries become hot with use. The continued use of a damaged product or part may cause injuries or fire.
- Take the product to a Minolta Service Facility when repairs are required

CAUTION

- Do not use or store the product in a hot or humid environment such as the glove compartment or trunk of a car. It may damage the product and batteries which may result in burns or injuries caused by heat, fire, explosion, or leaking battery fluid.
- If batteries are leaking, discontinue use of the product.
- The camera temperature rises with extended periods of use. Care should be taken to avoid burns.
- Burns may result if the CompactFlash card or batteries are removed immediately after extended periods of use. Turn the camera off and wait for it to cool.
- Do not fire the flash while it is in contact with people or objects. The flash unit discharges a large amount of energy which may cause burns.
- Do not apply pressure to the LCD monitor. A damaged monitor may cause injury, and the liquid from the monitor may cause inflammation. If liquid from the monitor makes contact with skin wash the area with fresh water. If liquid from the monitor comes in contact with the eyes, immediately rinse the eyes with plenty of water and contact a doctor.
- The rim of the lens hood can cause injury. Take care not to accidentally strike anyone with the camera when the lens hood is attached.
- When using the AC adaptor, insert the plug securely into the electrical outlet.
- Do not use if the AC adaptor cord is damaged.
- Do not cover the AC adaptor. A fire may result.
- Do not obstruct access to the AC adaptor; this can hinder the unplugging of the unit in emergencies.
- Unplug the AC adaptor when cleaning or when the product is not in use.

TABLE OF CONTENTS

Names of parts	
Camera body	10
Data panel	13
EVF and LCD monitor display	14
Getting up and running.....	15
Camera-shake warning	15
Attaching the camera strap	16
Removing the lens cap	16
Attaching the lens hood.....	17
Inserting batteries.....	18
Inserting the CompactFlash card	18
Handling the camera	19
Turning on the camera and displays	19
Taking pictures.....	20
Using the built-in flash	21
Flash range - automatic operation.....	21
Viewing and deleting pictures in quick view	22
Basic operation	23
Changing batteries	24
Battery condition indicators	25
Auto power save	25
External power supplies (sold separately).....	26
Changing the CompactFlash card.....	26
Setting the camera to record images automatically	28
EVF and LCD monitor display	28
Basic recording operation.....	29
Focus lock.....	30
Focus signals.....	31
Special focusing situations	31
Display controls - recording mode.....	32
Quick view	34
Deleting images in quick view.....	35
Recording mode - advanced operation	36
What is an Ev? What is a stop?	36
Pro-auto button	37
Digital-subject-program button.....	38
Setting the function dial	40
Image size	42

Image quality	43
About super-fine and RAW image quality.....	44
Image-file size and CompactFlash card capacity.....	45
Exposure modes.....	46
Program - P	47
Program shift.....	47
Aperture priority - A	48
Shutter priority - S.....	49
Manual exposure - M.....	50
Drive modes	51
Continuous advance	52
Self-timer.....	53
Bracketing	54
Exposure bracketing	54
Digital Enhanced Bracketing.....	55
Interval	56
White balance.....	58
Automatic white balance.....	59
Preset white balance	59
Custom white balance	60
Camera sensitivity - ISO.....	61
Digital Effects Controller	62
Exposure compensation	63
Contrast compensation	64
Color-saturation compensation.....	65
Autofocus areas and control.....	66
Flex Focus Point	67
Autofocus modes	68
Macro mode.....	69
Digital zoom.....	70
Manual focus	71
Electronic magnification (DiMAGE 7 only).....	71
Electronic viewfinder.....	72
Diopter adjustment.....	72
Automatic monitor amplification (DiMAGE 7 only).....	72
AF/AEL button	73
Metering modes.....	74
Flash metering.....	75

TABLE OF CONTENTS

Flash modes	76
Flash compensation	78
Flash range.....	79
Attaching a Minolta accessory flash (sold separately)	79
Navigating the recording-mode menu	80
Recording-mode menu - Basic.....	82
Recording-mode menu - Custom 1	83
Recording-mode menu - Custom 2	84
Memory - storing camera settings.....	85
Sharpness	86
Color mode	86
Data imprinting	87
Electronic keyboard	88
Instant playback.....	89
Movie recording	90
Bulb exposures.....	92
Attaching a remote cord (sold separately)	92
Playback mode - viewing and editing images	93
Viewing pictures	94
Viewing movies.....	95
Deleting images.....	95
Single-frame playback display	96
Movie playback display	96
Histogram display	97
Display controls - playback mode.....	98
Enlarged playback	100
Navigating the playback-mode menu	102
Playback-mode menu - basic	104
Deleting images	104
Locking images.....	105
Changing the index playback format	105
Playback-mode menu - Custom 1 (Slide Show).....	106
Playback-mode menu - Custom 2	108
About DPOF	108
Creating a DPOF print order.....	108
Ordering an index print	109
Canceling a DPOF print order	109
Copying images	110

Frame-selection screen	111
Viewing images on a television	112
Setup mode - controlling the camera's operation.....	113
Navigating the setup menu.....	114
Setup menu - basic	116
EVF and LCD monitor brightness.....	116
Formatting CompactFlash cards.....	116
Auto power save	117
Beep.....	117
Language	117
Setup menu - Custom 1	118
File number memory.....	118
Select folder	118
New folder.....	119
Setup menu - Custom 2	120
Reset default.....	120
EVF auto switch.....	121
Setting the date and time.....	122
Setting the date format	122
Video output.....	122
Data-transfer mode.....	123
Connecting the camera to a computer	124
Connecting to Windows 98.....	126
Automatic installation.....	126
Manual installation	127
Connecting to Mac OS 8.6	129
QuickTime 4.1 system requirements	129
CompactFlash card folder organisation.....	130
Auto power save (Data-transfer mode).....	131
Disconnecting the camera from the computer	132
Changing the CompactFlash card (data-transfer mode)	134
Appendix	135
A short guide to photography	136
System accessories.....	138
Troubleshooting	139
When using filters with the DiIMAGE 7	141
Care and storage.....	142
Technical specifications/NOTE ABOUT BATTERIES	146

NAMES OF PARTS

CAMERA BODY

* This camera is a sophisticated optical instrument. Care should be taken to keep these surfaces clean. Please read the care and storage instructions in the back of this manual (p. 142).

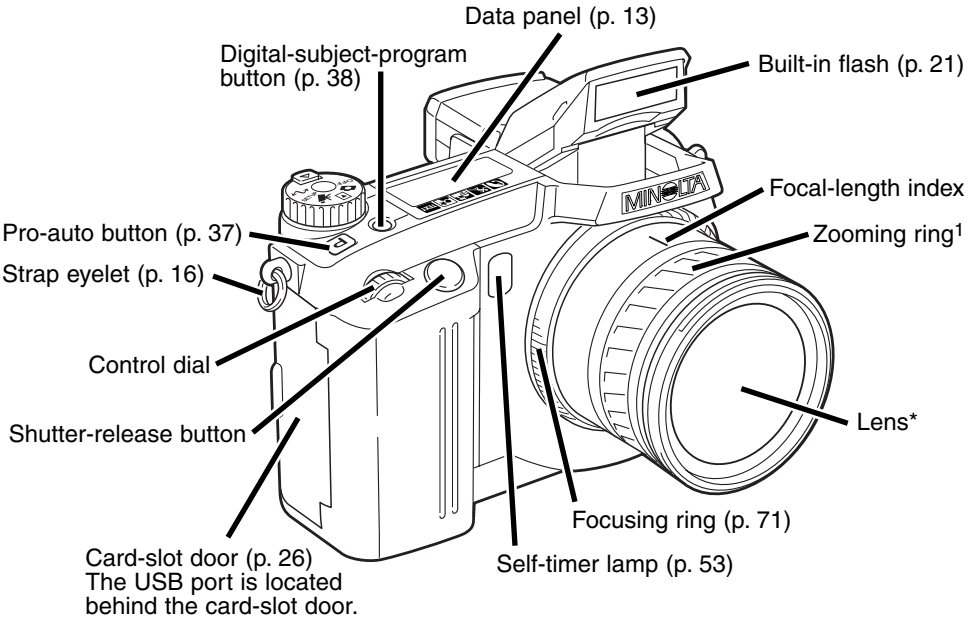

1. The focal-length scale on the zooming ring is given in 35mm focal-length equivalents. Both cameras have a 7.2 - 50.8 mm Minolta GT lens, but because of the CCD size the DiMAGE 7 has an equivalent zooming range of 28 - 200mm and the DiMAGE 5 has an equivalent of 35 - 250mm. For more on equivalent focal lengths, see page 135.

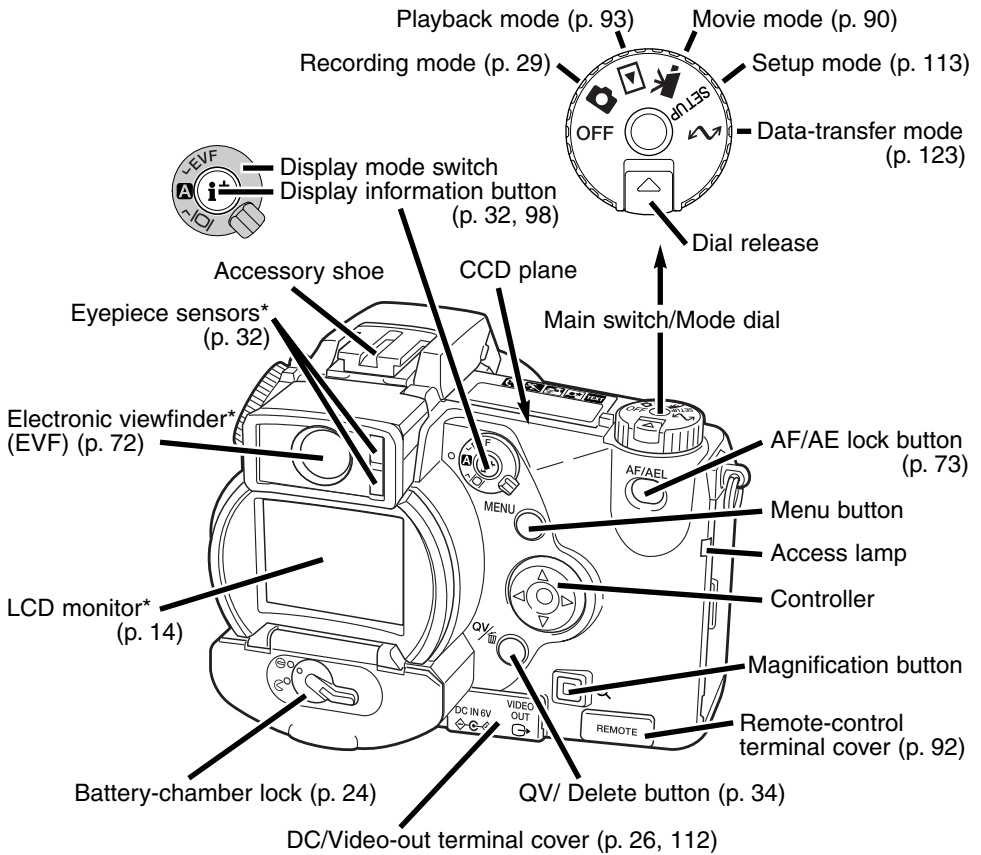

NAMES OF PARTS

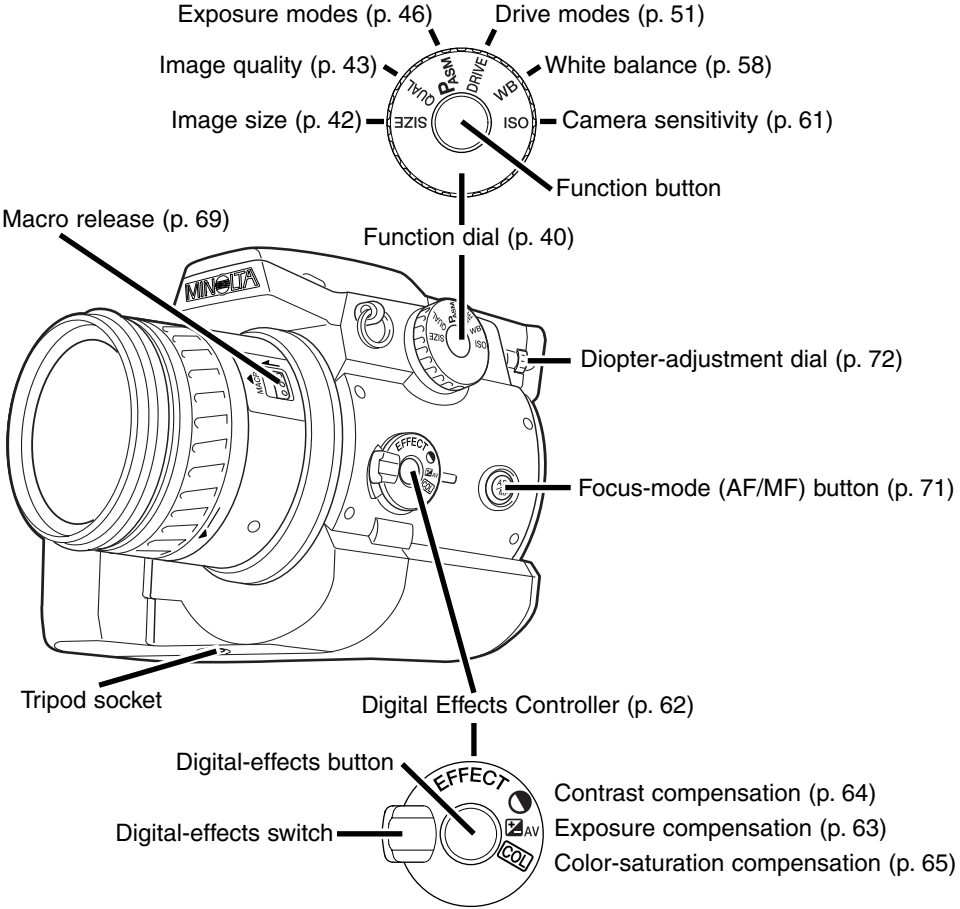

DATA PANEL

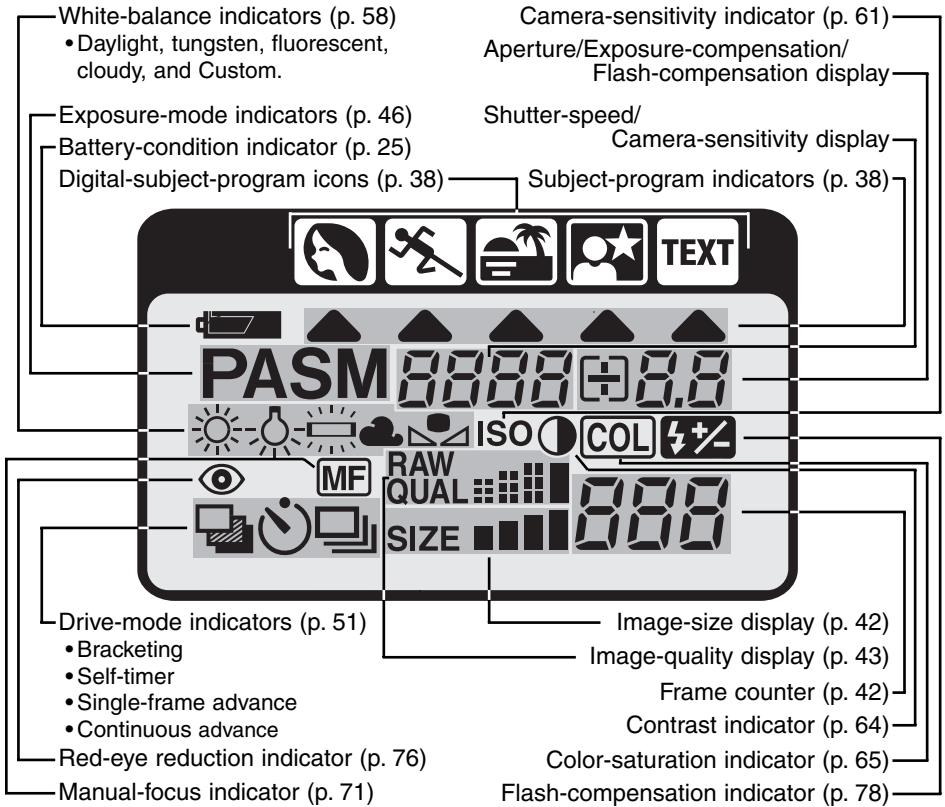

NAMES OF PARTS

EVF AND LCD MONITOR DISPLAY

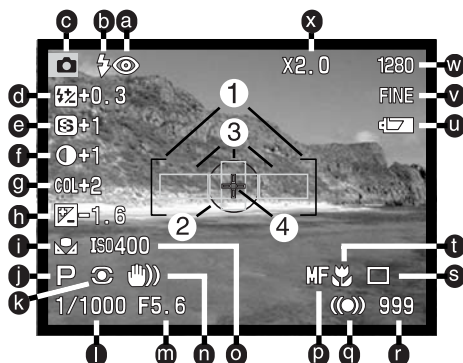

- a. Flash-mode indicators (p. 76)
- b. Flash signals (p. 21)
- c. Mode indicator
- d. Flash-compensation display (p. 78)
- e. Sharpness display (p. 86)
- f. Contrast-compensation display (p. 64)
- g. Color-saturation-compensation display (p. 65)
- h. Exposure-compensation display (p. 63)
- i. White-balance indicators (p. 58)
- j. Exposure-mode/Digital-subject-program indicators (p. 46/38)
- k. Metering-mode indicators (p. 74)
- l. Shutter-speed display
- m. Aperture display
- n. Camera-shake warning (p. 15)
- o. Camera-sensitivity (ISO) display (p. 61)
- p. Manual-focus indicator (p. 71)
- q. Focus signals (p. 31)
- r. Frame counter (p. 42)
- s. Drive-mode indicators (p. 51)
- t. Macro-mode indicator (p. 69)
- u. Battery-condition indicator (p. 25)
- v. Image-quality indicator (p. 43)
- w. Image-size indicator (p. 42)
- x. Digital-zoom (Electronic-magnification) indicator (p. 70)
- 1. Focus frame
- 2. Spot metering area (p. 74)
- 3. AF sensors (p. 29)
- 4. Flex Focus Point (p. 67)

GETTING UP AND RUNNING

This is a quick reference guide so that the camera can be used as soon as possible. However, it is recommended that the entire manual be read to properly operate the camera and to achieve the best results.

CAMERA-SHAKE WARNING

If the shutter speed falls below the point where the camera can be hand held safely, the camera-shake warning will appear in the EVF and LCD monitor. Camera shake is slight blurring caused by subtle hand motion and is more pronounced at the telephoto setting of the lens than at the wide-angle setting. The warning appears at approximately the reciprocal of the focal length used; if the lens is set at 100mm, the camera shake warning will appear at 1/100 second. Although the warning appears, the shutter can still be released. If the warning appears, the following steps can be taken:

- Place the camera on a tripod.
- Use the built-in flash (p. 21).
- Increase the camera sensitivity (ISO) (p. 61).
- Zoom the lens towards the wide-angle position.



GETTING UP AND RUNNING

ATTACHING THE CAMERA STRAP

Attach the camera strap to the strap eyelets as shown.

- Always keep the camera strap around your neck incase you drop the camera.

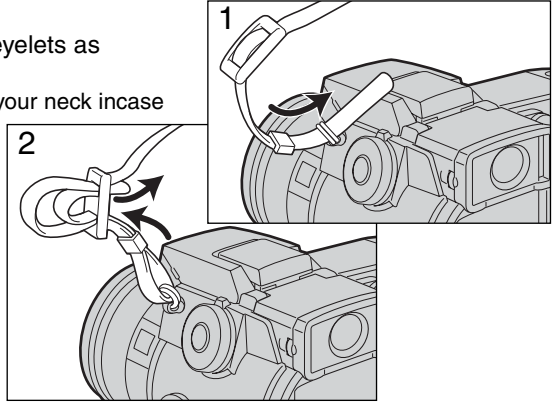

REMOVING THE LENS CAP

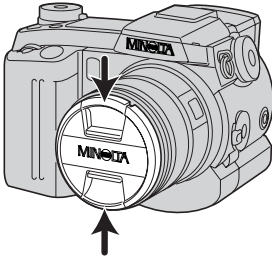

Using your thumb and index finger, pinch the inside or outside tabs of the lens cap to remove.

- When the camera is not in use, always replace the lens cap.

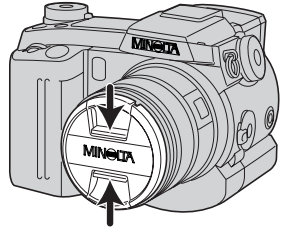

ATTACHING THE LENS HOOD

The lens hood is used to control stray light from entering the lens and causing flare. When using the camera under bright light, the use of the lens hood is recommended. The lens hood should not be used with the built-in flash as it can cause a shadow.

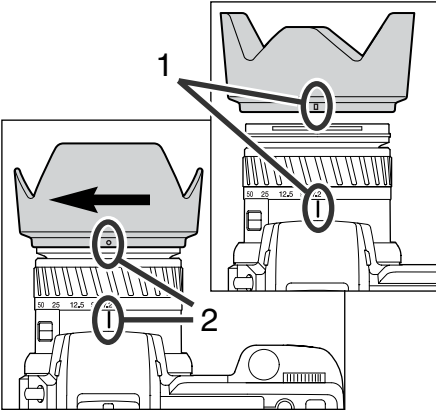

To mount the lens hood, align the rectangular raised line on the rim of the hood with the focal-length index on the top of the lens barrel

Slide the hood onto the end of the lens and turn it 90° clockwise until it clicks and the circular raised dot is aligned with the focal-length index.

- When mounted correctly, the large petals of the lens hood should be to the top and bottom.
- Never force the lens hood. If it does not fit, check its orientation.
- To detach the lens hood, turn it 90° counterclockwise and remove.

The lens hood can be reverse mounted when the camera is not in use.

With one of the large petals to the top, slide the hood onto the end of the lens. Turn it 90° clockwise until it clicks.

- The lens hood can be attached or removed with the lens cap on the camera.
- To detach the lens hood, turn it 90° counterclockwise and remove.

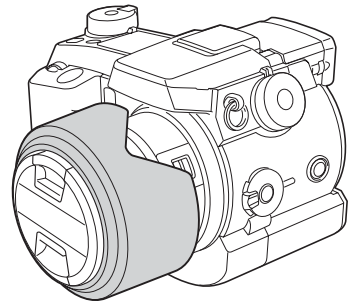

GETTING UP AND RUNNING

INSERTING BATTERIES

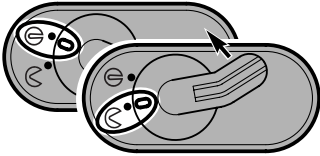

Open the battery-chamber door by moving the battery-chamber lock to the open position .

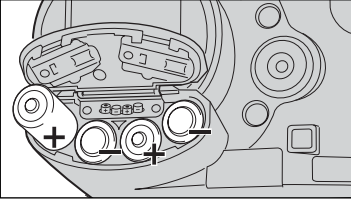

Insert the batteries.

- Make sure the positive and negative battery terminals are orientated as illustrated on the diagram in the battery chamber.



INSERTING THE COMPACTFLASH CARD

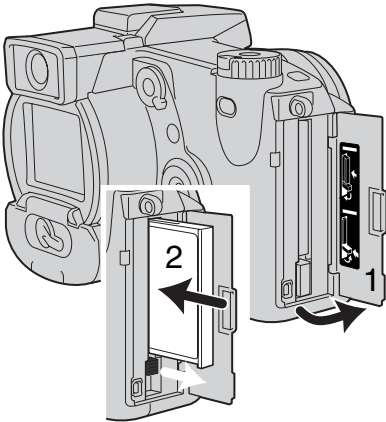

Open the card-slot door (1).

Insert the CompactFlash card (2) and fold down the card-eject lever.

- Insert the card so that the face is toward the front of the camera. Always push the card in straight, never at an angle. Never force the card. If the card does not fit, check its orientation.

HANDLING CAMERA

While using the electronic viewfinder (EVF) or LCD monitor, grip the camera firmly with your right hand while supporting the body with the palm of your left hand. Keep your elbows at your side and your feet shoulder-width apart to hold the camera steadily.

The EVF can be tilted between 0° and 90°. This is useful for low-level camera positions.

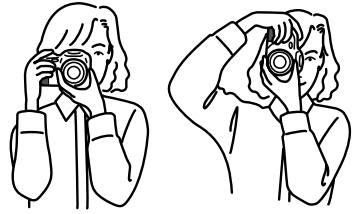

TURNING ON THE CAMERA AND DISPLAYS

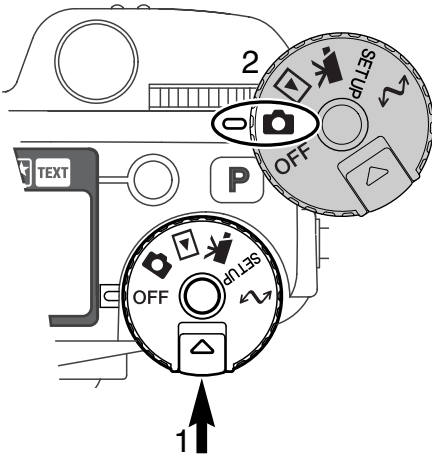

While pushing in the dial release (1), turn the mode dial (2) to the still-image recording position.

The display switch at the back of the camera controls which display will activate during camera operation. Turn the switch to the auto-display position (A); the display will alternate between the electronic viewfinder (EVF) and LCD monitor automatically.

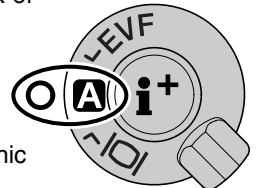

Display switch

GETTING UP AND RUNNING

TAKING PICTURES

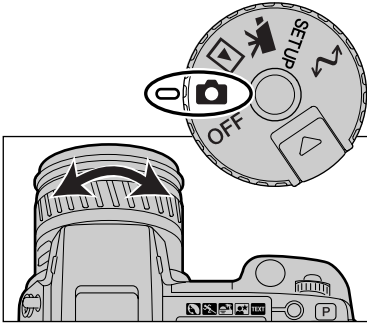

With the mode dial set to still-image recording, the camera will be on and the electronic viewfinder (EVF) and LCD monitor will activate.

The zooming ring can be used to frame your subject. The effect of the zoom is immediately displayed on the EVF and LCD monitor.



Compose the image in the EVF or on LCD monitor taking care to place the subject within the focus frame.

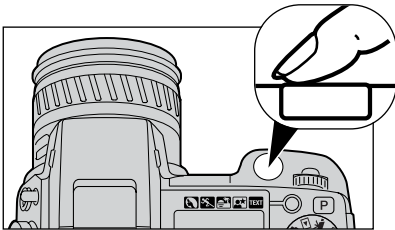

Press the shutter-release button all the way down to take the picture.

- The access lamp will glow indicating the image data is being written to the CompactFlash card. Never remove the CompactFlash card while data is being transferred.



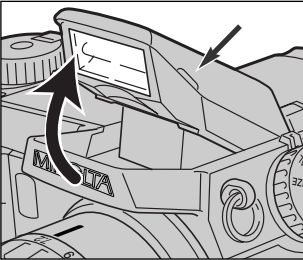

USING THE BUILT-IN FLASH

In low-light conditions or indoors, the flash is needed to illuminate the subject and reduce blurring through camera shake. The flash can also be used as a fill light in direct sunlight to soften harsh shadows.



To use the flash, simply pull up the unit by the tabs on each side. Icons will appear in the upper left corner of the EVF and LCD monitor (see chart below).

- The flash position must be set manually.
- The flash will always fire regardless of the amount of ambient light.
- Always remove the lens hood when using the built-in flash. The hood may cast a shadow if mounted.

	Flash warning. In backlit situations, the icon will appear to recommend the use of the flash.
	When pressing the shutter-release button partway down, the red flash icon indicates the flash is charging.
	When pressing the shutter-release button partway down, the white flash icon indicates the flash is ready to fire.
	After taking the picture, a blue flash icon will appear if the flash properly exposed the subject.

FLASH RANGE - AUTOMATIC OPERATION

The camera will automatically control the flash output. For well-exposed images, the subject must be within the flash range. Because of the optical system, the flash range is not the same at the lens' wide-angle position as it is at the telephoto position.

Wide-angle position	0.5m ~ 3.8m (1.6 ft. ~ 12.5 ft.)
Telephoto position	0.5m ~ 3.0m (1.6 ft. ~ 9.8 ft.)

GETTING UP AND RUNNING

VIEWING AND DELETING PICTURES IN QUICK VIEW

Captured images can be viewed in recording mode. Simply press the QV/delete button to access the images, and use the controller to scroll through the pictures on the CompactFlash card.

In quick view, images can also be deleted. Care should be taken when deleting image; once deleted it is impossible to recover the picture. When selecting an image for deletion, a confirmation screen will appear before the operation is executed. For more information about quick view, see page 34.

1 Press the QV/delete button to playback the recorded images.

2 Use the left/right keys of the controller to scroll through the images.



3 To delete the displayed image, press the QV/delete button.

- A confirmation screen will appear.

4 Use the left/right keys to highlight “YES.”

- Choosing “NO” will cancel the operation.

5 Pressing the controller will delete the image.



6 Press the menu button to return to the recording mode.

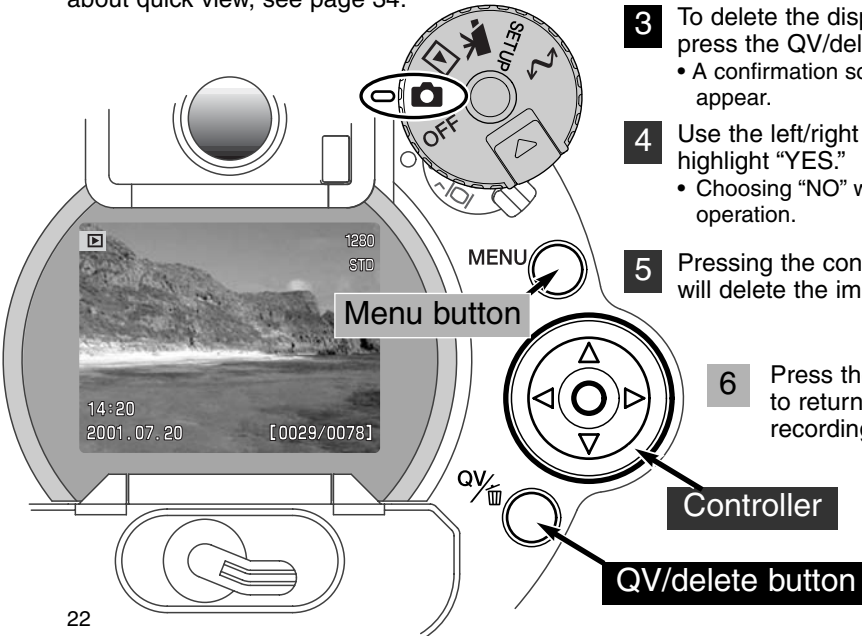

BASIC OPERATION

This section covers the basic operation of the camera. Please thoroughly familiarise yourself with the operations in this section before moving on to other sections in the manual.

BASIC OPERATION

CHANGING BATTERIES

This digital camera uses four AA-size batteries. Ni-MH batteries can be used, and are recommended as they will offer longer life. When using Ni-MH batteries, fully recharge them with a battery charger suitable for Nickel Metal Hydride cells. Please consult your vendor about an appropriate charger.

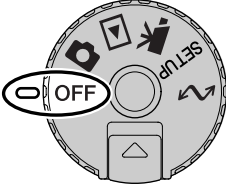

When replacing batteries, check that the mode dial is in the off position.

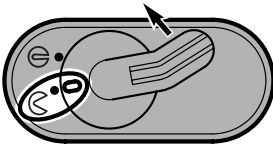

Open the battery-chamber door by moving the battery-chamber lock to the open position ☞ .

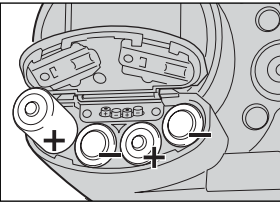

Insert the batteries.

- Make sure the positive and negative battery terminals are orientated as illustrated on the diagram in the battery chamber.

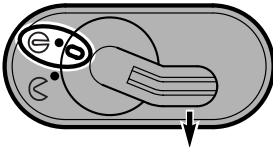

Close the battery-chamber door and slide the lock lever to the close position ☹ .

BATTERY-POWER INDICATORS

This camera is equipped with an automatic battery-condition indicator. When the camera is on, the battery-condition indicator appears on the data panel and monitors. The monitor icon will change from white to red when battery power is low. If the data panel and monitors are blank, the batteries may be dead or installed incorrectly.



Full-battery icon - The batteries are fully charged. This icon is displayed for five seconds on the monitors when the camera is turned on. The icon remains on the data panel.



Low battery warning - Battery power is very low, but all functions are operational. The battery should be replaced as soon as possible. This warning automatically appears and remains on the display until the batteries are changed.

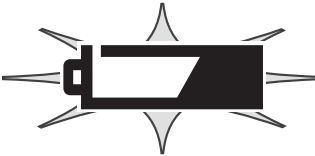

Blinking low battery icon - When displayed on the data panel with no other icons, power is insufficient for camera operation. The shutter will not release. Replace the batteries immediately.

AUTO POWER SAVE

To conserve battery power, the camera will turn off displays and unnecessary functions if an operation is not made within a certain period. The LCD monitor will turn off after thirty seconds. The EVF and data panel turn off after one minute. To restore the displays, press the shutter-release button partway down or press the display-information button. The length of the auto-power-save period for the EVF and data panel can be changed in the basic section of the setup menu (p. 114).

BASIC OPERATION

EXTERNAL POWER SUPPLIES (SOLD SEPARATELY)

The AC Adaptor allows the camera to be powered from an electrical household outlet. During periods of heavy use, the AC Adaptor can conserve battery power. Its use is recommended when the camera is interfaced with a computer. AC Adaptor model AC-1L is for use in North America, and AC-2L is for use in all other areas.

The External High-power Battery Pack Kit EBP-100 is a portable source of power for the camera. This battery pack will significantly extend the operating time of the camera.

Do not change the power supply while the camera is on. Always turn off the camera before changing between power supplies.

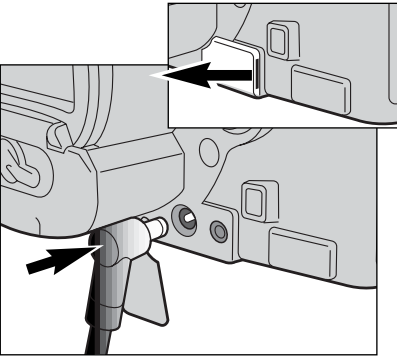

Remove the DC terminal cover by using the notch on the right.

- The cover is attached to the body to prevent loss.

Always remove exhausted batteries before connecting an external power supply!

Insert the mini plug of the AC adaptor or battery pack into DC terminal.

Insert the AC adaptor plug into an electrical outlet.

CHANGING THE COMPACTFLASH CARD

A CompactFlash card must be inserted for the camera to operate. If a card has not been inserted, a “no-card” warning will automatically be displayed on the monitors. IBM Microdrives are compatible with this camera. For recording media care and storage, see page 143.

Always turn off the camera and confirm the access lamp is not lit before inserting or removing a CompactFlash card otherwise the card may be damaged, and data lost.

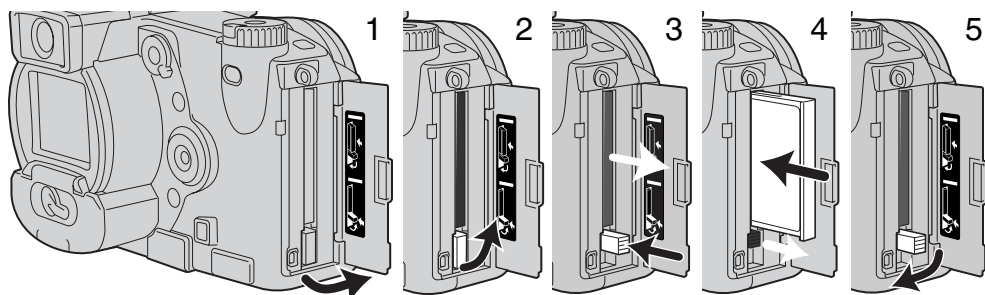

Open the card-slot door in the direction indicated (1).

To eject a CompactFlash card, lift (2) then press (3) the card-eject lever. The card can now be pulled out.

- Take care when removing the card as it becomes hot with use.

Insert the CompactFlash card into the card slot until the card-eject lever pops out (4).

- Insert the card so the face is toward the front of the camera. Always push the card in straight, never at an angle. Never force the card. If the card does not fit, check that it is orientated correctly.

Fold the card-eject lever down as shown (5) and close the card-slot door.

If the card-not-recognised message appears, the inserted card in the camera may need to be formatted. A CompactFlash card used in another camera may need to be formatted before being used. If the “unable-to-use-card” message appears, the card is not compatible with the camera and should not be formatted. A card can be formatted in the basic section of the setup menu (p. 116). When a card is formatted, all the data on the card is permanently erased.

BASIC OPERATION

SETTING THE CAMERA TO RECORD IMAGES AUTOMATICALLY

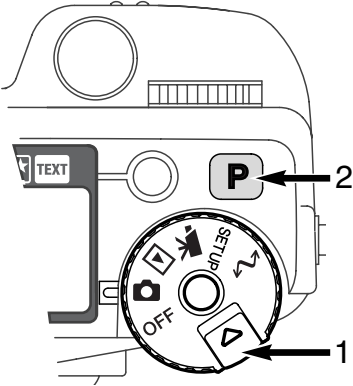

While holding in the dial release (1), turn the mode dial to still-image recording. Press the pro-auto button (2) to reset the programmed and automatic functions.

All camera operations are now fully automatic. The autofocus, exposure, and imaging systems will work together to bring professional results effortlessly.

EVF AND LCD MONITOR DISPLAY

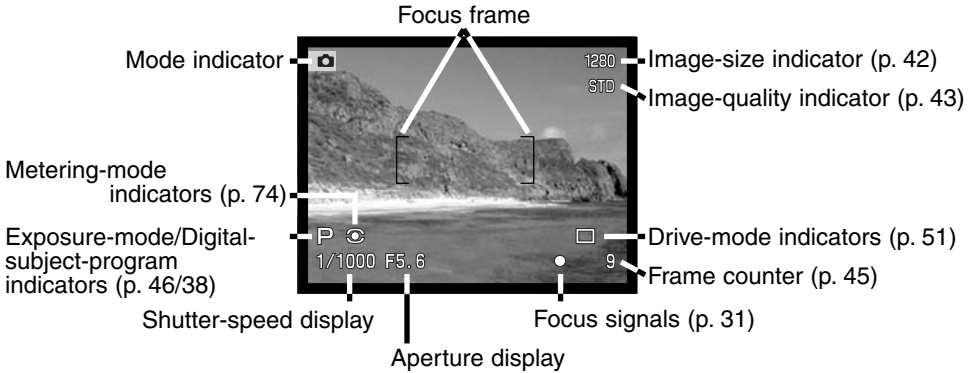

BASIC RECORDING OPERATION

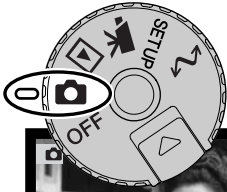

With the mode dial set to still-image recording, the camera will be on and the electronic viewfinder (EVF) and LCD monitor will activate.

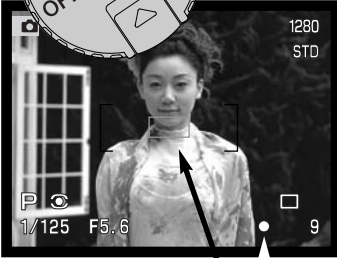

Place the subject within the focus frame.

- For off centre subjects use the focus-lock function (p. 30).
- Make sure the subject is within the focus range of the lens: 0.5m - ∞. For subjects closer than 0.5m, use the macro function (p. 69).

Press the shutter-release button partway down (1) or press and hold the AF/AEL button (2) to lock the focus and exposure.

- The focus signals (p. 31) in the monitors will confirm that the image is in focus. If the focus signal is red, the camera was unable to focus on the subject. Repeat the previous steps until the signal is white.
- When the focus is set, an AF sensor symbol will briefly appear on the live image to indicate the point of focus.
- The shutter speed and aperture value will change from white to black indicating the exposure is locked.

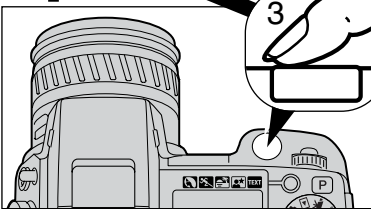
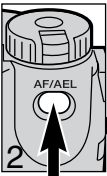

Press the shutter-release button all the way down (3) to take the picture.

- The access lamp will glow indicating the image data is being written to the CompactFlash card. Never remove a CompactFlash card while data is being transferred.

BASIC OPERATION

FOCUS LOCK

The focus-lock function is used when the subject is off-centre and outside the focus frame. Focus lock may also be used when a special focusing situation prevents the camera from focusing on the subject.

Focus lock can be controlled one of two ways. The shutter-release button can be pressed and held partway down or the AF/AEL button at the back of the camera can be pressed and held.



Place the subject within the focus frame. Press and hold the shutter-release button partway down or press the AF/AEL button.

- The focus signals will indicate that the focus is locked. The shutter speed and aperture value will change from white to black indicating the exposure is locked.
- When the focus is set, an AF sensor will briefly appear on the live image to indicate the point of focus.



Without lifting your finger from the shutter-release button or the AF/AEL button, recompose the subject within the image area. Press the shutter-release button all the way down to take the picture.

The function and operation of the AF/AEL button can be changed in the Custom 1 section of the recording-mode menu (p. 80). The Flex Focus Point can also be used for off-centre subjects (p. 67).

FOCUS SIGNALS

This digital camera has a quick, accurate autofocus system. The focus signals in the lower right corner of the EVF and LCD monitor indicate the focus status. For more information on autofocus modes see p. 68.

○	Focus icon: white	Focus confirmed.
●	Focus icon: red	Cannot focus. The subject is too close or a special situation is preventing the AF system from focusing.

- The shutter can be released even if the camera cannot focus on the subject.
- When the AF system cannot focus, the focus is set to infinity. When the flash is in use, the focus is set between 3.0 and 3.8m. In this case, focus lock can be used with an object at the same distance as the main subject or the camera can be focused manually (p. 71).

SPECIAL FOCUSING SITUATIONS

The camera may not be able to focus in certain situations. If the autofocus system cannot focus on a subject, the focus icon will turn red. In this situation the focus-lock function can be used to focus on another object at the same distance as your main subject, and then the image can be recomposed to take the picture.

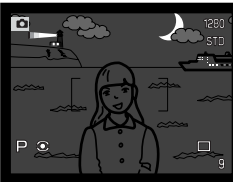

The subject is too dark.

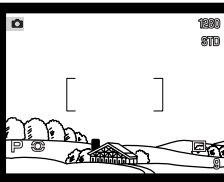

The subject in the focus frame is low in contrast.

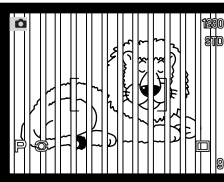

Two subjects at different distances overlap in the focus frame.

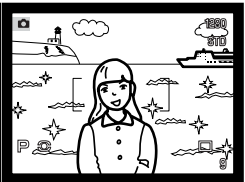

The subject is near a very bright object or area.

BASIC OPERATION

DISPLAY CONTROLS - RECORDING MODE

Located on the back of the camera, the display-mode switch and the display-information button controls on which monitor the image is displayed and what information is included in the display. The three position switch allows the choice between automatic display and setting the display to the EVF or LCD monitor.

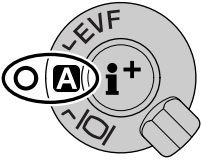

Auto display - the camera will automatically change between displaying the live image in the EVF or on the LCD monitor. The EVF's eye sensors monitor if the EVF is being used and switches the display location accordingly.

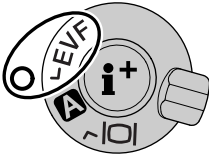

EVF display - the live image will only be displayed in the electronic viewfinder. Under bright-light, the image is easier to see in the EVF than on the LCD monitor.



LCD monitor display - the live image will only be displayed on the LCD monitor.

If battery power is a concern, have the eye sensor activate the EVF when in use, but not the LCD monitor. The auto-display function can be changed in the Custom 2 section of the setup menu (p. 114).



In the centre of the display switch, the display-information button controls what information is displayed with the live image. Each time the button is pressed the display cycles to the next format: full display (shooting data, warnings, and focus frame), warnings and focus frame, live image only.



Full display



Warnings and focus frame



Live image only

- A warning will be displayed if battery power is low, autofocus cannot lock, or exposure is beyond the aperture and shutter-speed range.

BASIC OPERATION

QUICK VIEW

Captured images can be viewed in recording mode. Simply press the QV/delete button to access the images, and use the controller to scroll through the pictures on the CompactFlash card. Images can be displayed with various information: date, frame number, printing status, and lock status. A histogram of the image with shooting data can be displayed. For more information on the histogram display, see page 97.

- 1** Press the QV/delete button to play back the recorded images.
- 2** Use the left/right keys of the controller to scroll through the images.
- 3** Press the up key to see the histogram of the displayed image.
 - Pressing the down key returns to quick view.
- 4** To return to the recording mode, press the menu button .

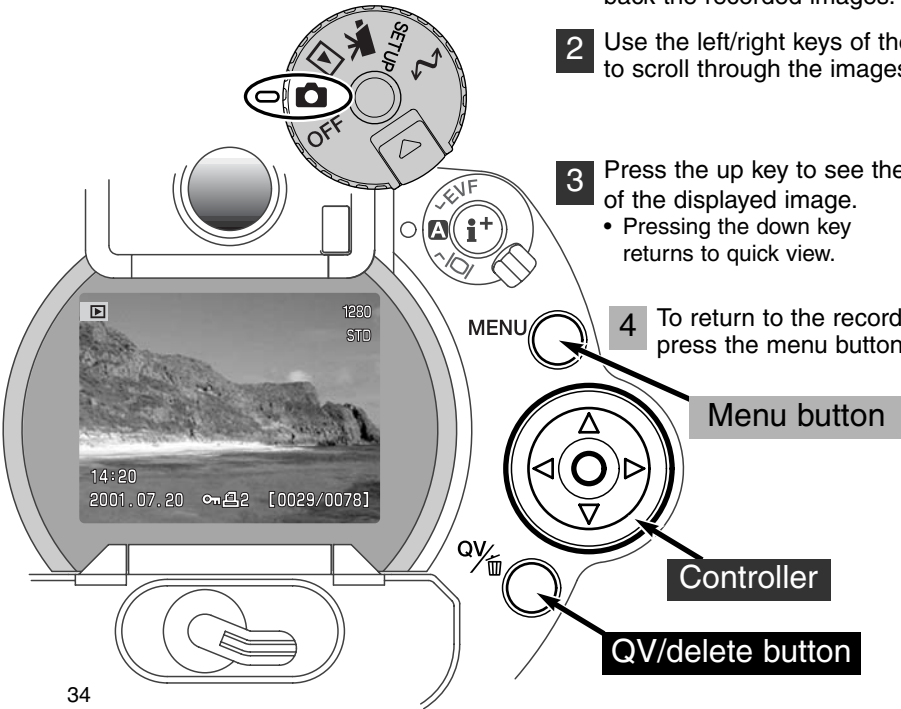

QUICK-VIEW DISPLAY

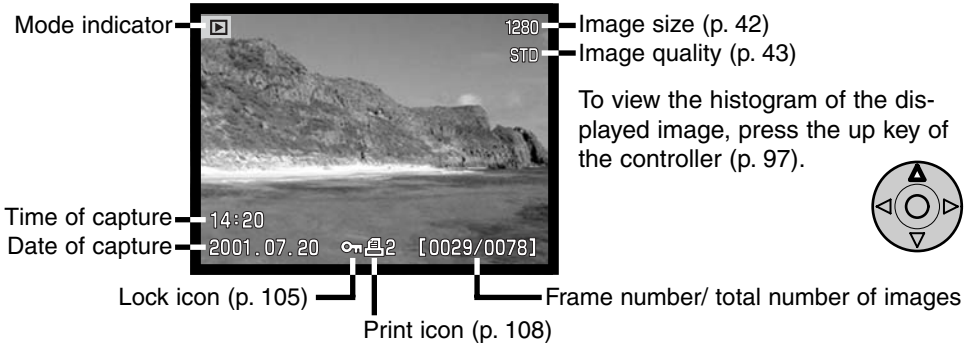

DELETING IMAGES IN QUICK VIEW

In quick view, the displayed image can be deleted. When selecting an image for deletion, a confirmation screen will appear before the operation is executed.

Once deleted, an image cannot be recovered. Care should always be taken when deleting images.

- 1 To delete a displayed image, press the QV/delete button.
 - A confirmation screen will appear.

- 2 Use the left/right keys to highlight "Yes."
 - "No" will cancel the operation.



- 3 Pressing the controller will execute the command on the confirmation screen.
 - The camera will return to quick view.

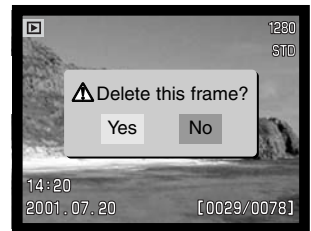

Confirmation screen

RECORDING MODE

ADVANCED OPERATION

This section contains detailed information on the camera's recording functions and operation. Read the sections pertaining to your interest and need. The 'setting the function dial' (p.40), Digital Effects Controller (p. 62), and the 'navigating the recording-mode menu' (p. 80) sections cover setting most of the advanced features in this camera. Each of these sections are followed by detailed descriptions of the settings.

WHAT IS AN EV? WHAT IS A STOP?

Ev stands for exposure value. Stop refers to click stops in mechanical cameras. A change of one Ev or one stop will adjust the exposure calculated by the camera by a factor of two. Adjustments to exposure in the A, S, and M exposure modes are made in 1/2 stop increments or 0.5 Ev.

Change in Ev	Change in stops	Adjustment to exposure
+2.0 Ev	+2 stops	4X as much light
+1.0 Ev	+1 stop	2X as much light
0.0 Ev	Calculated exposure	
-1.0 Ev	-1 stop	1/2 as much light
-2.0 Ev	-2 stops	1/4 as much light

PRO-AUTO BUTTON

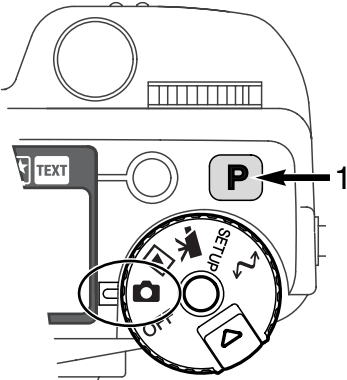

Simply pressing the pro-auto button (1) resets the camera to programmed and automatic functions. The camera's systems work together to bring professional results leaving the operator free to concentrate on aesthetic decisions.

The pro-auto button only affects functions in the recording mode. The button has a limited effect in the movie mode; exposure, contrast, and colour-saturation compensation as well as the focus mode is reset.

Digital subject program (p. 38)	Cancelled
Exposure mode (p. 46)	Program
Drive mode (p. 51)	Single-frame advance
Focus mode (p. 68, 71)	Single AF
Autofocus area (p. 66)	Wide
White balance (p. 58)	Auto white balance
Metering mode (p. 74)	Multi-segment metering
Exposure compensation (p. 63)	0.0
Contrast compensation (p. 64)	0
Colour-saturation compensation (p. 65)	0
Flash metering (p. 75)	ADI metering
Flash compensation (p. 78)	0.0
Flash mode (p. 76)	Fill or red-eye reduction*
Sharpness (p. 86)	Normal

* The flash mode is reset to whichever of the two modes was set last.



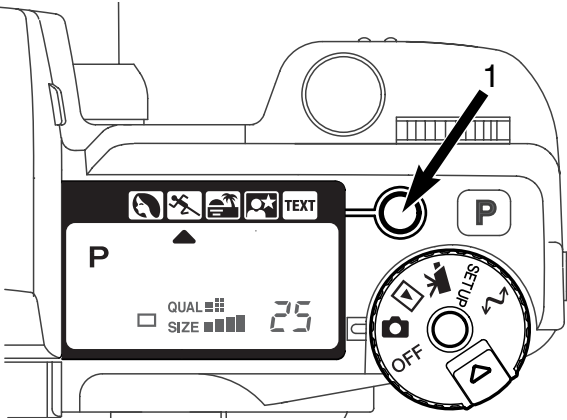

RECORDING MODE

DIGITAL-SUBJECT-PROGRAM BUTTON



The subject-program button (1) optimises the camera's performance for various conditions and subjects. Exposure, white-balance, and image-processing systems work in unison for beautiful results.

Pressing the subject-program button cycles through the modes: portrait, sport action, sunset, night portrait, text, and the original exposure mode. A pointer will indicate the active subject program. The subject program will remain in effect until it is changed.

	Portrait	Optimised to reproduce warm, soft skin tones and a slight defocusing of the background.
	Sport action	Used to capture fast action by maximising shutter speeds and tracking subjects with continuous AF.
	Sunset	Optimised to reproduce rich, warm sunsets.
	Night portrait	For deep, subtle night scenes. When used with flash, the subject and background are balanced.
	Text	For the crisp reproduction of black text on white backgrounds.

While camera performance is optimised for each shooting condition, some changes can be made to camera settings when using subject programs. The autofocus mode can be changed (p. 80). The sport action mode uses continuous AF, the other modes use single AF. The digital effects controller can be used to compensate exposure, contrast, and colour saturation (p. 62). White balance can be changed in all modes except sunset and night portrait (p. 58). Sharpness can be changed in the sport action, sunset, and text modes (p. 80). The metering mode cannot be changed.



Shooting tips

Portrait - Most portraits look best at long focal lengths. Features are not exaggerated and the background is softer because of a shallower depth of field. Use the built-in flash with strong direct sunlight or backlight to reduce harsh shadows.

Sports action - When using a flash, make sure the subject is within the flash range: 0.5 - 3.0m (telephoto). The flash range can be extended by changing the camera sensitivity (p. 79). A monopod is more flexible and compact than a tripod when shooting events.

Sunset - When the sun is above the horizon, do not point the camera toward the sun for prolonged periods of time. The intensity of the sun could damage the CCD. Between exposures, turn off the camera or cover the lens.

Night portrait - When taking pictures of a landscape at night, use a tripod to eliminating blurring from camera shake. The flash can only be used with close subjects such as with a portrait of a person. When using the flash, ask your subjects not to move after the burst; the shutter will still be open for the background exposure.

Text - When taking pictures of small text on a sheet of paper, the macro mode (p. 69) can be used. Use a tripod to eliminate camera shake and ensure the sharpest images.

RECORDING MODE

SETTING THE FUNCTION DIAL

Image size, image quality, exposure modes, drive modes, white balance, and camera sensitivity are controlled by the function dial. Making changes with the function dial is simple. The function dial can only be used for still photography.

Turn the function dial to the mode to be changed (1).

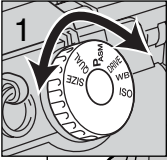

While pressing the button in the centre of the function dial, turn the control dial near the shutter-release button to change the mode (2). Release the function button to set the mode.

- Changes are displayed on the monitors and data panel.

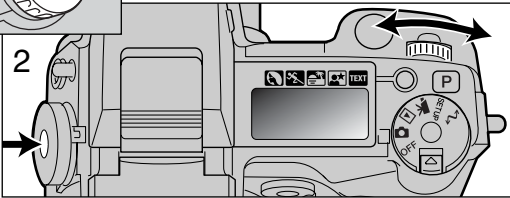

SIZE	Image size	Controls the pixel resolution (p. 42).
QUAL	Image quality	Controls the rate of compression (p. 43).
P.A.S.M.	Exposure modes	Changes exposure mode (p. 46).
DRIVE	Drive modes	Changes drive mode (p. 51).
WB	White balance	Changes between automatic, preset, and Custom white balance (p. 58).
ISO	Camera sensitivity	Changes camera sensitivity (p. 61).

Function Dial	Display	Setting	Page	EVF & Monitor Display
SIZE	SIZE ■■■■	2560 X 1920 (2048 X 1536)	42	2560 (2048)
	SIZE ■■■	1600 X 1200	42	1600
	SIZE ■■	1280 X 960	42	1280
	SIZE ■	640 X 480	42	640
QUAL	RAW QUAL ■■■■	RAW	43	RAW
	QUAL ■■■■	Super fine	43	S. FIN
	QUAL ■■■	Fine	43	FINE
	QUAL ■■	Standard	43	STD
	QUAL ■	Economy	43	ECON
P.A.S.M.	P	Program	47	Numbers in brackets are for the DiIMAGE 5. Display for the data panel, EVF and LCD monitor are the same unless indicated.
	A	Aperture priority	48	
	S	Shutter priority	49	
	M	Manual	50	
DRIVE		Single-frame advance	51	
		Continuous advance	52	
		Self-timer	53	
		Bracketing	54	
	<i>int</i>	Interval	56	
WB	<i>Auto</i>	Automatic white balance	59	
		Daylight	59	
		Tungsten	59	
		Fluorescent	59	
		Cloudy	59	
		Custom setting	60	
	<i>SET</i>	Custom calibration	60	
ISO	<i>Auto</i>	Automatic gain	61	(No display when set)
	100, 200, 400, 800.	Preset camera sensitivity in ISO equivalents.	61	ISO value is displayed

RECORDING MODE

IMAGE SIZE

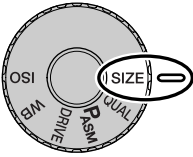

Changing image size affects the number of pixels in each image. The greater the image size, the larger the file size. Choose image size based on the final use of the image - smaller images will be more suitable for web sites whereas larger sizes will produce higher quality prints.

Image size must be set before the picture is taken. Changes made to image size are displayed on the data panel, EVF, and LCD monitor. Image size must be reset manually. See setting the function dial section on page 40.

Data panel	EVF and LCD monitor	Number of pixels (hor. X vert.)	Image size
SIZE ■■■■	2560 (2048)*	2560 X 1920 (2048 X 1536)*	FULL
SIZE ■■■	1600	1600 X 1200	UXGA
SIZE ■■	1280	1280 X 960	SXGA
SIZE ■	640	640 X 480	VGA

* The number in brackets indicates the value for the DiMAGE 5.

ABOUT THE FRAME COUNTER

The frame counter indicates the approximate number of images that can be stored on the CompactFlash card at the camera's image quality and size settings. If the settings are changed, the frame counter adjusts accordingly. Because the calculation is based on average file sizes, the actual image may not change the counter or may decrease it by more than one. The frame counter cannot exceed 999. When the number of recordable images exceeds this, 999 will be displayed. The frame counter will continue to count down when the number of recordable images falls below one thousand.

IMAGE QUALITY

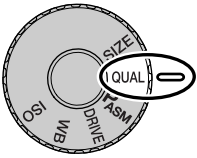

This camera has five image quality settings: raw, super fine, fine, standard, and economy. Always select the desired setting before taking the picture. See 'setting the function dial' section on page 40.

Image quality controls the rate of compression, but has no effect on the number of pixels in the image. The higher the image quality, the lower the rate of compression and the larger the file sizes. The super-fine mode will produce the highest quality image and the largest image files. If the economical use of the CompactFlash card is important, use the economy mode. Standard image quality is sufficient for normal usage.

File formats vary with the image quality setting. Super fine images are saved as a TIFF file. The fine, standard, and economy settings are formatted as a JPEG file. Super fine, fine, standard, and economy files are saved as 24-bit colour or 8-bit monochrome images. RAW creates a file format that can only be read with the DiIMAGE Image Viewer Utility software.

If the image quality is changed, the data panel will display the approximate number of images that can be recorded at that setting on the installed CompactFlash card. One CompactFlash card can contain images with differing qualities.

Data panel	EVF and LCD monitor	
RAW QUAL ■■■■	RAW	RAW - unprocessed image data.
QUAL ■■■■	S. FIN	Super fine - the highest quality image.
QUAL ■■■	FINE	Fine - high quality image.
QUAL ■■■	STD	Standard - the default setting.
QUAL ■■	ECON	Economy - the smallest file sizes.

RECORDING MODE

ABOUT SUPER-FINE AND RAW IMAGE QUALITY

Because super-fine and RAW data files are so large, the continuous-advance mode (p.52) cannot be used with these image-quality settings. If the continuous advance is used with either of these settings, only one image will be captured when the shutter-release button is pressed and held. With the bracketing drive mode, the continuous advance is cancelled and the shutter must be released manually for each frame of the bracket. When capturing super fine and RAW images, a delay of between thirty to forty seconds can occur as the image is saved to the CompactFlash card; the monitors will be blank and the access lamp will glow during that period.

In the RAW image-quality mode, the image size is set at full and cannot be changed. The image size will not be displayed in the monitor. The digital zoom, enlarged playback, and data imprinting cannot be used.

Unlike the other image-quality modes, RAW image data is unprocessed and requires image processing before it can be used. To view the RAW data, the DiMAGE Image Viewer Utility software is required. The utility software can reconstruct the image and apply the same image processing controls as the camera. RAW data is saved as a 12-bit file; the DiMAGE Viewer Utility software can convert this data into 48-bit TIFF files.

When the camera is set to RAW image quality, the camera's image processing controls alter the live image displayed in the EVF and on the LCD monitor in recording mode, but have no effect on the stored image. When the image is played back on the camera, image processing is not applied and the colours of the image can look unnatural. When viewed on a computer using the DiMAGE Image Viewer software, the natural colours will be restored.

A RAW image is stored with a file header that contains white-balance information, changes made to contrast and saturation with the digital effects controller, any image processing applied in a subject-program setting, and changes to sharpness. The colour mode has no effect on the final image; a raw image taken in the black and white mode can be restored to a colour picture. The changes in camera sensitivity are applied to the RAW data; ISO values can be manually set to control noise (p. 62).

Note

If JPEG or TIFF files are retouched and overwritten with image processing applications that do not support Exif files such as Adobe Photoshop, they can not be read or displayed in the DiMAGE Image Viewer Utility (an error message "File not supported" appears).

IMAGE-FILE SIZE AND COMPACTFLASH CARD CAPACITY

The number of images that can be stored on a CompactFlash card is determined by the size of the card and the file size of the images. The actual file size is determined by the scene; some subjects can be compressed further than others. The tables below list approximate file sizes based on average file sizes.

Approximate file sizes.					
Image quality	Image size	2560 X 1920 (2048 X 1536)*	1600 X 1200	1280 X 960	640 X 480
		RAW	9.5MB (6.1MB)	–	–
Super fine	14.1MB (9.1MB)	5.6MB	3.6MB	0.96MB	
Fine	2.1MB (1.6MB)	1.0MB	0.66MB	0.27MB	
Standard	1.1MB (0.9MB)	0.6MB	0.41MB	0.2MB	
Economy	0.65MB (0.59MB)	0.38MB	0.29MB	0.15MB	
Approximate number of images that can be stored on a 16MB CompactFlash card.					
Image quality	Image size	2560 X 1920 (2048 X 1536)*	1600 X 1200	1280 X 960	640 X 480
		RAW	1 (2)	–	–
Super fine	1 (1)	2 (2)	4 (4)	16 (16)	
Fine	7 (9)	17 (15)	28 (23)	80 (57)	
Standard	15 (16)	33 (26)	50 (38)	115 (81)	
Economy	22 (27)	46 (41)	67 (54)	135 (104)	

* The figures in parentheses apply to the DiIMAGE 5 only.

RECORDING MODE

EXPOSURE MODES

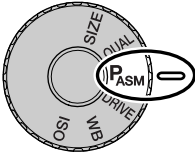

The four exposure modes allow extensive control over image making. Programmed AE gives carefree operation, aperture and shutter priority allow photographers to maximise exposures in different situations, and manual exposure provides complete freedom in controlling the final image. See setting the function dial section on page 40.

P	Program	The camera controls both the shutter speed and aperture.
A	Aperture priority	The photographer selects the aperture and the camera sets the appropriate shutter speed.
S	Shutter priority	The photographer selects the shutter speed and the camera sets the appropriate aperture.
M	Manual exposure	The photographer selects both the shutter speed and aperture.

Data panel

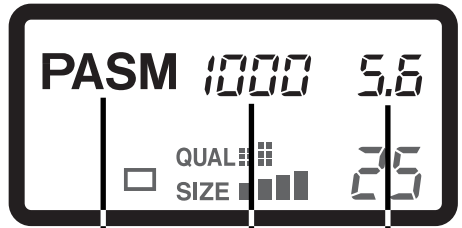

LCD monitor

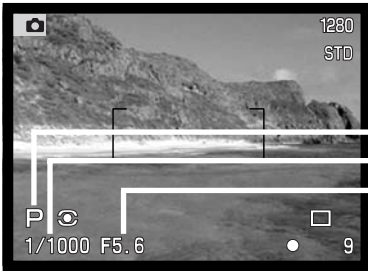

Exposure modes
Shutter speed
Aperture

All exposure mode icons on the data panel have been shown for clarity.

PROGRAM - P

The programmed AE exposure control uses luminance and focal-length information to ensure perfect exposures. The sophisticated exposure system allows the photographer the freedom to shoot without having to worry about the technical details of exposure settings. The shutter speed and aperture value of the exposure are displayed on the monitors and data panel.

The program line adjusts with the changes in focal length of the zoom lens. The camera is programmed to maximise depth of field in the wide-angle range to provide sharp landscape pictures, and to maximise shutter speed in the telephoto range to minimise camera shake and blurred images. When the shutter speed falls below an acceptable limit for the camera to be hand held, the camera-shake warning appears in the lower left corner of the monitors (p. 15).

PROGRAM SHIFT

Although exposure calculations can be left to the camera, photographers can still have control over the final exposure with the program-shift function. As described in the basic recording operation (p. 29), press the shutter-release button partway down (1) until the shutter speed and aperture value is displayed. The control dial (2) can then be used to shift the shutter speed and aperture combination; each combination will give the optimum exposure.

The built-in flash cannot be used with program shift. The camera gives priority to the flash exposure; once the flash is raised, any changes made will the program shift will be cancelled. Pressing the function button will also reset the program shift.

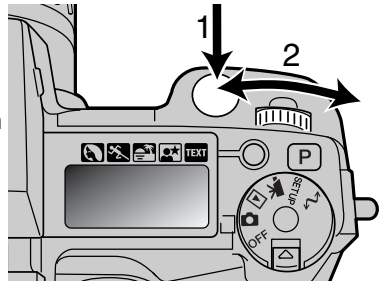

RECORDING MODE

APERTURE PRIORITY - A

The photographer selects the aperture and the camera sets the appropriate shutter speed to ensure correct exposure. When A mode is selected, the aperture value on the monitor and EVF will turn blue.

Turn the control dial (1) to set the desired aperture value. Press the shutter-release button (2); the corresponding shutter speed will be displayed.

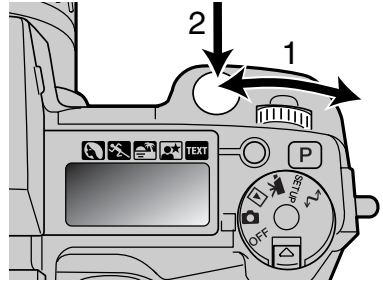

The aperture values can be changed by half stop increments between $f/2.8$ and $f/8$ at the lens' wide-angle position and $f/3.5$ to $f/9.5$ at the lens' telephoto position. If the aperture value is beyond the shutter-speed range, the shutter-speed display will blink on the data panel and turn red on the monitors.

When the shutter speed falls below an acceptable limit for the camera to be hand held, a warning appears in the lower left corner of the EVF and LCD monitor. When the warning appears, decrease the aperture value until the warning disappears or place the camera on a tripod.

Because the shutter speeds can be adjusted in fine steps, the same shutter speed maybe displayed when the aperture is changed. With the camera sensitivity (ISO) set to auto, the shutter speed may not change when the aperture is adjusted.

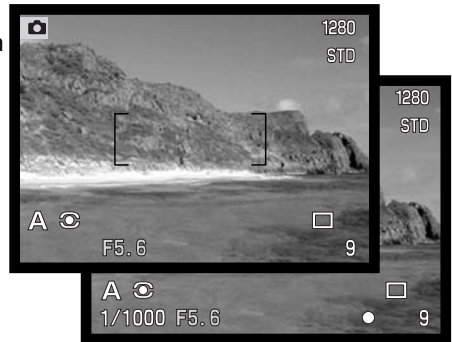

SHUTTER PRIORITY - S

The photographer selects the shutter speed and the camera sets the appropriate aperture to ensure correct exposure. When S mode is selected, the shutter speed on the monitor and EVF will turn blue.

Turn the control dial (1) to set the desired shutter speed. Press the shutter-release button (2); the corresponding aperture will be displayed.

The shutter speeds can be changed by half stop increments from 4 seconds to 1/2000. If the shutter speed is beyond the aperture range, the aperture display will blink on the data panel and turn red on the monitors.

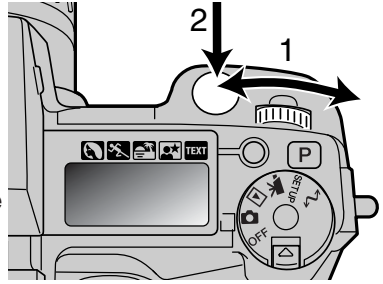

Camera Notes

For 35mm photographers, an aperture range of $f/2.8$ to $f/8$ does not seem impressive. However, because of the CCD size and the actual focal length of the lens, the apertures on this digital camera give significantly more depth of field at any given angle of view with any given aperture than a 35mm camera. So even with the minimum aperture of $f/8$, the depth of field will give the coverage needed to create beautiful, sharp images.

RECORDING MODE

MANUAL EXPOSURE - M

Manual exposure mode allows individual selection of shutter speeds and apertures. This mode overrides the exposure system giving the photographer total control over the final exposure. The shutter speeds and aperture values can be changed in half stop increments. The value that is being set will turn blue on the monitors.

As changes are made to the exposure, the effect will be visible on the monitors. The shutter-speed and aperture display will blink on the data panel and turn red on the monitors, if the image extremely under or overexposed. If the monitors are black, increase the exposure until the image is visible; decrease the exposure if the monitors are white.

In manual mode, the auto camera sensitivity setting will be set to ISO 100. The camera sensitivity can be changed with the function dial (p. 40). Bulb exposures can made in M mode, see page 92 for more information.

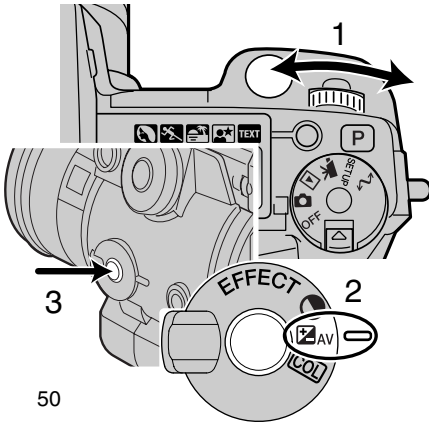
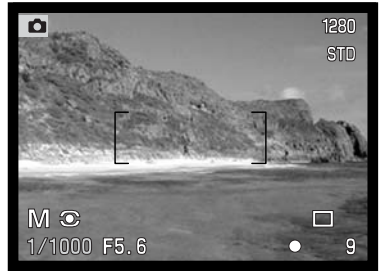

To set the shutter speed:

- Turn the control dial (1) to set the desired shutter speed.

To set the aperture:

- Set the digital effects switch (2) to the exposure-compensation position.
- While pressing the digital effects button (3), turn the the control dial (1) to set the desired aperture value.

DRIVE MODES

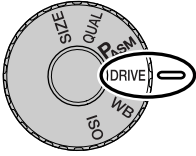

The drive modes control the rate and method images are captured. Icons indicating the selected drive mode appear on the data panel and LCD monitor and in the EVF. See 'setting the function dial' section on page 40.

	Single-frame advance	To take a single image each time the shutter-release button is pressed.
	Continuous drive	To take multiple images when the shutter-release button is pressed and held.
	Self-timer	To delay the release of the shutter. Used for self-portraits.
	Bracketing	To take a series of images with differing exposure, contrast, and saturation.
	Interval shooting	To take a series of images over a period of time.

All icons have been shown for clarity. The single-frame advance and continuous drive indicators occupy the same area of the data panel. All the drive-mode icons appear in the lower right corner of the monitors.

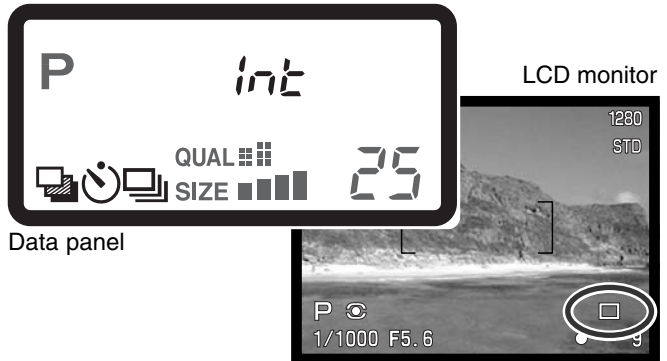

RECORDING MODE

CONTINUOUS ADVANCE

Continuous-advance mode allows a series of images to be captured while holding down the shutter-release button. Continuous-advance acts as a motor drive on a film camera. The number of images that can be captured at one time and the rate of capture depends on the image-quality and image-size setting. The maximum rate of capture is 1.1 fps (1.3 fps for DiMAGE 5) with full-size images with manual focus in manual-exposure mode. The continuous-advance mode is set with the function dial (p. 40).

When the shutter-release button is pressed and held, the camera will begin recording images until the maximum number has been taken or the shutter button is released. This mode cannot be used with super-fine or RAW image (p. 44). The built-in flash can be used, but the rate of capture is reduced because the flash must recharge between frames.

Compose the picture as described in the basic operation section (p. 29). Press the shutter-release button partway down to lock the exposure and focus for the series; if the autofocus mode is set to continuous AF, the lens will continually focus during the series (p. 68). Press and hold the shutter-release button all the way down to begin taking pictures.

The following chart lists the maximum number of images that can be captured with different image-quality and image-size combinations. The numbers in brackets refer to the DiMAGE 5.

Image Quality \ Image Size	2560 X 1920 (2048 X 1536)	1600 X 1200	1280 X 960	640 X 480
Fine	5 (8)	8 (12)	11 (17)	25 (38)
Standard	7 (12)	12 (18)	17 (26)	35 (53)
Economy	12 (19)	18 (28)	24 (36)	44 (68)

SELF-TIMER

Used for self-portraits, the self-timer will delay the release of the shutter for approximately ten seconds after the shutter is released. The self-timer is set with the function dial (p. 40).

With the camera on a tripod, compose the picture as described in the basic operation section (p. 29). Focus lock (p.30) or the Flex Focus Point (p. 67) can be used with off-centre subjects . Press the shutter-release button partway down or press the AF/AEL button to lock the exposure and focus. Press the shutter-release button all the way down to begin the countdown. Because focus and exposure is determined when the shutter-release button is pressed, do not stand in front of the camera when taking a self-timer image. Always confirm the focus with the focus signals before beginning the countdown (p. 68).

During the countdown, the self-timer lamp on the front of the camera will start to blink and is accompanied by an audio signal. A few seconds before the exposure, the self-timer lamp will blink rapidly. The lamp will glow steadily just before the shutter fires. To stop the countdown, press the pro-auto button or change the position of the flash (lift it or push it down). The audio signal can be turned off in the basic section of the setup menu (p. 114).

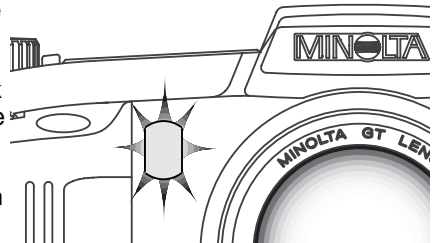

Shooting tips

The self-timer can be used to minimise camera shake with long exposures. When using the camera on a tripod, photographs of static subjects (landscapes, still-life, or close-up photographs) can be made with the self-timer. Because no contact is made with the camera during exposure, there is no risk of camera shake caused by the operator.

RECORDING MODE

BRACKETING

This mode makes a three image bracket of a scene. Bracketing is a method of taking a series of images of a static subject in which each image has a slight variation in exposure. The camera is not limited to exposure brackets, but can also make contrast and colour saturation brackets. Only one image characteristic can be bracketed at a time. The bracketing mode is set with the function dial (p. 40).

EXPOSURE BRACKETING

Exposure bracket



After setting the drive mode to bracketing, turn the digital effects switch to the exposure-compensation setting. The order of the bracket series is normal exposure (as indicated by the shutter speed and aperture displays), underexposure, overexposure. The exposure bracket is set to 1/3 stop increments, but can be adjusted to 1/2 or 1 stop increments in the Custom 1 section of the recording-mode menu (p. 80).

Compose the picture as described in the basic-operation section (p. 29). Press the shutter-release button partway down (1) or press the AF/AEL button (2) to lock the exposure and focus for the series; the camera will continue to focus during the series if set to continuous AF (p. 68). Press and hold the shutter-release button all the way down (3) to make the bracket series; three consecutive images will be captured.

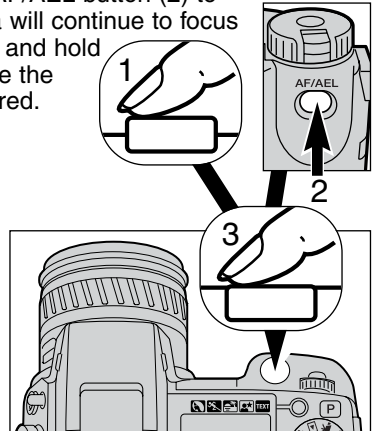
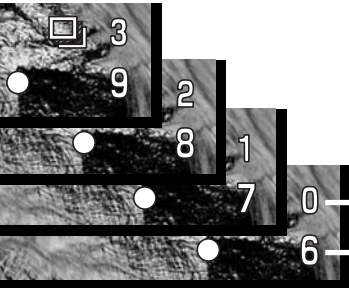

DIGITAL ENHANCED BRACKETING

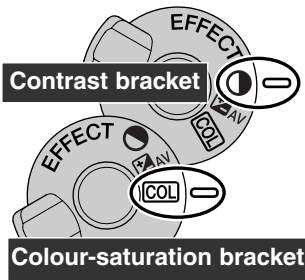

After setting the drive mode to bracketing, turn the digital effects switch to the contrast or colour-saturation setting. Set the contrast or colour saturation to the desired level; the bracket series is from one unit under to one unit over the set level. Except for a RAW image, if the contrast or colour saturation is set to the maximum or minimum level (± 3), one bracket will be made at ± 4 : +3, +2, +4. A RAW image cannot exceed the the maximum and minimum levels and will contain two identical brackets: +3, +2, +3. See the digital-effects-controller section on page 62 to set contrast and colour saturation.

Compose the picture as described in the basic-operation section (p. 29). Press the shutter-release button partway down (1) or press the AF/AEL button (2) to lock the exposure and focus for the series; the camera will continue to focus during the series if set to continuous AF (p. 68). Press and hold the shutter-release button all the way down (3) to make the bracket series; three consecutive images will be captured. The frames in the bracket series is countdown on the monitors next to the bracketing icon.

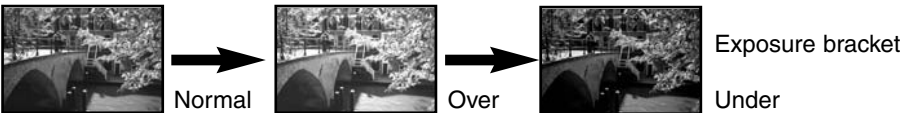

NOTES ON BRACKETING

If the CompactFlash card is full or the shutter button is released before the series has completed, the camera will reset and the entire bracket must be made again.

With super fine and RAW image qualities or when using flash, the bracket will not advance automatically; the shutter-release button must be pressed for each frame of the series. Once the series begins, the focus and exposure values are set and do not have to be made again. The remaining number of frames in the bracket series is displayed on the monitors next to the bracketing icon.

RECORDING MODE

INTERVAL

The interval mode makes a series of still images over a period of time. Similar to time-lapse photography, a series of images of a slow moving event can be taken: the blossoming of a flower, the construction of a building. The built-in flash can be used. Instant playback (p. 89) is disabled.

Use the function dial to set the drive mode to interval (p. 40). The number of frames in the series will be displayed on the monitors next to the interval icon. The number of frames can be set between two and ninety nine on the Custom 1 section of the recording-mode menu (p. 80). The interval period is also set on the recording-mode menu; 1 - 10, 15, 20, 30, 45, and 60 minutes.

After mounting the camera on a tripod, compose the image so that the subject area falls within the focus frames; the camera sets the focus, exposure, and white balance, and charges the flash just before each exposure. Continuous AF can be used. Settings locked with the AF/AEL button are canceled after the first frame (p. 73). To override the automatic systems, use manual focus (p. 71), manual exposure (p. 50), and manual white balance (p. 58).

Confirm the CompactFlash card has enough storage capacity for the series by comparing the number of frames in the interval series with the number of recordable images displayed on the frame counter. Image size and quality settings can be changed to increase the number of pictures that can be saved on the CompactFlash card (p. 40).

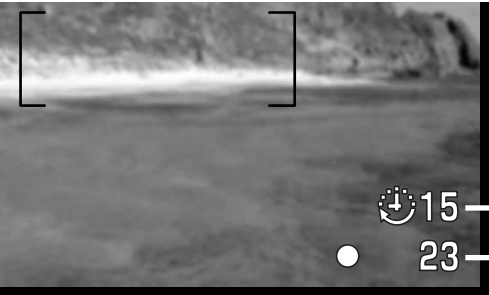

Number of frames in the interval series.

Frame counter.

Press the shutter-release button to begin the series. During the interval series, the monitors will be turned off to conserve power. “Int” will be displayed on the data panel and the data-panel frame counter will countdown the remaining frames in the interval series. The access lamp will glow when an image is being recorded.

To force the shutter to fire before the end of an interval, press the shutter-release button. The next interval will be timed from the new exposure. When the shutter is forced to fire, the EVF will activate for the duration of the auto-power-save period (p. 117) and the LCD monitor will activate for thirty seconds.

The camera will stop recording images and reset to the first frame when the number of frames set has been taken, or when the CompactFlash card is full. To cancel the interval series, turn off the camera.



The setting sun: 10 minute intervals

Shooting tips

When creating a large series of images, the text and a serial number can be imprinted on the images. This aids editing the images and time calculations for specific images. For information on data imprinting, see page 87.

RECORDING MODE



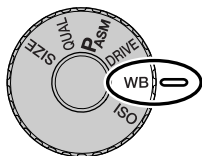



WHITE BALANCE



White Balance is the camera's ability to make different types of lighting appear neutral. The effect is similar to selecting daylight or tungsten film, or using colour compensating filters in conventional photography.

When setting the white balance, "Auto" (data panel) and "AWB" (monitors) will be displayed to indicate the auto white-balance setting. An icon will be displayed on the data panel and monitors if a setting other than auto white-balance was chosen. See setting the function dial section on page 40.



No display	AUTO	The AUTO setting will detect the type of light and adjust the white balance accordingly.
	Daylight	For outdoor and sunlit subjects.
	Tungsten	For incandescent lighting: household filament light bulbs.
	Fluorescent	For fluorescent lighting: office ceiling lights.
	Cloudy	For overcast outdoor scenes.
	Custom setting	For using the Custom white-balance setting.
	Custom calibration	For manual white-balance calibration.

AUTOMATIC WHITE BALANCE

The automatic white balance compensates for the colour temperature of a scene. In most cases, the AUTO setting will balance the ambient light and create beautiful images, even under mixed-lighting conditions. When the built-in flash is used, the white balance is set for the colour temperature of the flash.

PRESET WHITE BALANCE

Preset white-balance settings must be set before the image is taken. Once set, the effect is immediately visible in the EVF and LCD monitor.

The built-in flash can be used with preset white-balance settings, but will create a pinkish or blueish cast with the fluorescent and tungsten settings. The flash is daylight balanced and will produce excellent results with the daylight and cloudy settings.

Shooting tips

The daylight and cloudy settings are primarily for outdoor shooting conditions. Daylight is used for sunny weather when the light is relatively warm. The light during overcast conditions is much cooler and requires a different white balance: cloudy. Office lighting will produce a strong green cast in photographs; the fluorescent setting restores the natural colour under these conditions. Traditional household light bulbs emit very yellow light, which can be corrected with the tungsten setting.

Auto and manual white balance will not change the colour of neon signs. White balance cannot correct high-energy vapour lighting: sodium-vapour (yellow highway lights), or mercury vapour. For portraits under these lighting conditions, the flash can be used to overpower the ambient light. With landscapes containing these types of lights, set the white balance to the preset daylight setting.

RECORDING MODE

CUSTOM WHITE BALANCE

Custom-white-balance function allows a photographer to calibrate the camera to a specific lighting condition. The setting can be used repeatedly until reset. Custom white balance is especially useful with mixed-lighting conditions or when critical control over colour is needed.

To calibrate the camera, press the function button and turn the control dial until the Custom white-balance icon and “SET” appear on the data panel and red on the monitors. Select a white object and fill the image area with it; the object does not need to be in focus. Press the shutter-release button to calibrate the camera. If an error occurs during calibration, an error message will appear on the monitors. Press the controller to cancel the message, then recalibrate using a suitable reference target and the shutter-release button. This sequence can be repeated as many times as necessary.



Calibration display

The setting will remain until another calibration is made. If the Custom white-balance setting needs to be used again, while pressing the function button, turn the control dial until the Custom white-balance icon is displayed *without* the “SET” on the data panel and white on the monitors. The camera will use the last Custom setting.

The built-in flash can be used with the Custom setting. However, since the flash is daylight balanced, it will give an unusual colour cast to an image if the camera is calibrated to any other light source.

Shooting tips

When making the calibration, the colour of the object used is critical. The object should be white. A coloured object will cause the calibration to compensate for the object colour rather than the colour temperature of the ambient light. A blank piece of white paper is an ideal surface and can easily be carried in a camera bag.

CAMERA SENSITIVITY - ISO

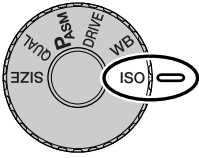

Five settings can be selected for camera sensitivity: Auto, 100, 200, 400, and 800; the numerical values are based on an ISO equivalent. ISO is the standard used to indicate film sensitivity: the higher the number, the more sensitive the film. See 'setting the function dial' section on page 40 to change the ISO setting.

The auto setting automatically adjusts the camera sensitivity to the light conditions between ISO 100 and 400. When the flash is activated and camera sensitivity is set to auto, the ISO value is set to ISO 200. When any other setting than auto is used, "ISO" will appear on the data panel and "ISO" and the set value will be displayed on the monitors.

Photographers can select a specific sensitivity setting. Like grain in silver-halide film that increases with speed, noise increases with sensitivity in digital imaging; an ISO setting of 100 will have the least noise and 800 will have the most noise. A change in ISO also effects the flash range (p. 79); the higher the ISO, the greater the range.

As the ISO value doubles, the camera sensitivity doubles; changing the ISO between 100 and 200, 200 and 400, or 400 and 800 changes the camera sensitivity by one stop or 1 Ev (p. 36). A change between 100 and 800 changes the camera sensitivity by a factor of 8 or three stops. High ISO settings (400, 800) will allow the photographer to hand hold the camera in low-light conditions without the need of a flash.

Camera Notes

When making bulb exposures (p. 92), noise can be more pronounced because of the unusually long exposure times, especially at 400 and 800 ISO. When making long bulb exposures of 20 to 30 seconds, a camera sensitivity setting of 100 or 200 will produce excellent results. At higher ISO settings, using shorter exposure times (8 - 16 seconds) will reduce the effect of noise. With long exposures at high ISO settings, noise from interference may be noticeable.

RECORDING MODE

DIGITAL EFFECTS CONTROL

The Digital Effects Controller is a powerful tool. As well as being able to make adjustments to exposure, the controller can also change image contrast and colour saturation. The effect of any change is instantly visible in the EVF or on the LCD monitor before the image is captured. Since compensation is applied to the image before it is compressed and saved, image information can be maximised before leaving the scene. The digital effects controller can be used with movie recording.

Operating the controller is very simple:

- 1 Turn the digital effects switch to the image characteristic to be changed.
- 2 Press and hold the digital-effects button in the centre of the switch and adjust the setting by turning the control dial next to the shutter-release button. Release the digital-effects button to set the adjustment.

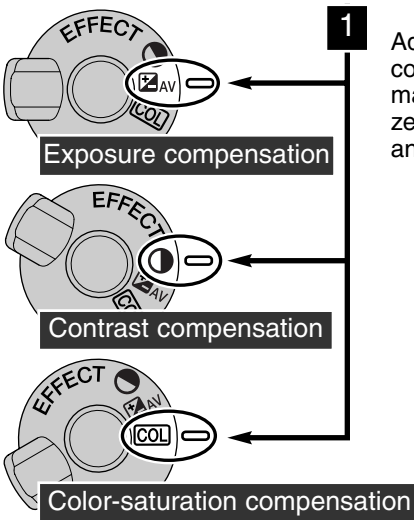

Adjustments can be made repeatedly and in combination. Adjustments remain in effect until manually reset. When set to any value other than zero, an icon will be displayed on the data panel and monitors as a warning.

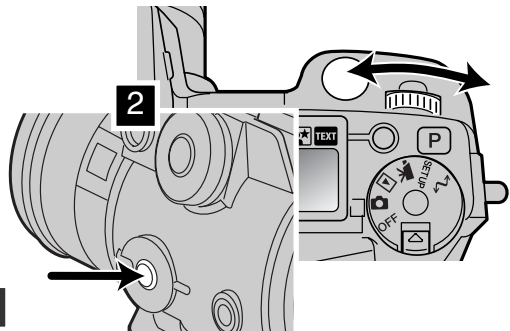

EXPOSURE COMPENSATION

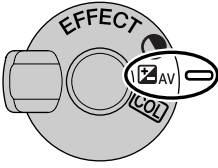

The exposure can be adjusted before the image is captured to make the final picture lighter or darker. Exposure can be adjusted by as much as $\pm 2\text{EV}$ in $1/3$ increments (p. 36). The exposure compensation value will remain in effect until it has been reset.

The exposure compensation must be set before the image is captured. When setting the exposure compensation, the change is shown on the data panel aperture display and next to the exposure-compensation icon on the monitors. After the setting is made, the shutter-speed and aperture displays will indicate the actual exposure. Because the shutter speeds can be adjusted in fine steps, the same shutter speed or aperture value maybe displayed after exposure compensation.

Data panel	EVF & LCD monitor	
1.3	-1.3	Display when adjusting exposure.
5.6*	-1.3	Exposure compensation warning after adjustment

* The aperture value for the exposure.

Shooting tips

Sometimes the camera's exposure meter is deceived by certain conditions. Changing the exposure value can compensate for these situations. For example, a very bright scene, such as a snowy landscape or a white sandy beach, can appear too dark in the captured image. Before taking the picture, adjusting the exposure by +1 or +2 EV will result in an image with normal tonal values.

In this example, the dark scene appears bright and washed-out on the LCD monitor. By decreasing the exposure by -1.5EV , the richness of the sunset is preserved.

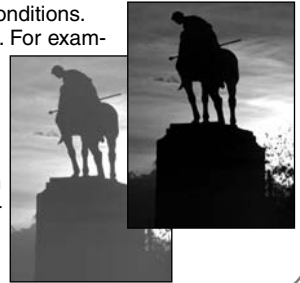

RECORDING MODE

CONTRAST COMPENSATION

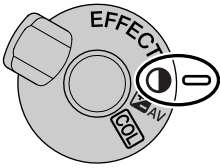

The contrast of a scene can be adjusted within seven levels (± 3) with the Digital Effects Controller. If a scene is too contrasty, information will be lost; if a scene is flat, the image information is not optimised for the recording ability of the camera. Control over the contrast gives photographers the ability to optimise the image information at the scene.

The contrast must be set before the image is captured. When changing the contrast setting, an icon will appear on the data panel and in the live image. The data panel and monitors will indicate if an increase (+) or decrease (-) in contrast has been made. If contrast is set to any other value than zero, the icon will remain on the displays as a warning.

Data panel	EVF & LCD monitor	
		Display when adjusting contrast.
		Contrast compensation warning after adjustment.

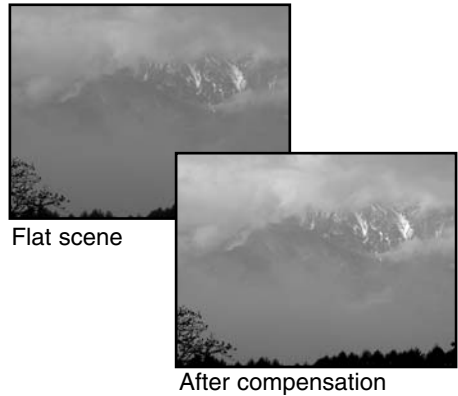
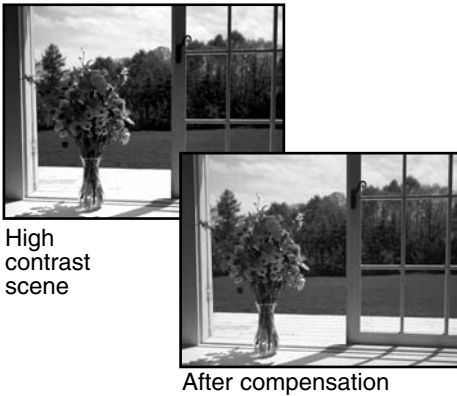

COLOUR-SATURATION COMPENSATION

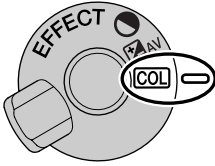

The colour saturation of a scene can be adjusted within seven levels (± 3) with the Digital Effects Controller. Colours can be accented or subdued.

The colour saturation must be set before the image is captured. When changing the colour-saturation setting, an icon will appear on the data panel and in the live image. The data panel and monitors will indicate if an increase (+) or decrease (–) in saturation has been made. If colour saturation is set to any other value than zero, the icon will remain on the displays as a warning.

Data panel	EVF & LCD monitor	
COL + ;	COL+1	Display when adjusting colour saturation.
COL	COL+1	Color-saturation compensation warning

Shooting tips

Unlike the display on a computer monitor, changes to contrast and colour saturation can be difficult to see in the EVF and LCD monitor. To ensure the optimum level of contrast or colour saturation, make an automatic bracket (p. 55) or manual bracket of the scene.

RECORDING MODE

AUTOFOCUS AREAS AND CONTROL

In still-image recording mode, the controller selects the focus area used and moves the spot-focus area within the image. The two focus areas, wide focus area and spot focus point, allow flexibility over a variety of situations.

The wide focus area is an array of local focus areas that work together to control focus. This system is especially effective with moving subjects or quick shooting in fast-moving events. When the focus is locked in single AF mode, one of the AF sensors within the wide focus area will briefly indicate the point of focus. The spot focus point gives critical control over focus. It can be used to single out an individual subject from a group.

Switching between the wide focus area to the spot focus point is simple. Press and hold the controller (1) until the wide-focus-area frame lines change to the spot-focus-point cross. Press and hold the controller again to return to the wide-focus-area frame lines.

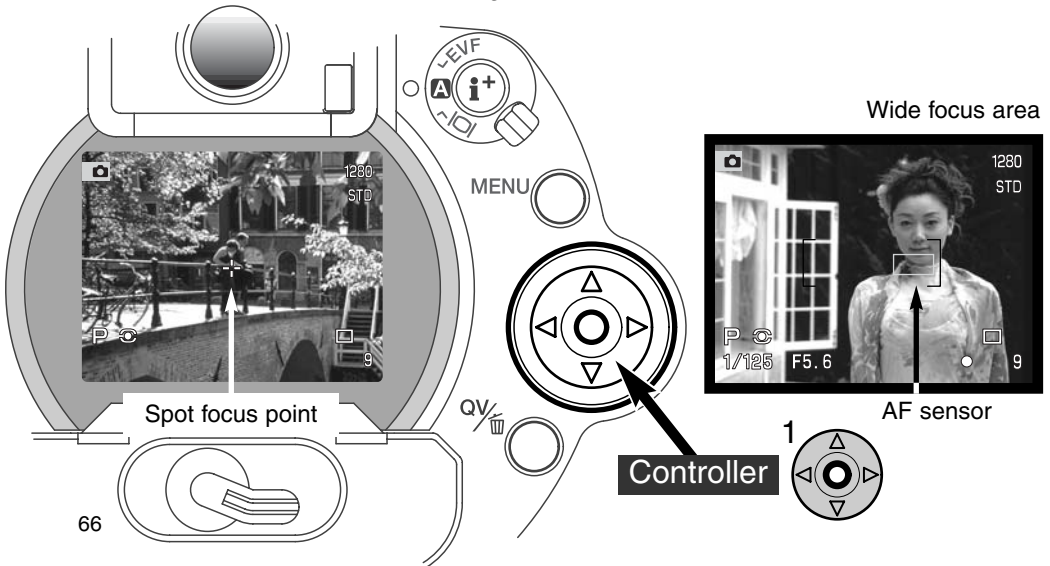

FLEX FOCUS POINT - CONTROLLING THE SPOT FOCUS POINT

Once displayed, the spot focus area can be moved to any point in the image area. This Flex Focus Point is a powerful tool for off-centre subjects. The Flex Focus Point cannot be used with continuous AF (p. 68) or the digital zoom (p. 70).

With the spot-focus-area cross displayed, use the controller's four-way keys (1) to move the focus point anywhere within the live image. Press the shutter-release button partway down or press the AF/AEL button to focus; the cross will turn red to confirm focus.

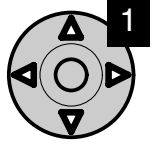

Pressing the centre of the controller (2) returns the focus point to the centre of the image area. To return to the wide-focus-area mode press and hold the controller until the frame lines appear.

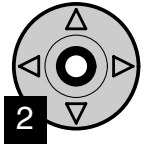

RECORDING MODE



AUTOFOCUS MODES

This digital camera has two autofocusing modes. The single and continuous autofocus modes are selected in the basic section of the recording-mode menu (p. 80).

Single AF - for general purpose photography and static subjects. When the shutter-release button is pressed partway down the autofocus system locks onto the subject in the focus area and will remain in effect until the shutter button is released.

Continuous AF - for moving subjects. When the shutter-release button is pressed partway down, the autofocus system will activate and continue to focus until the exposure is made.

- When the AF system is unable to focus because of a special focusing situation (p. 31), the focus is set to infinity. When using flash, the focus is set between 3 and 3.8m. In this case, focus lock (p. 30) can be used with an object at the same distance as the main subject or the camera can be focused manually (p. 71).
- When using continuous AF with the wide focus area (p. 66), the AF sensors will not appear to indicate the point of focus.
- The continuous AF mode may have difficulty focusing on extremely fast subjects. In this situation, use manual focus to focus on a point in the subject's path and release the shutter just before the subject reaches that point; there is a slight delay between the time the shutter-release button is pressed and the shutter opens.

	Single AF icon	Focus confirmed.
	Continuous AF icon	Focus confirmed.
	Focus icon: red	Cannot focus. The subject is too close or a special situation is preventing the AF system from focusing.

- Do not confuse these icons with the metering-mode icons (p. 74).
- The shutter can be released even if the camera cannot focus on the subject.

MACRO MODE

The macro mode is used for close-up photographs of small objects. The minimum focusing distance is 25cm from the CCD or about 13cm from the front of the lens. The macro mode can be used with the digital zoom to increase the close-up effect. Subject programs and movie recording can be used with the macro setting. The built-in flash cannot be used with macro mode.

Turn the zoom ring to the telephoto setting.

- Align the arrow on the zooming ring with the arrow near the macro switch.

Slide the macro switch on the lens barrel forward.

- The camera is now in macro mode.
- Make sure the subject is within the macro focusing range: 0.25 - 0.6m from the CCD.
- To return to normal recording mode, slide the macro switch towards the rear of the lens.
- The macro icon is displayed in the lower right corner of the monitors.

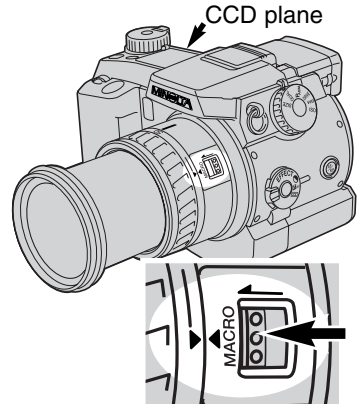

Shooting tips

Because of the high image magnification, hand holding cameras during close-up photography is very difficult. When possible, use a tripod.

Use the Flex Focus Point (p. 67) to specify the area to be within focus. Because depth of field (the area in focus) is narrow in close-up photography, using focus lock with off-centre subjects can cause minor errors which are exaggerated at high magnifications.

The variable position EVF makes working in tight spaces and at low levels easy. The EVF can be tilted between 0° and 90°.



RECORDING MODE

DIGITAL ZOOM

The digital zoom doubles the lens magnification. The digital zoom cannot be used with RAW image quality or in movie recording.

Press the magnification button on the back of the camera. The effect is immediately displayed.

- The live image is enlarged on the LCD monitor and is cropped with a shaded border in the EVF.
- X2.0 is displayed in the monitors when the digital zoom is in effect.
- Pressing the magnification button a second time cancels the digital zoom.
- When using the wide focus area (p. 66), the AF sensor will not appear to indicate the point of focus.



EVF



LCD monitor

When an image is taken with the digital zoom, the final image size depends on the image-size setting on the camera. The image is trimmed and then the total number of pixels are interpolated to produce an image with a pixel resolution shown in the chart.

	Image size setting			
	Full	1600 X 1200	1280 X 960	640 X 480
DiIMAGE 7	1280 X 960	1280 X 960	1280 X 960	640 X 480
DiIMAGE 5	1024 X 768	1024 X 768	1024 X 768	640 X 480

MANUAL FOCUS MF

Manual control over focus is simple. The focus mode button (AF/MF) (1) toggles between automatic and manual focus. The MF icon is displayed on the data panel and monitors when the camera is in the manual-focus mode.

Use the focus ring (2) at the rear of the lens barrel to make a sharp image in the EVF or on the LCD monitor. The approximate distance from the CCD to the subject is displayed on the monitors. Manual focus can be used with movie recording and in macro mode.

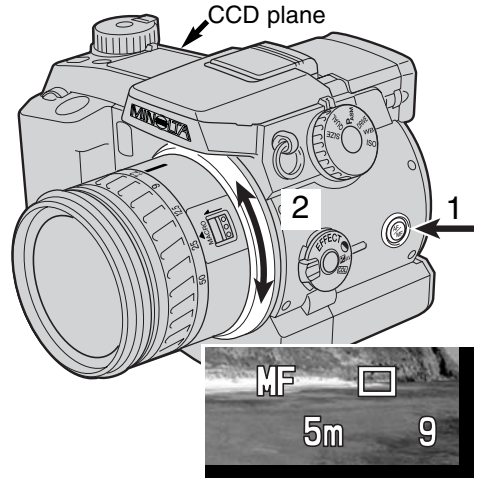

ELECTRONIC MAGNIFICATION (DIMAGE 7 ONLY)

The magnification button can be used to enlarge the centre of the image by X4 to aid manual focusing. This function has no effect on the final image size. This function is activated using the Custom 1 section of the recording-mode menu (p. 80); activating this function disables the digital zoom. Electronic magnification can only be used to check manual focus. The magnified display cannot be used to set the exposure.

Press the magnification button on the back of the camera.

- The magnifier icon is displayed on the monitors when electronic magnification is in effect.
- Pressing the magnification button a second time cancels the function.
- When the shutter-release button is pressed partway down, the magnified display is cancelled showing the entire image area.



RECORDING MODE

ELECTRONIC VIEWFINDER

The EVF displays 100% field of view. When using the camera outdoors or under bright lighting conditions, the viewfinder image is not affected by the ambient light and is bright and clear.

The electronic viewfinder can be tilted between 0° to 90°. Simply grip the finder between your fingers and move it to the position desired. Always store the camera with finder down against the body.

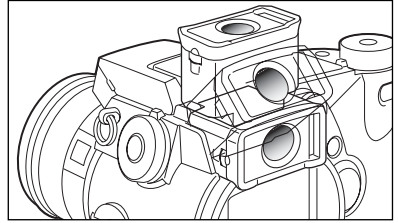

DIOPTER ADJUSTMENT

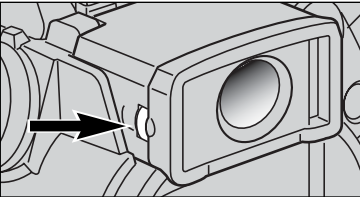

The EVF has a built-in dioptre that can be adjusted between -5.0 to $+0.5$. While looking through the EVF, turn the dioptre-adjustment dial until the viewfinder image is sharp.

AUTOMATIC MONITOR AMPLIFICATION (DiIMAGE 7 only)

In extremely low-light conditions when the camera-sensitivity gain has reached its limit, the automatic monitor amplification function will intensify the EVF and LCD monitor image. The live image will be brighter, however the display will be black and white. This will have no effect on the final colour image.

When the automatic monitor amplification is in use, the electronic-magnification function cannot be used.

AF/AE LOCK BUTTON

When the shutter-release button is pressed partway down, the focus and exposure is locked. The AF/AEL button performs the same operation when pressed and held; the focus signals and exposure displays will confirm if the settings are locked. The operation of this button can be changed in the Custom-1 section of the recording-mode menu (p. 80). Changing these settings has no effect on the operation of the shutter-release button. Focus lock is disabled when the camera is set to continuous AF.

Recording-mode menu setting	
AF/AE hold	The camera's default setting. While pressing and holding the AF/AEL button, the focus and exposure are set and locked. These settings will remain in effect until the AF/AEL button is released.
AF/AE toggle	Pressing and releasing the AF/AEL button will set and lock the focus and exposure. The settings are cancelled when the AF/AEL button is pressed again.
AE hold	While pressing and holding the AF/AEL button, only the exposure is set and locked. This setting will remain in effect until the AF/AEL button is released or a picture is taken.
AE toggle	Pressing and releasing the AF/AEL button will set and lock the exposure only. The setting is cancelled when the AF/AEL button is pressed again.



- The autofocus and auto exposure settings will not reset after an image has been captured until the AF/AEL button has been released (hold setting) or pressed again (toggle setting).
- When the AE hold or AE toggle are used with the flash, the slow-shutter-sync flash mode will be in effect (p. 76).

Shooting tips

Using the spot-metering mode with the AF/AEL button as an exposure-only lock allows exposure measurements to be made from a different object than the subject. The shutter-release button will continue to control focus, but the exposure can be set from an object that is not at the same distance or at the same position as the subject. This is extremely useful when the colour or tone of the subject is very light or dark.

RECORDING MODE

METERING MODES

	Multi-segment	An advanced metering system appropriate for almost all photographic situations.
	Centre weighted	Averages luminance values from the entire image area with a bias toward the centre of the image.
	Spot	For precise measurements of a small area displayed on the monitors.

The icons indicating the metering mode are displayed on the monitors only. Do not confuse these icons with the focus signals (p. 68). The metering mode is changed in the basic section of the recording-mode menu (p. 80). When centre-weighted or spot metering is selected, pressing the shutter-release button partway down will activate the exposure system, but will not lock the exposure; the AF/AEL button must be used.

Multi-segment metering uses 300 segments (256 segments for the DiMAGE 5) to measure luminance and colour. This data is combined with distance information to calculate the camera exposure. This advanced metering system will give accurate worry-free exposures in almost all situations.

Centre-weighted metering is a traditional metering method in silver-halide cameras. The system measures light values over the entire image area with emphasis given to the central region of the scene.

Spot metering uses a small area within the image to calculate the exposure. When this mode is selected, a small circle will appear in the middle of the live image indicating the measuring area. The spot allows precise exposure measurements of a particular object without being influenced by extremely bright or dark areas within the scene.



Spot metering display

FLASH METERING

Two flash-metering methods are available: ADI and pre-flash TTL. The flash metering-mode can be changed in the basic section of the recording-mode menu (p. 80).

ADI flash metering - Advanced Distance Integration. This metering mode combines distance information from the autofocus system with information from a pre-flash exposure. Unlike conventional TTL flash metering, ADI is not influenced by the reflectance of the subject or background, ensuring optimum flash exposures.

Pre-flash TTL - calculates flash exposure with a pre-flash only. This mode must be used when using close-up filters or filters that reduce the amount of light entering the camera such as neutral density filters. Pre-flash TTL must be used when a diffuser is attached to the built-in flash or an external flash unit.





The camera will automatically switch from ADI metering to pre-flash TTL when a low-contrast subject is preventing the autofocus system from focusing. If the autofocus system cannot lock on the subject, press the AF/MF button and manually focus; the ADI metering will remain in effect.

This camera does not have a preset flash sync speed. When calculating the exposure in program (P) or aperture-priority (A) exposure mode, the shutter speed will not fall below the camera-shake limit (p. 15). When using shutter-priority (S) or manual (M) exposure mode, any shutter speed can be used in the exposure.

For a list of compatible Minolta accessory flash units and for information on accessory flash operation, see page 138. Because both flash modes use a pre-flash, slave controlled flash units cannot be used.

RECORDING MODE

FLASH MODES

Data panel	EVF & LCD monitor		
–		Fill-flash	Used in low-light conditions and to reduce shadows under direct sunlight.
		Red-eye reduction	To reduce the red-eye effect with flash photographs of people and animals
–		Rear flash sync	Flash fires at the end of long exposures.

The flash mode can be changed in the basic section of the recording-mode menu (p. 80). For the flash to fire, the unit must be manually lifted. The flash will fire in the selected mode regardless of the amount of ambient light. When the flash is used, the camera sensitivity is automatically set at ISO 200. This setting can be changed using the function dial (p. 40). The auto-white-balance setting will give priority to the flashes colour temperature. If manual white-balance settings are used, priority is given to the active settings colour temperature (p. 59).

FILL FLASH

Fill-flash can be used as the main or supplementary light. In low-light conditions, the flash will act as the main source of illumination and overpower the ambient light. Under strong sunlight or in backlit situations, the fill-flash can reduce harsh shadows.



RED-EYE REDUCTION

Red-eye reduction is used when taking photographs of people or animals in low-light conditions. The red-eye effect is caused by light reflected from the retina of the eye. The camera will fire a pre-flash before the main flash to contract the pupils of the subject's eyes.

REAR FLASH SYNC

Rear flash sync is used with long exposures to make trailing lights or blurring appear to follow rather than precede the subject. The effect is not apparent if the shutter speed is too fast and stops the subject's motion.

When the shutter is released, a pre-flash will fire. This pre-flash does not exposure the subject, but is used in the calculation of the flash exposure. The flash will fire again just before the shutter closes.



Camera Notes

Slow shutter sync can be set in P and A exposure modes (p. 46). In low-light conditions, this flash mode controls the shutter to increase the ambient or background exposure. When photographing a subject outside at night, the camera and flash exposure will be balanced to bring out the details in the background. Because shutter speeds can be longer than usual, the use of a tripod is recommended.

1. Set the camera to the P or A exposure mode (p. 40).
2. Set "AE hold" or "AE toggle" in the Custom 1 section of the recording mode menu (p. 80).
3. Frame the subject on the monitors.
4. Press the AF/AEL button to lock the exposure.
5. Press the shutter-release button to lock the focus. Composed the image on the monitors.
6. Press the shutter-release button all the way down to take the picture.

RECORDING MODE

FLASH COMPENSATION

The flash output can be controlled by ± 2 Ev in $1/3$ Ev increments. Flash compensation is set in the basic section of the recording-mode menu (p. 80). If the flash compensation is set to any value other than 0.0, the flash-compensation indicator will appear on the monitors and data panel.



Shooting tips

When using the fill-flash to reduce harsh shadows on the subject's face caused by bright illumination or direct sunlight, flash compensation can be used to change the ratio between the high-lights and shadows. The fill-flash will affect the darkness of the shadows without affecting the area illuminated by the main light source. By decreasing the flash output with a negative Ev setting, the shadows will receive less light than with normal fill-flash and be harder, but will bring out subtle details in the shadows that would not appear without the flash. Increasing the flash output by using a positive Ev setting will soften and can even nearly eliminate shadows.



Positive compensation



No compensation



Negative compensation

FLASH RANGE

For correct flash exposures, the subject must be within the flash range. The flash range can be extended by changing the camera sensitivity (p. 40). When the camera sensitivity is set to auto, the ISO is set at 200. The flash range is measured from the CCD. Because of the optical system, the flash range is not the same at the lens' wide-angle position as it is at the telephoto position.

ISO setting	Flash range (wide angle)	Flash range (telephoto)
AUTO	0.5m ~ 3.8m (1.6 ft. ~ 12.5 ft.)	0.5m ~ 3.0m (1.6 ft. ~ 9.8 ft.)
100	0.5m ~ 2.7m (1.6 ft. ~ 8.8 ft.)	0.5m ~ 2.1m (1.6 ft. ~ 6.9 ft.)
200	0.5m ~ 3.8m (1.6 ft. ~ 12.5 ft.)	0.5m ~ 3.0m (1.6 ft. ~ 9.8 ft.)
400	0.5m ~ 5.4m (1.6 ft. ~ 17.6 ft.)	0.5m ~ 4.2m (1.6 ft. ~ 13.8 ft.)
800	0.5m ~ 7.6m (1.6 ft. ~ 25 ft.)	0.5m ~ 6.0m (1.6 ft. ~ 19.6 ft.)

ATTACHING A MINOLTA ACCESSORY FLASH UNIT

To extend the versatility of the camera, an accessory flash unit (sold separately) can be mounted on the camera. See page 138 for a list of compatible flash units.

Slide the accessory-shoe cap off as shown.

Mount the flash unit on the accessory shoe by sliding it forward until it stops.

- Always remove the accessory flash when the camera is not in use. Replace the accessory-shoe cap to protect the contacts.

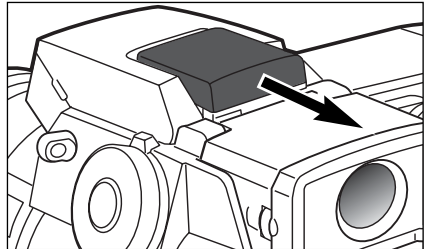

RECORDING MODE

NAVIGATING THE RECORDING-MODE MENU

1 In recording mode, press the menu button to activate the menu. The menu button also turns off the recording-mode menu after making settings.

2 The four-way keys are used to move the cursor in the menu. Pressing the centre of the controller will enter a setting.



Activate the recording-mode menu with the menu button (1). The “Basic” tab at the top of the menu will be highlighted. Use the left/right keys of the controller (2) to highlight the appropriate menu tab; the menus will change as the tabs are selected and highlighted.



When the desired menu section is displayed, use the up/down keys (2) to scroll through the menu options. Highlight the option whose setting needs to be changed.



With the menu option to be changed highlighted, press the right controller key; the settings will be displayed with the current setting highlighted.

- To return to the menu options, press the left key.

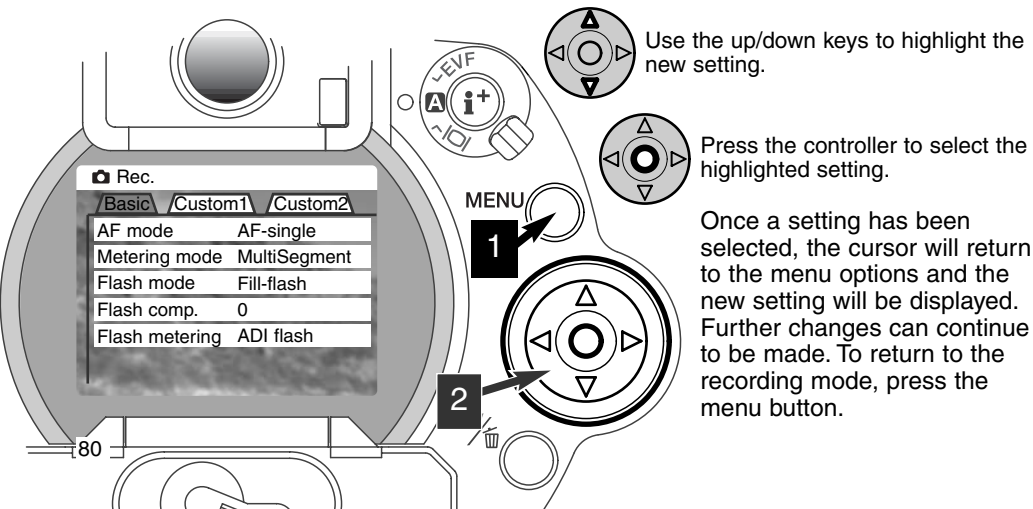

Basic	
AF mode	AF single AF continuous
Metering mode	Multi-segment Centre weighted Spot
Flash mode	Fill-flash Red-eye Rear flash sync
Flash comp.	±2 Ev
Flash Metering	ADI flash Pre-flash TTL

Custom 1	
Memory	1 2 3 Store memory
Exposure bracket	0.3 0.5 1.0
Interval	1~10, 15, 20, 30, 45, 60 min.
Frames	2 ~ 99
AF/AEL button	AF/AE hold AF/AE toggle AE hold AE toggle
Magnification button	Digital zoom Elec. mag.

Custom 2	
Sharpness	Hard (+) Normal Soft (-)
Color mode	Color B&W
Data imprint	No YYYY/MM/DD MM/DD/hr:min Text Text + ID#
Instant playback	No 2 sec 10 sec

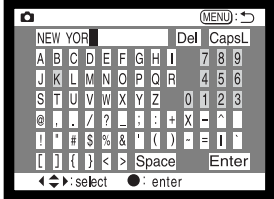

Store in	1 2 3
----------	-------------











For DiIMAGE 7 only

For more information about the electronic keyboard see page 88.

Please refer to the following sections for descriptions of the menu options and their settings.

RECORDING MODE

RECORDING-MODE MENU - BASIC

Menu option	Settings	Description	Data panel display	EVF and LCD monitor display
AF mode (p. 68)	AF-single	Focus is calculated and set when the shutter-release button is pressed partway down.	—	
	AF-continuous	Camera continues to focus on a moving subject even when the shutter-release button is pressed partway down.	—	
Metering mode (p. 74)	Multi-segment	Employs 300 segments (256 for the DiMAGE 5) over the image area to calculate exposure.	—	
	Centre weighted	The exposure calculation is biased toward the the centre region of the image area.	—	
	Spot	The exposure is based on a small area in the centre of the image area.	—	
Flash mode (p. 76)	Fill-flash	General purpose flash mode for low-light conditions and for reducing harsh shadows caused by direct sunlight.	—	
	Red-eye	Same as the fill-flash, but also fires a pre-burst to reduce red-eye in portraits.		
	Rear flash-sync	Flash fires at the end of a long exposure.	—	
Flash compensation (p. 78)	±2 Ev (1/3 Ev increments)	To compensate flash exposure.		

Flash metering (p. 75)	ADI flash	Uses distance and pre-flash information to calculate exposure.	—
	Pre-flash TTL	Uses only pre-flash information to calculate exposure.	—

RECORDING-MODE MENU - CUSTOM 1

Memory (p. 85)	1 ~ 3	Camera settings can be recalled from three memory channels.	—
	Store memory	To store camera settings in memory. When selected, the store-in-memory screen will appear.	—
Exposure bracket (p. 54)	0.3 Ev, 0.5 Ev, 1.0 Ev	Used with the bracketing drive mode to specify the exposure increment for the series.	—
Interval (p. 56)	1 ~ 10, 15, 20, 30, 45, 60 min.	Used with the interval drive mode to specify the duration of the interval between exposures.	—
Frames (p. 56)	2 ~ 99 frames	Used with the interval drive mode to specify the total number of frames for the series.	
AF/AE lock button (p. 73)	AF/AE hold	Focus and exposure are locked while pressing and holding the AF/AEL button.	—
	AF/AE toggle	The AF/AEL button toggles between the focus and exposure being locked and unlocked.	—
	AE hold	Only exposure is locked while pressing and holding the AF/AEL button.	—
	AE toggle	The AF/AEL button toggles between exposure being locked and unlocked.	—







Continued on next page

RECORDING MODE

RECORDING-MODE MENU - CUSTOM 1 (CONT.)

Menu option	Settings	Description	EVF and LCD monitor display
Magnification button (p. 71) (DiIMAGE 7 only)	Digital zoom	The 2X digital zoom is active.	X2.0
	Electronic magnification	The 4X electronic magnification is active.	

RECORDING-MODE MENU - CUSTOM 2

Sharpness (p. 86)	Hard (+)	Sets the degree of sharpness to be applied before the image is captured.	
	Normal		—
	Soft (-)		
Color mode (p. 86)	Color	To record 24-bit colour or 8-bit monochrome images. These settings have no effect on RAW images.	—
	B&W		—
Data imprint (p. 87)	No	Disables the data imprinting function.	—
	YYYY/MM/DD	Imprints date on image	
	MM/DD/hr:min	Imprints date and time on image	
	Text	To imprint caption on image. Electronic keyboard appears when selected.	
	Text + ID#	To imprint caption and serial number on image. Electronic keyboard appears when selected.	
Instant playback (p. 87)	No	Disables the instant playback function.	—
	2 sec.	Images are played back for two seconds after they are captured.	—
	10 sec.	Images are played back for ten seconds after they are captured. During playback the image can be deleted.	—

MEMORY - SAVING CAMERA SETTINGS

Three sets of camera settings can be saved. This feature saves time under frequently repeating conditions by eliminating the need to set camera functions. Except for the AF/AEL button, subject programs, data imprinting, and instant playback settings, all recording-mode camera settings will be saved including the position of the Flex Focus Point, the Custom white balance setting and changes made with the function dial and digital effects control. Although the the bracketing drive mode setting can be saved, the type of bracket, exposure, contrast, or colour saturation, must be set again with the digital effects controller.

Camera settings are saved with the memory function in the Custom 1 section of the recording-mode menu (p. 80). Initially, each memory location contains the camera's original settings.

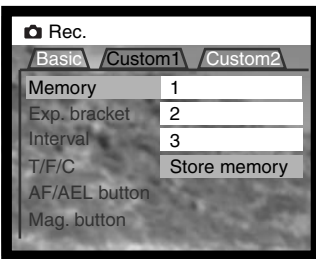

To save the current camera settings, select the store-memory setting from the memory option in the Custom 1 section of the recording-mode menu. The store-in-memory screen will appear.

On the store-in-memory screen, chose the memory register in which the camera settings are to be saved. Pressing the controller will complete the operation; the previous settings will be erased and replaced by the new ones.



To recall a setting, simply choose and enter the appropriate memory register from the memory option of the Custom 1 section of the recording-mode menu. The settings are instantly applied to the camera.

Camera settings cannot be deleted from memory by turning the camera off, using the pro-auto button (p. 37), or choosing the default function on the setup menu (p. 120).

RECORDING MODE

SHARPNESS

The sharpness of the image can be altered. This must be set before the image is recorded. Sharpness is set in the Custom 2 section of the recording-mode menu (p. 80).

Recording-mode menu settings	EVF and LCD monitor display	
Hard (+)		Increases the sharpness of the image, accentuating details.
Normal	–	No filter applied.
Soft (–)		Softens the details of the image.

If any setting other than normal is selected, the sharpness icon will be displayed on the monitors with the degree of sharpness. Sharpness must be reset manually.

COLOUR MODE

The colour mode controls whether the image is colour or black and white. This must be set before the image is recorded. The colour mode is set in the Custom 2 section of the recording-mode menu (p. 80). The live image on the monitors will reflect the selected colour mode. The colour mode has no effect on image file size. The colour mode must be reset manually.

RAW images are not affected by the colour-mode setting. Although the monitors will display a black and white image, the utility software can recreate the original colour.

DATA IMPRINTING

Data can be printed directly on the image. The imprinting function must be activated before the image is taken. Once activated, data will continue to be imprinted until the function is reset; a yellow bar is displayed behind the distance indicator and frame counter on the monitors to indicate the imprinting function is active. Data imprinting is controlled in the Custom 2 section of the recording-mode menu (p. 80).

Recording-mode menu setting	
No	Data imprinting function disabled.
YYYY/MM/DD	Prints the year, month, and day the image was taken. The date format can be changed in the Custom 2 section of the setup menu (p. 114).
MM/DD/hr:min	Prints the date and time the image was taken. The date and time can be set in the Custom 2 section of the setup menu (p. 114).
Text	Up to 16 characters can be printed on the image. When this setting is selected, the electronic keyboard will appear (p. 88).
Text + ID#	Up to eight characters and a serial number can be printed on the image. As each successive image is captured, the ID number will increase by one. When this setting is selected, the electronic keyboard will appear (p. 88). The serial number is reset every time the setting is made.

The data is imprinted in the lower right corner of the image when viewed horizontally. Only one imprinting format can be employed at one time. The data is printed directly on the photograph, writing over the image information.

Camera Notes

Every time a still image is recorded, it is stored with an Exif tag that contains the date and time of recording as well as shooting information. This information can be viewed with the camera in the playback or quick-view mode or on a computer with the DiMAGE Image Viewer Utility software .

RECORDING MODE

ELECTRONIC KEYBOARD

The electronic keyboard is used to enter text for imprinting data or for naming new folders. The keyboard automatically appears when text needs to be entered.

To enter text, simply use the four-way keys of the controller to highlight the desired character and then press the centre of the controller to enter it. Entering the CapL key will change case; the change is immediately displayed on the letters of the keyboard. When complete, highlight the enter key and press the controller to enter the text and complete the operation. To cancel the operation, press the menu button.

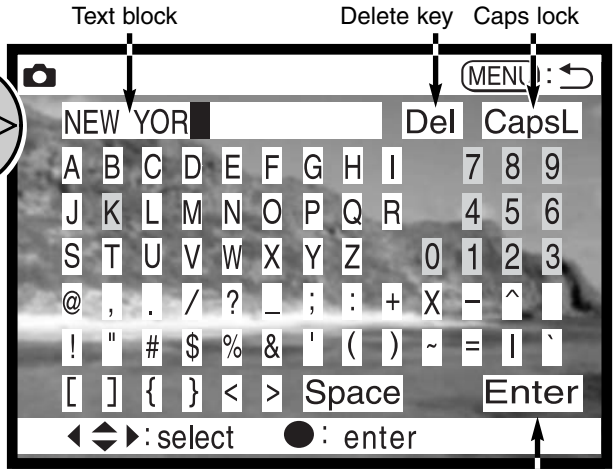
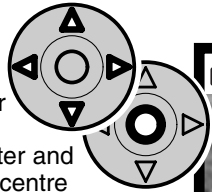

Enter key

To delete text, move the cursor into the text block at the top of the screen. Use the cursor to highlight the character to be deleted. Press the down key; the delete key will be highlighted. Press the centre of the controller to delete the character.

To replace a character, repeat the previous procedure, but when the delete key is highlighted, used the four-way keys to highlight the character to replace the one highlighted in the text box; press the controller to replace the character.

INSTANT PLAYBACK

After an image is captured, it will be displayed on the monitors before being saved. When in continuous drive or bracketing mode, an index display is used. The instant playback function is set in the Custom 2 section of the recording-mode menu (p. 80).

Recording-mode menu setting	
No	Instant playback is disabled.
2 sec	The captured image will be displayed for two or ten seconds. While displayed, the image can be deleted before being saved.
10 sec	

- If the centre of the controller is pressed during the instant playback, the displayed image will immediately be saved and the playback cancelled.

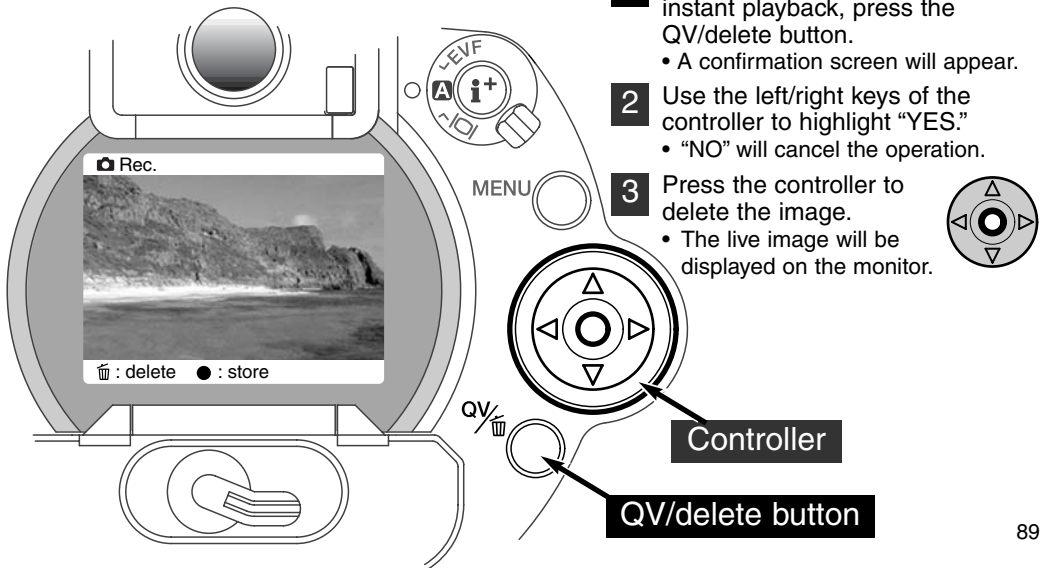

RECORDING MODE

MOVIE RECORDING

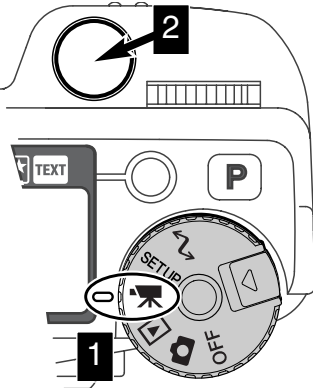

This camera can record up to sixty seconds of digital video. The motion JPEG image is 320 X 240 pixels (QVGA). The effective image area is 308 X 240 pixels; two thin lines will appear to the left and right of the image when played back.

Shooting digital video is simple. Set the main dial to movie recording (1). Frame the picture as described in the basic recording operation (p. 29). Press the shutter-release button once to start recording (2). The camera will continue to record until the recording time is used or the shutter-release button is pressed again. When recording, the data panel and monitor frame counters will countdown the remaining time.



● REC — Recording indicator
45s — Countdown in seconds

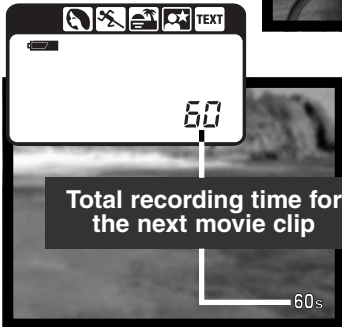

When the camera is not recording, the data-panel and monitor frame counters will show the maximum time in seconds that can be recorded with the next movie clip. A maximum of 60 seconds will be displayed until the amount of remaining time falls below one minute, then the remaining number of seconds that can be recorded will be displayed.

The table below shows the approximate total recording time with various CompactFlash cards. Actual time depends on the subject and the number of still images captured.

	8MB	16MB	64MB
DiIMAGE 7	44 sec.	90 sec.	363 sec.
DiIMAGE 5	36 sec.	70 sec.	290 sec.

This table indicates which functions can be used, which are fixed, and which are disabled in movie mode. Manual focus can be used before or during movie recording.

Exposure compensation (p. 63)	Available
Contrast compensation (p. 64)	Available
Color-saturation compensation (p. 65)	Available
Macro mode (p. 69)	Available
Focus mode (p. 68, 71)	Continuous AF or Manual
Autofocus area (p. 66)	Wide (fixed)
Exposure mode (p. 47)	Program (fixed)
Metering mode (p. 74)	Centre-weighted (fixed)
Camera Sensitivity (ISO) (p. 61)	Auto (fixed)
White balance (p. 58)	Auto white balance (fixed)
Flash	Disabled
Digital zoom (Electronic magnification)	Disabled
Digital-subject-program button	Disabled
Function Dial	Disabled
AF/AEL button	Disabled
Recording-mode menu	Disabled

RECORDING MODE

BULB EXPOSURES

Bulb photographs can be taken in the manual-exposure mode (M) (p. 71). Exposures up to thirty seconds can be made by pressing and holding the shutter-release button. The use of a tripod and a remote cord is recommended for bulb exposures.

Use the control dial (1) to decrease the shutter-speed value below four seconds until “bulb” is displayed.

To set the aperture value, turn the Digital Effects Controller to exposure compensation (2). While pressing the digital effects button (3), turn the control dial (1) until the correct aperture is displayed.

- The camera's exposure system cannot be used to calculate bulb exposures. The use of a separate light meter is recommended.

To take the picture, press and hold the shutter-release button for the duration of the exposure.

- Releasing the shutter button will end the exposure.
- The monitors will be blank during the exposure.

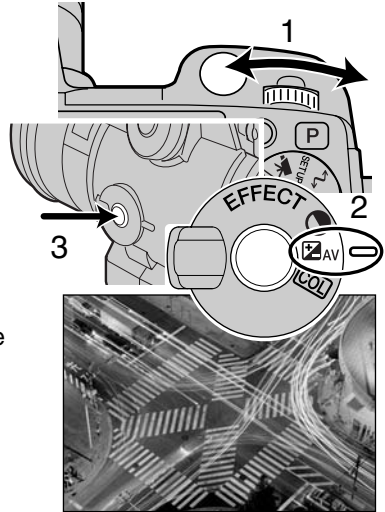

ATTACHING A REMOTE CORD (SOLD SEPARATELY)

The optional remote cords (RC-1000S or RC-1000L) can be used to reduce vibrations from touching the camera during long exposures.

Remove the remote-control terminal cover.

- Use the notch on the left side of the cover.
- The cover is attached to the body to prevent loss.

Insert the plug of the cord into the terminal.

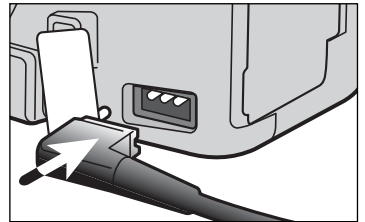

PLAYBACK MODE

VIEWING AND EDITING IMAGES

This section contains detailed information on the camera's playback functions and operation. Read the sections pertaining to your interest and need. The sections on viewing pictures, viewing movies, deleting images (p. 94 - 95), navigating the playback-mode menu (p. 102), and frame-selection screen (p. 111) cover the use of most of the features for viewing and editing images. The navigating the playback-mode menu section is followed by detailed descriptions of the settings.

PLAYBACK MODE

VIEWING PICTURES

Still images and movie clips can easily be viewed and edited in playback mode. To set the camera to view images, turn the mode dial to the playback position (1).

Simply use the controller to scroll through the pictures on the CompactFlash card. Images are displayed with date, frame number, printing status, and lock status information. Still images can be displayed with a histogram and shooting data. The first frame of each movie clip is shown; a movie clip is indicated by the movie icon displayed with a thumbnail of the first frame.

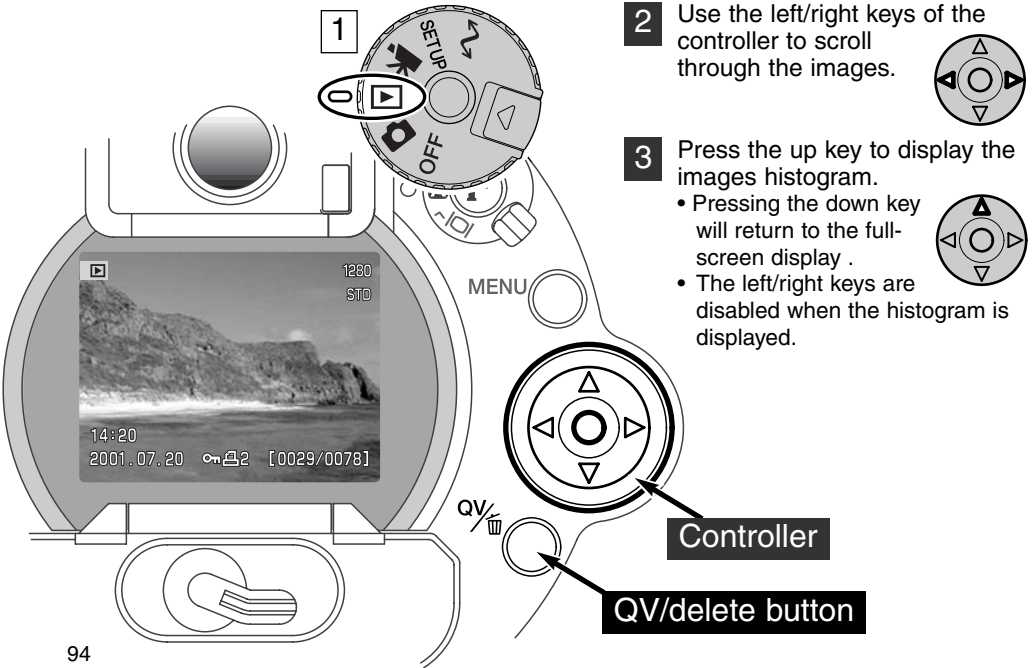

- 2** Use the left/right keys of the controller to scroll through the images.
- 3** Press the up key to display the images histogram.
 - Pressing the down key will return to the full-screen display .
 - The left/right keys are disabled when the histogram is displayed.

VIEWING MOVIES

- 1 Use the left/right keys of the controller to display the movie clip to be viewed.
- 2 Press the centre of the controller to play back the clip.
 - Pressing the controller during playback will pause the movie clip; pressing the controller again will resume the playback.
 - When the movie clip finishes, the first frame will be displayed.
- 3 To cancel the playback of a movie, press the down key of the controller.



DELETING IMAGES

In playback mode, the displayed image or movie clip can be deleted. When selecting an image for deletion, a confirmation screen will appear before the operation is executed.

Once deleted, an image cannot be recovered. Care should always be taken when deleting images.

- 1 To delete a displayed image, press the QV/delete button.
 - A confirmation screen will appear.
- 2 Use the left/right keys to highlight "YES."
 - "NO" will cancel the operation.
- 3 Press the controller to delete the image.

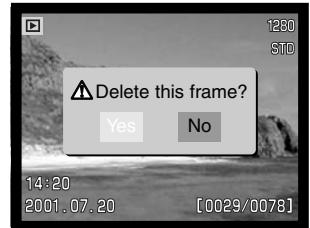

Confirmation screen

PLAYBACK MODE

SINGLE-FRAME PLAYBACK DISPLAY

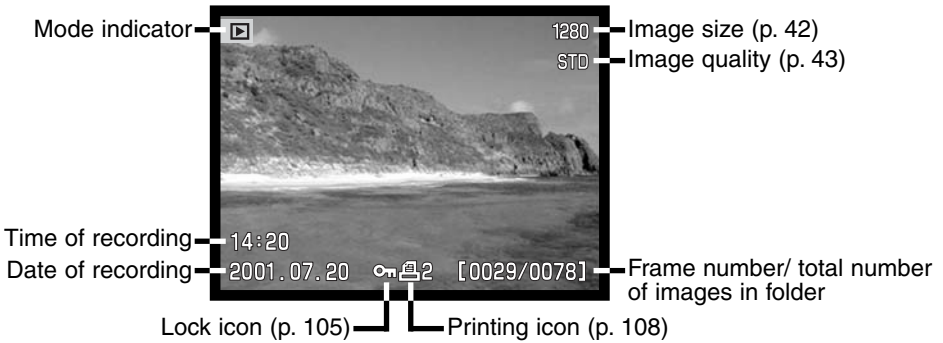

MOVIE PLAYBACK DISPLAY

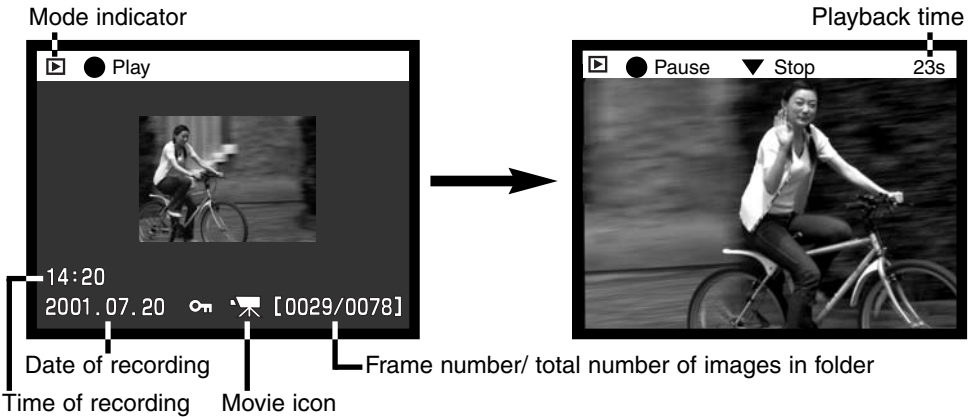

HISTOGRAM DISPLAY

Mode indicator Thumbnail of image

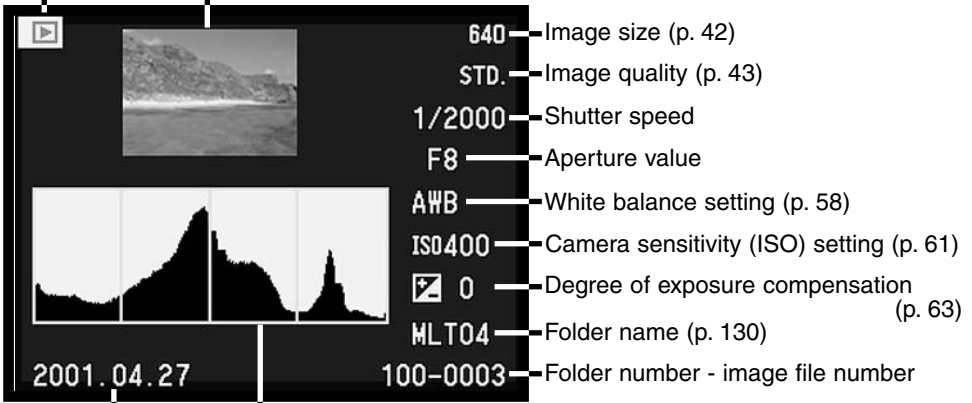

Date of recording The luminance distribution of the image

The black area of the histogram shows the luminance distribution of the recorded image from black (left) to white (right). Each one of the 256 vertical lines indicates the relative proportion of that light value in the image. The histogram can be used to evaluate exposure and contrast, but displays no colour information. A change in exposure would create an image whose histogram would be the same shape as a previous image, but would be shifted to the left (less exposure) or right (more exposure). Changing the contrast would contract (decrease in contrast) or expand (increase in contrast) the distribution of luminance values compared with a previous image of the scene.

PLAYBACK MODE

DISPLAY CONTROLS - PLAYBACK MODE

Located on the back of the camera, the display-mode switch and the display-information button controls on which monitor the image is displayed and the display format. The three position switch allows the choice between automatic display and setting the display to the EVF or LCD monitor.

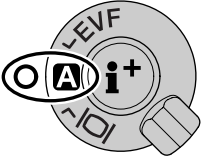

Auto display - the camera will automatically change between displaying the image in the EVF or on the LCD monitor. The EVF's eye sensors monitor if the EVF is being used and switch the display location accordingly.

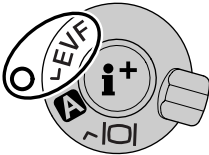

EVF display - the image will only be displayed in the electronic viewfinder. Under bright-light, the EVF is easier to see than the LCD monitor.

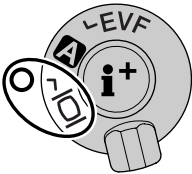

LCD monitor display - the image will only be displayed on the LCD monitor.



In the centre of the display switch, the display-information button controls the display format. Each time the button is pressed the display cycles through to the next format: full display, image only, index playback.

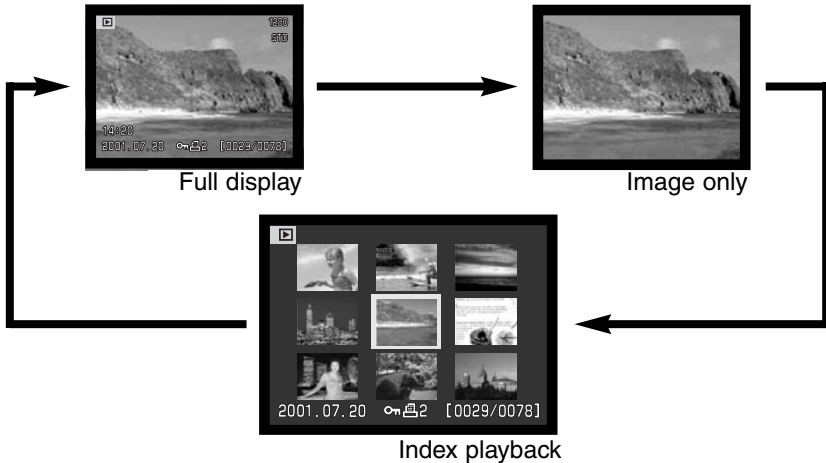

In index playback, the left/right keys of the controller will move the yellow border to the next or the previous image. When the image is highlighted with the border, the date of recording, the lock and printing status, and the frame number of the images is displayed at the bottom of the screen. The highlighted image can be deleted using the QV/delete button (p. 95). When the display information button is pressed again, the highlighted image will be displayed in the single-frame playback mode. A nine or four image index can be displayed. The index-playback format can be changed in the basic section of the playback-mode menu (p. 102).

PLAYBACK MODE

ENLARGED PLAYBACK

In single-frame playback, a still image can be enlarged for closer examination. RAW and super fine images cannot be enlarged.

- 1 With the image to be enlarged displayed, press the magnification button.
 - The degree of magnification is displayed in the EVF and on the LCD monitor.
 - The image is magnified in a maximum of three steps. Each time the magnification button is pressed the image is enlarged. After the final step, the image is displayed at the original size.
- 2 When enlarged, the four-way keys of the controller can scroll the image.

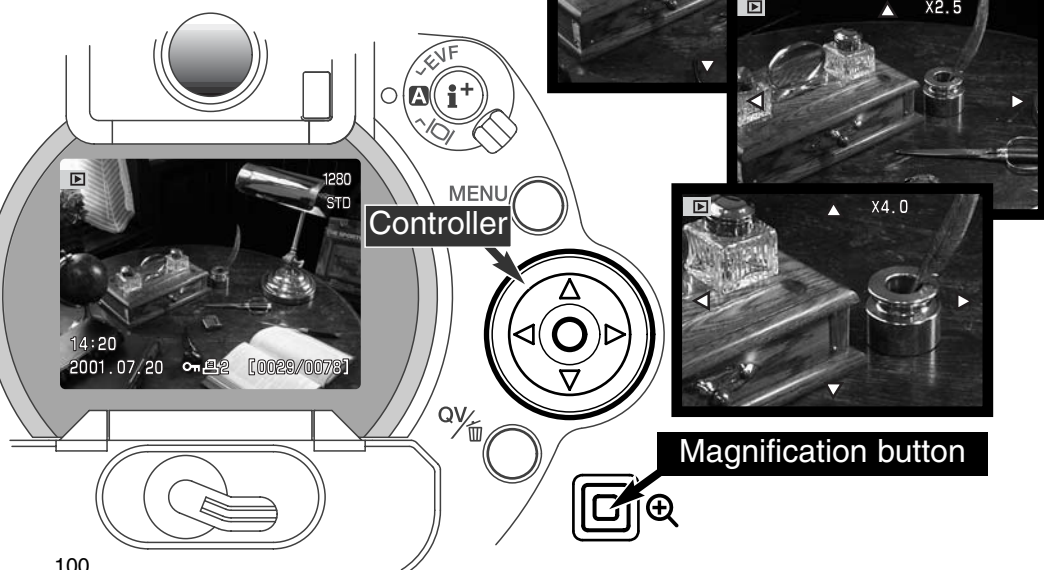

The number of magnification steps in enlarged playback is dependent on the size of the recorded image. The smaller the image size, the fewer steps are available. 1024 X 768 digital zoom images recorded with the DiMAGE 5 are enlarged in three steps: 2X, 2.5X and 3.2X.

DiMAGE 7	2560 X 1920	1600 X 1200	1280 X 960	640 X 480
1 st step	2X	2X	2X	2X
2 nd step	2.5X	2.5X	2.5X	–
3 rd step	4X	4X	4X	–

DiMAGE 5	2048 X 1536	1600 X 1200	1280 X 960	640 X 480
1 st step	2X	2X	2X	2X
2 nd step	2.5X	2.5X	2.5X	–
3 rd step	3.2X	3.2X	3.2X	–

PLAYBACK MODE

NAVIGATING THE PLAYBACK-MODE MENU

1 In playback mode, press the menu button to activate the menu. The menu button also turns off the playback-mode menu when the settings have been completed.

2 The four-way keys are used to move the cursor in the menu. Pressing the controller will enter a setting.



Activate the playback-mode menu with the menu button (1). The “Basic” tab will be highlighted. Use the left/right keys of the controller (2) to highlight the appropriate menu tab; the menus will change as the tabs are highlighted.



When the desired menu is displayed, use the up/down keys (2) to scroll through the menu options. Highlight the option whose setting needs to be changed.



With the menu option to be changed highlighted, press the right controller key; the settings will be displayed with the current setting highlighted.

- To return to the menu options, press the left key.

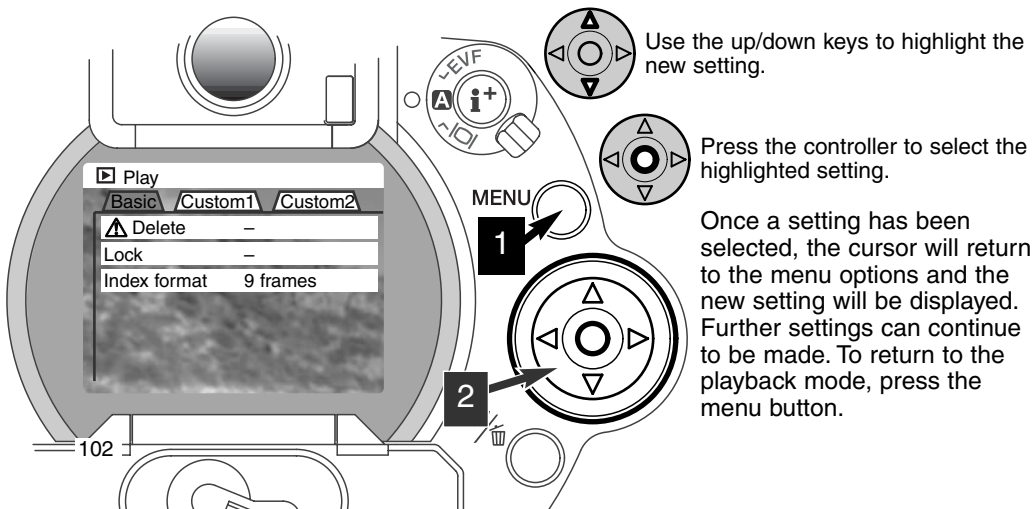

Basic

Delete	This frame	
	All frames	
	Marked frames	
Lock	This frame	
	All frames	
	Marked frames	
	Unlock frames	
Index format	9 frames	
	4 frames	

Yes No

Choosing "Yes" will execute the operation, "No" will cancel the operation

Please refer to the following sections for descriptions of the menu options and their settings.

For information on frame-selection screens, see page 111.

Custom 1

Slide show	Start	
Playback	All frames	
	Marked frames	
Duration	1 ~ 60 sec.	
Repeat	No	
	Yes	



Pressing the down key of the controller will cancel the slide show playback and return to the playback-mode menu.

Custom 2

Print	This frame	
	All frames	
	Marked frames	
Index print	No	
	Yes	
Cancel print	All frames - F	
	All frames - C	
Copy	This frame	
	Marked frames	

Number of copies

New folder number

Yes No

- 1 Copying to camera memory
- 2 Please change CF card
- 3 Copying to CF card
- 4 Copy completed

PLAYBACK MODE

PLAYBACK-MODE MENU - BASIC

DELETING IMAGES

Deleting permanently erases the image. Once deleted, an image cannot be recovered. Care should be taken when deleting images.

Single, multiple, or all images in a folder can be deleted with the playback-mode menu. Before an image is deleted, a confirmation screen will appear; choosing “Yes” will execute the operation, “No” will cancel the operation. To delete images in other folders, the folder must first be selected in the Custom 1 section of the setup menu (p. 114). The delete option has three settings:

This frame - The image displayed or highlighted in playback mode will be deleted.

All frames - All unlocked images in the selected folder will be deleted.

Marked frames - To delete multiple images. When this setting is chosen, the frame-selection screen will be displayed. Use the left/right keys of the controller to highlight the first image to be deleted. Pressing the up key will mark the image with the garbage-can icon. To deselect an image for deletion, highlight it with the yellow border and press the down key; the garbage-can icon will disappear. Continue until all the images to be deleted are marked. Press the controller to continue (the confirmation screen will appear), or press the menu button to cancel the operation and return to the playback menu. On the confirmation screen, highlighting and entering “Yes” will delete the marked images.

The delete function will only erase unlocked images. If an image is locked, it must be unlocked before it can be deleted.

LOCKING IMAGES

Single, multiple, or all images in a folder can be locked. A locked image cannot be deleted by either the playback-mode menu functions or the QV/delete button. Important images should be locked. To lock images in other folders, the folder must first be selected in the Custom 1 section of the setup menu (p. 114). The lock option has four settings:

This frame - The image displayed or highlighted in playback mode will be locked.

All frames - All images in the folder will be locked.

Marked frames - To lock or unlock multiple images. When this setting is chosen, the frame-selection screen will be displayed. Use the left/right keys of the controller to highlight the image to be locked. Pressing the up key will mark the image with the key icon. To unlock an image, highlight it with the yellow border and press the down key; the key icon will disappear. Continue until all the images to be locked are marked. Press the controller to lock the marked frames, or press the menu button to cancel the operation and return to the playback menu.

Unlock frames - All images in the folder will be unlocked.

Locking an image will protect it from a delete function. However, the formatting function will erase all images on a CompactFlash card whether locked or not.

CHANGING INDEX PLAYBACK FORMAT

The index format option allows the index playback to be displayed with four or nine images. This effects all index displays.

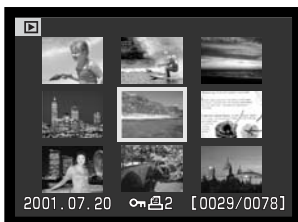

PLAYBACK MODE

PLAYBACK-MODE MENU - CUSTOM 1 (SLIDE SHOW)

The Custom 1 section of the playback-mode menu controls the slide-show function. This function automatically displays all still images in a folder in order.



Image count-down / total number of images in the presentation.

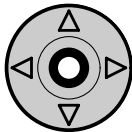

Press the controller to pause and restart the presentation.



To cancel the presentation, press the down key of the controller.

Menu options	Settings	
Slide show	Start	To start the slide-show presentation. Pressing the centre of the controller will pause the presentation. During the slide show, press the down key of the controller to stop the presentation and return to the playback-mode menu.
Playback	All frames	To select all the images in the folder to be displayed in the slide-show presentation.
	Marked Frames	To select specific images in the folder to be displayed in the slide-show presentation. When this setting is chosen, the frame-selection screen will be displayed. Use the left/right keys of the controller to highlight the image to be included in the presentation. Pressing the up key will mark the image with a check icon. To deselect a marked image, highlight it with the yellow border and press the down key; the check icon will disappear. Continue until all the images have been edited. Press the controller to set the marked frames, or press the menu button to cancel the operation and return to the playback menu.
Duration	1 - 60s.	To select the period each image will be displayed during the slide show.
Repeat	Yes / No	Selecting "Yes" will cause the slide show to repeat until it is cancelled using the down key of the controller. "No" will end the slide show presentation and return to the playback-mode menu when all the images have been displayed once.

PLAYBACK MODE

PLAYBACK-MODE MENU - CUSTOM 2

ABOUT DPOF

This camera is supported by DPOF™ version 1.1. The DPOF (Digital Print Order Format) allows direct printing of still images from digital cameras. After the DPOF file is created, the CompactFlash card is simply taken to a photofinishing service or inserted into the CompactFlash-card slot of DPOF compatible printers. When a DPOF file is created, a misc. folder is automatically made on the CompactFlash card to store it (p. 130). DPOF print files cannot be made for RAW images.

CREATING A DPOF PRINT ORDER

The print menu option is used to set an order for standard prints from images in a specific folder. Single, multiple, or all images can be printed. If a CompactFlash card has multiple folders, a printing file must be created for each folder. Folders are selected in the Custom 1 section of the setup menu (p. 114).

This-frame - To create a DPOF file for the image displayed or highlighted in playback mode.

All-frames - To create a DPOF file for all images in the folder specified in the Custom 1 section of the setup menu (p. 114).

Marked frames - To choose a group of images to be printed or when the number of copies for each image varies. When selected, the frame selection screen will appear. Use the left/right keys of the controller to highlight an image to be printed. Pressing the up key will mark the image with the printer icon. The number next to the icon indicates the number of copies of that image to be printed. Pressing the up key will increase the number of copies, pressing the down key will decrease the number. A maximum of nine copies can be ordered. To deselect an image for printing, press the down key until the the number of copies reaches zero and the printer icon disappears. Continue until all the images to be printed are marked. Press the controller to create the DPOF file, or press the menu button to cancel the operation and return to the playback menu.

When the this-frame or all-frames setting is chosen, a screen will appear requesting the number of copies of each image; a maximum of nine copies can be ordered. Use the up/down keys of the controller to set the number of copies desired. If the all-frames setting was used to create a print order, any additional images saved afterwards in the folder will not be included in the order.

Dpof files cannot be created for images captured with another camera. DPOF data created on other cameras will not be recognised.

ORDERING AN INDEX PRINT

To create an index print of all the images in the folder, select “Yes.” To cancel an index print, simply change the setting to “No.” If an index-print order is created, any additional images saved afterwards in the folder will not be included in the index print. The number of images printed per sheet differs between printers. The information printed with the thumbnails can vary.



CANCELING A DPOF PRINT ORDER

The cancel-print option deletes the DPOF files. When the setting is selected, a confirmation screen will appear; choosing and entering “Yes” will execute the operation and cancel the print order. After the pictures have been printed, the DPOF file will still remain on the CompactFlash card and must be cancelled manually.

All frames C - To cancel all printing files on the CompactFlash card.

All frames F - To cancel the printing file in the folder.

PLAYBACK MODE

COPYING IMAGES

Image files can be copied from one CompactFlash card to another. Up to 10MB of data can be transferred. Every time the copy function is used a new folder is automatically be created for the images (p. 130).

This frame - To copy the image currently displayed.

Marked frames - To copy single or multiple images. When selected, the frame-selection screen will appear; highlight the image to be copied with the yellow border and then press the up key of the controller to mark it with the check icon. To deselect an image to be copied, highlight the selected image and press the down key; the check icon will disappear. Continue until all the images to be copied are marked. Press the controller to continue, or press the menu button to cancel the operation and return to the playback menu.

When the controller is pressed, a screen with four messages will be displayed; the messages are highlighted as the copying procedure is executed. When the change-CF-card message is highlighted, remove the camera's CompactFlash card and insert the card to which the image should be copied. Press the centre of the controller to continue. Wait until the copy-completed message is highlighted. A new screen will appear to indicate the name of the new folder containing the copied images; press the controller to return to the playback menu.

If too many images have been selected, a warning will appear and the copy routine will be cancelled. Divide the number of images into two or three batches. The copy-unsuccessful message will appear when one or all of the images could not be copied. Check the second CompactFlash card to see which files were copied and then repeat the procedure for the images that could not be transferred.

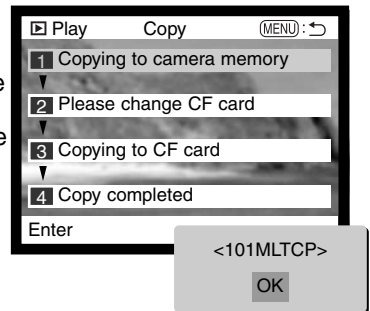

FRAME-SELECTION SCREEN

When a marked-frames setting is chosen on a menu, the frame selection screen will appear. This screen allows multiple images to be chosen. The index format of the screen can be changed in the basic section of the playback-mode menu (p. 102).





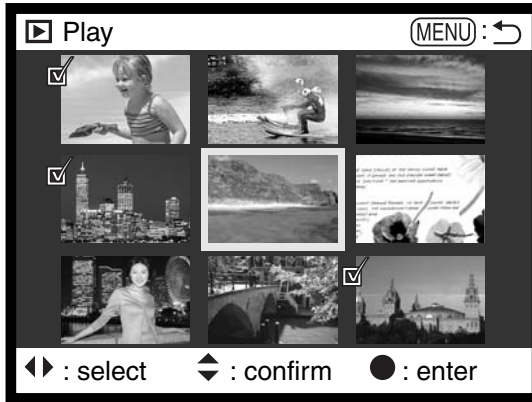

The left/right keys of the controller move the yellow border to select the image.

Menu button

Cancels the screen and any operation made.



The up key of the controller selects the frame; when selected, an icon will appear next to the image. The down key will deselect the image removing the icon.

	<p>The garbage-can icon indicates the image is selected for deletion.</p>
	<p>The key icon indicates the image is locked or selected to be locked.</p>
	<p>The check icon indicates the image is selected for the slide show or to be copied to another CompactFlash card.</p>
	<p>The printer icon indicates the image is selected for printing. The number next to the icon shows the number of copies requested.</p>

VIEWING IMAGES ON A TELEVISION

It is possible to view camera images on your television. The camera has a video-out terminal which can be used to connect the camera to a television using the supplied video cable. The camera is compatible with the NTSC and PAL standards. The video-output setting can be checked and set in the Custom 2 section of the setup menu (p. 114).

1. Turn off the television and the camera.
2. Insert the mini-plug end of the video cable into the camera's video-out terminal.
3. Plug the other end of the video cable into the video-input terminal on the television.
4. Turn the television on.
5. Change the television to the video channel.
6. Turn the camera's mode dial to the playback position.
 - The camera's monitors will not activate when the camera is attached to a television. The playback-mode display will be visible on the television screen.
7. View images as described in the playback section.

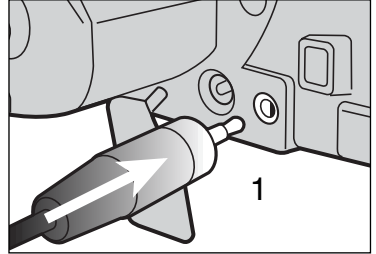

SETUP MODE

CONTROLLING THE CAMERA'S OPERATION

This section contains detailed information on controlling the camera's functions and operation as well as creating and selecting image folders. The 'navigating the setup menu' section (p. 114) covers the operation of the setup menu. The section is followed by detailed descriptions of the settings.

SETUP MODE

NAVIGATING THE SETUP MENU

The four-way keys of the controller are used to move the cursor in the menu. Pressing the controller will enter a setting.



The “Basic” tab will be highlighted. Use the left/right keys of the controller (2) to highlight the appropriate menu tab; the menus will change as the tabs are highlighted.



When the desired menu is displayed, use the up/down keys (2) to scroll through the menu options. Highlight the option whose setting needs to be changed.



With the menu option to be changed highlighted, press the right controller key; the settings will be displayed with the current setting highlighted.

- To return to the menu options, press the left key.



Use the up/down keys to highlight the new setting.



Press the controller to select the highlighted setting.

Once a setting has been selected, the cursor will return to the menu options and the new setting will be displayed. Further settings can continue to be made.

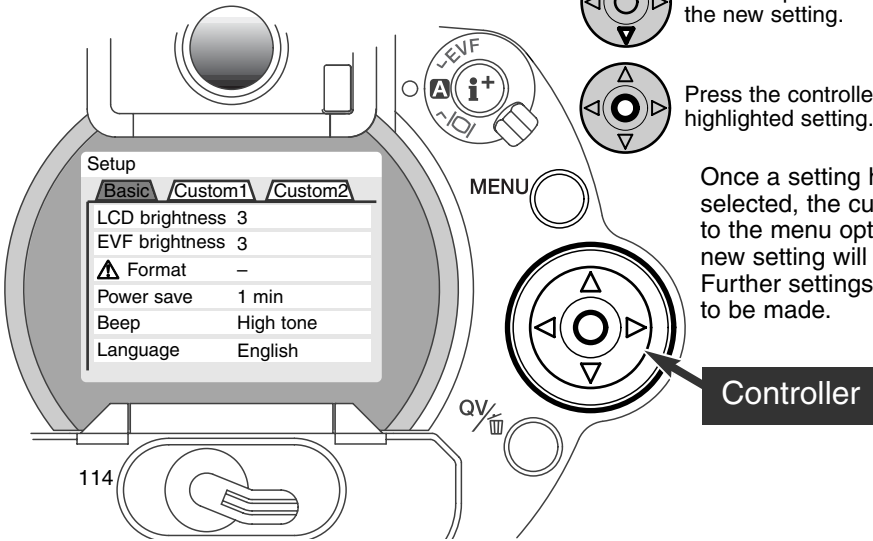

Basic	
LCD brightness	1 (low) ~ 5 (high)
EVF brightness	1 (low) ~ 5 (high)
Format	Enter
Power Save	1, 3, 5, or 10 min
Beep	High tone
	Low tone
	Off
Language	English
	Deutsch
	Français
	Español

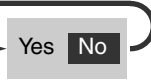

Choosing “Yes” on the confirmation screens will execute the operation, “No” will cancel the operation

Please refer to the following sections for descriptions of the menu options and their settings.

Custom 1	
File # memory	Yes
	No
Select folder	(Folder names)
New folder	Enter

For more information about the electronic keyboard, see page 88.

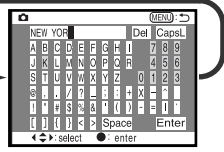

Custom 2	
Reset default	Enter
EVF autoSwitch	Auto EVF/LCD
	EVF auto on
Date/Time set	Enter
Date format	YYYY/MM/DD
	MM/DD/YYYY
	DD/MM/YYYY
Video output	NTSC
	PAL



Year • Month • Day Hour : Minute

SETUP MODE

SETUP MENU - BASIC

The basic section of the setup menu allows changes to be made to the operation of the camera as well as the ability to format CompactFlash cards.

EVF AND LCD MONITOR BRIGHTNESS

The brightness settings of the EVF and LCD monitor is set independent of each other. Brightness is controlled in five levels from 1 (low) to 5 (high). As each setting is highlighted, the monitor will adjust accordingly; the controller must be pressed to set the highlighted level. When the LCD brightness or EVF brightness setting is selected, the corresponding monitor will activate automatically.

FORMATTING COMPACTFLASH CARDS

When a CompactFlash card is formatted, all data on the card is erased.

The formatting function is used to erase all data on a CompactFlash card. Before formatting a CompactFlash card, copy the data to a computer or storage device. Locking images will not protect them from being deleted when the card is formatted. Always format the CompactFlash card using the camera; never use a computer to format a card.

When the format option is selected and entered, a confirmation screen will appear. Choosing "Yes" will format the card, choosing "No" will cancel the formatting operation. A screen will appear to indicate the card has been formatted; press "OK" to return to the setup menu.

If the card-not-recognised message appears, the inserted card in the camera may need to be formatted. A CompactFlash card used in another camera may need to be formatted before being used. If the unable-to-use-card message appears, the card is not compatible with the camera and should not be formatted.

AUTO POWER SAVE

The camera will turn off the EVF and data panel to conserve battery power if no operation is made within a certain period. The length of this period can be changed to 1, 3, 5, or 10 minutes. The auto-power-save option will not effect the display period of LCD monitor; it will shut down after 30 seconds. To restore the displays when they shut down, simply press the shutter-release button or the display information button.

When the camera is connected to the computer, the auto-power-save period is set to ten minutes. This period cannot be changed.

BEEP

The audio signal can be turned off or on. The tone of the signal can be changed to high or low.

LANGUAGE

The language used in the menus can be changed.

SETUP MODE

SETUP MENU - CUSTOM 1

The Custom 1 section of the setup menu controls file number sequencing and the creation of new folders. See page 130 about the organisation of the folders on the CompactFlash card

FILE NUMBER (#) MEMORY

When file number memory is selected, if a new folder is created, the first file stored in the folder will have a number one greater than the last file saved. This allows multiple folders to be created to store images by category, place, or date, but the image file numbers will be in the order in which they were shot. If the file number memory is disabled, the image file name will have a number one greater than the last image saved in the folder.

If file number memory is active and the CompactFlash card is changed, the first file saved to the new card will have a number one greater than the last file save on the previous card if the new card does not contain an image with a greater file number. If it does, the file number of the new image will be one greater than the greatest on the card.

SELECT FOLDER

This option allows the selection of existing folders. After folder is selected, all images recorded will be placed in that folder. In quick view or playback mode, only the images in the selected folder can be viewed or edited.

Except for the all-frames-C setting in the Custom 2 section of the playback-mode menu, changes made with menus only affect the images in the selected folder. To make changes to all images in multiple folders, each folder must be selected and the menu operation repeated for each folder. Formatting a CompactFlash card in the basic section of the setup menu erases all folders regardless of whether they are selected or not.

NEW FOLDER

This allows the creation of new folders. When selected, the electronic keyboard (p. 88) automatically appears so that the folder name can be entered. Once the name is typed in and the enter button on the keyboard is highlighted and entered, the folder will be created and the name will be listed in the select-folder option.

Every folder name begins with a three digit index number. When the electronic keyboard activates, three digits will be displayed in the register. This number cannot be changed. Everytime a new folder is created, the folder number will increase automatically by one greater than the highest folder number on the CompactFlash card. A five-character folder name must be entered after the number; only capital letters, numbers, and the underbar can be used. To cancel the electronic-keyboard display without creating a new folder, press the menu button.

SETUP MODE

SETUP MENU - CUSTOM 2

RESET DEFAULT

Unlike the pro-auto button (p. 37), this function affects not only the recording mode, but also the playback, and setup modes. When selected, a confirmation screen will appear; choosing “Yes” resets the following functions and settings, “No” cancels the operation.

	Default Setting	Page
Exposure mode	Program	46
Focus mode	Single AF	68
Focus area	Wide focus area	66
Digital zoom	Cancelled	70
White balance	Auto white balance	58
Exposure compensation	0.0	63
Contrast compensation	0	64
Color-saturation compensation	0	65
Image quality	Standard	43
Image size	2560 X 1920 (2048 X 1536)*	42
Camera sensitivity (ISO)	Auto	61
Drive mode	Single-frame advance	51
Metering mode	Multi-segment	74
Flash mode	Fill flash	76
Flash compensation	0.0	78
Flash metering	ADI metering	75
Exposure bracket	0.3 Ev	54

* for DiIMAGE 5 only.

	Default Setting	Page
Interval capture	1 minute	56
Total frame count	2 frames	56
AF/AEL button	AF/AE hold	73
Sharpness	Normal	86
Color mode	Color	86
Data imprinting	No (Disabled)	87
Instant playback	No	89
Index playback format	9 frames	105
Duration (Slide Show)	5 seconds	106
Repeat (Slide Show)	No	106
Index print	No (Cancelled)	109
LCD monitor brightness	3	116
EVF brightness	3	116
Auto-power-save period	1 minute	117
Beep	High tone	117
File number memory	No (Disabled)	118
EVF auto switch	Auto EVF/LCD	121
Magnification button	2X digital zoom (DiIMAGE 7 only)	83

EVF AUTO SWITCH - CONTROLLING THE AUTO-DISPLAY FUNCTION

This option controls the auto-display function in recording mode (p. 32). The auto-EVF/LCD setting allows the display to switch between the EVF and LCD monitor automatically. The EVF-auto-on setting turns off the LCD monitor and uses the eye sensors to activate only the EVF when in use. This setting will help conserve battery power.

SETUP MODE

SETTING THE DATE AND TIME

It is important to accurately set the clock. When a still image or a movie clip is recorded, the date and time of the recording is saved with the image and is displayed during playback or can be read with the DiIMAGE Image Viewer Utility software included on the CD-ROM. The camera's clock is also used with data imprinting.

When the Date/Time-set option is selected and entered, the date/time screen will be displayed. The left/right keys of the controller are used to select the item to be changed and the up/down keys are used to change the value. From left to right, the screen shows the year, month, day, hour, and minute. When the date and time have been adjusted, set the clock by pressing the centre of the controller.

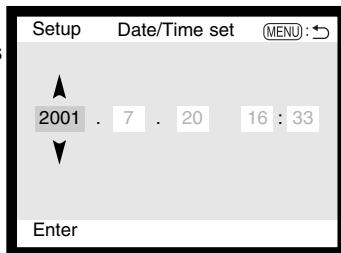

SETTING THE DATE FORMAT

The date format that is displayed or imprinted can be changed: YYYY/MM/DD (year, month, day), MM/DD/YYYY (month, day, year), DD/MM/YYYY (day, month, year). Simply select the format and enter it by pressing the centre of the controller; the new format will be displayed on the menu.

VIDEO OUTPUT

Camera images can be displayed on a television (p. 112). The video output can be changed between NTSC and PAL. North America uses the NTSC standard and Europe uses the PAL standard. Check which standard is used in your region to play back images on your television set.

DATA-TRANSFER MODE

CONNECTING TO A COMPUTER

Read this section carefully before connecting the camera to a computer. Details on using and installing the DiMAGE Image Viewer Utility software are found in the supplied software manual. These manuals do not cover the basic operation of computers or their operating systems; please refer to the manual supplied with your computer.

For the camera to be connected directly to the computer and used as a mass storage device, the following requirements must be met:

IBM PC / AT Compatible	Macintosh
Pre-installed Windows Me, 2000, 98, or 98 second edition operating systems	Pre-installed Mac OS 8.6 ~ 9.1
USB port as standard interface	

Users with Windows 98 or 98 second edition will need to install the driver software on the included CD-ROM (p. 126). Users with Mac OS 8.6 will need to download and install a USB mass storage device from the Apple web site (p. 129). There have been no reports of compatibility problems with Apple G4 computers with Mac OS 10.0.3 or earlier.

DATA-TRANSFER MODE

CONNECTING THE CAMERA TO A COMPUTER

A fresh set of batteries should be used when the camera is connected to a computer. The use of the AC adaptor (sold separately) is recommended over the use of batteries. For users with Windows 98 and Mac OS 8.6 read the respective sections on how to connect to the operating system before connecting the camera to a computer (Windows 98 - p. 126, OS 8.6 - p. 129).

- 1 Start up the computer.
 - The computer must be turned on before connecting the camera.
- 2 Insert the CompactFlash card into the camera.
 - Confirm that the correct card is in the camera. To change the CompactFlash card while the camera is connected to a computer, see page 134.
- 3 Set the mode dial to the data-transfer position.
 - The data-transfer menu will be displayed.
- 4 Open the card-slot door. Attach the smaller plug of the USB cable to the camera.
 - Make sure the plug is firmly attached.
- 5 Attach the other end of the USB cable to the computer's USB port.
 - Make sure the plug is firmly attached.
 - The camera should be connected directly to the computer's USB port. Attaching the camera to a USB hub may prevent the camera from operating properly.

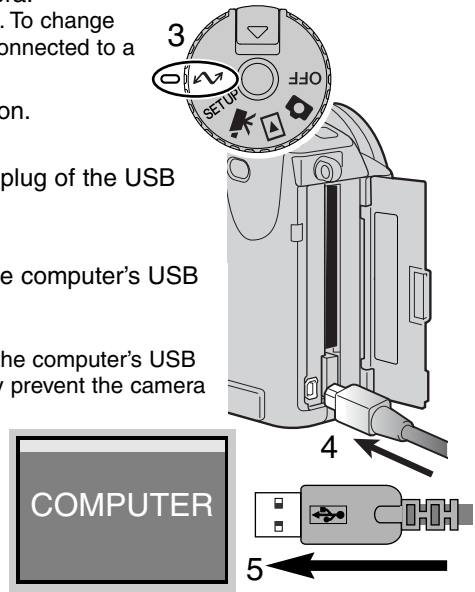

- 6 After using the four-way keys of the controller to highlight the USB option in the USB section of the data-transfer menu, press the the right key of the controller.
- “Enter” should appear on the right side of the screen.
- 7 Press the centre of the controller to send a signal to the computer to initiate the USB connection.
- A screen will appear to indicate the beginning of the connection process.
 - When the signal has been received by the computer, the camera’s monitors will turn off.

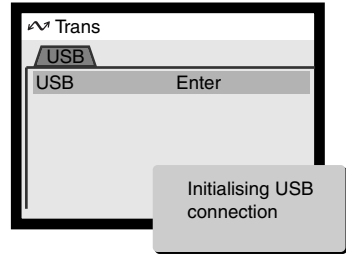

When the camera is properly connected to the computer, a drive icon will appear. If the computer does not recognise the camera, disconnect the camera and restart the computer. Repeat the connection procedure above.

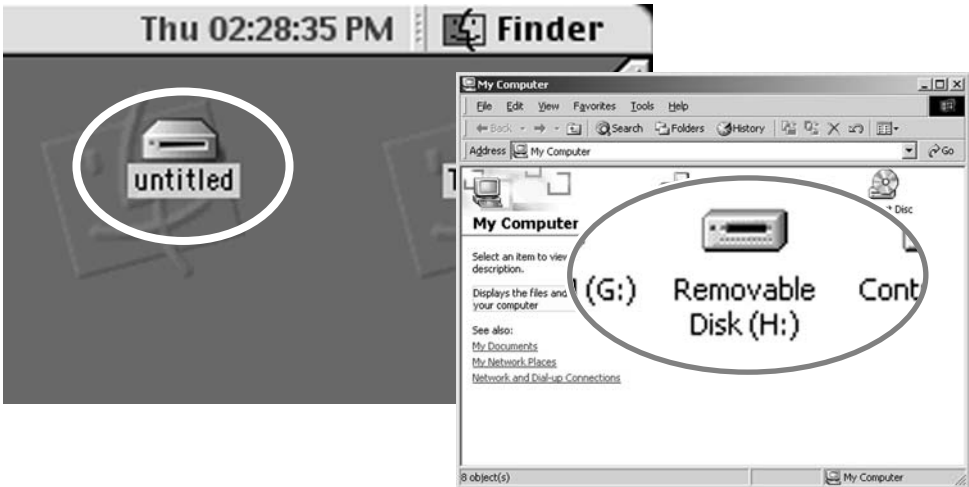

DATA-TRANSFER MODE

CONNECTING TO WINDOWS 98

The driver needs only to be installed once. If the driver cannot be installed automatically, it can be installed manually with the operating system's add-new-hardware wizard; see the instructions on the following page. During installation, if the operating system requests the Windows 98 CD-ROM, inset it into the CD-ROM drive and follow the accompanying instructions on the screen.

AUTOMATIC INSTALLATION



Before connecting the camera to the computer, place the DiMAGE software CD-ROM in the CD-ROM drive. The DiMAGE installer menu should automatically activate. To automatically install the Windows 98 USB driver, click on the starting-up-the-USB-device-driver-installer button. A window will appear to confirm that the driver should be installed; click "Yes" to continue.

When the driver has been successfully installed, a window will appear. Click "OK." The camera can now be attached to the computer (p. 124).



MANUAL INSTALLATION

To install the Windows 98 driver manually, follow the instruction in the connecting-the-camera-to-a-computer section on page 124.

When the camera is plugged into the computer, the operating system will detect the new device and the add-new-hardware-wizard window will open. Place the DiMAGE software CD-ROM in the CD-ROM drive. Click “Next.”



Choose the recommended search for a suitable driver. Click “Next.”



Choose to specify the location of the driver. The browse window can be used to indicate the location of the driver. When the driver location is shown in the window, click “Next.”

- The driver should be located in the CD-ROM drive at :\\Win98\\USB.



(Continued on the next page)

DATA-TRANSFER MODE



The add new hardware wizard will confirm the location of the driver. Click “Next” to install the driver in the system.

- One of three drivers may be located: MNLVENUM.inf, USBPDR.inf, or USBSTRG.inf
- The letter designating the CD-ROM drive will vary between computers.

The last window will confirm the driver has been installed. Click “Finish” to close the add new hardware wizard.

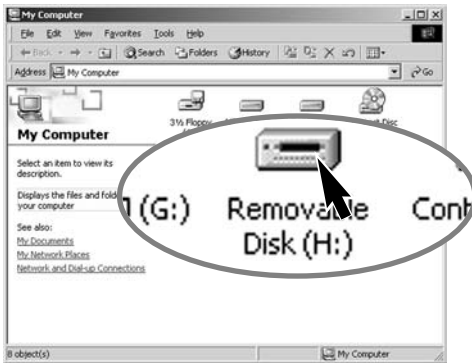

When the my-computer window is opened, a new removable-disk icon will be displayed. Double click on the icon to access the camera’s CompactFlash card, see page 130.

CONNECTING TO MAC OS 8.6

To access this camera with a computer with Mac OS 8.6, the USB storage support 1.3.5.smi must be installed first. This software is supplied by Apple Computer, Inc. free of charge. It can be downloaded from the Apple Software Updates web site at <http://www.apple.com/support>.



USB Storage Support 1.3.5.smi

To download and install this software, follow the instruction on the Apple web site. Always read the attached terms and conditions before installing any new software.

QUICKTIME 4.1 SYSTEM REQUIREMENTS

IBM PC / AT Compatible
Pentium-based computer
Windows 95, 98, NT 4.0, 2000.
16MB or more of RAM

QuickTime is used for viewing movie clips. To install QuickTime, follow the instructions in the read-me folder and in the installer. Users will Windows Me can use the system's media player to view movie clips. Macintosh users can download QuickTime 4.1 free of charge from the Apple Computer web site: <http://www.apple.com>.

Camera Notes

To view images correctly on your computer, the monitors colour space may need to be adjusted. Refer to your computer manual on how to calibrate the display to the following requirements: sRGB, with a colour temperature of 6500°K, and a gamma of 2.2.

DATA-TRANSFER MODE

COMPACTFLASH CARD FOLDER ORGANISATION



Drive Icon



Misc

The misc. folder contains DPOF print files (p. 108).



Dcim

Image-file names begins with "pict," followed by a four-digit file number, and a tif, jpg, avi, mrw, or thm extension. The thumbnail images (thm) are used in camera operation and cannot be opened.

The last two digits in the folder name indicate the camera that was used to capture the images; "03" indicates a DiMAGE 7 and "04" a DiMAGE 5.

Images copied from one CompactFlash card to another (p. 110) are placed in a folder with a name ending in "CP." The first three digits in the folder name will be one greater than the largest folder number.

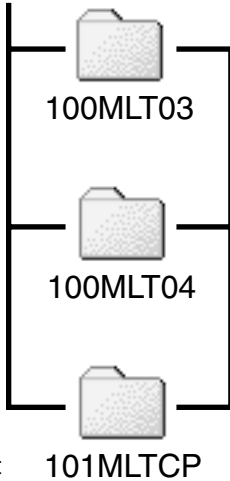

PICT0001.TIF



PICT0001.THM

Super-fine image



PICT0002.JPG

Fine, standard, or economy image

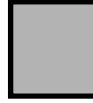

PICT0003.AVI



PICT0003.THM

Movie clip



PICT0004.MRW



PICT0004.THM

RAW image

Once the camera is connected to the computer, image files can be accessed by simply double clicking on icons. Copying images can be done by dragging and dropping the image-file icon into a location in the computer. Files and folders on the CompactFlash card can be deleted using the computer. Never format the CompactFlash card from the computer; always use the camera to format the card.

The index number on the image file may not correspond to the frame number of the image. As images are deleted on the camera, the frame counter will adjust itself to show the number of images in the folder and reassign the frame numbers accordingly. The index numbers on the image files will not change when an image is deleted. When a new image is recorded, it will be assigned a number one greater than the largest index number in the folder. File numbers can be controlled with the file-number-memory function in the Custom 1 section of the setup menu (p. 118).

When the index number in the image file name exceeds 9,999, a new folder will be created with a number one greater than the greatest folder number on the CompactFlash card: e.g. from 100MLTXX to 101MLTXX. The last two digits in the folder name indicates the camera with which the images were recorded. New folders can be created in the Custom 1 section of the setup menu (p. 119). When a DPOF file is created for a print order (p. 108), a misc. folder is automatically made for the file.

AUTO POWER SAVE (DATA-TRANSFER MODE)

If the camera does not receive a read or write command within ten minutes, it will shut down to save power. When the camera shuts down, an unsafe-removal-of-device warning may appear on the computer monitor. Click "OK." Neither the camera or computer will be damaged in this operation.

Pressing the shutter-release button will reactivate the camera. Remake the USB connection with the data-transfer menu (steps 6 and 7 on page 125).

DATA-TRANSFER MODE

DISCONNECTING THE CAMERA FROM THE COMPUTER

Never disconnect the camera when the access lamp is lit - the data or CompactFlash card may be permanently damaged.

WINDOWS 98

Confirm that the access lamp is not lit. Turn the mode dial to another position and then disconnect the USB cable.

WINDOWS ME AND WINDOWS 2000



To disconnect the camera, click once on the unplug-or-eject hardware icon located on the task bar. A small window will open indicating the device to be stopped.



Click on the small window to stop the device. The safe-to remove-hardware window will appear. Click "OK." Turn the mode dial to another position and then disconnect the USB cable.



When more then one external device is connected to the computer, the unplug-or-eject hardware window can be used. To disconnect the camera, double click on the unplug-or-eject hardware icon located on the task bar to activate the window.



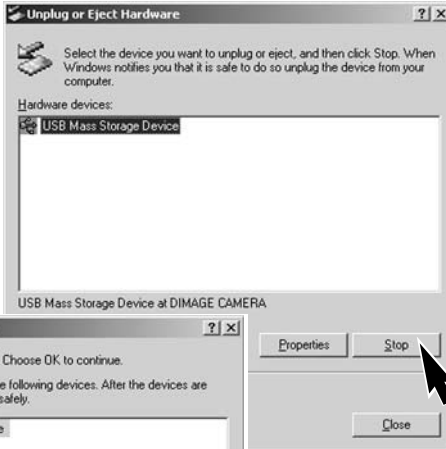

The hardware devices to be stopped will be displayed. Highlight the device by clicking on it then click “Stop.”



A confirmation screen will appear to indicate the devices to be stopped. Clicking “OK” will stop the device.

A third and final screen will appear to indicate the camera can be safely disconnected from the computer. Turn the mode dial to another position and then disconnect the USB cable.

MACINTOSH

Confirm that the access lamp is not lit and then drag the mass-storage device icon and drop it into the trash.

Disconnect the USB cable.

- If the USB cable is disconnected before performing step 1, an alert message will appear. Always complete step 1 before disconnecting the USB cable.

DATA-TRANSFER MODE

CHANGING THE COMPACTFLASH CARD (DATA-TRANSFER MODE)

Care should be taken when changing CompactFlash cards while the camera is attached to the computer. Data could be lost or damaged if the camera is not properly disconnected.

Always confirm the access lamp is out
before removing the CompactFlash card.

WINDOWS 98

1. Turn off the camera.
2. Change the CompactFlash card.
3. Turn on the camera.
4. Use the data-transfer menu to remake the USB connection.

WINDOWS ME AND 2000

1. Stop the USB connection using the unplug-or-eject-hardware routine (p. 132).
2. Turn off the camera.
3. Change the CompactFlash card.
4. Turn on the camera.
5. Use the data-transfer menu to remake the USB connection.

MACINTOSH

1. Stop the USB connection by dragging the drive icon into the trash (p. 133).
2. Turn off the camera.
3. Change the CompactFlash card.
4. Turn on the camera.
5. Use the data-transfer menu to remake the USB connection.

APPENDIX

FOCAL LENGTH EQUIVALENTS

The Exif tag information of each image includes the actual focal-length setting of the camera's 7.2 - 50.8mm zoom lens. The following chart can be used to estimate the equivalent focal length in 35mm photography.

Actual focal length	7.2	9	13	21	27	34	38	50.8
35mm equivalent (DiIMAGE 7)	28	35	51	83	106	134	149	200
35mm equivalent (DiIMAGE 5)	35	44	64	103	133	167	187	250

A SHORT GUIDE TO PHOTOGRAPHY

Photography can be a rewarding pursuit. It is a broad and disciplined field that can take years to master. But the pleasure in making photographs and the joy of capturing a magical moment cannot be compared. The guide is an introduction to some basic photographic principles.

The lens aperture controls not only exposure, but also depth of field; the area between the closest object in focus and the furthest object in focus. The larger the aperture value, the greater the depth of field and the longer the shutter speed needed to make the exposure. The smaller the aperture value, the shallower the depth of field and the faster the shutter speed needed to make the exposure. Usually landscape photographs use a large depth of field (large aperture value) to keep the foreground and background in focus, and portraits use a shallow depth of field (small aperture value) to separate the subject from the background.



Depth of field also changes with focal length. The smaller the focal length, the greater the depth of field; the longer the focal length, the shallower the depth of field.

The shutter controls not only exposure, but also the ability to stop motion. Fast shutter speeds are used in sport photography to stop action. Slow shutter speeds can be used to show the flow of motion such as water cascading over a waterfall. The use of a tripod is recommended with slow shutter speeds.



The change in aperture and shutter speed is not apparent in the live image. Unlike film cameras, test photographs can be taken and immediately viewed. For critical work, take a test photograph at the set aperture or shutter speed and view the result in quick view (p.34). The image can be deleted if not acceptable and another test image can be taken at a different setting.

SYSTEM ACCESSORIES

A variety of Minolta accessories can be used with this camera to extend its performance. For more details on the items listed below and in other sections of this manual, contact your local Minolta dealer.

External High-power Battery Pack Kit EBP-100

The kit contains a high-power lithium-ion battery, holder, and charger. The battery and charger are also available separately

Close-up Diffuser CD-1000

Used directly on the camera with the built-in flash to provide soft lighting for close-up photography.

Several high-quality Minolta flash units can be used with this camera:

Program Flash 3600HS(D)

Program Flash 5600HS(D)

Macro Ring Flash 1200 with Macro Flash Controller

Macro Twin Flash 2400 with Macro Flash Controller

Camera Notes

Minolta Program Flash 3600HS(D), Program Flash 5600HS(D), Macro Ring Flash 1200, and Macro Twin Flash 2400 are compatible with this camera. ADI flash metering (p. 75) will work with both program flashes attached to the accessory shoe. The use of other flash units is not recommended.

With the Program Flash units, the flash-metering mode will automatically switch to pre-flash TTL when the bounce-flash function is used, or the flashes are connected to the camera with an off-camera cable. Pre-flash TTL (p. 75) automatically activates when using the macro flash units.

When using the Program Flashes, if the flash illumination is uneven at the camera's wide-angle setting, attach the wide-angle adaptor to the flash units. With the 3600 HS(D), also change the flash metering mode to pre-flash TTL. When the auto-zoom function is used with the Program Flashes, the flashes zoom setting will be wider than the lens setting.

TROUBLESHOOTING

The section covers minor problems with basic camera operation. For major problems or damage, or if a problem continues to re-occur frequently, contact a Minolta service facility listed on the back cover of this manual.

Problem	Symptom	Cause	Solution
The camera will not work.	Nothing displayed on the data panel or the monitors.	The batteries are dead.	Replace batteries (p. 24).
		The batteries are inserted incorrectly.	Re-insert the batteries taking care that the negative and positive terminals are orientated as indicated on the inside of the battery chamber door (p.24).
		The AC adaptor is not connected properly.	Check that the adaptor is connected to the camera and a live electrical outlet (p. 26).
	"Err" displayed on the data panel	The camera is hot or it has been left in a very hot environment.	Turn off the camera and allow it to cool. If "Err" is still displayed on the camera after it cools, remove and replace the batteries or power cord.
Shutter will not release.	"000" is displayed on the frame counter.	CompactFlash card is full and unable to store an image at the image-quality or image-size setting on the camera.	Insert a new CompactFlash card (p. 26), delete some images (p. 102), or change the image-quality or image-size setting (p.40).

TROUBLESHOOTING

Problem	Symptom	Cause	Solution
Shutter will not release.	No-card warning appears on the monitors.	No CompactFlash card in the camera.	Insert a CompactFlash card (p.26).
Pictures are not sharp.	Focus signal is red.	Subject is too close.	Make sure the subject is within the autofocus range (0.5m - ∞) or use the macro mode (p. 69).
		The camera is in macro mode.	Cancel the macro mode setting (p. 69).
		A special situation is preventing the autofocus system from focusing (p.31)	Use the focus-lock function to focus on an object at the same distance as the subject (p. 30) or use manual focus (p. 71).
	Pictures are taken indoors or in low-light situations without flash.	Slow shutter speeds result in blurred images when the camera is hand-held.	Use a tripod, change the camera sensitivity to a higher setting (p. 61), or use the flash (p. 21).
Continuous drive does not work.	The built-in flash is up or image quality is set to super fine or RAW.		Push the flash down or change the image-quality setting (p. 43).
While using flash, the pictures are too dark.		The subject is beyond the flash range (p. 79).	Move closer to the subject or change the camera sensitivity to a higher setting (p. 61).

Problem	Symptom	Cause	Solution
A shadow appears on the bottom of the image.	Lens hood mounted when using flash.	The lens hood blocks the light from the built-in flash.	Always remove the lens hood when using the built-in flash.
Shooting data is displayed, but live image is entirely black or white.	Camera set to manual-exposure mode (M).	Shutter speed and aperture combination is extremely under or over-exposing the live image.	Change the shutter speed or aperture value until an image appears on the monitor (p. 50).
Live image turns black and white.	Camera used under low-light conditions.	Automatic monitor amplification activates under low-light conditions (p. 72). Although the live image is black and white, the recorded image will be colour.	

If the camera does not function normally, turn it off, remove and re-insert the batteries, or unplug and re-connect the AC adaptor. Always turn the camera off using the mode dial otherwise the CompactFlash card may be damaged and camera settings reset.

The camera temperature rises with extended periods of use. Care should be taken to avoid burns when handling the camera, batteries, or CompactFlash card.

WHEN USING FILTERS WITH THE DIMAGE 7

Polarising filters and close-up lenses may cause vignetting at the wide-angle range of the lens (below the 50mm mark on the zooming ring). With very powerful close-up lenses, such as a +3 or Minolta No. 2, vignetting may be noticeable below 100mm. Using step-up rings will cause vignetting; use only 49mm filters.

CARE AND STORAGE

CAMERA CARE

- Do not subject the camera to shock or impact.
- Turn off the camera when transporting.
- This camera is neither waterproof nor splashproof. Inserting or removing batteries or the CompactFlash card, or operating the camera with wet hands may damage the camera.
- When at the beach or near water, take care not to expose the camera to water or sand. Water, sand, dust, or salt can damage the camera.
- Do not leave the camera under direct sunlight. Do not point the lens directly at the sun; the CCD may be damaged.

CLEANING

- If the camera or the outside of the lens is dirty, gently wipe it with a soft, clean, dry cloth. If the camera or lens comes in contact with sand, gently blow away loose particles. Wiping may scratch the surface.
- To clean the lens surface, first blow away any dust or sand, then, if necessary, moisten a lens tissue or soft cloth with lens cleaning fluid and gently wipe the lens.
- Never use organic solvents to clean the camera.
- Never touch the lens surface with your fingers.

STORAGE

- Store in a cool, dry, well-ventilated area away from dust and chemicals. For long periods of disuse, store the camera in an airtight container with a silica-gel drying agent.
- Remove the batteries and CompactFlash card from the camera when not in use for extended periods.
- Do not store the camera in an area with naphthalene or mothballs.
- During long periods of storage, operate the camera occasionally. When taking the camera out of storage, check that the camera is functioning properly before using.

OPERATING TEMPERATURES AND CONDITIONS

- This camera has been designed for use in temperatures from 0°C to 40°C (32°F to 104°F).
- Never leave the camera exposed to extreme high temperatures, such as in a car parked in the sun, or to extreme humidity.
- When taking the camera from a cold to a warm environment, place it in a sealed plastic bag to prevent condensation from forming. Allow the camera to come to room temperature before removing it from the bag.

RECORDING MEDIA CARE AND HANDLING

- Read and follow the instruction manual supplied with the CompactFlash card.
- The following may cause data loss or damage.
 - 1 Improper use of the card.
 - 2 Static electrical discharge or electromagnetic fields near the card.
 - 3 Removing the card or interrupting the power supply while the camera or computer is accessing the card (reading, writing, formatting, etc.).
 - 4 The disuse of a card for an extended period.
 - 5 Using the card beyond its life

Minolta has no responsibility for any loss or damage to data. It is recommend that a copy of the card data be made in another media such as a ZIP disc, hard disc, CD-ROM, etc.

- When the card is formatted, all recorded data will be deleted. Be sure to make a backup of any important data.
- The storage capability of the CompactFlash card will diminish with extended use. It may be necessary to purchase a new card periodically.
- Keep away from static electricity and electromagnetic fields.
- Do not bend, drop, or subject the card to impact.
- Strong static electrical discharges or physical shock may prevent the card from being able to transfer data.
- Do not touch the electrical contacts of the card with your fingers or metal objects.
- Keep away from heat, moisture, and direct sunlight.
- Keep away from small children.
- When using an IBM Microdrive, do not subject the camera to vibrations.

CARE AND STORAGE

BATTERIES

- Battery performance decreases with temperature. In cold environments, we recommend keeping spare batteries in a warm place, such as the inside of a coat. Batteries can recover their power when they warm up. As the performance of Ni-MH batteries is less effected by temperature, their use is recommended when shooting in cold environments.
- Remove the batteries when the camera is not in use for an extended period. Leaking battery fluid may damage the battery-chamber.
- Occasionally, when using alkaline batteries, the battery-condition indicator will give a false low-battery-power warning, even though there is enough power capacity. Continue to use the camera; the low-battery indicator will disappear.
- If batteries have been exhausted when used in the camera, do not reload them even if their change seems to recover over time. These batteries will interfere with normal camera operation.

LCD MONITOR CARE

- Although the LCD monitor is manufactured using high precision technology, there may occasionally be a lack of colour or bright points on the LCD monitor.
- Do not apply pressure to the surface of the LCD monitor; it may be permanently damaged.
- In a cold environment, the LCD monitor may become temporarily dark. When the camera warms up, the display will function normally.
- The LCD monitor may be slow to react in low temperatures or may turn dark in a hot environment. When the camera reaches normal operating temperature, the display will function normally.
- If fingerprints are on the LCD monitor surface, gently wipe with a soft, clean, dry cloth.

COPYRIGHT

- TV program, films, video tapes, photographs, and other materials may be copyrighted. Unauthorised recording or duplication of such material may be contrary to copyright laws. Taking pictures or images of performances, exhibitions, etc. is prohibited without approval and can infringe on copyright. Images protected by copyright can only be used under the provisions within the copyright laws.

BEFORE IMPORTANT EVENTS OR JOURNEYS

- Check the camera's operation; take test pictures and purchase spare batteries.
- Minolta has no responsibility for any damage or loss incurred by equipment malfunction.

QUESTIONS AND SERVICE

- If you have questions about your camera, contact your local camera dealer or write to the Minolta distributor in your area.
- Before shipping your camera for repair, please contact a Minolta Service Facility.

The following marks may be found on the product:



This mark certifies that this camera meets the requirements concerning interference causing equipment regulations in Japan.



This mark on your camera certifies that this camera meets the requirements of the EU (European Union) concerning interference causing equipment regulations. CE stands for Conformité Européenne (European Conformity).

Digital Camera: DiMAGE 7



Tested To Comply
With FCC Standards

FOR HOME OR OFFICE USE

This device complies with Part 15 of the FCC Rules. Operation is subject to the following two conditions: (1) This device may not cause harmful interference, and (2) this device must accept any interference received, including interference that may cause undesired operation. Tested by the Minolta Corporation
101 Williams Drive, Ramsey, New Jersey 07446, U.S.A.

This Class B digital apparatus complies with Canadian ICES-003.

Cet appareil numérique de la classe B est conforme à la norme NMB-003 du Canada.

Do not remove the ferrite cores from the cables.

TECHNICAL SPECIFICATIONS

CCD:	2/3-type interline primary-colour CCD with a total of 5.24 million pixels. (DiMAGE 7) 1/1.8-type interline primary-colour CCD with a total of 3.34 million pixels. (DiMAGE 5)
Number of effective pixels:	4.95 million (2568 X 1928) DiMAGE 7 3.17 million (2056 X 1544) DiMAGE 5
Camera sensitivity (ISO):	Auto and 100, 200, 400, and 800 ISO equivalents.
Aspect ratio:	4:3
Lens construction:	16 elements in 13 groups including two AD glass and two aspheric elements.
Maximum aperture:	f/2.8 (wide-angle position), f/3.5 (telephoto position)
Focal length:	7.2 - 50.8 mm (35mm equivalent: 28 - 200mm (DiMAGE 7), 35 - 250mm (DiMAGE 5))
Focusing range:	0.5 m - infinity (from the CCD) 0.25 - 0.6 m (from the CCD) macro mode
Filter diameter:	49 mm
Autofocusing system:	Video AF
Shutter:	CCD electronic shutter plus mechanical shutter
Built-in flash recycling time:	7s (approx)
Viewfinder LCD:	Ferroelectric 4.8 mm reflective liquid crystal microdisplay.
Monitor LCD:	46 mm TFT colour
Field of view:	Approximately 100%
A/D conversion:	12 bits
Recording media:	Type I and II CompactFlash cards, 170MB, 340MB, 512MB, and 1GB IBM Microdrives as of June, 2001.
File formats:	Exif 2.1 (JPEG, TIFF), motion JPEG (avi), and RAW. DCF 1.0 and DPOF compliant.
Print Image Matching:	Yes
Menu languages:	English, German, French, and Spanish

Video output:	NTSC and PAL
Batteries:	4 AA alkaline or Ni-MH batteries
Battery performance (recording):	Approx. number of recorded images: 200 frames Based on Minolta's standard test method: Ni-MH batteries, EVF on, LCD monitor off, flash used with 50% of the frames, no instant playback.
Battery performance (playback):	Approx. continuous playback time: 110 min. Based on Minolta's standard test method: Ni-MH bat- teries, LCD monitor on, EVF off.
External power source:	AC adaptor (AC-1L or AC-2L) High-power battery pack (EBP-100)
Dimensions:	116.5 (W) X 90.5 (H) X 112.5 (D) mm
Weight:	Approximately 505g (without batteries or CompactFlash card)
Operating temperature:	0° - 40°C
Operating humidity:	5 - 85% (non-condensing)

Specifications are based on the latest information available at the time of printing and are subject to change without notice.

Apple, the Apple logo, Macintosh, Power Macintosh, Mac OS, and the Mac OS logo are registered trademarks of Apple Computer Inc. Microsoft and Windows are registered trademarks of the Microsoft Corporation. The official name of Windows® is Microsoft Windows Operating System. Pentium is a registered trademark of the Intel Corporation. Adobe and PhotoDeluxe are registered trademarks of Adobe Systems Inc. Microdrive is a trademark of the International Business Machines Corporation. QuickTime is a trademark used under license. All other trademarks are the property of their respective owners.

NOTE ABOUT BATTERIES

NOTE ABOUT BATTERIES

Ni-MH batteries are recommended for digital cameras. Recording performance with 1,600mAh Ni-MH batteries is approximately 200 frames: based on Minolta's standard test method: EVF on, LCD monitor off, no instant playback, flash used with 50% of the frames.

Although alkaline batteries are supplied with this product, its performance will be limited; only use alkaline batteries for test photographs or when Ni-MH batteries, the Minolta external battery pack or AC adapter are not available. Fully recharge the Ni-MH batteries just before using the camera.

IBM Microdrives require more power than CompactFlash cards. Always use Ni-MH batteries with IBM Microdrives.

WHEN USING NI-MH BATTERIES:

- Clean both battery terminals with dry cloth to wipe off any dirt or residue. Because of the sophisticated computer system, the camera critically monitors power levels. If the battery terminals are dirty, the camera may give a false low-battery warning. If battery performance is unusually low, wipe the battery terminals with a clean, dry cloth.
- Ni-MH battery performance will decrease if the batteries are often recharged before they have been fully discharged. Completely exhaust the Ni-MH batteries using the camera before charging.





Printed in Germany

9224-2773-11 H-A106

© 2001 Minolta Co., Ltd. under the Berne Convention
and the Universal Copyright Convention.