



KONICA MINOLTA

DiMAGE A1



E INSTRUCTION MANUAL

COLOR MODE

The color mode controls whether a still image is color or black and white as well as the color space. The color mode is set in section 3 of the recording menu (p. 80). The live image on the monitors will reflect the selected color mode. For more on the color mode see page 102.

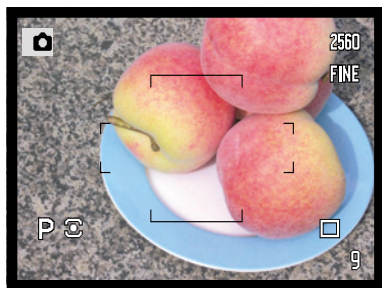

Natural Color and Adobe RGB - reproduces the colors in the scene faithfully.

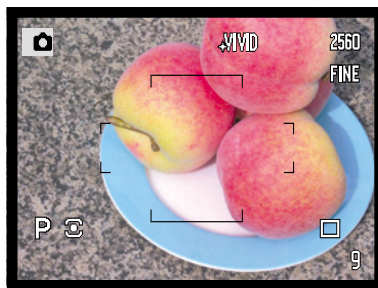

Vivid Color - increases the saturation of the colors in the scene.

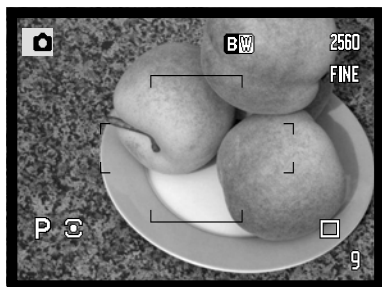

Black & White - produces monochrome images.

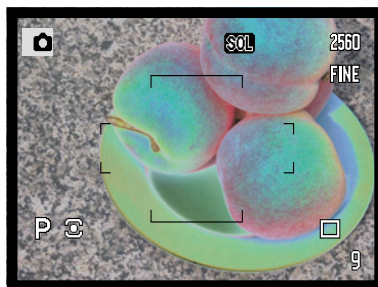

Solarization - produces a partial reversal of tones and colors in the image.

BEFORE YOU BEGIN

Thank you for purchasing this Minolta digital camera. Please take the time to read through this instruction manual so you can enjoy all the features of your new camera.

Check the packing list before using this product. If any items are missing, immediately contact your camera dealer.

Minolta DiMAGE digital camera	CompactFlash card
Lithium-ion battery NP-400	AV cable AVC-400
Lithium-ion battery charger BC-400	USB cable USB-500
Neck strap NS-DG4000	Ferrite Core FRC-100
Lens shade DLS-1	DiMAGE Viewer CD-ROM
Lens cap LF-1249	DiMAGE Viewer instruction manual
Accessory shoe cap SC-10	Camera instruction manual
	Warranty card

This product is designed to work with accessories manufactured and distributed by Minolta. Using accessories or equipment not endorsed by Minolta may result in unsatisfactory performance or damage to the product and its accessories.

Minolta, The essentials of imaging, and DiMAGE are trademarks or registered trademarks of Minolta Co., Ltd. Apple, Macintosh, and Mac OS are registered trademarks of Apple Computer Inc. Microsoft and Windows are registered trademarks of the Microsoft Corporation. The official name of Windows is Microsoft Windows Operating System. Pentium is a registered trademark of the Intel Corporation. Microdrive is a trademark of the International Business Machines Corporation. QuickTime is a trademark used under license. Adobe is a registered trademark of Adobe Systems Incorporated. All other brand and product names are trademarks or registered trademarks of their respective owners.

FOR PROPER AND SAFE USE

NP-400 LITHIUM-ION BATTERIES

This camera operates on a powerful lithium-ion battery. Misuse or abuse of the lithium-ion battery can cause damage or injury through fire, electric shock, or chemical leakage. Read and understand all warnings before using the battery.

DANGER

- Do not short, disassemble, damage, or modify the battery.
- Do not expose the battery to fire or high temperatures over 60°C (140°F).
- Do not expose the battery to water, or moisture. Water can corrode or damage the internal battery safety devices and cause the battery to overheat, ignite, rupture, or leak.
- Do not drop or subject the battery to strong impacts. Impacts can damage the internal battery safety devices and cause the battery to overheat, ignite, rupture, or leak.
- Do not store the battery near or in metallic products.
- Do not use the battery with any other products.
- Only use the specified charger. An inappropriate charger may cause damage or injury through fire or electric shock.
- Do not use a leaking battery. If fluid from the battery enters your eye, immediately rinse the eye with plenty of fresh water and contact a doctor. If fluid from the battery makes contact with your skin or clothing, wash the area thoroughly with water.
- Only use or charge the battery in an environment with ambient temperatures between 0° and 40°C (32° and 104°F). Only store the battery in an environment with ambient temperatures between -20° and 30°C (-4° and 86°F) and a humidity of 45% to 85% RH.

WARNING

- Tape over the lithium-ion battery contacts to avoid short-circuiting during disposal; always follow local regulations for battery disposal.
- If charging is not completed after the specified period elapses, unplug the charger and discontinue charging immediately.

GENERAL PRODUCT WARNINGS AND CAUTIONS

Read and understand the following warnings and cautions for safe use of the digital camera and its accessories.

WARNING

- Only use the battery specified in this manual.
- Only use the specified charger or AC adapter within the voltage range indicated on the unit. An inappropriate adapter or current may cause damage or injury through fire or electric shock.
- Only use the charger power cord in the sales region for which it was designed. An inappropriate current may cause damage or injury through fire or electric shock.
- Do not disassemble the camera or charger. Electric shock may cause injury if a high voltage circuit inside the product is touched.
- Immediately remove the battery or unplug the AC adapter and discontinue use if the camera is dropped or subjected to an impact in which the interior, especially the flash unit, is exposed. The flash has a high voltage circuit which may cause an electric shock resulting in injury. The continued use of a damaged product or part may cause injuries or fire.
- Keep the battery, memory card, or small parts that could be swallowed away from infants. Contact a doctor immediately if an object is swallowed.
- Store this product out of reach of children. Be careful when around children not to harm them with the product or parts.
- Do not fire the flash directly into the eyes. It may damage eyesight.
- Do not fire the flash at vehicle operators. It may cause a distraction or temporary blindness which may lead to an accident.
- Do not use the monitor while operating a vehicle or walking. It may result in injury or an accident.
- Do not use these products in a humid environment, or operate them with wet hands. If liquid enters these products, immediately remove the battery or unplug the product, and discontinue use. The continued use of a product exposed to liquids may cause damage or injury through fire or electric shock.

- Do not use these products near inflammable gases or liquids such as gasoline, benzine, or paint thinner. Do not use inflammable products such as alcohol, benzine, or paint thinner to clean these products. The use of inflammable cleaners and solvents may cause an explosion or fire.
- When unplugging the AC adapter or charger, do not pull on the power cord. Hold the plug when removing it from an outlet.
- Do not damage, twist, modify, heat, or place heavy objects on the AC adapter or charger cord. A damaged cord may cause damage or injury through fire or electric shock.
- If these products emits a strange odor, heat, or smoke, discontinue use. Immediately remove the battery taking care not to burn yourself as the battery may become hot with use. The continued use of a damaged product or part may cause injuries or fire.
- Take the product to a Minolta Service Facility when repairs are required.
- Handling the cord on this product may expose you to lead, a chemical known to the State of California to cause cancer, and birth defects or other reproductive harm. Wash hands after handling.

CAUTION

- Do not use or store these products in a hot or humid environment such as the glove compartment or trunk of a car. It may damage the camera, charger, and battery which may result in burns or injuries caused by heat, fire, explosion, or leaking battery fluid.
- If the battery is leaking, discontinue use of the product.
- The camera, charger, and battery temperature rises with extended periods of use. Care should be taken to avoid burns.
- Burns may result if the memory card or battery is removed immediately after extended periods of use. Turn the camera off and wait for it to cool.
- Do not fire the flash while it is in contact with people or objects. The flash unit discharges a large amount of energy which may cause burns.
- Do not apply pressure to the LCD monitor. A damaged monitor may cause injury, and the liquid from the monitor may cause inflammation. If liquid from the monitor makes contact with skin, wash the area with fresh water. If liquid from the monitor comes in contact with the eyes, immediately rinse the eyes with plenty of water and contact a doctor.
- When using the AC adapter and charger, insert the plug securely into the electrical outlet.
- The rim of the lens hood can cause injury. Take care not to accidentally strike anyone with the camera when the lens hood is attached.
- Do not use electronic transformers or travel adapters with the charger. The use of these devices may cause a fire or damage the product.
- Do not use if the AC adapter or charger cord is damaged.
- Do not cover the AC adapter or charger. A fire may result.
- Do not obstruct access to the AC adapter or charger; this can hinder the unplugging of the units in emergencies.
- Unplug the AC adapter or charger when cleaning or not in use.

TABLE OF CONTENTS

Names of parts	14
Camera body	14
Data panel	17
Monitor display - recording mode	18
Monitor display - Quick View & playback mode	19
Getting up and running	20
Attaching the camera strap	20
Removing the lens cap	20
Attaching the lens hood	21
Charging the battery	22
Installing and changing the battery	23
Battery condition indicator	24
Auto power save	24
External power supplies (sold separately)	25
Inserting and changing a memory card	26
Turning on the camera	28
Handling the camera	28
Adjusting the viewfinder and monitor	29
Diopter adjustment	29
Setting the date and time	30
Basic recording	32
Setting the camera to record images automatically	32
EVF and LCD monitor display	32
Basic recording operation	33
Focus lock	34
Automatic monitor amplification	34
Focus signals	35
Special focusing situations	35
Using the built-in flash	36
Flash range - automatic operation	36
Anti-shake system	37
Movie recording	38
Display mode switch	39
Basic playback	40
Single-frame playback and histogram display	40
Viewing images and histogram	41
Deleting single images	41
Changing the Quick View & playback display	42

Enlarged playback	43
Viewing movies	44
Advanced recording	45
Display-information button	45
Focus-mode switch	46
Digital zoom	47
Flex Focus Point	48
Macro mode	49
Exposure lock	50
Exposure-mode dial	50
Program - P	51
Program shift - PA/Ps	51
Auto recording	52
Aperture priority - A	54
Shutter priority - S	55
Manual exposure - M	56
Bulb exposures	57
Attaching a remote cord (sold separately)	57
Digital Subject Programs	58
Exposure and flash compensation	59
Using the function dial	60
Drive modes	61
Bracketing	62
Standard and high-speed continuous advance	64
Interval	66
Self-timer	68
Metering modes	69
White balance	70
Custom white balance calibration	71
Memory - storing camera settings	72
Memory recall	73
Camera sensitivity - ISO	74
Flash range and camera sensitivity	75
Attaching a Minolta accessory flash unit	75
Using the flash sync terminal	76
Digital Effects Control	77
Color-saturation compensation	77
Contrast compensation	78
Filter	78
Recording menu	80

Navigating the recording-mode menu	80
Image size and image quality	82
About RAW image quality	84
Notes on image size and resolution	85
Flash modes	86
Wireless/Remote flash	88
Wireless/Remote camera and flash ranges	90
Notes on wireless/remote flash	91
Flash control	92
AEL button	94
Recording-mode reset	95
Interval setup	96
Bracketing setup	96
Sharpness	97
Data imprinting	98
Electronic keyboard	99
Instant playback	100
Voice memo	101
Color mode	102
About Adobe RGB	103
Noise reduction	103
Monitor amplification	104
Magnification button	105
Flex Digital Magnifier	105
DSP (Digital Subject Program) setup	106
Tracking AF	106
AE lock	106
Spot AE area	107
Direct Manual Focus	107
A short guide to photography	108
About exposure and flash compensation	110
What is an Ev?	111
Light sources and color	111
Movie menu	112
Navigating the movie menu	112
Movie mode	113
Movie reset	113
Notes on movie recording	114
Advanced playback	115
Playing back voice memos	115

Navigating the playback menu	116
Frame-selection screen	118
Delete	119
Format	120
View folder.....	120
Lock	121
Index playback format	121
Copy	122
Slide Show.....	124
About DPOF	126
DPOF setup.....	126
Index print.....	127
Cancel print	127
Viewing images on a television	128
Setup menu	129
Opening the setup menu	129
Navigating the setup menu.....	130
LCD brightness.....	132
Shortcut help	132
Transfer mode	134
EVF auto switch.....	135
Video output	135
Language.....	135
Custom setup	136
File number memory.....	136
Folder name	137
Select folder.....	137
New folder	138
Date and time setup	138
Reset default	139
Audio signals	141
Focus signals.....	141
Shutter FX	142
Volume	142
Auto power save.....	142
Anti-shake.....	143
Full-time AF	143
Grip sensor	143
Control dial setup.....	144
Control dial setup - Manual exposure	145

Delete confirmation.....	145
Data-transfer mode	146
System requirements.....	146
Connecting the camera to a computer	147
Connecting to Windows 98 / 98 second edition	148
Automatic installation	148
Manual installation	149
QuickTime system requirements	151
Auto power save (Data-transfer mode)	151
Memory card folder organization	152
Disconnecting the camera from the computer	154
Windows 98 / 98 second edition.....	154
Windows Me, 2000 Professional, and XP	154
Macintosh.....	155
Changing the memory card (data-transfer mode).....	156
Removing the driver software - Windows.....	157
Troubleshooting.....	158
When using filters	160
About the lithium-ion battery charger cord	161
Attaching the ferrite core FRC-100.....	161
Care and storage	162
Camera care.....	162
Cleaning.....	162
Storage.....	162
Operating temperatures and conditions	163
Memory card care and handling.....	163
Batteries.....	164
LCD monitor care	164
Copyright	164
Before important events or journeys	165
Questions and service.....	165
Index	166
Technical specifications.....	168
Battery Pack BP-400.....	170

The following marks may be found on the product:



This mark on your camera certifies that this camera meets the requirements of the EU (European Union) concerning interference causing equipment regulations. CE stands for Conformité Européenne (European Conformity).

Digital Camera: DiIMAGE A1



Tested To Comply
With FCC Standards

FOR HOME OR OFFICE USE

This device complies with Part 15 of the FCC Rules. Operation is subject to the following two conditions: (1) This device may not cause harmful interference, and (2) this device must accept any interference received, including interference that may cause undesired operation. Changes or modifications not approved by the party responsible for compliance could void the user's authority to operate the equipment.

This equipment has been tested and found to comply with the limits for a Class B digital device, pursuant to Part 15 of the FCC Rules. These limits are designed to provide reasonable protection against harmful interference in a residential installation. This equipment generates, uses and can radiate radio frequency energy and, if not installed and used in accordance with the instructions, may cause harmful interference to radio communications. However, there is no guarantee that interference will not occur in a particular installation. If this equipment does cause harmful interference to radio or television reception, which can be determined by turning the equipment off and on, the user is encouraged to try to correct the interference by one or more of the following measures:

- Reorient or relocate the receiving antenna.
- Increase the separation between the equipment and the receiver.
- Connect the equipment to an outlet on a circuit different from that to which the receiver is connected.
- Consult the dealer or an experienced radio/TV technician for help.

Tested by the Minolta Corporation 101 Williams Drive, Ramsey, New Jersey 07446, U.S.A.
Do not remove the ferrite cores from the cables.

This Class B digital apparatus complies with Canadian ICES-003.

NAMES OF PARTS

CAMERA BODY

* This camera is a sophisticated optical instrument. Care should be taken to keep these surfaces clean. Please read the care and storage instructions in the back of this manual (p. 162).

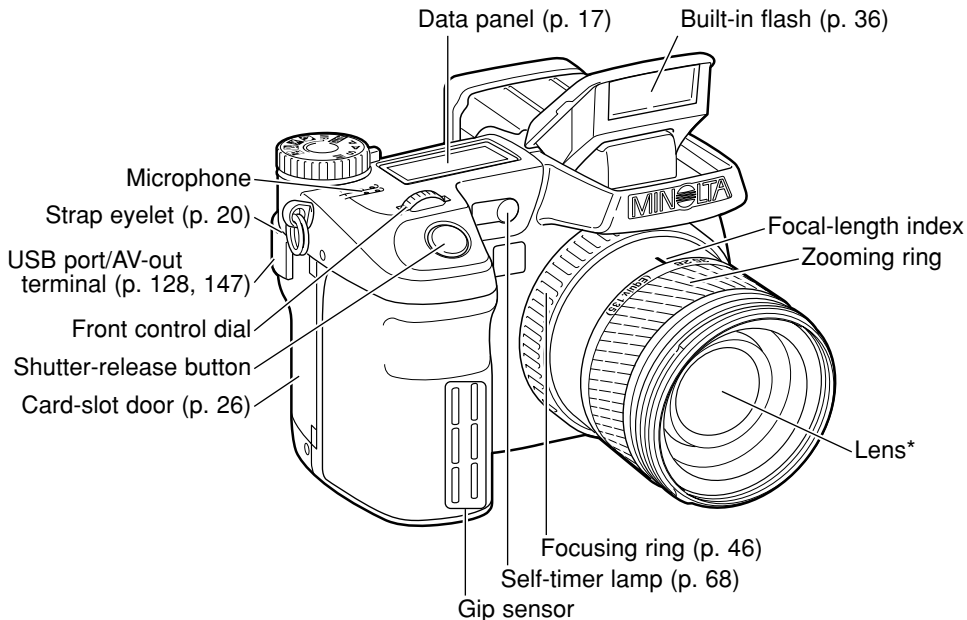

Camera Notes

The focal-length scale on the zooming ring is given in 35mm focal-length equivalents. The DiIMAGE Viewer software supplied with the camera can display the actual focal length used to capture the recorded image as well as the equivalent focal length in 35mm photography.

- Manual exposure (p. 56) **M**
- Shutter priority (p. 55) **S**
- Aperture priority (p. 54) **A**
- Program exposure (p. 51) **P**
- Auto recording (p. 52) **AUTO**

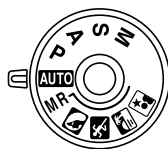

Exposure-mode dial

- MR** Memory recall (p. 73)
- Portrait subject program (p. 58)
- Sports action subject program (p. 58)
- Sunset subject program (p. 58)
- Night portrait subject program (p. 58)

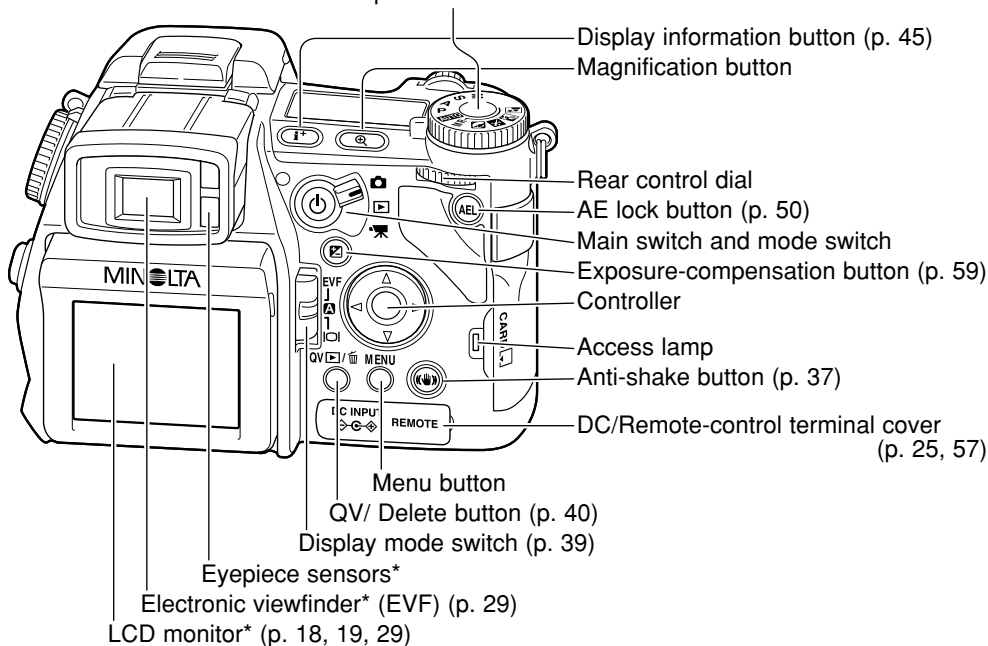

Function button

- Metering modes (p. 69) 
- Custom function (p. 136) **CUST**
- Memory set (p. 72) **MSET**

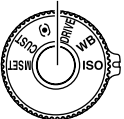

- DRIVE** Drive modes (p. 61)
- WB** White balance (p. 70)
- ISO** Camera sensitivity (p. 74)

Function dial (p. 60)

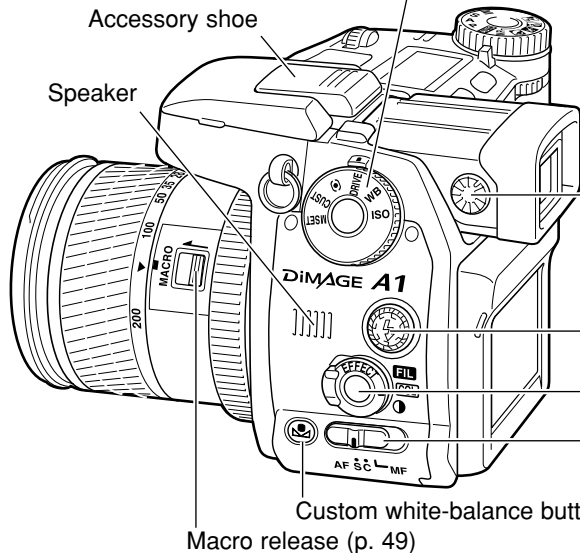

Accessory shoe

Speaker

Diopter-adjustment dial (p. 29)

Flash sync terminal (p. 76)

Digital-Effects Controller (p. 77)

Focus-mode switch (p. 46)

Custom white-balance button (p. 71)

Macro release (p. 49)

Battery-chamber (p. 23)

Battery-chamber lock (p. 23)

Tripod socket

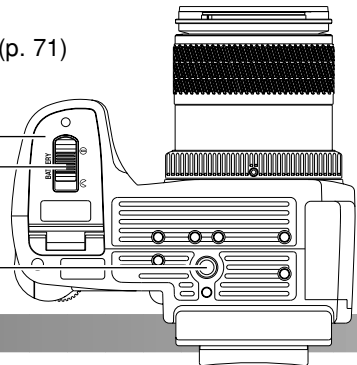

DATA PANEL

Located on the top of the camera body, the data panel shows the status of the camera. All icons have been shown for clarity. The single-frame advance and continuous advance indicators are displayed in the same area of the data panel.

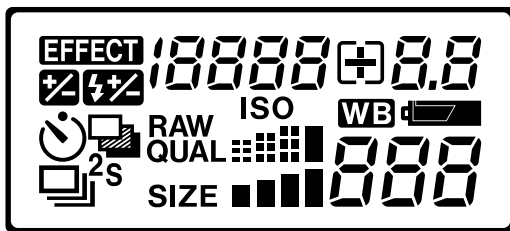

EFFECT Digital-effects indicator (p. 77)



Exposure-compensation indicator (p. 59)



Flash-compensation indicator (p. 59)



Single-frame advance (p. 33)



Continuous advance (p. 64)



Bracketing (p. 62)



Self-timer (p. 68)

RAW QUAL  Image-quality display (p. 82)

SIZE  Image-size display (p. 82)

ISO

Camera-sensitivity indicator (p. 74)

WB

White-balance indicator (p. 70)



Battery-condition indicator (p. 24)

18888  Shutter-speed and aperture display & exposure/flash compensation display

000

The frame counter cannot exceed 999. When the number of recordable images exceeds this, 999 will be displayed. The frame counter will continue to count down when the number of recordable images falls below one thousand.

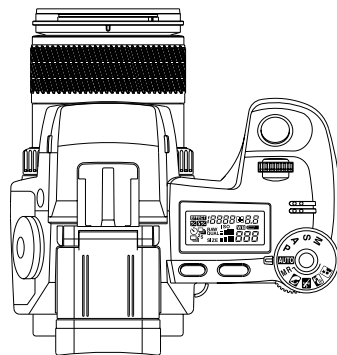

MONITOR DISPLAY - RECORDING MODE

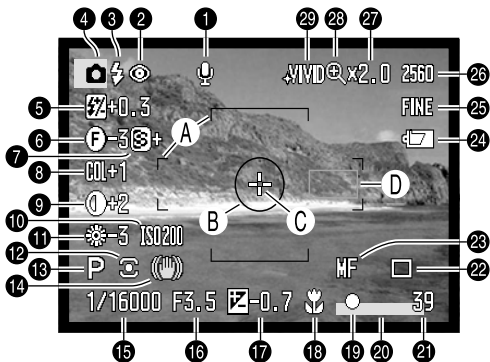

- | | |
|--|---|
| 1. Microphone indicator | 10. Camera-sensitivity (ISO) display (p. 74) |
| 2. Flash-mode indicator (p. 61) | 11. White-balance indicator (p. 70) |
| 3. Flash signal (p. 36) | 12. Metering-mode indicator (p. 69) |
| 4. Mode indicator | 13. Exposure-mode indicator (p. 50) |
| 5. Flash-compensation display (p. 77) | 14. Anti-shake indicator (p. 37) |
| 6. Filter display (p. 77) | 15. Shutter-speed display |
| 7. Sharpness display (p. 97) | 16. Aperture display |
| 8. Color-saturation-compensation display (p. 77) | 17. Exposure-compensation display (p. 59) |
| 9. Contrast-compensation display (p. 77) | 18. Macro-mode indicator (p. 49) |
| | 19. Focus signal (p. 35) |
| | 20. Data-imprinting indicator (p. 98) |
| | 21. Frame counter (p. 83) |
| | 22. Drive-mode indicator (p. 61) |
| | 23. Manual-focus indicator (p. 46) |
| | 24. Battery-condition indicator (p. 24) |
| | 25. Image-quality indicator (p. 82) |
| | 26. Image-size display (p. 82) |
| | 27. Digital-zoom display (p. 47) |
| | 28. Flex Digital Magnifier indicator (p. 105) |
| | 29. Color-mode indicator (p. 102) |

- A. Focus frame
- B. Spot metering area (p. 69)
- C. Flex Focus Point (p. 48)
- D. AF sensors

MONITOR DISPLAY - QUICK VIEW & PLAYBACK MODE

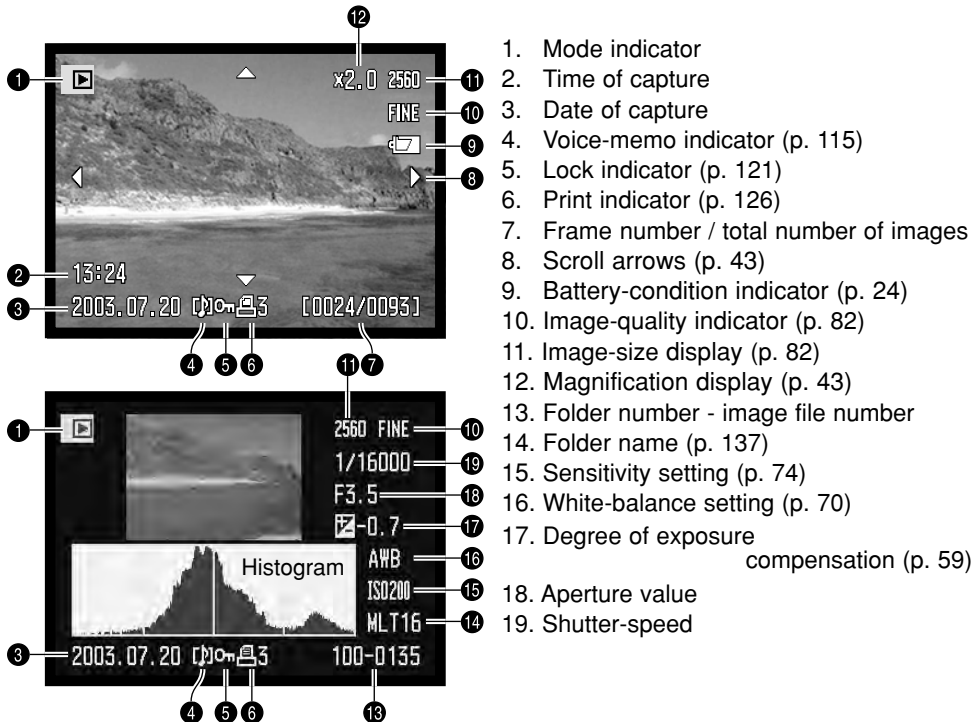

The dark area of the histogram shows the luminance distribution of the recorded image from black (left) to white (right). Each one of the 256 vertical lines indicates the relative proportion of that light value in the image. The histogram can be used to evaluate exposure and contrast, but displays no color information.

GETTING UP AND RUNNING

This section covers the preparation of the camera. This includes the changing of batteries and memory card as well as the use of external power supplies.

ATTACHING THE CAMERA STRAP

Attach the camera strap to the strap eyelets as shown. The tip of the strap should pass under the buckle (2).

Always keep the camera strap around your neck in the event that you drop the camera.

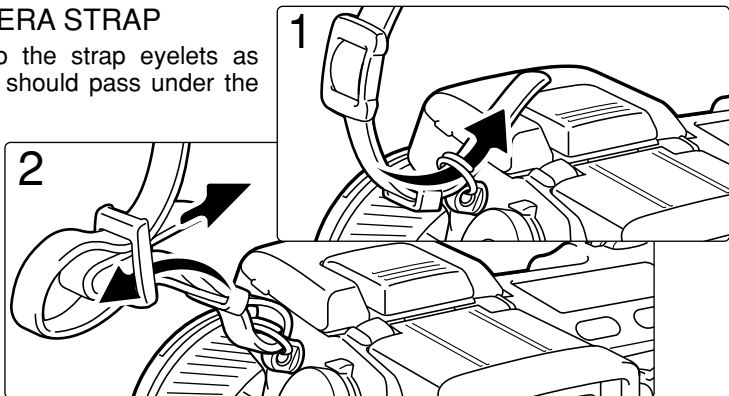

REMOVING THE LENS CAP

Using your thumb and index finger, pinch the inside or outside tabs of the lens cap to remove. When the camera is not in use, always replace the lens cap.

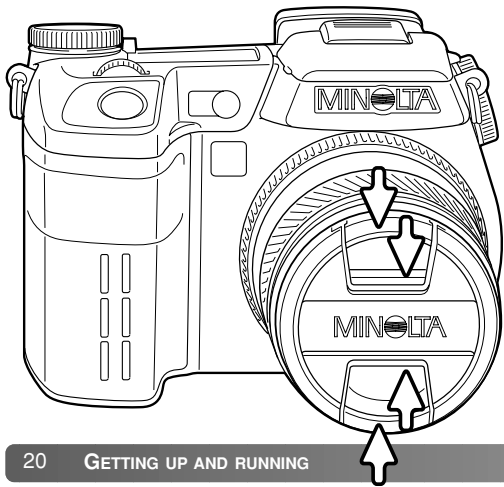

ATTACHING THE LENS HOOD

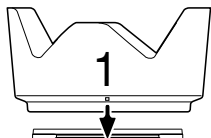

The lens hood is used to control stray light from entering the lens and causing flare. When using the camera under bright light, the use of the lens hood is recommended. The lens hood should not be used with the built-in flash as it can cause a shadow.

To mount the lens hood, align the rectangular dimple on the rim of the hood with the focal-length index on the top of the lens barrel (1).

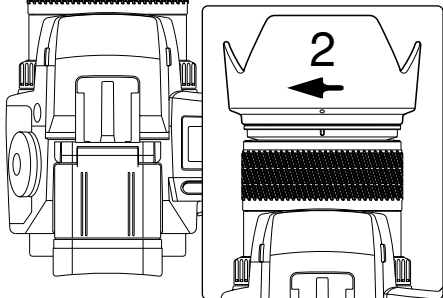

Slide the hood onto the end of the lens and turn it 90° clockwise until it clicks and the circular dimple is aligned with the focal-length index (2). When mounted correctly, the large petals of the lens hood should be to the top and bottom. Never force the lens hood. If it does not fit, check its orientation. To detach the lens hood, turn it 90° counterclockwise and remove.

The lens hood can be reverse mounted when the camera is not in use.

With one of the large petals to the top, slide the hood onto the end of the lens. Turn it 90° clockwise until it clicks into place.

The lens hood can be attached or removed with the lens cap on the camera. To detach the lens hood, turn it 90° counterclockwise and remove.

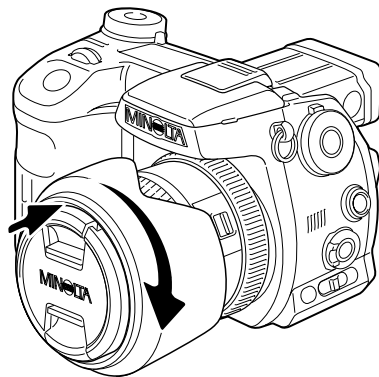

CHARGING THE BATTERY

Before the camera can be used, the lithium-ion battery must be charged. Before charging the battery, read the safety warnings on page 4 of this manual. Only recharge the battery with the supplied battery charger. The battery should be recharged before each shooting session. See page 164 for battery care and storage.

Plug the power cord into the back of the charger unit (1). Plug the other end of the cord into a live household outlet. The included AC cord is designed for the current of the sales region. Only use the cord in the region it was purchased. For more on the AC cable, see page 161.

With the battery contacts toward the charger, align the channels on the bottom of the battery with the tabs on the charger unit. Slide the battery into the unit.

The indicator lamp (2) will glow to show the battery is charging. The lamp will go out when the battery is charged. Charging time is approximately 150 minutes.

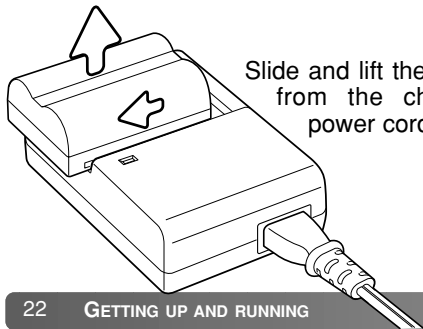

Slide and lift the battery to remove it from the charger. Unplug the power cord from the outlet.

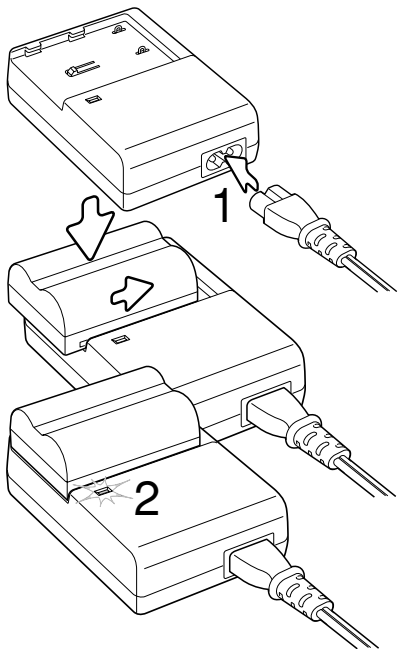

INSTALLING AND CHANGING THE BATTERY

This digital camera uses one NP-400 lithium-ion battery. Before using the battery, read the safety warnings on pages 4 of this manual. When replacing batteries, the camera should be off.

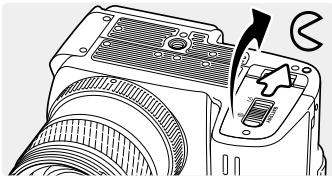

Open the battery-chamber door by sliding the battery-chamber lock to the open position.

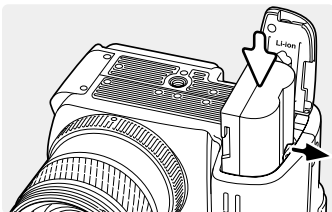

Insert the battery with the battery contacts first. Insert the battery so that it slides past the battery latch in the chamber. Push the battery into the chamber until the latch clicks into place.

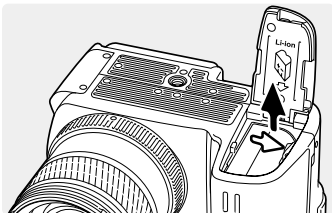

To remove a battery, slide the battery latch to the side of the battery chamber; the battery will spring out.

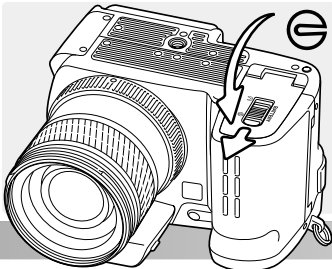

Close the battery-chamber door and slide the battery-chamber lock to the close position.

BATTERY CONDITION INDICATOR

This camera is equipped with an automatic battery-condition indicator. When the camera is on, the indicator appears on the data panel and monitors. The monitor indicator will change from white to red when battery power is low. If the data panel and monitors are blank, the battery may be exhausted.



Full-battery indicator - the batteries are fully charged. This indicator is displayed for five seconds on the monitors when the camera is turned on. The indicator remains on the data panel.



Low-battery warning - battery power is very low, but all functions are operational. The batteries should be replaced as soon as possible. This warning automatically appears and remains on the display until the batteries are changed.



Blinking low-battery warning - displayed on the data panel with no other icons. Power is insufficient for camera operation. The shutter will not release. Replace or recharge the batteries immediately.

AUTO POWER SAVE

To conserve battery power, the camera will turn off the monitors and unnecessary functions if an operation is not made within three minutes. The data panel remains on. To restore power, press the shutter-release button partway down or press the main switch. The length of the auto-power-save period can be changed in section 3 of the setup menu (p. 129).

If an operation is not made within thirty minutes, the camera will shut down. Press the main switch to restore power.

EXTERNAL POWER SUPPLIES (SOLD SEPARATELY)

The AC Adapter allows the camera to be powered from an electrical household outlet. The AC Adapter is recommended when the camera is interfaced with a computer or during periods of heavy use. AC Adapter model AC-1L is for use in North America, Japan, and Taiwan, and AC-11 is for use in all other areas.

The External High-power Battery Pack Kit EBP-100 is a portable power source and significantly extends the operating time of the camera. The kit contains a high-power lithium-ion battery, holder, and charger. The battery, holder, and charger are also available separately.

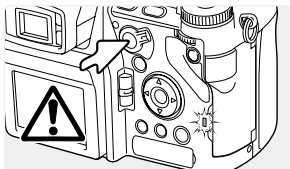

Always turn off the camera and confirm the access lamp is not lit before changing between power supplies.

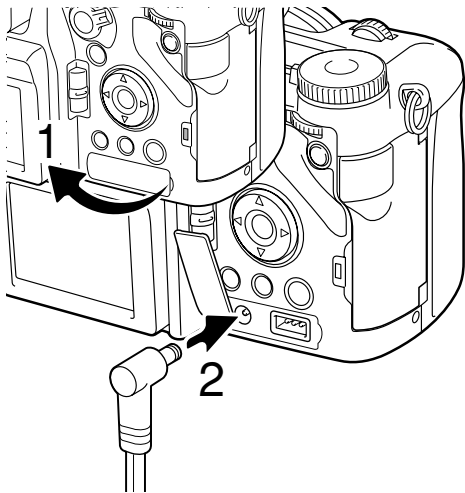

Remove the DC terminal cover from the right (1). The cover is attached to the body to prevent loss.

Insert the mini plug of the AC adapter or battery pack into the DC terminal (2).

Insert the AC adapter plug into an electrical outlet.

INSERTING AND CHANGING A MEMORY CARD

Always turn off the camera and confirm the access lamp is not lit before inserting or removing a memory card, otherwise the card may be damaged, and data lost.

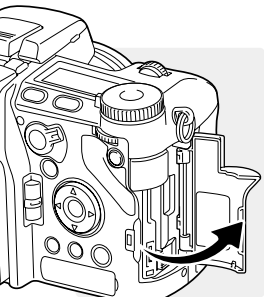

A memory card must be inserted for the camera to operate. If a card has not been inserted, a no-card warning will be displayed on the monitors. Type I and II CompactFlash cards and IBM Microdrives are compatible with this camera. For memory card care and handling, see page 163.

Open the card-slot door in the direction indicated.

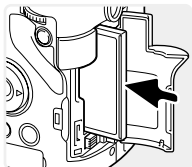

Insert a memory card all the way into the card slot. Insert the card so the face is toward the front of the camera. Always push the card in straight. Never force the card. If the card does not fit, check that it is oriented correctly.

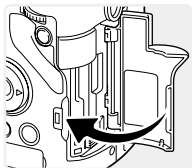

Close the card-slot door.

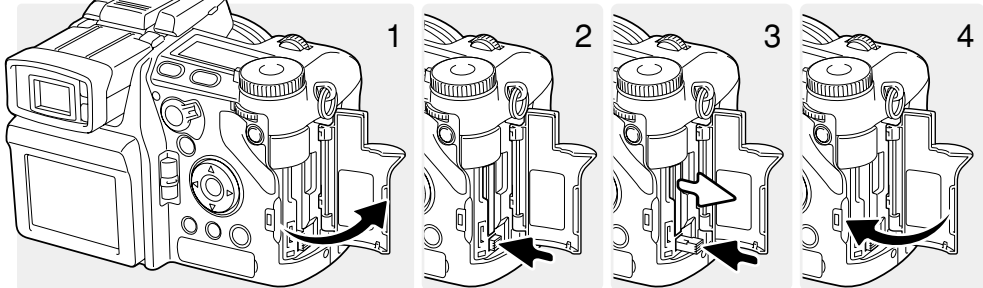

To eject a card, open the card-slot door (1), and press and release the card-eject lever to extend it (2).

Press (3) the card-eject lever to eject the card (3). The card can now be pulled out. Take care when removing the card as it becomes hot with use. The card-eject lever should remain inside the camera body. If it extends, push it into the camera.

Insert a new memory card and close the card-slot door (4).

A memory card used in another camera may have to be formatted before being used. If the unable-to-use-card message appears, the card should be formatted with the camera. A memory card can be formatted in section 1 of the playback menu (p. 120). When a card is formatted, all the data on the card is permanently erased. If the card-error message appears, press the central button of the controller to close the window; check the Minolta web site for the latest compatibility information:

North America: <http://www.minoltausa.com>

Europe: http://www.minoltaeurope.com/pe/digital/languages_stage.html

TURNING ON THE CAMERA

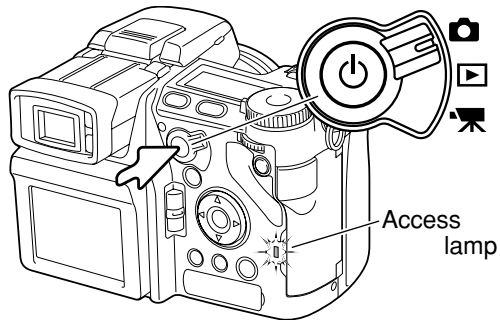

Press the main switch to turn on the camera. The access lamp glows briefly and an audio signal sounds to indicate the power is turned on. The audio signal can be turned off with the setup menu (p. 141).

If the camera shuts down immediately after it is turned on, the battery power is low. See page 22 on how to charge the battery.

Press and hold the main switch to turn the camera off.

HANDLING THE CAMERA

While using the electronic viewfinder (EVF) or LCD monitor, grip the camera firmly with your right hand while supporting the body with the palm of your left hand. Keep your elbows at your side and your feet shoulder-width apart to hold the camera steadily.



ADJUSTING THE VIEWFINDER AND MONITOR

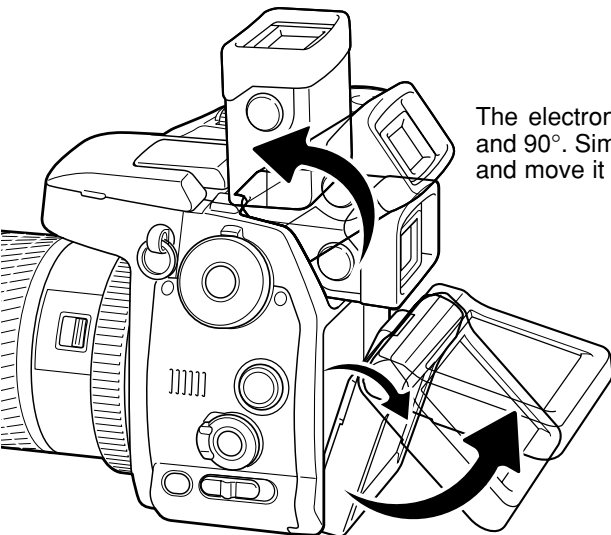

The electronic viewfinder can be tilted between 0° and 90° . Simply grip the finder between your fingers and move it to the position desired.

The LCD monitor can be tilted between -20° and $+90^{\circ}$. Grip the top of the monitor and pull to tilt it down. The bottom of the monitor can then be swung up.

Always store the camera with finder and monitor against the body.

DIOPTRER ADJUSTMENT

The EVF has a built-in diopter that can be adjusted between -5.0 to $+2.0$. While looking through the EVF, turn the diopter-adjustment dial until the viewfinder image is sharp.

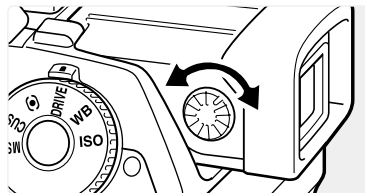

SETTING THE DATE AND TIME

After initially inserting a memory card and battery, the camera's clock and calendar must be set. When images are recorded, the image data is saved with the date and time of recording. Depending on the region, the menu language may also have to be set. To change the language, see the camera notes on the following page.



Turn on the camera.

While holding down the function button (1), press the menu button (2) to open the setup menu.

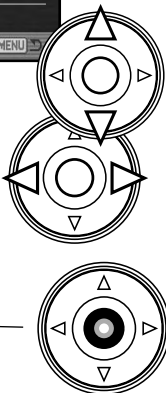
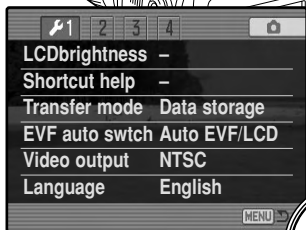

Navigating the menu is simple. The up/down and left/right keys of the controller move the cursor and change settings on the menu.

The central button of the controller selects menu options and sets adjustments.

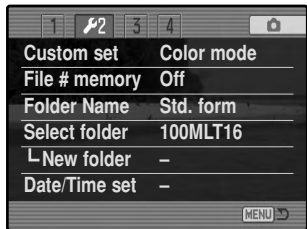

Use the right controller key to highlight the 2nd tab at the top of the menu.



Use the down key to highlight the date/time-set menu option.



Press the right key. "Enter" will appear on the right side of the menu.



Press the central button to display the date/time setting screen.

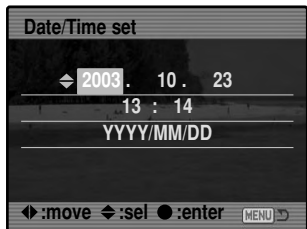

Date/Time setting screen



Use the left and right keys to select the item to be changed.



Use the up and down keys to adjust the item.



Press the central button to set the clock and calendar. The setup menu will be displayed.

Camera notes

For customers in certain areas, the menu language must also be set. Highlight the language option in section 1 of the setup menu. Press the right key to display the language settings. Using the up/down keys, highlight the desired language. Press the central button to set the highlighted language; the setup menu will be displayed in the selected language.

BASIC RECORDING

SETTING THE CAMERA TO RECORD IMAGES AUTOMATICALLY

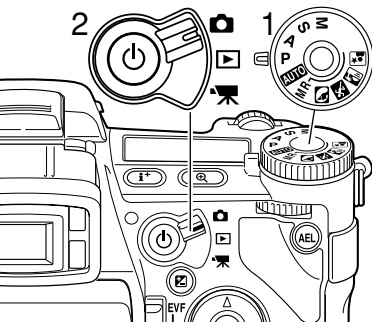

Set the exposure dial to the program (P) position (1). Confirm the mode switch is in the recording position (2).

All camera operations are now fully automatic. The autofocus, exposure, and imaging systems will work together to make photography effortless.

The Auto exposure mode acts like the program mode, except that the many of the recording functions are reset each time it is selected, see page 52 for more information.

EVF AND LCD MONITOR DISPLAY

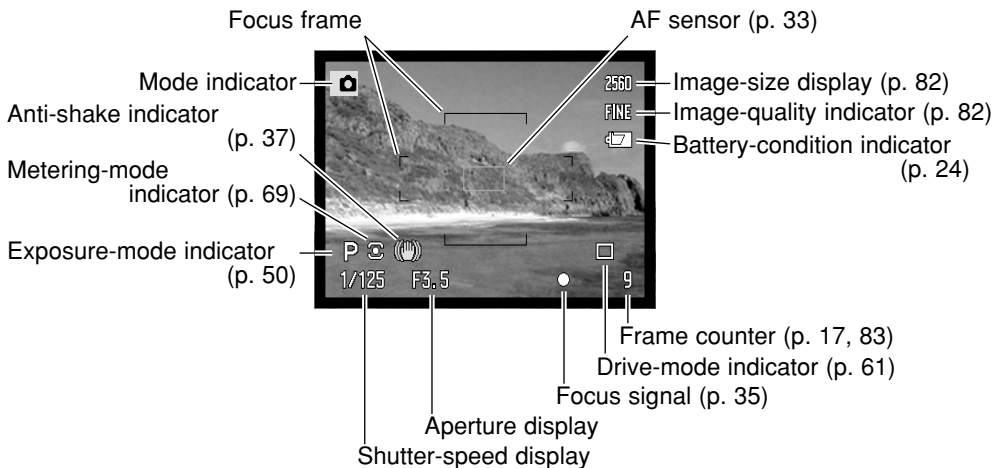

BASIC RECORDING OPERATION

Use the zooming ring to frame the subject (1). The effect of the zoom is immediately displayed in the viewfinder (EVF) and LCD monitor.

Place the subject within the focus frame. For off-center subjects, use the focus-lock function (p. 34).

The subject must be within the focus range of the lens: 0.5m (1.6ft) - ∞. For subjects closer than 0.5m (1.6ft), use the macro function (p. 49).

Press the shutter-release button partway down (2) to lock the focus and exposure.

When the focus is set, an AF sensor will briefly appear in the live image to indicate the point of focus. The focus signals (p. 35) on the monitors will confirm that the image is in focus. If the focus signal is red, the camera was unable to focus on the subject. Repeat the previous steps until the signal is white. The shutter speed and aperture value will change from white to black indicating the exposure is locked.

Press the shutter-release button all the way down (3) to take the picture.

The access lamp will glow indicating the image data is being written to the memory card. Never remove a card while data is being transferred.

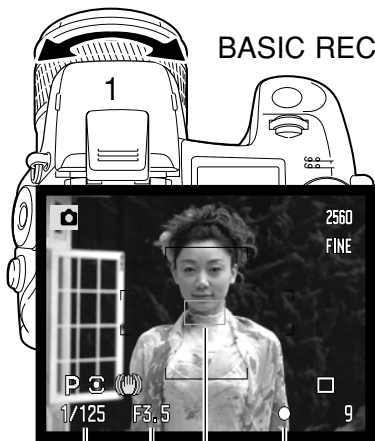

Focus signal
AF sensor
Shutter-speed and aperture

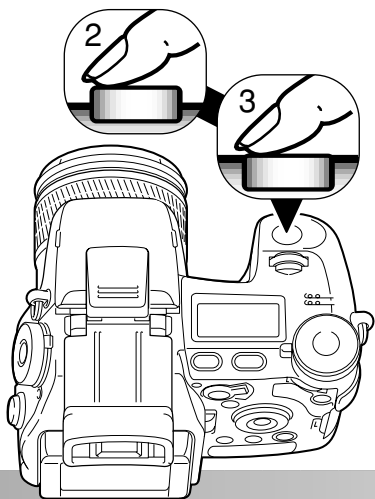

FOCUS LOCK

The focus-lock function is used when the subject is off-center and outside the focus frame. Focus lock may also be used when a special focusing situation prevents the camera from focusing on the subject.



Place the subject within the focus frame. Press and hold the shutter-release button partway down.

- The focus signals will indicate that the focus is locked. The shutter speed and aperture value will change from white to black indicating the exposure is locked.
- When the focus is set, an AF sensor will briefly appear on the live image to indicate the point of focus.



Without lifting your finger from the shutter-release button, recompose the subject within the image area. Press the shutter-release button all the way down to take the picture.

AUTOMATIC MONITOR AMPLIFICATION

In extremely low-light conditions when the camera-sensitivity gain has reached its limit, the automatic monitor-amplification function will intensify the EVF and LCD monitor image. The live image will be brighter, however, the display will be black and white. This will have no effect on the final color image. This function can be turned off in section 3 of the recording menu (p. 104).

FOCUS SIGNALS

This digital camera has a quick, accurate autofocus system. The focus signals in the lower right corner of the EVF and LCD monitor indicate the focus status. For more information on autofocus modes, see p. 46.



White focus indicator - focus confirmed.



Red focus indicator - the subject is too close or a special situation is preventing the AF system from focusing. The shutter can be released.

If the AF system cannot focus on a certain subject, focus lock can be used with an object at the same distance as the main subject or the camera can be focused manually (p. 34).

SPECIAL FOCUSING SITUATIONS

The camera may not be able to focus in certain situations. If the autofocus system cannot focus on a subject, the focus icon will turn red. In this situation the focus-lock function can be used to focus on another object at the same distance as your main subject, and then the image can be recomposed to take the picture.

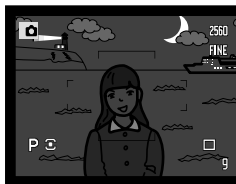

The subject is too dark.

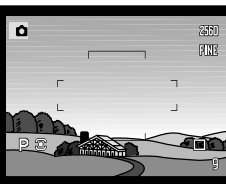

The subject in the focus frame is low in contrast.



Two subjects at different distances overlap in the focus frame.





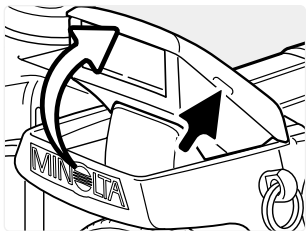

The subject is near a very bright object or area.

USING THE BUILT-IN FLASH

In low-light conditions or indoors, the flash is needed to illuminate the subject and reduce blurring through camera shake. The flash can also be used as a fill light in direct sunlight to soften harsh shadows. Always remove the lens hood when using the built-in flash; the hood may cast a shadow if mounted.



To use the flash, simply pull up the unit by the tabs on each side. The flash position must be set manually, and once up, the flash unit will always fire regardless of the amount of ambient light. The following indicators will appear in the upper left corner of the EVF and LCD monitors to show the flash status.

-  When pressing the shutter-release button partway down, the red flash indicator appears when the flash is charging.
-  When pressing the shutter-release button partway down, the white flash indicator appears when the flash is ready to fire.
-  After taking a picture, the OK indicator appears briefly if the flash properly exposed the subject.
-  Flash warning. In backlit situations, a yellow indicator appears to recommend the use of the flash.

FLASH RANGE - AUTOMATIC OPERATION

The camera will automatically control the flash output. For well-exposed images, the subject must be within the flash range. Because of the optical system, the flash range is not the same at the lens' wide-angle position as it is at the telephoto position.

Wide-angle position

0.5m ~ 3.8m (1.6 ft. ~ 12.5 ft.)

Telephoto position

0.5m ~ 3.0m (1.6 ft. ~ 9.8 ft.)

ANTI-SHAKE SYSTEM

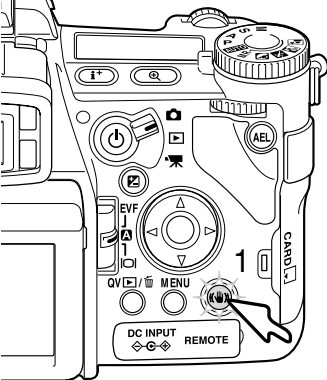

The Anti-shake system minimizes the affect of camera shake, a slight blurring caused by subtle hand motion. Camera shake is more pronounced at the telephoto setting than at the wide-angle. Anti-shake is employed when the shutter speed falls below a certain limit depending on the focal length in use. The effectiveness of Anti-shake depends on the shutter speed in use and the degree of shaking. The system may not work with moving subjects or when the camera is panned.

When the system is active, the Anti-shake button glows (1). Anti-shake can be turned off and on by pressing the button.

Frame the subject as described in the basic operation section. Press the shutter-release button partway down to focus and set the exposure; an Anti-shake indicator is displayed when active. Confirm the image has stabilized on the monitor and press the shutter-release button all the way down to take the picture.



The blue indicator appears when the Anti-shake system is activated.



The yellow indicator appears when the Anti-shake system is activated, but the shutter speed is too slow for it to be effective.



When Anti-shake is off, the white indicator appears to warn the shutter speed is too long for the camera to be safely handheld.

If the yellow or white warnings appears, place the camera on a tripod, use the built-in flash, increase the camera sensitivity (ISO) (p. 74), or use a wide-angle zoom position. If the Anti-shake indicator turns red, the camera is overheating because of operating and ambient temperatures. The Anti-shake system will turn off automatically. Allow the camera to cool before using Anti-shake.

The Anti-shake system is less effective at short subject distances or when using the macro function (p. 49). The use of a tripod is recommended. Anti-shake is not effective with a tripod mounted camera; turn off the Anti-shake function to conserve power.

MOVIE RECORDING

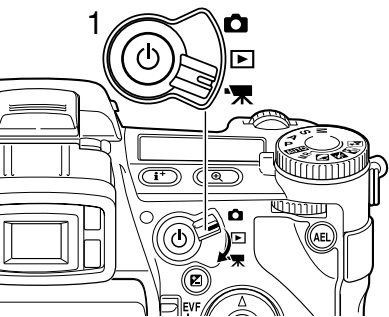

Movie files are recorded at approximately 522KB per second. A 16MB Compactflash card can store about 19 seconds of digital video with audio. Actual time depends on the subject and the amount of free space on the memory card. For more on movie recording, see page 112.

Set the mode switch to the movie recording (1) position. Before recording, the data-panel and monitor frame counters will show the maximum time in seconds that can be recorded.



Shooting digital video is simple. Place the subject in the center of the live image and press the shutter-release button partway down to set the focus. Use the focus signal to confirm focus.

Focus signal

Total recording time for the next movie clip.



Press the shutter-release button all the way down and release to start recording. The camera will continue to record until the recording time is used or the shutter-release button is pressed again. When recording, the monitor frame counter and status bar shows the recorded time.

Recording time in seconds
Recording indicator

DISPLAY MODE SWITCH

Located on the back of the camera, the display-mode switch controls which monitor is active. The three position switch allows the choice between automatic display and setting the display to the EVF or LCD monitor.

Auto display - the camera will automatically change between displaying the live image in the EVF or on the LCD monitor. The EVF's eye sensors monitor if the EVF is being used and switches the display location accordingly.

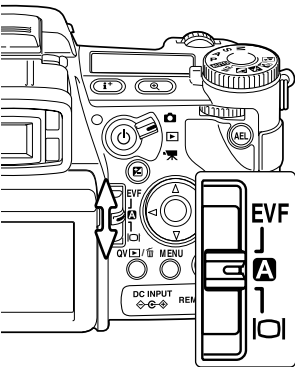

EVF display - the live image will only be displayed in the electronic viewfinder. Under bright light, the image is easier to see in the EVF than on the LCD monitor.

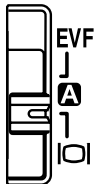

LCD monitor display - the live image will only be displayed on the LCD monitor.

If battery power is a concern, have the grip and eye sensors activate the EVF when in use, but not the LCD monitor. The auto-display function can be changed in section 1 of the setup menu (p. 135).

BASIC PLAYBACK

Images can be viewed in the Quick View or playback modes. This section covers the basic functions in both modes. The playback mode has additional menu functions, see page 116.

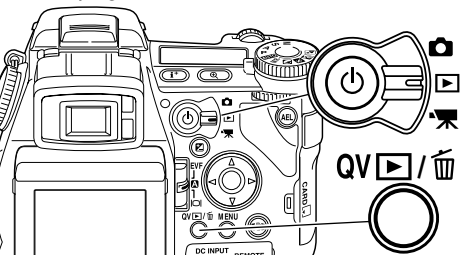

To view images from the playback mode, turn the mode switch to the playback position.

To view images from the recording or movie recording modes, press the Quick View / delete button.

SINGLE-FRAME PLAYBACK AND HISTOGRAM DISPLAY

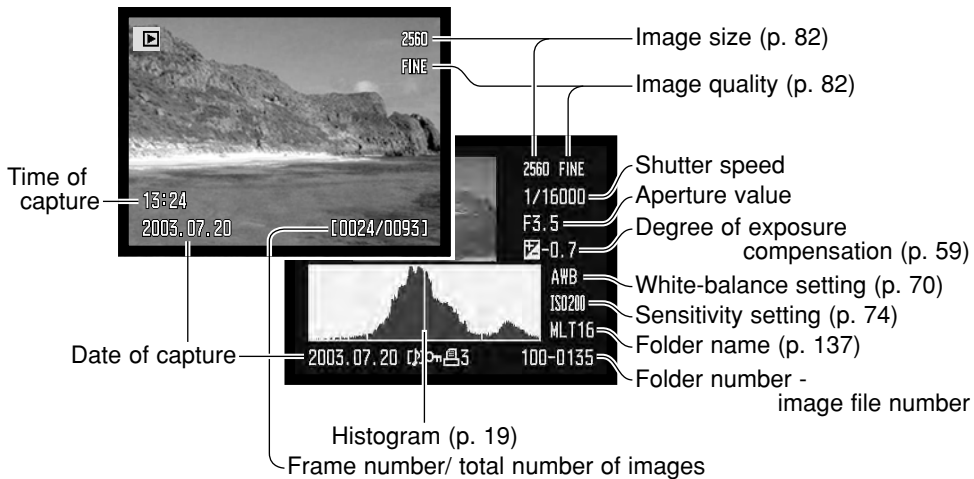

VIEWING IMAGES AND HISTOGRAM

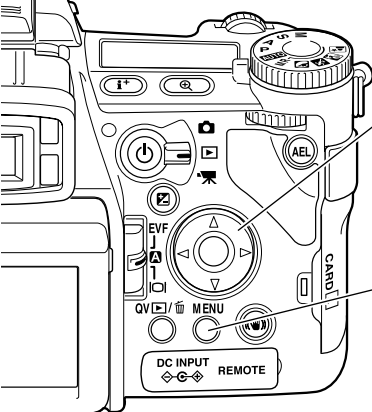

When in the Quick view or playback mode, use the left/right keys of the controller to scroll through the images on the memory card.



To view the histogram of a still image, press the up key. Press the down key to return to single-frame playback.

To return to a recording mode from Quick View, press the menu button.

DELETING SINGLE IMAGES

The displayed image can be deleted. Once deleted, an image cannot be recovered.



To delete a displayed image, press the QV/delete button; a confirmation screen will appear.



Use the left/right keys to highlight "Yes." "No" will cancel the operation.



Press the controller to execute the command on the confirmation screen. The camera will return to playback mode.



Confirmation screen

CHANGING THE QUICK VIEW & PLAYBACK DISPLAY

The display-information button controls the display format. Each time the button is pressed, the display cycles through to the next format: full display, image only, index playback.

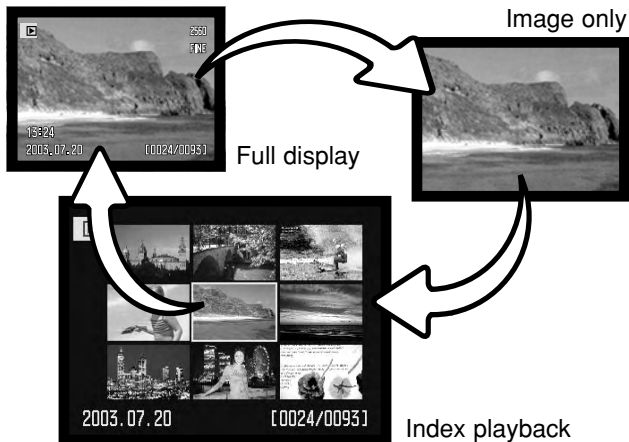
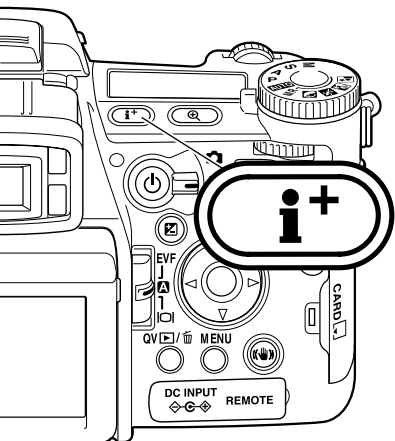

In index playback, the four-way keys of the controller will move the yellow border to the adjacent image. When the image is highlighted with the border, the date of recording, voice-memo indicator, the lock and printing status, and the frame number of the image are displayed at the bottom of the screen. The highlighted image can be deleted using the QV/delete button (p. 41) or an accompanying audio track can be played by pressing the central button of the controller. When the display information button is pressed again, the highlighted image will be displayed in the single-frame playback mode. A nine or four image index can be displayed. The index-playback format can be changed in section 1 of the playback menu (p. 121).

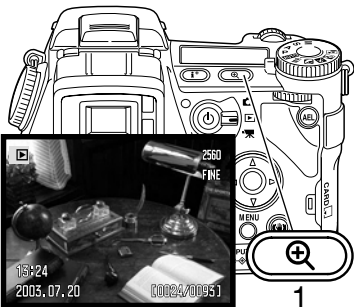

ENLARGED PLAYBACK

In single-frame playback, a still image can be enlarged for closer examination from 1.2X. The degree of maximum magnification depends on image size: 8X for 2560X1920, 6.4X for 2080X1560, 5X for 1600X1200, 2X for 640X480, and 4X for 1280X960 digital-zoom images. RAW and TIFF images cannot be enlarged.

With the image to be enlarged displayed, press the magnification button (1).



Use the up/down keys of the controller to adjust the magnification. The degree of magnification is displayed on the monitors.

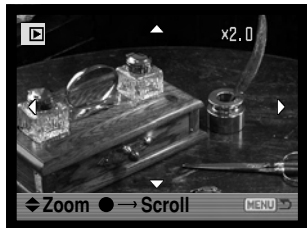

Press the central button of the controller to switch between the zoom and scroll functions. The scroll arrows or magnification display will turn blue to indicate the active function.

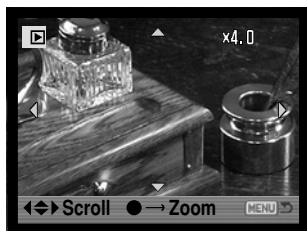
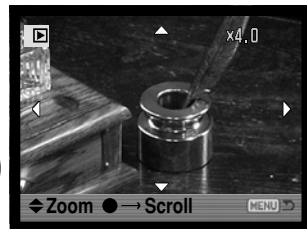

Use the four-way key to scroll the image. Press and hold the four-way key to scroll continuously. Press the menu or magnification button to exit the enlarged playback mode.

The guidance bar and display icons can be hidden or shown by pressing the display-information button (i+).

VIEWING MOVIES

Movies can be played back on the camera. Movie files are indicated by an indicator at the bottom of the display.



Press the center of the controller to play back the file.



Press the controller to pause the movie; pressing the controller again will resume the playback.



Use the left/right keys of the controller to rewind or fast forward the movie clip.



Use the up/down keys to adjust the volume of the audio track.

When the movie is paused, pressing the up/down keys will jump to the first or last frame of the movie clip.

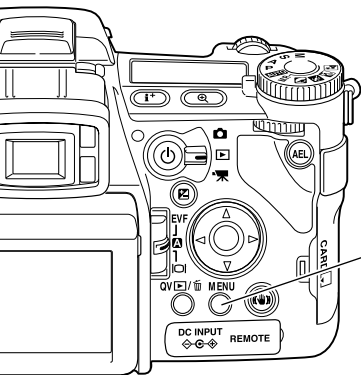

To cancel the playback, press the menu button.

ADVANCED RECORDING

This section contains detailed information on the camera's recording functions and operation. Read the sections pertaining to your interest and need.

DISPLAY-INFORMATION BUTTON

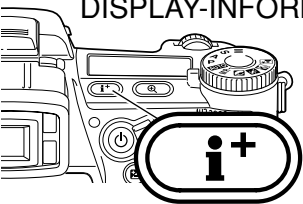

The display-information button controls what information is displayed with the live image. Each time the button is pressed, the display cycles to the next format: standard display, real-time histogram, focus frame only, and live image only.

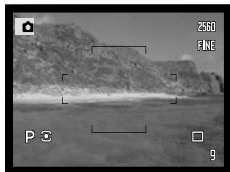

Standard display

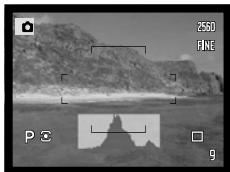

Real-time histogram

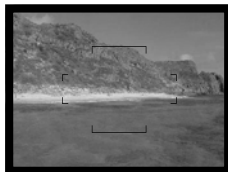

Focus frame only



Live image only

The real-time histogram shows the approximate luminance distribution of the live image. This histogram will not be accurate when the monitor image is amplified (p. 34, 104), or the built-in or a compatible Minolta flash unit is used. The histogram of a recorded image may not show the same distribution as the real-time histogram.

To display a grid or scale over the display formats, press and hold the function button (1) and press the display-information button to cycle through the options: grid, scale, and off.

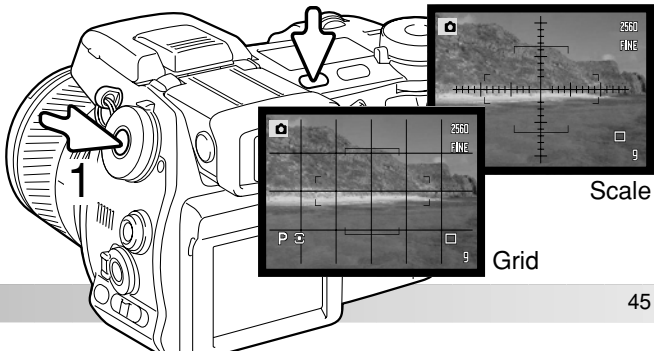

FOCUS-MODE SWITCH

Single-shot AF (Autofocus), continuous AF, and manual focus is set with the focus-mode switch. Slide the switch to select the appropriate focus mode.

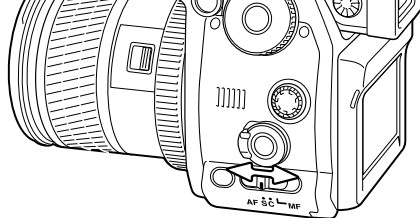

AF S.C. MF

Single-shot AF - a general purpose autofocusing mode. Its operation is described in the basic recording section.



AF S.C. MF

Continuous AF - used for photographing moving subjects. The camera continuously tracks and focuses on the subject.

Place the focus area on the subject. The four-way key of the controller can be used to move the area anywhere in the live image for off center subjects.

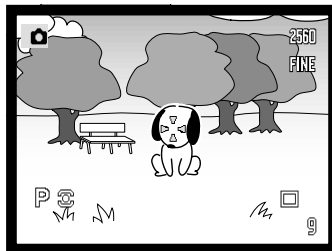

Press the shutter-release button partway down to engage the subject lock; the focus signal will confirm focus. If the subject moves or the camera is panned, the focus area will follow the subject. Focus and exposure will change as the subject moves and lighting conditions change.

Press the shutter-release button all the way down to take the picture. When the shutter button is released the focus area returns to the center of the live image. Subject tracking can be disabled and AE lock can be activated in section 4 of the recording menu (p. 80).

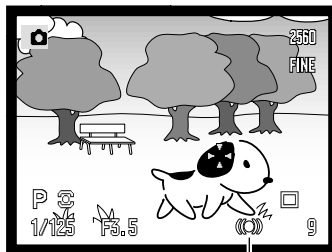

Continuous AF focus signal



Manual focus - the MF indicator is displayed in the lower right corner of the monitors to indicate the focus mode.

Use the focusing ring at the rear of the lens barrel to focus. Always use the monitor image to confirm focus. The approximate object distance from the CCD is displayed near the frame counter. The Flex Digital Magnifier (p. 105) can be used to enlarge the live image to judge sharpness.

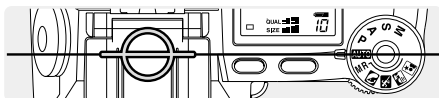

Approximate location of the CCD plane

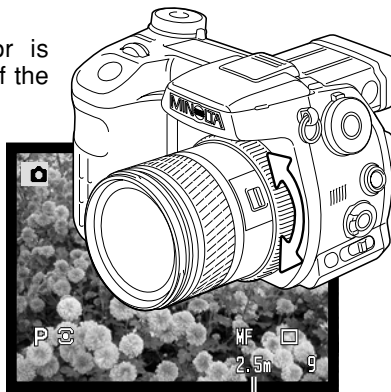

Object distance

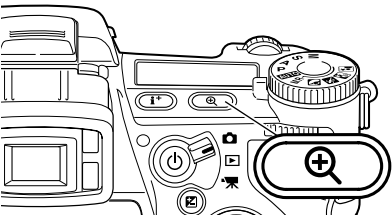

Magnification display

DIGITAL ZOOM

The digital zoom doubles the lens magnification. The digital zoom cannot be used with RAW image quality or in movie recording.

Press the magnification button on the back of the camera. The effect is immediate and X2.0 is displayed in top right corner of the live image. Pressing the magnification button a second time cancels the digital zoom.

When an image is taken with the digital zoom, the final image size depends on the image-size setting on the camera. 2560 X 1920, 2080 X 1560, and 1600 X 1200 size images are resized to 1280 X 960. The pixel dimension of 640 X 480 size images do not change.

FLEX FOCUS POINT

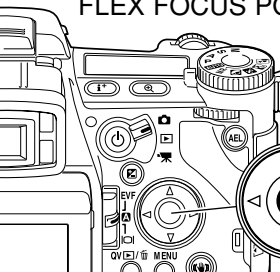

The Flex Focus Point (FFP) is a powerful tool for off-center subjects. It can be moved to any point in the image area. The FFP cannot be used with the digital zoom or movie recording.

Press and hold the center button of the controller to activate the Flex Focus Point; the wide focus frames are replaced with a central cross.



Use the controller's four-way keys (1) to move the Flex Focus Point in the live image.



Press the shutter-release button partway down to focus; the FFP turns red briefly to confirm focus.

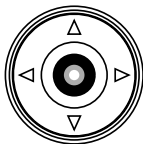

Pressing the central button of the controller returns the focus point to the center of the image area. To return to the wide-focus frames, press and hold the button until the frame lines appear.

MACRO MODE

The macro mode is used for close-up photographs of small objects. The built-in flash cannot be used with macro mode. The use of a tripod is recommended.

Align one of the arrows on the zooming ring with the index next to the macro switch and slide the switch forward. The lens must be zoomed to the wide-angle or telephoto position for the macro switch to engage. The zooming ring is locked at the wide-angle position. At the telephoto position, the zooming ring can move slightly to make fine adjustments to image size.

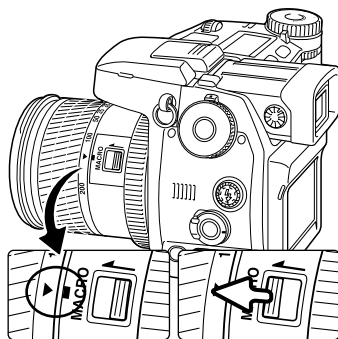

The macro indicator is displayed in the lower right corner of the monitors. Make sure the subject is within the macro focusing range:

Wide-angle position	0.3 ~ 0.6m (12 ~ 24 in.)
Telephoto position	0.25 ~ 0.6m (10 ~ 24 in.)

Approximate location of the CCD plane

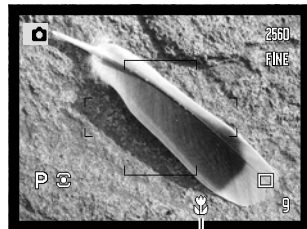
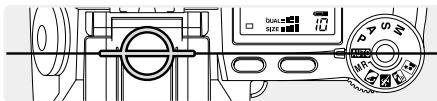

Macro-mode indicator

Shooting tips

Because of the high image magnification, hand holding cameras during close-up photography is very difficult. When possible, use a tripod.

Use the Flex Focus Point to specify the area to be in focus. Because depth of field (the area in focus) is narrow in close-up photography, using focus lock with off-center subjects can cause minor errors which are exaggerated at high magnifications.

