

# MINOLTA

The essentials of imaging

[www.minoltaeurope.com](http://www.minoltaeurope.com)



## *DiMAGE* F300

**E** INSTRUCTION MANUAL

## Before you begin

Thank you for purchasing this Minolta digital camera. Please take the time to read through this instruction manual so you can enjoy all the features of your new camera.

Check the packing list before using this product. If any items are missing, immediately contact your camera dealer.

Minolta DiMAGE F300 digital camera  
CR-V3 battery  
Hand strap HS-DG100  
16MB SD Memory Card  
AV cable AVC-200  
USB cable USB-500  
DiMAGE Viewer CD-ROM  
DiMAGE Instruction Manuals CD-ROM  
Quick Reference Guide (printed)  
Minolta International Warranty Certificate

Apple, the Apple logo, Macintosh, Power Macintosh, Mac OS, and the Mac OS logo are registered trademarks of Apple Computer Inc. Microsoft and Windows are registered trademarks of the Microsoft Corporation. The official name of Windows is Microsoft Windows Operating System. Pentium is a registered trademark of the Intel Corporation. Power PC is a trademark of the International Business Machines Corporation. QuickTime is a trademark used under license. USB DIRECT-PRINT is a trademark of Seiko Epson Corporation. All other trademarks are the property of their respective owners.

## For proper and safe use

Read and understand all warnings and cautions before using this product.

### WARNING

Using batteries improperly can cause them to leak harmful solutions, overheat, or explode which may damage property or cause personal injury. Do not ignore the following warnings.

- Only use the batteries specified in this instruction manual.
- Do not install the batteries with the polarity (+/–) reversed.
- Do not use batteries which show wear or damage.
- Do not expose batteries to fire, high temperatures, water, or moisture.
- Do not attempt to short or disassemble batteries.
- Do not store batteries near or in metallic products.
- Do not mix batteries of different types, brands, ages, or charge levels.
- Do not charge lithium batteries.
- When recharging rechargeable batteries, only use the recommended charger.
- Do not use leaking batteries. If fluid from the batteries enters your eye, immediately rinse the eye with plenty of fresh water and contact a doctor. If fluid from the batteries makes contact with your skin or clothing, wash the area thoroughly with water.
- Tape over lithium battery contacts to avoid short-circuiting during disposal; always follow local regulations for battery disposal.

- Use only the specified AC adapter within the voltage range indicated on the adapter unit. An inappropriate adapter or current may cause damage or injury through fire or electric shock.
- Do not disassemble this product. Electric shock may cause injury if a high voltage circuit inside the product is touched.
- Immediately remove the batteries or unplug the AC adapter and discontinue use if the s dropped or subjected to an impact in which the interior, especially the flash unit, is exposed. The flash has a high voltage circuit which may cause an electric shock resulting in injury. The continued use of a damaged product or part may cause injuries or fire.
- Keep batteries or small parts that could be swallowed away from infants. Contact a doctor immediately if an object is swallowed.
- Store this product out of reach of children. Be careful when around children, not to harm them with the product or parts.
- Do not fire the flash directly into the eyes. It may damage eyesight.
- Do not fire the flash at vehicle operators. It may cause a distraction or temporary blindness which may lead to an accident.
- Do not use the monitor while operating a vehicle or walking. It may result in injury or an accident.
- Do not look directly at the sun or strong light sources through the viewfinder. It may damage your eyesight or cause blindness.
- Do not use this product in a humid environment, or operate this product with wet hands. If liquid enters the product, immediately remove the batteries or unplug the AC adapter and discontinue use. The continued use of a product exposed to liquids may cause damage or injury through fire or electric shock.
- Do not use the product near inflammable gases or liquids such as gasoline, benzene, or paint thinner. Do not use inflammable products such as alcohol, benzene, or paint thinner to clean the product. The use of inflammable cleaners and solvents may cause an explosion or fire.
- When unplugging the AC adapter, do not pull on the power cord. Hold the adapter unit when removing it from an outlet.
- Do not damage, twist, modify, heat, or place heavy objects on the AC adapter cord. A damaged cord may cause damage or injury through fire or electric shock.
- If the product emits a strange odour, heat, or smoke, discontinue use. Immediately remove the batteries taking care not to burn yourself as the batteries become hot with use. The continued use of a damaged product or part may cause injuries or fire.
- Take the product to a Minolta Service Facility when repairs are required

## CAUTION

- Do not use or store the product in a hot or humid environment such as the glove compartment or trunk of a car. It may damage the product and batteries which may result in burns or injuries caused by heat, fire, explosion, or leaking battery fluid.
- If batteries are leaking, discontinue use of the product.
- The lens retracts when the camera is turned off. Touching the lens barrel while it is retracting may cause injury.
- The camera temperature rises with extended periods of use. Care should be taken to avoid burns.
- Burns may result if the memory card or batteries are removed immediately after extended periods of use. Turn the camera off and wait for it to cool.
- Do not fire the flash while it is in contact with people or objects. The flash unit discharges a large amount of energy which may cause burns.
- Do not apply pressure to the LCD monitor. A damaged monitor may cause injury, and the liquid from the monitor may cause inflammation. If liquid from the monitor makes contact with skin, wash the area with fresh water. If liquid from the monitor comes in contact with the eyes, immediately rinse the eyes with plenty of water and contact a doctor.
- When using the AC adapter, insert the plug securely into the electrical outlet.
- Do not use if the AC adapter cord is damaged.
- Do not cover the AC adapter. A fire may result.
- Do not obstruct access to the AC adapter; this can hinder the unplugging of the unit in emergencies.
- Unplug the AC adapter when cleaning or when the product is not in use.

## About this manual

The basic operation of this camera is covered between pages 14 and 37. This section of the manual covers the camera parts, preparation of the camera for use, and the basic camera operation for recording, viewing, and deleting images.

The basic and advanced auto-recording mode sections cover all the basic functions of the camera in this mode and in the multi-function recording mode. Take time to read these sections before moving on to the multi-function recording mode section. The basic playback section describes how to view images. The other sections can be read as needed.

Many of the features of this camera are controlled with menus. The menu navigation sections concisely describe how to change menu settings. Descriptions of the settings immediately follow the navigation sections.

Names of parts.....	10
Camera body .....	10
Viewfinder .....	12
Mode dial .....	12
Data panel .....	13
Getting up and running.....	14
Changing the CR-3V battery .....	14
Installing AA batteries.....	15
Attaching the hand strap .....	15
Battery condition indicator .....	16
Auto power save .....	16
Connecting the AC adapter (sold separately) .....	17
Changing the memory card.....	18
About memory cards.....	19
Setting the date and time .....	20
Auto-recording mode - basic operation .....	22
Handling the camera .....	22
Power / Access lamp .....	22
Setting the camera to record images automatically .....	23
Using the zoom lens.....	24
Focus range.....	24
About camera operation .....	25
Basic recording operation.....	26

Focus signals.....	27
Special focusing situations .....	27
Automatic Digital Subject Program Selection .....	28
Digital-subject-program button.....	29
Display button - recording mode .....	31
Flash modes .....	32
Flash range - auto-recording mode .....	33
Flash signals.....	33
Camera-shake warning .....	33
Playback - basic operation .....	34
Single-frame playback and histogram display .....	34
Viewing and deleting images.....	35
Display button - playback mode .....	36
Display button - Quick View .....	36
Enlarged playback .....	37
Auto-recording mode - advanced operation .....	38
Navigating the auto-recording mode menu .....	38
Digital zoom .....	40
Drive modes .....	41
Self-timer .....	42
Remote control (sold separately) .....	43
Continuous advance .....	44
UHS continuous advance .....	45
Bracketing .....	46
Image size and image quality .....	48
Date imprinting .....	50
Exposure compensation .....	51
Focus area selection .....	52
Focus lock.....	53
Multi-function recording mode - advanced operation .....	54
Multi-function recording mode display .....	55
Navigating the multi-function recording mode menu .....	56
Exposure modes.....	58
Programmed AE - P.....	58
Aperture priority - A .....	58
Shutter priority - S.....	59
Manual exposure - M .....	60
Bulb exposures .....	61

White balance.....	62
Automatic white balance.....	62
Preset white balance.....	62
Custom white balance.....	63
Focus modes.....	64
Single-shot AF.....	64
Subject Tracking AF.....	64
Manual focus.....	65
Full-time AF.....	65
Flash compensation.....	66
Metering modes.....	66
Camera sensitivity - ISO.....	67
Flash range and camera sensitivity.....	67
Digital Effects Control.....	68
Voice memo.....	70
Instant playback.....	71
A short guide to photography.....	72
Using exposure and flash compensation.....	74
What is an Ev? What is a stop?.....	75
Exposure latitude.....	75
Movie and audio recording.....	76
Recording movies.....	76
Recording audio.....	77
Navigating the movie menu.....	78
Notes on movie recording.....	79
Recording movies and audio with the RC-3 remote control (sold separately).....	79
Playback mode - advanced operation.....	80
Playing back voice memos and audio captions.....	80
Playing back movies and audio recordings.....	81
Navigating the playback-mode menu.....	82
Frame-selection screen.....	84
Deleting files.....	85
Locking files.....	86
Audio captioning.....	87
Slide Show.....	88
About DPOF.....	90
Creating a DPOF print order.....	90
Ordering an index print.....	91
Copy and E-mail Copy.....	92
Viewing images on a television.....	94



Setup mode - controlling the camera's operation.....	95
Navigating the setup menu.....	96
LCD monitor brightness.....	98
Formatting memory cards.....	98
Auto power save.....	99
Language.....	99
File number (#) memory.....	99
Folder name.....	100
Audio signals.....	100
Shutter FX.....	101
Volume.....	102
Reset default.....	102
Noise reduction.....	104
Setting the date and time.....	104
Setting the date format.....	104
Video output.....	104
Data-transfer mode - connecting to a computer.....	105
System requirements.....	105
Connecting the camera to a computer.....	106
Connecting to Windows 98 and 98 Second Edition.....	108
Automatic installation.....	108
Manual installation.....	109
Connecting to Mac OS 8.6.....	111
QuickTime system requirements.....	111
Auto power save (data-transfer mode).....	111
Memory card folder organisation.....	112
Disconnecting the camera from the computer.....	114
Windows 98 and 98 Second Edition.....	114
Windows Me, 2000 Professional, and XP.....	114
Macintosh.....	115
Changing the memory card (data-transfer mode).....	116
Appendix.....	117
Troubleshooting.....	117
About Ni-MH batteries.....	119
Uninstalling the driver software - Windows.....	120
Using USB DIRECT-PRINT.....	121
Care and storage.....	122
Technical specifications.....	126

## Camera body

\* This camera is a sophisticated optical instrument. Care should be taken to keep these surfaces clean. Please read the care and storage instructions in the back of this manual (p. 122).

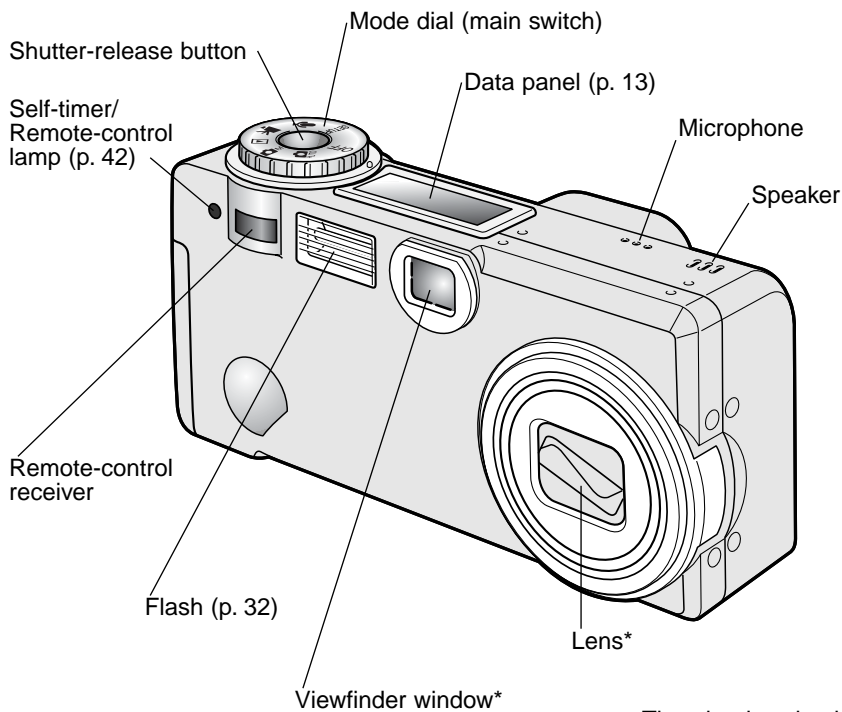

The tripod socket is located on the bottom of the body.

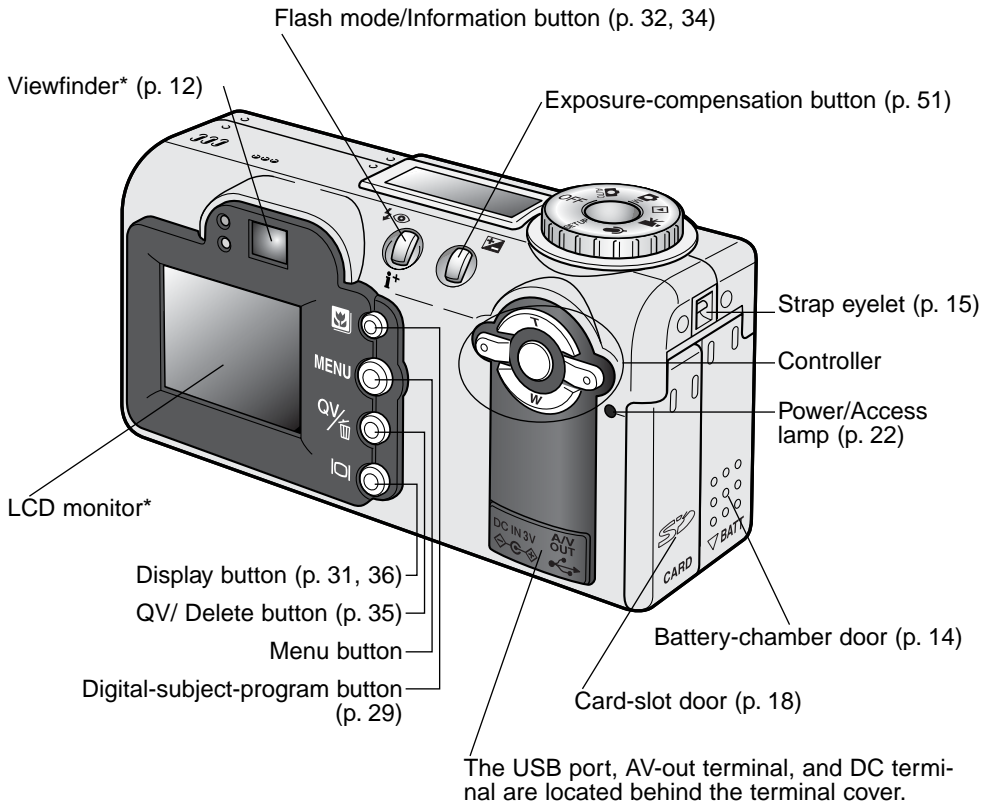

## Viewfinder

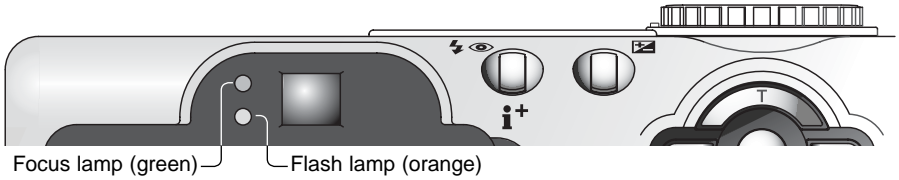



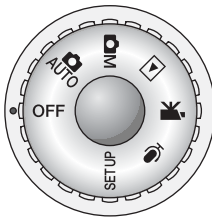

Because the optical viewfinder and the lens are slightly separated, the image seen through one is not exactly the same as the other; this is called parallax. Parallax can cause errors in framing at close distances and is more pronounced at longer focal lengths. When the subject is closer than 1m (3ft) at the wide-angle lens position or 3m (9.8ft) at the telephoto position, use the LCD monitor to compose the image; because the lens creates the monitor image, it does not suffer from parallax.

## Mode dial

This dial gives direct and easy access to the camera's major modes. It also acts as the main switch.



-  **AUTO** Auto-recording mode (p. 22, 38)
-  **M** Multi-function recording mode (p. 54)
-  **PLAYBACK** Playback mode (p. 34, 80)
-  **MOVIE** Movie-recording mode (p. 76)
-  **AUDIO** Audio recording mode (p. 76)
- SETUP** Setup mode (p. 95)

## Data panel

Located on the top of the camera body, the data panel shows the status of the camera. All icons have been shown for clarity.

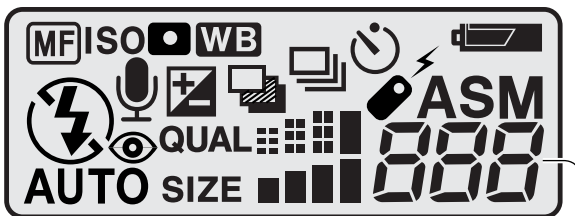

Frame counter (p. 49)



Manual-focus indicator (p. 65)

ISO

Camera-sensitivity indicator (p. 67)



Spot-metering indicator (p. 66)

WB

White-balance indicator (p. 62)



Drive-mode indicators (p. 41)



Battery-condition indicator (p. 16)



Microphone indicator (p. 70, 77, 87)



Flash-mode indicators (p. 32)

QUAL

Image-quality display (p. 48)

SIZE

Image-size display (p. 48)

ASM

Exposure-mode indicators (p. 58)



Exposure / Flash-compensation indicator (p. 51, 66)

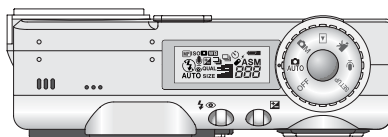

The frame counter cannot exceed 999. When the number of recordable images exceeds this, 999 will be displayed. The frame counter will continue to count down when the number of recordable images falls below one thousand.

# GETTING UP AND RUNNING

## Changing the CR-V3 battery

This digital camera uses one CR-V3 lithium battery. When replacing the batteries, the mode dial should be in the off position. N.B. Whilst this battery is available in some digital camera stores we recommend that Ni-MH AA batteries be used. See next section.

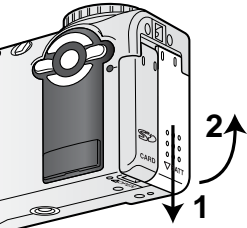
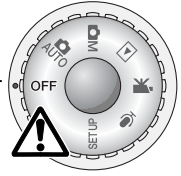

Open the battery-chamber door by sliding the door toward the bottom of the camera (1) to release the safety catch; the door can then be opened (2).

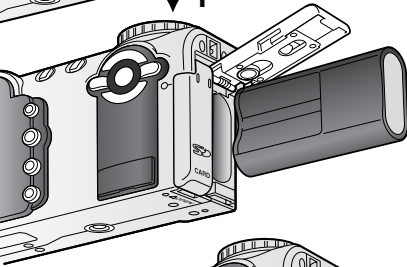

Insert the battery. The CR-V3 battery must be inserted with the battery terminals first. The flat side of the battery should face the front of the camera. If the battery does not fit, check its orientation. Never force the battery.

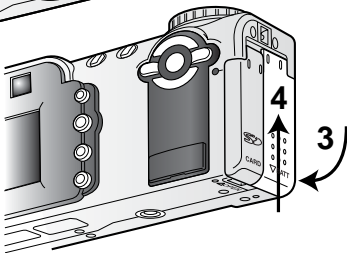

Close the battery-chamber door (3) and slide it toward the top of the body (4) to engage the safety catch.

After installing the battery, the set-time/date message may appear on the monitor. The clock and calendar are set in the custom 2 section of the setup menu (p. 20).

## Installing AA batteries

When the supplied CR-V3 battery is exhausted please use two AA-size Nickel Metal Hydride (Ni-MH) batteries. We do not recommend the use of Alkaline or Lithium AA batteries. Ni-MH batteries offer improved performance particularly when charged with an 'intelligent' charger. Intelligent chargers recharge each battery with the amount of power it requires. 1800mAh or higher capacity batteries are recommended.

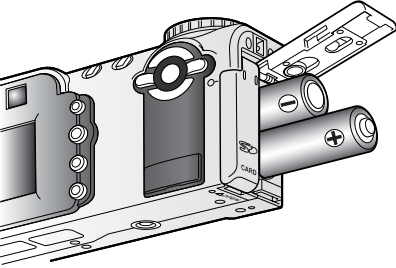

Install the AA batteries as shown in the diagram; make sure the positive and negative battery terminals are oriented correctly.

## Attaching the hand strap

Always keep the strap around your wrist in case the camera is accidentally dropped. An optional metal chain neck strap, NS-DG100, and leather neck strap, NS-DG200, are also available from your Minolta dealer. Availability varies with region.

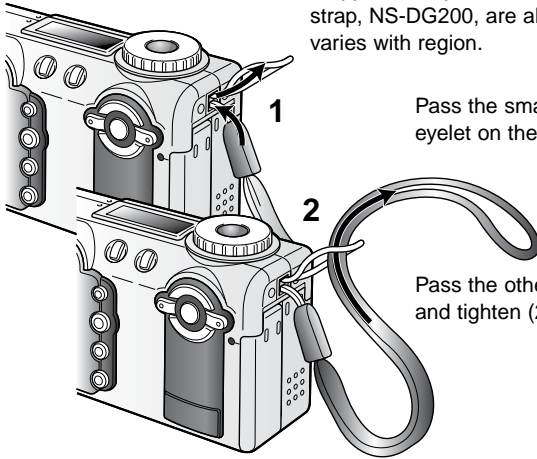









Pass the small loop of the hand strap through the strap eyelet on the camera body (1).

Pass the other end of the strap through the small loop and tighten (2).

## Battery condition indicator

This camera is equipped with an automatic battery-condition indicator. When the camera is on, the battery-condition indicator appears on the data panel and monitor. If the data panel and monitor are blank, the battery may be exhausted or installed incorrectly.

		Full-battery indicator - the battery is fully charged. This icon is displayed for five seconds on the monitor when the camera is turned on. The icon remains on the data panel.
		Low-battery indicator - battery power is low. The battery should be replaced as soon as possible. The monitor will turn off while the flash is charging to save power.
		Low-battery warning - battery power is very low. The monitor icon is red. The battery should be replaced as soon as possible. This warning automatically appears and remains on the monitor until the battery is changed. The monitor will turn off while the flash is charging to save power. If power falls below this level, the battery-exhausted message will be displayed just before the camera shuts down.
		Blinking low-battery warning - displayed on the data panel with no other icons; power is insufficient for camera operation. The shutter will not release.

## Auto power save

To conserve battery power, the camera will turn off displays and unnecessary functions if an operation is not made within a minute. The LCD monitor turns off after thirty seconds. To restore power, press any button or key, or turn the mode dial to another position. Except for the thirty-second monitor period, the length of the auto-power-save period can be changed in the basic section of the setup menu (p. 96).



## Connecting the AC adapter (sold separately)

The AC Adapter AC-6 allows the camera to be powered from an electrical household outlet. The AC Adapter is recommended when the camera is interfaced with a computer or during periods of heavy use.

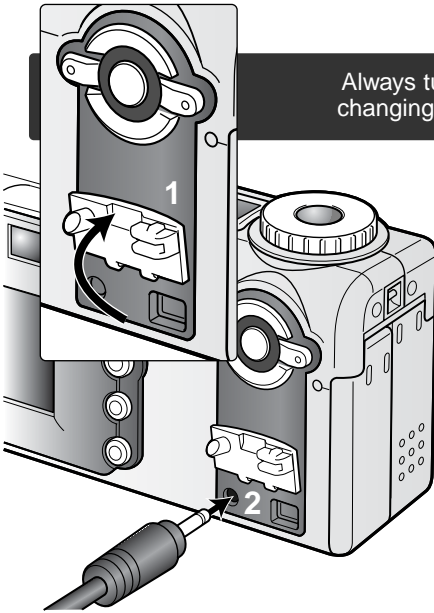

Always turn off the camera before changing between power supplies.

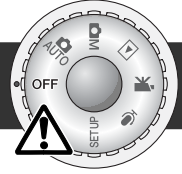

Lift the DC terminal cover from the bottom (1). The cover is attached to the body to prevent loss.

Insert the mini plug of the AC adapter into the DC terminal (2).

Insert the AC adapter plug into an electrical outlet.

## Changing the memory card

An SD Memory Card or MultiMediaCard must be inserted for the camera to operate. If a card has not been inserted, a no-card warning will automatically be displayed on the monitor and three dashes (---) will be displayed on the data-panel frame counter.

Always turn off the camera and confirm the power/access lamp is not red before removing or inserting a memory card; damage and data loss may result.

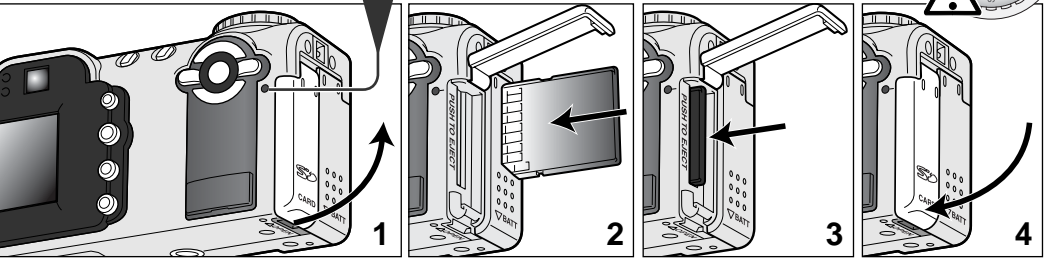
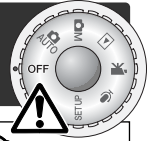

Open the card-slot door (1) from the fingernail notch at the bottom of the camera.

Insert the memory card all the way into the card slot and release (2). Insert the card so the face is toward the front of the camera. Always push the card in straight. Never force the card. If the card does not fit, check that it is oriented correctly. The card should catch in the slot.

To eject a memory card, press the card into the slot and release (3). The card can now be pulled out. Take care when removing the card as it becomes hot with use.

Close the card-slot door (4). The door should click into place.

If the card-not-recognized message appears, the inserted card in the camera may need to be formatted. A card used in another camera may have to be formatted before being used. If the unable-to-use-card message appears, the card is not compatible with the camera and cannot be formatted. A card is formatted in the basic section of the setup menu (p. 96). The formatting operation permanently erases all the data on the card.

## About memory cards

The response time during recording and playback is longer with MultiMediaCards compared with SD Memory Cards. This is not a defect, but rather due to the specifications of the cards. When using large capacity cards, some operations like deletion may take longer.

SD Memory Cards have a write-protect switch to prevent image data from being deleted. By sliding the switch to the bottom of the card, the data will be protected. However, when the card is protected, images cannot be recorded. If an attempt is made to record or delete an image with the camera, the card-locked message will appear on the monitor. For memory card care and storage see page 123.

Memory cards should not be used to permanently store image data.

Always make a copy of camera files on an appropriate storage device or recording media. Making an additional backup copy of the data is recommended. Minolta has no responsibility for any loss or damage to data.

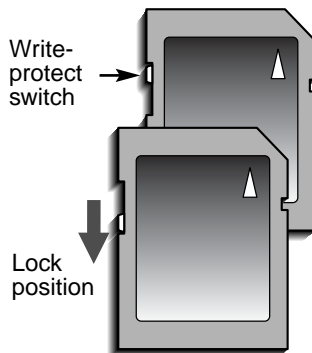

## Setting the date and time

After initially inserting a memory card and battery, the camera's clock and calendar must be set. When images are recorded, the image data is saved with the date and time of recording. Depending on the region, the menu language may also have to be set. To change the language, see the camera notes on the following page.

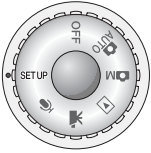

Turn the mode dial on the top of the camera to the setup position. The camera will turn on and the setup menu will be displayed.

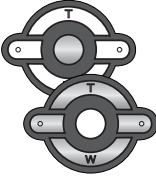

Navigating the menu is simple. The up/down and left/right keys of the controller (1) move the cursor and change settings on the menu.

The central button of the controller selects menu options and sets adjustments.

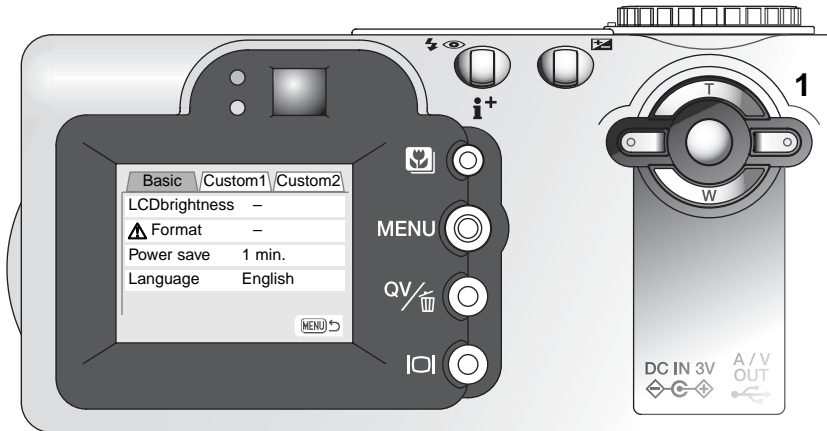

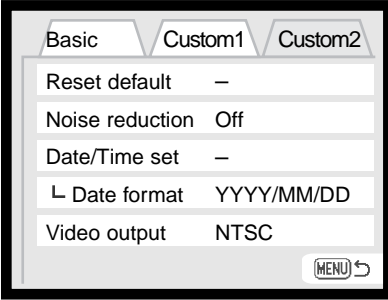

Setup menu: custom 2 section



Use the right key to highlight the custom 2 tab at the top of the menu.



Use the down key to highlight the date/time-set menu option.



Press the right key. "Enter" will appear on the right side of the menu.



Press the central button to display the date/time setting screen.



Use the left and right keys to select the item to be changed.



Use the up and down keys to adjust the item.



Press the central button to set the clock and calendar. The setup menu will be displayed.

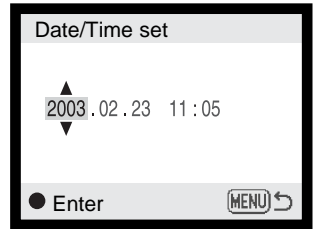

Date/Time setting screen

## Camera notes

For customers in certain areas, the menu language must also be set. Highlight the language option in the basic section of the setup menu. Press the right key to display the language settings. Using the up/down keys, highlight the desired language. Press the central button to set the highlighted language; the setup menu will be displayed in the selected language.

# AUTO-RECORDING MODE – BASIC OPERATION

This section covers the basic operation of this camera. Thoroughly familiarize yourself with the operations in this section before moving on to the other sections in the manual.

The sophisticated technology employed in the auto-recording mode frees the photographer from complicated camera settings. Although automated, the camera's operation can be changed to meet various conditions as well as to suit personal shooting preferences.

## Handling the camera

While using the viewfinder or LCD monitor, grip the camera firmly with your right hand while supporting the body with your left. Keep your elbows at your side and your feet shoulder-width apart to hold the camera steadily.

When taking vertical pictures, hold the camera so that the flash is above the lens with the grip to the top. Take care not to cover the lens with your fingers or the strap.

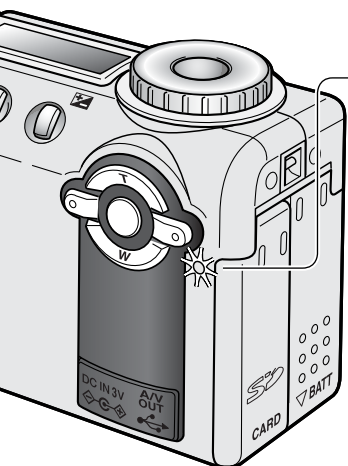
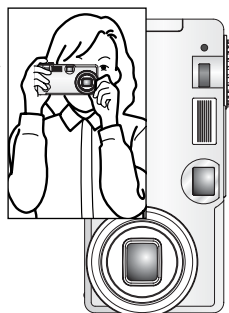

## Power / Access lamp

The power / access lamp turns green and glows steadily when the camera is on. The lamp will turn red and blink when data is being transferred between the camera and memory card; never remove the card during this period.

If the lens is hindered while extending, the green lamp may blink for a three-minute period. Turn the camera off and on to initialize the lens.

# Setting the camera to record images automatically

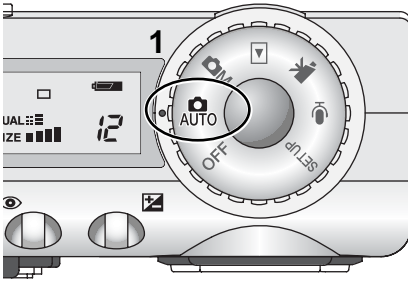

Turn the mode dial to the auto-recording mode position (1); all camera operations are now fully automatic. The autofocus, exposure, and imaging systems will work together to bring beautiful results effortlessly.

While many of the camera's systems in this mode are automatic, the camera's operation can be optimized to different subjects very simply with the digital subject program button (p. 29). The flash mode (p. 32) and drive mode (p. 41) can also be changed. Image size and quality can be set on the auto-recording mode menu (p. 38).

- Exposure mode – Program (fixed)
- Metering mode – Multi-segment (fixed)
- Camera sensitivity (ISO) – Auto (fixed)
- Flash mode – Autoflash (can be changed\*)
- Focus area – Wide focus area (can be changed\*)
- Focus control – Area AF & Subject Tracking AF (fixed)
- Drive mode – Single-frame advance (can be changed\*)
- Exposure compensation – 0.0 (can be adjusted\*)
- Sharpness – Normal (fixed)
- Contrast – Normal (fixed)
- Saturation – Normal (fixed)
- Color mode – Natural Color (fixed)
- White balance – Auto (fixed)

\* Changes to the flash mode, focus area, drive mode, or exposure compensation will be reset when the mode dial is turned to another position. The flash mode is reset to autoflash or autoflash with red eye reduction depending on which of the two modes was set last.

## Using the zoom lens

This camera is equipped with a 7.8 to 23.4mm optical zoom. This is equivalent to a 38 to 114mm zoom lens on a 35mm camera. In 35mm photography, focal lengths below 50mm are referred to as wide-angle; the angle of view is larger than that of the human eye. Above 50mm is referred to as telephoto and makes distant objects appear closer. The effect of the optical zoom is visible in both the viewfinder and LCD monitor.

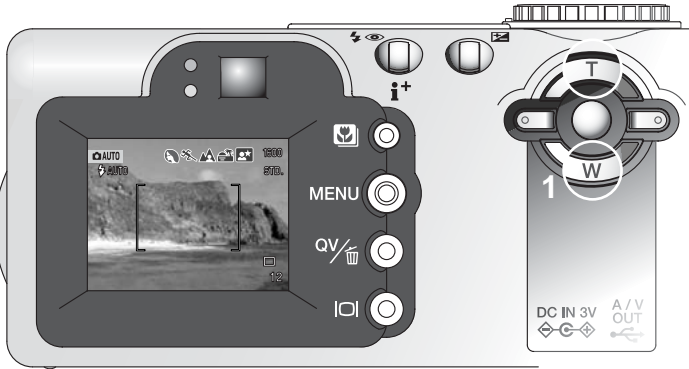

The zoom lens is operated by the controller (1). Pressing the up key (T) will zoom in to the telephoto position of the lens. Pressing the down key (W) will zoom out to the wide-angle position.

## Focus range

Normal focusing range

0.5m - ∞ (1.6ft - ∞)

Macro mode (p. 29)

0.2m - 0.6m (0.7ft - 2ft)

All distances are measured from the CCD.

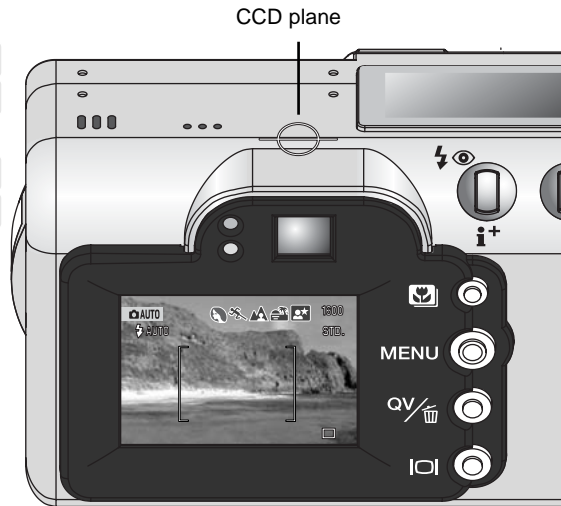



# About camera operation

The auto-recording mode uses advanced technology to make photography as effortless as possible. Automatic Digital Subject Program Selection optimizes exposure, color, and image-processing settings for each subject. The sophisticated AF system locates and tracks the subject automatically.

**Automatic Digital Subject Program Selection** - The icons at the top of the LCD monitor display indicate the Digital Subject Program in use. When taking pictures, the icon for the active subject program will remain. If no icons are displayed, programmed AE is employed. For more on Automatic Digital Subject Program Selection, see page 28.

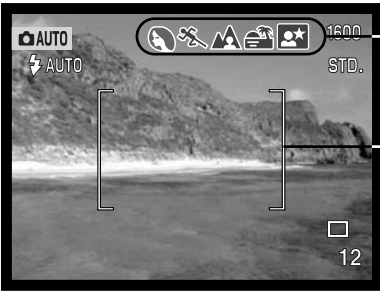

Automatic Digital Subject Program Display

Area AF focus frames

**Area AF & Subject Tracking AF** - Area AF locates the subject within the extra large focus frames. An AF sensor will be displayed when the camera locates and focuses on the subject. Subject Tracking AF will continue to follow the subject in the focus frames whether the subject moves or the camera position is changed.

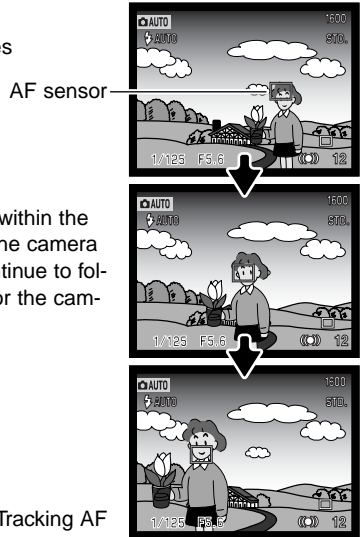

Subject Tracking AF

## Basic recording operation

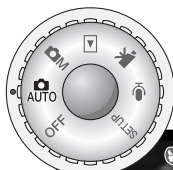

With the mode dial set to auto recording, the camera will be on and the LCD monitor will activate. Auto recording mode uses two advanced AF systems, Area AF and Subject Tracking AF, to locate and track the subject in the the extra-wide focus frames.

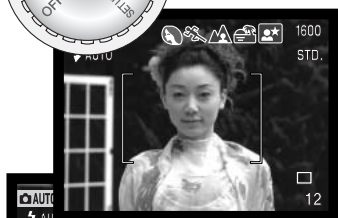

Place the subject anywhere within the focus frame.

- Make sure the subject is within the focus range of the lens: 0.5m - ∞ (1.6ft - ∞). For subjects closer than 0.5m, use the macro function (p. 29).
- If the subject is closer than 1m at the wide-angle lens position or 3m at the telephoto position, use the monitor to frame the subject.

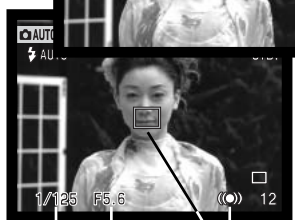

Press the shutter-release button partway down (1) to lock onto the subject and fix the exposure.

- The focus signals on the monitor will confirm subject lock. If the focus signal is red, the camera was unable to locate the subject. Repeat the previous steps until the signal is white.
- When the subject lock engages, an AF sensor will appear on the live image to indicate the subject. If the subject moves within the focus frames, the AF sensor will change to track the subject.
- The shutter speed and aperture will appear indicating the exposure is locked.
- See page 28 for information on Automatic Digital Subject Selection.

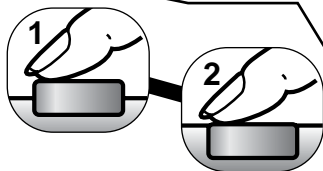



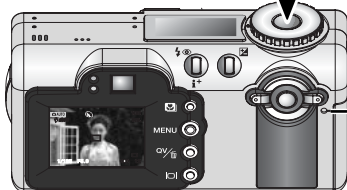

Press the shutter-release button all the way down (2) to take the picture.

- The access lamp will turn red and blink indicating image data is being written to the memory card. Never remove a memory card while data is being transferred.



## Focus signals

This digital camera has a quick, accurate autofocus system. The focus icon in the lower right corner of the LCD monitor and the green focus lamp next to the viewfinder indicate the focus status. The shutter can be released even if the camera cannot focus on the subject.

		Focus icon: white Focus lamp: steady	Subject locked. The camera will continue to track the subject within the focus frames.
		Focus icon: red Focus lamp: blinking	Cannot focus. The subject is too close or a special situation is preventing the AF system from focusing.

If the subject lock is lost, the monitor icon will change from white to red, but the focus lamp will continue to glow steadily. For more about Subject Tracking AF, see page 64.

When the AF system cannot focus, focus lock with Focus Area Selection can be used (p. 52, 53).

## Special focusing situations

The camera may not be able to focus in certain situations. If the autofocus system cannot focus on a subject, the focus icon will turn red. In this situation, focus-lock with Focus Area Selection can be used to focus on an object at the same distance as the main subject and then the image can be recomposed on the monitor (p. 52, 53).

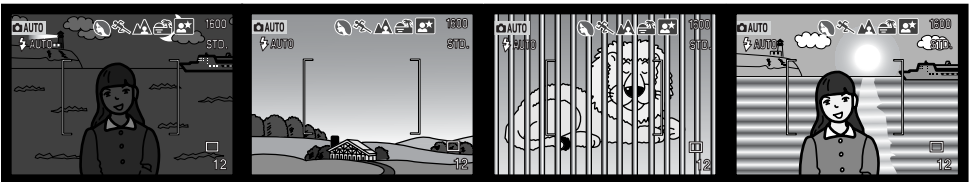

The subject is too dark.

The subject in the focus frame is low in contrast.

Two subjects at different distances overlap in the focus frame.

The subject is near a very bright object or area.

## Automatic Digital Subject Program Selection

Automatic Digital Program Selection chooses between programmed AE and one of five subject programs: portrait, sports action, landscape, sunset, and night portrait. The digital subject programs optimize the camera's performance for various conditions and subjects. Exposure, white-balance, and image-processing systems work in unison for beautiful results. For information on individual subject programs, see page 30.

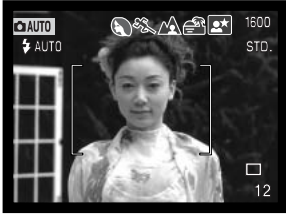

A row of gray indicators at the top on the monitor display will indicate Automatic Digital Subject Selection is active. Place the subject in the focus frames; the procedure is the same as the basic recording operation described on page 26.



Press the shutter-release button partway down; the AF system will locate the subject and the Automatic Digital Subject Selection function will choose a subject program. If no icons are displayed, programmed AE is active. Press the shutter-release button all the way down to take the picture.

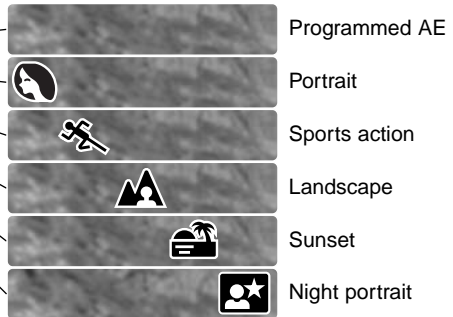

Hold the camera steadily when the sunset or night-portrait subject program is selected as exposures can be long.

# Digital-subject-program button

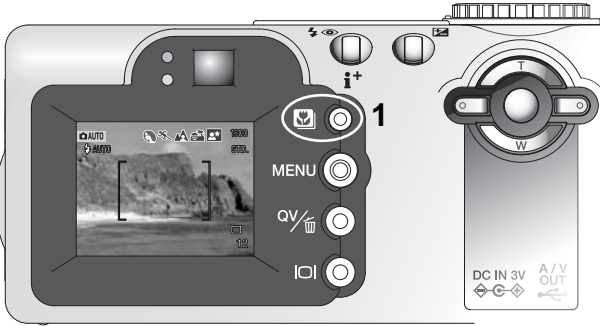

Pressing the subject-program button (1) cycles through the modes. The active subject program will be indicated at the top of the live image. The subject program will remain in effect until it is changed or the mode dial is turned to another position. Except for macro and night portrait, digital subject programs cannot be used in the multi-function recording mode. For information on individual subject programs, see page 30.

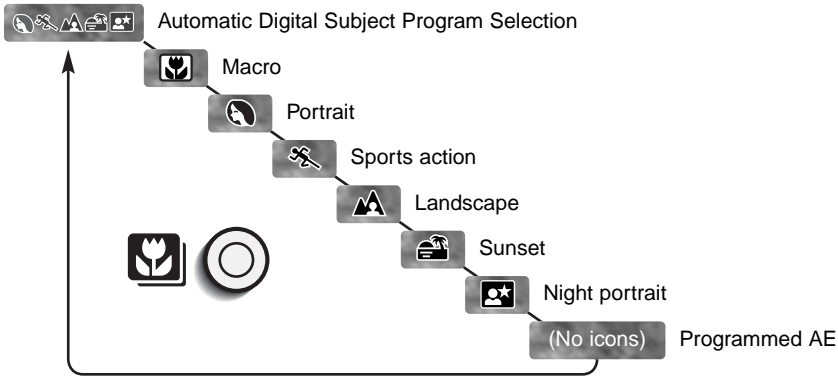

While camera performance is optimized for each shooting condition, some changes can be made to camera settings with subject programs. The flash mode (p. 32) can be changed and the exposure can be altered using exposure-compensation (p. 51). In extreme lighting conditions, adjustments using exposure compensation may not produce the intended results in the portrait, or night-portrait mode. The camera-shake warning (p. 33) may appear in macro, landscape, sunset, or night-portrait modes.



**MACRO** - used for close-up photography between 20 and 60 cm (0.7 - 2.0ft) from the CCD. The lens will automatically zoom to the macro position and cannot be changed. Because of parallax, the LCD monitor should be used to compose the picture. Full-time AF (p. 65) is employed. Available in the multi-function recording mode.



**PORTRAIT** - optimized to reproduce soft skin tones and a slight defocusing of the background. Most portraits look best at a telephoto setting; longer focal lengths do not exaggerate facial features and the shallower depth of field softens the background.



**SPORTS ACTION** - optimized to stop action. Automatic Digital Subject Program Selection activates this mode when shooting moving subjects at a distance with a telephoto lens setting. Full-time AF (p. 65) is employed.



**LANDSCAPE** - optimized to produce sharp, colorful landscapes. With bright outdoor scenery, Automatic Digital Subject Program Selection activates this mode with distant subjects at a wide-angle lens setting. The flash will not fire in this mode. To use the flash, change the flash mode to fill flash.



**SUNSET** - optimized to produce rich, warm sunsets. Automatic Digital Subject Program Selection recognizes the warmth of the setting sun in a landscape photograph and activates this mode.



**NIGHT PORTRAIT** - the flash and ambient exposures are balanced to reveal the subject and background in low light. Ask your subject not to move after the flash burst; the shutter may still be open for the background exposure. To take pictures of landscapes at night, set the flash mode to flash cancel (p. 32). Because the exposures can be long the use of a tripod is recommended.

## Display button - recording mode

The display button controls the LCD monitor display. The display cycles to the next position each time the button is pressed: full display, live image only, and monitor off.

Battery power can be conserved by turning the monitor off and using the viewfinder to take pictures. When the menu or exposure-compensation button is pressed, or the macro mode is activated, the monitor will automatically turn on. Subject Tracking AF, Full-time AF (p. 65), and the digital zoom are disabled when the monitor is off.

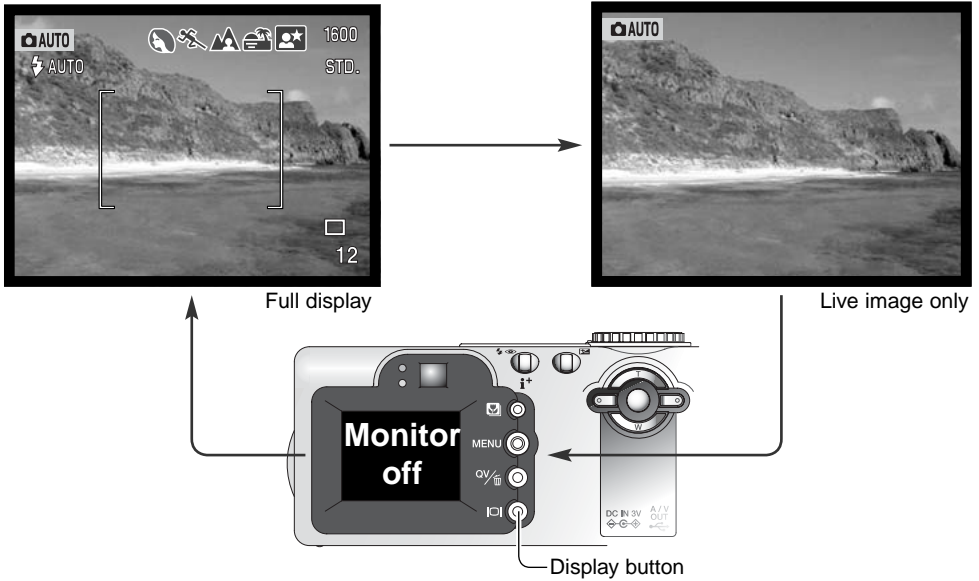

## Flash modes

To set the flash mode, simply press the flash mode button (1) on the back of the camera until the appropriate mode is indicated.

**Autoflash** - the flash fires automatically in low-light and backlit conditions.

**Red-eye reduction** - multiple flashes are used before the main flash burst to reduce red-eye; an effect caused by light reflected from the retina. Use in low-light conditions when taking photographs of people or animals. The pre-flashes contract the pupils of the subject's eyes.

**Fill-flash** - the flash fires with each exposure regardless of the amount of ambient light. Fill-flash can be used to reduce harsh shadows caused by strong direct light or sunshine.

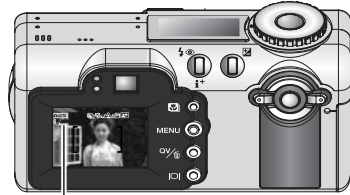
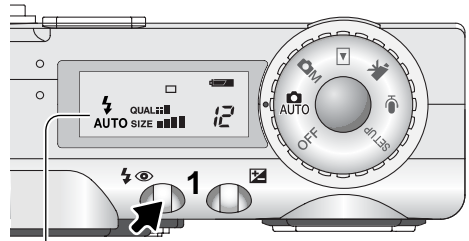

		Autoflash
		Autoflash with red-eye reduction
		Fill-flash
		Flash cancel

**Flash cancel** - the flash will not fire. Use flash cancel when flash photography is prohibited, natural light is desired to illuminate the subject, or the subject is beyond the flash range. The camera-shake warning may appear when flash cancel is selected.



## Flash range - auto-recording mode

The camera will automatically control the flash output. For well-exposed images, the subject must be within the flash range. Because of the optical system, the flash range is not the same at the lens' wide-angle position as it is at the telephoto position.

Wide-angle position	0.5m ~ 3.4m (1.6 ft. ~ 11.1 ft.)
Telephoto position	0.5m ~ 2.0m (1.6 ft. ~ 6.6 ft.)

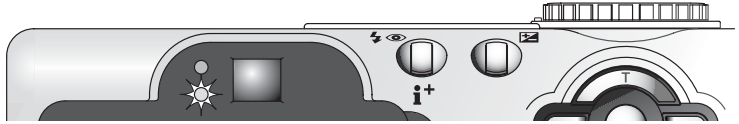

## Flash signals

The orange flash lamp next to the viewfinder indicates the status of the flash. When the lamp blinks quickly, the flash is charging and the shutter will not release. The lamp glows steadily when the flash is charged and ready to fire.

## Camera-shake warning

If the shutter speed falls below the point where the camera can be safely hand held, the camera-shake warning will appear on the LCD monitor and the orange flash lamp will blink slowly. Camera shake is slight blurring caused by subtle hand motion and is more pronounced at the telephoto position of the lens than at the wide-angle. Although the warning appears, the shutter can still be released. If the warning appears, the following steps can be taken:

- Place the camera on a tripod.
- Use the built-in flash.
- Zoom the lens towards the wide-angle position until the warning disappears.

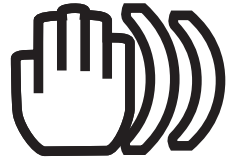

# PLAYBACK - BASIC OPERATION

Images can be viewed in the Quick View or playback modes. This section covers the basic operations in both modes. The playback mode has additional functions, see page 80.

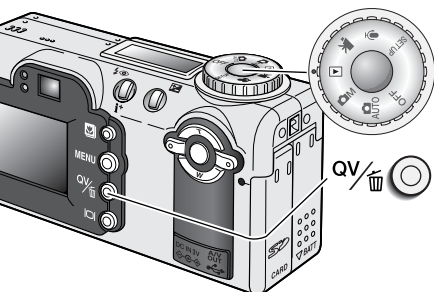

To view images from the playback mode, turn the mode dial to the playback position.

To view images from the auto-recording or multi-function recording modes, press the Quick View / delete button.

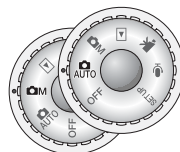

## Single-frame playback and histogram display

The diagram shows a camera's LCD screen divided into three sections. The top section shows a landscape photo with playback data. The middle section shows a smaller version of the photo with technical data. The bottom section shows a histogram with technical data.

- Mode indicator**: [PLAYBACK icon]
- Image size (p. 48)**: 1600
- Image quality (p. 48)**: STD
- Time of capture**: 14:20
- Date of capture**: 2002.12.27
- Audio-track indicator (p. 80)**: [Audio icon]
- Lock indicator (p. 86)**: [Lock icon]
- Print indicator (p. 90)**: [Print icon]
- Frame number/ total number of images**: 100-0056 / [0029/0078]
- Aperture value**: F5.6
- Shutter speed**: 1/125
- White-balance setting (p. 62)**: AWB
- Sensitivity setting (p. 67)**: ISO AUTO
- Degree of exposure compensation (p. 51)**: [0]
- Folder name**: MLT17
- Folder number - image file number**: 100-0056
- Histogram**: [Histogram graph]

The histogram shows the luminance distribution of the image from black (left) to white (right). The 256 vertical lines indicates the relative proportion of that light value in the image. The histogram can be used to evaluate exposure, but displays no color information.

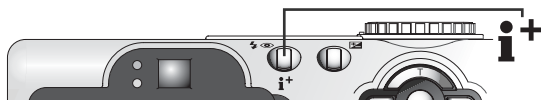

To switch between the single-frame playback and histogram display, press the information button.

## Viewing and deleting images



In Quick View or the playback mode, use the left/right keys of the controller to scroll through the images.

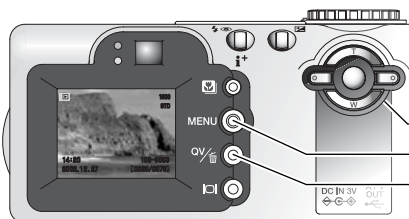

To return to the recording mode from Quick View, press the menu button or shutter-release button partway down.

Controller

Menu button

Quick View / Delete button

The displayed image can be deleted. Once deleted, an image cannot be recovered.



To delete the displayed image, press the QV/delete button. A confirmation screen will appear.



Use the left/right keys to highlight "Yes," "No" will cancel the operation.



Press the central button of the controller to delete the image.



## Display button - playback mode

The display button controls the display format. Each time the button is pressed, the display cycles through to the next format: full display, image only, index playback.

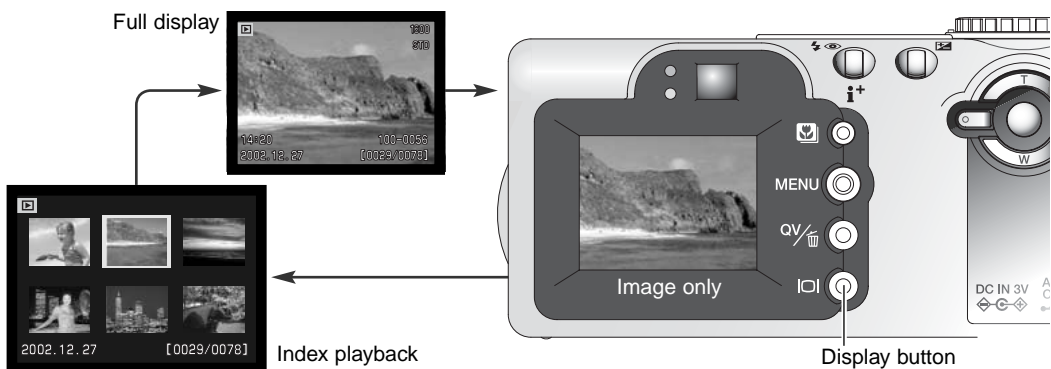

In index playback, the four-way keys of the controller will move the yellow border. When the image is highlighted with the border, the date of recording, voice-memo indicator, the lock and printing status, and the frame number of the image are displayed at the bottom of the screen. The highlighted image can be deleted using the QV/delete button (p. 35), or an audio track or movie clip can be played by pressing the central button of the controller. When the display button is pressed again, the highlighted image will be displayed in the single-frame playback mode.

## Display button - Quick View

Pressing the display button in Quick View switches between the full display and the image-only display.



# Enlarged playback

In single-frame playback in Quick View or the playback mode, a still image can be enlarged up to 6X in 0.2 increments for closer examination.



With the image to be magnified displayed, press the up key of the controller to activate the enlarged playback mode. The degree of magnification is displayed on the LCD monitor.



Pressing the up key increases the image magnification. Pressing the down key decreases the magnification.



The display button switches between showing the full display and the image only.



To scroll the image, press the central button of the controller; the central button switches between the enlarged-playback and scroll screens.

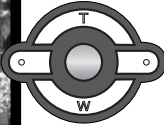
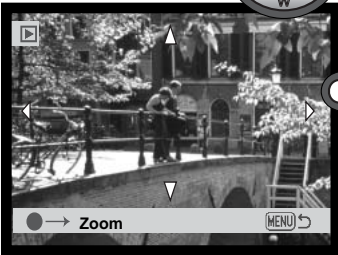

Use the four-way keys of the controller to scroll the image.



To exit the enlarged playback mode, press the menu button.

# AUTO-RECORDING MODE - ADVANCED OPERATION

## Navigating the auto-recording mode menu

In auto-recording mode, the menu button (1) turns the menu on and off. The left/right and up/down keys of the controller (2) are used to move the cursor in the menu. Pressing the central button of the controller will enter a setting.

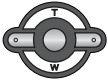

Use the up/down keys of the controller (2) to scroll through the menu options. Highlight the option whose setting needs to be changed.



With the menu option to be changed highlighted, press the right controller key; the settings will be displayed with the current setting highlighted. To return to the menu options, press the left key.

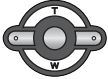

Use the up/down keys to highlight the new setting.



Press the central button of the controller to select the highlighted setting.

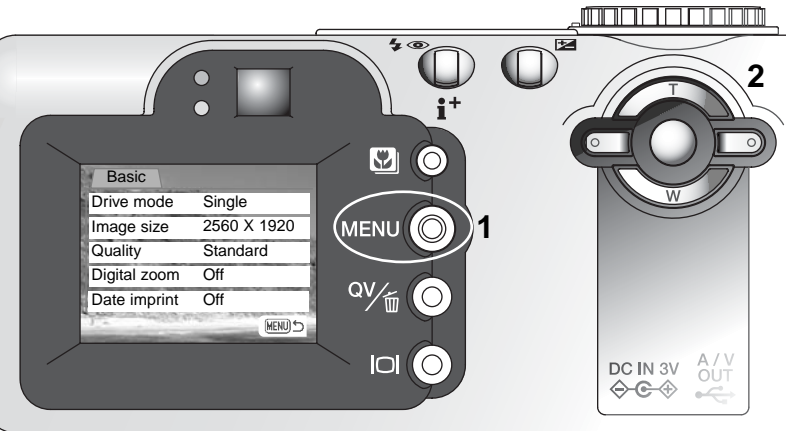

Once a setting has been selected, the cursor will return to the menu options and the new setting will be displayed. Changes can continue to be made.

To return to the auto-recording mode, press the menu button.

Basic	
Drive mode	<input type="checkbox"/> Single Timer / RC Continuous UHS cont. Bracketing
Image size	2560 X 1920 2048 X 1536 1600 X 1200 640 X 480
Quality	Super fine Fine Standard Economy
Digital zoom	On / Off
Date imprinting	On / Off

Except for the drive mode, settings made with the auto-recording menu will remain in effect until changed or the camera is reset to its default settings (p. 102).

**Drive modes** - to control the rate and method of image capture.

**Image size** - to set the pixel resolution of the images. Image size affects the size of the image file.

**Image quality** - to set the rate of compression of the images. Image quality affects the size of the image file.

**Digital zoom** - the digital zoom can be turned off or on.

**Date imprinting** - to imprint the date of capture on each image when it is recorded.

Read the following sections for more details on these options and settings. Changes made to image size, image quality, digital zoom, and date imprinting will affect the multi-function recording mode. All of these functions appear on the multi-function recording mode menu.



Use the left/right keys to select the bracketing increment (p. 46).

# Digital zoom

The digital zoom is activated on the auto-recording mode menu (p. 38) and in the custom 2 section of the multi-function recording mode menu (p. 56). The digital zoom extends the power of the telephoto position of the optical zoom by up to 4X in 0.1X increments. The transition between the optical zoom and digital zoom is seamless. When the digital zoom is active, the image magnification is displayed on the monitor and the focus frames change to a single focus area. The autofocus mode is set to single-shot AF (p. 64). The digital zoom is canceled if the LCD monitor is turned off.

Digital zoom images are interpolated to the set image size. There can be some loss of quality with images taken with the digital zoom.

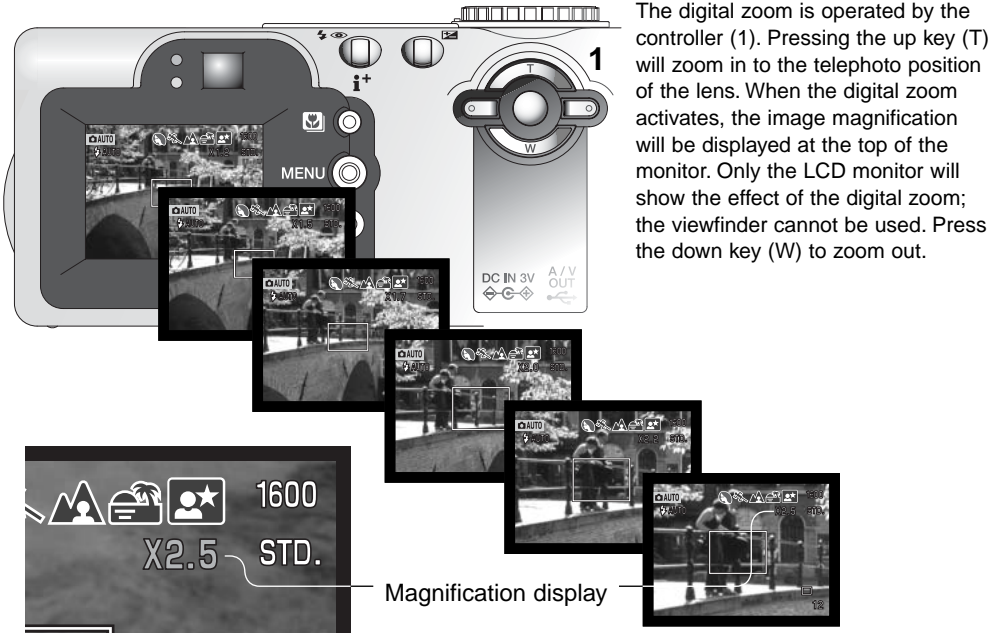



# Drive modes

The drive modes control the rate and method of image capture. Icons indicating the selected drive mode appear on the data panel and LCD monitor.

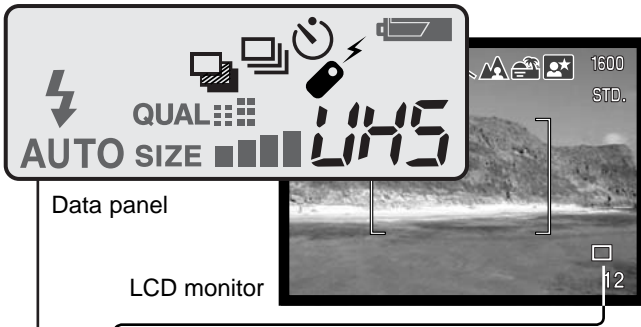

All icons have been shown for clarity. The single-frame advance and continuous drive indicators occupy the same area of the data panel. All the drive-mode icons appear in the lower right corner of the monitor.

		Single-frame advance	To take a single image each time the shutter-release button is pressed (p. 26).
		Self-timer/ Remote control	To delay the release of the shutter. Used for self-portraits.
		Continuous advance	To take multiple images when the shutter-release button is pressed and held.
		UHS continuous advance	To take up to eleven 1280 X 960 images in one second.
		Bracketing	To take a series of three images with differing exposures.

In auto-recording mode, the drive mode resets to single-frame advance each time the position of the mode dial is changed. In multi-function recording mode, the drive mode will remain in effect until changed on the menu or the camera is reset to its default settings.

## Self-timer

Used for self-portraits, the self-timer will delay the release of the shutter for approximately ten seconds after the shutter-release button is pressed. When the drive mode is set to self-timer, the focus mode is changed from Subject Tracking AF to single-shot AF allowing the use of focus lock (p. 53). The self-timer is set on the auto-recording mode menu (p. 38) or in the basic section of the multi-function recording mode menu (p. 56).

With the camera on a tripod, compose the picture so the subject is within the focus frames. Press the shutter-release button partway down to lock the exposure and focus (1). Press the shutter-release button all the way down to begin the countdown (2). Because focus and exposure are determined when the shutter-release button is pressed, do not stand in front of the camera when setting up a self-timer image, the camera will focus on you in that position rather than your position when the photograph is taken. Always confirm the focus with the focus signals before beginning the countdown (p. 53).

During the countdown, the self-timer lamp on the front of the camera (3) will start to blink and is accompanied by an audio signal. A few seconds before the exposure, the self-timer lamp will blink rapidly. The lamp will glow steadily just before the shutter fires. To stop the countdown, turn the mode dial to another position. The self-timer drive mode is cancelled after the exposure. The audio signal can be turned off in the custom 1 section of the setup menu (p. 96).

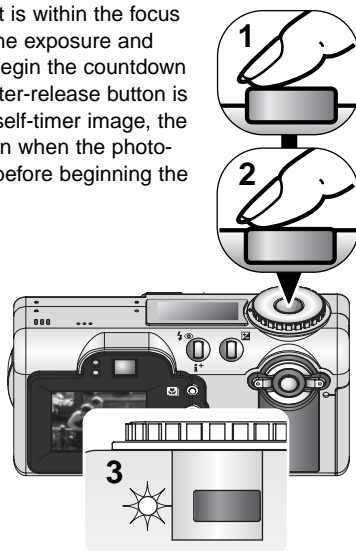

### Shooting tips

The self-timer can be used to minimize camera shake with long exposures. When using the camera on a tripod, photographs of static subjects (landscapes, still-lives, or close-up photographs) can be made with the self-timer. Because no contact is made with the camera during exposure, there is no risk of camera shake caused by the operator.

## Remote control (sold separately)

The IR Remote Control RC-3 allows remote camera operation up to 5m (16 ft.) away. The remote control unit can also be used in movie and audio recording (p. 79). The remote control may not operate with backlit subjects or under fluorescent light.

Place the camera on a tripod, and set the drive mode to self-timer / remote control (p. 38, 56). Arrange the camera and subject to compose the picture.

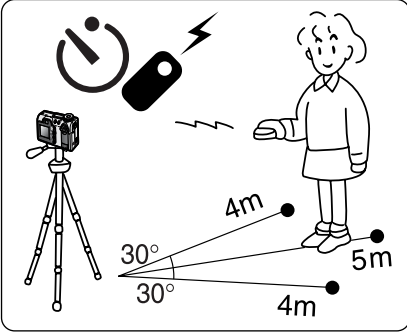

When setting up the camera, make sure the subject will fall within the focus frames. Focus lock cannot be used with the IR remote control. Focus area selection (p. 52) and manual focus (p. 65) can be used.

Point the emitter window of the remote control unit toward the camera and press the release button or the delay button to take the picture.

When the release button is pressed, the self-timer lamp on the front of the camera (1) will blink once before the picture is taken. When the delay button is pressed, the self-timer lamp will blink for two seconds before the picture is taken.

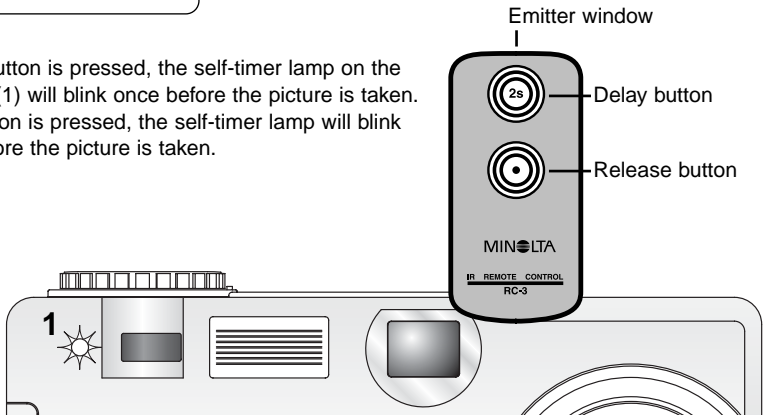

## Continuous advance

The continuous-advance drive mode allows a series of images to be captured while holding down the shutter-release button. Continuous advance acts like a motor drive on a film camera. The number of images that can be captured at one time and the rate of capture depend on the image-quality and image-size setting. The maximum rate of capture is 1.2 fps with the shutter FX on (p. 101), or 1.5 fps with it off. Date imprinting lowers the frame rate. The continuous-advance mode is set on the auto-recording mode menu and in the basic section of the multi-function recording mode menu (p. 56).

When the shutter-release button is pressed and held, the camera will begin recording images until the maximum number has been taken or the shutter button is released. Super-fine images (p. 48) cannot be captured. The built-in flash can be used, but the rate of capture is reduced because the flash must recharge between frames.

Compose the picture as described in the basic recording operation section (p. 26). Press the shutter-release button partway down to lock onto the subject and set the exposure for the series. Press and hold the shutter-release button all the way down (1) to begin taking pictures; focus is locked with the first frame.

The following chart lists the maximum number of images that can be captured with different image-quality and image-size combinations.

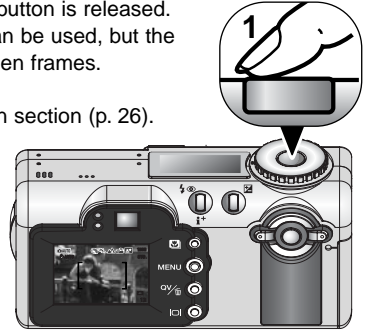

Quality \ Size	2560 X 1920	2048 X 1563	1600 X 1200	640 X 480
Fine	5	8	13	64
Standard	10	16	25	101
Economy	20	30	45	142



## UHS continuous advance

UHS continuous-advance mode allows up to eleven 1280 X 960 images to be captured in one second. The UHS continuous-advance mode is set on the auto-recording mode menu and in the basic section of the multi-function recording mode menu (p. 56).

This mode cannot be used with super-fine image quality, flash illumination, the digital zoom, or Digital Subject Programs. Shutter speeds slower than 1/30th of a second cannot be used. If the red low-battery warning (p. 16) appears, power is insufficient for UHS drive operation and the shutter cannot be released.

When the shutter-release button is pressed and held, the camera will begin recording images until the eleven frames have been taken or the shutter button is released. Very bright light sources in the image may cause streaking. A recorded image may show black areas caused by a loss of data.

Compose the picture as described in the basic recording section (p. 26). Press the shutter-release button partway down (1) to lock the exposure and focus for the series. Press and hold the shutter-release button all the way down (2) to begin taking pictures. The last frame in the series is briefly displayed before the images are saved.

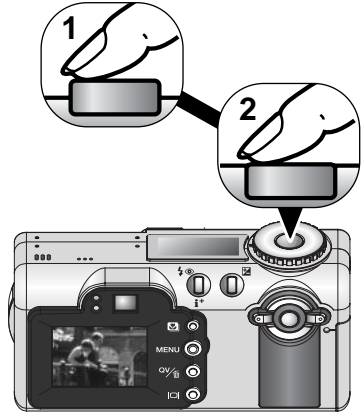



## Bracketing

This mode makes a three-image bracket of a scene. Bracketing is a method of taking a series of images of a static subject in which each image has a slight variation in exposure. The bracketing mode is set on the auto-recording mode menu (p. 38) or in the basic section of the multi-function recording mode menu (p. 56). Brackets cannot be made with super-fine images (p. 48).

The order of the bracket series is normal exposure, underexposure, and overexposure. The exposure bracket can be made in 0.3, 0.5, or 1.0 Ev increments (p. 75). The larger the number, the greater the difference in exposure between the images in the bracketed series.

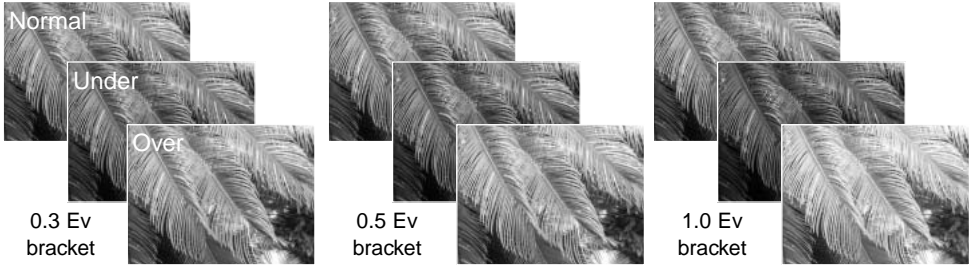

After the bracketing drive mode has been selected on the menu, a screen to choose the bracketing step will be displayed. Use the left and right keys of the controller (1) to select the bracketing increment. Press the central button of the controller (2) to set the value. To change the increment, select the bracketing drive mode again from the menu.

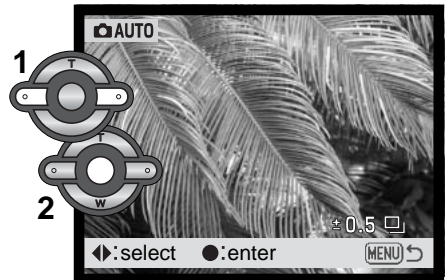

Compose the picture as described in the basic recording operation section (p. 26). Press the shutter-release button partway down (1) to lock onto the subject and set the exposure for the series. Press and hold the shutter-release button all the way down (2) to make the bracket series; three consecutive images will be captured. Focus is locked with the first frame.

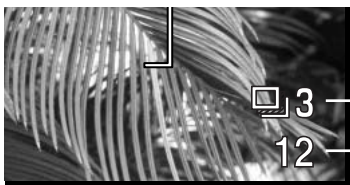
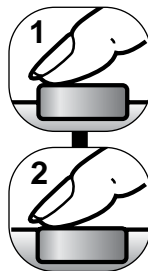

Number of frames in bracketing series

12 — Frame counter



The remaining number of frames in the bracket series is displayed on the monitor next to the bracketing icon. If the memory is filled or the shutter button is released before the series has completed, the camera will reset and the entire bracket must be made again. If the red low-battery indicator appears, the bracketing drive mode is disabled. The flash cannot be used with the bracketing drive mode.

When using exposure compensation (p. 51), the bracketing series will be made in relation to the compensated exposure. Under extreme conditions, one of the bracketed exposures may be inaccurate because it is outside the exposure control range of the camera.

## Image size and image quality

Changing image size affects the number of pixels in each image. The greater the image size, the larger the file size. Choose image size based on the final use of the image - smaller images will be more suitable for web sites whereas larger sizes will produce high-quality prints.

Data panel	LCD monitor	Number of pixels (hor. X vert.)
SIZE ■■■■	2560	2560 X 1920
SIZE ■■■	2048	2048 X 1536
SIZE ■■	1600	1600 X 1200
SIZE ■	640	640 X 480

Image quality controls the rate of compression, but has no effect on the number of pixels in the image. The higher the image quality, the lower the rate of compression and the larger the file sizes. If economical use of the memory card is important, use the economy mode. Standard image quality is sufficient for normal usage. The super-fine mode will produce the highest quality image and the largest image files. A status bar is displayed when large images are saved.

Data panel	LCD monitor		File type
QUAL ■■■■	S. FIN	Super fine - the highest quality image.	TIFF
QUAL ■■■	FINE	Fine - high-quality image.	JPEG
QUAL ■■	STD.	Standard - the default setting.	JPEG
QUAL ■	ECON.	Economy - the smallest file sizes.	JPEG

File formats vary with the image quality setting. Super fine images are saved as a TIFF file. The fine, standard, and economy settings are formatted as a JPEG file. Super fine, fine, standard, and economy files can be recorded as color or monochrome images (p. 68) in the multi-function recording mode.

Image size and quality must be set before the picture is taken. Changes are displayed on the data panel and LCD monitor. Image size and quality must be reset manually. See navigating the auto-recording mode menu section on page 38. In multi-function recording mode, image size and quality are controlled in the basic section of the multi-function recording menu (p. 56).



If image size or quality are changed, the frame counter will display the approximate number of images that can be recorded at that setting on the installed memory card. One memory card can contain images with differing sizes and qualities. The number of images that can be stored on a memory card is determined by the size of the card and the file size of the images. The actual file size is determined by the scene; some subjects can be compressed further than others.

Approximate file sizes.					
Quality	Size	2560 X 1920	2048 X 1536	1600 X 1200	640 X 480
	Super fine	15MB	9.5MB	6.0MB	1.0MB
	Fine	2.5MB	1.6MB	1.0MB	200KB
	Standard	1.3MB	850KB	550KB	150KB
	Economy	650KB	450KB	300KB	100KB
Approximate number of images that can be stored on a 16MB memory card.					
	Super fine	1	1	2	14
	Fine	5	9	14	69
	Standard	11	17	27	100
	Economy	22	32	47	150

## Camera Notes

The frame counter indicates the approximate number of images that can be stored on the memory card at the camera's image quality and size settings. If the settings are changed, the frame counter adjusts accordingly. Because the counter uses approximate file sizes, the actual image taken may not change the counter or may decrease it by more than one. When the frame counter displays zero, it indicates no more images at the image size and quality settings can be captured. Changing those settings may allow more images to be saved to the card.

## Date imprinting

The date of recording can be printed directly on the image. The imprinting function must be activated before the image is taken. Once activated, the date will continue to be imprinted until the function is reset; a yellow bar is displayed behind the frame counter on the monitor to indicate the imprinting function is active. Date imprinting is activated with auto-recording mode menu (p. 38) and with the custom 2 section of the multi-function recording menu (p. 56).



Date-imprinting indicator



The date is imprinted in the lower right corner of the image when viewed horizontally. It is printed directly on the photograph writing over the image information. The date can be imprinted in three formats: year/month/day, month/day/year, and day/month/year. The date and date format are set in the custom 2 section of the setup-mode menu (p. 96).



### Camera Notes

Every time a still image is recorded, it is stored with an exif tag that contains the date and time of recording as well as shooting information. This information can be viewed with the camera in the Quick View or playback mode, or on a computer with the DiIMAGE Viewer software.

## Exposure compensation

The camera exposure can be adjusted to make the final picture lighter or darker by as much as  $\pm 2\text{Ev}$  in  $1/3$  increments. For information on the use of exposure compensation, see page 74. In auto-recording mode, exposure compensation is reset when the mode dial is moved to another position. In multi-function recording mode exposure compensation will remain in effect until it has been reset.

Exposure compensation must be set before the image is captured. When making adjustments to exposure, the amount of compensation is shown next to the exposure-compensation indicator on the monitor. After the setting is made, the shutter-speed and aperture displays will indicate the actual exposure. Because the exposure can be adjusted in fine steps, the shutter speed or aperture value displayed may not change. When set to any value other than 0.0, the exposure-compensation indicator will remain on the data panel and LCD monitor as a warning.

To adjust the exposure, press the exposure-compensation button (1). The exposure-compensation screen will appear.

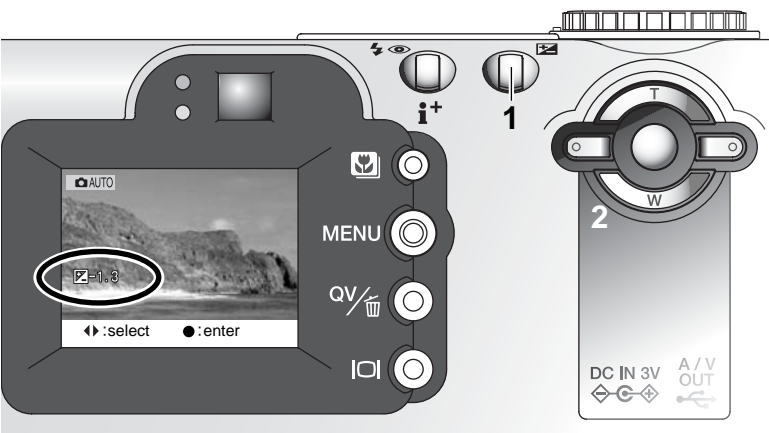

Use the left/right keys of the controller (2) to adjust the exposure-compensation value. Changes to exposure are visible in the live image.

Press the central button of the controller or the exposure-compensation button to set the adjustment.

## Focus area selection

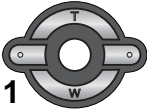

Individual focus areas can be selected. Press and hold the central button of the controller (1) until the Area-AF frame lines change to the spot-focus-area display. Press and hold the controller again to return to the Area-AF frame lines.

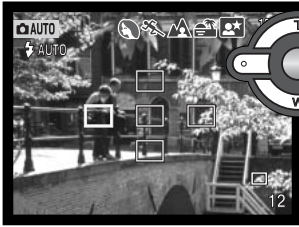

Use the four-way key of the controller (2) to highlight the desired autofocus area; the active area is blue.



Press the shutter-release button partway down (3) or press the central button of the controller (4) to select the area; the other four areas will disappear. Focus and exposure are locked when the shutter-release button is pressed partway down. Press the shutter-release button all the way down to take the picture.

Once a focus area is selected, it will remain active even after the picture has been taken. Only when a focus area has been selected, can the controller be used to operate the zoom.

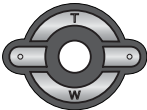
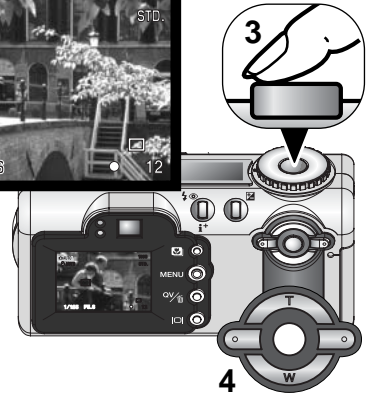

Press and hold the central button of the controller about one second to return to the Area AF focus frames. To use another focus area, repeat the procedure.

# Focus lock

The focus-lock function prevents the AF system from focusing. Focus lock can be used with off-center subjects or when a special focusing situation prevents the camera from focusing (p. 27).







When using focus area selection, place the active focus area on the subject. Press and hold the shutter-release button partway down; the active focus area will turn red and the other areas will disappear. The focus signal should turn white to indicate the focus is locked.

When using single-shot AF with Area AF in the multi-function recording mode, place the subject in the focus frames and press the shutter-release button partway down. The focus frames will disappear and a red AF sensor will indicate the point of focus.



Without lifting your finger from the shutter-release button, recompose the subject within the image area. Press the shutter-release button all the way down to take the picture.

The focus signal in the lower right corner of the LCD monitor and the green focus lamp next to the viewfinder indicate the focus status.

 	<p>Focus icon: white Focus lamp: steady</p>	<p>Focus locked.</p>
 	<p>Focus icon: red Focus lamp: blinking</p>	<p>Cannot focus. The subject is too close or a special situation is preventing the AF system from focusing.</p>

## MULTI-FUNCTION RECORDING – ADVANCED OPERATION

Except for digital subject programs, the basic operation of the camera in multi-function recording mode is identical to the auto-recording mode. Thoroughly familiarize yourself with the previous sections before moving on.

The multi-function recording mode allows greater control over image making. This recording mode gives more control over autofocus and composition. The menu controls are extensive allowing critical adjustments to image qualities such as sharpness, contrast, and color saturation.

### Minolta history

In the center of the Sakai plant in Japan is Okina bridge. In the 15th century, Sakai was a very prosperous free city, and Okina bridge spanned the moat at one of the entrances into the walled town. For centuries, this bridge carried pilgrims on their way to two of Japan's sacred places: the mountain monastery of Koyasan and the great Shinto shrine, Kumano Taisha.

The bridge in the courtyard dates from 1855. In 1968, Minolta offered to remove and preserve the bridge when the city government announced they would fill in the moat for a planned highway. The bridge now spans a specially constructed goldfish pond. The writing on the stone bollard at the front of the bridge prohibits vehicles from crossing.



# Multi-function recording mode display

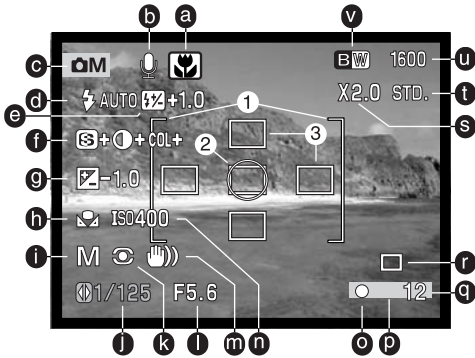

- a. Digital-subject-program indicator (p. 29)
  - b. Microphone indicator
  - c. Mode indicator
  - d. Flash-mode indicator (p. 32)
  - e. Flash-compensation display (p. 66)
  - f. Sharpness, contrast, and color-saturation compensation displays (p. 68)
  - g. Exposure-compensation display (p. 51)
  - h. White-balance indicator (p. 62)
  - i. Exposure-mode indicator (p. 58)
  - j. Shutter-speed display
  - k. Metering-mode indicator (p. 66)
  - l. Aperture display
  - m. Camera-shake warning (p. 33)
  - n. Camera-sensitivity (ISO) display (p. 67)
  - o. Focus signal (p. 27, 53)
  - p. Date-imprinting indicator (p. 50)
  - q. Frame counter (p. 13, 49)
  - r. Drive-mode indicator (p. 41)
  - s. Digital-zoom display (p. 40)
  - t. Image-quality indicator (p. 48)
  - u. Image-size display (p. 48)
  - v. Color-mode display (p. 68)
- 
- 1. Focus frame
  - 2. Spot metering area (p. 66)
  - 3. Spot focus areas (p. 52)

## Navigating the multi-function recording mode menu

In the multi-function recording mode, the menu button (1) turns the menu on and off. The left/right and up/down keys of the controller (2) are used to move the cursor in the menu. Pressing the central button of the controller will enter a setting.



Activate the recording-mode menu with the menu button. The basic tab at the top of the menu will be highlighted. Use the left/right keys of the controller to highlight the appropriate menu tab; the menu will change as the tabs are highlighted.

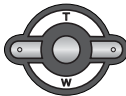

When the desired menu section is displayed, use the up/down keys to scroll through the menu options. Highlight the option whose setting needs to be changed.



With the menu option to be changed highlighted, press the right controller key; the settings will be displayed with the current setting highlighted. To return to the menu options, press the left key.

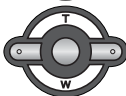

Use the up/down keys to highlight the new setting.



Press the central button of the controller to select the highlighted setting.

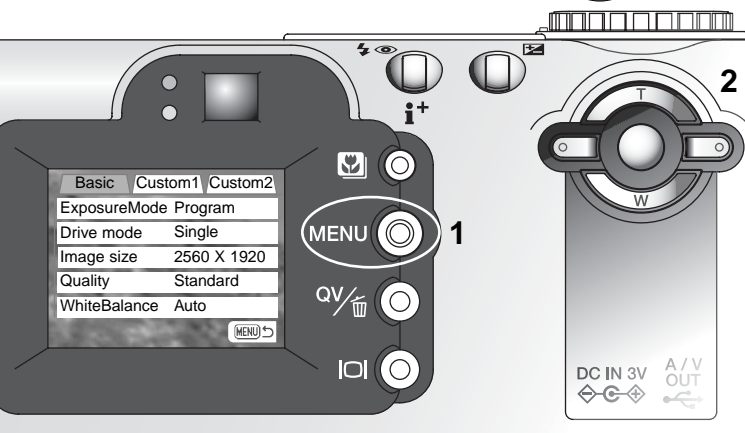

Once a setting has been selected, the cursor will return to the menu options and the new setting will be displayed. To return to the recording mode, press the menu button. Changes made to image size, image quality, digital zoom, and date imprinting will affect the auto-recording mode.



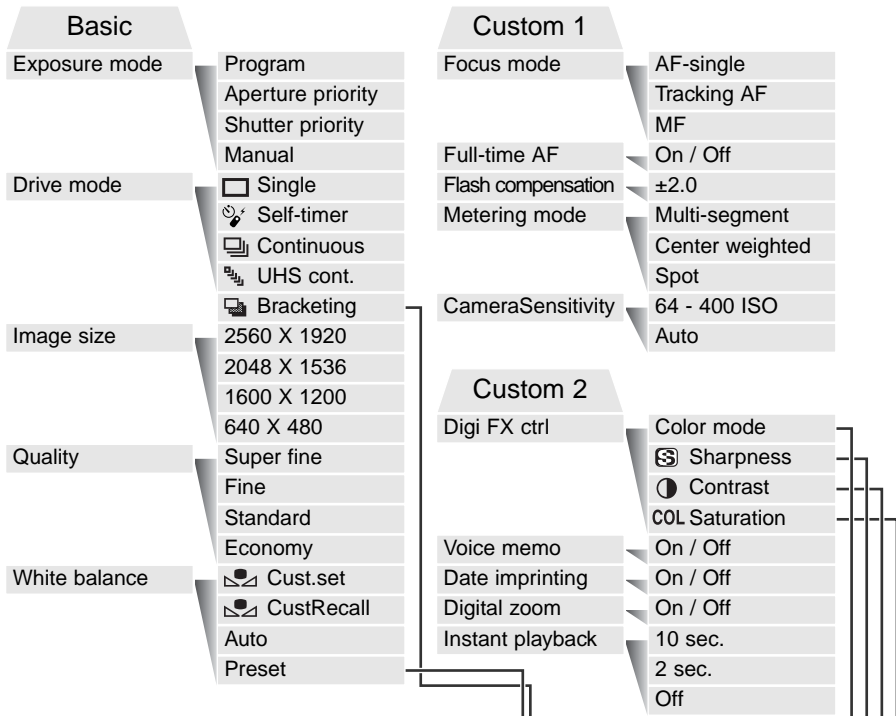

Refer to the auto-recording mode section for details on drive modes (p. 41), image size (p. 48), image quality (p. 48), date imprinting (p. 50), and digital zoom (p. 40).



Use the left/right keys to select the setting and the central button to enter the setting.

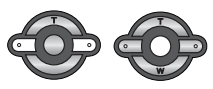

## Exposure modes

### *Programmed AE - P*

The program exposure mode controls both the shutter speed and aperture to ensure perfect exposures. The sophisticated exposure system allows the photographer the freedom to shoot without having to worry about the technical details of exposure settings. The shutter speed and aperture values of the exposure are displayed on the monitor. If shutter speed and aperture displays turn red, the scene is beyond the exposure control range of the camera. This exposure mode is also used in the auto-recording mode, but the exposure-mode indicator is not displayed.

### *Aperture priority - A*

The photographer selects the aperture and the camera sets the appropriate shutter speed to ensure the correct exposure. When aperture priority is selected, the aperture value on the monitor turns blue and a double arrow icon appears next to it. If the LCD monitor is turned off, the aperture value is fixed at the last setting and cannot be changed. The flash mode is set to flash cancel. Fill-flash and fill-flash with red-eye reduction can be selected (p. 32).

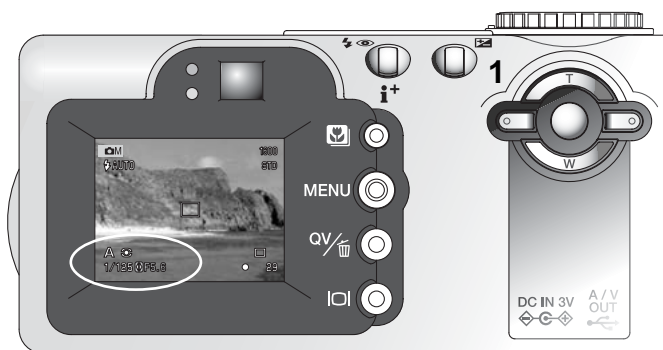
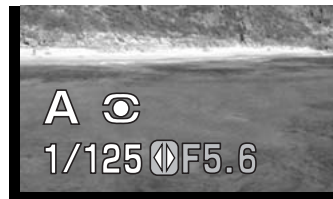

Use the left/right keys of the controller (1) to set the aperture. The aperture value can be changed in half stop increments. Press the shutter-release button to activate the exposure system; the corresponding shutter speed will be displayed on the monitor.

Because the maximum aperture is not the same at the wide-angle and telephoto position, as the lens is zoomed, the aperture will automatically shift. If the aperture value is beyond the shutter-speed range, the shutter-speed display will turn red on the monitor.

## Shutter priority - S

The photographer selects the shutter speed and the camera sets the appropriate aperture to ensure correct exposure. When shutter priority is selected, the shutter speed on the monitor turns blue and a double arrow icon appears next to it. If the LCD monitor is turned off, the shutter speed is fixed at the last setting and cannot be changed. The flash mode is set to flash cancel. Fill-flash and fill-flash with red-eye reduction can be selected (p. 32).

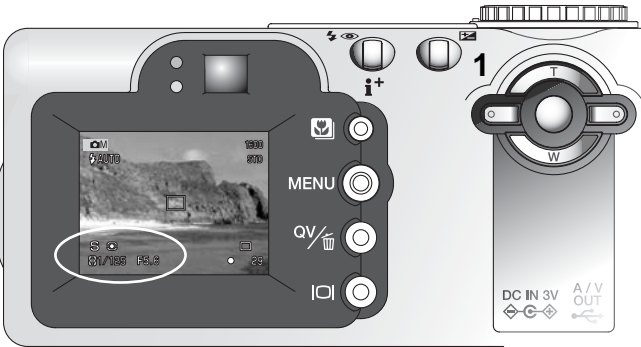

Use the left/right keys of the controller (1) to set the shutter speed. Press the shutter-release button to activate the exposure system; the corresponding aperture will be displayed on the monitor.

The shutter speed can be set between 1/1000 and 15 seconds. If the shutter speed is beyond the aperture range, the aperture display will turn red on the monitor.

## Manual exposure - M

Manual exposure mode allows individual selection of shutter speeds and apertures. This mode overrides the exposure system giving the photographer total control over the final exposure.



The changes made to the exposure will be visible in the live image on the monitor. The monitor shutter-speed and aperture display will turn red if the image is underexposed or overexposed by more than 3 Ev. If the monitor is black, increase the exposure until the image is visible; decrease the exposure if the monitor is white. If the LCD monitor is turned off, the exposure is fixed at the last setting and cannot be changed. When the shutter-release button is pressed partway down, the brightness of the live image may change while the camera focuses.

In manual exposure mode, the auto camera-sensitivity setting will fix the ISO value at 100. The camera sensitivity can be changed in the custom 1 section of the multi-function recording menu (p. 56). The flash mode is set to flash cancel. Fill-flash and fill-flash with red-eye reduction can be selected (p. 32), but the live image will not reflect the flash exposure.

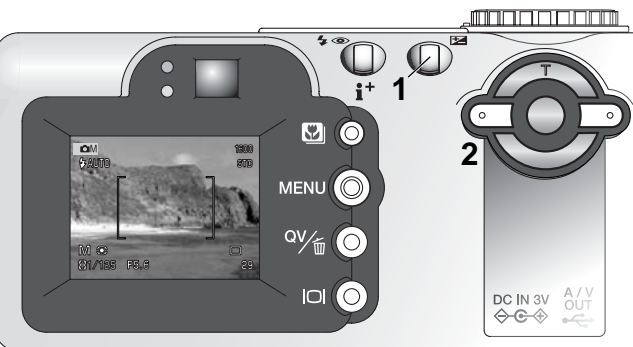

Press the exposure-compensation button (1) to select the aperture or shutter speed; the active display will turn blue.

Use the left/right keys of the controller (2) to change the exposure setting.

# Bulb exposures

Bulb photographs can be taken in the manual-exposure mode. Exposures up to fifteen seconds can be made. A tripod is recommended for bulb exposures. The camera's exposure system cannot be used to calculate bulb exposures. The use of a separate light meter is recommended.

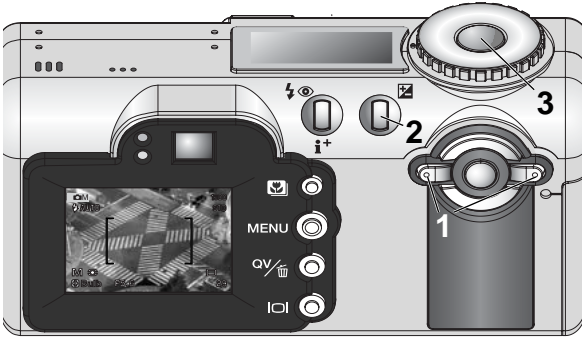

Use the left key of the controller (1) to decrease the shutter-speed value below 15 seconds until "bulb" is displayed.

To set the aperture value, press the exposure-compensation button (2); the aperture display will turn blue. Use the left/right keys of the controller (1) to set the aperture. Noise reduction processing will be applied to the image after the exposure. Noise reduction can be canceled in the custom 2 section of the setup menu (p. 96).

To take the picture, press and hold the shutter-release button (3) for the duration of the exposure. The monitors will be blank during the exposure. Releasing the shutter button will end the exposure.

The optional remote control RC-3 can be used to eliminate the risk of camera shake. Set the drive mode to self-timer / remote control in the basic section of the multi-function mode menu (p. 56). While pointing the remote control toward the front of the camera, press and release either button to begin the exposure; the delay button begins the exposure after two seconds. Press either button again to end it.

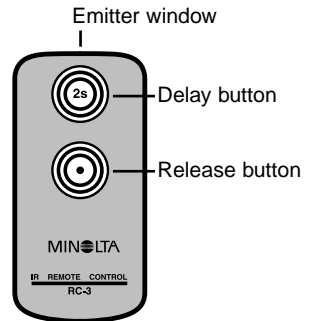

## White balance

White balance is the camera's ability to make different types of lighting appear neutral. The effect is similar to selecting daylight or tungsten film, or using color compensating filters in conventional photography. An indicator will be displayed on the monitor if a setting other than auto white-balance is chosen. White balance is set in the basic section of the multi-function recording mode menu (p. 56).

### *Automatic White Balance*

The automatic white balance compensates for the color temperature of a scene. In most cases, the auto setting will balance the ambient light and create beautiful images, even under mixed-lighting conditions. When the built-in flash is used, the white balance is set for the color temperature of the flash.

### *Preset White Balance*

Preset white-balance settings must be set before the image is taken. Once set, the effect is immediately visible on the LCD monitor.

The built-in flash can be used with preset white-balance settings, but will create a pinkish or blueish cast with the fluorescent and tungsten settings. The flash is daylight balanced and will produce acceptable results with the daylight and cloudy settings.

To apply a preset white-balance setting, select preset from the white balance option in the basic section of the multi-function recording mode menu; the preset setting screen will open.



**Daylight** - for outdoor and sunlit subjects.



**Cloudy** - for overcast outdoor scenes.



**Tungsten** - for incandescent lighting: household filament light bulbs.



**Fluorescent** - for fluorescent lighting: office ceiling lights.

Use the left/right keys of the controller (1) to select the preset setting, an indicator is displayed in the bottom left corner of the screen and the live image shows the effect of the white-balance setting. Press the central button of the controller (2) to apply the setting.

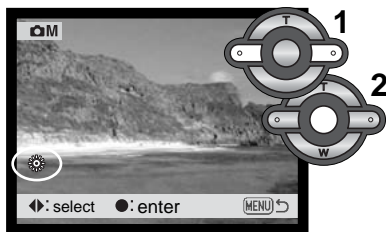

## Custom White Balance



Custom white-balance allows a photographer to calibrate the camera to a specific lighting condition. The setting can be used repeatedly until reset. Custom white balance is especially useful with mixed-lighting conditions or when critical control over color is needed.

The object used to make a calibration must be neutral. A blank piece of white paper is an ideal surface and can easily be carried in a camera bag.

To calibrate the camera, select custom set from the white balance option in the basic section of the multi-function recording mode menu; the custom white-balance calibration screen will open.

Fill the image area with a white object; the object does not need to be in focus. Press the central button of the controller to make the calibration or press the menu button to cancel the routine. The live view will show the effect of the new white balance setting.

The custom setting will remain in effect until another calibration is made or the white-balance setting is changed. If the custom white-balance setting is required again, select custom recall from the white-balance option of the menu; the last custom white-balance setting will be applied to the camera. The same custom white-balance setting is made and accessed from both the multi-function recording mode and the movie mode.

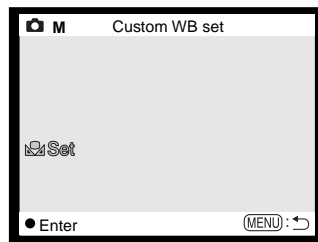

Calibration screen

## Focus modes

This camera has autofocus and manual focus control. The focus mode is set in the custom 1 section of the multi-function recording mode menu (p. 56).

Autofocus will produce excellent results in almost every situation, however, under certain conditions, the autofocus system will not work accurately; see special focusing situations on page 27. In these situations the camera can be manually focused.

### *Single-shot AF*

Single-shot AF focuses on the subject and locks the focus position. This focus mode is ideal for static subjects. Because the focus is locked when the shutter-release button is pressed partway down, single-shot AF can be used when the subject is outside the focus frames, or when a special focusing situation is preventing the autofocus system from focusing. For more on focus lock, see page 53.

Focus Area Selection (p. 52) and the self-timer/remote control drive mode (p. 42) use single-shot AF.

### *Subject Tracking AF*

Place the subject within the Area-AF focus frames and press the shutter-release button partway down; Subject Tracking AF will lock onto the subject and follow the subject's movement in three-dimensional space through the focus area; the AF sensors are displayed to indicate the subject. Subject Tracking AF will not work with fast moving subjects. This is the primary focus mode in the auto-recording mode.

Subject Tracking AF will automatically switch to single-shot AF under very low lighting conditions. Single-shot AF is used with Focus Area Selection (p. 52), the self-time/remote control drive mode (p. 44), and the digital zoom, or when the monitor is turned off (p. 31).

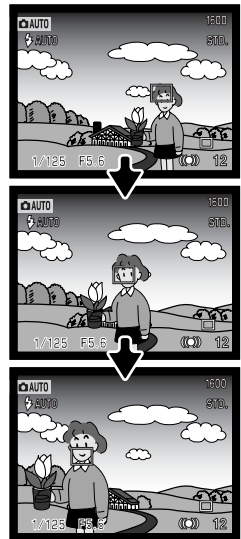



## Manual focus

After setting the camera to the manual focus mode (MF), “ZOOM” and “FOCUS” will appear at the top of the LCD monitor. Press the central button of the controller to switch between the two functions; the function highlighted in blue is active. With “FOCUS” highlighted, use the up/down keys of the controller to focus; the monitor image is automatically magnified so that image sharpness can be judged. Manual focus is disabled when the monitor is turned off; the controller function will automatically switch to the zoom.

Press the controller to switch between focus and zoom (1). The active function is highlighted in blue (2).



Use the up/down keys of the controller to zoom or focus. When focusing, the monitor image is automatically magnified by a maximum of 2.5X depending on the digital zoom setting. The live image returns to normal after two seconds, when zooming, or when the shutter-release button is pressed part-way down.

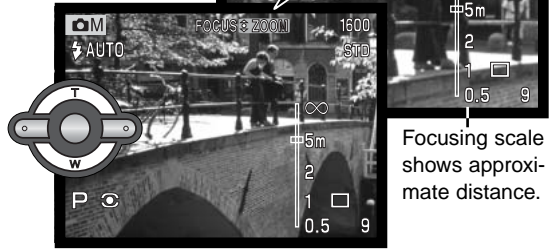

## Full-time AF

With full-time AF active, the autofocus systems continually focuses to keep the monitor image sharp. This also reduces the autofocusing time when taking pictures. Full-time AF can be activated in the custom 1 section of the multi-function recording mode menu (p. 56).

When the monitor is turned off or when the camera is set to manual focus, full-time AF is disabled. Turning the full-time AF function off can help conserve battery power. Full-time AF is always used with the macro subject program as well as the sports action subject program in the auto-recording mode (p. 29).



## Flash compensation

Flash compensation increases or decreases the flash exposure in reference to the ambient exposure by as much as 2 Ev. For information on the use of flash compensation, see page 74.

Select the flash compensation option on the custom 1 section of the multi-function recording mode menu. Use the up/down keys to adjust the degree of compensation (1). Press the central controller button to set this value (2). If any value other than 0.0 is set, an icon will be displayed on the monitor and data panel as a warning.

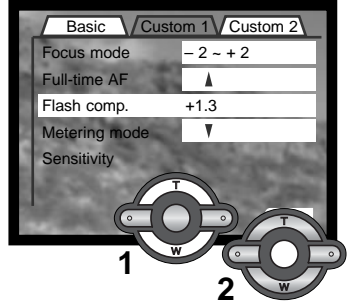

## Metering modes

The icons indicating the metering modes are displayed on the monitor. The metering mode is set in the custom 1 section of the multi-function recording mode menu (p. 56).



**Multi-segment metering:** uses 256 segments to measure luminance and color. This data is combined with distance information to calculate the camera exposure. This advanced metering system will give accurate worry-free exposures in almost all situations.



**Center weighted:** a traditional metering method in film cameras. The system measures light values over the entire image area with emphasis given the central region.



**Spot metering:** uses a small area within the image to calculate the exposure. When this mode is selected, the LCD monitor will automatically activate if off and a small circle will appear in the middle of the live image indicating the measuring area. The spot allows precise exposure measurements of a particular object without being influenced by extremely bright or dark areas within the scene. If the LCD monitor is turned off, the spot-metering mode will remain active.



## Camera sensitivity - ISO

Five camera sensitivity settings can be selected: Auto, 64, 100, 200, and 400; the numerical values are based on an ISO equivalent. ISO is the standard used to indicate film sensitivity: the higher the number, the more sensitive the film. Camera sensitivity is set in the custom 1 section of the multi-function recording mode menu (p. 56).

The auto setting automatically adjusts the camera sensitivity to the light conditions between ISO 64 and 200. When any other setting than auto is used, "ISO" will appear on the data panel, and "ISO" and the set value will be displayed on the monitor.

A specific sensitivity setting can be selected. As the ISO value doubles, the camera sensitivity doubles. Like grain in silver-halide film that increases with speed, noise increases with sensitivity in digital imaging; an ISO setting of 64 will have the least noise and 400 will have the most noise. An ISO setting of 400 may allow the camera to be hand-held in low-light conditions without the need of a flash. The affect of noise with exposures of one second or longer is reduced by the noise-reduction function in the custom 2 section of the setup menu (p. 96).

### *Flash range and camera sensitivity*

The flash range is measured from the CCD. Because of the optical system, the flash range is not the same at the lens' wide-angle position as it is at the telephoto position.

ISO setting	Flash range (wide angle)	Flash range (telephoto)
AUTO	0.5m ~ 3.4m (1.6 ft. ~ 11.1 ft.)	0.5m ~ 2.0m (1.6 ft. ~ 6.6 ft.)
64	0.5m ~ 1.9m (1.6 ft. ~ 6.2 ft.)	0.5m ~ 1.1m (1.6 ft. ~ 3.6 ft.)
100	0.5m ~ 2.4m (1.6 ft. ~ 7.9 ft.)	0.5m ~ 1.4m (1.6 ft. ~ 4.6 ft.)
200	0.5m ~ 3.4m (1.6 ft. ~ 11.1 ft.)	0.5m ~ 2.0m (1.6 ft. ~ 6.6 ft.)
400	0.5m ~ 4.8m (1.6 ft. ~ 15.7 ft.)	0.5m ~ 2.8m (1.6 ft. ~ 9.2 ft.)

## Digital Effects Control

Changes in color, sharpness, contrast, and saturation can be made using the custom 2 section of the multi-function recording mode menu (p. 56). These imaging controls give photographers the ability to maximize the image information at the scene. For example, if a scene is too contrasty, information can be lost in the shadows and highlights; decreasing the contrast will bring out more detail.

Any changes made with these functions are applied to the live image on the monitor. The color mode, sharpness, contrast, and color saturation levels must be set before the image is recorded. These functions can be used individually or in combination. Turning the camera off will not reset these functions; they must be manually reset using the menu.



VIVID  
Color

BW

**Color mode** - to select between Natural Color, Vivid Color, and black and white images. Vivid Color has increased saturation.



**Sharpness** - to accent or soften details in an image in three levels: hard (+), normal, and soft (-).



**Contrast** - to increase or decrease the contrast of the scene in three levels: high (+), normal, and low (-).



**Color saturation** - to accent or subdue the color of a scene in three levels: high (+), normal, and low (-).

To change color, sharpness, contrast, or saturation, select the setting from the Digital Effects Control option in the custom 2 section of the multi-function recording mode menu; the setting screen will open.

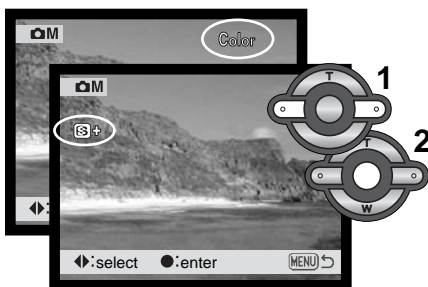

Use the left/right keys of the controller (1) to select the color mode, or level of sharpness, contrast, or saturation; an indicator is displayed on the screen and the live image shows the effect of each setting. Press the central button of the controller (2) to apply the setting.

The setting will remain in effect until it is changed. If sharpness, contrast, or color saturation is set to any setting other than normal, an indicator will be displayed indicating an increase (+) or decrease (-) in the quality selected. If the Vivid Color or black and white is selected, an indicator indicating the color mode will be displayed at the top of the monitor.

Unlike the display on a computer, changes made with sharpness, contrast, and color saturation may be difficult to see on the LCD monitor. However, when viewed with imaging software, the changes will be evident.

## Voice memo

Voice memo allows a fifteen second audio track to be recorded with a still image. The function is activated in the custom 2 section of the multi-function recording menu (p. 56). When the function is active, the microphone indicator is displayed on the data panel and LCD monitor. Voice memo must be set before taking a picture. It will remain in effect until reset.

After an image is captured, a screen will appear indicating the audio recording has started. A bar graph (1) will display the amount of recorded time remaining. The recording will automatically stop when the set time has elapsed. To stop the recording before the total time has elapsed, press the central button of the controller (2).

When used with the continuous-advance or bracketing drive modes (p. 41) the audio file is attached to the last frame of the series. The voice memo can be played back in Quick View or the playback mode (p. 80). Images with voice-memo audio tracks have the audio-track indicator displayed with them.

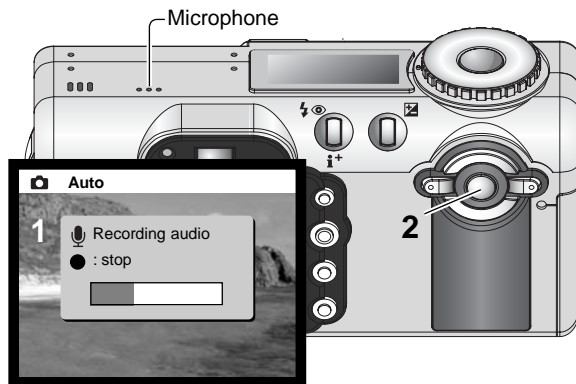

### Recording Tips

When making audio recordings, be careful not to touch or cover the microphone. The quality of the recording is proportional to the subject to microphone distance. For best results, hold the camera approximately 20cm (8in) from your mouth.

## Instant playback

An image can be displayed on the monitor after it is captured. When used with the continuous-advance or bracketing drive modes (p. 41), thumbnails of the last six images in the series will be displayed. Only the last frame in a series is displayed with UHS continuous advance or when using date imprinting.

Instant playback is activated in the custom 2 section of the multi-function recording menu (p. 56). A playback period of two or ten seconds can be selected. When used with voice memo, the audio recording will begin after the image is played back.

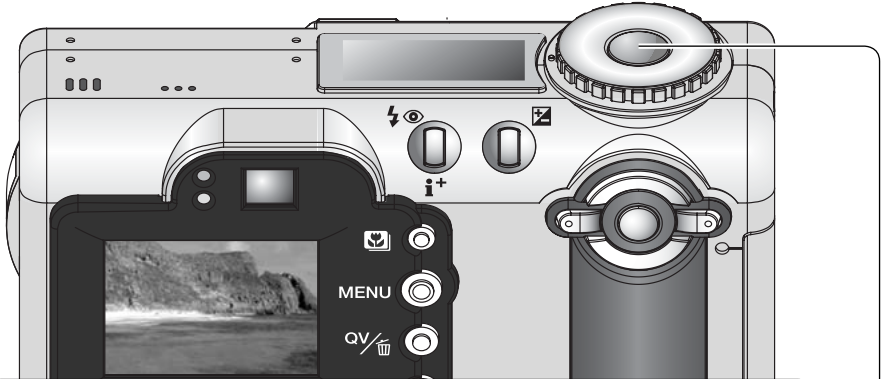

To cancel the playback and save the image before the end of the playback period, press the shutter-release button partway down.

### Camera Notes

Single still images can be previewed immediately after being captured without instant playback active. Simply continue to hold the shutter-release button down after taking the picture to display the image. Release the shutter button to end the playback.

# A SHORT GUIDE TO PHOTOGRAPHY

Photography can be a rewarding pursuit. It is a broad and disciplined field that can take years to master. But the pleasure in making photographs and the joy of capturing a magical moment cannot be compared. This guide is an introduction to some basic photographic principles.

The lens aperture controls not only exposure, but also depth of field; the area between the closest and the furthest object in focus. The larger the aperture value, the greater the depth of field and the longer the shutter speed needed to make the exposure. The smaller the aperture value, the shallower the depth of field and the faster the shutter speed needed to make the exposure. Usually landscape photographs use a large depth of field (large aperture value) to keep the foreground and background in focus, and portraits use a shallow depth of field (small aperture value) to separate the subject from the background.



Depth of field also changes with focal length. The wide-angle position of the lens has a large depth of field; the telephoto position has a shallow depth of field.



The shutter controls not only exposure, but also the ability to stop motion. Fast shutter speeds are used in sport photography to stop action. Slow shutter speeds can be used to show the flow of motion such as water cascading over a waterfall. The use of a tripod is recommended with slow shutter speeds.



The change in aperture and shutter speed is not apparent in the live image. Unlike film cameras, test photographs can be taken and immediately viewed. For critical work, take a test photograph at the set aperture or shutter speed and view the result in Quick View. The image can be deleted if not acceptable and another test image can be taken at a different setting.

## Using exposure and flash compensation

Sometimes the camera's exposure meter is deceived by certain conditions. Exposure compensation can compensate for these situations. For example, a very bright scene, such as a snowy landscape or a white sandy beach, can appear too dark in the captured image. Before taking the picture, adjusting the exposure by +1 or +2 EV will result in an image with normal tonal values.

In this example, the dark scene appears bright and washed-out on the LCD monitor. By decreasing the exposure by  $-1.5$  EV, the richness of the sunset is preserved.



Flash compensation changes the ratio between the ambient and flash exposures. For example, when using the fill-flash to reduce harsh shadows on the subject caused by bright illumination or direct sunlight, flash compensation can change the ratio between the highlights and shadows. The fill-flash will affect the darkness of the shadows without affecting the area illuminated by the main light source. By decreasing the flash output with a negative Ev setting, the shadows will receive less light and be deeper, but will bring out shadow details that would be lost without the flash. Increasing the flash output by using a positive Ev setting will soften and can even nearly eliminate shadows.



Positive compensation



No compensation



Negative compensation

# What is an Ev? What is a stop?

Ev stands for exposure value. The term stop comes from the name of aperture plates used in early lenses. A change of one Ev or one stop will adjust the exposure calculated by the camera by a factor of two.

Change in Ev	Change in stops	Adjustment to exposure
+2.0 Ev	+2 stops	4X as much light
+1.0 Ev	+1 stop	2X as much light
0.0 Ev	Calculated exposure	
-1.0 Ev	-1 stop	1/2 as much light
-2.0 Ev	-2 stops	1/4 as much light

## Exposure latitude

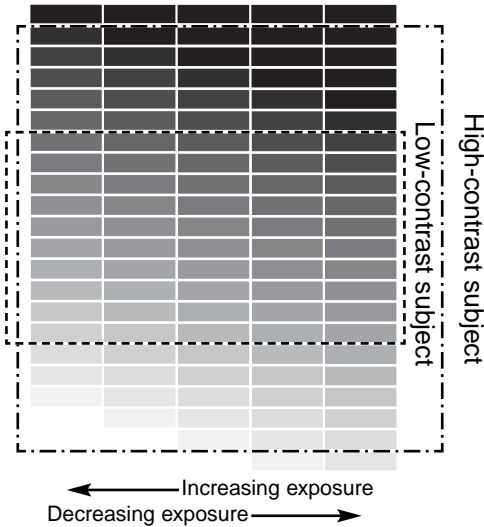

How much the exposure can be adjusted using exposure compensation or manual exposure before there is a loss of image quality depends on subject contrast. High-contrast subjects have a great range of tones, deep shadows and brilliant highlights, whereas low-contrast subjects have a limited tonal range, such as a landscape on an overcast day.

High-contrast subjects have a much narrower exposure latitude before the shadows block up from underexposure or the highlights washout from overexposure. To ensure the best possible exposure for a subject, brackets (p. 46) can be made. Some scenes are beyond the contrast range of the CCD. In those situations, expose for the main subject of the image.

# MOVIE AND AUDIO RECORDING

## Recording movies

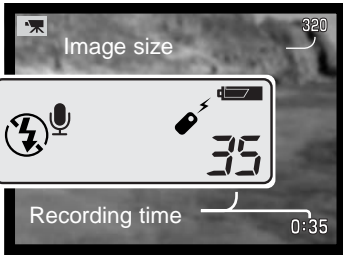

This camera can record digital video with sound. Total recording time varies with the image size. See the navigating the movie menu section on page 78. In movie recording, some functions can be used, some are fixed, and some are disabled. See the notes section on page 79.

Before recording, the data-panel and monitor frame counters will show the maximum time in seconds that can be recorded on the next movie clip.

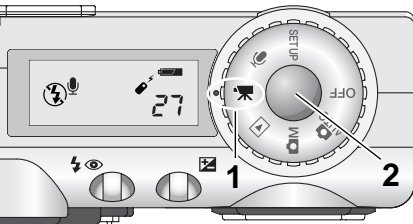

Shooting digital video is simple. Set the main dial to movie recording (1). Frame the picture as described in the basic recording operation section (p. 26). Press the shutter-release button partway down to lock the focus (2). Press the shutter-release button all the way down and release to start recording.



Countdown in seconds

During recording, the focus is fixed, but a stepless 4X digital zoom is available. The camera will continue to record until the recording time is used or the shutter-release button is pressed again. When recording, the data panel and monitor frame counters will count down the remaining time.

Recording indicator

# Recording audio

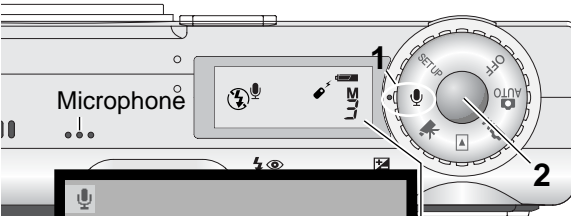

Audio can be recorded without an image. About 30 minutes of audio can be stored on a 16MB memory card. Audio is recorded at approximately 8KB/s. A maximum of 180 minutes can be recorded at one time; the optional AC adapter is required for long recordings.

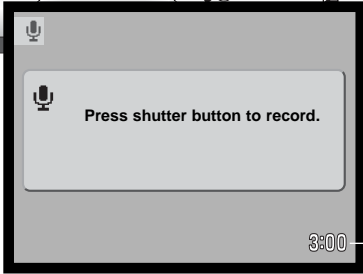

Turn the mode dial to the audio-recording position (1); a blue screen is displayed. In stand-by, the monitor and data panel show the approximate recording time available. Above the data panel frame counter, the unit of the remaining time is displayed: M - minute, S - second.

Remaining recording time



To begin recording, press and release the shutter button (2). A bar graph (3) and the frame counter will display the amount of recorded time. The recording will stop when the shutter-release button is pressed again or the remaining time has elapsed.

When making audio recordings, be careful not to touch or cover the microphone. The quality of the recording is proportional to the subject to microphone distance. For best results, hold the camera approximately 20cm (8in) from your mouth.

Recording countdown

## Camera Notes

When turning the camera on, the lens can be prevented from extending. Press and hold the down the central key of the rear controller when turning the mode dial from off to the audio recording position.

## Navigating the movie menu



With the mode dial set to the movie recording position, press the menu button to activate the menu.

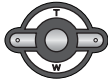

Use the up/down keys to highlight the option whose setting needs to be changed.



Press the right controller key to display the settings; the current setting is indicated by an arrow. To return to the menu options, press the left key.



Use the up/down keys to highlight the new setting.



Press the central button of the controller to select the highlighted setting.

Once a setting is made, the cursor returns to the menu options and the new setting is displayed. To return to the movie mode, press the menu button.

Image size not only affects the resolution of the movie image, but also changes the maximum length of the movie clip. The maximum recording time for a 320 X 240 size movie is 3 minutes at approximately 340 KB/sec, and 20 minutes at approximately 85 KB/sec for a 160 X 120 movie. A 16 MB memory card can contain approximately 42 seconds of digital video recorded at 320 X 240 or 170 second at 160 X 120.

See page 62 for information on white balance.

The movie mode option selects the type of movie recorded. Standard produces a normal movie clip. Night Movie uses high camera sensitivity to record under low light levels. Image quality is lower with Night Movies because of the higher sensitivity.

Basic	
Image size	320 X 240 160 X 120
White balance	Cust set CustRecall Auto Preset
Movie mode	Night movie STD. movie

# Notes on movie recording

In movie recording, some functions can be used, some are fixed, and some are disabled, see chart. Image size, white balance, and movie mode can be selected with the movie menu.

When the red low-battery indicator appears (p. 16), power is insufficient for movie recording. The writing speed of the memory card in use may prevent an entire movie clip from being recorded.

Focus mode	– Single-shot AF (fixed)
Autofocus area	– Area AF focus frames (fixed)
Exposure mode	– Program (fixed)
Metering mode	– Multi-segment (fixed)
Camera sensitivity	– Auto (fixed)
Digital zoom	– 4X (fixed)
Exposure compensation	– Available (p. 51)
Flash	– Disabled
Digital subject programs	– Disabled

## Remote movie and audio recording with the RC-3

The RC-3 remote control (sold separately) can be used to record movie clips and audio tracks (p. 77) from up to 5m (16ft) away. Simply point the remote control toward the camera and use the release or delay button to start and stop the recording.

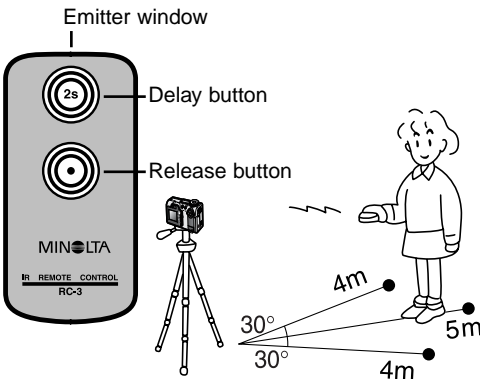

When the release or delay button is pressed, the self-timer lamp will blink before the camera starts to record; there is a two second delay when the delay button is used before the lamp glows to indicate recording. Both buttons will stop the recording when pressed. The remote control may not operate with backlit subjects or under fluorescent light.



# PLAYBACK MODE - ADVANCED OPERATION

The basic functions in this mode are described in the basic playback section on pages 34 through 37. This section covers how to playback movie clips and audio tracks as well as the advanced function on the playback menu.

## Camera Notes

When turning the camera on, the lens can be prevented from extending. Press and hold the down the central key of the rear controller when turning the mode dial from off to the playback position.

## Playing back voice memos and audio captions



Voice memos (p. 70) and audio captions (p. 87) can be played back in Quick View and the playback mode. When one of these audio tracks is attached to a still image, the audio-track indicator will be displayed at the bottom of the monitor.



Press the central button of the controller to start the audio playback.



Playback time is displayed on a bar at the top of the image. The display will return to Quick View or the playback mode when the audio track finishes.

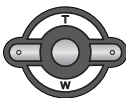

During playback, the up/down keys of the controller adjust the volume.



Press the menu button to cancel the playback.



# Playing back movies and audio recordings

Movie clips and audio recordings are played back the same way. Use the left/right keys of the controller to display the movie or audio file; audio files are displayed with a blue screen. These files cannot be played back in Quick View.

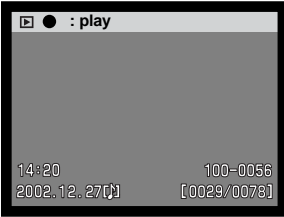

Audio file



Press the center of the controller to play back a movie or audio file.

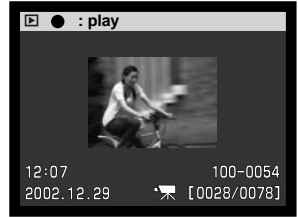

Movie file

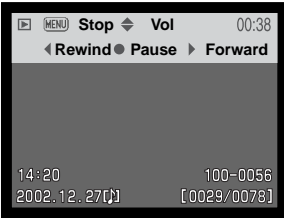

Press the controller to pause the movie or audio playback; press the controller again to resume the playback.

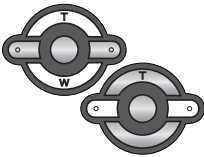

During playback, the up/down keys adjust the volume and the left/right keys rewind and fast forward the recording.



Press the display button to view the movie with or without the guidance bar.



To cancel the playback, press the menu button.

# Navigating the playback-mode menu

In playback mode, the menu button turns the menu on and off. The left/right and up/down keys of the controller are used to move the cursor in the menu. Pressing the central button of the controller will enter a setting.



Activate the playback menu with the menu button. The basic tab at the top of the menu will be highlighted. Use the left/right keys of the controller to highlight the appropriate menu tab; the menu will change as the tabs are highlighted.

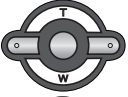

When the desired menu section is displayed, use the up/down keys to scroll through the menu options. Highlight the option whose setting needs to be changed.



With the menu option to be changed highlighted, press the right controller key; the settings will be displayed with the current setting highlighted. To return to the menu options, press the left key.

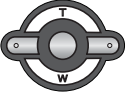

Use the up/down keys to highlight the new setting. If "Enter" is displayed, press the center button to continue.



Press the central button of the controller to select the highlighted setting.

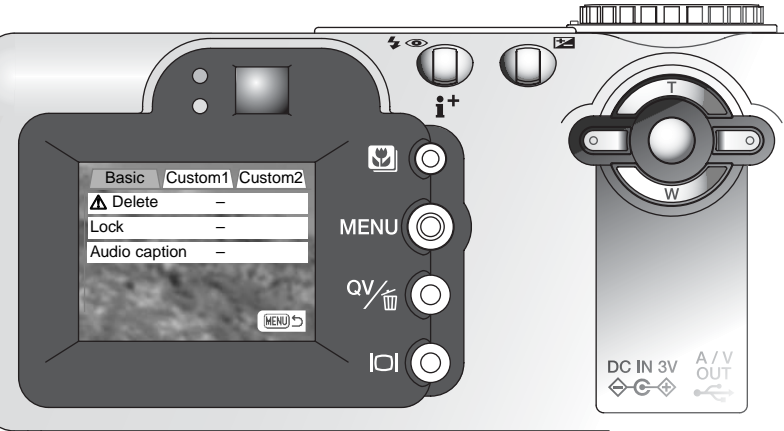

Once a setting has been selected, the cursor will return to the menu options and the new setting will be displayed. Changes can continue to be made. To return to the playback mode, press the menu button.

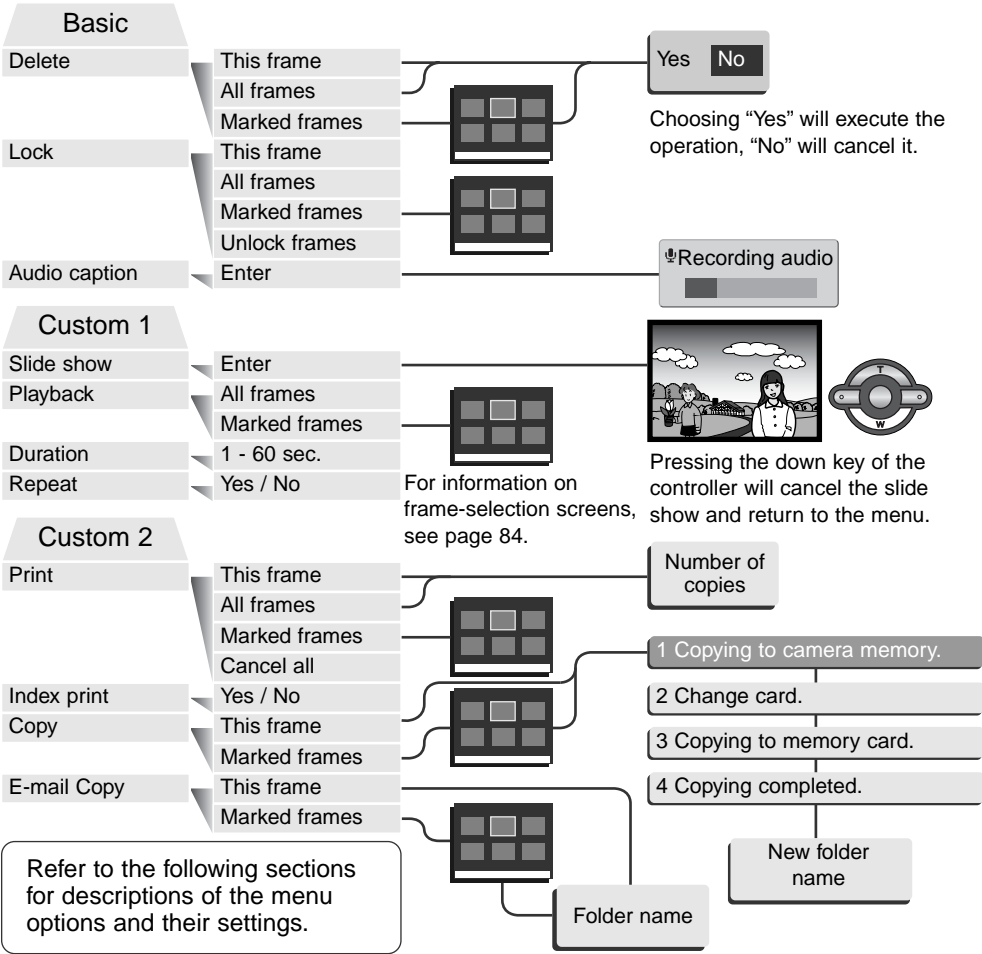

## Frame-selection screen

When a marked-frames setting is chosen on a menu, the frame selection screen will appear. This screen allows multiple images to be chosen.



The left/right keys of the controller move the yellow border to select the image.



The menu button cancels the screen and any operation made.

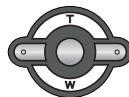
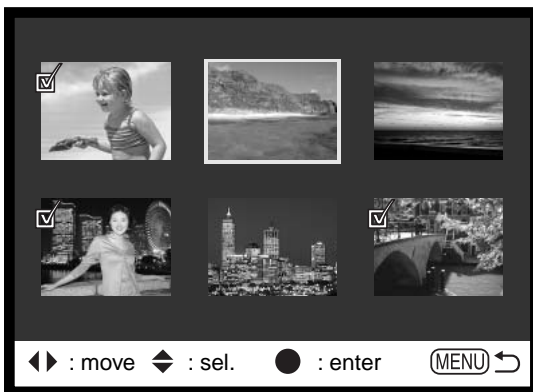

The up key of the controller selects the frame; when selected, an icon will appear next to the image. The down key will deselect the image removing the icon.



The garbage-can icon indicates the image is selected for deletion.



The key icon indicates the image is locked or selected to be locked.



The check icon indicates the image is selected for the slide show or to be copied.



The printer icon indicates the image is selected for printing. The number next to the icon shows the number of copies requested.



Press the central button of the controller to complete the operation.

## Deleting files



Deleting permanently erases the file. Once deleted, a file cannot be recovered. Care should be taken when deleting images.

Single, multiple, or all files on the memory card can be deleted in the basic section of the playback-mode menu (p. 82). Before a file is deleted, a confirmation screen will appear; choosing “Yes” will execute the operation, “No” will cancel the operation. The delete option has three settings:

<b>This frame</b>	The file displayed or highlighted in playback mode will be deleted.
<b>All frames</b>	All unlocked files will be deleted.
<b>Marked frames</b>	To delete multiple files. When this setting is chosen, the frame-selection screen will be displayed. Use the left/right keys of the controller to highlight the first file to be deleted. Pressing the up key will mark the thumbnail with the garbage-can icon. To deselect a file for deletion, highlight it with the yellow border and press the down key; the garbage-can icon will disappear. Continue until all the files to be deleted are marked. Press the central button of the controller to continue (the confirmation screen will appear), or press the menu button to cancel the operation and return to the playback menu. On the confirmation screen, highlighting and entering “Yes” will delete the marked files.

The delete function will only erase unlocked files. Locked files must be unlocked before they can be deleted.

## Locking files

Single, multiple, or all files can be locked. A locked file cannot be deleted by either the playback-mode menu functions or the QV/delete button. Important images and audio recordings should be locked. The lock function is in the basic section of the playback menu (p. 82). The lock option has four settings:

<b>This frame</b>	The file displayed or highlighted in playback mode will be locked.
<b>All frames</b>	All files on the memory card will be locked.
<b>Marked frames</b>	To lock or unlock multiple files. When this setting is chosen, the frame-selection screen will be displayed. Use the left/right keys of the controller to highlight the file to be locked. Pressing the up key will mark the file with the key icon. To unlock a file, highlight it with the yellow border and press the down key; the key icon will disappear. Continue until all the files to be locked are marked. Press the central button of the controller to lock the marked thumbnails, or press the menu button to cancel the operation and return to the playback menu.
<b>Unlock frames</b>	All files on the memory card will be unlocked.

Locking a file will protect it from a delete function. However, the formatting function (p. 98) will erase all files on a memory card whether locked or not.

# Audio captioning

A still image can have a fifteen-second audio caption attached to it. This function will also replace a voice-memo audio track recorded with an image. Audio captions cannot be attached to movie clips, nor can they overwrite audio recordings.

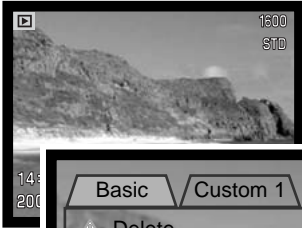

Display the image to which the audio caption will be attached. If the image is locked, unlock it using the basic section of the playback menu (p. 82).

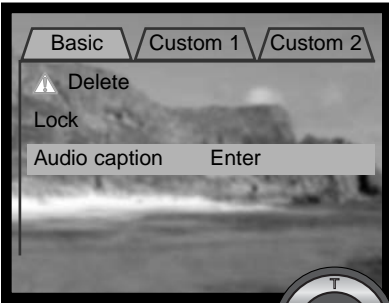

On the playback menu, highlight the enter setting in the audio-caption option.

Press the central button of the controller (1) to start recording. If an audio track is already attached to the image, a confirmation screen will appear. Choosing and entering “Yes” will start the audio caption recording replacing the previous audio track. “No” will cancel the audio-caption operation.

1



The audio caption can be stopped during the fifteen-second recording period by pressing the central button of the controller (1).

## Slide Show

The custom 1 section of the playback-mode menu controls the slide-show function. This function automatically displays all still images on the memory card in order.



Press the central button of the controller to pause and restart the slide show presentation.



To cancel the presentation, press the down key.

### Camera Notes



The presentation can be viewed without image information. Before opening the playback menu, press the display button to turn off the information display.



Menu options	Settings	
Slide show	Enter	To start the slide-show presentation. Pressing the central button of the controller will pause the presentation. During the slide show, press the down key of the controller to stop the presentation and return to the playback-mode menu.
Playback	All frames	To select all the images on the memory card to be displayed in the slide-show presentation.
	Marked Frames	To select specific images to be displayed in the slide-show presentation. When this setting is chosen, the frame-selection screen will be displayed. Use the left/right keys of the controller to highlight the image to be included in the presentation. Pressing the up key will mark the image with a check icon. To deselect a marked image, highlight it with the yellow border and press the down key; the check icon will disappear. Continue until all the images have been edited. Press the controller to set the marked frames, or press the menu button to cancel the operation and return to the playback menu.
Duration	1 - 60s.	To select the period each image will be displayed during the slide show.
Repeat	Yes / No	Selecting "Yes" will cause the slide show to repeat until it is canceled using the down key of the controller. "No" will end the slide show presentation and return to the playback-mode menu when all the images have been displayed once.

## About DPOF

This camera is supported by DPOF™ version 1.1. The DPOF (Digital Print Order Format) allows direct printing of still images from digital cameras. After the DPOF file is created, the memory card is simply taken to a photofinishing service or inserted into the memory-card slot of DPOF compatible printers. When a DPOF file is created, a misc. folder is automatically created on the memory card to store it (p. 112).

## Creating a DPOF Print Order

The print menu option is used to set an order for standard prints from still images on the memory card. Single, multiple, or all images can be printed. Print orders are created in the custom 2 section of the playback-mode menu (p. 82). The print menu option has four settings:

<b>This frame</b>	To create a DPOF file for the displayed or highlighted image.
<b>All frames</b>	To create a DPOF file for all images on the memory card.
<b>Marked frames</b>	To choose a group of images to be printed or when the number of copies of each image varies. When selected, the frame selection screen will appear. Use the left/right keys of the controller to highlight an image to be printed. Pressing the up key will mark the image with the printer icon. The number next to the icon indicates the number of copies that will be printed. Pressing the up key will increase the number of copies, pressing the down key will decrease the number. A maximum of nine copies can be ordered. To deselect an image for printing, press the down key until the number of copies reaches zero and the printer icon disappears. Continue until all the images to be printed are marked. Press the central button of the controller to create the DPOF file, or press the menu button to cancel the operation and return to the playback menu.
<b>Cancel all</b>	To delete the DPOF file.

When the this-frame or all-frames setting is chosen, a screen will appear requesting the number of copies of each image; a maximum of nine copies can be ordered. Use the up/down keys of the controller to set the required number of copies. If the all-frames setting was used to create a print order, any additional images recorded afterwards will not be included in the order.

DPOF files created with another camera will be canceled. After the pictures have been printed, the DPOF file will still remain on the memory card and must be canceled manually.

## Ordering an Index Print

To create an index print of all the images on the card, select "Yes."  
To cancel an index print, simply change the setting to "No."

If an index-print order is created, any additional images saved afterwards on the card will not be included in the index print. The number of images printed per sheet differs between printers. The information printed with the thumbnails can vary.



### Camera Notes

The DPOF print file, including the index print, can be directly printed from the camera with Epson USB DIRECT-PRINT compatible printers. For instructions on how to connect and use the camera with these printers, see page 121.

## Copy and E-mail Copy

The copy function makes exact copies of image, audio, or movie files and can store the copied data on another memory card. E-mail Copy makes a standard 640 X 480 (VGA) JPEG copy of an original still image so that it may be easily transmitted by e-mail. If an economy image is selected for E-mail Copy, the image quality will not change. E-mail copies can only be copied to the original card. The copy functions are selected in the custom 2 section of the playback-mode menu (p. 82).

When a copy function is used, a folder is created for the files (p. 112); copy files are placed in a folder with a name ending in CP, and E-mail Copy images are placed in a folder ending in EM. Images with voice memos are copied with their audio files. Copies of locked images are unlocked. DPOF information is not copied.

The copy and E-mail copy functions have two menu options:

<b>This frame</b>	To copy the file displayed or highlighted in playback mode.
<b>Marked frames</b>	To copy single or multiple files. When selected, the frame-selection screen will appear; highlight the file to be copied with the yellow border and then press the up key of the controller to mark it with the check icon. To deselect a file to be copied, highlight the selected thumbnail and press the down key; the check icon will disappear. Continue until all the files to be copied are marked. Press the central button of the controller to continue, or press the menu button to cancel the operation and return to the playback menu.

Up to 15 MB of data can be copied. If too many images have been selected, a warning will appear and the copy routine will be canceled. Divide the number of images into two or three batches. The amount of data can be converted into E-mail copies depends on the free space remaining on the memory card.

## Copy

When the image(s) to be copied are selected, a screen with four messages is displayed. The messages are highlighted during the copying procedure.

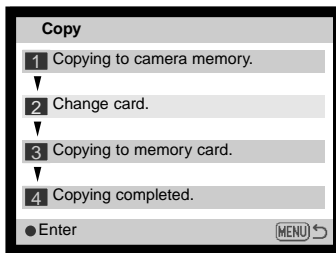
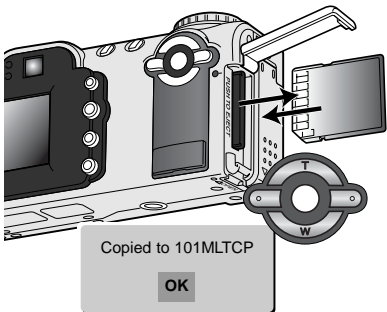

When the change-card message is highlighted, remove the camera's memory card and insert the card to which the image should be copied. Press the central button of the controller to continue or the menu button to cancel the copy operation.

After the copy-completed message is highlighted, a new screen will appear to indicate the name of the new folder containing the copied images; press the central button of the controller to return to the menu.

## E-mail Copy

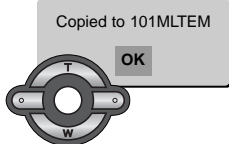

When the image(s) to be converted to an e-mail file are selected, the copy routine will begin and a screen will appear indicating the name of the folder containing the copied images; press the central button of the controller to return to the menu. The same folder is used to store e-mail copies until the number of images exceeds 9,999.

## Camera Notes

The copy-unsuccessful message will appear when one or all of the images could not be copied. Check the memory card to see which files were copied and then repeat the procedure for the uncopied images.

## Viewing images on a television

It is possible to view camera images on your television. The camera has a video-out terminal to make the connection using the supplied AV cable. The camera is compatible with the NTSC and PAL standards. The video-output setting can be checked and set in the custom 2 section of the setup menu (p. 82).

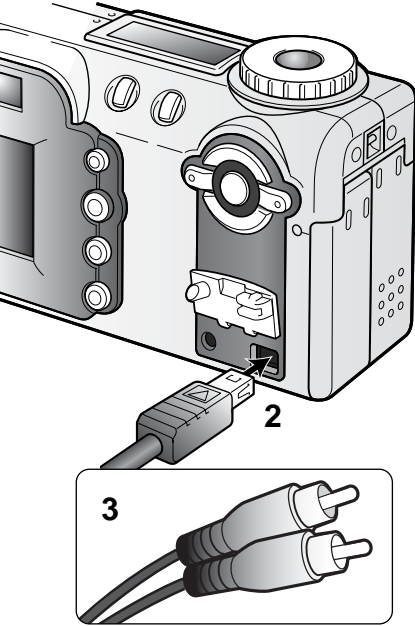

1. Turn off the television and the camera.
2. Insert the mini-plug end of the AV cable into the camera's AV-out terminal.
3. Plug the other end of the AV cable into the video and audio input terminals on the television. The yellow plug is for the video output. The white plug is for the monaural audio output.
4. Turn the television on.
5. Change the television to the video channel.
6. Turn the camera's mode dial to the playback position. The camera's monitors will not activate when the camera is attached to a television. The playback-mode display will be visible on the television screen.
7. View images as described in the playback section.

# SETUP MODE

## CONTROLLING THE CAMERA'S OPERATION

The setup mode is used to control the camera's functions and operation. The navigating the setup menu section covers the operation of the menu. The section is followed by detailed descriptions of the settings.

### Camera Notes

When turning the camera on, the lens can be prevented from extending. Press and hold the down the central key of the rear controller when turning the mode dial from off to the setup position.

### Minolta History



Innovation and creativity has always been a driving force behind Minolta products. The Electro-zoom X was purely an exercise in camera design. It was unveiled at Photokina in Germany in 1966.

The Electro-zoom X was an electronically controlled aperture-priority mechanical SLR with a built-in 30 - 120mm f/3.5 zoom lens giving twenty 12 X 17mm images on a roll of 16mm film. The shutter-release button and battery chamber are located in the grip. Only a few prototypes were built making it one of Minolta's rarest cameras.

## Navigating the setup menu

To access the menu, simply turn the mode dial to the setup position. The left/right and up/down keys of the controller are used to move the cursor in the menu. Pressing the central button of the controller will enter a setting.

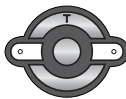

The basic tab at the top of the menu will be highlighted. Use the left/right keys of the controller to highlight the appropriate menu tab; the menu will change as the tabs are highlighted.



When the desired menu section is displayed, use the up/down keys to scroll through the menu options. Highlight the option whose setting needs to be changed.



With the menu option to be changed highlighted, press the right controller key; the settings will be displayed with the current setting highlighted. To return to the menu options, press the left key.

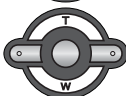

Use the up/down keys to highlight the new setting. If "Enter" is displayed, press the central button to continue.



Press the central button of the controller to select the highlighted setting.

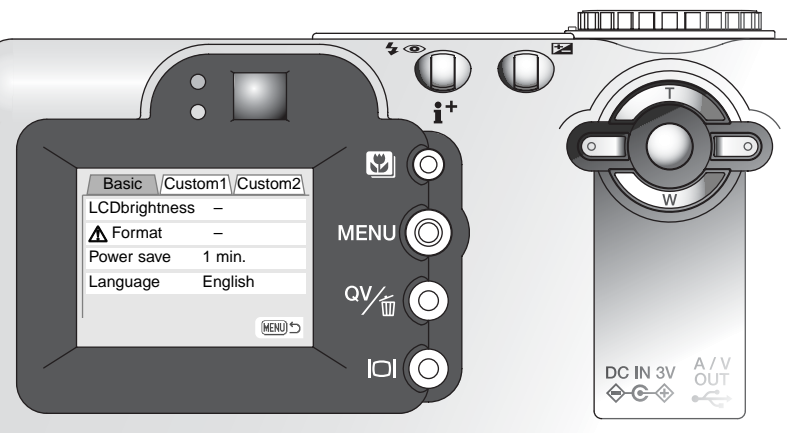

Once a setting has been selected, the cursor will return to the menu options and the new setting will be displayed. You can continue to make other settings.



## Basic

LCD brightness	Enter
Format	Enter
Power save	1, 3, 5, 10 min.
Language	Japanese
	English
	Deutsch
	Français
	Español

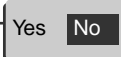

Choosing "Yes" on the confirmation screens will execute the operation, "No" will cancel it.

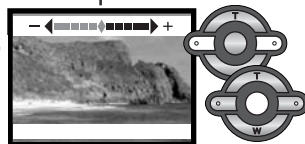

Use the left/right keys to adjust the monitor brightness. Press the central button to set the level.

## Custom 1

File # memory	On / Off
Folder name	Standard form
	Date form
Audio signals	1
	2
	Off
Shutter FX	1
	2
	Custom
	Off
Volume	Custom record
	1 (Low) - 3 (High)

Refer to the following sections for descriptions of the menu options and their settings.

## Custom 2

Reset default	Enter
Noise reduction	On / Off
Date/Time set	Enter
Date format	YYYY/MM/DD
	MM/DD/YYYY
	DD/MM/YYYY
Video output	NTSC
	PAL

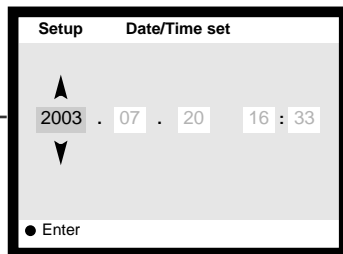

On the date/time setting screen, use the left/right keys of the controller to select the year, month, day, hour, or minute. The up/down keys are used to change the value. Press the central button of the controller to set the calendar and clock.

## LCD monitor brightness

The brightness of the LCD monitor can be set in eleven levels. The brightness setting screen is opened from the basic section of the setup menu (p. 96). Use the left/right keys of the controller (1) to adjust the brightness. The monitor image will change accordingly. Press the central button of the controller (2) to set the brightness level.

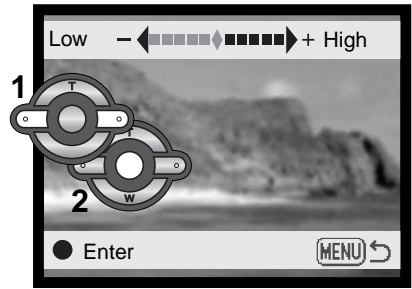

## Formatting memory cards



When a memory card is formatted, all data on the card is erased.

The formatting function is used to erase all data on a memory card. Before formatting a memory card, copy the data to a computer or storage device. Locking images will not protect them from being deleted when the card is formatted. Always format the memory card using the camera; never use a computer to format a card.

When the format option is selected and entered in the basic section of the setup menu (p. 96), a confirmation screen will appear. Choosing “Yes” will format the card, choosing “No” will cancel the formatting operation. A screen will appear to indicate the card has been formatted.

If the card-not-recognized message appears, the inserted card in the camera may need to be formatted. A memory card used in another camera may also have to be formatted before being used. If the unable-to-use-card message appears, the card is not compatible with the camera and cannot be formatted.

## Auto power save

To conserve battery power, the camera will shut down if no operation is made within a certain period. The length of the auto-power-save period can be changed to 1, 3, 5, or 10 minutes. When the camera is connected to a computer, the auto-power-save period is fixed at ten minutes.

## Language

The language used in the menus can be changed. The language is selected in the basic section of the setup menu.

## File number (#) memory

If file number memory is selected, when a new folder is created, the first file stored in the folder will have a number one greater than the last file saved. If the file number memory is disabled, the image file number will be 0001. File number memory is activated in the custom 1 section of the setup menu.

If file number memory is active and the memory card is changed, the first file saved to the new card will have a number one greater than the last file saved on the previous card if the new card does not contain an image with a greater file number. If it does, the file number of the new image will be one greater than the greatest on the card.

## Folder name

All recorded images are stored in folders on the memory card. Folder names come in two formats, standard and date.

Standard folders have an eight character name. The initial folder is named 100MLT17. The first three digits are the folder's serial number, which will increase by one each time a new folder is created. The next three letters refer to Minolta, and the last two numbers indicate the camera used; 17 indicates a DiIMAGE F300.



100MLT17  
(Standard)

A date folder name also starts with the three digit serial number and is followed by one register for the year, two registers for the month, and two registers for the day: 101YMMDD. The folder 10130412 was created in 2003 on April 12th.



10130412  
(Date)

With the date folder format selected, when an image is recorded a new folder with the day's date will be created. All images recorded that day will be placed in that folder. Images recorded on a different day will be placed in a new folder with the corresponding date. If the file number memory function is off (p. 99), when a new folder is created, the serial number in the image-file name is reset to 0001. If file number memory function is on, the serial number in the image-file will be one greater than the last image saved. For more information on folder organisation and file names, see page 112.

## Audio signals

Every time a button is pressed, an audio signal will give a positive confirmation of the operation. The audio signals can be turned off in the custom 1 section of the setup menu (p. 96). The tone of the signal can also be changed; signal 1 is mechanical and signal 2 is electrical.

# Shutter FX

When the shutter is released, a shutter sound effect will give a positive confirmation of the operation. The sound effect can be turned off in the custom 1 section of the setup menu (p. 96). Three shutter effects are available; signal 1 is mechanical, signal 2 is electrical, and custom for a personalized effect. The mechanical shutter sound was taken from the legendary Minolta CLE, a compact rangefinder that represents the pinnacle of the development of the Leitz-Minolta CL.



To record a custom shutter effect, select custom record from the shutter FX option on the menu. Messages will appear during the routine. Press the shutter-release button to begin the recording of the shutter sound effect.

Microphone



Remaining recording time

During the recording, hold the camera's microphone approximately 20cm (8in) from the sound source. Up to five seconds of audio can be recorded. The remaining recording time is indicated by a status bar and the frame counter on the monitor. The recording will end when the shutter-release button is pressed again or recording time has elapsed.

The length of the recording will affect the performance of the camera. The longer the recorded sound effect, the longer the delay between image capture. This can have a significant effect on the continuous-advance frame rate.

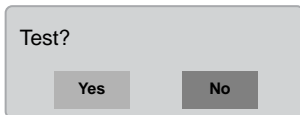

To test the recording select and enter "Yes." During playback, the up/down controller keys control volume and the menu button cancels the playback. Select and enter "No" to continue.



Playback display

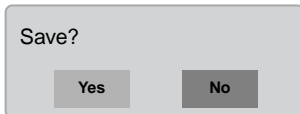

To save the shutter sound effect and replace any previous recording, select and enter "Yes." "No" will cancel the operation. Once saved the sound effect can be recalled anytime by selecting the custom setting from the sound FX option on the setup menu.

## Volume

The volume of the audio signals and shutter FX can be increased or decreased in the custom 1 section of the setup menu (p. 96). This affects the camera's audio signals only and will not change the playback levels of an audio track.

## Reset default

This function affects all modes. When selected, a confirmation screen will appear; choosing "Yes" resets the following functions and settings, "No" cancels the operation.

Exposure mode	Program	p. 58
Focus mode (Multi-function rec.)	Area AF with single-shot AF	p. 64
Full-time AF	Off (Multi-function recording mode)	p. 65
Digital zoom	Off	p. 40
Drive mode	Single-frame advance	p. 41
Flash mode	Autoflash	p. 32
Image quality	Standard	p. 48

Image size (still)	2560 X 1920	p. 48
Image size (movie)	320 X 240	p. 78
Metering mode	Multi-segment	p. 66
Exposure compensation	0.0	p. 51
Flash compensation	0.0	p. 66
Movie mode	Standard	p. 78
Camera sensitivity (ISO)	Auto	p. 67
White balance	Auto (custom setting deleted)	p. 62
Voice memo	Off	p. 70
Date imprinting	Off	p. 50
Instant playback	Off	p. 71
Color mode	Natural Color	p. 68
Sharpness	Normal	p. 68
Contrast	Normal	p. 68
Color-saturation	Normal	p. 68
Noise reduction	On	p. 104
Duration (Slide Show)	5 seconds	p. 88
Repeat (Slide Show)	No	p. 88
LCD monitor brightness	Normal	p. 98
Auto-power-save period	1 minute	p. 99
Audio signals	1	p. 100
Shutter FX	1 (custom recording erased)	p. 101
Volume	2	p. 102
File number memory	Off	p. 99
Folder name	Standard	p. 100

## Noise reduction

This function reduces the affect of dark noise caused by long exposures. Noise reduction is only applied to exposures of one second or longer. Processing is applied to each image after it is captured. The processing time varies from image to image; a message will be displayed during this period.

## Setting the date and time

It is important to accurately set the clock. When a still image or a movie clip is recorded, the date and time of the recording are saved with the image and are displayed during playback or can be read with the DiIMAGE Viewer software included on the CD-ROM. The camera's clock is also used with date imprinting (p. 50). See page 20 for instructions on how to set the clock and calendar.

## Setting the date format

The date format that is displayed or imprinted can be changed: YYYY/MM/DD (year, month, day), MM/DD/YYYY (month, day, year), DD/MM/YYYY (day, month, year). Simply select the format and enter it by pressing the central button of the controller; the new format will be displayed on the menu.

## Video output

Camera images can be displayed on a television (p. 94). The video output can be changed between NTSC and PAL. North America uses the NTSC standard and Europe uses the PAL standard. Check which standard is used in your region to play back images on your television set.



# DATA-TRANSFER MODE

Read this section carefully before connecting the camera to a computer. Instructions on using and installing the DiMAGE Viewer software are found in the supplied software manual. The DiMAGE manuals do not cover the basic operation of computers or their operating systems; please refer to the manual supplied with your computer.

## System requirements

For the camera to be connected directly to the computer and used as a mass-storage device, the computer must be equipped with a USB port as a standard interface. Both the computer and the operating system must be guaranteed by their manufacturers to support USB interface. The following operating systems are compatible with the camera:

IBM PC / AT Compatible	Macintosh
Windows 98, 98SE, Me, 2000 Professional, and XP.	Mac OS 8.6 ~ 9.2.2 and Mac OS X 10.1.3 - 10.1.5 and 10.2.1

Check the Minolta web site for the latest compatibility information:

North America: <http://www.minoltausa.com>

Europe: <http://www.minoltasupport.com>

Users with Windows 98 or 98 second edition will need to install the driver software on the included DiMAGE Viewer CD-ROM (p. 108). Users with Mac OS 8.6 will need to download and install a USB mass-storage device from the Apple web site (p. 111). No special driver software is required for other Windows or Macintosh operating systems.

Customers who have bought a previous DiMAGE digital camera and have installed the Windows 98 driver software must repeat the installation procedure. The updated version of the driver software included on the supplied DiMAGE Viewer CD-ROM is required for the operation of the DiMAGE F300 with a computer. The new software will have no affect on the performance of older DiMAGE cameras.

## Connecting the camera to a computer

Confirm the battery has sufficient power before connecting the camera to a computer, the full-battery indicator should be displayed on the monitor and data panel. The use of the AC adapter (sold separately) is recommended over the use of the battery. For users with Windows 98, 98SE, or Mac OS 8.6, read the respective sections on how to install the necessary USB driver before connecting the camera to a computer (Windows 98 - p. 108, OS 8.6 - p. 111).

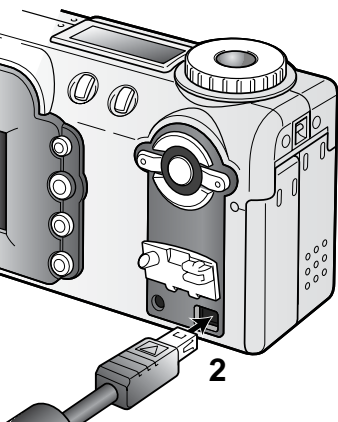

- 1** Start up the computer. The computer must be on before connecting the camera.
- 2** Remove the USB-port cover. Attach the smaller plug of the USB cable to the camera. Make sure the plug is firmly attached. The USB-port cover is attached to the body to prevent loss.
- 3** Attach the other end of the USB cable to the computer's USB port. Make sure the plug is firmly attached.
  - The camera should be connected directly to the computer's USB port. Attaching the camera to a USB hub may prevent the camera from operating properly.

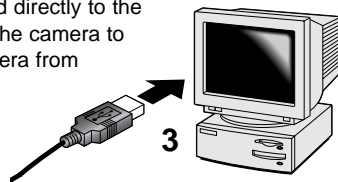

- 4** Insert the memory card into the camera. To change the memory card while the camera is connected to a computer, see page 116.
- 5** Turn on the mode dial to any position to initiate the USB connection. While the camera is connected to a computer, the data-transfer screen will be displayed.

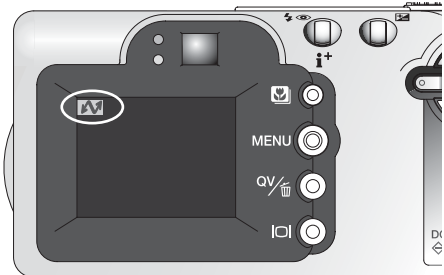



Windows XP

When the camera is properly connected to the computer, a drive icon, or volume, will appear. When using Windows XP or Mac OS X, a window will open requesting instructions on what to do with the image data; follow the directions in the window. If the computer does not recognize the camera, disconnect the camera and restart the computer. Repeat the connection procedure above.

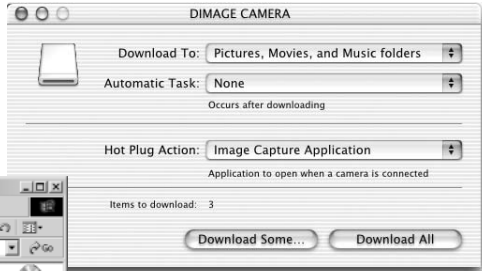

Mac OS X

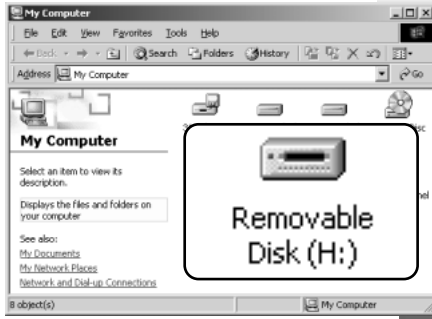

Windows

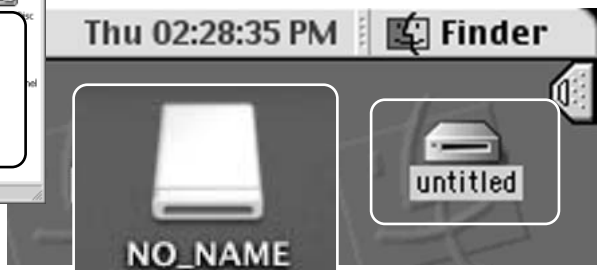

Mac OS X

Earlier Mac OS

The volume name varies between memory cards.

## Connecting to Windows 98 and 98 Second Edition

The driver needs only to be installed once. If the driver cannot be installed automatically, it can be installed manually with the operating system's add-new-hardware wizard; see the instructions on the following page. During installation, if the operating system requests the Windows 98 CD-ROM, insert it into the CD-ROM drive and follow the accompanying instructions on the screen. No special driver software is required for other Windows or Macintosh operating systems.

### Automatic Installation



Before connecting the camera to the computer, place the DiMAGE Viewer CD-ROM in the CD-ROM drive. The DiMAGE installer menu should automatically activate. To automatically install the Windows 98 USB driver, click on the starting-up-the-USB-device-driver-installer button. A window will appear to confirm that the driver should be installed; click "Yes" to continue.

When the driver has been successfully installed, a window will appear. Click "OK." Restart the computer and connect the camera (p. 106) to complete the operation.



## Manual Installation

To install the Windows 98 driver manually, follow the instructions in the connecting-the-camera-to-a-computer section on page 106.

When the camera is plugged into the computer, the operating system will detect the new device and the add-new-hardware-wizard window will open. Place the DiIMAGE Viewer CD-ROM in the CD-ROM drive. Click “Next.”



Choose the recommended search for a suitable driver. Click “Next.”



Choose to specify the location of the driver. The browse window can be used to indicate the driver location. When the location is shown in the window, click “Next.”

- The driver should be located in the CD-ROM drive at :\\Win98\\USB.





The add new hardware wizard will confirm the location of the driver. Click "Next" to install the driver in the system.

- One of three drivers may be located: MNLVNUM.inf, USBPDR.inf, or USBSTRG.inf.
- The letter designating the CD-ROM drive will vary between computers.

The last window will confirm the driver has been installed. Click "Finish" to close the add new hardware wizard. Restart the computer.

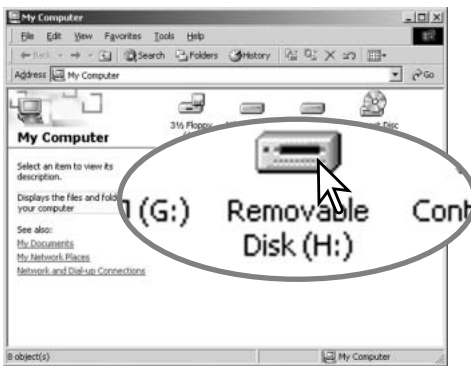

When the my-computer window is opened, a new removable-disk icon will be displayed. Double click on the icon to access the camera's memory card; see page 112.

## Connecting to Mac OS 8.6

To access this camera with a computer with Mac OS 8.6, the USB storage support must be installed first. This software is supplied by Apple Computer, Inc. free of charge. The latest version can be downloaded from the Apple Software Updates web site at <http://www.apple.com/support>.



To download and install this software, follow the instruction on the Apple web site. Always read the attached terms and conditions before installing any new software.

### USB Storage Support 1.3.5.smi

## QuickTime system requirements

IBM PC / AT Compatible

Pentium-based computer

Windows 95, 98, 98SE, NT, Me,  
2000 Professional, or XP.

32MB or more of RAM

Sound Blaster or compatible sound card

DirectX 3.0 or later recommended

To install QuickTime, follow the instructions in the installer. Macintosh users can download the latest version of QuickTime free of charge from the Apple Computer web site: <http://www.apple.com>.

## Auto power save (data-transfer mode)

If the camera does not receive a read or write command within ten minutes, it will shut down to save power. When the camera shuts down, an unsafe-removal-of-device warning may appear on the computer monitor. Click "OK." Neither the camera or computer will be damaged in this operation.

Turn off the camera with the mode dial. Remake the USB connection by turning on the camera with the mode dial.

# Memory card folder organisation



Drive Icon

Once the camera is connected to the computer, image and audio files can be accessed by double clicking on icons. Image folders are located in the DCIM folder. To copying images and audio recordings, simply drag and drop the file icon into a location in the computer. Files and folders on the memory card can be deleted using the computer. Never format the memory card from the computer; always use the camera to format the card. Only files recorded by the camera should be stored on the memory card.



Dcim



Misc

The misc. folder contains DPOF print files (p. 90).



100MLT17



10130801



102MLTCP



103MLTEM



PICT0001.TIF



PICT0002.JPG  
Fine, standard,  
or economy  
image



PICT0002.WAV  
PICT0002's  
voice-memo or  
audio-caption  
file



PICT0003.MOV  
Movie clip



PICT0004.WAV  
Audio recording



PICT0001.THM  
Super-fine image



Image and audio file names begin with "PICT" followed by a four-digit file number and a tif, jpg, mov, or thm extension. Voice-memo and audio caption files have a wav extension and the file name corresponds to their image file. Audio recordings also use the wav extension. The thumbnail images (thm) are produced with super-fine images and are only used in camera and DiMAGE Viewer operation.

Copy images (p. 92) are placed in a folder with a name ending in "CP." E-mail Copy images are placed in a folder ending in "EM." When a new folder is created, the first three digits in the folder name will be one greater than the largest folder number on the card. When the index number in the image file name exceeds 9,999, a new folder will be created with a number one greater than the greatest folder number on the memory card: e.g. from 100MLT17 to 101MLT17.

The number in the image file name may not correspond to the frame number of the image. As images are deleted in the camera, the frame counter will adjust itself to show the number of images on the card and reassign the frame numbers accordingly. The serial numbers used with image files will not change when an image is deleted. When a new image is recorded, it will be assigned a number one greater than the largest serial number in the folder. File serial numbers can be controlled with the file-number-memory function in the custom 1 section of the setup menu (p. 96).

## Camera Notes

Image files contain exif tag data. This data includes the time and date the image was recorded as well as the camera settings used. This data can be viewed with the camera or the DiMAGE Viewer software. If a camera image is opened in a photo-retouching application like Adobe Photoshop, and then the image is saved overwriting the original data, the exif tag information is erased. When using software other than the DiMAGE Viewer, always make a backup copy of the image files to protect the exif tag data.

To view images correctly on your computer, the monitor's color space may need to be adjusted. Refer to your computer manual on how to calibrate the display to the following requirements: sRGB, with a color temperature of 6500K, and a gamma of 2.2. Changes made to the captured image with the camera's contrast and color-saturation controls will affect any color-matching software in use.

# Disconnecting the camera from the computer



Never disconnect the camera when the access lamp is red - the data or memory card may be permanently damaged.

## Windows 98 / 98 Second Edition

Confirm that the access lamp is not lit. Turn the mode dial to another position and then disconnect the USB cable.

## Windows Me, 2000 Professional, and XP



To disconnect the camera, click once on the unplug-or-eject-hardware icon located on the task bar. A small window will open indicating the device to be stopped.

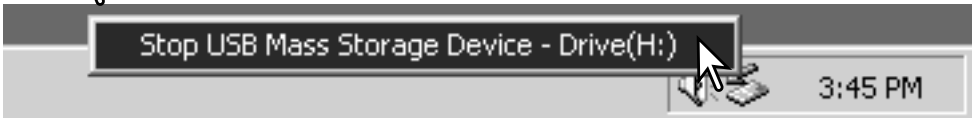

Click on the small window to stop the device. The safe-to-remove-hardware window will open. Close the window, turn the camera off, and then disconnect the USB cable.



When more than one external device is connected to the computer, repeat the procedure above except right click on the unplug-or-eject-hardware icon. This will open the unplug-or-eject-hardware window after clicking on the small window indicating the unplug-or-eject-hardware routine.



The hardware devices to be stopped will be displayed. Highlight the device by clicking on it then click "Stop."

A confirmation screen will appear to indicate the devices to be stopped. Clicking "OK" will stop the device.

A third and final screen will appear to indicate the camera can be safely disconnected from the computer. Close the window, turn the camera off, and then disconnect the USB cable.

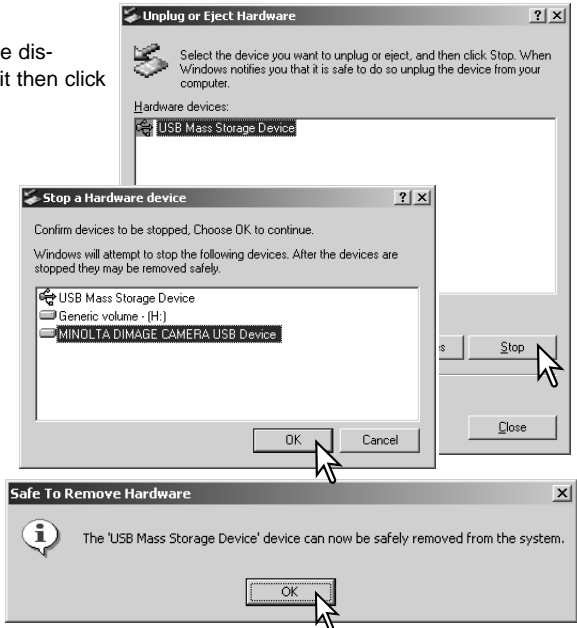

### Macintosh

Confirm that the access lamp is not lit and then drag the mass-storage device icon and drop it into the trash. Turn the camera off, and then disconnect the USB cable.



## Changing the memory card (Data-transfer mode)

Care should be taken when changing memory cards while the camera is attached to the computer. Data could be lost or damaged if the camera is not properly disconnected.



Never remove the card when the access lamp is red - the data or memory card may permanently be damaged.

### *Windows 98 and 98 Second Edition*

1. Turn off the camera.
2. Change the memory card.
3. Turn on the camera to remake the USB connection.

### *Windows ME, 2000 Professional, and XP*

1. Stop the USB connection using the unplug-or-eject-hardware routine (p. 114).
2. Turn off the camera.
3. Change the memory card.
4. Turn on the camera to remake the USB connection.

### *Macintosh*

1. Stop the USB connection by dragging the drive icon into the trash (p. 115).
2. Turn off the camera.
3. Change the memory card.
4. Turn on the camera to remake the USB connection.

# APPENDIX

## Troubleshooting

The section covers minor problems with basic camera operation. For major problems or damage, or if a problem continues to reoccur frequently, contact a Minolta service facility.

Problem	Symptom	Cause	Solution
The camera will not work.	Nothing displayed on the data panel or the monitors.	The battery is dead.	Replace battery (p. 14).
		AA Ni-MH batteries are inserted incorrectly.	Reinsert the batteries taking care that the negative and positive terminals are orientated as indicated on the inside of the battery chamber door (p. 15).
		The AC adapter is not connected properly.	Check that the adapter is connected to the camera and a live electrical outlet (p. 17).
Shutter will not release.	"000" is displayed on the frame counter.	Memory card is full and unable to store an image at the image-quality or image-size setting on the camera.	Insert a new memory card (p.18), delete some images (p. 85), or change the image-quality or image-size setting (p. 38, 56).
	No-card warning appears on the monitors.	No memory card in the camera.	Insert a memory card (p. 18).

Problem	Symptom	Cause	Solution
Pictures are not sharp.	Focus signal is red.	Subject is too close.	Make sure the subject is within the autofocus range (p. 24) or use the macro mode (p. 29).
		The camera is in macro mode.	Cancel the macro mode setting (p. 29).
		A special situation is preventing the autofocus system from focusing (p. 27).	Use the focus-lock function to focus on an object at the same distance as the subject (p. 53) or use manual focus (p. 65).
	Pictures are taken indoors or in low-light situations without flash.	Slow shutter speeds result in blurred images when the camera is hand-held.	Use a tripod, change the camera sensitivity to a higher setting (p. 67), or use the flash (p. 32).
Continuous advance and bracketing drive mode does not work.	The image quality is set to super fine.		Change the image-quality setting (p. 38, 56).
While using flash, the pictures are too dark.	The subject is beyond the flash range (p. 67).		Move closer to the subject or change the camera sensitivity to a higher setting (p. 67).

Problem	Symptom	Cause	Solution
Shooting data is displayed, but live image is entirely black or white.	Camera set to manual-exposure mode (M).	Shutter speed and aperture combination is extremely under or over-exposing the live image.	Change the shutter speed or aperture value until an image appears on the monitor (p. 60).

The camera temperature rises with extended periods of use. Care should be taken to avoid burns when handling the camera, batteries, or memory card.

If the camera does not function normally or the system error message appears, turn it off, remove and reinsert the batteries, or unplug and reconnect the AC adapter. If the camera has become hot with extended use, wait for it to cool before removing or disconnecting the power supply. Always turn the camera off using the mode dial otherwise the memory card may be damaged and camera settings reset.

## About Ni-MH batteries

When using Ni-MH batteries, clean both battery terminals with dry cloth to wipe off any dirt or residue. Because of the sophisticated computer system, the camera critically monitors power levels. If the battery terminals are dirty, the camera may give a false low-battery warning. If battery performance is unusually low, wipe the battery terminals with a clean, dry cloth.

Ni-MH battery performance will decrease if the batteries are often recharged before they have been fully discharged. Completely exhaust the Ni-MH batteries using the camera before charging.

## Uninstalling the driver software - Windows

1. Insert a memory card in the camera and connect it to the computer with the USB cable. Other devices must not be connected to the computer during this procedure.

2. Right click on the My-computer icon. Select “properties” from the drop-down menu.

Windows XP: from the start menu go to the control panel. Click on the performance and maintenance category. Click “System” to open the system properties window.

3. Windows 2000 and XP: select the hardware tab in the properties window and click the device-manager button.

Windows 98 and Me: click the device-manager tab in the properties window.

4. The driver file will be located in the universal-serial-bus-controller or other-devices location of the device manager. Click on the locations to display the files. The driver should be indicated with the camera name. Under certain conditions, the driver name may not contain the camera name. However, the driver will be indicated by either a question mark or exclamation point.

5. Click on the driver to select it.

6. Windows 2000 and XP: click on the action button to display the drop-down menu. Select “uninstall.” A confirmation screen will appear. Clicking “Yes” will remove the driver from the system.

Windows 98 and Me: click the remove button. A confirmation screen will appear. Clicking “Yes” will remove the driver from the system.

7. Disconnect the USB cable and turn off the camera. Restart the computer.



# Using USB DIRECT-PRINT

USB DIRECT-PRINT allows still images to be printed directly from a compatible Epson printer using a DPOF file (p. 90). Images to be printed are selected with the print option in the custom 2 section of the playback menu. An index print can also be selected on the menu. Super fine images cannot be printed with USB DIRECT-PRINT.

Before each print run, check the printer settings; refer to the printer manual. A fully charged battery should be used when the camera is connected to the printer. The use of the AC adapter (sold separately) is recommended over the use of the battery.

Connect the camera to the printer using the camera's USB cable. The larger plug on the cable is connected to the printer. Lift the rubber cover and insert the smaller plug of the cable into the camera (1).

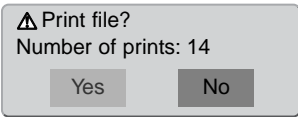
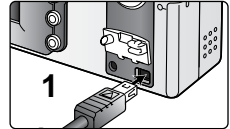

Turn the camera on with the mode dial; the dial can be set to any position. The number of prints in the DPOF file are displayed on the LCD monitor; index prints are counted as one. Use the left/right keys to highlight "Yes," and press the center of the controller to start printing.

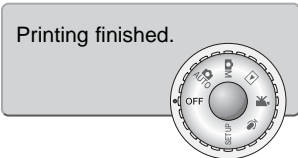

Once printing begins, the operation can be canceled by pressing the center of the controller. The printing finished message will indicate the end of the operation; turn the camera off to end the routine.

If a minor problem occurs during printing, such as the paper runs out, follow the procedure recommended for the printer; no action is required for the camera. If a major printer error occurs, press the center of the controller to end the routine. Refer to the printer manual for the correct procedure for the printer problem. Check the printer settings before starting again and remake the DPOF file to deselect any printed images; the USB cable must be unplugged from the camera to access the playback menu. The images can be edited by selecting marked frames from the print option in the custom 2 menu section.

## Care and storage

Read this section in its entirety to get the best results from your camera. With proper care, your camera will provide years of service.

### *Camera care*

- Do not subject the camera to shock or impact.
- Turn off the camera when transporting.
- This camera is neither waterproof nor splashproof. Inserting or removing batteries or the memory card, or operating the camera with wet hands may damage the camera.
- When at the beach or near water, take care not to expose the camera to water or sand. Water, sand, dust, or salt can damage the camera.
- Do not leave the camera under direct sunlight. Do not point the lens directly at the sun; the CCD may be damaged.

### *Cleaning*

- If the camera or the outside of the lens is dirty, gently wipe it with a soft, clean, dry cloth. If the camera or lens comes in contact with sand, gently blow away loose particles. Wiping may scratch the surface.
- To clean the lens surface, first blow away any dust or sand, then, if necessary, moisten a lens tissue or soft cloth with lens cleaning fluid and gently wipe the lens.
- Never use organic solvents to clean the camera.
- Never touch the lens surface with your fingers.

### *Storage*

- Store in a cool, dry, well-ventilated area away from dust and chemicals. For long periods of disuse, store the camera in an airtight container with a silica-gel drying agent.
- Remove the batteries and memory card from the camera when not in use for extended periods.
- Do not store the camera in an area with naphthalene or mothballs.
- During long periods of storage, operate the camera occasionally. When taking the camera out of storage, check that the camera is functioning properly before using.

## *Operating temperatures and conditions*

- This camera has been designed for use in temperatures from 0°C to 40°C (32°F to 104°F).
- Never leave the camera exposed to extreme high temperatures, such as in a car parked in the sun, or to extreme humidity.
- When taking the camera from a cold to a warm environment, place it in a sealed plastic bag to prevent condensation from forming. Allow the camera to come to room temperature before removing it from the bag.

## *Memory cards*

SD Memory Cards and MultiMediaCards are manufactured with precision electronic components. The following may cause data loss or damage:

- Improper use of the card.
- Bending, dropping, or subjecting the card to impact.
- Heat, moisture, and direct sunlight.
- Static electrical discharge or electromagnetic fields near the card.
- Removing the card or interrupting the power supply while the camera or a computer is accessing the card (reading, writing, formatting, etc.).
- Touching the electrical contacts of the card with your fingers or metal objects.
- Using the card beyond its life. Purchasing a new card periodically may be necessary.

Minolta has no responsibility for any loss or damage to data. It is recommended that a copy of the card data be made.

## *Batteries*

- Battery performance decreases with temperature. In cold environments, we recommend keeping spare batteries in a warm place, such as the inside of a coat. Batteries can recover their power when they warm up.
- If batteries have been exhausted when used in the camera, do not reload them even if their charge seems to recover over time. These batteries will interfere with normal camera operation.
- A special built-in long-life battery supplies power to the clock and memory when the camera is off. If the camera resets each time it is turned off, the battery is exhausted. The battery must be replaced at a Minolta service facility.

## *LCD monitor care*

- Although the LCD monitor is manufactured using high precision technology, there may occasionally be a lack of color or bright points on the monitor.
- Do not apply pressure to the surface of the LCD monitor; it may be permanently damaged.
- In cold temperatures, the LCD monitor may become temporarily dark. When the camera warms up, the display will function normally.
- The LCD monitor may be slow to react in low temperatures or may turn dark in a hot environment. When the camera reaches normal operating temperature, the display will function normally.
- If fingerprints are on the LCD monitor surface, gently wipe with a soft, clean, dry cloth.

## *Copyright*

- TV program, films, video tapes, photographs, and other materials may be copyrighted. Unauthorized recording or duplication of such material may be contrary to copyright laws. Taking pictures or images of performances, exhibitions, etc., is prohibited without approval and can infringe on copyright. Images protected by copyright can only be used under the provisions within the copyright laws.

## *Before important events and journeys*

- Check the camera's operation; take test pictures and purchase spare batteries.
- Minolta has no responsibility for any damage or loss incurred by equipment malfunction.

## *Questions and service*

- If you have questions about your camera, contact your local camera dealer or write to the Minolta distributor in your area.
- Before shipping your camera for repair, please contact a Minolta Service Facility.

The following marks may be found on the product:



This mark on your camera certifies that this camera meets the requirements of the EU (European Union) concerning interference causing equipment regulations. CE stands for Conformité Européenne (European Conformity).

Digital Camera: DiMAGE F300



Tested To Comply  
With FCC Standards

FOR HOME OR OFFICE USE

This device complies with Part 15 of the FCC Rules. Operation is subject to the following two conditions: (1) This device may not cause harmful interference, and (2) this device must accept any interference received, including interference that may cause undesired operation.

Do not remove the ferrite cores from the cables.

Tested by the Minolta Corporation

101 Williams Drive, Ramsey, New Jersey 07446, U.S.A.

This Class B digital apparatus complies with Canadian ICES-003.

Cet appareil numérique de la classe B est conforme à la norme NMB-003 du Canada.

## Technical specifications

CCD:	1/1.8-type interline primary-color CCD
Number of effective pixels:	5.0 million
Total number of pixels:	5.3 million
Camera sensitivity (ISO):	Auto and 64, 100, 200, and 400 ISO equivalents.
Aspect ratio:	4:3
Lens construction:	8 elements in 7 groups
Maximum aperture:	f/2.8 (wide-angle position), f/4.7 (telephoto position)
Focal length:	7.8 - 23.4 mm (35mm equivalent: 38 - 114 mm)
Focusing range (from the CCD):	0.5 m - $\infty$ / 1.6 ft - $\infty$ 0.2 - 0.6 m / 0.7 - 2.0 ft in macro mode
Autofocusing system:	Video AF
Shutter:	CCD electronic shutter and mechanical shutter
Shutter speeds:	1/1000 - 4s, bulb (15s maximum)
Built-in flash recycling time:	6s (approx.)
Viewfinder:	Optical real-image zoom viewfinder
Monitor LCD:	38 mm (1.5 in) low-temperature polysilicon TFT color
Monitor field of view:	100% (approx.)
A/D conversion:	12 bits
Recording media:	SD Memory cards and MultiMediaCards
File formats:	JPEG, TIFF, Motion JPEG (mov), WAV. DCF 1.0 and DPOF compliant.
Printing output control:	Exif print, PRINT Image Matching II, Epson USB DIRECT-PRINT
Menu languages:	Japanese, English, German, French, and Spanish
AV output:	NTSC and PAL

Batteries:	One CR-3V lithium battery or two AA Ni-MH batteries.
Battery performance (recording):	Approximately 260 frames: based on Minolta's standard test method: CR-3V lithium battery, LCD monitor on, full-size images (2560 X 1920), standard image quality, no instant playback, no voice memo, no full-time AF, no subject tracking AF, flash used with 50% of the frames. Approximately 560 frames: based on Minolta's standard test method: CR-3V lithium battery, LCD monitor off, full-size images (2560 X 1920), standard image quality, no instant playback, no voice memo, no full-time AF, no subject tracking AF, flash used with 50% of the frames.
Battery performance (playback):	Approx. continuous playback time: 270 min. Based on Minolta's standard test method using a CR-3V battery.
External power source:	AC Adapter AC-6 (sold separately)
Dimensions:	111.0 (W) X 52.5 (H) X 32.5 (D) mm 4.37 (W) X 2.07 (H) X 1.28 (D) in
Weight:	Approximately 185g / 6.5 oz. (without batteries or memory card)
Operating temperature:	0° - 40°C / 32° - 104°F
Operating humidity:	5 - 85% (noncondensing)

Specifications are based on the latest information available at the time of printing and are subject to change without notice.

# MINOLTA

© 2002 Minolta Co., Ltd. under the Berne Convention  
and the Universal Copyright Convention.

0-43325-53136-1

9222-2785-11 P-A211  
Printed in Germany