

E INSTRUCTION MANUAL

DYNAX™ **MAXXUM®** **700si**

PREPARATIONS ■

BASICS ■

FOCUS ■

METERING ■

EXPOSURE ■

FLASH ■

ADDITIONAL ■



MINOLTA

Welcome to your adventure in photography with the Dynax/Maxxum 700si. This instruction manual will help you understand the 700si's automatic systems and learn how to use its many functions.

The 700si features High-Speed Autofocus, Predictive Focus Control, Minolta's highly acclaimed 14-Segment Honeycomb Pattern Metering, a top shutter speed of 1/8000 second, and Expert Program Selection. As a result, the 700si responds quickly, accurately, and flexibly to virtually any motion, composition, or lighting condition in the moment of a shutter release.

The 700si also offers full control over all camera systems. You can select any of the four local focus areas, take temporary spot readings and lock the spot exposure with the spot button, lock focus with the AF button, and use Memory to save and later recall your most often used camera settings.

First, familiarize yourself with the names of the controls and their location on the camera, then read this manual thoroughly. The Quick Reference Guide in the back of the manual will help you make changes you want when you are in a hurry or simply wish to refresh your memory.

This instruction manual was printed in September, 1993.

IMPORTANT INFORMATION

The Minolta 700si was designed to work specifically with lenses, flash units, and other accessories manufactured and distributed by Minolta. We therefore caution users of this camera that the attachment and/or use of incompatible products with the 700si may result in unsatisfactory performance or damage to the camera or its accessories. To obtain optimum performance throughout the life of your 700si, we recommend that you use only those lenses, flashes and other accessories distributed by Minolta specifically for use with this camera.

STATEMENT OF FCC COMPLIANCE

This device complies with Part 15 of the FCC Rules. Operation is subject to the following conditions: (1) This device may not cause harmful interference, and (2) this device must accept any interference received, including interference that may cause undesired operation. Changes or modifications not approved by the party responsible for compliance could void the user's authority to operate the equipment. This equipment has been tested and found to comply with the limits for a Class B digital device, pursuant to Part 15 of the FCC Rules. These limits are designed to provide reasonable protection against harmful interference in a residential installation. This equipment generates, uses and can radiate radio frequency energy and, if not installed and used in accordance with the instructions, may cause harmful interference to radio communications. However, there is no guarantee that interference will not occur in a particular installation. If this equipment does cause harmful interference to radio or television reception, which can be determined by turning the equipment off and on, the user is encouraged to try to correct the interference by one or more of the following measures:

Reorient or relocate the receiving antenna.

Increase the separation between the equipment and receiver.

Connect the equipment into an outlet on a circuit different from that to which the receiver is connected. Consult the dealer or an experienced radio/TV technician for help.

STATEMENT OF DOC COMPLIANCE

This digital apparatus does not exceed the Class B limits for radio noise emissions from digital apparatus set out in the Radio Interference Regulations of the Canadian Department of Communications.

TABLE OF CONTENTS

NAMES OF PARTS

Body	4
Body Data Panel	7
Viewfinder	8

PREPARATION

Standard Accessories	10
Neckstrap	10
Eyepiece cup	10
Eyepiece and accessory-shoe cap	10
Battery	11
Installation	11
Battery-condition indicators	12
Battery performance	13
Cold-weather operation	13
Lens	14
Attaching	14
Removing	15
Care of glass surfaces	15
Film	16
Loading	16
Manual film speed setting	19
Rewinding	20
High-speed load and rewind	21
Eye-Start	22

THE BASICS

Program-Reset Button	24
Holding the Camera	25
Looking Through the Viewfinder	26

FOCUS DETAILS

Autofocus	30
AF illuminator	31
Focus Lock	32
Local Focus Area Selection	34
Manual Focus	35
Special Focusing Situations	36

METERING DETAILS

Honeycomb-Pattern Metering	38
Spot Metering	40
Center-Weighted Average Metering	42

EXPOSURE DETAILS

P: Programmed Autoexposure	44
PA/Ps: Creative Program Control	45
A: Aperture-Priority Autoexposure	46
S: Shutter-Priority Autoexposure	48
M: Manual exposure	50
Bulb	51
Double Exposure	53
Exposure Compensation	54
Exposure Bracketing	56

FLASH DETAILS

Built-In Flash	58
Red-Eye Reduction	59
P-Mode Flash	60
Manual fill-flash	61
A, S, and M-Mode Flash	62
Slow-Shutter Sync	63
Flash Compensation	64
Remote/Wireless Off-Camera Flash Control	65

ADDITIONAL FEATURES

Metering Index	71
Memory	72
Self-Timer	74
Film Drive	75
Depth-of-Field Preview	76
Release Priority	77
Image-Size Lock	78
Panorama Indicator	79

APPENDIX

Accessory Information	81
Technical Details	85
Caring For Your Camera	88
Quick Reference Guide	90

NAMES OF PARTS

For information on specific parts, refer to the page numbers shown in parentheses.

Body

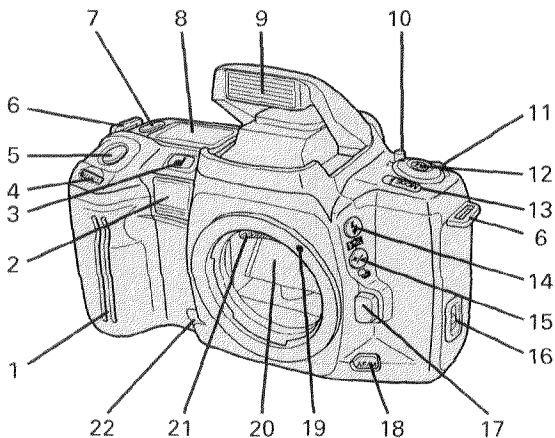

1. Grip sensor (22)
2. AF illuminator/self-timer light (31/74)
3. Program-reset button (24)
4. Front control dial
5. Shutter-release button
6. Strap eyelet (10)
7. Card button
8. Body data panel
9. Built-in flash (58)
10. Memory-switch release (73)
11. Memory switch (73)
12. Memory recall button (73)
13. Exposure-mode button (44-50)
14. Flash-control button (61/64)
15. Exposure-compensation button (54/64)
16. Back-cover release
17. Lens release (15)
18. Focus-mode button (35)
19. Mounting index (14)
20. Mirror*
21. Lens contacts*
22. Depth-of-field preview button (76)

* Do not touch

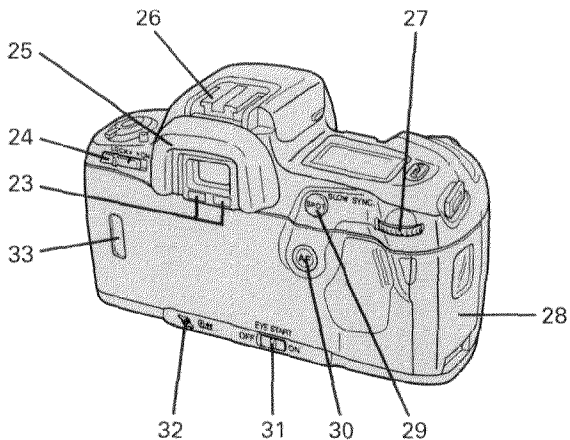

- 23. Eyepiece sensor (22)
- 24. Main switch
- 25. Eyepiece cup (10)
- 26. Accessory shoe
- 27. Rear control dial
- 28. Card door

- 29. Spot button (40,63)
- 30. AF button (32,34)
- 31. Eye-start switch (22)
- 32. Rewind button (20)
- 33. Film window (16)

Inside Card Door

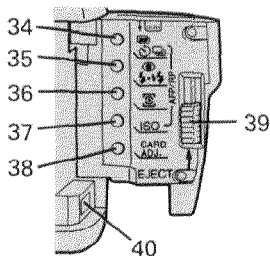

- 34. Self-timer/drive-mode button (53/74/75)
- 35. Flash-mode button (59,60)
- 36. Metering-mode button (38-42)
- 37. ISO button (19)
- 38. Card-adjust button
- 39. Card-eject slide
- 40. Remote-control terminal (52)

Body

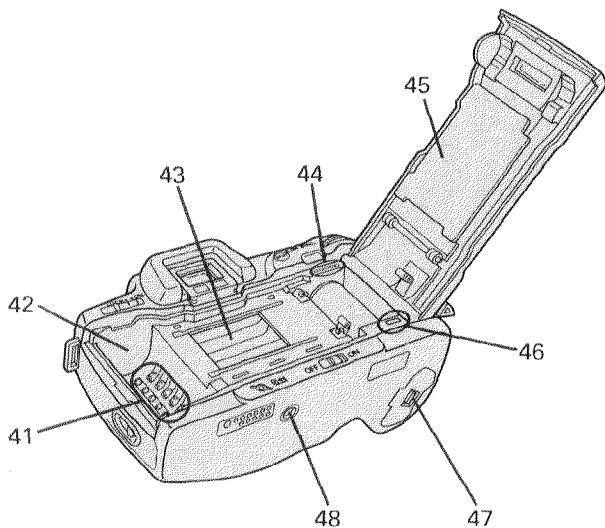

41. DX contacts*

42. Film chamber (16)

43. Shutter*

44. Accessory-back contacts*

45. Pressure plate*

46. Film-leader index (16)

47. Battery-cover release (11)

48. Tripod socket

* Do not touch

Body Data Panel

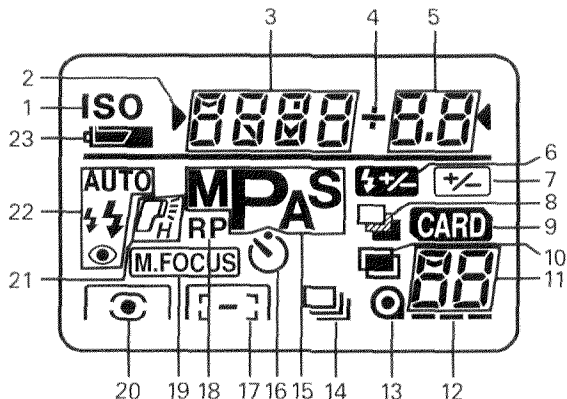

- | | |
|--|---|
| 1. Film-speed mark (18,19) | 10. Double-exposure indicator (54) |
| 2. Selectable setting pointers | 11. Frame counter |
| 3. Shutter-speed/Film-speed/
Card-name/Local-focus-area
display | 12. Film-transport signal (18) |
| 4. Compensation indicator (54,64) | 13. Film-cartridge mark (18,20) |
| 5. Aperture/Exposure-
compensation/Flash-
compensation/Card-setting
display | 14. Drive-mode indicator (75) |
| 6. Flash-compensation reminder
(64) | 15. Exposure-mode indicators
(44-50) |
| 7. Exposure-compensation
reminder (54) | 16. Self-timer indicator (74) |
| 8. Exposure-bracketing indicator
(56) | 17. Wide/local-focus indicator
(32,34) |
| 9. Card indicator | 18. Release-priority indicator (77) |
| | 19. Manual-focus indicator (35) |
| | 20. Metering-mode indicator
(38-42) |
| | 21. High-speed sync flash
indicator (60) |
| | 22. Flash-mode indicator (60) |
| | 23. Battery-condition indicator (12) |

Viewfinder

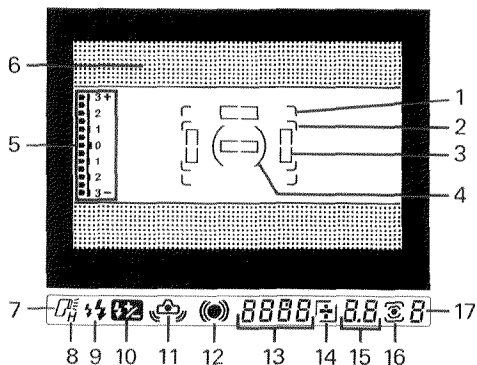

Viewfinder Screen

1. Horizontal wide-focus frame (30)
2. Vertical wide-focus frame (30)
3. Local-focus areas (32,34)
4. Spot-metering area (40,41)
5. Metering index (71)
6. Panorama indicator (80)

Viewfinder Data Panel

7. Flash-on indicator (60)
8. High-speed sync flash indicator (60)
9. Flash signals (59,60)
10. Flash-compensation reminder (64)
11. Camera-shake warning (44,47)
12. Focus signals (26)
13. Shutter-speed/Film-speed/Local focus-area display
14. Compensation indicator (54)
15. Aperture/Exposure-compensation/Flash-compensation display
16. Metering-mode indicator (38-42)
17. Frame counter (28)

PREPARATIONS

STANDARD ACCESSORIES

Neckstrap

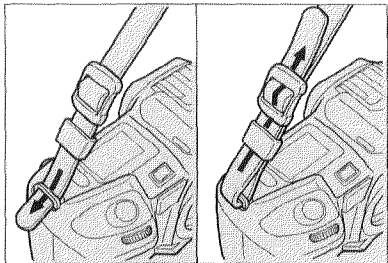

Attach the neckstrap as shown.

Eyepiece Cup

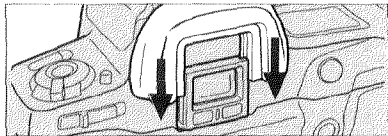

Attach the eyepiece cup as shown.

Eyepiece and Accessory Shoe Cap

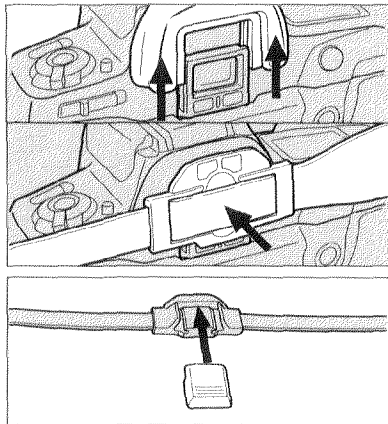

An eyepiece cap is attached to the strap. Before you use the self-timer or make long exposures, remove the eyepiece cup and attach the cap to the viewfinder eyepiece. This will prevent stray light from entering the camera and affecting exposure. The camera also comes with an accessory-shoe cap which protects the accessory-shoe contacts. When you are using a flash or other accessory, slide the accessory-shoe cap into the eyepiece cap for safekeeping.

BATTERY

This camera uses a 6-volt 2CR5 lithium battery which supplies power for all camera operations. If you are using an xi-Series lens, the camera battery also supplies power to the lens' zoom motor.

Battery Installation

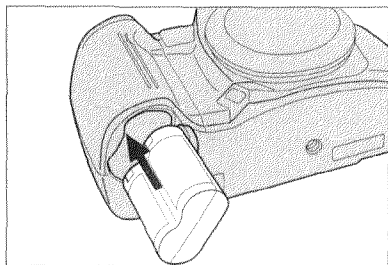
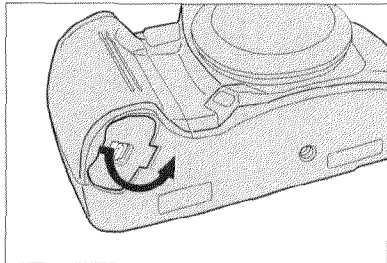

1. Set the main switch to LOCK and slide the battery-cover release in the direction indicated to open the battery cover.

2. Insert the battery according to the marks on the inside of the chamber cover.

3. Snap the cover closed.

CAUTION

- Read and follow all warnings and instructions supplied by the battery manufacturer.
- Do not attempt to disassemble, recharge, or short-circuit the battery.
- Do not subject it to high temperatures or fire. The battery may explode and cause severe burns.
- Keep batteries away from small children.

Battery-Condition Indicators

Whenever you slide the main switch from **LOCK** to **ON**, one of the following indicators will appear in the body data panel for 5 seconds.

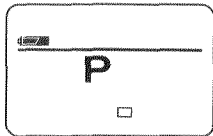

Power is sufficient if the full-battery symbol appears.

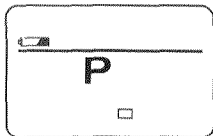

If the low-battery symbol appears, power is sufficient, but getting low. **Keep a fresh battery handy.**

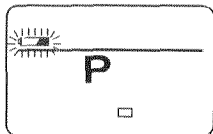

When the low-battery symbol blinks while it appears with other operating indicators at any time during use--camera can be operated, but power is extremely low. **The battery will need to be changed soon.**



If the blinking low-battery symbol appears, or no display appears at all and shutter locks--power is insufficient for operation. **Replace the battery or check that the battery is inserted correctly.**

● This indicator will appear even while the main switch is set to **LOCK**.

Battery Performance

Flash Use	20°C (68°F)
100%	15 rolls
50%	25 rolls
0%	60 rolls

Based on the following test conditions: 24 exposure roll of film; Eye-Start ON; AF 24-85mm f/3.5-4.5 lens; autofocus from infinity to minimum focus distance and back 3 times; shutter-release button held partway down for 10 seconds before shutter release.

- Battery performance with a 36 exposure roll is reduced by approximately 1/3.
- Because more operations are performed during actual use, battery performance will be slightly lower.
- To maximize battery performance/life, slide the main switch to LOCK when you are not using the camera.

Cold-Weather Operation

Lithium batteries provide excellent performance in cold weather. However, if you plan to shoot many rolls of film in temperatures near or below 0°C (32°F), we recommend that you carry the camera inside your coat while you are not shooting to keep it warm. You may also want to carry several spare batteries in your pocket so that you can change the camera battery if necessary. Do not discard a cold battery. After it warms up, it will regain some of its charge.

LENS

Attaching the Lens

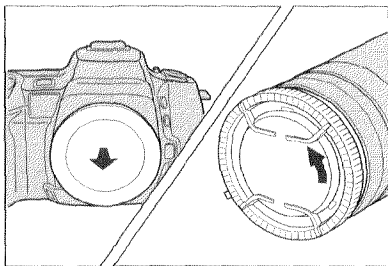

1. Remove the body cap and rear lens cap as shown.

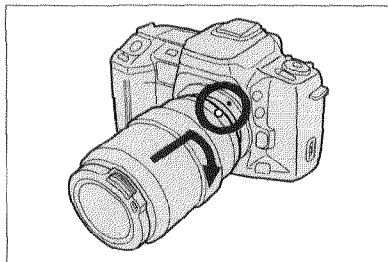

2. Align the red bead on the lens barrel with the red dot on the camera's lens mount. Gently insert the lens into the mount and turn the lens clockwise until it locks in place with a click.

CAUTION

- Do not force the lens onto the body if it does not turn smoothly.
 - Never touch anything inside the camera, especially the lens contacts and mirror.
-
- If “--” appears in the body data panel and viewfinder data panels, lens data is not being transmitted to the camera. This happens when no lens is attached to the camera, the lens is not attached properly, lens contacts are dirty, or a non-compatible lens is attached. When film is loaded, the shutter is locked to prevent accidental exposures. If you want to release shutter under such conditions (eg., when the camera is attached to a telescope), contact your nearest authorized MINOLTA Service Facility.

Removing the Lens

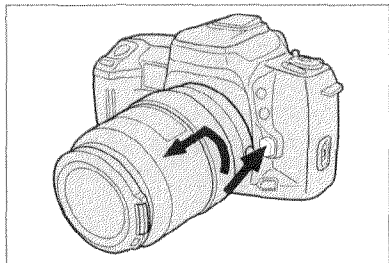

1. While pressing the lens release, turn the lens counterclockwise until it stops. Lift the lens out of the mount.

2. Immediately attach the rear cap to the lens and the body cap or another lens to the camera. This will protect the camera interior, lens contacts, and lens elements.

Care of Glass Surfaces

- Never touch any lens surfaces (including the eyepiece) with your fingers. If a lens surface becomes dirty, first gently clean it with a lens brush. Then, if necessary, moisten a sheet of lens tissue with one drop of lens-cleaning fluid and, starting from the center of the lens, wipe the glass with a circular motion.
- Never lift the mirror or touch its surface, because this may impair the mirror's alignment or scratch its face. Dust on the mirror will not adversely affect meter readings or picture quality. If it is distracting, have the camera cleaned at an authorized Minolta service facility.

Loading Film

Before you load film, check the film window. If the film cartridge is loaded, **do not open the back cover**. See page 20 for instructions on rewinding a partially exposed roll of film.

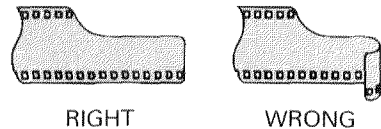
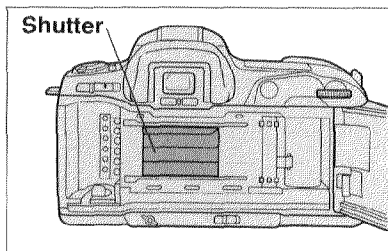
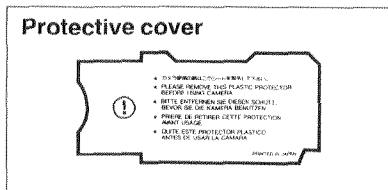

- Before you load film for the first time, remove and discard the protective cover in the film gate.

- Always load film in subdued or shaded light to limit the chances of fogging your film.

- **NEVER TOUCH THE SHUTTER CURTAIN WITH YOUR FINGERS OR WITH THE FILM TIP.** Its precision design makes it extremely sensitive to pressure.

- Make sure the film leader is shaped correctly, otherwise the film may not advance properly. Trim a torn or bent film tip so that it looks like the correct one pictured at left.

- If Eye-Start is on, make sure the main switch is set to LOCK before you begin loading the film; otherwise autofocus may be activated.

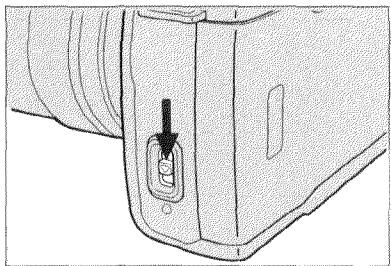

1. Open the back cover by sliding the back-cover release downward.

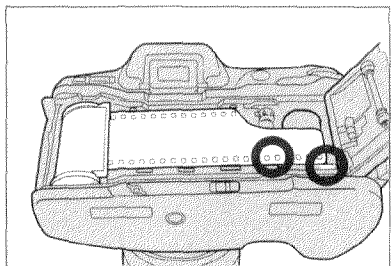

2. Place the film cartridge into the film chamber and extend the leader between the guide rails to the film-leader index. Make sure the sprocket holes in the film's lower edge are engaged by the camera's sprocket teeth.

● If the film tip extends beyond the red mark, gently push the excess film back into the cartridge.

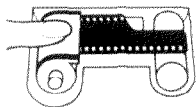

RIGHT

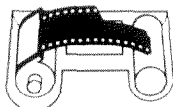

WRONG

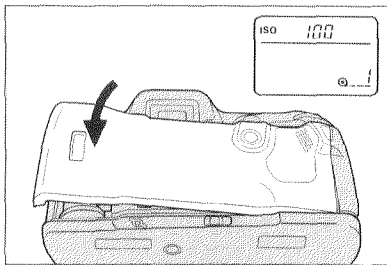

3. Close the back cover and slide the main switch to **ON**. The camera will automatically advance the film to the first frame and **1** will appear in the frame counter.



- If you use DX-coded film, the camera will automatically set the correct film speed and display it in the body data panel for 5 sec. If non-DX-coded film is used, the previous setting will appear.

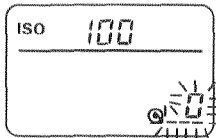

- When the film is loaded incorrectly, **0** will blink in the frame counter and the shutter will remain locked. Open the back cover and repeat steps 2 and 3.

- If you are not using DX-coded film or you want to override the automatically film speed setting, see the Manual Film Speed Setting section on page 19.

- To display the current film speed setting at any time, press the ISO button in the card door--the film speed will appear in the body data panel.

- When you are reaching the end of a roll of film, a frame counter appears in the viewfinder data panel to countdown the last nine frames.

Manual Film Speed Setting

If you are using a non-DX-coded film or if you want to override the camera's automatic setting, you must manually set the film speed. The camera will initially set non-DX-coded film to the ISO of the previous roll.

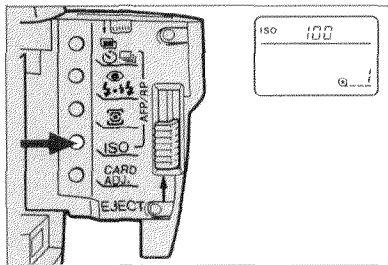

1. Load the film, open the card door and press the ISO button.

2. Turn either control dial until the desired film speed setting appears in the body data panel.

3. Press the shutter-release button partway down to enter your selection.

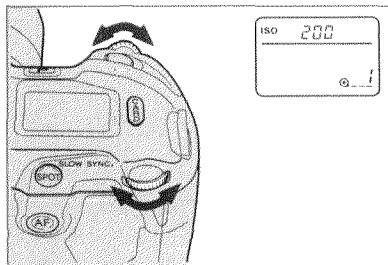

- Each click of the dial will change the film speed setting by 1/3-stop between ISO 6 and 6400.
- For flash exposures, Minolta recommends that you use film between ISO 25 and 1000.

Rewinding Film

After you have exposed the last frame, the camera will automatically rewind the film silently. With a fresh battery, it takes about 15 seconds to rewind a 24-exposure roll. You can also set the camera so that the film rewinds at high speed (see p.21). It takes about 8 seconds for a 24-exposure roll. When the film has been completely rewound, the motor will stop and the film-cartridge symbol in the body data panel will blink to indicate that it is safe to open the back cover.

To begin film rewind manually:

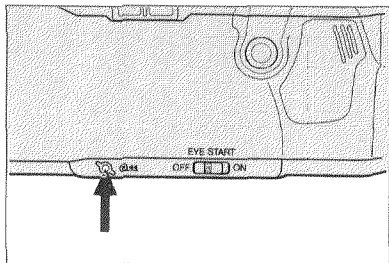

Press the rewind button with your fingernail.

- To finish rewinding the film at high speed, press the rewind button again.

- When the motor stops and the cartridge mark in the body data panel blinks, it is safe to open the back cover.
- If the motor stops before the film is completely rewound, insert a fresh battery. Do not open the back until the film cartridge mark blinks in the body data panel.

High-Speed Load and Rewind

The camera normally advances the film to first frame and rewinds silently. However, you can select high-speed load and rewind which is approximately twice as fast.

To select high-speed film load and rewind:

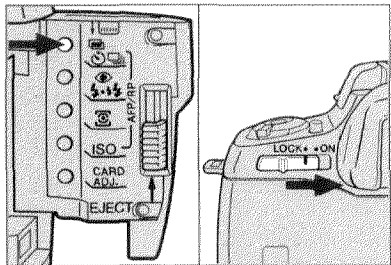

1. Open the card door.
2. While pressing the self-timer/ drive-mode button, slide the main switch from LOCK to ON. "On" will appear in the body data panel.

● To return to silent load and rewind, repeat steps 1 and 2 above. "Off" will appear in the body data panel.

EYE-START

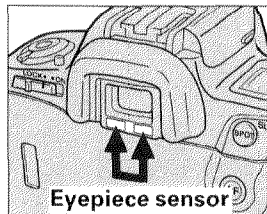
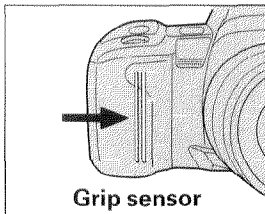
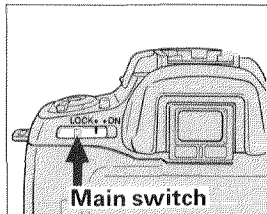

The Eye-Start System automatically activates all of the 700si's main systems as soon as you bring the camera to your eye. When you move the camera's main switch to **ON**, the body data panel and the grip sensor activate. Touching the grip sensor then activates an infrared emitter/detector located beneath the eyepiece. When the eyepiece sensor detects an object near the viewfinder, autofocus and autoexposure immediately activate so that the camera is already operating by the time you frame your main subject.

- When the eyepiece sensor no longer detects an object near the viewfinder, or you break contact with the grip sensor while looking through the viewfinder, autofocus and autoexposure will switch off after five seconds.
- If you are wearing sunglasses which absorb infrared light, Eye-Start may not function.

To turn off Eye-Start:

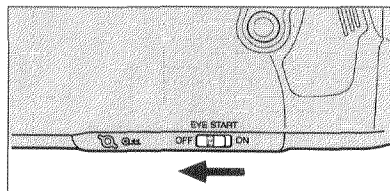

Slide the eye-start switch to OFF.

- To turn Eye-Start on again, slide the eye-start switch to ON.

- When Eye-Start is off, you can activate the camera by pressing the shutter-release partway down.

THE BASICS

PROGRAM-RESET BUTTON

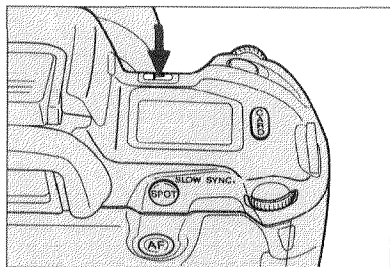

Press the program-reset button to return the following camera functions to their program settings.

Function	Program Setting
Focus area	Wide
Focus mode	Autofocus
Metering mode	14-segment honeycomb-pattern
Exposure mode	P mode
Exposure compensation	+/- 0.0
Built-in flash	Auto on (when up)
Flash compensation	+/- 0.0
Accessory flash (when attached)	Auto on
Film-drive mode	Single-frame advance
Self-timer	Canceled
Shutter-release mode	Autofocus priority

- If you have a dedicated, accessory flash attached to the 700si, pressing the program-reset button will also return it to its own program settings. Refer to the flash instruction manual for details.
- Many of the above settings may be changed with the Customized Function Card xi, available separately.

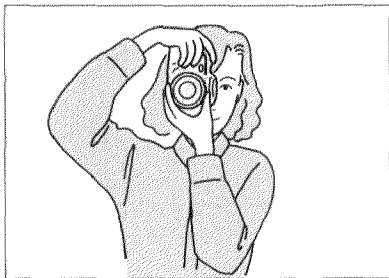

Hold the grip firmly in your right hand and use your left hand to support the camera or lens. Keep your elbows securely against your sides when shooting both horizontal and vertical pictures. When taking a picture, press the shutter-release button gently in a single, steady motion – never with a quick jab. Always keep the camera strap around you neck or wound around one wrist.

- When you pick up the camera, make sure you touch the grip sensor. Otherwise, Eye-start will not function.
- Do not touch the focusing ring of an AF lens or the end of the lens barrel of an xi-Series Autozoom lens.
- Do not block the AF illuminator when you are using autofocus.

The following indicators will appear in the viewfinder while Eye-Start is activated and when the shutter-release button is pressed partway down.

Focus Area



Horizontal

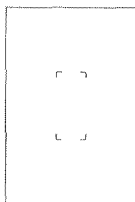

Vertical

This is the camera's wide focusing area as it appears when the camera is held vertically or horizontally. Place your main subject somewhere within this frame.

Focus Signals



When the blinking ● or (()) appear, the camera cannot focus on the subject. See Special Focusing Situations (p.36).

● Shutter is locked unless you select release priority (p.77).

(()) indicates that focus is confirmed in continuous AF.

The focus signal ● appears after you press the shutter-release button partway down indicating that focus is locked. You can take the picture.

● None of the indicators appear while the lens is focusing.

Exposure Settings



A is the shutter speed the camera is currently using and B is the aperture setting.

Camera-Shake Warning



When the camera-shake warning blinks, your subject or scene is too dark for a sharp hand-held photograph. Raise the built-in flash or use a tripod. See page 58 for information on using flash.

- This indicator only appears in P and A modes.

Metering-Mode Indicator



This indicator represents the current metering mode (Honeycomb-Pattern Metering is shown). See Metering Details starting on page 38 for more information.

Flash Signals

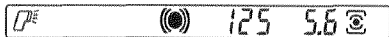

The flash-on indicator blinks when flash is needed (see page 60) and glows when flash will fire with the next shutter release.



The flash signals light when flash is charged. You can take the picture. For more information on flash, see Flash Details starting on page 58.

Frame Counter



When you are reaching the end of a roll of film, a frame counter appears in the viewfinder data panel to countdown the last nine frames.

- If both the shutter-speed and aperture settings, or metering-mode indicators blink in the viewfinder, see page 44.

FOCUS DETAILS

AUTOFOCUS

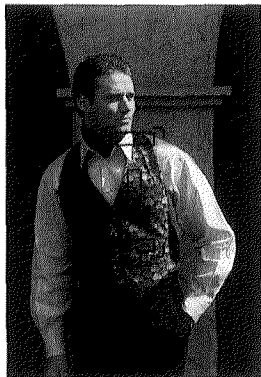
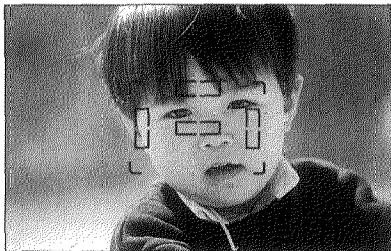

When you activate the camera, either by Eye-Start or pressing the shutter-release button partway down, the autofocus system automatically:

- Adjusts the focus frame for vertical or horizontal camera orientation.
- Determines which of the four AF sensors (three with vertically-framed pictures) is detecting the main subject.
- Activates continuous AF and maintains focus on moving subjects.

The 700si can accurately focus on subjects moving towards or away from the camera or across the scene and will predict their position at the time of a shutter release. The 700si also has focus-priority shutter release. This will lock the shutter until the subject is in sharp focus. Release priority mode is also available. In this mode, continuous autofocus and predictive focus control will continue to function, but sharp focus is not required for the shutter to release. See page 77 for details.

AF Illuminator

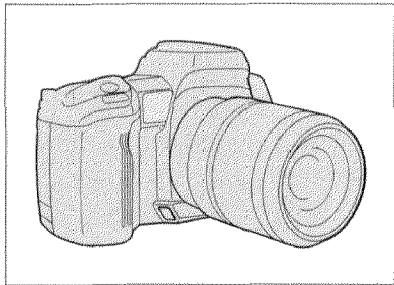

The 700si's AF system operates in light levels as low as -1 EV . In low light or when the contrast of your main subject is too low to be read by the autofocus sensors, the AF illuminator will automatically activate. It projects a pattern of lines onto your subject which the AF sensors can then detect.

- Be careful not to obstruct the AF illuminator while you are holding the camera.
- The range of the AF illuminator is 0.7 - 7m.
- The AF illuminator will not work if the focal length of the lens you are using is 300mm or longer (excluding AF Zoom/AF Zoom xi 100-300 and AF Zoom 75-300) or if you are using the 3X-1X Macro Zoom.

When you are taking pictures with your main subject off-center, first lock focus on it, then recompose the scene as desired. You can also use this function to see which local focus area the camera is using to focus on the subject.



1. Place your subject within the focus area.

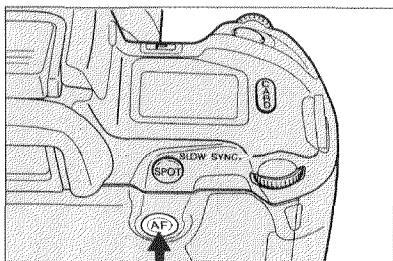

2. Press and hold the AF button. The camera first focuses on the subject and then locks focus. The focus signal ● appears in the viewfinder data panel. A local focus area indicator appears in the viewfinder screen where the camera is focusing on the subject. You can choose a different area by turning the front control dial (see page 34).



● If ● blinks in the viewfinder, the camera cannot focus on the subject. See Special Focusing Situations (p.36).



3. Continuing to hold the AF button, recompose the scene and press the shutter-release button all the way to take the picture.

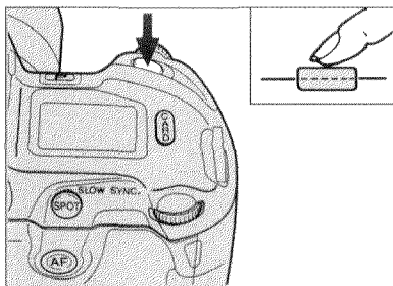

- You can also lock focus by pressing the shutter-release button partway down. In honeycomb-pattern and spot metering, exposure locks as well.

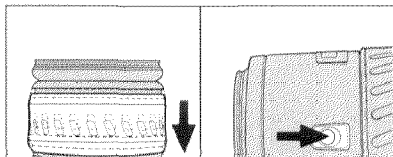

- With an xi-Series lens, you can lock focus by pulling the lens control ring toward the camera. Focus can also be locked with some manual zoom lenses by pressing their focus-hold button.

LOCAL FOCUS AREA SELECTION

If you want to use a specific local focus area, you can manually override the automatic selection sequence and use only one of the four areas.

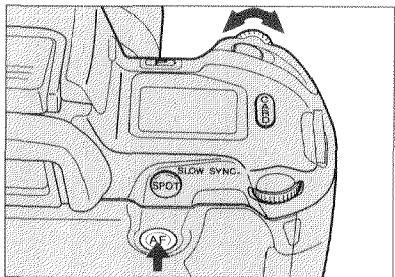

1. While pressing the AF button turn the front control dial until the local focus area you want appears in the viewfinder.

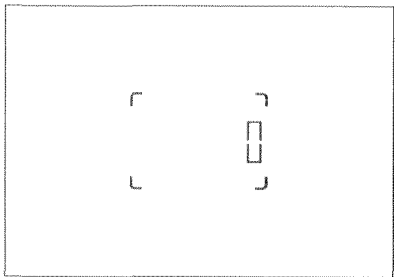

2. Release the AF button to enter the area you have selected. The selected local focus area indicator will remain in the viewfinder.

- To return to the wide focus area, press and hold the AF button and turn the front control dial one click.
- When the RF 500mm lens or the AF Power Zoom 35-80mm lens is attached, only the center local focus area can be selected.

To manually focus the lens:

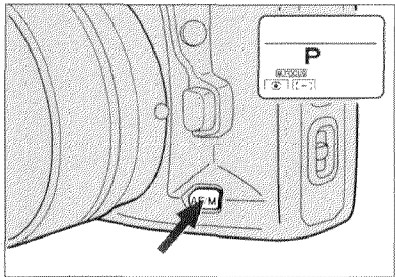

1. Press the focus-mode button to set the camera to manual focus mode. **M. FOCUS** will appear in the body data panel.

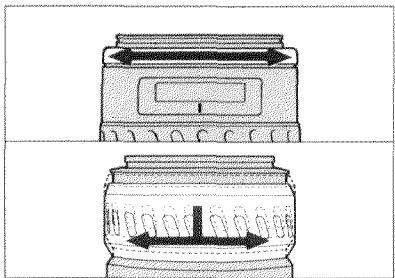

2. If you are using an AF-series lens, turn the focusing ring until the subject appears sharp. With an xi-Series lens or AF power zoom lens, pull and turn the control ring. For more information, refer to the lens instruction manual.

- Whenever any of the four AF sensors (three if you are holding the camera vertically) detects a focused image, focus signal ● will appear in the viewfinder data panel.
- In manual focus mode, the shutter will release even if the subject is not in focus.
- To return to autofocus mode, press the focus-mode button.

The 700si's autofocus system will produce sharply focused pictures in almost any situation. In the cases described below, however, it may be difficult or impossible for the camera to correctly focus on your subject--you may have to use focus lock (p.32) or manual focus (p.35).

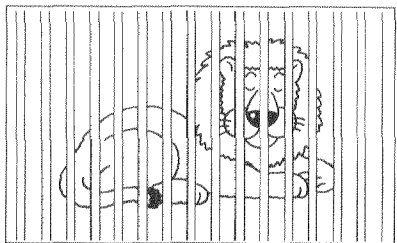

If two subjects at different distances overlap within the focusing frame

- Photographing through windows should not be a problem unless they are very dirty or a window frame or other object passes through the focus frame.

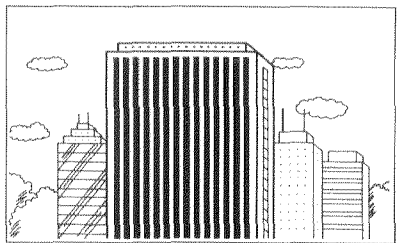

If a subject composed of alternating light and dark lines completely fills the focusing frame

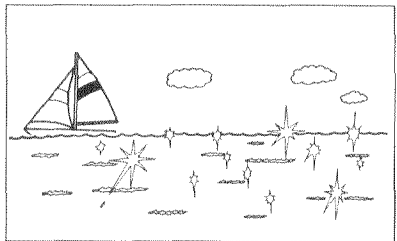

On very bright, very dark, or low-contrast subjects

METERING DETAILS

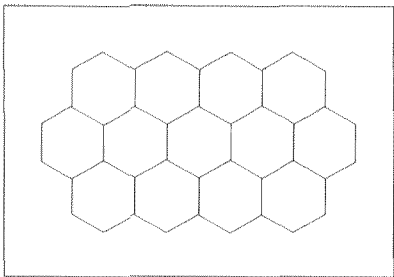

honeycomb segments separately to determine the degree of spot-lighting or backlighting present in your scene.

To select 14-segment honeycomb pattern metering:

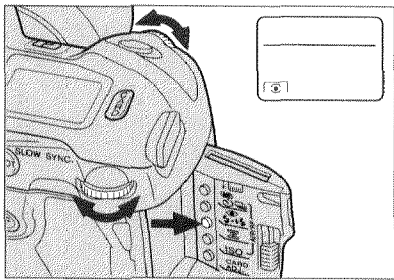

1. Open the card door and press the metering-mode button.
2. Turn either control dial until  appears in the body data panel.
3. Press the shutter-release button partway down to enter your selection.

● You can lock exposure with focus by pressing the shutter-release button partway down.

Comparing honeycomb-pattern metering with center-weighted average metering

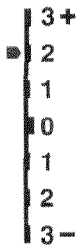

When 14-segment honeycomb-pattern metering is being used in P, A, or S mode and the exposure-compensation button is pressed, the metering index will appear. The middle of the scale 0 represents an unbiased, center-weighted average reading and the pointer shows the difference between it and a reading made by 14-segment honeycomb-pattern metering. This lets you see the adjustments made by honeycomb-pattern metering for backlit, spotlight, or off-center subjects. This will also include any exposure compensation set manually. See Exposure Compensation (p.54).

- In M mode, the metering index will always appear and will display the difference between your exposure settings and those suggested by honeycomb-pattern metering.

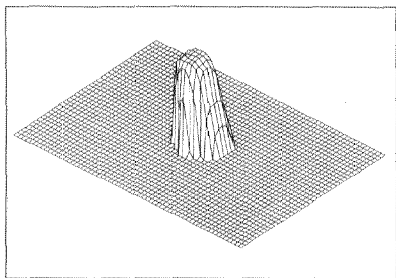

With the 700si, you can select spot metering temporarily using the spot button or full-time as a metering mode. When selected it uses only the center segment of the honey-comb pattern to read the brightness of the subject inside the viewfinder's spot-metering area.

To select spot metering:

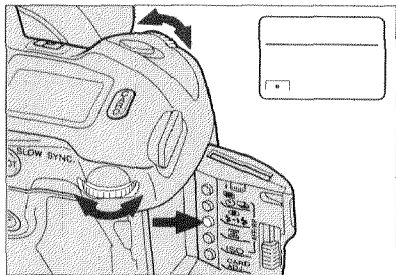

1. Open the card door and press the metering-mode button.
2. Turn either control dial until  appears in the body data panel.
3. Press the shutter-release button partway down to enter your selection.

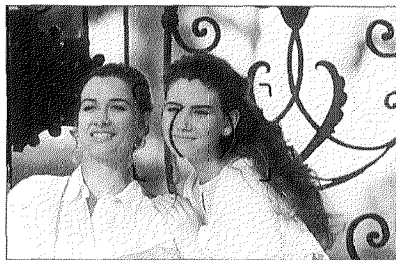

4. Center the spot-metering circle in the viewfinder over the area that you want to meter and press the shutter release button all the way down to take the picture.
- To lock the spot reading, press and hold the spot button while you take the picture (see p.41). To lock exposure and focus, press the shutter-release button partway down.

Using the Spot Button

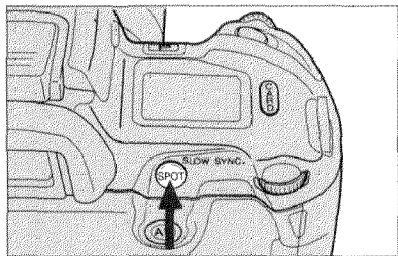
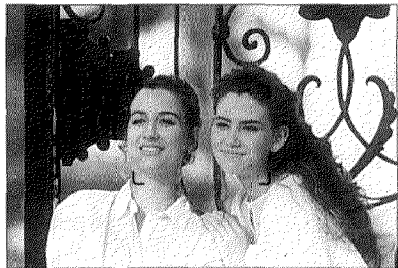

1. Place the area you want to meter in the center of the viewfinder.

2. Press and hold the spot button. The metering index appears in the viewfinder.

3. Recompose the scene as desired.

- The pointer on the metering index will indicate the difference between the locked spot reading and the reading of the area currently inside the spot area. You can use this to make a quick comparison of highlight and shadow areas.

4. Press the shutter-release button all the way down to take the picture.

- In manual exposure (M) mode, the metering index will always appear and will display the difference between your exposure settings and those suggested by spot metering.

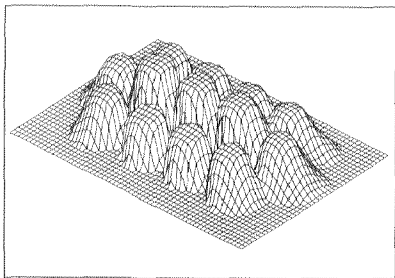

In center-weighted average mode, the exposure is based on an average of the readings made by each of the honeycomb segments, with emphasis placed on the center of the image. Take care when photographing backlit, spotlight, or off-center subjects because the meter may include non-subject areas of your scene when calculating the exposure. To correct or prevent this, use exposure compensation (p.54) or exposure bracketing (p.56).

To select center-weighted average metering:

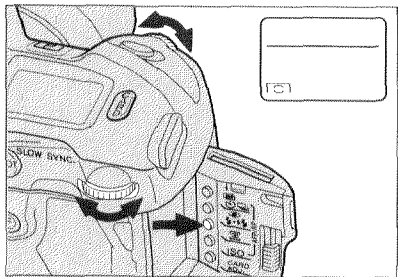

1. Open the card door and press the metering-mode button.
2. Turn either control dial until  appears in the body data panel.
3. Press the shutter-release button partway down to enter your selection.

EXPOSURE DETAILS

P: PROGRAMMED AUTOEXPOSURE

P mode is designed to be the camera's most versatile and flexible exposure mode. When you focus on your main subject, Expert Program Selection automatically analyzes subject size, motion, and magnification as well as lens focal length, and it then sets both the shutter speed and aperture according to the requirements of the scene.

To select P mode:

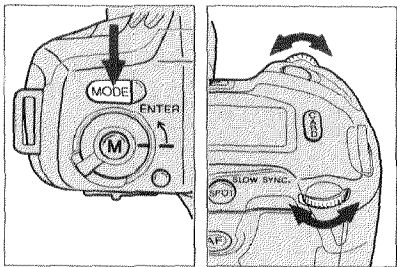

1. While pressing the exposure-mode button, turn either control dial until **P** appears in the body data panel.
 2. Release the exposure-mode button to enter your selection.
- P mode will also be set automatically when you press the program-reset button.

If  blinks, use flash or set the camera on a tripod. The shutter speed selected is too slow to permit a clear hand-held picture.

If the following indicators blink in the viewfinder or body data panel in bright light, attach a neutral density filter. In low light, use a faster lens.

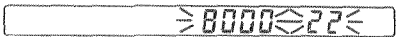

Scene or subject brightness is beyond the camera's metering range. Light level is beyond the range of available shutter speeds and apertures.

PA and Ps: Creative Program Control

When the camera is in **P** mode, you can change the shutter speed or aperture automatically set by Expert Program Selection in 1/2-stop increments while maintaining a correct exposure.

To use PA or Ps:

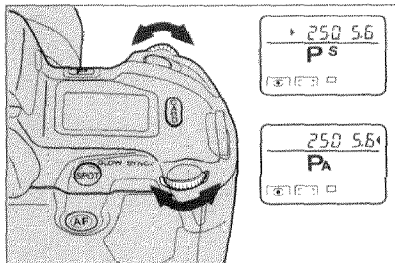

Turn the rear control dial until the desired aperture setting appears in the viewfinder and body data panels or turn the front dial to select the shutter speed setting. PA or Ps appears in the body data panel.



In PA mode, if the shutter speed blinks, turn the rear control dial until the blinking stops

Similarly, if the aperture blinks in Ps, turn the front control dial until the blinking stops.

- To cancel PA or Ps, and return to P mode press the exposure-mode button. PA and Ps will also be canceled when you raise the built-in flash.
- The built-in flash or an attached accessory flash will not fire while the camera is in PA or Ps mode. Similarly, Creative Program Control will not work if the built-in flash is up or an accessory flash is attached to the camera and the flash-on indicator  appears in the viewfinder data panel.

A: APERTURE-PRIORITY AUTOEXPOSURE

In **A** mode, you select the aperture you want and the camera's Expert AE system automatically sets a shutter speed which will provide a correct exposure. Use this mode when you want control over depth of field.

To use A mode:

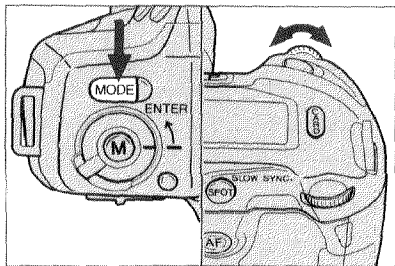

1. While pressing the exposure-mode button, turn either control dial until **A** appears in the body data panel.

2. Release the exposure-mode button to enter your selection.

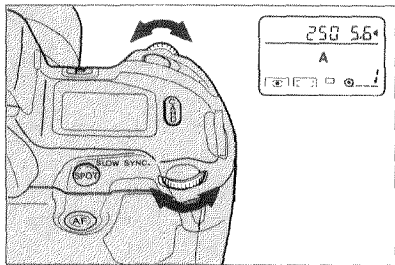

3. Compose your scene and turn either control dial to select the aperture you want. The aperture display in the viewfinder and body data panels will change in 1/2-stop increments with each click of the dial.

● If you have turned off Eye-Start, first press the shutter-release partway down to confirm the shutter-speed setting before you take the picture.

The following exposure warnings may appear in the viewfinder data panel:



If the camera-shake warning  blinks in the viewfinder data panel, the current shutter speed is too slow to permit a clear, hand-held picture. Use flash, set the camera on a tripod, or select a larger aperture (smaller f-number).

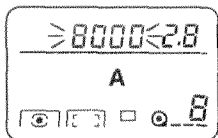

If the fastest shutter speed blinks, select a smaller aperture (larger f-number). Subject brightness is too high for a correct exposure with the aperture you have selected.

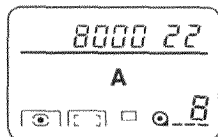

If the metering-mode indicator  blinks, the light level is beyond the camera's metering range. In bright light, attach a neutral density filter; in low light, use a faster lens.

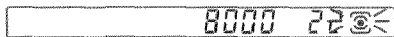

S: SHUTTER-PRIORITY AUTOEXPOSURE

This exposure mode allows you to select the shutter speed you want and the camera's Expert AE system sets the aperture which will provide a correct exposure. Use **S** mode when you want full control over shutter speed settings to create motion effects in your pictures.

To use S mode:

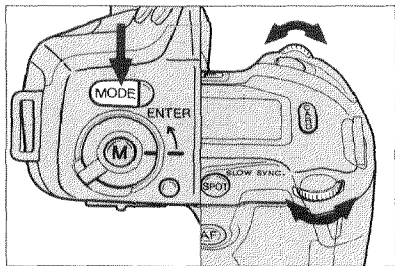

1. While pressing the exposure-mode button, turn either control dial until **S** appears in the body data panel.

2. Release the exposure-mode button to enter your selection.

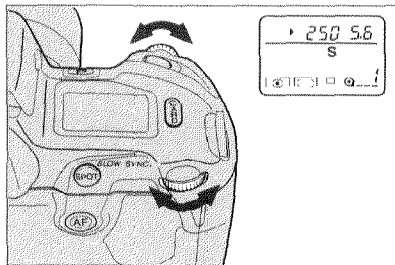

3. Compose the scene and turn either control dial to select the shutter speed you want. The shutter-speed display in the viewfinder and body data panels will change in 1/2-stop increments with each click of the dial.

● If you have turned off Eye-Start, first press the shutter-release button partway down to confirm the aperture setting before you take the picture.

The following exposure warnings may appear in the viewfinder data panel:

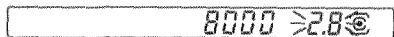
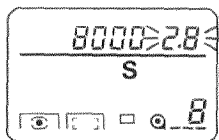

If the aperture display blinks, turn either control dial until the blinking stops. A correct exposure is not possible with the shutter speed you have selected.

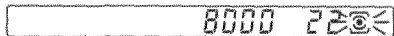
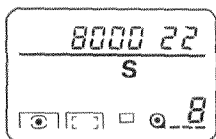

If the metering-mode indicator  blinks, the light level is beyond the camera's metering range. In bright light, attach a neutral density filter; in low light, use a faster lens.

M: MANUAL EXPOSURE

Use manual mode whenever you want full control over the exposure settings. In this mode, you select the shutter speed and aperture and the metering index will tell you whether your settings will provide an over-, under-, or correctly-exposed picture.

To use M mode:

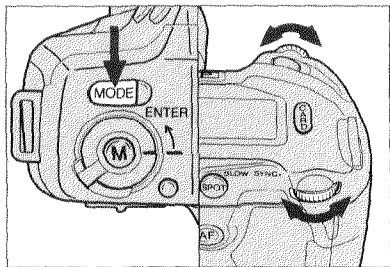

1. While pressing the exposure-mode button, turn either control dial until **M** appears in the body data panel.

- The metering index appears in the viewfinder.

2. Release the exposure-mode button to enter your selection.

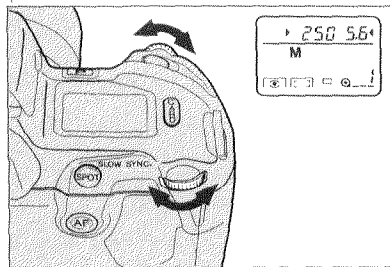

3. Compose your scene and turn the front dial to change the shutter speed and the rear dial to change the aperture. The shutter speed and aperture displays in the viewfinder and body data panels will change in 1/2-stop increments.

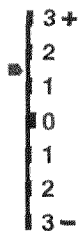

In manual mode, the metering index will show you how the exposure you have set compares with the camera's meter reading. The **0** position on the index represents the camera's suggested exposure using the current metering method. The pointer indicates your settings in relation to this reading.

- **+** or **-** appears between the shutter-speed and aperture setting to indicate whether your exposure settings are over or under the camera's suggested exposure value.
- If the metering-mode indicator  blinks, the light level is beyond the camera's metering range. In bright light, attach a neutral density filter; in low light, use a faster lens.

Bulb

When you select BULB, the shutter will remain open as long as you press the shutter-release button. Use it to make long exposures.

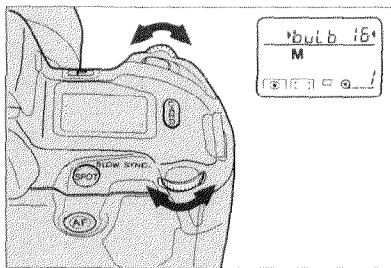

1. Mount the camera on a tripod.
2. While in M mode, turn the front control dial to the left until **bulb** appears in the body and viewfinder data panels. Turn the rear dial to set the aperture.
3. Compose your scene and focus the lens. If the scene is too dark, autofocus may not function. Press the focus-mode button and focus the lens manually.

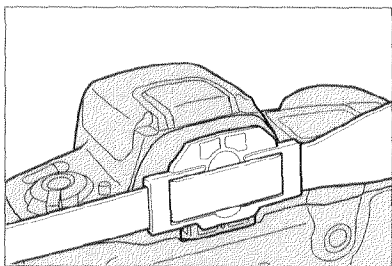

4. Attach the eyepiece cap (see p.10).

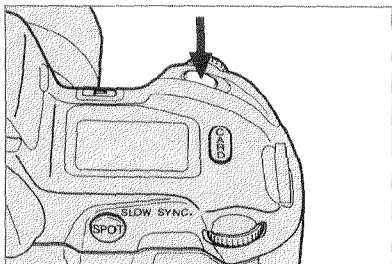

5. To take the picture, press and hold the shutter-release button. The shutter will remain open until you release the button.

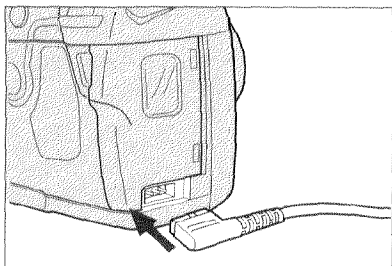

● To reduce or prevent blurring of your picture due to camera shake, attach Remote Cord RC-1000 S or L. Open the card door, remove the remote-control terminal cover, and insert the remote cord's plug into the terminal. The shutter will remain open as long as you hold the remote control button down.

DOUBLE EXPOSURE

Double-exposure mode lets you overlap two images on the same frame.

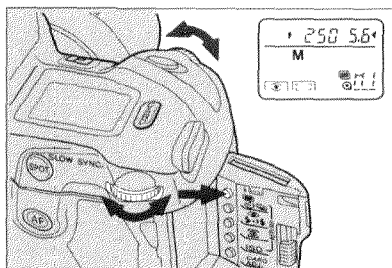

1. Open the card door and press the self-timer/drive-mode button.
2. Turn either control dial until  appears in the body data panel.
3. Press the shutter-release button partway down to enter your selection. M1 will appear in body data panel's frame counter.

4. Compose the scene and press the shutter-release button all the way down to take the first picture. M2 will appear in the body data panel's frame counter.
 5. Press the shutter-release button all the way down again to take the second picture.
- Double-exposure mode is canceled and the drive-mode is set to single-frame advance after both pictures are taken.

EXPOSURE COMPENSATION

This function enables you to bias the camera's exposure calculation up to 3 stops over or under the normally metered settings.

To set a compensation factor:

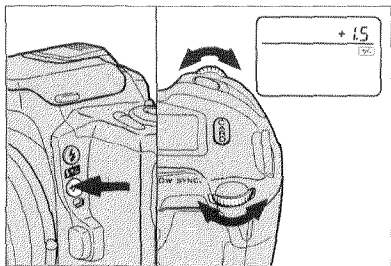

1. While pressing the exposure-compensation button, turn either control dial until the compensation factor you want appears in the viewfinder and body data panels.

- The metering index appears in the viewfinder. See Metering Index (p.71).

2. Release the exposure-compensation button to enter the compensation factor.

- The number and the metering index will disappear, but the compensation indicator will remain in viewfinder data panel and the exposure-compensation reminder in the body data panel. To check the amount of compensation at any time, press the exposure-compensation button.

- In 14-segment honeycomb-pattern metering the position of the pointer will be determined by any exposure adjustment which the camera has made automatically to correctly expose the main subject in addition to any compensation which you set manually. When center-weighted average or spot metering is selected, the pointer will show only the compensation which you set (see Metering Index, p.71).

Honeycomb-pattern metering selected

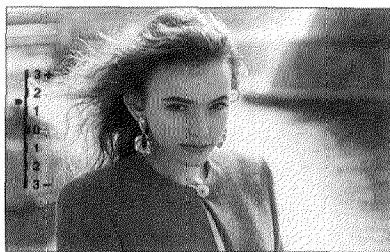
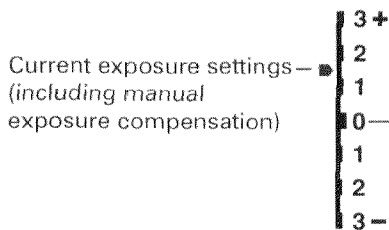

Exposure determined by center-weighted average metering

Center-weighted average or spot metering selected

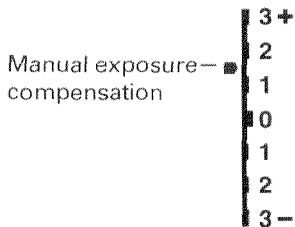

To cancel exposure compensation, set 0.0.

EXPOSURE BRACKETING

With exposure bracketing you can expose a series of 3 frames with a 1/2-stop change between exposures. The order of the exposures will be 1/2-stop under metered exposure, metered exposure, and 1/2-stop over metered exposure.

To make an exposure-bracketing series:

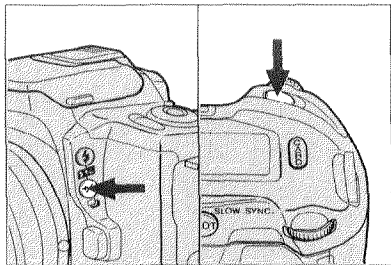

While pressing the exposure-compensation button, press the shutter-release button all the way down to take the picture. Hold the shutter-release button and exposure-compensation button down until the series is complete. Releasing either button will cancel the series. The film will stop automatically after three frames have been exposed.

- The metering index appears in the viewfinder with three pointers indicating the exposures to be made. The center pointer represents the initial meter reading.
- Focus and metering are locked on the first frame of the series.
- The film will advance in continuous mode and the exposure settings will change automatically.
- Flash cannot be used.

FLASH DETAILS

BUILT-IN FLASH

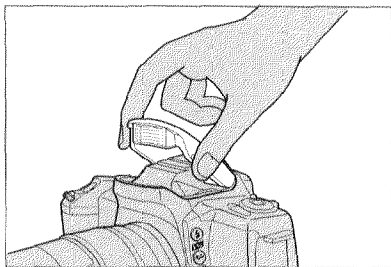

The 700si is equipped with a built-in flash which uses the camera's TTL (through-the-lens) flash metering system to control the flash output and ensure proper exposure. To activate the built-in flash, gently lift it. To use the built-in flash in P mode, refer to page 60; to use it in A, S, or M mode, refer to page 62.

Flash Range		
Aperture	ISO 100	ISO 400
f/2.8	4.2m (13.7 ft.)	8.5m (27.8 ft.)
f/4	3m (9.8 ft.)	6m (19.6 ft.)
f/5.6	2.1m (6.8 ft.)	4.2m (13.7 ft.)

- While the built-in flash is charging, the shutter is locked; wait until the flash signals appear in the viewfinder to take the picture.
- When you have finished using the built-in flash, push it back down to save battery power.

CAUTION

- Remove the lens hood before taking pictures with the built-in flash, otherwise shadowing may occur.
- Shadowing also may occur when the AF 28-85 f/3.5-4.5, AF 28-135 f/4-4.5, or AF 28-70 f/2.8 G lens is used with the built-in flash. Contact your nearest MINOLTA Service Facility for their conditions of use.
- The built-in flash cannot be used with AF 300mm f/2.8 TELE, AF 300mm f/2.8 TELE(N), AF 600mm f/4 TELE, or AF 600mm f/4 TELE (N) lenses.

RED-EYE REDUCTION

In photographs of people, sometimes the subject's eyes appear to glow red (white in black and white pictures). This is caused by light from the flash reflecting from the retina of the eyes into the lens. The 700si has a pre-flash function which significantly minimizes red-eye. When selected, the flash fires a series of small bursts before the main burst. This causes your subject's pupils to close greatly reducing the amount of light which will reflect off the retina.

To select pre-flash:

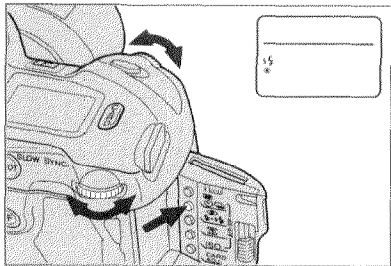





1. Open the card door and press the flash-mode button.
2. Turn either control dial until  appears in the body data panel.
 - The pre-flash will fire before every flash exposure.
3. Press the shutter-release button partway down to enter your selection.

- To cancel pre-flash, repeat the procedure so that the red-eye mark disappears from the data panel.
- Before you use pre-flash, warn your subject that the flash will fire several bursts before the picture is taken.

P MODE FLASH

The 700si automatically fires the flash when the subject is backlit or ambient lighting is low. The camera uses TTL (through-the-lens) control to ensure a proper exposure and shutter speeds are automatically set between 1/200 second and 1/60 second.

Viewfinder Signals

- When the built-in flash is up or a dedicated flash is attached and on, the flash-on indicator  appears in the viewfinder data panel when the camera's metering system detects that flash is required.
- The flash signals  (pre-flash selected) will light when the flash is fully charged.
- After you release the shutter, if the flash output was sufficient to provide a correct exposure, the flash signals will blink.
- When the 5400HS flash unit is attached and shutter speeds are 1/200 second or faster, High-Speed Sync (HSS) Flash is automatically selected and  appears in the viewfinder and body data panels. See the 5400HS instruction manual for details.
- If the flash-on indicator  blinks in the viewfinder, flash is required. Raise the built-in flash.
- The built-in flash or an attached accessory flash will not fire while the camera is in Ps or PA mode. See page 45 for details on Creative Program Control.

Manual Fill-Flash

In P mode even though the camera usually determines automatically when flash is necessary, you can also manually fire the built-in flash or attached accessory flash at any time. This will help reduce harsh shadows that occur with strong lighting.

To fire the flash manually:

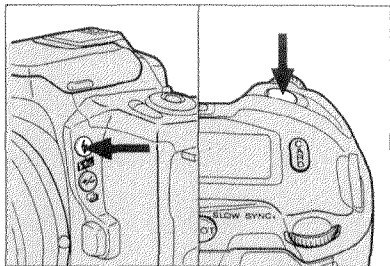



Make sure the built-in flash is up or the attached, dedicated flash is on. Then, while pressing the flash-control button, press the shutter-release button all the way down to take the picture.

A, S, AND M MODE FLASH

In A, S, or M mode when the built-in flash is up or an accessory flash is attached and on, the flash will fire each time you take a picture. The camera uses TTL control to ensure proper exposure. Camera operation in these three exposure modes with flash is the same as without flash except you cannot use shutter speeds faster than the camera's top x-sync speed, 1/200 second.

- If the 5400HS flash unit is attached, High-Speed Sync (HSS) Flash is available and any shutter speed up to 1/8000 second can be selected.  appears in the viewfinder and body data panels when it is selected. See the 5400HS instruction manual for details.

Viewfinder Signals

- The flash-on indicator  appears to indicate that the flash will fire with the next shutter release.
- The flash signals  (pre-flash selected) will light when the flash is charged.
- After you release the shutter, if the flash output was sufficient to provide a correct exposure, the flash signals will blink.

SLOW-SHUTTER SYNC



With slow-shutter sync



Without slow-shutter sync

In P and A modes, slow-shutter sync sets a slower shutter speed to increase the background or ambient lighting exposure in a flash picture. Flash output will be automatically decreased to maintain a correct exposure of your subject.

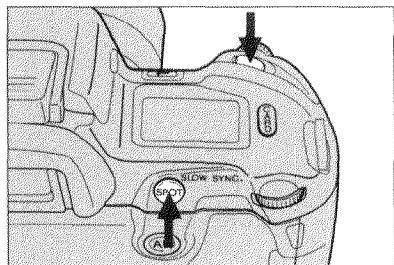

1. Frame your subject.
2. While pressing the spot button, press the shutter-release button all the way down to take the picture.

- If the background is bright or a large aperture is set, the shutter speed may not be reduced.
- The flash signals in the viewfinder data panel will blink if the flash output was sufficient to provide a correct exposure.
- If the shutter speed becomes too slow to allow sharp, hand-held pictures after you press the spot button, use a tripod.

FLASH COMPENSATION

This function enables you to bias the flash output of the built-in flash or an attached accessory flash + or -3 stops.

To set a compensation factor:

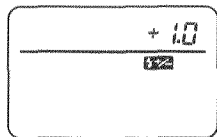
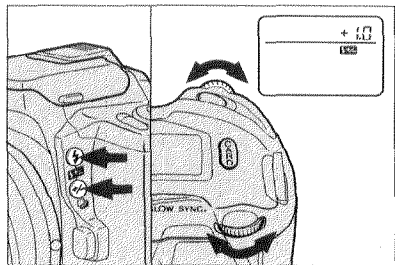

1. While simultaneously pressing the exposure-compensation and flash-control buttons, turn either control dial until the compensation factor you want appears in the viewfinder and body data panels.
2. Release the buttons to enter the factor.

- The flash compensation reminder remains in the viewfinder and body data panels. To check the amount of compensation at any time, simultaneously press the exposure-compensation and flash-control buttons.

- To cancel flash compensation, set 0.0.

REMOTE-WIRELESS OFF-CAMERA FLASH CONTROL

When used with specified xi flash units, this camera offers you the flexibility of remote/wireless off-camera flash control with TTL flash metering.

Setting Control Channel

The flash unit has more than one control channel so you will not interfere with other flash units in remote/wireless mode. To change the control channel, slide the control channel selector located in the battery chamber of the flash. After changing the control channel, attach the flash to the camera and press the shutter-release button partway down to set the camera to the same channel.

Standard Remote/Wireless Operation

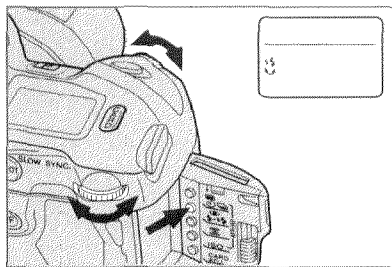

1. Attach the flash to the camera and turn it on.
2. Open the card door and press the flash-mode button.
3. Turn either control dial until  blink alternately in the body data panel.
4. Press the shutter-release button partway down to enter your selection.

● The accessory flash can also be set without attaching it to the camera. With the 3500xi flash unit, press the ON/OFF button so the flash turns on and hold it until the wireless lamp glows. For setting other flashes, see their respective instruction manuals.

5. Remove the flash and position it and the camera according to the chart.
- Make sure the AF illuminator on the flash is pointing at the subject.
 - The off-camera flash may not detect the control signals if it is placed behind the subject.

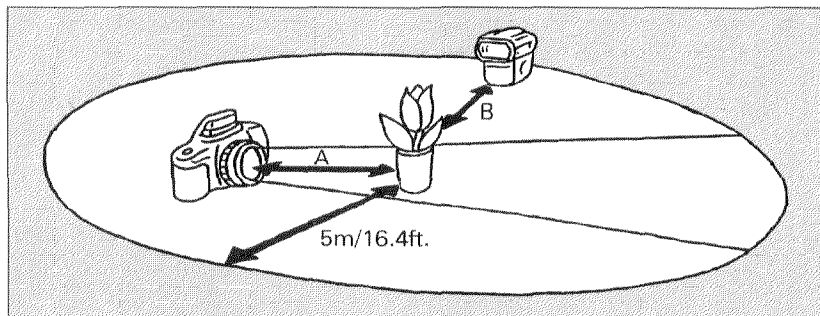

Aperture	Camera-Subject Distance m/ft. (A)		Flash-Subject Distance m/ft. (B)	
	ISO 100	ISO 400	ISO 100	ISO 400
f/2	2-5m/6.6-16.4 ft.	4-5m/13.2-16.4 ft.	2-5m/6.6-16.4 ft.	4-5m/13.2-16.4 ft.
f/2.8	1.4-5m/4.6-16.4 ft.	2.8-5m/9.2-16.4 ft.	1.4-5m/4.6-16.4 ft.	2.8-5m/9.2-16.4 ft.
f/4	1-5m/3.3-16.4 ft.	2-5m/6.6-16.4 ft.	1-5m/3.3-16.4 ft.	2-5m/6.6-16.4 ft.
f/5.6	1-5m (4m)/3.3-16.4 ft. (13.1 ft.)*	1.4-5m/4.6-16.4 ft.	0.7-4m/2.3-13.1 ft.	1.4-5m/4.6-16.4 ft.
f/8	1-5m (2.8m)/3.3-16.4 ft. (8.8 ft.)*	1-5m/3.3-16.4 ft.	0.5-2.8m/1.6-8.8 ft.	1-5m/3.3-16.4 ft.
f/11	1-5m (2m)/3.3-16.4 ft. (6.6 ft.)*	1-5m/3.3-16.4 ft.	0.4-2m/1.3-6.6 ft.	0.7-4m/2.3-13.1 ft.

*Values in parentheses indicate the maximum distance for wireless/remote ratio control (pp. 33, 35).

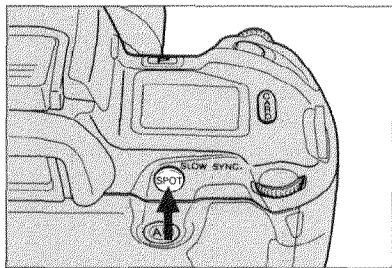
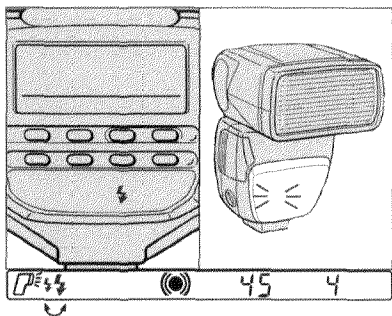

6. Lift the built-in flash and wait until both the off-camera flash and built-in flash are charged.

- In remote/wireless mode, the off-camera flash's AF illuminator will blink when the flash is charged. When the built-in flash is charged,  will appear and blink alternately in the camera's viewfinder data panel.

7. Press the spot button to test-fire the off-camera flash and wait again until both flashes are fully charged.

8. Press the shutter-release button all the way down to take the picture.

- The flash signals in the viewfinder data panel will blink if the flash output was sufficient to provide a correct exposure.

- When modeling-flash mode is selected on the 5400HS flash unit, pressing the spot button activates the modeling flash.
- You can control any number of off-camera flash units set to remote/wireless mode.
- Because the signal that fires the off-camera flash is a small burst from the built-in flash, reduce the brightness of your surroundings as much as possible.

Canceling Remote/Wireless Flash Mode

- To cancel remote/wireless flash mode on the camera, open the card door and press the flash-mode button. Then, turn either control dial to select another flash mode.
- To cancel remote/wireless flash mode on the 3500xi flash unit, press the ON/OFF button so the flash is on and hold it until the wireless lamp extinguishes. For canceling remote/wireless flash mode on other flash units, see their respective instruction manuals.

Remote/Wireless Slow-Shutter Sync

In remote/wireless slow-shutter sync mode, the camera sets a slow shutter speed and reduces the flash output to maintain a correct exposure.

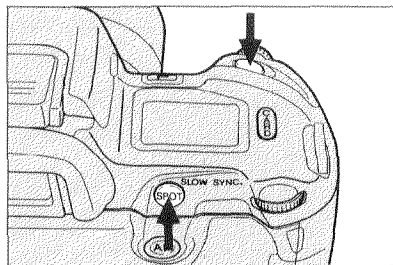

1. Press and hold the spot button. The off-camera flash will first fire a test burst. Do not release the spot button until after you have taken the picture.
2. Continue to hold the spot button while the flashes are charging. When  appears in the camera's viewfinder data panel, and the AF illuminator of the off-camera flash blink, press the shutter-release button all the way down to take the picture.

Wireless/Remote Ratio Control

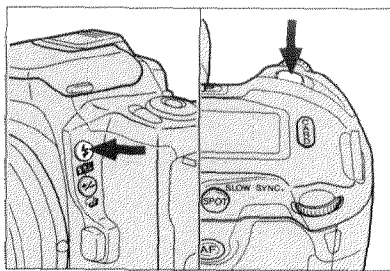

In remote/wireless mode, the off-camera flash and built-in flash can work together to provide a 2:1 lighting ratio on your subject. While pressing the flash-control button, press the shutter-release button all the way down to take the picture. The off-camera flash will provide 2/3 of the exposure and the built-in flash will add the remaining 1/3.

Wireless/Remote Ratio Control with the Wireless Remote Flash Controller, and Multiple Off-Camera Flash Units

When the Wireless Remote Flash Controller is attached to the 700si, a 2:1 or 1:2 lighting ratio is available between two flashes placed off-camera. You can obtain 2:1 and 1:2 lighting ratios using the 5400HS and/or the 5400xi. If you are using one 5400HS or 5400xi and one 3500xi, the only ratio possible is 5400xi/5400HS [1]:[2] 3500xi. Refer to the Wireless Remote Flash Controller instruction manual and the 5400xi or 5400HS instruction manual for details.

ADDITIONAL FEATURES

METERING INDEX

The table below summarizes the situations in which the metering index will appear in the viewfinder screen.

	When the Index Appears	0 Position on Index	Pointer
P / A / S	14-Segment Honeycomb-Pattern metering is selected and the exposure-compensation button is pressed	Exposure calculated by center-weighted average metering	Current exposure settings*
	Center-weighted average metering is selected and the exposure-compensation button is pressed	Un-biased center-weighted average reading	Amount of compensation
	Spot metering is selected and the exposure-compensation button is pressed	Un-biased spot reading	Amount of compensation
	While the spot button is pressed	Locked spot reading	Difference in exposure required by area currently inside the spot circle
	In manual exposure mode	Exposure calculated by camera using current metering mode	Difference in exposure provided by manual camera settings

*This will include any exposure compensation you have set manually in addition to the adjustment made by honeycomb-pattern metering for backlit, spotlight, or off-center subjects.

- The pointer will blink if the indicated value is greater than +3 EV or less than -3 EV.

MEMORY

With Memory you can store a wide range of your most-often-used camera settings or settings for a particular event (listed below) and recall them at any time by pressing the memory recall button. To return to the camera's programmed settings, press the program-reset button (see p.24).

Functions	Settings that can be stored in Memory
Exposure mode	P/A/S/M
Aperture settings	f/1.0-f/64 (depends on lens)
Shutter-speed settings	1/8000 – 30 sec. or BULB
Film-drive mode	Single-frame advance, Continuous advance, Double exposure, or Self-timer
Flash mode	Pre-flash on, Pre-flash off, or Remote/Wireless mode
Exposure compensation	+ / – 3.0 EV in 0.5 EV steps
Flash compensation	+ / – 3.0 EV in 0.5 EV steps
Metering mode	Honeycomb-pattern, Spot, or Center-weighted average metering
Focus area	Wide or one of the four local focus areas
Shutter-release mode	Autofocus or Release priority

To store settings in Memory:

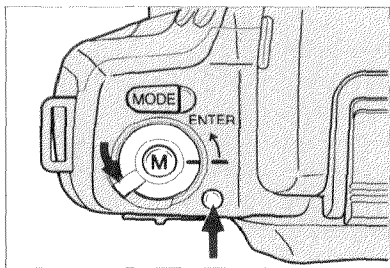

1. Make all the camera settings you want to save (see the chart on the previous page).
2. While pressing the memory-switch release, turn the memory switch to ENTER.
 - **MEMORY** will appear in the body data panel.
3. Release the memory switch. It will return to its locked position.

- When you store your settings in Memory, shutter-speed, aperture, exposure compensation, and flash compensation values will not appear in the data panel, but they will be memorized.

To recall camera settings in Memory:

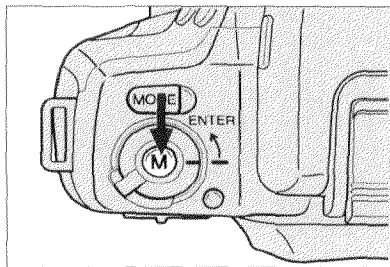



- Press the memory recall button.
- When you want to return to the camera's *programmed* settings, press the program-reset button (see p.24).

SELF-TIMER

The electronic self-timer will delay release of the shutter for approximately 10 seconds after you press the shutter-release button.

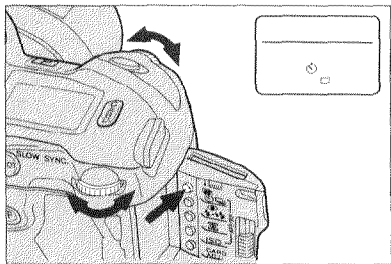

To activate the self-timer:



1. Open the card door and press the self-timer/drive-mode button.
2. Turn either control dial until  appears in the body data panel.
3. Press the shutter-release button partway down to enter your selection.
4. Compose your scene and press the shutter-release button all the way down to start the timer.

- If you are not looking through the viewfinder when you press the shutter-release button, light entering the eyepiece may affect the camera's automatic exposure settings. To prevent this, attach the eyepiece cap before you start the timer (see page 10).
- The AF illuminator will blink twice per second until the shutter releases.
- To cancel the self-timer, slide the main switch to LOCK.
- The self-timer is canceled automatically after shutter-release.

FILM DRIVE

The camera has single-frame and continuous film advance. In single-frame mode  , the camera makes one exposure and advances the film one frame each time you press the shutter-release button. In continuous mode  , the film is advanced at up to 3 frames per second while you hold the shutter-release button down. When you use continuous and autofocus mode, focus will be checked and adjusted between each exposure to ensure that moving subjects remain sharply focused.

To change the film-drive mode:

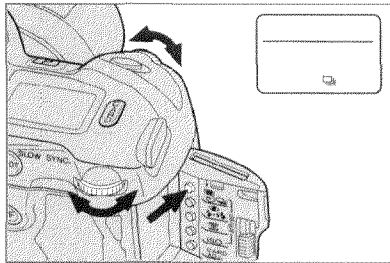

1. Open the card door and press the self-timer/drive-mode button.
2. Turn either control dial until the indicator for the mode you want appears in the body data panel.
3. Press the shutter-release button partway down to enter the mode you selected.

● Because the camera has focus-priority shutter release, the actual frame rate will depend on the speed of your main subject. To ensure the maximum speed of the drive mode you select, you can use release-priority mode. See page 77 for details.

DEPTH-OF-FIELD PREVIEW

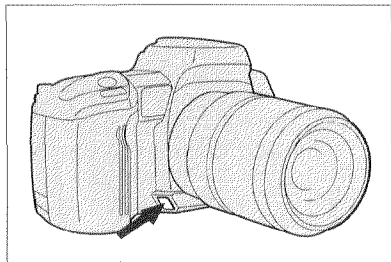
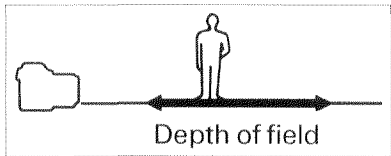

Depth of field is the distance in front of and behind the point on which the lens is focused which will also appear sharp in the final image. To check how much of your scene will appear in focus, press the depth-of-field preview button. This will stop the lens down to the aperture which appears in the data panel. The image in the viewfinder screen will darken when you press the button; the smaller the aperture, the darker it will be.

- The exposure settings cannot be changed while you are pressing the depth-of-field preview button.

RELEASE PRIORITY

The 700si has focus-priority shutter release. With it, the shutter will not release if the subject is not in focus and the camera is in autofocus mode. This helps ensure a high percentage of sharp photographs when you are shooting a moving subject and using continuous-drive mode. This also makes the actual speed of film advance dependent on the speed of your subject.

In release-priority mode, the shutter will release even if the subject is not sharply focused. Continuous autofocus and predictive focus control will continue to operate, but priority will be placed on maintaining the top speed of the drive mode.

When the 700si is manufactured, it will be set to focus-priority mode.

To select release-priority mode:

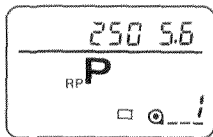
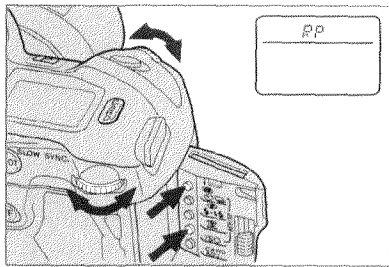

1. Open the card door and simultaneously press self-timer/drive-mode and ISO buttons.

- "AFP" will appear in the body data panel.

2. Turn either control dial until "RP" appears in the body data panel.

3. Press the shutter-release button partway down to enter your selection.

- The release priority indicator **RP** appears in the body data panel.

- When you set release priority, the performance of multi-/omni-dimensional predictive focus control may diminish slightly.

To return to focus-priority mode, repeat 1 through 3 above.

- "AFP" will appear in the body data panel while setting.

IMAGE-SIZE LOCK

Image-Size Lock is available with xi-Series lens. It automatically adjusts the lens' focal length to maintain the size of the main subject's image in the viewfinder.

To use Image-Size Lock:

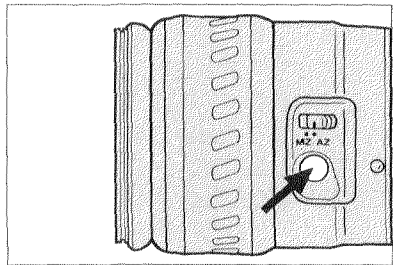

1. Make sure the eye-start switch is set to ON.
2. Compose your subject within the focus area, then press and hold the lens-function button on an xi-Series lens. ISL On will appear in the viewfinder data panels while Image-Size Lock is operating until you press the shutter-release partway down. It will then be replaced by shutter-speed and aperture settings.
3. Press the shutter-release button all the way down whenever you want to take a picture.

- To turn off Image-Size Lock, release the lens-function button.
 - Image-Size Lock is limited by the focal length range of the lens you are using. If either end of the lens focal length range is reached while image-size lock is operating, the lens will stop zooming, but ISL ON will continue to be displayed in the viewfinder data panel. If you subject comes back into range, Image-Size Lock will resume operation.
 - Image-Size Lock may not be able to accurately track high-speed subjects. If your subject is moving too fast, the image size may not remain constant, but ISL ON will continue to be displayed in the viewfinder data panel.
- In the following situations, ISL -- will appear in the viewfinder data panel when you press the lens-function button and Image-Size Lock will not function:
- If your subject is too small and/or too far away for the camera to lock on to it.
 - If the camera cannot focus on your subject (see Special Focusing Situations, p. 36).
 - If the lens is initially set to a focal length shorter than 50mm.

PANORAMA INDICATOR



When you insert the Panorama Adapter in the back of the camera, you must set the camera's viewfinder frame for the panorama format. If you do not insert the adapter, you can use the panorama frame to compose your shots and later have them printed as panoramic pictures.

To turn on the panorama indicator:

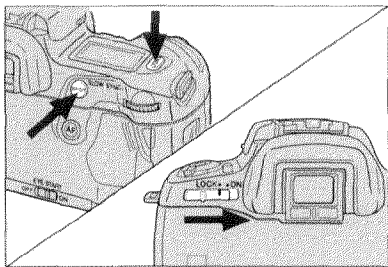

Simultaneously press the card and AF buttons while sliding the main switch from LOCK to ON. The panorama indicator will appear in the viewfinder.

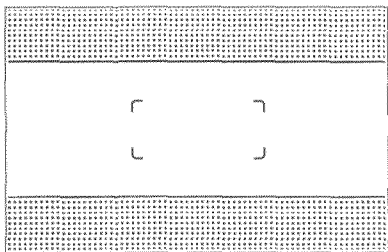

- To reset the standard frame, repeat the procedure.
- Exposed film and printed pictures will be full frame, not panoramic.

APPENDIX

ACCESSORY INFORMATION

If you already have own MINOLTA accessories, check their compatibility before using them with your 700si.

1. LENS

- All Minolta AF lenses can be used with 700si.
- Manual focusing lenses (MD or MC) cannot be attached to the 700si.
- Shadowing on the bottom of your picture may occur when the built-in flash is used together with a lens listed below. Before using any of these lenses with the built-in flash, check with the nearest MINOLTA Service Facility for the conditions of their use.

AF 28-85mm f/3.5-4.5 AF 28-135mm f/4-4.5 AF 28-70mm f/2.8 G

- The built-in flash cannot be used under any conditions with the following lenses.

AF 300mm f/2.8 APO TELE AF 300mm f/2.8 APO TELE (N)

AF 600mm f/4 APO TELE AF 600mm f/4 APO TELE (N)

- Keep in mind, too, that the built-in flash provides coverage for lenses with focal lengths no wider than 24mm.

2. FLASH

- All Minolta i- and xi-Series flash units can be used, as well as the Program Flash 5400HS.
- Flash Shoe Adapter FS-1100 must be used to attach an AF-series flash (Program/Maxxum Flash 4000AF, 2800AF, 1800AF, 1200AF Macro) to your 700si.

When used with the 700si, these units fire whenever a picture is taken, regardless of the exposure mode selected. In all exposure modes TTL flash control will operate.

ACCESSORIES

3. CARDS

	With 700si	Additional Restrictions			
		Exposure Bracketing	Double Exposure	Memory	Focus Lock with AF button
Travel	1,2	○	○	15	○
Child	○	○	○	15	16,17
Sports action	○	○	○	15	17,18
Sports action 2	○	○	○	15	17,18
Portrait	○	○	○	15	○
Automatic depth control	1	○	○	15	19
Closeup	○	○	○	15	○
Panning	3	—	○	15	18
Intervalometer	○	—	○	○	○
Background priority	4	○	○	15	○
Multiple exposure	5,6	—	—	20	○
Exposure bracketing	5,7	—	—	21	○
Flash bracketing	5,8	—	—	22	○
Bracketing 2	8	—	—	22	○
Data memory	5	○	○	○	○
Data memory 2	○	○	○	○	○
Fantasy effect	9	—	○	15	○
Fantasy 2	10	—	○	15	23
Automatic program shift	5,11	—	—	15,21	○
Auto shift 2	○	—	—	21	○
Multi spot memory	12,13	○	○	24	○
Highlight/shadow control	12	○	○	24	○
A/S mode	×	×	×	×	×
Customized function xi	14	○	○	○	○
Customized function	×	×	×	×	×

O: can be used.

X: cannot be used.

- : cannot be used. Card function overrides the camera function. "Card" blinks in the body data panel.

1 to 24: can be used with the conditions listed below.

1. In release priority, the shutter will not release unless the subject is in focus. Continuous film advance is not recommended.
2. ASZ does not function.
3. Metering index can be used to monitor your panning skill. If the indicator is to the + side of the index, tracking is smooth.
4. Metering index can be used to select the background sharpness. If the indicator is to the + side of the index, both near and far objects should appear sharp in the final image.
5. Settings must be made with front control dial.
6. The aperture is fixed when the camera is being used without flash during fade-in/fade-out in M mode.
7. The aperture is fixed when bracketing in M mode.
8. With flash bracketing, exposure adjustment and frame number for the next frame will appear in the body data panel when you take the camera away from your eye.
9. Focus priority is recommended. If you use release priority, make sure that the subject is in focus before you release the shutter. Otherwise, the fantasy effect may not be obtained. Continuous film advance is not recommended.
10. In release priority, the shutter will not release unless the subject is in focus.
11. The starting point of the exposure series cannot be changed from the settings chosen by Expert Program Selection.
12. When you insert this card, spot metering is automatically activated.
13. The number of areas measured will appear in the body data panel when you take the camera away from your eye.
14. When you select metering method in personal program mode, select either honeycomb-pattern or center-weighted average metering.

-
15. The card's programmed-autoexposure mode will remain selected even when the memory-recall button is pressed.
 16. APZ does not function.
 17. If you press the AF button, the camera will focus once and lock.
 18. When this card is activated, the camera is in continuous AF; however, if you press the AF button, the camera will focus once and lock.
 19. Only one frame can be exposed while the AF button is pressed. You have release the AF button before you can take a second picture.
 20. Double-exposure mode cannot be stored in Memory.
 21. Continuous-frame film advance will remain selected even when the memory-recall button is pressed.
 22. Single-frame advance will remain selected even when the memory-recall button is pressed.
 23. When multi-exposure fantasy mode is selected, the second exposure will not be made until the AF button is released.
 24. Spot-metering mode will remain selected even when the memory-recall button is pressed.

4. OTHER

- Control Grip CG-1000 and Data Receiver DR-1000 cannot be used with 700si.

TECHNICAL DETAILS

Type: 35mm SLR with built-in flash and expert control of autofocus (AF) and autoexposure (AE)

Lens Mount: Minolta A-type bayonet mount

Eye-Start System: AF and AE automatically activated by combination of eyepiece sensors and grip sensors; Can be selected and canceled by eye-start switch

AF System: Minolta's through-the-lens (TTL) phase-detection system with four CCD sensors; Activated by eye-start, or if eye-start is canceled, by pressing the shutter-release button partway down; Omni-/Multi-dimensional Predictive Focus Control; Built-in AF illuminator automatically activated in low-light/low-contrast conditions; AF sensitivity range: EV -1 to 18 (at ISO 100 in ambient light); AF illuminator range: 0.7 to 7 m (based on Minolta's standard test methods); Focus lock and local focus area selection available; Manual focus selectable

Metering: TTL-type; 14-segment honeycomb-pattern silicon photocell (SPC); Automatically activated by eye-start, or if eye-start is canceled, by pressing the shutter-release button partway down; Second SPC for TTL flash metering of built-in flash or other dedicated flash unit; Metering modes: Honeycomb-pattern, center-weighted average, or spot metering (2.7% of viewfinder); Range: Honeycomb-pattern metering: EV 0 - 20; Center-weighted average metering: EV 0 - 20; Spot metering: EV 3 - 20 (ISO 100, f/1.4 lens)

Exposure Modes: Programmed AE (P mode): Automatic control of aperture and shutter speed depending on lens specifications and scene characteristics; PA, Ps: Creative Program Control

Aperture-priority AE (A mode): Any available aperture in 0.5 EV increments; Shutter speeds set from 1/8000 to 30 sec. automatically by autoexposure program

Shutter-priority AE (S mode): Any shutter speed from 1/8000 to 30 sec. selectable in 0.5 EV increments; Aperture set automatically by autoexposure program;

Manual (M mode): Any shutter speed/aperture combination selectable in 0.5 EV increments; Correct and over-/under-exposure indicated in viewfinder; BULB setting also selectable

TECHNICAL DETAILS

Built-In Flash: Guide number 12 (in meters at ISO 100); flash coverage for 24mm field of view; Recycling time: Approx. 2.5 sec. (power supplied by camera); Pre-flash for red-eye reduction and remote/wireless off-camera flash control available

TTL Flash Metering: Operates in all flash modes with built-in flash dedicated flash unit; X-sync shutter speed automatically set when flash-on indicator appears in viewfinder; In P, A, or S mode, pressing spot button sets slower shutter speed (down to 30 sec.) to balance flash with ambient lighting;

Programmed AE: Aperture and shutter speeds set automatically; Built-in and attached accessory flash fires automatically when necessary

Shutter-Priority AE: Shutter speeds from 30 sec. to 1/200 sec. selectable; Aperture set automatically; built-in and attached accessory flash will fire when activated

Aperture Priority AE: Any available aperture selectable; Shutter speed automatically set from 1/60 sec. to 1/200 sec.; Built-in and attached accessory flash will fire when activated

Manual: Any shutter speed 1/200 or slower and any available aperture usable; Built-in and attached accessory flash will fire when activated

High-Speed Sync (HSS) Flash available with 5400HS flash unit: Flash can synchronize with camera at shutter speeds 1/200 sec. to 1/8000sec.

Remote/wireless off-camera flash and ratio control are available: Flash sync in remote/wireless mode: 1/60 sec.; Flash sync in ratio control: 1/60 sec.; Control range: 5m

Film-Speed Setting: Automatic setting for DX-coded films ISO 25 - 5000; Manual setting range: ISO 6 - 6400 (1/3-stop increments); Recommended range with flash: ISO 25 - 1000

Flash Compensation: +/- 3 EV (0.5 EV increments)

Exposure Compensation: +/-3 EV (0.5 EV increments)

Exposure Bracketing: -0.5 EV, +/-0.0, +0.5 EV

Auto Programmed Zoom (only available with xi-series Autozoom lenses and specified CE cards): Programmed continuous setting of focal length based on changing subject position

Image-Size Lock (Only available with xi-series Autozoom lenses): Continuous setting of focal length to maintain image size

Shutter: Electronically-controlled, vertical-traverse, focal-plane type; Range: 1/8000 to 30 sec., bulb; Flash sync: 1/200 sec. or slower

● With shutter speeds 1/200 sec. or faster, camera will automatically switch to HSS mode (only with 5400HS flash unit)

Film transport: Automatic with built-in motor drive; Auto threading; Auto advance to first frame; Single-frame or Continuous advance; Double exposure; Automatic rewind, Manual start of rewind, or High-speed load and rewind; Frame counter in body data panel; Frame counter in viewfinder data panel with countdown of last 9 frames

Viewfinder: Eye-level fixed pentaprism; Field of view: 92% of vertical and 94% of horizontal; Magnification: 0.75 (with 50mm lens at infinity); Diopter: -1; Long eye-relief finder with protective glass; Distance from eye to eyepiece: 22.9mm; Distance from eye to eyepiece cup: 18.9mm; Panorama indicator selectable

Depth-of-Field Preview: Aperture closed down to current f-number while pressing the depth-of-field preview button; AF and AE locked

Self-Timer: Electronic with approx. 10-sec. delay; Cancelable (indication by blinking AF illuminator)

Power: 6-volt 2CR5 lithium battery; Automatic battery check when camera is turned on; Battery condition indicated by four-stage indicator in body data panel

Card System: All cards acceptable (except Customized Function Card and A/S Card)

Dimensions: 153.5 x 98.0 x 71.5mm / 6-7/16 x 3-7/8 x 2-13/16 in.

Weight: 595g/21oz. without lens and battery

Specifications and accessories are based on the latest information available at the time of printing and are subject to change without notice.

CARING FOR YOUR CAMERA

Precautions

- No part of the camera should be forced at any time.
- Polaroid instant 35mm films cannot be used.
- Never subject your camera to shock, high heat, humidity, water, or harmful chemicals. Be particularly careful not to leave it in the glove compartment or other places in motor vehicles where it may be subjected to high temperatures.
- Never lubricate any part of the camera body or lens.
- Never touch the shutter curtains, mirror, or the interior of the body or clean them with compressed air. Doing so may impair their alignment and movement.
- This camera is not waterproof, dustproof or sand-proof. If you use this camera near water or at the beach, water-, dust-, or sand-damage may occur. Protect it at all time from moisture or splashes, especially saltwater spray, and be extremely careful to keep sand from both the interior and exterior of the camera and its accessories.
- If the camera is subjected to a sudden change in temperature, as when transferring it from a cold environment into a heated building, condensation may form inside. To prevent condensation, place the camera in a sealed plastic bag before transferring it from a cold place to a warm environment, and wait for it to come to room temperature before taking it out of the bag.
- The operating range for camera's data panel is from -20 to 50°C (-4 to 122°F). At temperatures outside this range, response time and contrast will change, making the display difficult to read. At very high temperatures, a display may temporarily darken. If this occurs, the display should return when the camera is restored to operating range conditions.
- This camera contains no user-serviceable parts. Do not attempt to disassemble or repair the camera yourself.
- This camera's circuitry may switch off, even when a battery with sufficient power is installed. To resume operation, remove the battery and install it again.
- If HELP appears in the body data panel, remove the battery, then reinstall it. If it appears again after you release the shutter, take the camera to an authorized Minolta service facility.

Cleaning

- External camera surfaces and lens barrel -- but not glass surfaces -- can be cleaned by wiping with a dry or silicone-treated cloth. Never use organic solvents to clean the camera.
- Never touch the lens or eyepiece surfaces with your fingers. Whisk away loose matter with a blower brush. To remove stubborn spots, use a sheet of photographic lens tissue. If necessary, tissue may be moistened with one drop of lens-cleaning fluid; never place fluid directly on glass surfaces.
- We recommend that you have your camera cleaned once a year at an authorized MINOLTA Service Facility.
- If your camera comes in contact with water, wipe it with a clean, dry cloth and bring it to an authorized MINOLTA Service Facility. If it comes in contact with sand or if sand enters the camera, gently blow away loose particles --wiping may scratch the camera-- and bring it to an authorized MINOLTA Service Facility.

Storage

- Always keep your camera in its case with the lens capped when not in use, or with a body cap on when a lens is not attached.
- If you plan to store your camera for an extended period of time, rewind and remove the film, then remove the battery. Place the camera in a cool, dry place away from dust or chemicals, preferable in an airtight container with a drying agent such as silica gel. Also, it is recommended that you periodically release the camera's shutter to maintain proper working condition.
- After prolonged storage, and especially before taking pictures at an important event, carefully check the operation of the camera and lens.

Questions and Service

- If you have question about your camera, contact your local camera dealer. For more information, write to the Minolta distributor or subsidiary in your area (addresses listed on the back of this manual).
- To assure prompt service, please contact an authorized Minolta Service Facility before shipping your camera for repairs.

QUICK REFERENCE GUIDE

When you want to...

Cancel
Eye-Start

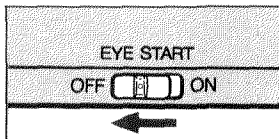

Set the
exposure
mode

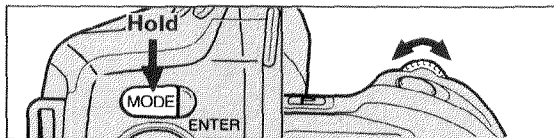

Set the
metering
mode

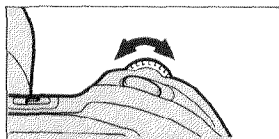
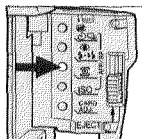

Use
self-timer

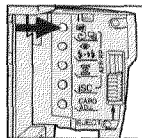

Check the
battery

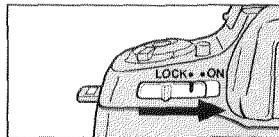

Lock spot
exposure

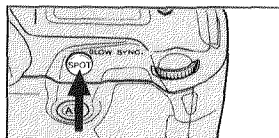

Set exposure compensation

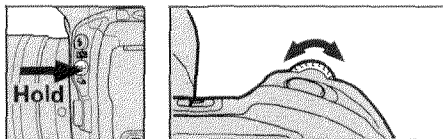

Bracket exposures

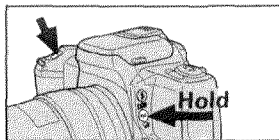

Select a local focus area

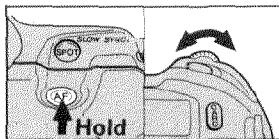

Lock focus



Focus manually

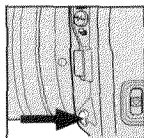

Check film speed

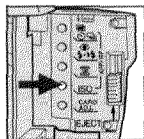

**Manually
rewind film**

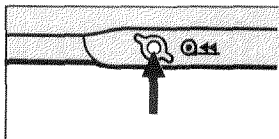

**Set high-
speed load
and rewind**

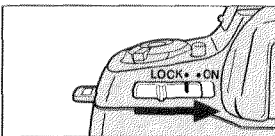
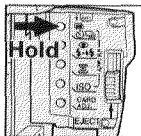

**Use manual
fill-flash
(P mode)**

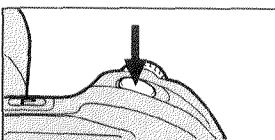
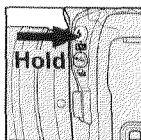

**Use slow-
shutter
sync**

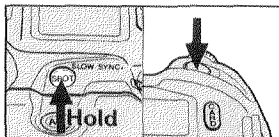

**Set flash
mode**

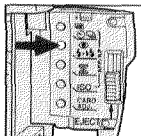

**Set flash
compensation**

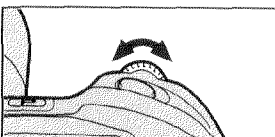
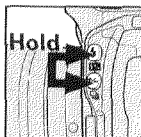

**Test-fire in remote/
wireless
flash mode**

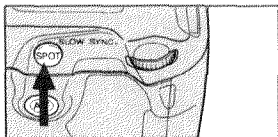

**Set drive
mode**

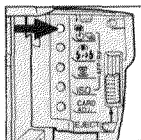

Remove lens

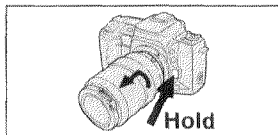

**Set release
priority**

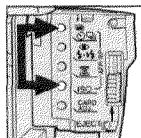

**Set
panorama
frame**

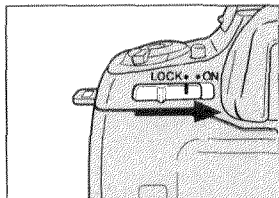
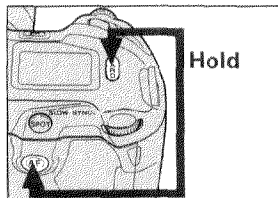



MINOLTA

Minolta Camera Co., Ltd.

3-13, 2-Chome, Azuchi-Machi, Chuo-Ku, Osaka 541, Japan

Minolta GmbH

Kurt-Fischer-Strasse 50, D 22923 Ahrensburg, Germany

Minolta France S.A.

365-367 Route de Saint-Germain, 78420 Carrières-Sur-Seine, France

Minolta (UK) Limited

1-3 Tanners Drive, Blakelands North, Milton Keynes, MK14 5BU, England

Minolta Austria Gesellschaft m.b.H.

Amalienstrasse 59-61, 1131 Wien, Austria

Minolta Camera Benelux B.V.

Zonnebaan 39, 3606 CH Maarssenbroek, P.B. 264, 3600 AG Maarssen, The Netherlands

Belgium Branch

Kontichsesteenweg 38, B 2630 Aartselaar, Belgium

Minolta (Schweiz) AG

Riedhof V, Riedstrasse 6 8953 Dietikon-Zürich, Switzerland

Minolta Svenska AB

Brännkyrkagatan 64, Box 17074, S-10462 Stockholm 17, Sweden

Finland Branch

Niitykatu 6 PL 37 SF-02201 ESPOO, Finland

Minolta Portugal Limitada

Av. do Brasil 33 a, 1700 Lisbon, Portugal

Minolta Corporation

Head Office

101 Williams Drive, Ramsey, New Jersey 07446, U.S.A.

Los Angeles Branch

11150 Hope Street Cypress, CA 90630, U.S.A.

Minolta Canada Inc.

Head Office

369 Britannia Road East, Mississauga, Ontario L4Z 2H5, Canada

Vancouver Branch

106-3850 Jacombs Road, Richmond, B.C. V6V 1Y6, Canada

Minolta Hong Kong Limited

Room 208, 2/F, Eastern Center, 1065 King's Road, Quarry Bay, Hong Kong

Minolta Singapore (Pte) Ltd.

10, Teban Gardens Crescent, Singapore 2260

© 1993 Minolta Camera Co., Ltd. under the Berne
Convention and Universal Copyright Convention