

## FCC STATEMENT

This device complies with Part 15 of the FCC Rules. Operation is subject to the following two conditions:

- (1) This device may not cause harmful interference, and
- (2) This device must accept any interference received, including interference that may cause undesired operation.

### **Note:**

This equipment has been tested and found to comply with the limits for Class B digital devices, pursuant to Part 15 of the FCC rules. These limits are designed to provide reasonable protection against harmful interference in a residential installation. This equipment generates uses and can radiate radio frequency energy and, if not installed and used in accordance with the instructions, may cause harmful interference to radio communications. However, there is no guarantee that interference will not occur in a particular installation. If this equipment does cause harmful interference to radio or television reception, which can be determined by turning the equipment off and on, the user is encouraged to try to correct the interference by one or more of the following measures:

- Reorient or relocate the receiving antenna.
- Increase the separation between the equipment and receiver.
- Connect the equipment into an outlet on a circuit different from that to which the receiver is connected.
- Consult the dealer or an experienced radio/TV technician for help.

Use of shielded cable is required to comply with Class B limits in Subpart B of Part 15 of the FCC rules.

Do not make any changes or modifications to the equipment unless otherwise specified in the manual. If such changes or modifications should be made, you could be required to stop operation of the equipment.

### **Notice**

If static electricity or electromagnetism causes data transfer to discontinue midway (fail), restart the application or disconnect and connect the communication cable (USB, etc.) again.

# READ THIS FIRST

## Trademark Information

- Microsoft® and Windows® are U.S. registered trademarks of Microsoft Corporation.
- Pentium® is a registered trademark of Intel Corporation.
- Macintosh is a trademark of Apple Inc.
- SD™ is a trademark.
- SDHC™ is a trademark.
- Other names and products may be trademarks or registered trademarks of their respective owners.

## Product Information

- Product design and specifications are subject to change without notice. This includes primary product specifications, software, software drivers, and user's manual. This User Manual is a general reference guide for the product.
- The product and accessories that come with your camera may be different from those described in this manual. This is due to the fact that different retailers often specify slightly different product inclusions and accessories to suit their market requirements, customer demographics, and geographical preferences. Products very often vary between retailers especially with accessories such as batteries, chargers, AC adapters, memory cards, cables, pouches, and language support. Occasionally a retailer will specify a unique product color, appearance, and internal memory capacity. Contact your dealer for precise product definition and included accessories.
- The illustrations in this manual are for the purpose of explanation and may differ from the actual design of your camera.
- The manufacturer assumes no liability for any errors or discrepancies in this user manual.

# SAFETY INSTRUCTIONS

Read and understand all **Warnings** and **Cautions** before using this product.

## Warnings

**If foreign objects or water have entered the camera, turn the power off and remove the battery.**

Continued use might cause fire or electric shock. Consult the store of purchase.



**If the camera has fallen or its case has been damaged, turn the power off and remove the battery.**

Continued use might cause fire or electric shock. Consult the store of purchase.



**Do not disassemble, change or repair the camera.**

This might cause fire or electric shock. For repair or internal inspection, ask the store of purchase.



**Use the supplied AC adapter only with the indicated power supply voltage.**

Use with any other power supply voltage might cause fire or electric shock.



**Do not use the camera in areas near water.**

This might cause fire or electric shock. Take special care during rain, snow, on the beach, or near the shore.



**Do not place the camera on inclined or unstable surfaces.**

This might cause the camera to fall or tilt over, causing damage.



**Keep the battery out of the reach of children.**

Swallowing the battery might cause poisoning. If the battery is accidentally swallowed, immediately consult a physician.



**Do not use the camera while you are walking, driving or riding a motorcycle.**

This might cause you to fall over or result in traffic accident.



**Please use battery with complete external seals.**

Do not use battery from which the seals have been damaged or removed. This may cause leakage, explosion, or injury.



## Cautions

**Insert the battery paying careful attention to the polarity (+ or -) of the terminals.**

Inserting the battery with its polarities inverted might cause fire and injury, or damage to the surrounding areas due to the battery rupturing or leaking.



**Do not fire the flash close to anyone's eyes.**

This might cause damage to the person's eyesight.



**Do not subject the LCD monitor to impact.**

This might damage the glass on the screen or cause the internal fluid to leak. If the internal fluid enters your eyes or comes into contact with your body or clothes, rinse with fresh water. If the internal fluid has entered your eyes, consult a physician to receive treatment.



**A camera is a precision instrument. Do not drop it, strike it or use excessive force when handling the camera.**

This might cause damage to the camera.



**Do not use the camera in humid, steamy, smoky, or dusty places.**

This might cause fire or electric shock.



**Do not remove the battery immediately after long period of continuous use.**

The battery becomes hot during use. Touching a hot battery might cause burns.



**Do not wrap the camera or place it in cloth or blankets.**

This might cause heat to build up and deform the case, resulting in fire. Use the camera in a well-ventilated place.



**Do not leave the camera in places where the temperature may rise significantly, such as inside a car.**

This might adversely affect the case or the parts inside, resulting in fire.



**Before you move the camera, disconnect cords and cables.**

Failure to do this might damage cords and cables, resulting in fire and electric shock.



## Notes on Battery Usage

When you use the battery, carefully read and strictly observe the **Safety Instructions** and the notes described below:

- Use only the specified battery (3.7V).
- Avoid extremely cold environments as low temperatures can shorten the battery life and reduce camera performance.
- When you are using a new rechargeable battery or a rechargeable battery that has not been used for an extended period of time (the battery that passed the expiry date is an exception), it may affect the number of images that can be captured. Therefore, to maximize its performance and lifetime, we recommend that you fully charge the battery and discharge it for at least one complete cycle before use.
- The battery may feel warm after a long period of continuous use of the camera or the flash. This is normal and not a malfunction.
- The camera may feel warm after a long period of continuous use. This is normal and not a malfunction.
- If the battery is not to be used for a long period of time, remove it from the camera to prevent leakage or corrosion and store it after no battery power is left. Stored for a long time in a fully charged condition, its performance may be impaired.
- Always keep the battery terminals clean.
- There is a risk of explosion if the battery is replaced by an incorrect type.
- Dispose of used battery according to the recycle instructions.
- Charge the rechargeable battery fully before using for the first time.
- To prevent short-circuiting or fire, keep the battery away from other metal objects when carrying or storing.

# CONTENTS

## **7 INTRODUCTION**

- 7 Overview
- 7 Package Contents

## **8 GETTING TO KNOW YOUR CAMERA**

- 8 Front View
- 9 Rear View
- 10 LCD Monitor Display

## **12 GETTING STARTED**

- 12 Preparation
- 13 Charging the Battery
- 14 Initial Settings

## **16 CAPTURE MODE**

- 16 Capturing Images
- 17 Capturing Images When the Smile Feature is On
- 18 Recording Shots using Face Detection Technology
- 19 Recording a Subject onto an Existing Background Image
- 19 Combining Shots of Two People into a Single Image
- 20 Setting the Panorama Mode
- 20 Recording Voice Memos

## **21 VIDEO MODE**

- 21 Recording Video Clips
- 21 Playing Back Video Clips

## **22 PLAYBACK MODE**

- 22 Playing Back Still Images
- 23 Thumbnail Display
- 23 Removing Red-eye
- 24 Attaching Voice Memos
- 25 Protecting Images
- 26 DPOF Settings
- 27 Erasing Images

## **28 MENU OPTIONS**

- 28 Capture Menu
- 31 Video Menu
- 32 Playback Menu
- 33 Setup Menu

## **34 TRANSFERRING FILES TO YOUR COMPUTER**

- 34 Downloading Your Files

## **35 USING THE CAMERA AS A PC CAMERA**

## **35 EDITING SOFTWARE INSTALLATION**

## **36 SPECIFICATIONS**

## **37 APPENDIX**

- 38 Troubleshooting
- 39 Connecting to a PictBridge Compliant Printer

# INTRODUCTION

## Overview

Congratulations on your purchase of the new digital camera.

Capturing high-quality digital images is fast and easy with this state-of-the-art smart camera. Equipped with a 10.0-megapixel CCD, this camera is capable of capturing images with a resolution of up to 3648 x 2736 pixels.

## Package Contents

Carefully unpack your camera and ensure that you have the following items:

### Common Product Components:

- Digital Camera
- User's manual
- Software CD-ROM
- USB cable
- AV cable
- Camera strap
- Camera pouch
- AC power adapter
- Rechargeable lithium-ion battery

### Common (Optional) Accessories:

- SD/SDHC memory card



- 
- Accessories and components may vary by retailer.

# GETTING TO KNOW YOUR CAMERA

## Front View

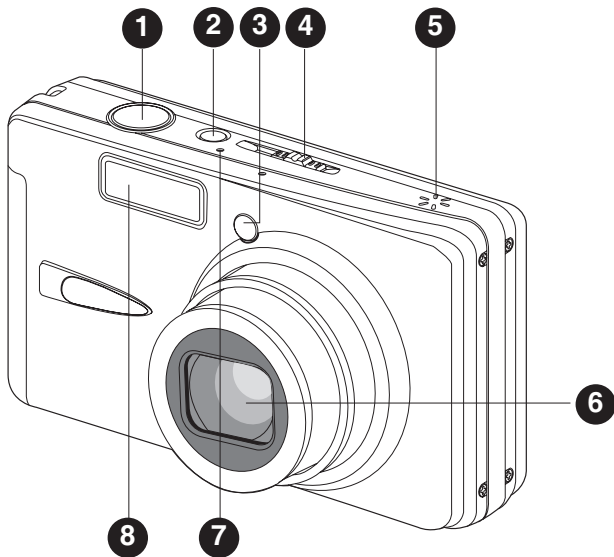

- 1. Shutter button



---

- 2. **ON/OFF** button

---

- 3. Self-timer LED

---

- 4. Mode switch
  -  Capture mode
  -  Video mode
  -  Playback mode

---

- 5. Speaker

---

- 6. Lens

---

- 7. Microphone

---

- 8. Flash

---

## Rear View

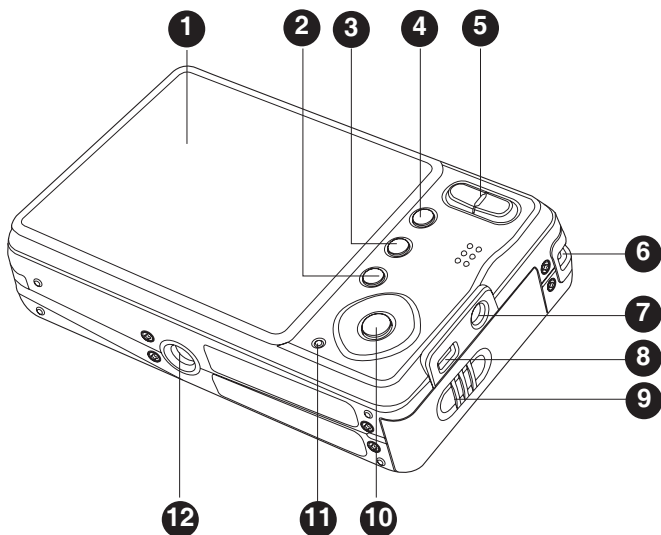



1. LCD monitor

2.  Delete button

3. **DISP** Display button

4. **MENU** Menu button

5.  Zoom in button

 Zoom out button

6. Strap holder

7. DC IN 5V terminal

8. USB or AV OUT terminal

9. Battery / Memory card cover

10. **SET** / Direction button

 button

 Focus button

 button

 Flash button

 button

 Self-timer button

 button

 Backlight/Exposure compensation button





























**SET** Set button

11. Status LED

12. Tripod socket

# LCD Monitor Display

## Capture mode

1. Zoom status
2. Voice memo
3. Battery condition
  - [  ] Full battery power
  - [  ] Medium battery power
  - [  ] Low battery power
  - [  ] No battery power
  - [  ] AC adapter icon (if used)
4. Flash mode
  - [ Blank ] Auto Flash
  - [  ] Red-eye Reduction
  - [  ] Forced Flash
  - [  ] Pre-flash
  - [  ] Slow sync flash
  - [  ] Flash Off
5. [  ] Histogram
6. Main focus area (When the shutter button is pressed halfway)
7. Capture mode icon
  - [  ] Single
  - [  ] Continuous
  - [  ] Auto Exposure Bracketing
  - [  ] Cont. flash
  - [  ] Burst
  - [  ] Pre-Shot
  - [  ] Coupl. shot
  - [  ] Album Shot
8. Image size resolution
  - [ 10M ] 3648 x 2736
  - [ 5M ] 2816 x 2112
  - [ 4M ] 2272 x 1704
  - [ 2M ] 1600 x 1200
  - [ VSA ] 640 x 480
9. Available number of shots
10. Image quality
  - [  ] Fine
  - [  ] Standard
  - [  ] Economy
11. Date and time
12. Self-timer icon
  - [  ] 10 sec.
  - [  ] 2 sec.
  - [  ] 10+2 sec.
13. Slow shutter warning
14. [  ] Exposure compensation  
 [  ] Backlight correction  
 (Adjust exposure value with the ▲ / ▼ buttons)
15. Metering
  - [  ] Average
  - [  ] Spot

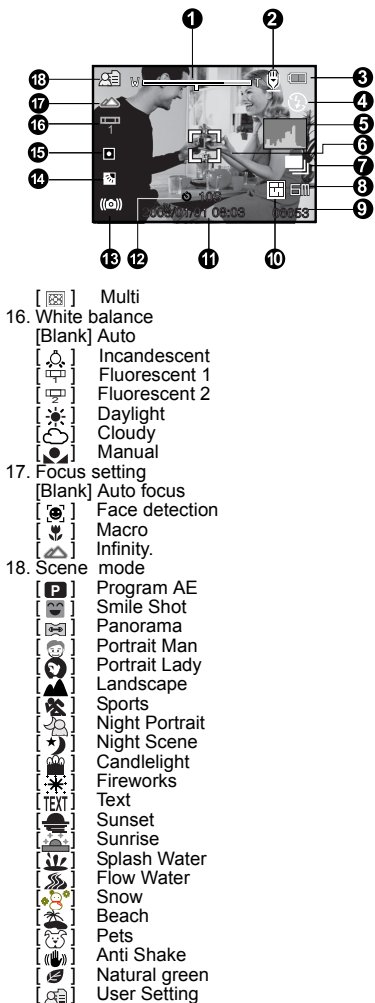

### Video mode [ ]

1. Mode icon
2. Zoom status
3. Battery condition
4. Video resolution
5. Available recording time/Elapsed time
6. Video quality
7. Recording indicator
8. Self-timer icon
9. Focus setting

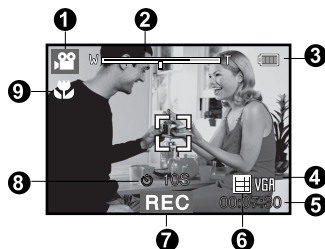

### Playback mode [ ] - Still image playback

1. Mode icon
2. File number
3. Folder number
4. Protect icon
5. Voice memo
6. DPOF icon

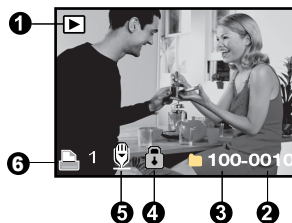

### Playback mode [ ] - Video playback

1. Video status bar
2. Elapsed time
3. File number
4. Folder number
5. Protect icon
6. Mode icon
7. Play mode
8. Sound off icon (When the  button is pressed during video playback)
9. Total recorded time

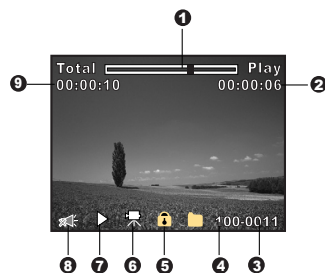

# GETTING STARTED

## Preparation

1. Attach the camera strap.

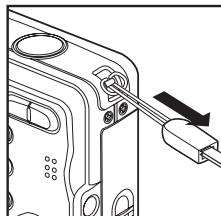

2. Open the battery/memory card cover.
3. Insert the supplied battery with correct orientation as shown.

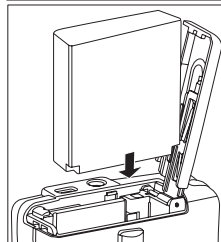

4. Insert an SD/SDHC memory card (Optional).
  - The camera has 32MB internal memory (28MB available for image storage), but you can load an SD/SDHC memory card to expand the camera's memory capacity.
  - Be sure to format the memory card with this camera before its initial usage.
5. Close the battery/memory card cover and make sure it is locked securely.

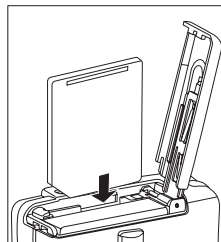

- To prevent valuable data from being accidentally erased from an SD/SDHC memory card, you can slide the write protect tab (on the side of the SD/SDHC memory card) to "LOCK".
- To save, edit, or erase data on an SD/SDHC memory card, you must unlock the card.
- To prevent damaging of an SD/SDHC memory card, be sure to turn off the power when inserting or removing the SD/SDHC memory card. If inserting or removing the SD/SDHC memory card with the power on, the camera will automatically turn off.

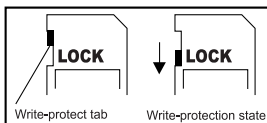

## Charging the Battery

The AC power adapter may charge the battery or operate as the camera's power supply. Make sure that the camera is turned off and the battery is inserted before starting.

1. Insert one end of the AC power adapter into the DC IN 5V terminal of the camera.
2. Insert the other end of the AC power adapter into a wall outlet.

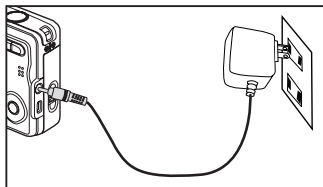

- The status LED lights red when charging has started and the LED turns off when charging is completed. The LED lights green when a charging error has occurred or no battery is inserted inside the camera.
- It is recommended that you fully discharge the battery before recharging.
- Charging time varies according to the ambient temperature and the status of battery.



- 
- This camera must use with the specified battery and AC power adapter for battery charging. Damage caused by using of an incorrect adapter is not covered under the warranty.
  - The battery may feel warm after it has been charged or immediately after being used. This is normal and not a malfunction.
  - When using the camera in cold areas, keep the camera and battery warm by holding them inside your outer clothes.

# Initial Settings

## Setting the Date and Time

The date/time needs to be set if and when:

- The camera is turned on for the first time.
- The camera is turned on after leaving the camera without the battery for an extended period of time.

When the date and time information is not displayed on the LCD monitor, follow these steps to set the correct date and time.

1. Slide the mode switch to [📷] or [📹], and press the **MENU** button.
2. Select [Setup] with the ► button.
3. Select [Date/Time] with the ▲ / ▼ buttons, and press the **SET** button.
4. Select the date format with the ▲ / ▼ buttons, and press the **SET** button.
  - Select the item's field with the ◀ / ▶ buttons and adjust the value for the date and time with the ▲ / ▼ buttons.
  - The time is displayed in 24-hour format.
  - After confirming all settings are correct, press the **SET** button.
5. To exit from the [Setup] menu, press the **MENU** button.

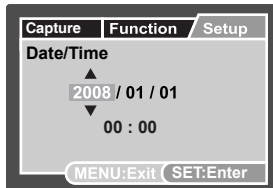
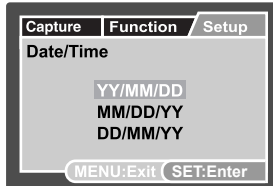
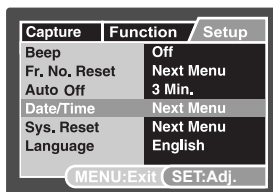

## Choosing the Language

Specify in which language menus and messages are to be displayed on the LCD monitor.

1. Slide the mode switch to [📷], [📺] or [▶], and press the **MENU** button.
2. Select [Setup] menu with the ▶ button.
3. Select [Language] with the ▲ / ▼ buttons and press the **SET** button.
4. Select the displayed language with the ▲ / ▼ buttons and press the **SET** button.
  - The setting will be stored.

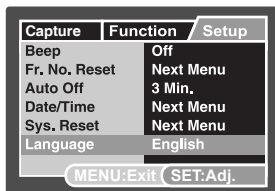

## Formatting the Memory Card or Internal Memory

This utility formats the internal memory (or memory card) and erases all stored images and data.

1. Slide the mode switch to [▶], and press the **MENU** button.
2. Select [Setup] menu with ▶ button.
3. Select [Format] with the ▲ / ▼ buttons, then press the **SET** button.
4. Select [Execute] with the ▲ / ▼ buttons, and press the **SET** button.
  - To cancel formatting, select [Cancel] and press the **SET** button.

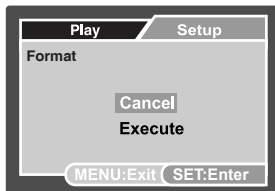
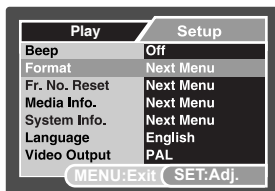

# CAPTURE MODE

## Capturing Images

Your camera is equipped with a 2.7" full color TFT LCD monitor to help you compose images, playback recorded images/video clips or adjust menu settings.

1. Press the **ON/OFF** button to turn the power on.
  - The status LED lights green and the camera is initiated.
  - When the power is turned on, the camera will start in the mode that was last set.
  - If the power is turned on in [📷] or [📹] mode, the lens will extend forward and it is ready for shooting. In both modes, if the mode switch is set to [▶], the lens barrel will retract into the camera body after 30 seconds.
  - If the power is turned on in [▶] mode, the lens will remain closed.
2. Slide the mode switch to [📷].
3. Compose your image in the LCD monitor.
  - Pressing the ⬆ button zooms in on the subject, and enlarges the subject on the LCD monitor.
  - Pressing the ⬇ button provides a wider angle image.
4. Press the shutter button.
  - Pressing the shutter button down halfway automatically focuses and adjusts the exposure, and pressing the shutter button down fully captures the images.
  - The focus area frame turns green when the camera is in focus and the exposure is calculated.
  - When the focus or exposure is not suitable, the frame of the focus area turns red.
  - If the photographic preview is set to [On], the captured image will be displayed while the image is being recorded onto the SD/SDHC memory card.

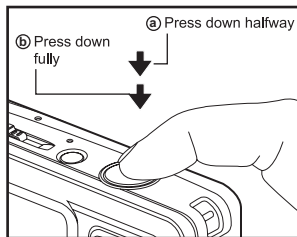

## Capturing Images When the Smile Feature is On

With the camera's new "smile detection" function, this camera detects smiles so you do not miss those special moments in life.

1. Slide the mode switch to [📷].
2. Press the **MENU** button.
3. Select [Scene mode] with the ▲ / ▼ buttons, and press the **SET** button.
4. Select [Smile Shot] with the ▲ / ▼ buttons, and press the **SET** button.
5. Press the **MENU** button to exit the menu mode, and the camera returns to preview display.



6. Compose the image, and press the shutter button down fully.



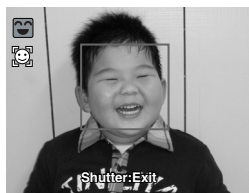

7. Once the camera detects a smile, it will automatically capture 3 images (by default, the flash mode setting is set to ☀).
  - If the flash mode setting is changed to 4, the camera will only capture an image after it detects a smile.
  - When capturing group shots (if the number of people is more than 1), the camera will automatically capture the image(s) when it detects two smiles. The number of shots taken depends on the flash mode setting.
  - If the camera does not detect a smile within 5 seconds, the camera will automatically capture an image.
  - Press the shutter button once again to reactivate this function.

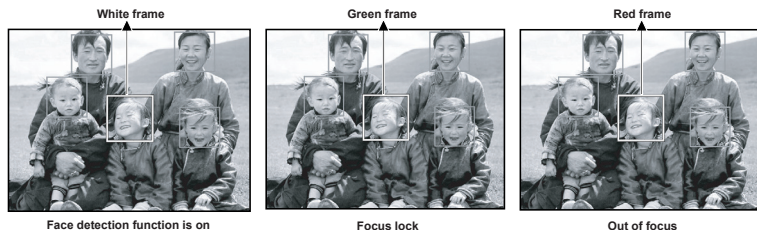

## Recording Shots using Face Detection Technology

Face Detection Technology can identify and focus on the human faces in the image. This advanced function simultaneously detects up to 5 human faces regardless of their position in the scene.



1. Slide the mode switch to [📷].
2. Toggle the  button until [👤] icon appears on the LCD monitor.
  - The white frame is identified as the “top priority” face (main focus frame), and gray ones around the other faces.
3. Press the shutter button halfway down to lock the focus.
  - The main focus frame simultaneously turns green.
  - If the “top priority” face is out of focus, the main focus frame turns red.
4. Press the shutter button down fully to capture your image.



- Subjects that are not suitable with this function:
  - a. A person is wearing glasses, sunglasses, or face is covered with hat or hair.
  - b. A person turned sideways.

## Recording a Subject onto an Existing Background Image

Pre-Shot helps you get the background you want, even if you need to ask someone else to record the image for you. Basically, Pre-Shot is a two-step process.

1. Slide the mode switch to [📷].
  - a. Press the **MENU** button.
  - b. Select [Function] with the ► button.
  - c. Select [Capture Mode] with the ▲ / ▼ button, and press the **SET** button.
  - d. Select [Pre-Shot] with the ▲ / ▼ button, and press the **SET** button.
  - e. Press the **MENU** button to exit from the menu screen.
2. Compose the background you want on the screen, and then press the shutter button to temporarily record it as a reference image.
  - This operation causes a semi-transparent image of the background to appear on the screen, but the displayed image is not actually saved in camera memory.
3. Now you can stand in front of the background and ask someone else to take your picture, using the semi-transparent background on the screen as a composition guide.
4. After composing the final image (using the semi-transparent background as a guide), the person with the camera should press the shutter button to record.
  - Note that the semi-transparent background image temporarily recorded in step 2 is for composition purposes only. The final image contains only what is in front of the camera when the shutter button is pressed in step 4.

## Combining Shots of Two People into a Single Image

This mode lets you record images of two people and combine them into a single image. This makes it possible for you to include yourself in group images, even when there is no one else around to record the image for you.

1. Slide the mode switch to [📷].
  - a. Press the **MENU** button.
  - b. Select [Function] with the ► button.
  - c. Select [Capture Mode] with the ▲ / ▼ button, and press the **SET** button.
  - d. Select [Coupl.shot] with the ▲ / ▼ button, and press the **SET** button.
  - e. Press the **MENU** button to exit from the menu screen.
2. Align the focus frame on the screen with the subject you want on the left side of the image.
3. Press the shutter button to record the left side of the image.
4. Next compose the subject you want in the right side of the image, taking care to align the background with the semi-transparent image of the background of the first image, which is shown on the screen.
5. When everything is aligned correctly, record the right side of the image.

## Setting the Panorama Mode

This mode is designed to make it easier to take a series of shots then stitch them together with software to make a single image. You can capture a photographic subject that won't fit into a single frame, such as a landscape, and stitch it together later with a program such as Cool 360 or Photoshop application.

1. Slide the mode switch to [ ].
2. Press the **MENU** button.
3. Select [Scene Mode] with the ▲ / ▼ buttons, and press the **SET** button.
4. Select [Panorama] with the ▲ / ▼ buttons, and press the **SET** button.
5. Press the **MENU** button.
6. Select the photographic direction with the ◀ / ▶ buttons.
7. Shoot the first image.
  - The next image appears beside the previous image.
8. Orient the camera so that the second frame overlaps a small portion of the photographic subject of the first image and press the shutter button to capture the next image.
9. Follow the same steps to capture subsequent images in the sequence.
10. Finish the sequence by pressing the **MENU** button or switch to another mode after the last image has been recorded.

## Recording Voice Memos

A voice memo can be recorded once for 30 seconds in the still image mode immediately following a still image capture.

1. Slide the mode switch to [ ].
2. Press the **MENU** button, and select the [Function] menu with the ▶ button.
3. Select [Voice Memo] with the ▲ / ▼ buttons, and press the **SET** button.
4. Select [On] with the ▲ / ▼ buttons, and press the **SET** button.
5. Press the **MENU** button to exit from the menu.
  - An icon is displayed on the screen.
6. Compose the image, press the shutter button down halfway, then press it down fully.
  - [VOICE RECORDING] is displayed on the screen immediately, and the voice memo recording starts.
7. Press the shutter button one more time during recording, or wait for 30 seconds
  - [VOICE RECORD END] will be displayed and the recording will end.
  - An icon is displayed with images that have been recorded with a voice memo.

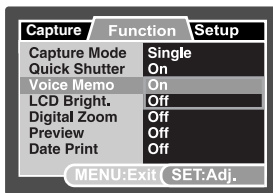

# VIDEO MODE

## Recording Video Clips

This mode allows you to record video clips at a resolution of 320 x 240 / 640 x 480 pixels.

1. Slide the mode switch to [📹].
2. Compose the image.
3. Press the shutter button.
  - The recording of the video clip will start.
  - Pressing the shutter button one more time will end the recording of the video clip.
  - The recording time depends on the storage size and the subject of the image to be recorded.
  - The zoom function cannot be used during video recording.

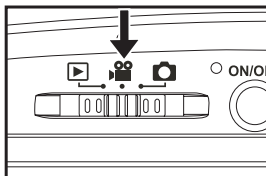

- 
- When recording a video clip, the flash and "10+2 sec." self-timer function cannot be used.
  - If the write speed of your SD/SDHC memory card is not fast enough for recording video clips in the currently selected quality, a warning icon (🚫) will appear, and the video recording will stop. In this case, select a video quality lower than the current one.

## Playing Back Video Clips

You can play back recorded video clips on the camera. You can also play back sound if recorded with the video.

1. Slide the mode switch to [▶].
  - The last image appears on the screen.
2. Select the desired video clip with the ◀ / ▶ buttons.
3. Press the **SET** button.
  - A press of the ▶ / ◀ buttons during playback allows fast forward play / fast reverse play.
  - To stop video playback, press the ▼ button. This stops playback and returns to the start of the video clip.
  - To pause video playback, press the **SET** button. This pauses video playback. To cancel pause, press the **SET** button again.
  - By pressing the shutter button with a movie in pause mode, you can capture a still image from the video.



- 
- Video clips cannot be displayed rotated or enlarged.
  - Windows Media player or QuickTime Player is recommended to play back the video clip on your computer.
  - QuickTime Player is a free media player available at [www.apple.com](http://www.apple.com); and compatible with Mac and Windows computers.
  - For more information about the operation of the media player, refer to its respective help documentation.

# PLAYBACK MODE

## Playing Back Still Images

You can play back the still images on the LCD monitor.

1. Slide the mode switch to [▶].
  - The last image appears on the screen.
2. The images can be displayed in forward or reverse sequence with the ◀ / ▶ buttons.
  - To view the previous image, press the ◀ button.
  - To view the next image, press the ▶ button.
  - Pressing the ▲ / ▼ buttons during image playback will result in a 90-degree rotated display.
  - The ▲ button rotates the image counterclockwise and displays it, whereas the ▼ button rotates the image clockwise and displays it. A press of the button opposite to the direction in which the image was rotated will return the image to the normal display.
  - Pressing the ⬆ button enlarges the image.
  - To return to normal magnification, press the ⬆⬆ button.

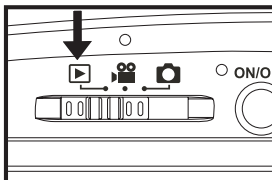

Entire image      Current position of enlargement



- 
- An [▶] icon is displayed with the video data. Video clips cannot be rotated.
  - An [🔊] icon is displayed with images which have an audio memo recorded.
  - Press the **SET** button to playback the voice memo data.

## Thumbnail Display

This function allows you to view thumbnail images on the LCD monitor so you may search for a particular image/video clip/audio file.

- Slide the mode switch to [▶].
  - The last image appears on the screen.
- Press the \*\*\* button.
  - The images are displayed in the thumbnail display.
  - Press the ⬆ button to exit from thumbnail display.
  - Use the ◀ / ▶ buttons to go to previous or next page.
  - Use the ▲ / ▼ buttons to select the file to be displayed.
- Press the **SET** button.
  - The selected image is displayed at its regular size.

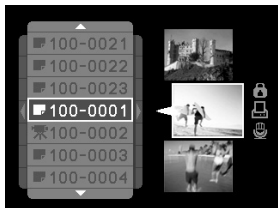

## Removing Red-eye

You can use this function to remove the red-eye effect after an image is taken.

- Slide the mode switch to [▶].
- Select the image that you want to edit with the ◀ / ▶ buttons.
- Press the **MENU** button.
- Select [Fix Red Eyes] with the ▲ / ▼ buttons, and press the **SET** button.
- Select [Execute] with the ▲ / ▼ buttons, and press the **SET** button.
- View the changes on the corrected image.
- To save your corrected image, select [Confirm] with the ▲ / ▼ buttons, and press the **SET** button.
  - When this process ends, this replaces the original image with the corrected image.

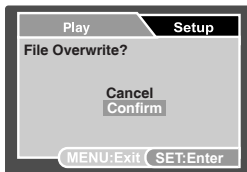

## Attaching Voice Memos

A maximum of 30 seconds of audio can be recorded as a memo for captured still images. The voice memo can be recorded only once.

1. Slide the mode switch to [📷].
  - The last image appears on the screen.
2. Select the image to which you want to attach the voice memo with the ◀ / ▶ buttons.
3. Press the shutter button.
  - [VOICE RECORDING] is displayed on the screen and recording starts.
4. To stop recording a voice memo as it is being recorded, press the shutter button again.
  - [VOICE RECORD END] will be displayed and the recording will end. An [🗑️] icon is displayed with images that have been recorded with a voice memo.

## Playing back voice memo

A press of the **SET** button displays [VOICE PLAYBACK] and plays back the voice memo.



- 
- Voice memo is only available for still images.

## Protecting Images

Set the data to read-only to prevent images from being erased by mistake.

1. Slide the mode switch to [▶].
2. Select the image that you want to protect with the ◀ / ▶ buttons.
3. Press the **MENU** button.
4. Select [Protect] with the ▲ / ▼ buttons, and press the **SET** button.
5. Select [Single] or [All] with the ▲ / ▼ buttons, and press the **SET** button.
  - The protect icon [🔒] is displayed with protected images.  
When [All] has been selected, [🔒] is displayed with all the images.
6. Select [Set] with the ▲ / ▼ buttons, and press the **SET** button.

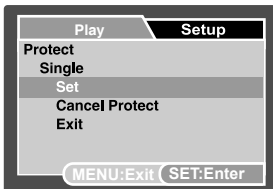
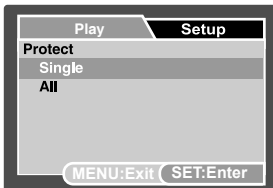

## Canceling the Protection

To cancel protection for only one image, display the image on which you want to remove the image protection.

1. Select [Protect] with the ▲ / ▼ buttons from the playback menu, and press the **SET** button.
2. Select [Single] or [All] with the ▲ / ▼ buttons, and press the **SET** button.
3. Select [Cancel Protect] with the ▲ / ▼ buttons, and press the **SET** button.



- Formatting an SD/SDHC memory card overrides protection, and erases all images regardless of their protected status.

## DPOF Settings

DPOF is the abbreviation for Digital Print Order Format, which allows you to embed printing information on your memory card. You can select the images to be printed and how many prints to make with the DPOF menu in the camera and insert the memory card to the card compatible printer. When the printer starts printing, it will read the embedded information on the memory card and print the specified images.

- Slide the mode switch to [P].
- Select the image that you want to set DPOF with the ◀ / ▶ buttons.
- Press the **MENU** button.
- Select [DPOF] with the ▲ / ▼ buttons, and press the **SET** button.
  - The DPOF setting screen is displayed.
- Select [Single] or [All] with the ▲ / ▼ buttons, and press the **SET** button.
  - [Single]: Sets DPOF for each individual image.
  - [All]: Sets DPOF for all images at once.
- Select [Print Num] with the ▲ / ▼ buttons, and press the **SET** button.
  - This displays the number of prints setting screen.
- Set the number of prints with the ▲ / ▼ buttons, and press the **SET** button.
  - You can set up to 9 prints for each image.
- Select [Date Print] with the ▲ / ▼ buttons, and press the **SET** button.
  - The date setting screen appears.
- Select date to [On] or [Off] with the ▲ / ▼ buttons, and press the **SET** button.
  - [On]: The date of the image will also be printed.
  - [Off]: The date of the image will not be printed.
- Select [Print Enable] with the ▲ / ▼ buttons, and press the **SET** button.
- Select [Execute] with the ▲ / ▼ buttons, and press the **SET** button.
  - This creates a file containing the DPOF information, and when the operation is finished, the screen returns to the playback mode.
  - The DPOF icon (📄) is displayed on each image that has set up DPOF settings.

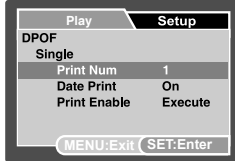
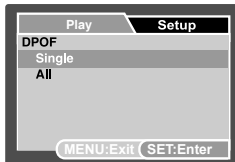

- The date that is printed on the image is the date set on the camera. To print the correct date on the image, set the date on the camera before you capture the image. Refer to section in this manual titled "Setting the Date and Time" for further details.

## Erasing Images

### Erasing in Photography Mode (Quick Delete Function)

The quick delete function enables you to delete the last-captured image during capture.

1. Slide the mode switch to [P] or [S].
2. Press the  button.
  - The last image and quick delete menu appear on the screen.
3. Select [Execute] with the ▲ / ▼ buttons.
4. Press the **SET** button to confirm the deletion.
  - To not delete, select [Cancel], and press the **SET** button.

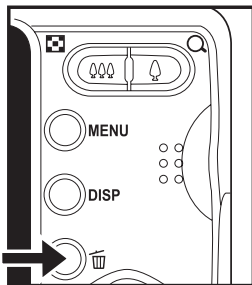

### Erasing single image / Erasing all images

1. Slide the mode switch to [P].
  - The last image will be displayed on the screen.
2. Select the image you want to erase with the ◀ / ▶ buttons.
3. Press the  button.
  - The deletion menu will be displayed.
4. Select [Single] or [All] with the ▲ / ▼ buttons, and press the **SET** button.
  - [Single]: Erases the selected image or the last image.
  - [All]: Erases all of the images except for the protected images.
5. Select [Execute] with the ▲ / ▼ buttons, and press the **SET** button.
  - To not erase, select [Cancel], and press the **SET** button.

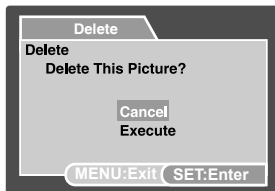
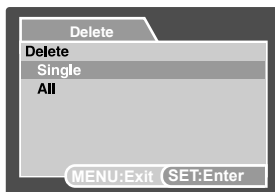

- Deleting an image will not affect sequential image numbering. For example, if you delete image number 240, the next captured image will be numbered 241 even though 240 no longer exists. In other words, an image-number is retired when an image is deleted and will not be reused or reassigned to another subsequently captured image.

# MENU OPTIONS

## Capture Menu

This menu is for the basic settings to be used when capturing still images.

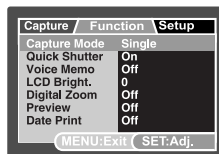
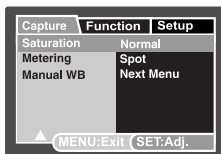
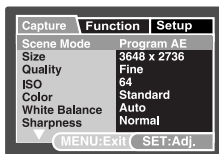

1. Slide the mode switch to [ ].
2. Press the **MENU** button, and select the [Capture] / [Function] / [Setup] menu with the ◀ / ▶ buttons.
3. Select the desired option item with the ▲ / ▼ buttons, and press the **SET** button to enter its respective menu.
4. Select the desired setting with the ▲ / ▼ buttons, and press the **SET** button.
5. To exit from the menu, press the **MENU** button.

### Scene Mode

Select from 22 different scene modes in accordance with the shooting conditions.

\* Program AE / Smile Shot / Panorama / Portrait Man / Portrait Lady / Landscape / Sports / Night Portrait / Night Scene / Candlelight / Fireworks / Text / Sunset / Sunrise / Splash Water / Flow Water / Snow / Beach / Pets / Anti Shake / Natural green / User Setting

### Size

This sets the size of the image that will be captured.

- \* [ ] 3648 x 2736
- \* [ ] 2816 x 2112
- \* [ ] 2272 x 1704
- \* [ ] 1600 x 1200
- \* [ ] 640 x 480

### Quality

This sets the quality (compression) at which the image is captured.

- \* [ ] Fine
- \* [ ] Standard
- \* [ ] Economy

### ISO

This sets the sensitivity for capturing images. When the sensitivity is raised (and the ISO figure is increased), photography will become possible even in dark locations, but the more pixelated (grainier) the image will appear.

\* Auto / 64 / 100 / 200 / 400 / 800 / 1600







### Color

This sets the color of the image that will be photographed.

\* Standard / Vivid / Sepia / Monochrome / Red / Green / Blue / Yellow / Purple

## White Balance

This sets the white balance for a variety of lighting conditions and permits images to be captured that approach the conditions that are seen by the human eye.

- \* [ Blank ] Auto
- \* [  ] Incandescent
- \* [  ] Fluorescent 1
- \* [  ] Fluorescent 2
- \* [  ] Daylight
- \* [  ] Cloudy
- \* [  ] Manual

## Sharpness

This sets the sharpness of the image that will be captured.

- \* Hard / Normal / Soft



## Saturation

This sets the saturation of the image that will be captured.

- \* High / Normal / Low

## Metering

This sets the metering method for calculating the exposure.

- \* [  ] Average: Averages the light metered from the entire frame, but gives greater weight to the subject matter at the center.
- \* [  ] Spot: A very small portion of the center of the screen is measured to calculate the correct exposure.
- \* [  ] Multi: The entire area of the screen is measured, and the exposure is calculated.

## Manual WB









This manually sets the white balance and stores it. Use of this is convenient when the white balance does not offer a good match.

Before selecting [Execute] and before taking your image, place a white paper in the scene and set the white balance manually.

- \* Cancel / Execute

## Capture Mode

This sets the recording method at the time of capturing images.

- \* [  ] Single: Captures one image at a time.
- \* [  ] Continuous: Permits continuous capture of up to 3 images.
- \* [  ] AEB: Permits 3 consecutive images in the order of standard exposure, underexposure and overexposure compensation.
- \* [  ] Burst: Permits continuous photography while keeping the shutter button pressed down. As long as you hold the shutter button pressed, pictures are captured until the memory capacity is exhausted.
- \* [  ] Cont.flash: The "Series + flash" capture mode lets you shoot a sequence of 3 pictures with flash.
- \* [  ] Pre-Shot: Pre-shot helps you get the background you want, even if you need to ask someone else to record the image for you. Basically, Pre-shot is a two-step process.
- \* [  ] Coup.l.shot: This mode lets you record images of two people and combine them into a single image. This makes it possible for you to include yourself in group images, even when there is no one else around to record the image for you.
- \* [  ] Album Shot: Creates an album-like layout to combine 3 shots into a single image.



- 
- In [Continuous], [AEB], [Burst], [Cont.flash], [Pre-Shot], [Coupl.shot] and [Album Shot] capture mode, the voice memo is automatically fixed at [Off].

### **Quick Shutter**

In case of pressing S2 (the shutter button down fully) fast at "Quick shutter on" mode, camera takes image without focus. However, if you set "Quick shutter off", the auto focus function works even if you press S2 fast.

\* On / Off

### **Voice Memo**

Refer to section in this manual titled "Recording Voice Memos" for further details.

\* On / Off



- 
- When [Voice Memo] is set to [On], the [Preview] is also fixed at [On].

### **LCD Bright.**

Select a brightness level for the LCD monitor.

The LCD becomes brighter with the ▲ button and darker with the ▼ button. The adjustment range is from -5 to +5.

### **Digital Zoom**

This sets whether or not to use digital zoom at the time of photography.

\* On / Off

### **Preview**

This sets whether or not to display the captured image on the screen immediately after the image is captured.

\* On / Off

### **Date Print**

The date of recording can be printed directly on the still images. This function must be activated before the image is captured.

\* On / Off

## Video Menu

This menu is for the basic settings to be used when recording video clips.

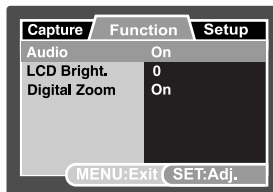
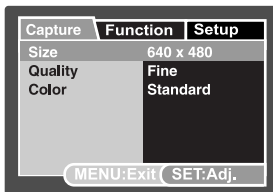

1. Slide the mode switch to [ , ].
2. Press the **MENU** button, and select the [Capture] / [Function] / [Setup] menu with the ◀ / ▶ buttons.
3. Select the desired option item with the ▲ / ▼ buttons, and press the **SET** button to enter its respective menu.
4. Select the desired setting with the ▲ / ▼ buttons, and press the **SET** button.
5. To exit from the menu, press the **MENU** button.

### Size

This sets the size of the video clip that will be captured.

\* [  ] 640 x 480

\* [  ] 320 x 240

### Quality

This sets the quality (compression) at which the video clip is captured.

\* [  ] Fine

\* [  ] Standard

### Color

This sets the color of the video clip that will be captured.

\* Standard / Vivid / Sepia / Monochrome / Red / Green / Blue / Yellow / Purple

### Audio

This sets whether or not to record audio at the time of video recording.

\* On / Off

### LCD Bright.

Refer to section in this manual titled "LCD Bright." in Capture Menu for further details.

### Digital Zoom

Refer to section in this manual titled "Digital Zoom" in Capture Menu for further details.

## Playback Menu

In the [▶] mode, choose which settings are to be used for playback.

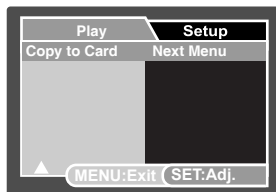
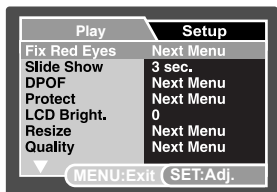

1. Slide the mode switch to [▶].
2. Press the **MENU** button.
3. Select the desired option item with the ▲ / ▼ buttons, and press the **SET** button to enter its respective menu.
4. Select the desired setting with the ▲ / ▼ buttons, and press the **SET** button.
5. To exit from the menu, press the **MENU** button.

### Fix Red Eyes

Refer to section in this manual titled "Removing Red-eye" for further details.

### Slide Show

This function enables you to playback your still images automatically in order one image at a time.

\* 3 sec. / 5 sec. / 10 sec.

### DPOF

Refer to section in this manual titled "DPOF Settings" for further details.

### Protect

Refer to section in this manual titled "Protecting Images" for further details.

### LCD Bright.

Refer to section in this manual titled "LCD Bright." in Capture Menu for further details.

### Resize

Resizes a previously saved image. Resizing replaces the original image with the changed image. It is only possible to resize to a smaller size.

### Quality

Changes the quality (compression) of a recorded image. Compresses images down to half of their size or less, overwrites old size images with newly compressed images. It is only possible to reduce the image quality/size, never to increase it.

### Copy to Card

Allows you to copy your files from the camera's internal memory to an SD/SDHC memory card. Of course, you can only do this if you have a memory card installed and some files in internal memory.

\* Cancel / Execute

# Setup Menu

Set your camera's operating environment.

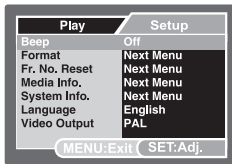
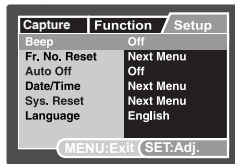

1. Slide the mode switch to [📷], [📹] or [▶].
2. Press the **MENU** button, and select the [Setup] menu with the ▶ button.
3. Select the desired option item with the ▲ / ▼ buttons, and press the **SET** button to enter its respective menu.
4. Select the desired setting with the ▲ / ▼ buttons, and press the **SET** button.
5. To exit from the menu, press the **MENU** button.

## Beep

This sets whether or not to mute the camera sound each time you press the camera's buttons.

\* On / Off

## Fr. No. Reset

This creates a new folder. The captured images are recorded to the newly created folder from number 0001.

\* Cancel / Execute

## Auto Off

If no operation is performed for a specific period of time, the power to the camera is automatically turned off. This feature is useful for reducing battery usage.

\* 1 Min. / 3 Min. / 5 Min. / 10 Min. / Off

## Date/Time

Refer to section in this manual titled "Setting the Date and Time" for further details.

## Sys. Reset

This returns all basic settings to the camera's default settings. The time setting will not be reset.

\* Cancel / Execute

## Language

Refer to section in this manual titled "Choosing the Language" for further details.

## Format

Refer to section in this manual titled "Formatting the Memory Card or Internal Memory" for further details.

## Media Info.

This displays the free capacity of the internal memory or the memory card.

## System Info.

This displays the firmware version of the camera.

## Video Output

This sets your camera to match the system of the equipment that you are going to connect to the camera.

\* PAL/NTSC

# TRANSFERRING FILES TO YOUR COMPUTER

## System Requirement

Windows	Macintosh
<ul style="list-style-type: none"><li>■ Pentium III 1GHz or equivalent</li><li>■ Windows 2000/XP/Vista</li><li>■ 512MB RAM</li><li>■ 150MB available hard disk space</li><li>■ CD-ROM drive</li><li>■ Available USB port</li></ul>	<ul style="list-style-type: none"><li>■ PowerPC G3/G4/G5</li><li>■ OS 9.0 or later</li><li>■ 256MB RAM (512MB recommended)</li><li>■ 128MB available hard disk space</li><li>■ CD-ROM drive</li><li>■ Available USB port</li></ul>

## Downloading Your Files

1. Connect one end of the USB cable to an available USB port on your computer.
2. Connect the other end of the USB cable to the USB terminal on the camera.
3. Turn on your camera.
4. Select [PC] using the ▲ / ▼ buttons and press the **SET** button.
5. From the Windows desktop, double click on "My Computer".
6. Look for a new "removable disk" icon.
  - This "removable disk" is actually the memory (or memory card) in your camera. Typically, the camera will be assigned drive letter "e" or higher.
7. Double click on the removable disk and locate the DCIM folder.
8. Double click on the DCIM folder to open it to find more folders.
  - Your recorded images and video clips will be inside these folders.
9. Copy & Paste or Drag-N-Drop image and video files to a folder on your computer.

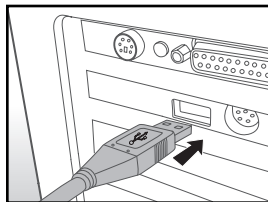

**Mac users:** Double-click the "untitled" or "unlabeled" disk drive icon on your desktop. iPhoto may automatically launch.

# USING THE CAMERA AS A PC CAMERA

Your camera can act as a PC camera, which allows you to videoconference with business associates, or have a real-time conversation with friends or family.

1. After installing the PC camera driver (included on the CD-ROM) in your Windows operating system, restart your computer.
2. Connect one end of the USB cable to the USB terminal of the camera.
3. Connect the other end of the USB cable to an available USB port on your computer.
4. Turn on your camera.
5. Select [PC Camera] with the ▲ / ▼ buttons and press the **SET** button.
6. Position the camera steadily on top of your computer monitor or use a tripod.
7. Launch the videoconferencing application software.
  - Simply follow the instructions in the application software to start your camera.



- 
- This function is not supported by Mac.
  - You are recommended to use Windows Netmeeting (Windows Meeting Space on Windows Vista) as a videoconferencing application software.
  - The video resolution for videoconferencing applications is generally 320 x 240.
  - For more information about the operation of videoconference application software, refer to its respective help documentation.

## EDITING SOFTWARE INSTALLATION

There are 3 types of software that are included on the CD-ROM:

**ArcSoft MediaImpression™** - manages your media for you, and gives you tons of fun and exciting ways to create and share projects featuring your photo, video, and music files. Create your own movies or photo slide shows, complete with soundtrack; edit, enhance, and add fun creative effects to your photos; and share your files easily through simple email attachments or popular photo printing and video sharing websites.

**Print Creations** - brings you a family of fun and easy print-project software that brings out the creativity in you. You can personalize the designs with your own digital pictures and text based on professionally designed templates and layouts. Projects can be printed at home or saved as image files for sharing with family and friends by email or the web.

**COOL 360 SE** - combines ease-of-use, power and flexibility to allow even novice digital imaging enthusiasts to move beyond traditional photos into immersive imaging. Its intuitive interface and easy-to-use wizard deliver great-looking panoramas while advanced warping, blending and alignment tools ensure excellent results.

To install software:

1. Insert the CD-ROM that came with the camera into your CD-ROM drive.  
The welcome screen appears.
2. Click the respective software name.  
Follow the on-screen instructions to complete the installation.



- 
- For more information about the operation of the software, refer to its respective help documentation.
  - For Windows 2000/XP/Vista users, please make sure to install and use the software in "Administrator" mode.
  - The software is not supported by Mac.
  - COOL 360 SE is not supported by Windows Vista.

# SPECIFICATIONS















Item	Description
Image sensor	1/2.33" CCD sensor (10.0 megapixels)
Image resolution	<Still image> 3648 x 2736, 2816 x 2112, 2272 x 1704, 1600 x 1200, 640 x 480 <Video clip> 640 x 480, 320 x 240
LCD monitor	2.7" full color TFT LCD (230K pixels)
Recording media	32MB internal memory (28MB available for image storage) Supports SD/SDHC memory card (up to 4GB) (optional)
File format	JPEG, DCF 1.1, EXIF 2.2, DPOF, AVI
Lens	5x optical zoom lens Aperture range: 3.2(W) - 4.8(T) Focal length:6.2mm - 31mm (equivalent to 37mm - 185mm on a 35mm camera)
Focus Range	Standard 0.5m to infinity Macro Wide: 0.05m to infinity Tele: 0.50m to infinity
Shutter speed	1 - 1/2000 sec.
Digital zoom	5x (Capture mode) 4x (Playback mode)
Flash effective range	0.3m - 2.7m (Wide) 0.3m - 2.1m (Tele)
Terminals	DC IN 5V AV OUT USB 2.0 compliant
Power supply	Rechargeable Lithium-ion battery (3.7V) AC power adapter (5V/2A)
Dimensions	Approx. 94 x 55 x 24mm (without protruding parts)
Weight	Approx. 134g (without battery and memory card)

\* Design and specifications are subject to change without notice.





# APPENDIX

## Possible number of shots (still image)

The table shows the approximate shots that you can capture at each setting based on the capacity of the internal memory and the SD/SDHC memory card.

Size	Quality	Internal Memory	SD/SDHC memory card capacity					
			128MB	256MB	512MB	1GB	2GB	4GB SDHC
10M 3648 x 2736	 Fine	7	33	68	137	276	553	1107
	 Standard	10	47	94	190	382	766	1534
	 Economy	12	55	112	227	455	911	1825
5M 2816 x 2112	 Fine	12	56	114	230	461	923	1848
	 Standard	17	75	151	304	610	1221	2445
	 Economy	19	83	167	336	674	1349	2701
4M 2272 x 1704	 Fine	22	97	197	395	793	1588	3179
	 Standard	25	109	220	442	886	1774	3551
	 Economy	29	127	257	516	1035	2073	4149
2M 1600 x 1200	 Fine	46	197	396	796	1596	3194	6394
	 Standard	55	236	475	955	1913	3830	7666
	 Economy	60	260	522	1049	2102	4207	8421
VGA 640 x 480	 Fine	141	602	1210	2429	4864	9737	19487
	 Standard	154	656	1319	2648	5302	10613	21241
	 Economy	185	788	1583	3178	6365	12740	25498

## Possible recording time / sec (video clip)

Size	Quality	Internal Memory	SD/SDHC memory card capacity					
			128MB	256MB	512MB	1GB	2GB	4GB SDHC
VGA 640 x 480	 Fine	00:00:17	00:01:16	00:02:34	00:05:08	00:10:18	00:20:38	00:44:18
	 Standard	00:00:19	00:01:23	00:02:47	00:05:35	00:11:12	00:22:25	00:44:52
QVGA 320 x 240	 Fine	00:00:54	00:03:54	00:07:51	00:15:45	00:31:34	01:03:11	02:06:27
	 Standard	00:01:03	00:04:31	00:09:05	00:18:15	00:36:33	01:13:10	02:26:27

\* We recommend a memory card of at least 10MB/Sec write speed to prevent auto stop or unexpected results. If you experience an error using a slower SD/SDHC memory card, you can set your camera's video recording to QVGA (320 x 240) and standard quality.

## Troubleshooting

Refer to the symptoms and solutions listed below before sending the camera for repairs. If the problem persists, contact your local reseller or service center.

Symptom	Cause	Solutions / Corrective Actions
The power does not come on.	The battery is not inserted.	Insert the battery correctly.
	The battery is exhausted.	Recharge the battery.
The battery runs out quickly.	The battery is not fully charged. The battery is not used for an extended period of time after being charged.	Fully charge the battery and discharge it for at least one complete cycle before use to maximize its performance and lifetime.
The battery or camera feels warm.	Long period of continuous use of the camera or the flash.	
Even if I press the shutter button, the camera does not take a picture.	The shutter button is not pressed all the way down.	Press the shutter button all the way down.
	The memory card does not have any free capacity.	Insert a new memory card, or delete unwanted files.
	The flash is charging.	Wait until the status LED is off.
	The memory card is write-protected.	Remove the write-protection.
Images do not appear on the LCD monitor.	LCD monitor is dark.	Adjust the brightness of the LCD monitor in the menu.
Although it is set to auto focus, it does not focus.	The lens is dirty.	Wipe clean with a soft, dry cloth or lens paper.
	The distance to the subject is smaller than the effective range.	Get your subject within the effective focus range.
The contents on the memory card cannot be played back.	You played back a memory card that was not formatted by this camera.	Insert a memory card that was formatted on this camera.
Files cannot be deleted.	The file is protected.	Cancel protection.
	The memory card is write-protected.	Remove the write-protection.
Even when the camera's buttons are pressed, it does not operate.	The battery is running low.	Recharge the battery.
The date and time are wrong.	The correct date and time is not set.	Set the correct date and time.
Cannot download images.	The free space on the hard disk in your computer may be insufficient.	Check whether the hard disk has space for running Windows, and if the drive for loading image files has a capacity at least that of the memory card inserted in the camera.
		Use an AC power adapter.
	No power supply.	Recharge the battery.

## Connecting to a PictBridge Compliant Printer

Read this section if the model you purchased is included with the PictBridge functions.

If a printer that supports PictBridge is available, images can be printed by connecting the digital still camera directly to the PictBridge-compatible printer without using a computer.

### Connecting the camera to the printer

1. Connect one end of the USB cable to your camera.
2. Connect the other end of the USB cable to the USB port on the printer.
3. Turn on your camera.
4. The [USB] screen is displayed. Select [Printer] with the  $\blacktriangle$  /  $\blacktriangledown$  buttons, and press the **SET** button.

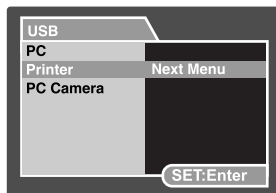

### Printing images

When the camera is properly connected to a PictBridge compliant printer, the PictBridge menu is displayed on the monitor.

1. Select the item you want to configure with the  $\blacktriangle$  /  $\blacktriangledown$  buttons, and press the **SET** button.
  - [Images]: Select whether you want to print specific image or all images. You may also select printing number for specific image.
  - [Date Print]: According to the printer type, select whether you want to print the image with date imprint or not.
  - [Paper Size]: Select the desired paper size according to the printer type.
  - [Layout]: Select the desired printing layout according to the printer type.
  - [Print]: After all settings are configured, select this item to start printing.
2. If you select [Images] in the previous step, the figure shown on the right hand side will appear. Select [Select], [All] or [DPOF] with the  $\blacktriangle$  /  $\blacktriangledown$  buttons, and press the **SET** button.
  - [Select]: Select to print one specific image.
  - [All]: Select to print all images.
  - [DPOF]: Select to print images with DPOF settings.
  - [Exit]: Exit from Images option.

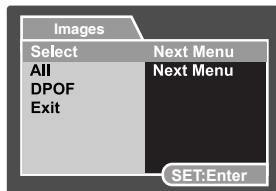
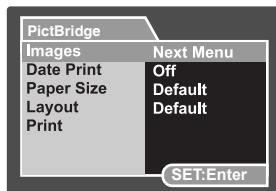

3. If you select [Select] in the previous step, the figure shown on the right hand side will appear.
  - Select the image that you want to print with the ◀ / ▶ buttons.
  - Select the [Print Num] (up to 99) with the ▲ / ▼ buttons.
  - After selecting the desired image and printing number, press the **SET** button to confirm.
4. Select [Exit] with the ▲ / ▼ buttons, and press the **SET** button.

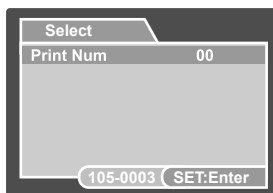

5. Select [Print] with the ▲ / ▼ buttons, and press the **SET** button to start printing.

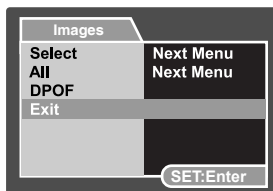

6. The printing starts and the figure shown on the right hand side appears.

- [COMPLETE] will be displayed temporarily, reminding you that the printing procedure is finished.
- If an error is detected during the connection (i.e. the printer hardware problem) between camera and printer, [PRINT ERROR] will be displayed.
- If an error is detected during the communication (i.e. wrong setting on the camera) between camera and printer, [ERROR] will be displayed.

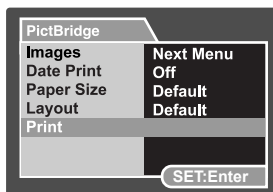

- The image printing may fail if the power to the camera is cut off.
- We recommend that you use the AC power adapter when connecting the camera to the printer.