

MioCARE 

L130/L135 Series

User Manual

Welcome

Thank you for purchasing a MioCARE product. This Quick Start Guide guides you through the successful setup of your device and familiarises you with the basic skills of using the device.

Getting to know your device

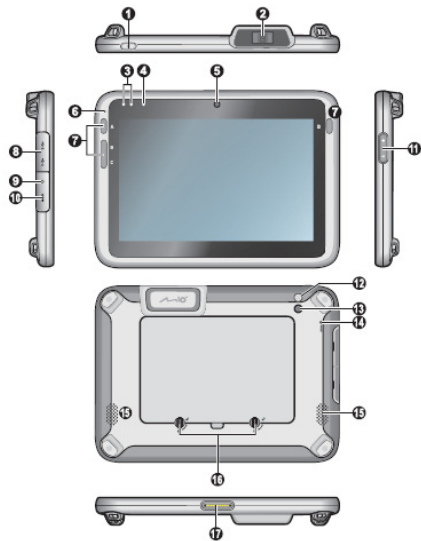

1. POWER Button
2. Barcode Reader*
3. LED Indicators
 - Left LED: Battery status (Green/Amber/Red)
 - Right LED: Barcode reader status* (Green/Red) & System notification
4. Light Sensor
5. Front Camera
6. Microphone
7. Programmable Application Buttons
 - A: Camera
 - B: Browser
 - C: Settings
 - D: Barcode reader*
8. USB Ports
 - A: USB Host port
 - B: Micro-USB port
9. Headphone Socket
10. Power Jack
11. Volume Buttons
12. Flash
13. Rear Camera
14. RESET Button
15. Speakers
16. Battery Cover Latches
17. Dock Connector

* For selected models only.

Getting started

Charging the battery

When charging the battery for the very first time, you should charge it for at least 8 hours (using the AC charger) with your device turned off.

To charge the battery, plug the supplied power cable into the Power jack **(1)** on the left of the device and the mains power charger into a power socket* **(2)**. While charging, the LED indicator on the device lights up to indicate the battery charge status: **Green** – battery full; **Amber** – battery charging; **Red** – battery fault.

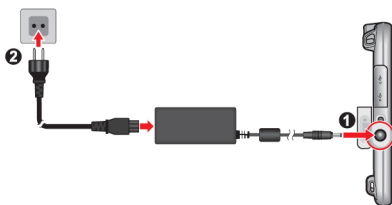

* The plug type varies with the region of your purchase.

CAUTION! For optimal performance of the lithium battery, note the following:

- Do not charge the battery where the temperature is high (e.g. in direct sunlight). The battery will stop charging when the ambient temperature is less than -3°C (26.6°F) or more than 55°C (131°F). The device will operate when the ambient temperature is between -10°C (14°F) and 50°C (122°F).
- Recharge the battery when it is nearly discharged. When recharging, make sure that the battery is fully charged. Doing so can extend the battery life.
- If the device has not been used for over a month or if you find the discharge/recharge time has been shortened, be sure to fully discharge the battery first before recharging it. You are also advised to fully discharge and recharge the battery once every 1–2 months.
- Failure to follow the battery usage instructions can cause damage to your device, battery and even bodily injury or property damage and will void the warranty.

Replacing the battery

The device contains a replaceable LI-ION polymer battery. Follow the instructions below to replace the battery:

1. Open the battery cover and remove the battery.

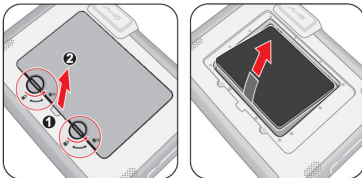

Note: When you remove the battery cover, the system will automatically enter Sleep mode.
The device includes a hot-swap feature allowing the battery to be changed in Sleep mode.

2. Install the battery.

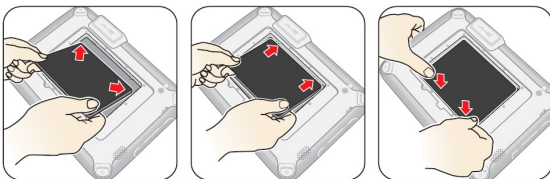

3. Replace the battery cover and turn both latches to the locked position to ensure the battery cover is securely closed.

Installing the memory card and SAM card

1. Open the battery cover and remove the battery.
2. Follow the instruction below to install the cards (not supplied):

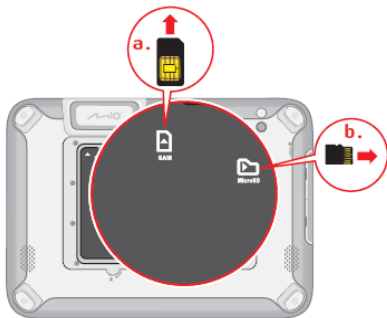

- a. SAM (Secure Access Module) card*
- b. MicroSD card

* For selected models only.

3. Replace the battery.
4. Replace the battery cover and turn both latches to the locked position to ensure the battery cover is securely closed.

Note:

- The device supports up to 32GB MicroSD memory cards. However, it does not guarantee the device's compatibility with memory cards from all manufacturers.
- While installing a card, do not apply pressure to the centre of the card. Do not use your finger or any metal objects to touch and scratch the contact part of the card.
- To remove a card, gently push the top edge of the card inwards to release it and then pull it out of the slot.

Connecting your device to a computer

Connect the Micro-USB end of the USB cable to your device (❶) and the other end to a USB port in your computer (❷). Once connected, you will be able to transfer the files between your computer and device easily through MTP*.

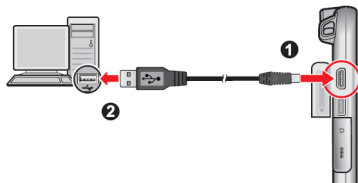

* MTP (Media Transfer Protocol) allows media files (including music, pictures, and other files) to be transferred automatically to and from portable devices. However, for Windows XP users, it is required to install Windows XP Service Pack 3 and Windows Media Player 10 (or higher).

Connecting the USB device

The USB Host port of the device allows you to connect an external USB storage (e.g. a USB flash drive) as the additional storage for the system.

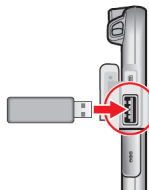

Operating basics

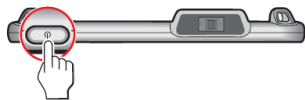

Using the POWER button

- To turn on the device

Note: Before turning on the device, make sure that the battery is installed and the battery cover is closed securely. The device will not power on if the battery cover is missing or open.

Briefly press the POWER button to turn the device on. After the boot up screen, the Home screen will be displayed and the device is in Lock mode by default.

Drag the Lock icon (🔒 > 🗝️) to unlock the system. You can now use your device.

- Sleep mode

Your device will automatically enter **Sleep mode** after 1 minute (by default) of inactivity. You can also manually switch to Sleep mode by pressing the POWER button briefly.

To resume from Sleep mode, briefly press the POWER button.

Note: When the battery power is less than 5%, the system will not resume from Sleep mode after you press the POWER button. Please connect the power cable to charge the battery.

- Aeroplane mode

When you are in an aeroplane or in the area where the use of wireless radio is prohibited, enable **Aeroplane mode**. Many of your devices applications will continue to work (e.g. playing games or listening music) but all wireless radios, including wireless network and Bluetooth, on the device are turned off – it cannot send or receive data.

To enter Aeroplane mode, press and hold the POWER button and select **Aeroplane mode** from the option menu.

- To restart / turn off the device

Press and hold the POWER button and select **Restart / Power off** from the option menu.

- To shut down the device manually

Press and hold the POWER button for 8 seconds.

Navigating on the screen

To operate your device, touch the screen with your fingertip*. You can perform the following actions:



- **Tap:** Touch the screen once with your fingertip to open items or select onscreen buttons or options.
- **Tap and hold:** Tap and hold on the desired item to open the pop-up menu that contains the available options for the item.
- **Drag:** Tap and hold on the item and then move it to the target position without releasing your fingertip.
- **Slide:** Drag to the left/right (or the top/bottom) to switch to the next/previous item on the list.
- **Multi-touch gestures:** Move your fingertips apart or together on the screen to zoom in or out while viewing a picture or a web page.
- **Rotating the screen:** For most applications, you can automatically change the screen orientation (from portrait to landscape, and vice versa) by turning the device sideways.

* Instead of using your fingertip, the active digitizer stylus (optional) lets you enjoy the freedom to write, draw and navigate on your device without leaving fingerprints or smudges.

Home screen

The Home screen is your starting place for tasks, providing quick access to frequently used applications and settings.

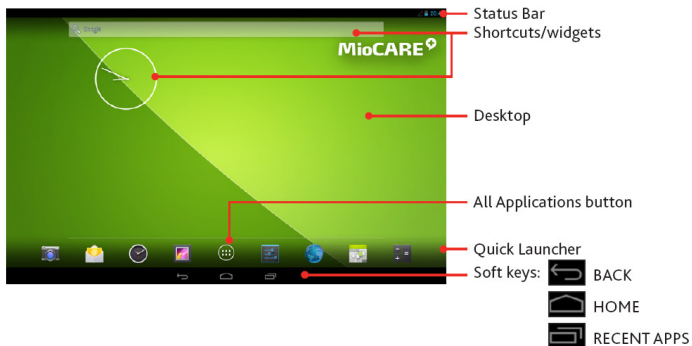

Tip: To display the Home screen, tap the HOME button at any time.

Customising your device

You can customise the device through the Settings menu, including personalising the Home screen, changing the display and sound settings, configuring the connection settings, and more.

From the desktop, do one of the following to access the Settings menu:

- Tap the All Applications button (⋮) > Settings.
- Tap  from the Quick Launcher.

For more information

Support

For initial support, contact your IT department or your local authorised dealer.

Occasionally, MiTAC may offer free system updates to improve user experience. Please regularly check the website <http://miocare.mio.com/> for more information.

IP67

The IEC 60529/IP67 is a European system of test specification standards for classifying the degree of protection provided by the enclosures of electrical equipment. An IP67 designation means that the unit is totally protected against dust, and withstands immersion in one meter (approx 3ft) of still water for up to 30 minutes. MiTAC guarantees this grade provided the battery door and all jack covers are properly and securely closed. This device is not IPX8 grade; water-pressure such as washing the unit with running water may cause damage to the unit and voids warranty.

Federal Communication Commission Interference Statement

This device complies with Part 15 of the FCC Rules. Operation is subject to the following two conditions: (1) This device may not cause harmful interference, and (2) this device must accept any interference received, including interference that may cause undesired operation.

This equipment has been tested and found to comply with the limits for a Class B digital device, pursuant to Part 15 of the FCC Rules. These limits are designed to provide reasonable protection against harmful interference in a residential installation. This equipment generates, uses and can radiate radio frequency energy and, if not installed and used in accordance with the instructions, may cause harmful interference to radio communications. However, there is no guarantee that interference will not occur in a particular installation. If this equipment does cause harmful interference to radio or television reception, which can be determined by turning the equipment off and on, the user is encouraged to try to correct the interference by one of the following measures:

- Reorient or relocate the receiving antenna.
- Increase the separation between the equipment and receiver.
- Connect the equipment into an outlet on a circuit different from that to which the receiver is connected.

- Consult the dealer or an experienced radio/TV technician for help.

FCC Caution: Any changes or modifications not expressly approved by the party responsible for compliance could void the user's authority to operate this equipment.

This transmitter must not be co-located or operating in conjunction with any other antenna or transmitter.

Note: The country code selection is for non-US model only and is not available to all US model. Per FCC regulation, all WiFi product marketed in US must fixed to US operation channels only.

Radiation Exposure Statement:

This device meets the government's requirements for exposure to radio waves.

This device is designed and manufactured not to exceed the emission limits for exposure to radio frequency (RF) energy set by the Federal Communications Commission of the U.S. Government.

The exposure standard for wireless device employs a unit of measurement known as the Specific Absorption Rate, or SAR. The SAR limit set by the FCC is 1.6W/kg. *Tests for SAR are conducted using standard operating positions accepted by the FCC with the device transmitting at its highest certified power level in all tested frequency bands.

IC Regulations:

This device complies with Industry Canada's licence-exempt RSSs. Operation is subject to the following two conditions:

- (1) This device may not cause interference; and
- (2) This device must accept any interference, including interference that may cause undesired operation of the device.

Le présent appareil est conforme aux CNR d'Industrie Canada applicables aux appareils radio exempts de licence. L'exploitation est autorisée aux deux conditions suivantes:

- (1) l'appareil ne doit pas produire de brouillage, et
- (2) l'utilisateur de l'appareil doit accepter tout brouillage radioélectrique subi, même si le brouillage est susceptible d'en compromettre le fonctionnement."

CAN ICES-3(B)/NMB-3(B)

The device could automatically discontinue transmission in case of absence of information to transmit, or operational failure. Note that this is not intended to prohibit transmission of control or signaling information or the use of repetitive codes where required by the technology.

- The device for operation in the band 5150–5250 MHz is only for indoor use to reduce the potential

for harmful interference to co-channel mobile satellite systems;

High-power radars are allocated as primary users (i.e. priority users) of the bands 5250-5350 MHz and 5650-5850 MHz and that these radars could cause interference and/or damage to LE-LAN devices.

Regulatory information (CE)

For regulatory identification purposes, MioCARE L130/L135 is assigned a model number of N450.

Products with the CE marking comply with Radio & Telecommunication Terminal Equipment Directive (R&TTE) (1999/5/EC), the Electromagnetic Compatibility Directive (2004/108/EC) and the Low Voltage Directive (2006/95/EC) - issued by the Commission of the European Community.



Compliance with these directives implies conformity to the following European Standards:

EN 301 489-1: Electromagnetic compatibility and Radio spectrum Matters (ERM); ElectroMagnetic Compatibility (EMC) standard for radio equipment and services; Part 1: Common technical requirements

EN 301 489-3: Electromagnetic compatibility and Radio spectrum Matters (ERM); ElectroMagnetic Compatibility (EMC) standard for radio equipment and services; Part 3: Specific conditions for Short-Range Devices (SRD) operating on frequencies between 9 kHz and 246 GHz

EN 301 489-17: Electromagnetic compatibility and Radio spectrum Matters (ERM); ElectroMagnetic Compatibility (EMC) standard for radio equipment; Part 17: Specific conditions for Broadband Data

EN 300 328: Electromagnetic compatibility and Radio spectrum Matters (ERM); Wideband transmission systems; Data transmission equipment operating in the 2,4 GHz ISM band and using wide band

EN 301 893: Broadband Radio Access Networks (BRAN); 5 GHz high performance RLAN; Harmonized EN covering the essential requirements of article 3.2 of the R&TTE Directive

EN 300 440: Electromagnetic compatibility and Radio spectrum Matters (ERM); Short range devices; Radio equipment to be used in the 1 GHz to 40 GHz frequency range; Part 2: Harmonized EN covering the essential requirements of article 3.2 of the R&TTE Directive

EN 302 291-1: Electromagnetic compatibility and Radio spectrum Matters (ERM); Short Range Devices (SRD); Close Range Inductive Data Communication equipment operating at 13,56 MHz; Part 1: Technical characteristics and test methods

EN 302 291-2: Electromagnetic compatibility and Radio spectrum Matters (ERM); Short Range Devices (SRD); Close Range Inductive Data Communication equipment operating at 13,56 MHz; Part 2: Harmonised EN under article 3.2 of the R&TTE Directive

EN 50566: Product standard to demonstrate compliance of radio frequency fields from handheld and body-mounted wireless communication devices used by the general public (30 MHz — 6 GHz)

EN 62209-2: Human exposure to radio frequency fields from handheld and body-mounted wireless communication devices — Human models, instrumentation, and procedures

EN 62479: Assessment of the compliance of low power electronic and electrical equipment with the basic restrictions related to human exposure to electromagnetic fields (10 MHz to 300 GHz)

EN 60601: Medical electrical equipment —Part 1-2: General requirements for basic safety and essential performance — Collateral standard: Electromagnetic compatibility — Requirements and tests

IEC 60950-1/A1: 2009: Product Safety

EN 50332-2: Sound system equipment: Headphones and earphones associated with portable audio equipment — Maximum sound pressure level measurement methodology and limit considerations —

Part 2: Matching of sets with headphones if either or both are offered separately

EN 55022: Information technology equipment — Radio disturbance characteristics — Limits and methods of measurement

EN 55024: Information technology equipment — Immunity characteristics — Limits and methods of measurement

EN 61000-3-2: Limits for harmonic current emissions

EN 61000-3-3: Limitation of voltage fluctuation and flicker in low-voltage supply system

This device have been tested to comply with the Sound Pressure Level requirement laid down in the applicable EN 50332-2 standards. Permanent hearing loss may occur if earphones or headphones are used at high volume for prolonged periods of time.

Warning statement:



To prevent possible hearing damage, do not listen at high volume levels for long periods.

The manufacturer cannot be held responsible for modifications made by the user and the consequences thereof, which may alter the conformity of the product with the CE Marking.

Declaration of Conformity

Hereby, MiTAC Europe Ltd declares that N450 is in compliance with the essential requirements and other relevant provisions of Directive 1999/5/EC.

Bluetooth



Bluetooth QD ID D022823

SAR information

The radio wave exposure guidelines employ a unit of measurement known as the Specific Absorption Rate (SAR), which adopts the limit of 2 W/kg averaged over ten (10) gram of tissue. Your device has been designed to comply with applicable safety requirements for exposure to radio waves.

SAR = 1.5 W/kg

WEEE



This product must not be disposed of as normal household waste, in accordance with the EU directive for waste electrical and electronic equipment (WEEE - 2002/96/EC). Instead, it should be disposed of by returning it to the point of sale, or to a municipal recycling collection point.