

N536/N536A/N536B

User Manual

Revision: R01
(July, 2018)

Trademark

All brand and product names are trademarks or registered trademarks of their respective companies.

Disclaimer

Specifications and documents are subject to change without notice.

Note

Not all models are available in all regions.

Not all features are available on all models.

Depending on the specific model purchased, the colour and look of your device and accessories may not exactly match the graphics shown in this document. The screenshots and other presentations shown in this document are for reference only.

Table of Contents

1	Device Basics	6
	Getting to Know Your Device.....	6
	Front and Back.....	6
	Left and Right.....	6
	Top and Bottom.....	6
	Installing the Micro-SIM Card, Memory Card and Battery.....	7
	Charging the Battery.....	8
	Extending the Battery Life.....	9
	Turning the Device On and Off.....	9
	Turning On.....	9
	Sleep Mode.....	10
	Airplane Mode.....	10
	Using the Hot-Swap Function.....	10
	Restarting the Device.....	11
	Turning Off.....	11
	Shutting Down.....	11
	Connecting the Device to a Computer.....	11
2	Getting Started	12
	Using the Touch Screen.....	12
	Rotating the Screen.....	13
	Home Screen.....	13
	Status Bar.....	13
	Desktop.....	14
	Google Search Bar.....	14
	Application Shortcuts and Widgets.....	14
	Favourites Tray.....	15
	Grouping Shortcuts in a Folder.....	15
	Changing the Wallpaper.....	15
	Customising the Home Screen Settings.....	15
	Navigation Buttons.....	16
	Quick Settings.....	16
	Your Apps.....	16
	App Permissions.....	16
	App Links.....	17
	Battery Optimization for Apps.....	17
	Stopping an App or a Service from Running.....	17
	Using the Keyboard.....	17
	Changing the Keyboard and Input Methods.....	17
	Basic Editing.....	18
	Adding Your Email Accounts.....	18
	Removing an Account.....	19
3	Connectivity	20
	Cellular Data Connection.....	20
	Wireless Network Connection.....	20
	Connecting to a Wireless Network.....	20
	Removing a Remembered Network.....	20
	Bluetooth.....	20
	Pairing with Another Bluetooth Device.....	21
	Disconnecting a Bluetooth Connection.....	21
	Changing the Bluetooth Name of the Device.....	21

	Removing a Paired Device.....	21
	Connecting to the Internet Using Bluetooth	21
	NFC	21
	Turning NFC On and Off	21
	Transferring Data Using NFC.....	22
4	Applications	23
	BCR Reader	23
	BCR Settings.....	23
	Browser	23
	Calculator	24
	Calendar	24
	Camera.....	24
	Taking a Photo	24
	Recording a Video.....	25
	Camera Settings	25
	Clock.....	25
	Contacts	26
	Importing/Exporting Contacts.....	26
	Adding a Contact.....	27
	Finding a Contact.....	27
	Editing a Contact.....	27
	Managing a Contact.....	27
	Adding a Contact to Favourites.....	27
	Managing a Group	27
	Downloads.....	28
	Email.....	28
	Checking Your Email.....	28
	Sending an Email Message	28
	Responding to an Email Message	29
	Managing Your Email Messages.....	29
	Searching Email Messages.....	29
	File Manager.....	29
	Gallery	30
	Albums	30
	Photos	30
	Videos	31
	MiDM Client.....	32
	Music	32
	Playback Controls	33
	Search	33
	Sound Recorder	33
	Videos.....	33
5	Personalizing Your Device	34
	Settings Menu.....	34
	Wireless and Networks Settings	34
	Device Settings	35
	Personal Settings	36
	System Settings	37
6	Reference.....	39
	Troubleshooting.....	39
	Caring for the Device.....	39
	Regulatory Information	40
	FCC.....	40

IC.....	41
CE	41
RF Exposure Information (SAR)	42
WEEE.....	42
Bluetooth	42
Safety Precautions	42

1 Device Basics

Getting to Know Your Device

Front and Back

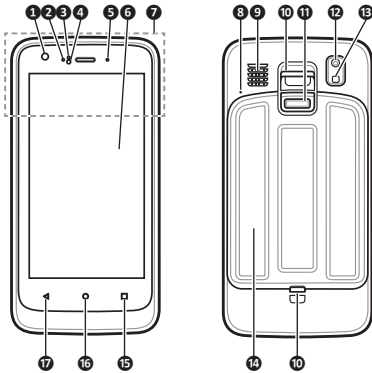

- ❶ Front camera lens*
- ❷ Charge indicator
- ❸ Light sensor
- ❹ Proximity sensor
- ❺ Notification indicator
- ❻ Touch screen
- ❼ NFC sensor*
- ❽ Microphone
- ❾ Speaker
- ❿ Lanyard holder
- ⓫ Battery cover latch
- ⓬ Rear camera lens*
- ⓭ Flash*
- ⓮ Battery cover
- ⓯ Recent Apps
- ⓰ Home
- ⓱ Back

*For selected models only

Left and Right

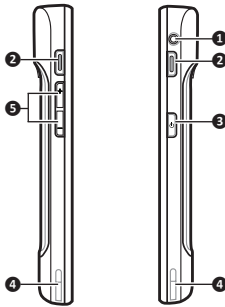

- ❶ Headphone jack
- ❷ Barcode reader button*
- ❸ Power button
- ❹ Socket for device charger
- ❺ Volume buttons

Top and Bottom

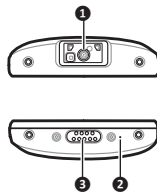

- ❶ Barcode reader*
- ❷ Microphone
- ❸ Dock connector

*For selected models only

Installing the Micro-SIM Card, Memory Card and Battery

1. Slide the battery cover latch downward to unlock the battery cover (1).
2. Using the small opening (beside the power button) as the release point (2), pry the cover open along the side, and then remove the cover.

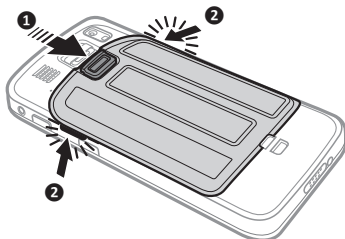

3. Depending on your model, your device may come with a Micro-SIM card slot that allows you to install a Micro-SIM card and use cellular services.

Locate the Micro-SIM card slot inside the battery compartment. Noting the card orientation, hold the card by the edges and gently insert it into the slot (3).

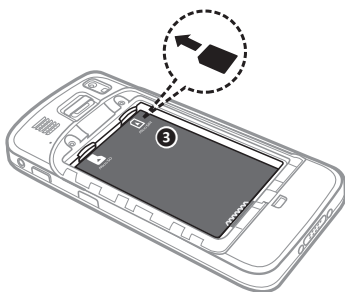

4. Locate the memory card slot inside the battery compartment. Noting the card orientation, hold the card (MicroSD) by the edges and gently insert it into the slot (4).

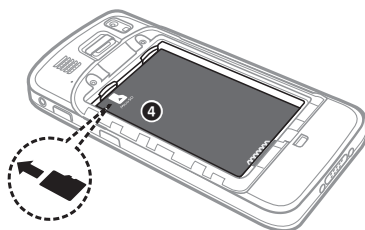

To remove a card, first unmount it from the device by tapping (⋮) on the desktop → **Settings** → **Storage & USB** → . Then gently push the top edge of the card inwards to release it, and pull it out of the slot.

Do not apply pressure to the center of the memory card.

Inserting the card in the reverse direction may cause damage.

The manufacturer does not guarantee the product's compatibilities with the storage cards from all manufacturers.

If you encounter access problems with your memory card, please visit the website https://www.sdcard.org/downloads/formatter_4/ and use the "SD Memory Card Formatter 5.0 for SD/SDHC/SDXC" tool to format your memory card.

- With the label side facing up, match the battery's contact points, insert the battery at an angle, and then fit it into the compartment (5).

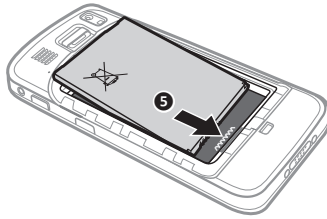

To remove the battery, pull the plastic tab at an angle downward and lift the battery out of the compartment.

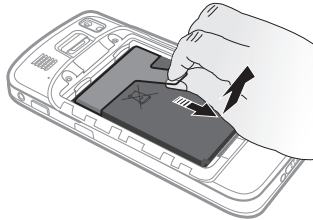

- Place the battery cover back on (6), lightly press the edges of the cover (7), and then slide the battery cover latch upward (8) to lock the battery cover.

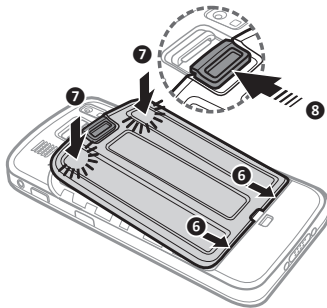

Charging the Battery

i Use only the charger supplied with your device. Use of another type of charger will result in malfunction and/or danger.

When charging the battery for the very first time, you should charge it for at least 8 hours (using the AC charger) with your device turned off.

CAUTION: For optimal performance of the lithium battery:

- Do not charge the battery where the temperature is high (for example, in direct sunlight).
- There is no need to fully discharge the battery.
- When storing the device for a long period of time, be sure to charge the device at least once every two weeks. Over discharge of the device can affect the performance.
- Failure to follow the battery usage instructions could cause damage to your device, battery and even bodily injury or property damage, and will void any warranty.

- Push the clip outwards (1), insert the plug to the AC charger and then push the clip inwards to lock the plug in place (2).

ⓘ The look of the charger plug varies depending on your region.

2. Attach the charging cable to the device by lining up the connector on the holder to the dock connector on the bottom of the device (❸). Make sure that the holder slides into the sockets on the device properly.
3. Plug the USB end of the power cord to the AC charger (❹), and plug the AC charger to a wall outlet (❺).

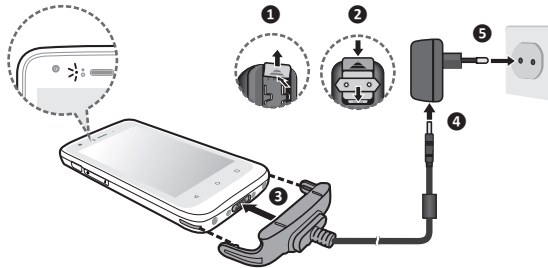

4. To detach the device from the charging cable, gently pry away one side of the holder.

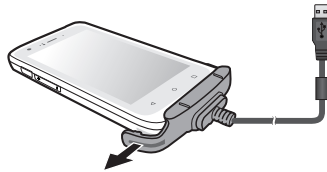

ⓘ When handling the holder of the charging cable, do not use force.

The charge indicator glows red when charging is in progress. When the battery is fully charged, the indicator turns green.

Extending the Battery Life

There are various ways to improve the device's battery life.

- Always fully charge the battery.
- Turn on Battery saver.
- Turn off unnecessary sounds, such as touch sounds.
- Close an app when you are not using it.
- Use a shorter timeout setting of the screen.
- Lower the brightness level of the screen.
- Turn off Bluetooth when you are not using it.
- Prevent the device from constantly scanning for available wireless networks.
- Enable Airplane mode to turn off all wireless transmission functions.

To change settings, tap (⋮) on the desktop → **Settings**.

Turning the Device On and Off

Turning On

1. Press and hold the Power button for about 2 seconds to turn on your device. Wait for the boot screen to display.

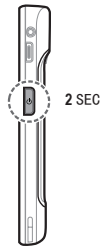

i The battery may not be fully charged when you use the device for the first time. Charge the battery first.

2. The Home screen will display and the device is in Lock mode by default. Drag the Lock icon (🔒) upwards to unlock. The device is ready for use.

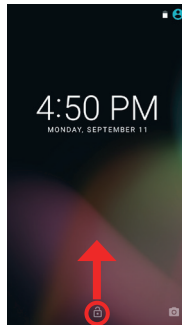

Sleep Mode

Your device will automatically switch off the screen after 1 minute (by default) of inactivity. You can manually switch off the screen by pressing the power button briefly.

To resume the screen, press the Power button briefly and then unlock the device by dragging the Lock icon (🔒) upwards.

Airplane Mode

When you are in an airplane or in the area where data transferring is not allowed, enable Airplane mode. You will be able to use many of your device's applications, but all wireless radios, including wireless networks and Bluetooth, on the device are turned off – it cannot send or receive data.

To enable Airplane mode: press and hold the Power button to display the options menu and tap **Airplane mode**. The ✈️ icon in the status bar indicates that Airplane mode is on.

i You can enable WIFI and Bluetooth in Airplane mode.

To disable Airplane mode: tap (⋮) on the desktop → **Settings** → **More** in **Wireless & networks**, and tap the **Airplane mode** switch to turn it off.

Using the Hot-Swap Function

The device supports the hot-swap function, allowing you to change the battery without having to turn off the device.

1. Press and hold the power button for 2 seconds to display the options menu, and then select **Hot swap battery**.

❗ If you have not used the device for a long time, you are advised not to use the Hot swap battery function until after 3 hours of powering on the device.

2. Wait until the notification indicator on the top-right corner of the front side turns green.

Restarting the Device

You may need to reset the device when the device is running slower or improperly. Press and hold the Power button to display the options menu and tap **Reboot** to restart the device.

Turning Off

To turn off the device, press and hold the Power button to display the options menu and tap **Power off**.

Shutting Down

If the device stops responding, you may need to shut down the device by pressing and holding the Power button for 8 seconds.

Connecting the Device to a Computer

To connect the device to a computer, use the device charger to connect the two devices.

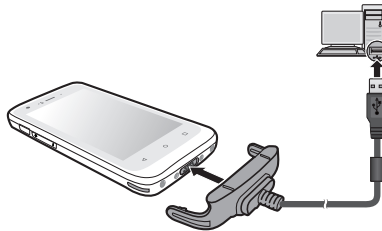

❗ When you connect the device to your computer for the first time, allow the USB driver of the device to be installed properly on your computer.

2 Getting Started

Using the Touch Screen

To operate your device, touch the screen with your finger. You can perform the following actions:

- **Tap:** Touch the screen once with your finger to open items or select on-screen buttons or options.
- **Tap and hold:** Tap and hold on the desired item to open the pop-up menu that contains the available options for the item.



- **Drag:** Tap and hold on the item and then move it to the target position without releasing your finger.
- **Slide/Swipe:** Drag your finger vertically or horizontally across the screen.
 - Drag to the left/right to switch to the next/previous item on the list.
 - Drag to the top/bottom to scroll up/down the screen.

i Not all slide gestures are applicable to all applications.

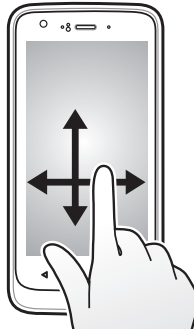

- **Two-finger gestures:** Move your fingers apart or together on the screen to zoom in or out while viewing a picture or a web page.

i Not all two-finger gestures are applicable to all applications.

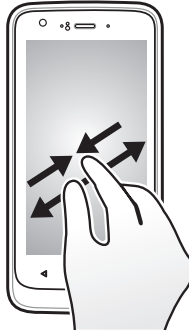

Rotating the Screen

For most applications, you can automatically change the screen orientation, from portrait to landscape and vice versa, by turning the device sideways.

❗ Rotating the screen is not applicable to all applications.

Home Screen

The Home screen is your starting place for tasks, providing quick access to frequently used applications and settings.

To display the Home screen, tap  at any time.

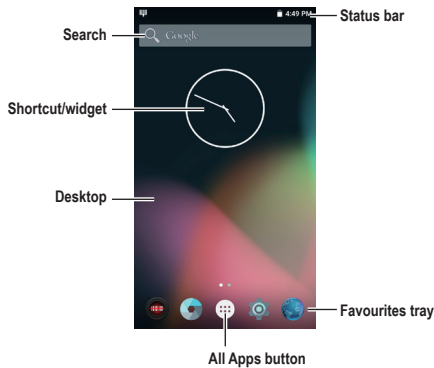

Status Bar

The status bar is at the very top of the screen, displaying system status icons and notification icons.

❗ Depending on your use of the device, some icons are not always shown in the status bar.

System status icons

The system status icons are displayed on the right side of the status bar. They provide the information about your device's status, including the connection status, signal strength, battery power, the time, and more.

Notification icons

The notification icons are displayed on the left side of the status bar. They report the arrival of new emails, calendar events, and other notifications.

When you see notification icons displayed in the status bar, you can open the Notifications panel to view the detailed descriptions. To open the Notifications panel, slide down from the top of the screen with one finger.

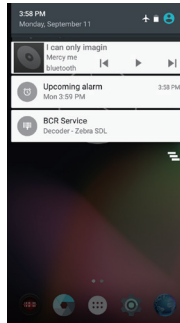

From the Notifications panel, do one of the following:

- Tap a notification to open the related application.
- Tap  to clear all notifications.

Desktop

The desktop includes the Home screen and the extended screens, providing useful information about notifications and device status. It also allows you to add an access to your favourite application shortcuts/widgets on the Home screen and the extended screens.

Slide left or right to switch between the screens.

To add an extended screen:

1. Tap and hold anywhere on the Home screen or an extended screen.
2. Tap **NEW HOME** to add a new extended screen.

 An extended screen will be removed automatically when all shortcuts and widgets on it are moved or removed.

Google Search Bar

The Google search bar is provided on the Home screen by default, allowing you to search the web, or applications, contacts and music stored on your device.

Application Shortcuts and Widgets

The application shortcuts and the widgets, such as the clock and Google search bar, can be placed on either the Home screen or any of the extended screens.

To add a shortcut:

1. Go to the screen where you want to place the shortcut.
2. Tap  on the desktop.
3. Tap and hold the desired app until the Home screen appears, slide it into place, and lift your finger.

To add a widget:

1. Go to the screen where you want to place the widget.
2. Tap and hold anywhere on the desktop, and select **WIDGETS**.
3. Slide left and right to explore the available widgets.
4. Tap and hold the desired widget until the Home screen appears, slide it into place, and lift your finger.

To move a shortcut or widget to another position:

1. Tap and hold the icon, and slide your finger to the new position.
 - To move between the screens on the desktop, slide toward the edge of the screen.
 - To bump another icon out of the way, slide your finger slowly into it.
2. Lift your finger.

To remove a shortcut or widget from the desktop (without removing it permanently from the device), tap and hold the icon, slide your finger toward the top of the screen, and drop it over **Remove**.

Favourites Tray

You can use the Favourites tray at the bottom of the desktop to quickly access the apps.

You can edit the apps in the Favourites tray: simply tap and hold an icon and move it in or out of the Favourites tray or the desktop.

Grouping Shortcuts in a Folder



You can group the shortcuts to apps or settings on the desktop and the Favourites tray into a folder.

1. Tap and hold a shortcut, and then drag it over to another shortcut. A folder will be created automatically.
2. Tap to open the folder.
 - To add another shortcut to the folder, tap and hold the shortcut, and drag it over to the folder.
 - To remove a shortcut from the folder, tap and hold the shortcut, and drag it out of the folder.
3. To rename the folder, tap the title bar of the folder, and enter the desired folder name.
4. To delete the folder, tap and hold the folder, slide your finger toward the top of the screen, and drop it over **Remove**.

Changing the Wallpaper

1. Tap and hold anywhere on the desktop, and select **WALLPAPERS**.
2. Slide right and left at the bottom of the screen and select a wallpaper image, or tap **Pick image** to select an image from your device.
3. Tap **Set wallpaper**.

Customising the Home Screen Settings

Tap and hold anywhere on the desktop, and tap  to access the Home screen settings. To close the settings, tap .

Home screen settings:

- **Search bar:** Show or hide the Google search bar on the Home screen.
- **Scroll effect:** Set the scrolling effect for the screens on the desktop.
- **Icon labels:** Show or hide the names of the icons.
- **Scroll wallpaper:** Set if you want the wallpaper to move along with the screens on the desktop.
- **Grid size:** Set the grid size for the icons on the desktop.

Drawer settings (for customising the app drawer when you tap on the desktop):

- **Layout:** Set if you want to scroll the app drawer horizontally or vertically.
- **Scroll effect:** When the horizontal layout is selected, you can set the scrolling effect for the screens on the desktop.
- **Sorting mode:** When the horizontal layout is selected, you can sort the apps by the name, use count or date.
- **Icon labels:** Show or hide the names of the icons.

App settings:

- **Larger icons:** Set if you want to use larger icons on the desktop.
- **Small text size:** Set if you want to use smaller text for the icons on the desktop.

Navigation Buttons

Three navigation buttons are located at the bottom of the screen:

- ◀: The Back button opens the previous screen you were working in. (You cannot go back further once you return to the Home screen.)
- ○: The Home button returns to the desktop. Tap again to return to the Home screen.
- □: The Recent Apps button opens a list of thumbnail images of the screens you have worked with recently. Tap one to open it. To remove a screen from the list, slide it left or right, or tap the X.

Some screens in apps and Settings have a menu icon ☰. Tap ☰ to access additional options.

Quick Settings

Some frequently used settings can be found in Quick Settings. To open Quick Settings, simply slide down from the top of the screen with two fingers or twice with one finger. Tap an icon to change its setting.

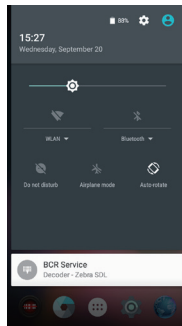

- **WLAN:** Turn the wireless network on or off, or open the WLAN settings menu.
- **Bluetooth:** Turn Bluetooth on or off, or open the Bluetooth settings menu.
- **Do not disturb:** Set how and when to receive notifications.
- **Airplane mode:** Turn the Airplane mode on or off.
- **Auto-rotate:** Set the device's orientation to automatically rotate or lock in the portrait mode.

Your Apps

To see all your apps, tap ☰ in the Favorites tray on the desktop to open the app drawer.



You can place an app icon on any of the screens on the desktop. Tap and hold the app icon, slide your finger, and lift your finger to drop the icon into the desired screen.

To view information about an app from the app drawer, tap and hold the icon, slide your finger toward the top of the screen, and drop the icon over **App info**.

App Permissions



When you use some apps for the first time, you will be prompted to grant permissions for the apps to access certain data or features. To grant a permission, tap **Allow**; to reject a permission, tap **Deny**.

You can customize the permission settings of your apps in Settings:

1. Tap  on the desktop → **Settings** → **Apps** → .
2. Tap the desired option: **App permissions**, **App links**, **Draw over other apps**, or **Modify system settings**.
3. Select an app to customize permission settings.
4. To reset the permission settings, tap  → **Reset app preferences**.



App Links

You can set the default app to handle a link or feature.

1. Tap  on the desktop → **Settings** → **Apps** → .
2. Tap **App links**.
3. Select an app, tap **Open supported links** and change the setting.

Battery Optimization for Apps

You can prolong the battery standby time by performing battery optimization for your apps.

1. Tap  on the desktop → **Settings** → **Apps** → .
2. Tap **Battery optimization**.
3. Tap **Not optimized** → **All apps**.
4. Select an app, tap **Optimize** → **Done**.

Stopping an App or a Service from Running

1. Tap  on the desktop → **Settings** → **Apps**.
2. Tap an app or a service, and tap **FORCE STOP** → **OK**.

Using the Keyboard

When you select a field that requires text or numbers, the on-screen keyboard will automatically display. You can use the on-screen keyboard to enter text, numbers, symbols, etc.



Some apps open the keyboard automatically. In others, tap where you want to type to open the keyboard.

As you type, suggestions for completing each word appear above the keyboard.

To close the keyboard, tap .

Changing the Keyboard and Input Methods

To change the keyboard and input methods:

1. Tap  on the desktop → **Settings** → **Language & input**. The keyboards that you can use are listed in the **Keyboard & input methods** section.
2. Tap **Current Keyboard** → **CHOOSE KEYBOARDS** to see available keyboards.
3. Tap the switch of the desired keyboard to turn it on.
To hide a keyboard, tap its switch to turn it off.
Tap . The new keyboard is now listed in the **Keyboard & input methods** section.
4. Tap **Current Keyboard** and select the keyboard that you want to use as the main input method.
5. To customise the settings for a keyboard, tap it in the **Keyboard & input methods** section.

Basic Editing

To change where you want to type:

- Tap the cursor, and tap and drag the tab below the cursor to the new position.

To select text:

1. Tap and hold (or double-tap) within the text.
2. The nearest word highlights, with a tab at each end of the selection. Drag the tabs to change the selection.











To delete text:

- Tap  to delete the characters before the cursor or selected text.



To cut, copy or paste text:

1. Select the text you want to cut or copy, and tap **CUT** or **COPY**.
2. Tap where you want to paste the text, and tap **PASTE**.

To type capital letters:

- To type one capital letter, tap  once to turn it to .
- To type multiple capital letters, tap and hold (or double-tap)  to turn it to  (caps lock is turned on).
- To quickly change the capitalisation of a word you have already typed, select it and tap the  /  / .
- To type lowercase letters, tap  /  once to turn it to .





To type a symbol:

1. Tap .
2. To view additional symbols, tap .
3. Tap  to return to the keyboard.

To type an accented characters (not applicable to all apps):

- Tap and hold the letter. When the suggestions appear above the keyboard, slide to the desired accented character and lift your finger.

To use emoji (not applicable to all apps):

1. Tap and hold . When  appears on the keyboard, slide to  and lift your finger. You will see the emoji symbols.
2. Slide left or right to view and select the desired emoji.
3. Tap  to return to the keyboard.

Adding Your Email Accounts

 This requires the Internet connection.



You need to set up an account on your device to use the Calendar and Email apps. You can set up multiple accounts.

1. Tap  on the desktop → **Settings** → **Accounts**.
2. Tap **Add account**.
3. Select the type of account that you want to add.
4. Follow the on-screen instructions to add the account.

By default, the auto-sync function of your account is enabled. To manually sync your account, tap  → **Sync now** on the account list screen.

Removing an Account

When you remove an account that you have added to your device, everything associated with that account, including email, contacts, calendar events and settings, is also deleted.

1. Tap  on the desktop → **Settings** → **Accounts**.
2. Select the account to remove.
3. Tap the account email address.
4. Tap  → **Remove account** → **REMOVE ACCOUNT**.

3 Connectivity

Cellular Data Connection

 This feature is not available on all models.

To use cellular services, you must have a subscription to the function with a mobile phone network service. In most cases, the settings of the cellular services are installed automatically.

To turn on or off the cellular services:

1. Tap  on the desktop → **Settings** → **Data usage**.
2. Tap the **Cellular data** switch to turn it on or off.

If you are on a limited data allowance, you can monitor the data usage on the device by tapping  on the desktop → **Settings** → **Data usage**.

 Turn off the cellular services when not in use to save battery power.



 For optimal performances, you may need to change the modem interface setting. For more information, see "Modem Interface" on Page 34.

Wireless Network Connection

To use wireless local area networks (WLAN) on your device, you need access to a wireless access point (AP) or "hotspot."

 The coverage of the WLAN signal can be up to 300 feet (100 metres). However, it varies greatly due to the type of infrastructure, and other objects through which the signal passes.

Connecting to a Wireless Network

3. Tap  on the desktop → **Settings** → **WLAN**.
4. Tap the **WLAN** switch to turn it on. The device will automatically scan for available wireless networks.
If the wireless network you are looking for is not on the list, tap  → **Refresh** to start a new scan.
5. Tap a wireless network to connect.
6. If you select an open network, you will be automatically connected to the network.
If you select a secured network, enter the key and then tap **CONNECT**.
7. When your device is connected to a wireless network, the WLAN icon () will appear in the status bar.

The next time your device connects to a previously accessed secured wireless network, you will not be prompted to enter the key again, unless you reset the network settings or reset your device to its factory default settings.

 Turn off the WLAN function when not in use to save battery power.



Removing a Remembered Network

1. Tap  on the desktop → **Settings** → **WLAN**.
2. Tap and hold the network to remove on the list, and select **Forget network**.

Bluetooth

Bluetooth is a short-range wireless communications technology that allows Bluetooth-enabled devices to exchange information over a distance of about 30 feet (10 metres) without requiring a physical connection.



Pairing with Another Bluetooth Device

1. Make sure that the Bluetooth function of the other device is turned on.
 2. Tap  on the desktop → **Settings** → **Bluetooth**.
 3. Tap the **Bluetooth** switch to turn it on.
The device is visible to nearby devices when the Bluetooth function is turned on.
The device will automatically scan for available Bluetooth devices.
If the Bluetooth device you are looking for is not on the list, tap  → **Refresh** to start a new scan.
 4. Tap the desired device from the list to initiate pairing.
 5. Make sure that the same passkey is displayed on your device and the other device, and then tap **PAIR**.
-  Turn off the Bluetooth function when not in use to save battery power.



Disconnecting a Bluetooth Connection

1. Tap  on the desktop → **Settings** → **Bluetooth**.
2. Tap the desired paired device.
3. When prompted to disconnect, tap **OK**.



Changing the Bluetooth Name of the Device

1. Tap  on the desktop → **Settings** → **Bluetooth**.
2. Tap the **Bluetooth** switch to turn it on.
3. Tap  → **Rename this device**, enter a new name, and tap **RENAME**.

Removing a Paired Device

1. Tap  on the desktop → **Settings** → **Bluetooth**.
2. Tap the **Bluetooth** switch to turn it on.
3. Tap  next to the desired paired device, and tap **FORGET**.

Connecting to the Internet Using Bluetooth

1. Make sure that the Bluetooth tethering function of the paired device is turned on.
2. Tap  on the desktop → **Settings** → **Bluetooth**.
3. Tap the **Bluetooth** switch to turn it on.
4. Tap  next to the desired paired device, select the checkbox for **Internet access**, and tap **OK**.
On the paired device, make sure that the Internet connection sharing checkbox is selected in the Bluetooth connection settings with your device, and tap **OK**.

NFC

 This feature is not available on all models.

Your device supports the Near Field Communication (NFC) feature that allows you to easily transfer data to an NFC-compatible device. The NFC area is located at the upper side of the front of the device.

Turning NFC On and Off

1. Tap  on the desktop → **Settings** → **More** → **NFC**.
2. Tap the **NFC** switch to turn it on or off. The device will automatically scan for available wireless networks.

Transferring Data Using NFC

1. Access the data you want to share, access the share options, and tap **Android Beam**.
2. Touch the screen of your device.
3. Hold the upper front side of your device close to the NFC sensor of the other device (within the range of 4 cm).
4. Pay attention to and accept the beam notification on the other device.

4 Applications

From the desktop, tap the All Apps button (⋮) to see all your apps.

BCR Reader

i This feature is not available on all models.

By using the barcode reader, your device will be able to read the information contained in a barcode.

1. Make sure that the barcode reader is enabled: tap (⋮) on the desktop → **BCR Settings**, and tap the **BCR Settings** switch to turn it on.
2. Tap (⋮) on the desktop → **BCR Reader**.
3. Position your device close to the barcode (within the range of 5 – 10 cm), and point the barcode reader to the barcode.
4. Tap the scan button on the screen to start scanning. Hold your device steadily until the scan is complete and the information is displayed on the screen.

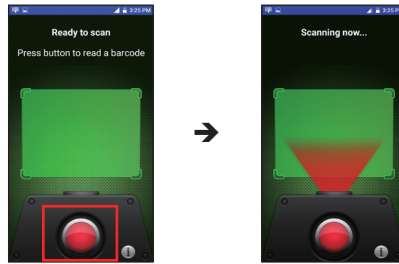

BCR Settings

To configure the barcode reader, tap (⋮) on the desktop → **BCR Settings**, or tap **i** from the barcode reader screen.





- **Decoder:** You can set up the barcode reader functions.
- **Symbology:** You can select the supported barcode types.
- **Indication:** You can set how you want to be notified of the reading result.
- **Information:** This contains the software information of the barcode reader.

Browser

i This feature requires the Internet connection.

Open Browser to start surfing the web. Browser is fully optimised and comes with advanced functionalities, allowing you to enjoy Internet browsing on your device.

1. Tap (⋮) on the desktop → **Browser**.
2. On the browser screen, tap the URL field and enter the web page address.
As you enter the address, the matching web pages/addresses will be displayed on the screen. If you find the web page you want, simply tap the address. Otherwise, continue entering the web page address.

3. When done, tap .
4. To open a new tab, tap  → .
5. To access the bookmarks, tap  → .



Calculator

Calculator helps you calculate simple math problems and complex mathematical functions.



Tap  on the desktop → **Calculator**.

The screen displays the basic panel. To open the advanced panel, slide the green panel from the right edge to the left.

Calendar



-  You must sign in to an account to use Calendar.
-  Syncing calendar events requires the Internet connection.

Use Calendar to view and edit your schedule.

1. Tap  on the desktop → **Calendar**.
2. Tap  → **New event**.
3. On the event details screen, enter the information for the event.
4. Set the event reminder if necessary. You can set multiple reminders.
5. When finished, and tap **DONE**.

To change the calendar view, tap the date field on the top-left of the screen and select **Day**, **Week**, **Month** or **Agenda**.

To read the event details, tap the event on the calendar.

- To edit the details, tap .
- To delete the event, tap .
- To email all parties in a meeting invitation, tap **Email guests**, select a quick response or write your own response.



Camera





Use Camera to take and share photos and videos.

Taking a Photo









1. Tap  on the desktop → **Camera**.

If you are in the Video mode, slide your finger from the left edge to the right, and tap  to switch to the Photo mode.

2. Frame your subject.
 - To focus on a certain part of the image, tap it.
 - To zoom in or out, use the two-finger gestures.
3. Tap  to access the quick settings in the Photo mode:
 - Self-timer : Set the countdown time before taking a photo.
 - Grid : Display or hide the grid line that can be helpful in photo composition.

- **HDR **: When enabled, the HDR (High Dynamic Range) feature can create a clear photo with a better ratio of light to dark.
 - **Flash **: Turn the flash on or off.
 - **Switching camera **: Tap to switch between the front and rear cameras.
4. Tap  below the image area to take the picture.
- The photo displays as a thumbnail in the lower-right corner momentarily. Tap the thumbnail to view the photo.

Recording a Video

1. Tap  on the desktop → **Camera**.
 2. Slide your finger from the left edge to the right, and tap  to switch to the Video mode.
 3. Frame your subject.
 - To focus on a certain part of the image, tap it.
 - To zoom in or out, use the two-finger gestures.
 4. Tap  to access the quick settings in the Video mode:
 - **Grid **: Display or hide the grid line that can be helpful in photo composition.
 - **Flash **: Turn the flash on or off.
 - **Switching camera **: Tap to switch between the front and rear cameras.
 5. Tap  to start recording.
 6. To stop recording, tap .
- The video displays as a thumbnail in the lower-right corner momentarily. Tap the thumbnail to play the video.

Camera Settings

To access the camera settings, slide your finger from the left edge to the right, and tap .

















- **Resolution & quality**
 - **Back camera photo**: Set the photo resolution of the rear camera.
 - **Front camera photo**: Set the photo resolution of the front camera.
 - **Back camera video**: Set the video resolution of the rear camera.
 - **Front camera video**: Set the video resolution of the front camera.
- **Advanced**
 - **Manual exposure**: When enabled, you can tap  in the quick settings in the Photo mode to set the exposure level to adjust the brightness of the image.
 - **Antibanding**: Allow the camera to avoid problems caused by artificial light sources that are not constant.

Clock

Clock displays the current date and time. It also lets you set alarm clocks, and works as a world clock, timer and stopwatch.

Tap  on the desktop → **Clock**.



Tap  to change the clock settings.

- Clock 
 - Tap  to add and show the clocks of other cities.
- Alarm Clock 
 - Tap an alarm item to turn it on and set details of the alarm.
 - Tap the switch of an alarm item to turn it on or off.
 - Tap  to add a new alarm.
- Countdown Timer 
 - Tap the numbers to set the time interval.
 - Tap  to start the countdown.
 - Tap  to pause the countdown.
 - Tap  to reset the timer.
 - Tap  to set a new timer. Multiple timers can run at the same time.
 - Tap  to delete a timer.
- Stopwatch 
 - Tap  to start counting.
 - Tap  to pause counting.
 - Tap  to mark a lap.
 - Tap  to reset the stopwatch.
 - Tap  to share

Contacts



Contacts lists all contacts that are stored on the device and in your online accounts.

Tap  on the desktop → **Contacts**. The app displays the contacts list in the **ALL CONTACTS** tab.



- To set up your contact information, tap **Set up my profile**.
- If you want to filter the contacts list by account, tap  → **Contacts to display**, select **Customise**, select a desired contact account, and tap **OK**.
- To change the sorting method of the contacts list, tap  → **Sort by**.
- To change the format of the contacts' names, tap  → **Name format**.

Importing/Exporting Contacts



You can import contacts to the device, or export contacts for backup.

1. Tap  on the desktop → **Contacts**.
2. Tap  → **Import/Export**.
3. To import contacts, select **Import from .vcf file**. Then select the desired .vcf file.
To export contacts, select **Export to .vcf file**. Select the desired contacts, tap **OK**. Select the storage destination, edit the filename, and tap **SAVE**.



Adding a Contact

1. Tap  on the desktop → **Contacts**.
2. To create a new contact, tap .
3. To save the new contact locally on the device: when prompted, tap **KEEP LOCALLY**.
To save the new contact to an account for online backup: when prompted, tap **OK** to save the new contact to the current account, or tap **ADD NEW ACCOUNT** to create a new account to save the new contact.
4. Enter the information of the new contact in the fields.
5. Tap  to save the contact.



Finding a Contact

1. Tap  on the desktop → **Contacts**.
2. Tap .
3. Enter information in the Find contacts box: the first few letters of the contact name, the first few numbers of the phone number, the first few letters of the email address, or the first few letters of the company name.

Editing a Contact





1. Tap  on the desktop → **Contacts**.
2. Tap **ADD NEW ACCOUNT**, tap the desired contact and tap .
3. Enter the new information.
4. Tap  to save the changes.

Managing a Contact

1. Tap  on the desktop → **Contacts**.
2. Tap **ADD NEW ACCOUNT**, tap the desired contact and tap  to do the following:
 - Tap **Delete** to delete the contact.
 - Tap **Share** to share the contact information with others.
 - Tap **Place on Home screen** to add a shortcut of the contact on the desktop.

Adding a Contact to Favourites





You can save the contacts that you frequently use to Favourites for quick access. Tap the **Favourites** tab to view the Favourites list. The contacts that you access most frequently are automatically added to the Frequently contacted group.



1. Tap  on the desktop → **Contacts**.
2. Tap **ADD NEW ACCOUNT**, and tap the desired contact to view the detailed information.
3. Tap  to turn it to .
4. To remove the contact from Favourites, tap  to turn it to .

Managing a Group

You can organise contacts into a group to quickly contact all parties in the group. You need an account to create groups.

1. Tap  on the desktop → **Contacts**.
2. Tap **GROUPS**, tap the desired contact to view the detailed information.

3. Tap  → **Add Group**.
4. Enter the name of the group.
5. Add the contacts to the group by entering the contact's name or tapping  to select from the contacts list. Tap  to remove a contact.
6. Tap  to save the changes.

To edit a group, tap the group in the **GROUPS** list, tap  → **Edit**. Make the changes and then tap  to save the changes.





To delete a group, tap the group in the **GROUPS** list, tap  → **Delete** → **OK**.

To move a contact to another group, tap the group in the **GROUPS** list, tap  → **Move group members**. Select the contacts to move, tap **OK**, and select the destination group.

Downloads

Downloads includes files that you have downloaded from emails or the Internet.

Tap  on the desktop → **Downloads**. You can:

- Tap an item to open it.
- To share a file with others, tap and hold the file, and tap .
- To delete a file, tap and hold the file, and tap .
- To copy a file to another location, tap and hold the file, tap  → **Copy to...**, and select the file destination.
- To change the sorting method of the files, tap  → **By name**, **By date modified** or **By size**.
- To change the viewing mode, tap  → **Grid view** or **List view**.





Email

 This feature requires the Internet connection.



You need to set up an email account before using the Email app. For more information, see the "Adding Your Email Accounts" section.



Checking Your Email

Tap  on the desktop → **Email**. The screen displays the inbox of one of your email accounts. You can:





- Tap an email message to read.
- To display email messages in another email folder, tap  and tap the folder you want to view.
- To switch to another email account, tap  and tap the desired account.
- To view the email messages from all your email accounts, tap  → **Combined view**.
- To change the settings of an email account, select the account and tap  → **Settings**.

Sending an Email Message



1. Tap  on the desktop → **Email**.
2. Select the desired email account.
3. Tap .
4. Enter the email address of the recipient.
 - To add more recipients, tap + in **To**.
 - To add more recipients in a carbon copy (Cc) or blind carbon copy (Bcc), tap ∨ in **To** → + in **Cc** or **Bcc**.

5. Enter the email subject and then your message.
6. To add an attachment, tap  and select a file.
7. Tap  to send the message.
To save the message and send it later, tap  → **Save draft**. The message will be saved in the Drafts folder.



Responding to an Email Message

1. Tap  on the desktop → **Email**.
2. Select the desired email account.
3. Tap the desired email message.
4. To reply to the sender, tap .
To reply to all recipients, tap  → **Reply all**.
To forward the message to another recipient, tap  → **Forward**.

Managing Your Email Messages

- To move a message that you are reading to another folder, tap  → **Move to**, and select a folder.
 - To delete a message that you are reading, tap .
-  You can select a message by tapping and holding it on the messages list.

Searching Email Messages





1. Tap  on the desktop → **Email**.
2. Select the desired email account.
3. Tap .
4. Enter the words you want to search for in the search box.
5. Tap .
6. On the results list, tap the desired message to view.

File Manager





File Manager allows you to browse a list of folders/files that are stored in the memory card and the internal storage of the device. You can open a file from File Manager by launching the associated application on your device (for example, viewing a picture file by Gallery).

You can also efficiently manage your files using File Manager.

Tap  on the desktop → **File Manager**. The screen of file categories displays. You can do the following:

- To change the storage location:
 - To access files on the memory card (if installed), tap  → **BOOKMARKS** → **SD card** (or the name of your card).
 - To access files in the internal storage of the device, tap  → **BOOKMARKS** → **Internal storage**.
- To browse all types of files, tap **All**.
To browse files of a specific type, tap the desired category. The screen displays the list of the search results.
- To change the view style, tap > to do the following:
 - To change the sorting method of the files, tap  → **By name ▲** (ascending), **By name ▼** (descending), **By date ▲** (ascending) or **By date ▼** (descending).
 - To change the list view style, tap  → **Icons**, **Simple** or **Details**.

Tap < to close the view options.

- You can access the editing and management options by tapping and holding a file/holder or by tapping 
 - **Add shortcut**
 - **Add to bookmarks**
 - **Compute checksum**
 - **Create copy**
 - **Delete**
 - **Deselect all**
 - **New file**
 - **New folder**
 - **Open**
 - **Open parent**
 - **Open with**
 - **Print**
 - **Properties**
 - **Refresh**
 - **Rename**
 - **Select**
 - **Select all**
 - **Send**
 - **Set as home**
- To search for a file by keyword, tap .
- To change the settings, tap  → .

Gallery







You can browse all the images and videos that are on your device and the memory card in Gallery.

Tap  on the desktop → **Gallery**. By default, the screen displays the Timeline view with all photos and videos.

Albums





To view photos and videos by albums, tap  → **Albums**. Tap an album to view the photos and videos in a chronological order.

From the album list, you can do the following:

- Tap a photo or video in an album to view it.
- Tap  to switch to the Camera app.
- To  to view all photos in an album in a slideshow.
- To change the viewing mode, tap  → **Grid view** or **List view**.
- To share an album/a photo, tap and hold an album/a photo until the check mark appears. Tap to select other albums/photos. Tap  to share via email or NFC (Android Beam), or tap  to share via Bluetooth.
- To delete an album/a photo, tap and hold an album/a photo until the check mark appears. Tap to select other albums/photos. Tap  to delete the selected albums/photos.
- To select all albums/photos, tap and hold an album/a photo until the check mark appears. Then tap  → **Select all**.

Photos

When viewing a photo, you can do the following:



- To share the photo via email, NFC (Android Beam) or Bluetooth, tap .
- To delete the photo, tap .
- To view all photos in the album in a slideshow, tap  → **Slideshow**.
- To set the photo as the wallpaper of the Home screen or the assigned photo for one of your contacts, tap  → **Set picture as** → **Wallpaper** or **Contact photo**.
- To view the information of the photo, tap  → **Details**.

- To save the photo as a PDF file, tap  → **Print** → . Select the storage directory, confirm or modify the filename, and tap **SAVE**.





Editing Photos

When viewing a photo, tap . Select **Gallery** as the photo editing app.

You can do the following:

- To adjust the color of the photo, tap **Color** and select the desired effect.
- To add a photo frame to the photo, tap **Frames** and select the desired photo frame.
- To crop the photo, tap **Crop** → **Crop**.
 - To move the crop frame, tap and hold inside the frame, and drag it to the desired position.
 - To resize the crop frame, tap and drag the edges or the corners of the frame inward or outward.
- To straighten a crooked photo, tap **Crop** → **Straighten**. Tap and drag the crop frame until you have the desired effect.
- To rotate the photo, tap **Crop** → **Rotate** to rotate it 90 degrees clockwise.
- To flip the photo, tap **Crop** → **Mirror** for a vertical flip; tap again for a horizontal flip; tap again for a vertical flip.
- To draw on the photo, first select a color to use. Tap one of the colors at the bottom of the screen, or tap  to select a desired color and set its transparency effect. Tap  to save the color settings.
- To adjust the exposure of the photo, tap **Exposure** and select the desired effect.
- To add a beautifying effect to the photo, tap **Beautify** and select the desired effect.

When editing is finished, tap . You can do the following:









- To clear your drawing, tap  → **Reset**.
- To view the information of the edited photo, tap  → **Information**.
- To export the edited photo, tap  → **Export**. You can resize the photo and set the export quality. Tap **Done** to save the settings.
- To save the edited photo as a PDF file, tap  → **Print** → . Select the storage directory, confirm or modify the filename, and tap **SAVE**.

When done, tap **Done** to save the edited photo as a copy.











Videos

To view only videos, tap  → **Videos**. The videos are listed in a chronological order.

You can do the following:



- Tap a video.
 - To view the information of the video, tap  → **Details**.
 - Tap  to view it.
- Tap  to switch to the Camera app.
- To change the viewing mode, tap  → **Grid view** or **List view**.
- To share a video, tap and hold a video until the check mark appears. Tap to select other videos. Tap  to share via email or NFC (Android Beam), or tap  to share via Bluetooth.
- To delete a video, tap and hold a video until the check mark appears. Tap to select other videos. Tap  to delete the selected videos.
- To select all videos, tap and hold a video until the check mark appears. Then tap  → **Select all**.

On the playback screen, you can do the following:

- To share the video via email, NFC (Android Beam) or Bluetooth, tap .
- To pause the playback, tap . To resume the playback, tap .
- To fast backward (rewind)/forward 3 seconds, tap / .
- To change the viewing mode, tap  to view in fit-height full screen,  in crop screen, or  in fit-width full screen.
- To stop the playback, tap .
- Tap  to access more options:
 - **Audio effects:** When enabled, you can customize the sound settings.
 - **Loop/Single:** Play the video repeatedly/once.
 - **Stereo/Single track:** Set the audio mode.
 - **Input URL:** Enter a URL address for streaming.
 - **Streaming Settings:** Customize the settings for streaming.
 - **Previous/Next:** Play the previous/next video.
 - **Settings:** Change the time for each fast backward/forward step.
 - **Speaker ON/OFF:** Turn off/on the speakerphone mode.

Editing Videos

Tap a video on the video list. You can do the following:

- To mute the video, tap  → **Mute**. The muted video is saved as a copy.
- To trim the video, tap  → **Trim**. Drag the trim sliders to the part where you want the video to begin and end. Tap  to preview it. Tap **Done** to save the trimmed video as a copy.

MiDM Client

MiDM is an Android Mobile Device Management (MDM) solution for remote management and control of Android devices. You can use it to update Android mobile devices, install or uninstall apps on Android mobile devices, etc.

For more information, refer to the MiDM documentation.

Music



Before using the Music app, have the audio files ready either on the device or on a memory card.



 Not all music file formats are supported by the Music app.

Tap  on the desktop → **Music**.

By default, the screen displays the Songs list. To filter audio files by category, tap  → **Artist, Albums** or **Playlists**.









You can do the following:

- To start playback, tap a file from the list, **Shuffle All** or .
- To view the Now playing screen, tap the current playback area at the bottom of the playlist.
- Tap  next to the desired file on the list to do the following:
 - **Play:** Play the file.
 - **Add to playlist:** Add the current file to the current or a new playlist.
 - **Delete:** Delete the file permanently from the device or the memory card.

- **Use as phone ringtone:** Set the current file as the phone ringtone.
 - **Share:** Share the file via Bluetooth, NFC (Android Beam) or email.
 - **Details:** View the information of the file.
- To search for a file by keyword, tap .
 - To customize the sound settings, tap  → **Snapdragon Audio+**.

Playback Controls

On the playback screen, you can do the following:

- To pause the playback, tap . To resume the playback, tap .
- To play the previous/next file, tap .
- To play by random sequence, tap . Tap again to disable the feature.
- Tap  to cycle through the repeat modes. : playing by sequence; : repeating the current file.
- To view the current playlist, tap .
- Tap  to access more options:
 - **Add to playlist:** Add the current file to the current or a new playlist.
 - **Use as phone ringtone:** Set the current file as the phone ringtone.
 - **Equalizer:** When enabled, you can customize the sound settings in Snapdragon Audio+.
 - **Delete:** Delete the file permanently from the device or the memory card.





Search

The Search feature enables you to search the web, or applications, contacts and music stored on your device. Simply enter words in the Google search bar.

Sound Recorder

Sound Recorder is useful for quickly recording messages or thoughts at any time.

Tap  on the desktop → **Sound Recorder**.

1. To record a message, tap , hold the device near your mouth, and start recording.
2. To pause recording, tap . To resume recording, tap .
3. To stop recording, tap . You can preview the message by tapping .
4. To save the message, tap **Done**. Otherwise tap **Discard**.

After the message is saved, you can access the file by using Music or File Manager to search and play it.

Tap  to change the settings:

- Tap **File type** to change the format of the recorded messages.
- Tap **Storage location** to change the location of the recorded messages to the device or the memory card.

Videos



See "Videos" in the "Gallery" section for information.

5 Personalizing Your Device

You can easily customise the device for personal settings through the Settings menu, such as personalizing the Home screen, changing the display and sound settings, configuration the connection settings, and more.

Settings Menu

To access the Settings menu, do one of the following:

- Tap  on the desktop → **Settings**.
- Slide down from the top of the screen with two fingers or twice with one finger to open Quick Settings, and tap .

 Not all features are available on all models.

Wireless and Networks Settings

WLAN

See the "Wireless Network Connection" section in the "Connectivity" chapter for information.

Bluetooth

See the "Bluetooth" section in the "Connectivity" chapter for information.

Data usage

You can monitor the data usage on the device. This is useful if you are on a limited data allowance.

Airplane mode

See the "Airplane Mode" section in the "Device Basics" chapter for information.

NFC

See the "NFC" section in the "Connectivity" chapter for information.

WIFI Calling Settings

When enabled, this "VoIP" feature helps improve the connection to make and receive calls and text messages, and audio quality over a WIFI network.

Android Beam

See the "NFC" section in the "Connectivity" chapter for information.

VPN

You can use a virtual private network (VPN) to access the Internet with more security and privacy. A VPN may also get around regional restrictions.

To set up a VPN connection, tap **+**, enter the details of the VPN and tap **SAVE**. Tap the VPN to connect, enter the required username and password, select the checkbox for **Save account information**, and tap **CONNECT**.

If you want to access the Internet via a VPN only, tap  → **Always-on VPN**.

Cellular networks

- You can change the mobile network settings, such as turning on or off data services when roaming, selecting a network mode, selecting Internet settings, or selecting a network manually.
- **Modem Interface:** the interface options include USB and UART. For optimal performances:
 - **USB:** Use this option when the device is using the mobile network, but is not connected to the cradle or computer. Restart the device for the change to take effect.
 - **UART:** Use this option when the device is using the mobile network and is connected to the cradle or computer. Restart the device for the change to take effect.

Mobile plan

You may be able to access the website to view the mobile plan of your service provider. (This feature may not be supported on all models.)

Emergency broadcasts

The emergency alerts feature can warn you about dangerous weather conditions, natural disasters, AMBER alerts, etc.

Device Settings

Display

- **Brightness level:** Move the slider to adjust the brightness level of the device.
- **Adaptive brightness:** When enabled, this can automatically optimize the brightness level of the device based on the available light around you.
- **Wallpaper:** Change the wallpaper of the desktop.
- **Sleep:** Change the screen time-out setting.
- **Daydream:** Set the screensaver when the device is charging or docked.
- **Font size:** Select the desired font size.
- **When device is rotated:** To set the screen to rotate automatically based on the device orientation, select **Rotate the contents of the screen**. Otherwise, select **Stay in current orientation**.

Sensors

- **Touch:** Tap **Calibration** to calibrate the touch screen if the touch screen is not working properly.

Sound & notification

- Move the slider to adjust the sound level for media playback, alarms and ringtones.
- If you want the device to vibrate besides playing a ringtone when there is an incoming call, enable **Also vibrate for calls**.
- **Do not disturb:** Set how and when to receive notifications.
- You can set the ringtones for incoming calls and notifications.
- Tap **Other sounds** to enable or disable **Dial pad tones**, **Screen locking sounds**, **Charging sounds**, **Touch sounds** and **Vibrate on touch**. You can also set the sound mode for emergency alerts.
- **When device is locked:** Set how to display notifications when the device is locked.
- **App notifications:** Set the notification settings individually for apps. (The setting under **When device is locked** will always take precedence over the setting for an individual app.)
- **Notification access:** View the apps that can access your notifications.
- **Do Not Disturb access:** View the apps that can override the **Do not disturb** setting.



Apps

You can manage the permission settings, default links and battery optimization for the apps. See the "Modem Interface: the interface options include USB and UART. For optimal performances:" section in the "Getting Started" chapter for information.

Storage & USB

The storage options of your device include the device internal storage and a removable memory card (if inserted). You can view the storage status in **Storage & USB**.

- **Internal storage:** This is used for personal settings and data, and downloaded or transferred contents. Tap this item to view more information and options.
- **Portable storage:** You can move media files or apps to a memory card to free up space in the internal storage. Tap this item to view more information and options.
 - To unmount the memory card, tap  before removing the card from the device.

- To format the memory card, tap the card name →  → **Settings** → **Format**. Note that all data will be erased from the card when you format it.
- You can use and format a new memory card as the device's internal storage. Tap the card name →  → **Settings** → **Format as internal**. Follow the on-screen instructions to complete the procedure. Note that if this card is not to be used as internal storage any longer, move all data to the device's internal storage before reformatting the card.

Battery

You can view the percentage and time of the remaining battery power since the last full charge.

You can turn on the Battery saver feature to help conserve the battery power. Tap  → **Battery saver**. You can turn on or off Battery saver, or set when to turn it on automatically.

For information on battery optimization for apps, see the "Modem Interface: the interface options include USB and UART. For optimal performances:" section in the "Getting Started" chapter.

Memory



The memory (RAM) of the device is used to handle the system and running apps. It is not used as storage space. You can view the memory status in **Memory**.

Users



You can share the device with others by creating a separate user space for each person. Each user can have their own settings, Home screens, etc.

You can also have someone use the device temporarily as a guest user instead of a regular user.

To add a new user:

1. Tap  on the desktop → **Settings** → **Users** → **Add user** → **OK**.
2. Tap **SET UP NOW**. The device will switch to the lock screen. Unlock the screen to use the device as the new user.
3. To select a user, slide down from the top of the screen with two fingers or twice with one finger to open Quick Settings, tap  and select the desired user.





To remove a user:

1. Tap  on the desktop → **Settings** → **Users**.
2. If you are the owner of the device, tap  next to the user's name, and tap **Remove user**.
If you are not the owner of the device, tap  → **Delete New user from this device**.

Personal Settings

Security

- **Screen lock**: Set the lock setting when the screen enters the sleep mode or when you press the power button. This can protect your personal information.
When using **Pattern** as the screen lock, you can customize the settings in **Make pattern visible**, **Automatically lock** and **Power button instantly locks**.
When using **Password** and **PIN** as the screen lock, you can customize the settings in **Automatically lock** and **Power button instantly locks**.
- **Lock screen message**: Set the message to display on the lock screen.
- **Encrypt phone**: When the device is encrypted, the data on the device cannot be read by an unauthorized party.
- **Make passwords visible**: When enabled, the characters of your passwords will not be hidden behind asterisks.
- **Device administrators**: View or activate/deactivate device administrators.

- **Unknown sources:** Enable this feature if you want to install an app from an unknown source.
- **Storage type:** Display the storage type.
- **Trusted credentials:** Most certificates are installed automatically for the purpose of identifying your device for security. Tap to display the trusted certificates installed on the device.
- **Install from SD card:** Use this feature if you want to manually install a certificate.
- **Clear credentials:** Use this feature if you want to remove all certificates that you have installed (not including the permanent system certificates).
- **Trust agents:** View or activate/deactivate security services to bypass the lock screen. To use this feature, you need to set the screen lock.
- **Screen pinning:** When enabled, you can lock the screen to a specific app, which can prevent prying from someone else while using your device and accidental key presses.
To use screen pinning:
 1. Enable **Screen pinning** in **Settings** → **Security**.
 2. Open the screen you want to pin.
 3. Tap  (Recent Apps button) on the device.
 4. Swipe up and then tap .
 5. To unpin the screen, tap and hold  and  at the same time.
- **Apps with usage access:** Manage what apps have access to app-usage data on your device

Accounts

You can set up multiple accounts on the device. For information on managing your accounts, see the "Modem Interface: the interface options include USB and UART. For optimal performances:" section in the "Getting Started" chapter.

Language & input

- **Language:** Change the display language.
- **Spell checker:** When enabled, you can tap on a misspelled word to get a list of suggested replacements.
- **Personal dictionary:** Add your own words to your personal dictionary so that your device remembers them.
- **Current Keyboard:** Change the keyboard language.
- **Android Keyboard (AOSP):** Change the keyboard settings.
- **Text-to-speech output:** Customise the text-to-speech settings.
- **Pointer speed:** Change the speed of scrolling.

Backup & reset

- **Network settings reset:** Reset the settings for mobile data, WIFI or Bluetooth when you encounter connection problems.
- **Factory data reset:** Delete all data and settings from the device. Back up your data before performing a factory data reset.

System Settings

Date & time

You can change the date and time of your device.

Accessibility

There may not be accessibility services installed on your device.

- **Captions:** Enable or disable the closed captions.
- **Magnification gestures:** When this item is enabled, you can zoom or magnify by triple-tapping the screen.

- **Large text:** Enable this item to make the screen easier to see.
- **High contrast text:** Enable this item to make text easier to read by turning colored text to black or white.
- **Power button ends call:** When this item is enabled, you can end a call easily by simply pressing the device's power button.
- **Auto-rotate screen:** When this item is enabled, the screen rotates automatically based on the device orientation.
- **Speak passwords:** When this item is enabled, password characters are announced audibly when optional accessibility services are enabled.
- **Accessibility shortcut:** When this item is enabled, you can enable optional accessibility services quickly.
- **Text-to-speech output:** Customise the text-to-speech settings.
- **Touch & hold delay:** Change the delay level for a touch on the screen to become a touch and hold.
- **Colour inversion:** Exchange colour values of the screen.
- **Colour correction:** When this item is enabled, the colours displayed on the screen are adjusted for people with difficulties distinguishing colours.

Printing

There may not be printing services installed on your device.

About phone

You can view the device and software information, and check for available system updates.

6 Reference

Troubleshooting

For initial support, contact your IT department or your local authorised dealer.

Power does not switch on when using battery power.

The remaining battery power may be too low to run your device. Charge the battery.

Screen responds slowly.

Make sure that your device is not running out of battery power. If the problem still persists, restart your device.

Screen freezes.

Restart your device.

Screen is hard to read.

Make sure that the backlight of the display is set to a high-enough brightness.

Cannot establish a connection with a computer.

- Make sure that your device and your computer are both switched on before trying to establish a connection.
- Make sure that the cable is securely plugged into the USB port on your computer and on your device. Connect the USB cable directly to your computer—do not run the cable through a USB hub.
- Restart your device before connecting the cable. Always disconnect your device before you restart your computer.

Caring for the Device

Taking good care of your device will ensure trouble-free operation and reduce the risk of damage to your device.

- Keep your device away from excessive moisture and extreme temperatures.
- Avoid exposing your device to direct sunlight or strong ultraviolet light for extended periods of time.
- Do not place anything on top of your device or drop objects on your device.
- Do not drop your device or subject it to severe shock.
- Do not subject your device to sudden and severe temperature changes. This could cause moisture condensation inside the unit, which could damage your device. In the event of moisture condensation, allow the device to dry out completely before use.
- The screen surface can easily be scratched. Avoid touching it with sharp objects. Non-adhesive generic screen protectors designed specifically for use on portable devices with LCD panels may be used to help protect the screen from minor scratches.
- Never clean your device with it powered on. Use a soft, lint-free cloth to wipe the screen and the exterior of your device.
- Do not use paper towels to clean the screen.
- Never attempt to disassemble, repair or make any modifications to your device. Disassembly, modification or any attempt at repair could cause damage to your device and even bodily injury or property damage and will void any warranty.
- Keep your device and its accessories out of the reach of small children or animals.
- Do not store or carry flammable liquids, gases or explosive materials in the same compartment as your device, its parts or accessories.
- To discourage theft, do not leave the device and accessories in plain view in an unattended vehicle.

- Do not leave the device and its accessories in a vehicle in direct sunlight. Overheating may damage the device.
- The device (excluding accessories) is protected against splashes, water and dust. When tested under controlled laboratory conditions, the device is compliant with the IP67 rating of the IEC 60529 standard. The manufacturer guarantees this grade provided all jack covers are properly and securely closed. Immersion in water or water-pressure such as washing the unit with running water may cause damage to the unit and voids warranty. Normal wear might decrease resistance. The device should not be operated in water.

Regulatory Information

For regulatory identification purposes, A500 series is assigned a model number of N536/N536A/N536B.

Marking labels located on the exterior of your device indicate the regulations that your model complies with. Please check the marking labels on your device and refer to the corresponding statements in this chapter. Some notices apply to specific models only.

Maximum radio frequency (RF) power for Europe:

BT	8.9 dBm
BLE	0.1 dBm
2.4G_11b	17.9 dBm
2.4G_11g	18.3 dBm
2.4G_11n20	17.6 dBm
5G_11a	19.02 dBm
5G_11n20	19.07 dBm
5G_11n40	19.06 dBm
GSM900	32 dBm
GSM1800	28.95 dBm
LTE Band3	22.48 dBm
LTE Band7	20.76 dBm
LTE Band 20	21.98 dBm
RFID	-9.88 dBuA/m@10m
Bluetooth	2402-2480 MHz
WLAN 2.4 GHz	2412-2472 MHz
WLAN 5G Hz	5180-5240 MHz / 5260-5320 MHz / 5500-5700 MHz
NFC	13.553-13.567 MHz

FCC



Federal Communication Commission Interference Statement

This equipment has been tested and found to comply with the limits for a Class B digital device pursuant to Part 15 of the FCC Rules. These limits are designed to provide reasonable protection against harmful interference in a residential installation. This equipment generates, uses, and can radiate radio frequency energy and, if not installed and used in accordance with the instructions, may cause harmful interference to radio communications. However, there is no guarantee that interference will not occur in a particular installation. If this equipment does cause harmful interference to radio or television reception, which can be determined by turning the equipment off and on, the user is encouraged to try to correct the interference by one or more of the following measures:

- Reorient or relocate the receiving antenna.
- Increase the separation between the equipment and receiver.
- Connect the equipment into an outlet on a circuit different from that to which the receiver is connected.

- Consult the dealer or an experienced radio/TV technician for help.

Any changes or modifications not expressly approved by the manufacturer could void the user's authority to operate the equipment.

This device complies with part 15 of the FCC Rules. Operation is subject to the following two conditions: (1) This device may not cause harmful interference, and (2) this device must accept any interference received, including interference that may cause undesired operation.

Please note:

The use of a non-shielded interface cable with this equipment is prohibited.

IC

Canadian Department Of Communications

CAN ICES-3(B)/NMB-3(B)

Radio Interference Regulations Class B Compliance Notice

This Class B digital apparatus meets all requirements of the Canada Interference-Causing equipment regulations.

Cet appareil numérique de Classe B respecte toutes les exigences du Règlement Canadien sur le matériel brouilleur.

This device complies with Industry Canada's licence-exempt RSSs. Operation is subject to the following two conditions:

- (1) This device may not cause interference; and
- (2) This device must accept any interference, including interference that may cause undesired operation of the device.

Le présent appareil est conforme aux CNR d'Industrie Canada applicables aux appareils radio exempts de licence. L'exploitation est autorisée aux deux conditions suivantes:

- (1) l'appareil ne doit pas produire de brouillage, et
- (2) l'utilisateur de l'appareil doit accepter tout brouillage radioélectrique subi, même si le brouillage est susceptible d'en compromettre le fonctionnement."

The device could automatically discontinue transmission in case of absence of information to transmit, or operational failure. Note that this is not intended to prohibit transmission of control or signaling information or the use of repetitive codes where required by the technology.

The device for operation in the band 5150–5250 MHz is only for indoor use to reduce the potential for harmful interference to co-channel mobile satellite systems.

High-power radars are allocated as primary users (i.e. priority users) of the bands 5250–5350 MHz and 5650–5850 MHz and that these radars could cause interference and/or damage to LE-LAN devices.

Cet équipement doit être installé et utilisé avec un minimum de 10 mm de distance entre la source de rayonnement et votre corps.

CE



Products with the CE marking comply with Radio Equipment Directive (Directive 2014/53/EU) - issued by the Commission of the European Community.

Compliance with these directives implies conformity to the following European Standards:

- EN301489-1: Electronic compatibility and Radio spectrum Matters (ERM), ElectroMagnetic Compatibility (EMC) standard for radio equipment and services; Part 1: Common technical requirements
- EN301489-3: Electronic compatibility and Radio spectrum Matters (ERM), ElectroMagnetic Compatibility (EMC) standard for radio equipment and services; Part 3: Specific conditions for Short-Range Devices (SRD) operating on frequencies between 9 kHz and 246 GHz
- EN55032: Electromagnetic compatibility of multimedia equipment-Emission requirements
- EN55035: Immunity characteristics

- EN61000-3-2: Limits for harmonic current emissions
- EN61000-3-3: Limitation of voltage fluctuation and flicker in low-voltage
- EN 300328: BT/WLAN 2.4 GHz
- EN 300330: RFID/NFC
- EN301893: WLAN 5 GHz
- EN301511: WWAN GSM
- EN301908-1: WWAN LTE
- EN301908-13: WWAN LTE
- IEC 60950-1:2005
IEC 60950-1:2005/AMD1:2009
IEC 60950-1:2005/AMD2:2013
(EN 60950-1:2006 + A11:2009 + A1:2010 + A12:2011 + A2:2013)

The device is restricted to indoor use only when operating in the 5150 to 5350 MHz frequency range.

	AT	BE	BG	HR	CY	CZ	DK
	EE	FI	FR	DE	EL	HU	IE
	IT	LV	LT	LU	MT	NL	PL
	PT	RO	SK	SI	ES	SE	UK

RF Exposure Information (SAR)

This device has been tested and meets applicable limits for Radio Frequency (RF) exposure. Specific Absorption Rate (SAR) refers to the rate at which the body absorbs RF energy. SAR limits are 1.6 Watts per kilogram (over a volume containing a mass of 1 gram of tissue) in countries that follow the United States FCC limit and 2.0 W/kg (averaged over 10 grams of tissue) in countries that follow the Council of the European Union limit. Tests for SAR are conducted using standard operating positions with the device transmitting at its highest certified power level in all tested frequency bands. To reduce exposure to RF energy, use a hands-free accessory or other similar option to keep this device away from your head and body. Carry this device at least 10 mm away from your body to ensure exposure levels remain at or below the as-tested levels. Choose the belt clips, holsters, or other similar body-worn accessories which do not contain metallic components to support operation in this manner. Cases with metal parts may change the RF performance of the device, including its compliance with RF exposure guidelines, in a manner that has not been tested or certified, and use such accessories should be avoided.

WEEE



This symbol means that according to local laws and regulations your product shall be disposed of separately from household waste. When this product reaches its end of life, take it to a collection point designated by local authorities. Proper recycling of your product will protect human health and the environment.

Bluetooth

 Bluetooth® DID: D033925

Safety Precautions

- When using the device, note that the ambient temperature should be below 45°C (113°F).
- To prevent possible hearing damage, do not listen at high volume levels for long periods of time.

About Charging

- Use only the charger supplied with your device. Use of another type of charger will result in malfunction and/or danger.

- This product is intended to be supplied by a LISTED Power Unit marked with "LPS", "Limited Power Source" and output rated + 5 V dc / 2.0 A.
- Use a specified battery in the equipment.

About the Charger

- Do not use the charger in a high moisture environment. Never touch the charger when your hands or feet are wet.
- Allow adequate ventilation around the charger when using it to operate the device or charge the battery. Do not cover the charger with paper or other objects that will reduce cooling. Do not use the charger while it is inside a carrying case.
- Connect the charger to a proper power source. The voltage requirements are found on the product case and/or packaging.
- Do not use the charger if the cord becomes damaged.
- Do not attempt to service the unit. There are no serviceable parts inside. Replace the unit if it is damaged or exposed to excess moisture.

About the Battery

- Use a specified battery in the equipment.
- **CAUTION:** This unit contains a Lithium Ion battery. The battery can burst or explode, releasing hazardous chemicals. To reduce the risk of fire or burns, do not disassemble, crush, puncture, or dispose of in fire or water.
- Important instructions (for service personnel only)
 - Caution: Risk of explosion if battery is replaced by an incorrect type. Dispose of used batteries according to the instructions.
 - Replace only with the same or equivalent type recommended by the manufacturer.
 - The battery must be recycled or disposed of properly.
 - Use the battery only in the specified equipment.

USA Contact Information

Magellan
279 E Arrow Highway San Dimas, CA 91773 USA
+1 909-394-5000
<http://www.magellangps.com>