

MITEL

# 5312 IP Phone



NN0330

## O Mitel 5312 IP Phone

- 1 Visor
- 2 Indicador de Toque/Mensagem
- 3 Comandos do Volume, Altifalante, Silêncio
- 4 Teclas de Função Fixas
- 5 Teclado
- 6 Teclas pessoais
- 7 Altifalante
- 8 Auscultador

## Teclas de Função Fixas

- ALTIFALANTE
- SILENCIAR
- MENU
- CANCELAR
- REMARCAR
- ESPERA
- TRANSF/CONFERÊNCIA
- MENSAGEM



**NOTA:** Para obter mais informações sobre como utilizar outras funções, ou sobre a programação das Teclas Pessoais no seu 5312 IP Phone, consulte o *Manual do Utilizador do 5312/5324 IP Phone*, localizado em [www.mitel.com](http://www.mitel.com), ou contacte o seu Administrador.

## Efectuar uma Chamada

- 8 Levante o auscultador ou
- 3 Prima .
- 5 Marque o número pretendido ou
- 6 Prima uma tecla de **Chamada Rápida** ou
- 4 Prima ou
- 5 Marque o prefixo para chamadas externas (por ex.: 9) e o número.

## Atender uma Chamada

- 8 Levante o auscultador ou
- 3 Prima e comece a falar.

## Terminar uma Chamada

- 4 Prima ou
- 8 Pouse o auscultador.

## Colocar uma Chamada em Espera

- 4 Prima .
- A tecla de linha pisca.
- 8 Pouse o auscultador se necessário.

## Recuperar uma Chamada em Espera

- 8 Levante o auscultador ou
- 3 Prima .
- 6 Prima a tecla da linha a piscar.

## Recuperar uma Mensagem

- 4 Prima . Esta tecla pisca quando existe uma mensagem em espera. Siga as indicações do correio de voz para obter a sua mensagem.

## Transferir uma Chamada

- 4 Prima .
- 5 Marque o número. Aguarde uma resposta.
- 8 Desligue ou anuncie a transferência e desligue.

## Chamadas em Conferência

- 4 Prima .
- 5 Marque o número. Aguarde uma resposta.
- 4 Prima .

## Programar uma Chamada Rápida

- 4 Prima .
- 5 Prima # até que **Teclas Pessoais?** apareça.
- 5 Prima \*.
- 6 Prima uma **Tecla Pessoal**.
- 5 Prima \*.
- 5 Marque o número.
- 6 Prima a **Tecla Pessoal** novamente.
- 5 Prima \* para tornar o número privado ou
- 5 Prima # para manter o número visível.
- 4 Prima .

## Ajustar os Níveis de Volume

Ajuste o volume da campainha enquanto o telefone está a tocar. Ajuste o volume do altifalante enquanto utilizar o auscultador ou o altifalante.

- 3 Prima repetidamente para aumentar o volume ou repetidamente para diminuir o volume.
- 3 Prima para silenciar o microfone. Para obter detalhes, consulte o *Manual do Utilizador do 5312/5324 IP Phone*.

MITEL

# 5324 IP Phone



NN0331

## O Mitel 5324 IP Phone

- 1 Visor
- 2 Softkeys
- 3 Indicador de Toque/Mensagem
- 4 Comandos do Volume, Altifalante, Silêncio
- 5 Teclas de Função Fixas
- 6 Teclado
- 7 Teclas pessoais
- 8 Altifalante
- 9 Auscultador

## Teclas de Função Fixas

- ALTIFALANTE
- SILENCIAR
- MENU
- CANCELAR
- REMARCAR
- ESPERA
- TRANSF/CONFERÊNCIA
- MENSAGEM



**NOTA:** Para obter mais informações sobre como utilizar outras funções, ou sobre a programação das Teclas Pessoais no seu 5324 IP Phone, consulte o *Manual do Utilizador do 5312/5324 IP Phone*, localizado em [www.mitel.com](http://www.mitel.com), ou contacte o seu Administrador.

### Efectuar uma Chamada

- 9 Levante o auscultador ou
- 4 Prima .
- 6 Marque o número ou
- 7 Prima uma tecla de **Chamada Rápida** ou
- 5 Prima ou
- 6 Marque o prefixo para chamadas externas (por ex.: 9) e o número.

### Atender uma Chamada

- 9 Levante o auscultador ou
- 4 Prima e comece a falar.

### Terminar uma Chamada

- 5 Prima ou
- 9 Pouso o auscultador.

### Colocar uma Chamada em Espera

- 5 Prima . A tecla de linha pisca.
- 9 Pouso o auscultador se necessário.

### Recuperar uma Chamada em Espera

- 9 Levante o auscultador ou
- 4 Prima .
- 7 Prima a tecla da linha a piscar.

### Recuperar uma Mensagem

- 5 Prima . Esta tecla pisca quando existe uma mensagem em espera. Siga as indicações do correio de voz para obter a sua mensagem.

### Transferir uma Chamada

- 5 Prima .
- 6 Marque o número. Aguarde uma resposta.
- 9 Desligue ou anuncie a transferência e desligue.

### Colocar uma Chamada em Conferência

- 5 Prima .
- 6 Marque o número. Aguarde uma resposta.
- 5 Prima .

### Programar uma Chamada Rápida

- 5 Prima .
- 2 Prima N° até que **Teclas Pessoais?** apareça.
- 2 Prima **Sim**.
- 7 Prima uma Tecla Pessoal.
- 2 Prima **Alterar**.
- 2 Prima **Sim** para **Chamada Rápida?**.
- 6 Marque o número.
- 2 Prima **Priv** para tornar o número privado.
- 2 Prima **Guardar**.
- 5 Prima .

### Ajustar os Níveis de Volume

Ajuste o volume da campainha enquanto o telefone está a tocar. Ajuste o volume do auscultador ou do altifalante enquanto utilizar o auscultador ou altifalante.

- 4 Prima repetidamente para aumentar o volume ou repetidamente para diminuir o volume.
- 4 Prima para silenciar o microfone. Para obter detalhes, consulte o *Manual do Utilizador do 5312/5324 IP Phone*.

MITEL

# Communications Director

5312 IP and 5324 IP Phones  
User Guide



## **GENERAL NOTICE**

The information contained in this document is not warranted by Mitel Networks Corporation or any of its affiliates or subsidiaries ("Mitel") and is subject to change without notice. Mitel assumes no liability for any errors or omissions. This document may be reproduced, either wholly or in part, solely for distribution to authorized users of Mitel's products.

## **NOTICE TO DEALERS OR DISTRIBUTORS**

As the dealer or distributor, you assume responsibility for the content contained in this document. To signify responsibility, you must insert your company name in the one of the places indicated.

Mitel logos and wordmarks, along with legal disclaimers and copyright information, contained in these documents must NOT be removed.

Mitel provides this documents as is. No support is available from Mitel or its subsidiaries to assist the user with the modification, printing, distribution, or other processes pertaining to the use of these documents.

## **TRADEMARKS**

Mitel and Speak@Ease are trademarks of Mitel Networks Corporation.

Windows and Microsoft are trademarks of Microsoft Corporation.

Other product names mentioned in this document may be trademarks of their respective companies and are hereby acknowledged.

Mitel 5312 and 5324 IP Phone - User Guide  
July 2009

®,™ Trademark of Mitel Networks Corporation  
© Copyright 2009, Mitel Networks Corporation  
All rights reserved

---

**IMPORTANT! This telephone is NOT suitable for direct connection to the public-switched telephone network. Connect the telephone to a Mitel Networks system only.**

---

---

<b>ABOUT YOUR PHONE .....</b>	<b>1</b>
Ring/Message Indicators .....	4
Selecting Menu Options.....	4
Using Your IP Phone with Mitel Unified Communicator Express.....	4
Using Your IP Phone in Remote Mode.....	4
About Feature Access Codes .....	4
For Users on Resilient 3300 ICP Systems .....	5
Line Interface Module .....	5
<b>TIPS FOR YOUR COMFORT AND SAFETY .....</b>	<b>6</b>
Don't cradle the handset!.....	6
Protect your hearing .....	6
Adjust the viewing angle .....	6
<b>CUSTOMIZING YOUR 5312/5324 IP PHONE .....</b>	<b>7</b>
Ringer Control.....	7
Handset Receiver Volume Control .....	7
Speaker Volume Control.....	7
Display Contrast Control.....	7
Feature Keys .....	8
Language Change .....	8
<b>MAKING AND ANSWERING CALLS .....</b>	<b>10</b>
Make a Call.....	10
Answer a Call.....	10
Emergency Calls.....	10
Auto-Answer .....	11
Phonebook.....	12
Redial.....	13
Redial – Saved Number.....	13
Speed Call Keys .....	13

Speed Call – Personal .....	14
Handsfree Operation .....	14
Group Listen .....	15
Hold .....	15
Mute .....	16
Transfer .....	16
Conference .....	17
Conference Split .....	17
Add Held (5324 IP Phone only) .....	17
Swap .....	18
Call Forward .....	18
Call Forward - Remote (I am Here) .....	19
Call Forward - End Chaining.....	20
Call Forward - Forced (5324 IP Phone only) .....	20
Call Forward - Override .....	20
Messaging - Advisory .....	21
Messaging - Callback .....	21
Messaging - Cancel Callback .....	22
Messaging - Cancel All Callbacks .....	23
<b>USING OTHER FEATURES.....</b>	<b>24</b>
Account Codes .....	24
Attendant Call Hold - Remote Retrieve.....	24
Call Park .....	25
Call Pickup.....	25
Campon .....	26
Do Not Disturb .....	26
Override .....	26
Paging.....	27
Direct Paging .....	27

---

Direct Paging - Handsfree Answerback Enabled.....	27
Direct Paging - Handsfree Answerback Disabled.....	28
Direct Voice Call .....	29
Timed Reminder (5324 IP Phone only) .....	29
Headset Operation.....	30
Headset Operation.....	31
Music .....	31
Group Paging / Meet Me Answer.....	32
Phone Lock.....	32
User PIN (5324 IP Phone only) .....	33
Trunk Flash.....	34
Record a Call.....	34
Hot Desking .....	35
Hot Desk Remote Logout .....	36
Tag Call .....	36
Call History .....	36
Night Answer .....	37
Release.....	38
Mobile Extension .....	38
Group Presence.....	39
Handoff - Personal Ring Groups.....	40
<b>USING YOUR 5324 IP PHONE WITH THE 5310 IP CONFERENCE UNIT .....</b>	<b>41</b>
Using the 5310 Conference Unit with a Mouse .....	41
Using the 5310 Conference Unit without a Mouse .....	42
<b>USING THE LINE INTERFACE MODULE (5324 IP PHONE ONLY).....</b>	<b>43</b>
Line Interface Module Mode .....	43
Failover Mode .....	44
Emergency Calls.....	45

<b>USING THE MITEL IP PROGRAMMABLE KEY MODULES (5324 IP PHONE ONLY).....</b>	<b>46</b>
<b>FEATURE ACCESS CODES .....</b>	<b>47</b>



## ABOUT YOUR PHONE

The Mitel 5312 and 5324 IP Phones are full-feature, dual port, dual mode telephones that provide voice communication over an IP network. Each features a back-lit liquid crystal display (LCD) screen, display-assisted access to features, on-hook dialing and off-hook voice announce with handsfree answerback, and a large ringing/message indicator. The 5312 IP Phone offers 12 programmable keys, and the 5324 IP Phone offers 24 programmable keys for one-touch feature access. Both phones provide ten fixed feature keys for convenient access to features such as Conferencing, Redial, and many customizable user settings.

The 5312 and 5324 IP Phones support Mitel Call Control (MiNet) protocol and Session Initiated Protocol (SIP). The 5324 IP Phone also supports modules such as the Line Interface Module, 5310 IP Conference Unit, and the 12 and 48 Button Programmable Key Modules. The 5324 IP Phone can be used as an ACD Agent Phone or a Teleworker phone. The personal key on the bottom left (5312) or bottom right (5324) is always your Prime Line; the remaining personal keys can be programmed as:

- Feature keys (for example, Do Not Disturb). You can program feature keys from your phone (5324 only), or using the Desktop Tool. Your administrator can also program feature keys.
- Speed Call keys. You can program speed call keys from your phone, or using the Desktop Tool.
- Line Appearances. Only the administrator can program line appearances.



Note: For more information on the Desktop Tool, talk to your system administrator.















NN0330

5312 IP Phone



NN0331

5324 IP Phone

Elements of Your Phone	
Feature	Function
1) Display	Provides a two–line, 20–character liquid crystal display (LCD) viewing area that assists you in selecting and using phone features, accessing your voice mail, and identifying callers. When you access the Menu key, prompts and feature information appear on the display screen. For information on selecting menu options, see "Selecting Menu Options" elsewhere in this guide.
2) Softkeys (5324 IP Phone only)	Context-sensitive keys change depending on the modes of the operation and the menu currently displayed. Softkeys enable you to easily view and select a variety of features.
3) Ring/Message Indicator	Flashes to signal an incoming call and to indicate a message waiting in your voice mailbox.
4) Volume, Speaker and Mute Controls	<p>Provide the following audio control capability:</p> <p> (UP) and  (DOWN) provide volume control for the ringer, handset, and handsfree speakers.</p> <p> (SPEAKER) enables and disables Handsfree mode.</p> <p> (MUTE) enables Mute, which allows you to temporarily turn your phone's handset, headset or handsfree microphone off during a call.</p>
5) Fixed Function Keys	<p>Give you access to the following phone functions:</p> <p> (MENU) : provides access to menus for your phone's additional features. Note : When navigating through Menu options, press  (CANCEL) or  (MENU) to back up one menu level.</p> <p> (CANCEL) : ends a call when pressed during the call, and, when you are programming the phone, eliminates any input and returns to the previous menu level.</p> <p> (REDIAL) : calls the last number dialed.</p> <p> (HOLD) : places the current call on hold.</p> <p> (TRANS/CONF) : initiates a call transfer or establishes a three–party conference call.</p> <p> (MESSAGE) : provides access to your voice mailbox and flashes to notify you of messages waiting in your voice mailbox. Note : The Ring/Message indicator also flashes when messages are waiting.</p>
6) Keypad	Use to dial.
7) Programmable Personal Keys and Designation Card	Provides 12 or 24 keys that can be programmed as speed call keys, feature keys, or line appearance keys, according to your communication needs. Personal keys have status indicators. On a 5324 IP Phone, the bottom right personal key is always your Prime Line key. On the 5312 IP Phone, the bottom left personal keys is always your Prime Line key. Write the name (speed call, feature or line appearance) of the Personal keys that you program on the designation card (use the side of the card with the textboxes provided). Use the slot behind the plastic cover at the bottom of the phone to remove/insert the designation card.
8) Handsfree Speaker	Provides sound for Handsfree calls and background music.
9) Handset	Use for handset calls. If you are in headset or handsfree mode, you do not need to use the handset.

## Ring/Message Indicators

When indicator is	it means that
Flashing rapidly	Your phone is ringing
Flashing slowly	A message or callback message is waiting at your phone
On	Your phone is ringing another phone
Off	Your phone is idle, or you are on a call

## Selecting Menu Options

Because the 5324 IP Phone offers softkeys, feature availability and menu options for the 5312 and 5324 IP Phones may differ.

To select menu items on the display:

1. On a 5324 IP Phone, press the softkeys.
2. On a 5312 IP Phone, press \*, 0 and # on the keypad. For example, if options \*=YES 0=DEFAULT #=NO appear and you want to select YES, press \*.

Procedures in this guide show all menu selection options, where applicable—for example, "Press the \* or **Yes** softkey". Procedures in this guide also specify when a menu option is available on only one of the phones—for example, "On a 5324 IP Phone only, press the **Save** softkey".

## Using Your IP Phone with Mitel Unified Communicator Express

Unified Communicator Express is a lightweight (server-less) unified communications client that provides productivity enhancements like click to dial, incoming caller ID pop-up, PC-based missed calls and speed calls list, and personal (Microsoft® Outlook®) directory integration. In addition to enhancing telephony features in the office environment, it allows you to be immediately attentive to all incoming communications.

For more information on installing and using this application, see the *Mitel Unified Communicator Express* documentation available at [www.mitel.com](http://www.mitel.com).

## Using Your IP Phone in Remote Mode

Remote Mode allows the 5312 and 5324 IP Phone to be used as a Teleworker in the home or in other locations away from the office. For information on how to program your IP Phone for remote operation, refer to the *Multi-protocol Border Gateway Remote IP Phone Configuration Guide* available at [www.mitel.com](http://www.mitel.com)

## About Feature Access Codes

Use of some features requires dialing access codes. Ask your Administrator for a list of codes you should use.

## For Users on Resilient 3300 ICP Systems

If during a call, you hear two beeps repeated every 20 seconds it means that your phone is switching to a secondary 3300 ICP system. The call continues but some of the keys and features on your phone function differently. The keys and most features begin working normally again after you hang up. If your phone switches to the secondary system while your speaker or handset is muted (that is, while the  MUTE light is on), the call remains muted until you hang up. Normal operation resumes when your phone switches back to the primary system. If your phone is idle and switched to the secondary system, you'll see a flashing rectangle on the display. The rectangle remains until the switch to the primary system is complete.

## Line Interface Module

The Line Interface Module is an optional device that adds an analog phone line (POTS) capability to your 5324 IP phone only. If Emergency Call Routing is not programmed on your 3300 ICP, you must use the Line Interface Module to dial emergency calls. For more information on emergency number dialing, refer to Emergency Calls. If you have a Line Interface Module connected to your 5324 IP Phone, all programming of the Line Interface Module, except the Analog Key, is done by the Installer when your phone is installed. For more information, refer to "Using the Line Interface Module" elsewhere in this guide. **Note:** The 5312 IP Phone does not support the Line Interface Module.

## TIPS FOR YOUR COMFORT AND SAFETY

### Don't cradle the handset!

Prolonged use of the handset can lead to neck, shoulder, or back discomfort, especially if you cradle the handset between your ear and shoulder. If you use your phone a lot, you may find it more comfortable to use a headset. See the section on headset usage elsewhere in this guide for more information.

### Protect your hearing

Your phone has a control for adjusting the volume of the handset receiver or headset. Because continuous exposure to loud sounds can contribute to hearing loss, keep the volume at a moderate level.

### Adjust the viewing angle

The stand built into your phone tilts to give you a better view of the keys.

To tilt your telephone for better viewing:

1. Turn the phone so that the front faces away from you.
2. Hold the base unit firmly and press the release tabs on the sides of the stand to detach the base unit.
3. Hinge the hooks of the base unit into the notches on the back of the phone and snap into place as follows:
  - For a high-angle mount, hinge the two lower hooks into the bottom set of notches and snap the two upper hooks into the middle set of notches.
  - For a low-angle mount, hinge the two lower hooks into the middle set of notches and snap the two upper hooks into the top set of notches.

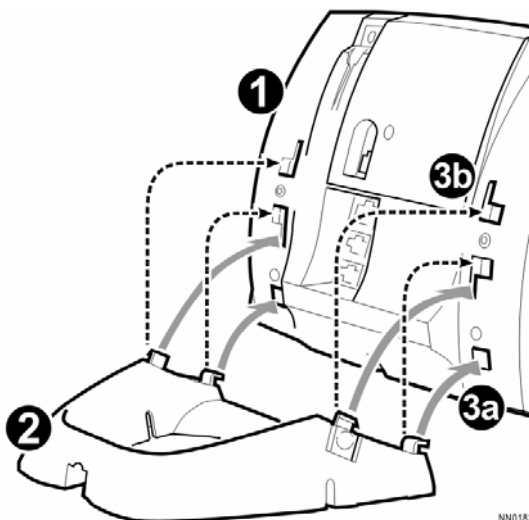



NN0183





## CUSTOMIZING YOUR 5312/5324 IP PHONE

### Ringer Control

**To adjust the Ringer Volume while the set is ringing:**



- Press  (UP) or  (DOWN).

**To adjust the Ringer Pitch while the set is idle:**

1. Press  (MENU).
2. Press # or the No softkey until "Ringer Adjust?" appears.
3. Press \* or the Yes softkey twice.
4. Press  (UP) or  (DOWN).
5. Press  (MENU).



### Handset Receiver Volume Control

**To adjust the Handset Receiver Volume when you are using the handset:**

- Press  (UP) or  (DOWN).



### Speaker Volume Control

**To adjust the Speaker Volume when making a handsfree call or when listening to background music:**

- Press  (UP) or  (DOWN).



### Display Contrast Control

**To adjust the Display Contrast while your set is idle:**

- Press  (UP) or  (DOWN).



## Feature Keys

You can use  (MENU) on your phone or the Desktop Tool to program the personal keys as feature keys. The Desktop Tool is a browser-based interface that makes programming quick and easy. For more information on using the Desktop Tool, please contact your System Administrator.



 **Note:** You can only program Speed Call keys using the  (MENU) key on the 5312 IP Phone. See Speed Call Keys for details.

To program some features to a personal key, you must dial a feature access code. Ask your Administrator for a list of codes you can use.

### To display information about a key:

1. Press  (MENU).
2. Press a personal key that isn't a line key.
3. Press  (MENU).

### To program a personal key:

1. Press  (MENU).
2. Press # or the No softkey until "Personal Keys?" appears.
3. Press \* or the Yes softkey.
4. Press a personal key that isn't a line key.
5. Press \* or the Change softkey.
6. Press # or the No softkey until the desired feature appears.
7. Press \* or the Yes softkey.
8. On a 5312 IP Phone only, press # to save the feature under the chosen key.
9. Press  (MENU), or press another personal key and proceed to program another feature.
10. Write the feature name on the key label.

## Language Change

### To change the display language:

1. Press  (MENU).
2. Press # or the No softkey until "Language?" appears.
3. Press \* or the Yes softkey.



4. Press \* or the Change softkey.
5. Press # or the No softkey until the desired language appears.
6. Press \* or the Yes softkey.

## MAKING AND ANSWERING CALLS

### Make a Call

1. Lift the handset (optional).
2. If you want to use a Non–Prime Line, press a Line Appearance key.
3. Do one of the following:
  - Dial the number
  - Press a Speed Call key
  - Press <sup>123</sup> (REDIAL).

### Answer a Call

Do one of the following:

- Lift the handset.
- Press  (SPEAKER).
- Press the flashing Line appearance key and lift the handset.
- Press the flashing Line appearance.

### Emergency Calls

**Warning for emergency number dialing:** Consult your local authorities for Emergency Numbers and 911 or equivalent service availability in your area. There are two methods of dialing emergency numbers, based on the programming of your 3300 ICP:

- Emergency Call Routing NOT programmed
- Emergency Call Routing programmed

---

**Caution: Verify with your System Administrator which type of emergency number dialing you can use.**

---

#### EMERGENCY CALLS WHEN EMERGENCY CALL ROUTING NOT PROGRAMMED

If Emergency Call Routing is NOT programmed, Emergency Number dialing should only be performed by picking up the handset and selecting the Line Interface Module key you have programmed. If Privacy Mode is enabled and the Line Interface Module key local line is busy, dialing will not occur on the Line Interface Module line. Emergency dialing using an IP connection may not be supported due to ICP system configuration and country location. For more information, contact your System Administrator.

**To make an Emergency Call using the Line Interface Module line:**

1. Lift the handset.
2. Press the Line Interface Module key that you have programmed.
3. The set indicates IP FAIL: ANALOG CALL
4. Dial your Local Emergency Number.

**To make an Emergency Call using the Line Interface Module line, when the IP connection has failed:**

1. Lift the handset.
2. Press the Line Interface Module key that you have programmed.  
The set indicates IP FAIL: ANALOG CALL.
3. Dial your Local Emergency Number.

**EMERGENCY CALLS WHEN EMERGENCY CALL ROUTING PROGRAMMED**

**Note:** This procedure is in addition to the methods described above.

**To make an Emergency Call if Emergency Call Routing is programmed:**

1. Lift the handset.
2. Dial your Local Emergency Number (911 or equivalent).

For more information, refer to Using the Line Interface Module.

## Auto-Answer

**To enable or disable Auto-Answer:**

- Press the programmed **Auto-Answer** feature key.

**To enable or disable Auto-Answer on a 5324 IP Phone only:**

1. Press  (MENU).
2. Press the No softkey until "Auto Answer?" appears.
3. Do one of the following:
  - To enable Auto-Answer, press the **TurnOn** softkey.
  - To disable Auto-Answer, press the **TurnOff** softkey.

**To answer a call when you hear ringback:**



- Begin speaking. Your phone's Handsfree microphone and Handsfree speaker transmit and receive audio.

**To end a call, do one of the following:**

- On a 5324 IP Phone only, press the Hang up softkey.
- Press  (CANCEL).
- Wait for the caller to hang up.

## Phonebook

**To use Phonebook:**

1. Press  (MENU).
2. Press the Yes softkey when "Phonebook?" appears.
  - Enter the name of the desired party, as follows:
    - For each letter in the name, press the appropriate key on the keypad until the letter is shown in the display. For example, if the letter C is required, press the digit 2 three times.
    - Use the ← softkey to correct errors.
    - If the next letter in the name is on the same digit key as the previous letter, press the → softkey before proceeding.
    - If required, press → softkey to add a space between the first and last name.
3. Press the **Lookup** softkey.
  - If the "Phonebook Lookup – Default to User Location" option is enabled on the system for your phone, the search is limited to names that share your location; otherwise, the entire directory is searched.
  - If "Phonebook Lookup – Display User Location" option is enabled, after the phonebook search displays the matching name and directory number, the user's location is displayed. The display alternates between the name/number and the location every 2 seconds.
4. If no match exists, edit the original entry,  
OR  
If the Phonebook with Location" option is enabled, press Retry. ALL LOCATIONS? Is displayed. Press Yes to search the entire directory or press No to search for only names that share your location. Edit the name and press Lookup.
5. If more than one match is found, press the Next softkey.
6. Do one of the following:
  - To make the call, press the **Call** softkey.
  - To edit the entry, press the **Retry** softkey.
  - To exit, press  (MENU).

## Redial

### To redial the last number that you manually dialed:

1. Lift the handset (optional).
2. Press  (REDIAL).

## Redial – Saved Number

### To save the last number that you manually dialed:

- Lift the handset, and then dial the appropriate feature access code.

### To Redial a saved number:

- Lift the handset, and then dial appropriate the feature access code.





## Speed Call Keys

You may use Speed Call Keys to make a call or to send a string of digits during a call (press a Speed Call Key during a call to send a multi-digit password, for instance).

### To dial a stored Speed Call number:

1. Lift the handset.
2. Press a Speed Call key.

### To store a Speed Call number:

1. Press  (MENU).
2. Press # or the No softkey until "Personal Keys?" appears.
3. Press \* or the Yes softkey.
4. Press a personal key that isn't a line key.
5. Press \* or the Change softkey
6. On a 5324 IP Phone only, press the Yes softkey.
7. Do one of the following:
  - To enter a new number, dial the number (press  (HOLD) between digits to create a one-second pause during dialing; press  (HOLD) more than once to lengthen the pause.)
  - To enter a trunk flash, press  (TRANS/CONF). (See "Trunk Flash" for more information about the use of this feature.)
8. On a 5312 IP Phone only, press the personal key again.



9. Do one of the following:
  - To make the number private, press \* or the **Priv** softkey
  - To keep the number visible, press # or the **Save** softkey.
10. Press  (MENU).

## Speed Call – Personal

### To dial a stored personal Speed Call number:

1. Lift the handset.
2. Dial the appropriate feature access code.
3. Enter an index number between 00 and 09.

### To store a personal Speed Call number:

1. Lift the handset.
2. Dial the appropriate feature access code.
3. Enter an index number between 00 and 09.
4. Dial the number to be stored (press  (HOLD) between digits to create a one-second pause during dialing; press  (HOLD) more than once to lengthen the pause.)
5. Hang up.

## Handsfree Operation

### To use Handsfree to make a call:

1. If you want to use a Non-Prime Line, press a Line Appearance key. Note: Your administrator must program Line Appearances to your phone.
2. Dial the number.
3. Begin speaking when the called party answers. Your phone's Handsfree microphone and Handsfree speaker transmit and receive audio.

### To use Handsfree operation to answer calls:

1. Press the flashing line key.
2. Begin speaking. Your phone's Handsfree microphone and Handsfree speaker transmit and receive audio.

### To hang up while using Handsfree operation:

- Press  (SPEAKER).

**To turn Mute on during Handsfree operation:**

- Press  (MUTE). The Mute key light turns ON.

**To turn Mute off and return to conversation:**

- Press  (MUTE). The Mute key light turns OFF.

**To disable Handsfree operation:**

- Lift the handset.

**To return to Handsfree operation:**

1. Press  (SPEAKER).
2. Hang up the handset.

## Group Listen

With Group Listen you can carry on a conversation using the handset or headset while allowing others nearby to listen to the person at the far end over the handsfree speaker in your phone. While Group Listen is active, the handsfree microphone in your phone is turned off.

**To allow others in the room to listen to the far end of your call:**

- Press the programmed **Group Listen** feature key.

**To return to a private two-way call from Group Listen:**

- Press the programmed **Group Listen** feature key.

**To change a Group Listen call into a Handsfree call so that others in the room can join the conversation:**

1. Press  (SPEAKER).
2. Hang up the handset.
3. CALL HANDLING

## Hold

**To place a call on Hold:**

- Press  (HOLD).

**To retrieve a call from Hold:**

1. Lift the handset.
2. Press the flashing line key.

**To retrieve a call from Hold at another phone, do one of the following:**

- Press the flashing line key.
- Dial the appropriate feature access code and the number of the station that placed the call on Hold.

## Mute

Mute lets you temporarily turn your phone's handset, headset or handsfree microphone off during a call.

**To turn Mute on during a call:**

- Press  (MUTE). The  (MUTE) light turns ON.

**To turn Mute off and return to the conversation:**



- Press  (MUTE). The  (MUTE) light turns OFF.



**Note:** If you are on a Handsfree MUTED call and you lift the handset, the handset microphone is automatically enabled and the MUTE light turns OFF. **NOTE FOR USERS ON RESILIENT 3300 ICP SYSTEMS:** If your phone switches to the secondary system while your speaker or handset is muted (that is, while the Mute key is lit) the call remains muted until you hang up.

## Transfer

**To Transfer an active call:**

1. Press  (TRANS/CONF).
2. Dial the number of the third party.
3. Do one of the following:
  - To complete the Transfer, hang up.
  - To announce the Transfer, wait for an answer, consult, and hang up.
  - To cancel the Transfer, press  (CANCEL).





**To transfer an active call during headset operation:**

1. Press  (TRANS/CONF).
2. Dial the number of the third party.
3. To complete the Transfer, press the Release feature key.

## Conference

**To form a Conference when a two-party call is already in place, or to add another party to an existing Conference:**

1. Press  (TRANS/CONF).
2. Dial the number of the next party.
3. Wait for an answer.
4. Press  (TRANS/CONF).

**To leave a Conference:**

- Hang up or press  (CANCEL).

## Conference Split

**To Split a Conference and speak privately with the original party on a 5312 IP Phone (only):**

1. Press  (TRANS/CONF).
2. Dial the appropriate feature access code.

**To Split a Conference and speak privately with the original party on a 5324 IP Phone (only):**

- Press the **Split** softkey.

## Add Held (5324 IP Phone only)

**To move a call on hold to another line appearance:**

1. Press an available line key.
2. Press the AddHeld softkey.
3. Press the flashing line key.

**To add a call on Hold to an existing conversation or conference:**

1. Press the AddHeld softkey.
2. Press the flashing line key.

## Swap

**To call another party when you are in an established two-party call:**

1. Press  (TRANS/CONF).
2. Dial the number.

**To alternate between the two parties:**

- Press the **Swap/Trade** feature key or the **Trade** softkey.

## Call Forward

Call Forward lets you redirect incoming calls to an alternate number. You can select one of the following forwarding options:

- Always redirects all incoming calls regardless of the state of your telephone.
- B-Int redirects internal calls when your telephone is busy.
- B-Ext redirects external calls when your telephone is busy.
- NA-Int redirects internal calls after several rings if you don't answer.
- NA-Ext redirects external calls after several rings if you don't answer.



**Note:** For information about "I'm Here?", see Call Forward – Remote.

**To program Call Forward:**

1. Press  (MENU).
2. Press # or the No softkey until "Call Forwarding?" appears.
3. Press \* or the Yes softkey .
4. Press # or the Next softkey until the type of Call Forward that you want to set up appears (see above).
5. On a 5324 IP Phone only, press \* or the Review softkey.
6. If a number is already programmed, press \* or the Change softkey .
7. Press \* or the Program softkey .
8. Dial the destination number.  
If you make an error while dialing, press \* or the ← softkey to correct errors.



9. Press  (DOWN) or the Save softkey.

**To turn Call Forward on and off (once it has been programmed):**

1. Press  (MENU).
2. Press # or the No softkey until "Call Forwarding?" appears.
3. Press \* or the Yes softkey .
4. Press # or the Next softkey until the type of Call Forward appears. .
5. Do one of the following:
  - On a 5312 IP Phone, press \* (**Change**) and then press # (**TurnOff/TurnOn**)
  - On a 5324 IP Phone, press the **Review** softkey. Press the **Change** softkey.
  - To turn Call Forward on, press the **TurnOn** softkey, or, to turn Call Forward off, press the **TurnOff** softkey.

## Call Forward - Remote (I am Here)



**To forward calls from a remote station to your current location:**

1. Press  (MENU).
2. Press # or the **No** softkey until "Call Forwarding?" appears.
3. Press \* or the **Yes** softkey.
4. Press # or the **Next** softkey until "I Am Here" appears.
5. Press \* or the **Yes** softkey.
6. On a 5312 IP Phone only, if a number is already programmed, press \* twice.
7. Dial the extension of the remote station.  
If you make an error while dialing, use the # or the ← softkey to backspace and correct the number.
8. Press  (DOWN) or the **Save** softkey.

**To cancel Call Forward – Remote from the station that set the remote forwarding:**

1. Lift the handset.
2. Dial appropriate feature access code.
3. Dial the extension of the remote station.
4. Hang up.

**To cancel Call Forward – Remote from the station that was forwarded:**

1. Press  (MENU).
2. Press # or the No softkey until "Call Forwarding?" appears.
3. Press \* or the Yes softkey.
4. Press \* or the Review softkey.
5. Press \* or the Change softkey.
6. Press # or the TurnOff softkey.
7. Press  (MENU).

## Call Forward - End Chaining

**To ensure that calls do not get forwarded again by the destination number:**

1. Lift the handset.
2. Dial the appropriate feature access code.
3. Hang up.

**To again allow calls to be forwarded by the destination number:**

1. Lift the handset.
2. Dial appropriate feature access code.
3. Hang up.

## Call Forward - Forced (5324 IP Phone only)

**To force an incoming call to be forwarded:**

- Press the **Forward** softkey.

## Call Forward - Override

**To override Call Forward and ring a station:**

1. Lift the handset.
2. Dial appropriate feature access code.
3. Dial the extension number.

## Messaging - Advisory

Advisory Messaging enables you to select a notice that appears on your phone display to inform people visiting your desk of your whereabouts. Select from a variety of advisory messages, including "On vacation", "In a meeting", or "Out to Lunch".

### To turn Messaging - Advisory on:

1. Press  (MENU).
2. If necessary, press the # or the No softkey until "Advisory Msgs?" appears.
3. Press \* or the Yes softkey when "Advisory Msgs?" appears.
4. Press # or the Next softkey until the desired message appears.
5. Press \* or the TurnOn softkey.

### To turn Messaging - Advisory off:

1. Press  (MENU).
2. If necessary, press the # or the No softkey until "Advisory Msgs?" appears. .
3. Press \* or the Yes softkey when "Advisory Msgs?" appears.
4. Press \* or the TurnOff softkey .

## Messaging - Callback

### To leave a Callback Message when you hear busy or ringback tone:

- Press  (MESSAGE) or, on a 5324 IP Phone only, press the **Callback** softkey.

### To respond to a message waiting condition on your 5312 IP Phone:



1. Press  (MESSAGE).
2. If a password is required, dial your password.
3. Do one or all of the following:
  - To call the message sender, press #.
  - To erase the message, press \*.

### To respond to a message waiting condition on your 5324 IP Phone:

1. Press  (MESSAGE).
2. If a password is required, dial your password (and press the Enter softkey if available).

3. Press the Yes softkey, and do one or all of the following:
  - To display the time the message was sent, press the **More** softkey.
  - To display the number of the caller, press the **More** softkey twice.
  - To call the message sender, press the **Call** softkey.
  - To delete the message, press the **Erase** softkey.
  - To view the next message, press  (MESSAGE).

On a 5324 IP Phone only, you can set, change, or clear a password (up to 7 digits, not including 0):

1. Press  (MENU).
2. Press the No softkey until "Set Password?" appears.
3. Press the Yes softkey.
4. Do one of the following:
  - To enter a new password, enter your password.
  - To change or clear your password, enter your current password.
5. Press the Enter softkey.
6. When changing or clearing your password, do one of the following:
  - To change your password, enter your new password and press the **Enter** softkey.
  - To clear your password, enter 0.
7. Enter your new password again.
8. If you are setting up or changing a password, press the Enter softkey.
9. Press  (MENU).

## Messaging - Cancel Callback

### To cancel a Callback:

1. Lift the handset.
2. Dial appropriate feature access code.
3. Dial the number of the called station.
4. Hang up.

## Messaging - Cancel All Callbacks

**To cancel all Callbacks:**

1. Lift the handset.
2. Dial appropriate feature access code.
3. Hang up.



## USING OTHER FEATURES

### Account Codes

#### To use Forced Account Codes:

1. Lift the handset.
2. Dial the Account Code digits.
3. Press #.

#### To enter an Account Code during a call on a 5312 IP Phone:

1. Press  (TRANS/CONF).
2. Dial appropriate feature access code.
3. Dial the Account Code digits.
4. Press #.
5. Press  (CANCEL).

#### To enter an Account Code during a call on a 5324 IP Phone:

1. Press  (MENU).
2. Press the Yes softkey.
3. Dial the Account Code digits.
4. Press the Save softkey.
5. Do one of the following:
  - For a verified account code, press the **Yes** softkey.
  - For a non-verified account code, press the **No** softkey.

### Attendant Call Hold - Remote Retrieve

#### To retrieve a call placed on Hold by the attendant:

1. Lift the handset.
2. Dial appropriate feature access code.
3. Dial the digits announced by the attendant.



## Call Park

The Call Park feature allows you to place a call in a special hold state. You, or someone else, can then retrieve the call from any extension in the system. After parking the call, the system can automatically connect you to paging equipment so that you can announce the call to the requested party.

### To park an active call:

1. Do one of the following:
  - Press the **Call Park** feature key (must be programmed)
  - Press  (TRANS/CONF), and then dial \*7#. The display shows PARKED@, followed by the park destination and parking spot index (if applicable). Example: PARKED@ 1234 @ 02.
2. Dial the directory number on which to park the call (not required if the number is programmed to the Call Park feature key).
3. To inform a user that a parked call is waiting, do one of the following:
  - If automatic paging is enabled, announce the call and the park retrieve digits shown on the display.
  - If automatic paging is disabled, press the programmed **Page** key, or dial \*\*9, followed by the Paging zone number (if required). Then, announce the call and park retrieve digits shown on the display.



**Note:** Paging over a loudspeaker is not permitted in handsfree mode; you must use the handset or headset.

### To retrieve a parked call:

1. Do one of the following:
  - Dial the appropriate feature access code.
  - Press the **Call Park - Retrieve** feature key (must be programmed).
2. Dial the directory number on which the call is parked (not required if the number is programmed to the Call Park feature key).
3. If there are multiple calls parked on the number, dial the two-digit index number to retrieve a specific call, or # to retrieve the longest parked call.

## Call Pickup

### To answer a call that is ringing at another phone in your Pickup Group:

1. Lift the handset.
2. Press the Pickup feature key or the Pickup softkey.

**To answer a call that is ringing at a station not in your Pickup Group:**

1. Lift the handset.
2. Dial the appropriate feature access code.
3. Dial the number of the ringing station.

## Campon

**To Campon to a busy station:**

- Press the **Wait** feature key or the **Wait** softkey.

**To retrieve a call when you hear Campon tone:**

- Press the **Trade** feature key or the **Trade** softkey.

## Do Not Disturb

**To activate or deactivate Do Not Disturb:**

- Press the **Do Not Disturb** feature key.

**To activate Do Not Disturb from a remote station:**

1. Lift handset.
2. Dial the appropriate feature access code.
3. Dial the number of the station to which Do Not Disturb is to apply.
4. Hang up.

**To deactivate Do Not Disturb from a remote station:**

1. Lift handset.
2. Dial the appropriate feature access code.
3. Dial the number of the station with Do Not Disturb activated.
4. Hang up.

## Override

**To use Override when you encounter busy or Do Not Disturb tone:**

- Press the **Intrude** feature key.

## Paging

### To use Paging:

1. Lift handset.
2. Press the Pager feature key.
3. Dial the Paging zone number (if required).
4. Make the announcement.

## Direct Paging

Direct Paging allows you to page a party through the party's handsfree speaker. If the paged party has Off-Hook Voice Announce enabled, the page will be heard even when the party is on a handset or headset call. If the paged party has Handsfree Answerback enabled and turned on on the phone, your page automatically establishes a handsfree call with the paged party.

### To page a party:

1. Lift the handset.
2. Press the Direct Paging feature key or dial the appropriate feature access code.
3. Dial the extension number.
4. Speak to the dialed party after the tone.

How you answer a Direct Page depends on whether Handsfree Answerback is enabled and turned on at your phone. See one of the following procedures in this guide:

- Direct Paging — Handsfree Answerback Enabled
- Direct Paging — Handsfree Answerback Disabled

## Direct Paging - Handsfree Answerback Enabled



When you receive a Direct Page, Handsfree Answerback automatically establishes a Handsfree call on your phone after a single burst of tone. Your administrator enables or disables Handsfree Answerback on your phone. After your administrator enables Handsfree Answerback, you can choose to turn it on or off directly from your phone.

### To turn Handsfree Answerback on:

- When your phone is idle, press  (MUTE) once. The **MUTE** key light flashes to indicate that Handsfree Answerback is ON.
- When a Direct Page arrives, the **MUTE** key light turns OFF and a Handsfree call is automatically established.

**To turn Handsfree Answerback off:**

- Press the flashing  (MUTE) key once. The **MUTE** key light turns OFF.
- To respond to a Direct Page when Handsfree Answerback is OFF, see "Direct Page – Handsfree Answerback Disabled" elsewhere in this guide.

 **Note:** By default, Handsfree Answerback is turned OFF at your phone. If the  (MUTE) key is OFF when your set is idle, Handsfree Answerback is OFF.

**To answer a call using Handsfree Answerback:**

Phone state before Page arrives	To answer the Direct Page
Phone is idle and MUTE is flashing	<ol style="list-style-type: none"> <li>1. Check that MUTE is OFF.</li> <li>2. Listen for the paging party.</li> <li>3. Begin speaking.</li> <li>4. Lift the handset if you wish to switch from a Handsfree call to a handset call.</li> </ol>
You are on a handset or headset call, and MUTE is OFF	<ol style="list-style-type: none"> <li>1. Check that MUTE is flashing.</li> <li>2. Press <b>MUTE</b>. The light turns ON solid, and you are now speaking to the paging party and have muted your handset/headset call.</li> <li>3. Speak to the paging party. Press <b>MUTE</b> to alternate between handset/headset and handsfree calls.</li> </ol>
You are on a MUTED handset/headset call, OR, you are on a Handsfree call	The party paging you receives a busy tone. Handsfree Answerback does not interrupt your call.

**To end a Handsfree Answerback call:**

- Press either  (SPEAKER) or  (CANCEL).

 **Note :** When the Handsfree Direct Page call ends, the **MUTE** key light returns to the state it was in before the call was established.

## Direct Paging - Handsfree Answerback Disabled



Your administrator enables or disables Handsfree Answerback and you can also turn it on or off on your phone.

To turn Handsfree Answerback off, see *Direct Paging - Handsfree Answerback Enabled* in this guide. When Handsfree Answerback is disabled on your phone and you receive a Direct Page, the Direct Page is indicated by a single burst of tone.

**To answer Direct Page calls when Handsfree Answerback is disabled:**

Phone state before Page arrives:	To answer the Direct Page (indicated by single burst of tone):
Phone is idle and MUTE is OFF.	<ol style="list-style-type: none"> <li>1. Check that MUTE is ON solid.</li> <li>2. Lift the handset OR press <b>MUTE</b> key to answer in Handsfree mode. (The light turns OFF.)</li> <li>3. Begin speaking.</li> </ol>
You are on a handset call or headset call, and MUTE is OFF	<ol style="list-style-type: none"> <li>1. Check that MUTE is flashing.</li> <li>2. Press <b>MUTE</b>. The light turns ON solid and you are now speaking to the paging party and have MUTED your handset/headset call.</li> <li>3. Speak to the paging party. Press <b>MUTE</b> to alternate between handset and handsfree calls.</li> </ol>
You are on a MUTED handset/headset call, OR, you are on a Handsfree call	The party paging you receives a busy tone. Handsfree Answerback does not interrupt your call.

**To end a Direct Page call, do one of the following:**

- Hang up the handset to end a handset call.
- Press  (SPEAKER) to end a Handsfree call.
- Press  (CANCEL).



**Note:** When the Handsfree Direct Page call ends, the **MUTE** key light returns to the state it was in before the call was established.

## Direct Voice Call

Direct Voice Call feature allows you to establish a two-way handsfree call at another extension whether or not it has Handsfree Answerback or Auto-Answer turned on. Only extensions programmed by the system administrator to receive Direct Voice Calls can be called using this feature.

**To make a Direct Voice Call:**

1. Lift handset.
2. Dial \*93.
3. Dial the extension you want.
4. Speak to called party.



## Timed Reminder (5324 IP Phone only)

**To program a Reminder:**

1. Press  (MENU).

2. Press the No softkey until "Timed Reminder?" appears.
3. Press the Yes softkey.
4. Enter the time in 24-hour format.
5. Press the Save softkey.

**To view, change, and/or cancel a pending Reminder:**

1. Press  (MENU).
2. Press the No softkey until "Timed Reminder?" appears.
3. Press the Yes softkey.
4. Do one of the following:
  - To change the Reminder, press the **Change** softkey, enter the new time, and press the **Save** softkey.
  - To cancel the Reminder, press the **Clear** softkey.
  - To exit without canceling the Reminder, press  (MENU).

**To acknowledge a Reminder when your phone rings once:**

- Press the **Confirm** softkey.

## Headset Operation

**To enable Headset Operation:**

- Press the **Headset** feature key.

**To answer a call (when Auto Answer is disabled):**

- Press the flashing line key.

**To hang up:**

- Press  (CANCEL).

**To mute your headset microphone:**

- Press the  (MUTE) key. The light turns ON.

**To turn mute off and return to the conversation:**

- Press the  (MUTE) key. The light turns OFF.

## Headset Operation

### To enable or disable Headset Operation:

- Press the **Headset** feature key.

### To answer a call:

- Press flashing Line Appearance key.

### To mute the headset microphone:

- Press and hold the headset's feature control switch.

### To hang up:

- Press  (CANCEL)

### To disable Headset Operation:



- Press the **Headset** feature key.

## Music

### To turn Music on and off on a 5312 IP Phone when the phone is idle:

- Press the **Music** feature key.

### To turn Music on and off on a 5324 IP Phone when the phone is idle:

1. Press  (MENU).
2. Press the No softkey until "Music?" appears.
3. Do one of the following:
  - To turn the music on, press the **TurnOn** softkey.
  - To turn the music off, press the **TurnOff** softkey.
4. Press  (MENU).

## Group Paging / Meet Me Answer

Group Paging allows you to page a group of telephones through their built-in speakers. You can belong to as many as three paging groups with one group designated as your "prime" group. When you need to respond to a Group Page but don't know the identity or extension number of the paging party, use the Meet Me Answer feature. You have up to 15 minutes after receiving the page to use Meet Me Answer.

### **To make a Group Page:**

1. Lift the handset.
2. Press Direct Page or dial the appropriate feature access code.
3. Do one of the following:
  - To page your prime page group, press #.
  - To page a specific page group, dial the page group directory number.
4. Speak to the dialed party after the tone.

### **To respond to a Group Page by using Meet Me Answer:**

1. Lift handset.
2. Dial the appropriate feature access code.
3. Do one of the following:
  - To respond to a page from your prime page group, press #.
  - To respond to a page from a specific page group, dial the page group directory number.

## Phone Lock

Phone Lock prevents access to the features on a phone, with the following exceptions:

- unlocking the set via a user PIN
- Hot Desk Login and Logout support, and
- Emergency Call Notification support.

Phone Lock has no effect on incoming calls but restricts outgoing calls, with the following exceptions:

- calls to emergency trunk routes, and
- local operators.

Most keys on the device are disabled, except for the dial pad and volume keys. The following access and keys are disabled:

- Menu access
- Softkeys



- Feature access keys
- Feature access codes, and
- Account codes



**Note:** Softkeys will be displayed but disabled, except the hot desking softkeys will remain enabled. The Phone Lock, Hot Desk login, and Emergency Notification feature access keys will still be available. Menu will provide Emergency Notification, if it is pending.

Before locking a set, ensure that

- the set is in the idle state (there should not be any ongoing call)
- you do not have any calls on hold or on consultation-hold on any line appearance
- you are not in headset mode

**To activate Phone Lock:**

- Press the **Phone Lock** feature key or enter the Phone Lock Feature Access code.

**To de-activate Phone Lock:**

- Press the **Phone Lock** feature key or enter the Phone Unlock Feature Access code.
- Enter your user PIN to unlock the set.



**Note:** If a user PIN has not been assigned, enter # when prompted for the PIN to unlock the phone.

## User PIN (5324 IP Phone only)

A Personal Identification Number (PIN) allows a user to log into a set as a hot desk user or generic SIP user. It is also used to de-activate the Phone Lock feature. PINs must be from 0 to 8 digits in length. Only digits (0 to 9) are permitted. The default PIN is blank (length zero).

Users will have one generic PIN that can be used for any required features.

The User PIN initially has a zero length, allowing a user, for example, to unlock a phone using a blank PIN for Phone Lock. Setting the User PIN on the set requires the PIN to have at least one digit.

**To change the User PIN:**

1. Press  (MENU).
2. Press No until "Set User PIN?" appears.
3. Press Yes softkey or the User PIN softkey.
4. At the prompt "Enter Old PIN", enter your old User PIN.
5. Press Enter.

6. At the prompt "Enter new PIN", enter your new PIN.  
Use left arrow key to correct mistakes. The PIN can include digits from 0 to 9 only and can be from 0 to 8 characters in length.
7. Press Enter.
8. At the prompt to verify the PIN, re-enter your new PIN again. The set confirms successful or failed completion.
9. Press  (MENU) to end the Menu session.

## Trunk Flash

The Trunk Flash feature allows you to access Centrex features (if available) while you are talking on an outside call.

### To flash a trunk while talking on an outside call:

1. Press  (TRANS/CONF).
2. Dial the appropriate feature access code for a single flash or a double flash.
3. Wait for dial tone.
4. Dial the Centrex feature access code.

## Record a Call

This feature uses your voice mail system to record your telephone conversations. **Note:** You may be required by law to inform the other party that you are recording the conversation. For specific instructions, consult your system administrator.

### To start recording while on a 2-party call:

- Press the **Record Call** key. (See Feature Keys elsewhere in this guide for instructions on programming a **Record Call** key to your phone.)



**Note:** Your system may be programmed to automatically begin recording external calls when you or the other answers.

### To control recording on a 5312 IP Phone, do one or all of the following:

- To stop and save a recording, press the **Record Call** feature key.
- To stop and erase a recording, press  (CANCEL).

### To control recording on a 5324 IP Phone, do one or all of the following:

- To pause recording, press the **Pause** softkey.
- To resume recording after pausing, press the **Resume** softkey.
- To stop a recording without saving it, press the **Erase** softkey or  (CANCEL).

- To stop and save a recording, press the **Save** softkey.

Putting the call on hold saves the recording; taking the call off hold starts a new recording. Depending on system programming, hanging up, or pressing  (TRANS/CONF) or a DSS key, may also save the recording.

**To listen to a recording:**

1. Lift the handset.
2. Access your voice mailbox.
3. Follow the prompts to retrieve the recording.

## Hot Desking

Hot Desking allows you to log into the telephone system from any phone designated as a Hot Desk phone. Simply log in at the phone using your assigned Hot Desk User Extension Number and the phone immediately assumes all your speed dials, features keys, call forwarding setup, and line appearances – even your language preference for the display. Any changes you make to the phone while you are logged in—for example, adding a speed dial—are saved to your personal profile. Logging in activates your profile on any phone that supports Hot Desking.



**Note:** All Hot Desking profiles have 13 programmable keys. If you log into a phone that has a fewer number of keys, the extra ones are "hidden". Only the use of the extra keys is lost, not the features assigned to them.

**To log into a Hot Desking 5312 IP Phone (the phone must be idle):**

1. Dial the appropriate feature access code.
2. Press \*.
3. Enter your Hot Desk User Extension Number
4. Press \*.

**To log out of Hot Desking 5312 IP Phone (the phone must be idle):**

1. Dial the appropriate feature access code.
2. Press #.
3. Press the \*.

**To log into a Hot Desking 5324 IP Phone (the phone must be idle):**

1. Press the HotDesk softkey.
2. Press the Login softkey.
3. Enter your Hot Desk User Extension Number.
4. Press the Okay softkey.

**To log out of Hot Desking 5324 IP Phone (the phone must be idle):**

1. Press the HotDesk softkey.
2. Press the Logout softkey.
3. Press the Confirm softkey.



**Note:** Your profile can only be active on one phone at a time. If you log in from another phone without logging out from the first one, the system will automatically deactivate your profile on the first phone.

## Hot Desk Remote Logout

A user who has forgotten to log out of a Hot Desking phone can be logged out using any phone that supports Hot Desk Remote Logout.

**To remotely log out a Hot Desking phone:**

1. Dial the appropriate feature access code.
2. Dial the Hot Desk User Extension Number that you want to log out.

## Tag Call

Tag Call allows you to signal that you are the victim of a threatening or malicious call. Using the tag, your system administrator or telephone company can identify the source of the call and provide this information to appropriate personnel or authorities. **CAUTION:** Tagging a non-malicious call may result in fines or other penalties.

**To tag a malicious call:**





- Press the **Tag Call** feature key while the call is in progress. See "Feature Keys" elsewhere in this guide for information on programming a **Tag Call** feature key to your phone. –OR–
- Press  (TRANS/CONF) and dial the appropriate feature access code.

If the call was successfully tagged "Thank You" is shown on the display; otherwise, "Not Allowed" is displayed. **Note:** Tag Call can be used on active two-party calls only. Calls on hold and conference calls cannot be tagged.

## Call History

Call History keeps track of the names (if available) and telephone numbers of missed calls, answered incoming external calls, and outgoing external calls. Once enabled on your phone by your system administrator, it functions automatically.

**To display the call history and view call detail:**

1. Press the Call History feature key. The total number of missed calls is displayed in brackets (), the number of new missed calls is indicated with a \*.
2. To browse through the list of missed calls, press \* or the Yes softkey, followed by the  (UP) and  (DOWN) keys to scroll through the list.
3. To view answered or outgoing calls, press # or the No softkey (once for Answered, twice for Outgoing), followed by the  (UP) and  (DOWN) keys to scroll through the list.
4. To view the number of the call, press the # or Options softkey. When the Options screen is displayed, press the \* or Details softkey to display the number. Press the # or Next softkey to display the call time and date.

**To return a call:**

1. Display the call you want to return.
2. Do one of the following:
  - If the call is internal, and the caller name is known, press \* or the **Call** softkey. For unknown numbers, the **Call** option is not displayed.
  - If the call is external, and you normally need to precede external calls with a digit such as 9, it is likely that your system administrator has programmed your system to insert the 9 for you. In this case, pressing \* or the **Call** softkey initiates the call immediately. Sometimes the system will be unable to complete the dialing automatically. When this happens, you can edit the dialed digits manually by pressing # or the **← (Clear)** softkey. Use the # or **← (Clear)** softkey to delete the left-most digit, and then type the digits to insert them. When you have the dial string edited to suit your needs, press the \* or **Call** softkey to dial the number.

**To delete all missed, answered, or outgoing call logs:**

1. After selecting the type of logs you wish to delete, press # or the Delete All softkey.
2. Confirm that you do want to delete all items by pressing \* or the # softkey.

**To delete a particular call from the call log:**

- With the call log that you want to delete displayed, press # twice or press the **Delete** softkey.

## Night Answer



Office telephone systems are often placed into Night Answer after regular hours. Calls then ring alternate answer points—either designated extensions or a night bell. You can dial the Trunk Answer From Any Station (TAFAS) code to answer calls ringing the night bell. If permitted by system programming, you can put your phone into one of two night answer modes, Night1 or Night2.

**To switch your 5312 IP Phone to Night Answer or back to Day service:**

1. Lift the handset.
2. Press the Night Answer feature key. (See "Feature Key" for instructions on programming a feature key.)
3. Do one of the following:
  - Press **0** for Day Service.
  - Press **1** for Night1.
  - Press **2** for Night2.
4. Hang up.

The **Night Answer** feature key light flashes slowly for Night1, and rapidly for Night2. The **Night Answer** feature key light is off for when your phone is in Day service.

**To switch your 5324 IP Phone to Night Answer or Day service, or to view which service your 5324 IP Phone is currently in:**

1. Press  (MENU).
2. Press the No softkey until "Night Answer?" appears.
3. Press the Yes softkey
4. Do one of the following:
  - To exit without making any changes, press  (MENU).
  - To change the mode of service, press the **Change** softkey, followed by **No** until the desired alternative appears, and then press **Yes**.

## Release

Release lets you disconnect from an attempted Call Transfer or Conference Call without hanging up the handset. Release is useful when you encounter a busy or unavailable party.

**To release from an attempted transfer or conference call:**

- Press the **Release** feature key or the **Release** softkey.

## Mobile Extension

Mitel Mobile Extension is a software solution that enables you to twin your desk phone with an external PSTN-connected phone (your cell phone, for example). Calls arriving at the desk phone ring the cell phone simultaneously, until one or the other is answered, or if unanswered, are forwarded to voice mail. For information about configuring Mobile Extension on your Mitel IP device, refer to the Mobile Extension Quick Reference Guide available at [www.mitel.com](http://www.mitel.com) or contact your Administrator.

## Group Presence

Group Presence allows members of call groups ( Hunt, ACD, Ring, and Personal Ring) to make themselves absent or present in a group. Only members who are present in a group are offered calls to that group.

If you are in a Personal Ring group (see Handoff – Personal Ring Groups), Group Presence lets you choose which device in the group you want to use to receive calls by making it 'Present' and the others 'Absent.'

You can also change the presence status of other users if allowed by your system administrator.

Users belonging to multiple groups can control their presence in each group separately through the use of feature keys (one for each group), or by dialing a feature access code (FAC) followed by the group number.

### To join a group:

1. Lift the handset.
2. Do one of the following:
  - Press the **Group Presence** feature key to join the group associated with the key.
  - Dial the Group Presence - Join Group feature access code followed by the group directory number.

The LED associated with the key is steady lit when the member is present and off when absent.

### To leave a group:

1. Lift the handset.
2. Do one of the following:
  - Press the **Group Presence** feature key to join the group associated with the key.
  - Dial the Group Presence - Leave Group feature access code followed by the group directory number.

The LED associated with the key is steady lit when the member is present and off when absent.

### To change another group member's presence status:

1. Lift the handset.
2. Dial the Group Presence - Join Group Third Party or Group Presence - Leave Group Third Party .
3. Dial the directory number of the group member.
4. Dial the group directory number.

**To change the presence status of another Personal Ring Group member using a feature key:**

- Press the **Personal Ring Group Presence** feature key.

The LED associated with the key is steady lit when the member is present and off when absent.

## Handoff - Personal Ring Groups

Personal Ring Groups (PRGs) associate two or more of your devices, such as your office phone and cell phone, with a single user Directory Number (DN). PRGs are set up by the system administrator. Group member devices ring simultaneously when called.

You can use the group Handoff feature to “Push” or “Pull” calls between group member devices. A Push passes the call to the group, where it can be answered by any other present group device. A Pull takes an in-progress call away from another member.

**To use Handoff to Push an in-progress call to the PRG:**

- Press the Handoff key.

**To Pull an in-progress call from another member of the PRG:**

- Lift the handset (optional if the device supports hands free operation).
- Press the Handoff key.



## USING YOUR 5324 IP PHONE WITH THE 5310 IP CONFERENCE UNIT

The 5324 IP Phone supports the 5310 Conference Unit. Your phone may use the 5310 IP Conference Unit for conferencing. An optional mouse connected directly to the conference unit is used to control the conference unit on or off, to adjust the volume, mute the conference call, or to put the conference unit into Presentation mode.

If a mouse is not installed, the conference unit acts as the phone's speaker for all operations, except ringing. For example, when the **SPEAKER** key  is pressed during a headset or handset call, the audio path is directed to the Conference Unit.

The 5324 IP Phone will activate the 5310 Conference Saucer when it detects that the Conference Module has been installed in the back of the phone.



### Using the 5310 Conference Unit with a Mouse

Use the procedures below if your 5310 Conference Unit has a mouse attached.

#### Turn the Conference Unit On and Off

1. Verify that the conference unit is connected to your phone.
2. Press the Power (On) key on the mouse to turn the unit on.
3. Press the Power key again to turn the conference unit off.

### Adjust the Conference Unit Volume

- Press **Volume Up** or **Volume Down** key on the mouse.

### Place the Conference Unit in Presentation mode

Presentation Mode is used when only one individual is speaking to a group. If another member in the group wishes to speak, you must disable Presentation Mode. Presentation Mode minimizes extraneous noise.

#### To place the conference unit in Presentation mode

- Press **Presentation Mode** key on the mouse.

### Mute the Conference Unit

**To mute the conference unit so that conversation in the meeting room cannot be heard by individuals being conferenced:**

- Press the **Mute** button on the mouse or  (MUTE) on the phone.

### Exit the Conference

- Press **Power** key on the mouse.

## Using the 5310 Conference Unit without a Mouse

Use the procedures below if you 5310 Conference Unit does not have a mouse attached. The 5324 IP Phone will activate the 5310 Conference Saucer when it detects that the Conference Module has been installed in the back of the phone.

### Start a Conference

- Press **SPEAKER** key  or just start dialing.

### Adjust the Conference Unit Volume

- Press **Volume Up** or **Volume Down**.

### Mute the Conference Unit

To mute the conference unit so that conversation in the meeting room cannot be heard by individuals being conferenced:

- Press  (MUTE) on the phone.

### Exit the Conference

- Hang up.

## USING THE LINE INTERFACE MODULE (5324 IP PHONE ONLY)

5324 IP Phones support the Mitel Line Interface Module. The Line Interface Module allows you to make and receive calls over an analog line (referred to as the Line Interface Module line) connected to your phone, and operates in either of the following two modes (as determined by your System Administrator):

- Line Interface Module mode: your phone allows you to use the Line Interface Module line at any time.
- Failover Mode: you can use the Line Interface Module line only when the IP connection has failed.



**Note:** Handsfree and on-hook dialing are not supported on the Line Interface Module line.

### Line Interface Module Mode

#### Make a Call

**To make a call using the Line Interface Module line:**

1. Lift the handset.
2. Press the Line Interface Module key. ANALOG CALL appears on the display.
3. Dial the number to make the call.



**Notes:**

- When making external calls over the Line Interface Module line, a prefix (e.g. 9) is not required.
- If your phone's **Line Interface Module** key has the Privacy option enabled and another phone is on a call using the Line Interface Module line (that is, the **Line Interface Module** key is solid orange), you cannot access the Line Interface Module line. The user of the other phone must first hang up before you can access the Line Interface Module line.
- To determine whether the Privacy option is enabled, contact your System Administrator.

#### Answer a Call

**To answer a call using the Line Interface Module line:**

1. Lift the handset.
2. Press the flashing **Line Interface Module** key. ANALOG CALL appears on the display.

## Answer a Waiting Call on the Line Interface Module Line

If you have subscribed to an analog call waiting service, you may use the hookswitch or press  (CANCEL) to answer a waiting Line Interface Module call. When you are on a Line Interface Module call and a waiting Line Interface Module call arrives, you will hear a beep.



**Note:** This feature may not be supported in all regions.

**To answer a waiting Line Interface Module call, or to return to the original Line Interface Module call, do one of the following:**

- Press and release the hookswitch.
- Press  (CANCEL).
- Press the **Line Interface Module** key.

## Hold a Call

**To put a current call on hold to answer an incoming Line Interface Module call:**

- Press the flashing **Line Interface Module** key. The current call is put on hold.

To switch between the current call and the held call when one of the calls is using the Line Interface Module line, do one of the following:

- If your current call is using the Line Interface Module line, press the flashing Line key of the held call. The Line Interface Module call is automatically put on hold.
- If your current call is using an IP line, press the flashing **Line Interface Module** key. The IP line is automatically put on hold.

## End a Call

**To end a current call when an incoming Line Interface Module call arrives:**

- Press  (CANCEL), and then press the flashing **Line Interface Module** key. The current call ends, and you are connected to the caller on the Line Interface Module line.

To end the current Line Interface Module call when an incoming call arrives:

- Press  (CANCEL). The current Line Interface Module call ends, and you are connected to the new caller.

## Failover Mode

### Make a Call

**To make a call using the Line Interface Module line during an IP connection failure:**

1. Lift the handset. IP FAIL: ANALOG CALL appears on the display.
2. Dial the number to make the call.

## Answer a Call

### To answer a call using the Line Interface Module line during an IP connection failure:

- Lift the handset. IP FAIL: ANALOG CALL appears on the display, and the call is answered.

## Emergency Calls

**WARNING FOR EMERGENCY NUMBER DIALING:** Consult your local authorities for Emergency Numbers and 911 or equivalent service availability in your area. Emergency Number dialing should only be performed by picking up the handset and selecting the **Line Interface Module** key. If Privacy Mode is enabled and the **Line Interface Module** key local line is busy, dialing will not occur on the Line Interface Module line. Emergency dialing using an IP connection may not be supported due to ICP system configuration and country location. For more information, contact your System Administrator. You can make an Emergency Call to your Local Emergency Service using the Line Interface Module line when the IP connection has failed.

### To make an Emergency Call using the Line Interface Module line:

1. Lift the handset.
2. Press the Line Interface Module key.
3. Dial your Local Emergency Number. ANALOG CALL appears on the display.

## USING THE MITEL IP PROGRAMMABLE KEY MODULES (5324 IP PHONE ONLY)

IP Programmable Key Modules (PKM) add programmable keys to the 5324 IP phones. An IP PKM Interface Module installs in the back of the 5324 IP Phone to allow the 12 or 48-button IP PKM to connect to the IP phone without using an additional LAN port.

PKM keys can be programmed as feature keys, speed call keys, Direct Station Select keys, or line appearance keys. Each key has a Line Status Indicator that works the same way as those on the associated telephone. The keys can be programmed through the telephone.



**Note:** Up to two 48-button PKMs can be attached for 96 additional keys.

## FEATURE ACCESS CODES

FEATURE ACCESS CODES	
Account Code	*43
Attendant Call Hold - Remote Retrieve	*23
Call Forwarding - Busy (Ext. & Int. Source)	**70
Call Forwarding - Busy (Ext. Source)	62
Call Forwarding - Busy (Int. Source)	63
Call Forwarding - End Chaining	64
Call Forwarding - Follow Me	*8
Call Forwarding - Follow Me - Third Party	**7
Call Forwarding - I Am Here	**8
Call Forwarding - No Answer (Ext. & Int. Source)	**71
Call Forwarding - No Answer (Ext. Source)	66
Call Forwarding - No Answer (Int. Source)	65
Call Forwarding - Override	*1*
Call Hold	*7
Call Hold - Remote Retrieve	**1
Call Hold - Retrieve	*1
Call Park	*7#
Call Park - Retrieve	*8#
Call Pickup - Dialed	*6
Call Pickup - Directed	**6
Call Privacy	#3
Callback - Cancel	#1
Callback - Cancel Individual	*1#
Callback - Setup	1
Camp on - Retrieve	*3
Camp on - Setup	3
Cancel All Forwarding	##8
Cancel Call Forwarding - Busy (Ext. & Int. Source)	**72
Cancel Call Forwarding - End Chaining	**73
Cancel Call Forwarding - No Answer (Ext. & Int. Source)	**74
Cancel Call Forwarding Follow Me	#8
Cancel Call Forwarding Follow Me - Remote	**77
Cancel Call Forwarding Follow Me - Third Party	**10
Clear All Features	*##

FEATURE ACCESS CODES	
Conference Call	*4
Conference Call Split	*41
Default Voice mail Passcode	999
Direct Page	*37
Direct Voice Call - Initiate	*93
Do Not Disturb	*5
Do Not Disturb - Cancel	#5
Do Not Disturb - Cancel Remote	##5
Do Not Disturb - Remote	**5
Flexible Answer Point	57
Flexible Answer Point Cancel All	*59
Group Presence - Join Group	*60
Group Presence - Leave Group	*61
Group Presence - Join Group Third Party	*62
Group Presence - Leave Group Third Party	*63
Hot Desking Login	222
Hot Desking Logout	333
Last Number Redial	*01
Loudspeaker Paging	**9
Meet Me Answer	*88
Message Center	555
Message Waiting - Activate	*90
Message Waiting - Deactivate	*91
Message Waiting - Inquire	*92
Non-verified Account Code	**4
Override <single digit only>	2
Personal Speed Call - Upper Range Index Number	09
Personal Speedcall - Invoke	*58
Personal Speedcall - Remove	**78
Personal Speedcall - Store	*67
Remote Clear All Features	55
Remote Hot Desking Logout	111
Repeat Last Number Saved	*6*
Save Last Number	**79
Tag Call	*55
Tone Demonstration	83



FEATURE ACCESS CODES	
Trunk Answer From Any Station (TAFAS)	*9
Trunk Double Flash	*56
Trunk Single Flash	*57



Global Headquarters	U.S.	EMEA	CALA	Asia Pacific
Tel: +1(613) 592-2122 Fax: +1(613) 592-4784	Tel: +1(480) 961-9000 Fax: +1(480) 961-1370	Tel: +44(0)1291-430000 Fax: +44(0)1291-430400	Tel: +1(613) 592-2122 Fax: +1(613) 592-7825	Tel: +852 2508 9780 Fax: +852 2508 9232

For more information on our worldwide office locations, visit our website at [www.mitel.com/offices](http://www.mitel.com/offices)

THIS DOCUMENT IS PROVIDED TO YOU FOR INFORMATIONAL PURPOSES ONLY. The information furnished in this document, believed by Mitel to be accurate as of the date of its publication, is subject to change without notice. Mitel assumes no responsibility for any errors or omissions in this document and shall have no obligation to you as a result of having made this document available to you or based upon the information it contains.

M MITEL (design) is a registered trademark of Mitel Networks Corporation. All other products and services are the registered trademarks of their respective holders.  
© Copyright 2008, Mitel Networks Corporation. All Rights Reserved.

[www.mitel.com](http://www.mitel.com)

