



# MiVOICE BUSINESS AND 5000 COMMUNICATIONS PLATFORMS

**IP-DECT SYSTEM (GLOBAL)  
MITEL 5603 WIRELESS HANDSET USER GUIDE**



## **NOTICE**

The information contained in this document is believed to be accurate in all respects but is not warranted by Mitel Networks™ Corporation (MITEL®). The information is subject to change without notice and should not be construed in any way as a commitment by Mitel or any of its affiliates or subsidiaries. Mitel and its affiliates and subsidiaries assume no responsibility for any errors or omissions in this document. Revisions of this document or new editions of it may be issued to incorporate such changes.

No part of this document can be reproduced or transmitted in any form or by any means - electronic or mechanical - for any purpose without written permission from Mitel Networks Corporation.

## **Trademarks**

Mitel is registered trademark of Mitel Networks Corporation.

Other product names mentioned in this document may be trademarks of their respective companies and are hereby acknowledged.

IP-DECT System (Global)  
Mitel 5603 Wireless Handset User Guide  
Release 7.0  
June 2014

®,™ Trademark of Mitel Networks Corporation  
© Copyright 2014, Mitel Networks Corporation  
All rights reserved

About Your Phone	1
Description of Your Handset	2
Features and Functions	3
Chargers	4
Contacting Emergency Services	4
Tips for your Comfort and Safety	5
Frequency Range	5
Exposure to Radio Frequency Signals	5
Environmental Requirements	6
Chemical Resistance	6
Icons and Text in the Display	7
Keys and Buttons	9
Off-hook Key	9
On-hook, and On/Off Key	9
Navigation Key	9
Sound off Key	9
Key Lock, and Upper/Lower Case Key	9
Soft Keys	10
Volume Button	10
Alphanumeric Keys	10
Headset	11
Customizing Your Phone	12
Switch the Handset On/Off	12
Turn the Audible Signal On/Off	12
Lock/Unlock the Keypad	12
Lock/Unlock the Keypad in Idle Mode	12
Lock/Unlock the Keypad during a Call	13
Lock/Unlock the Handset	13
Making and Answering Calls	14
Make a Call	14
Pre-Dial	14
Dial a Number from the Call list	14
Dial a Number from the Contacts	14
Dial a Number from the Local Phonebook	14
Dial a Name from the Central Phonebook	15
Dial a Number from the Company Phonebook	15
Answer a Call	15
Answer a Call	16
End a Call	16

- During a Call .....16
  - Adjust the Volume during a Call .....16
  - Open Contacts during the Call .....16
  - Turn the Microphone on/off during a Call .....16
  - Start a New Call during Conversation .....17
- Call Handling for MiVoice Business ..... 18
  - Hold .....19
  - Transfer .....19
  - Conference .....20
  - Answer Call Waiting .....20
  - Callback .....21
  - Call Park .....21
- Advanced Features for MiVoice Business ..... 22
  - Call Forward .....22
  - Call Pickup .....22
  - Do Not Disturb .....23
  - Direct Page .....23
  - Group Page .....23
  - Loudspeaker Page .....23
- Call Handling for the Mitel 5000 CP ..... 24
  - Hold .....25
  - Transfer .....25
  - Conference .....26
  - Answer Call Waiting .....26
- Advanced Features for the 5000 CP ..... 27
  - Call Operator .....27
  - Config Assistant .....28
  - Reverse Transfer .....28
- Voice Mail ..... 29
  - Receive a Voice Mail .....29
  - Check the Voice Mail Inbox .....29
- Contacts ..... 30
- Navigate the Menu ..... 31
  - Enter/Exit the Menu Mode .....31

Menu Tree .....	32
Calls .....	32
Contacts .....	33
Settings .....	34
In Call .....	35
Call Menu .....	36
Call List .....	36
Missed Calls .....	37
Call Time .....	37
Contact Menu .....	37
Call Contact .....	37
Edit Contact .....	38
Delete Contact .....	39
Central Phonebook .....	39
Settings Menu .....	40
Sound and Alert Settings .....	40
Select Headset Profile .....	41
Display Settings .....	41
Screen Saver .....	41
Time & Date Settings .....	41
Phone Lock Settings .....	42
Answering .....	43
Change the Menu Language .....	44
Change Owner ID .....	44
In Charger .....	44
System .....	45
Advanced Functions .....	48
Admin Menu .....	48
Clear Lists in Charger .....	48
System Handling .....	49
Software Upgrade and Additional Features .....	49
Handset Updates via Charging Rack .....	49
Troubleshooting .....	51
Operation Notice .....	53
Accessibility and Voice Quality .....	53
Maintenance .....	54
Maintenance of Batteries .....	54

Battery Warnings .....54  
Charge the Battery .....54  
Replace the Battery .....54  
Attach the Hinge-type Clip .....55  
Attach the Swivel-type Clip .....56  
Easy Replacement .....56  
    Before Starting Easy Replacement Procedure .....57  
    Easy Replacement Procedure .....57  
Related Documents .....59  
Index ..... 61

## About Your Phone



**Note:** Mitel® Communications Director (MCD) product name has been changed to MiVoice Business for release 7.0 and up.

This guide contains feature descriptions for both the Mitel5000 Communication Platform (CP) and MiVoice Business.

- [Call Handling for MiVoice Business](#) on page 18
- [Advanced Features for MiVoice Business](#) on page 22
- [Call Handling for the Mitel 5000 CP](#) on page 24
- [Advanced Features for the 5000 CP](#) on page 27

The Mitel 5603 Wireless Handset is a feature-rich handset designed to operate in conjunction with an IP-DECT base station and the 3300 ICP. It is ideal for users who need mobile voice and messaging functions.

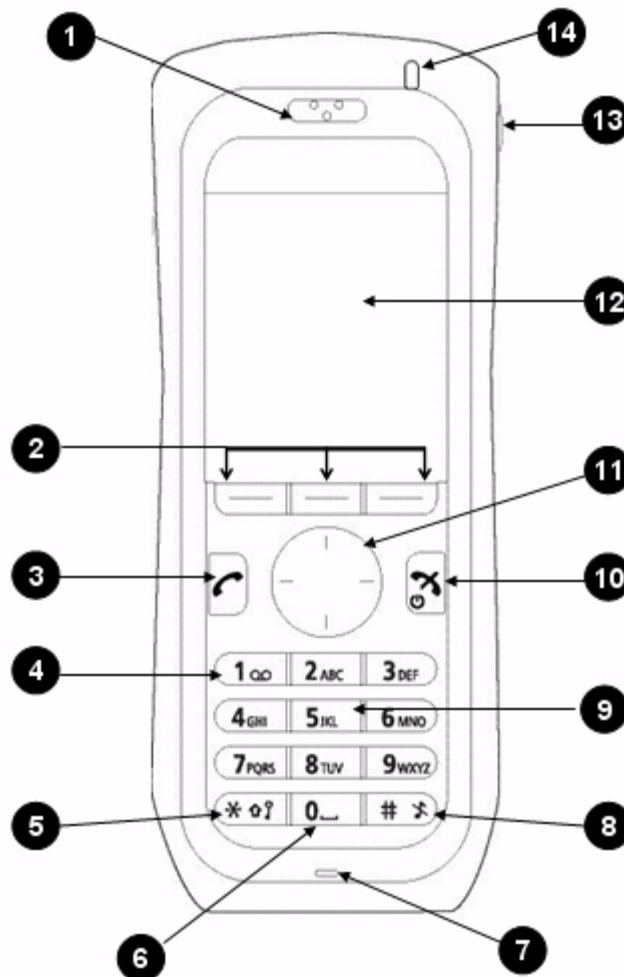

Figure 1: 5603 Handset



**Caution:** The handset/headset must be fully charged before starting regular use.

## Description of Your Handset

1	<b>Earpiece speaker</b>
2	<b>Soft keys</b> The three soft keys is used with GUI, that is, the functions of each Soft key is indicated by text in the display just above the keys.
3	<b>Off-hook key</b> To answer a call, to pre-dial a number, and as a short cut to the Call list.
4	<b>Voice mail access*</b> A quick access to the handset's Voice mail.
5	<b>Key lock and Upper/Lower case</b> Combined key lock and Upper/Lower Case.
6	<b>Space</b> To add space between text.
7	<b>Microphone</b>
8	<b>Sound off key</b> To turn on/off audible signals in idle mode, silencing the ring signal at incoming call, and to turn the microphone on/off during a call. <b>Note:</b> Incoming high priority messages will be indicated with a beep even when the handset is muted
9	<b>Tactile indicators</b> There are two tactile indicators to indicate the centre of the key pad.
10	<b>On-hook and On/Off key</b> Combined button; to end a call, to return to standby mode, and to switch the handset on/off by long press.
11	<b>Four-way navigation key</b> Navigation key with Left, Right, Up, and Down. During a call, the keys Up and Down are used to increase and decrease the speaker volume, respectively.
12	<b>Display</b> The B/W display is 28 mm wide and 35 mm high with backlighting.
13	<b>Headset connector</b> The headset connector is for connecting a headset. The connector is protected against dust by using the headset connector cover.
14	<b>LED</b> Indicates incoming call, messaging, low battery, and charging.

\*System dependent feature



## Features and Functions

---

**IMPORTANT:**The handset may retain small magnetic objects around the mouth cap or ear cap region.

---

### *Case*

The plastic cover parts are made of durable PC/ABS material.

### *Antenna*

The antenna is integrated inside the handset.

### *Loudspeaker*

The handset has a separate loudspeaker for the Loudspeaking function. It is located on the back side of the handset.

### *Microphone*

The microphone is placed on the front bottom side of the handset.

### *Clip*

There are two different belt clip options for the handset: a hinge-type clip (standard), and a swivel-type clip. You use the clip to attach the handset to a pocket or belt. You can use the handset without a clip on. See [Attach the Hinge-type Clip](#) on page 55, or [Attach the Swivel-type Clip](#) on page 56.

### *Battery*

The battery is a rechargeable Li-Ion battery, placed under a battery cover. See [Replace the Battery](#) on page 54.

The battery is fully charged within four hours. See [Charge the Battery](#) on page 54.

## Chargers

### Desktop Charger

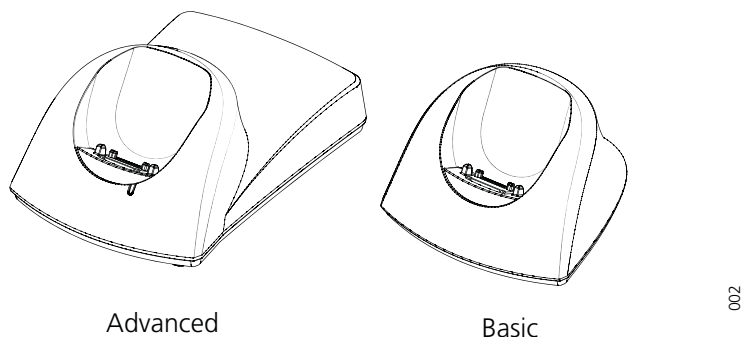

**Figure 2: Desktop Chargers**

There are two desktop chargers available: a basic one that will only charge the handset, and one with advanced functionality to download new software and to synchronize options. The handset is fully operational while placed in the charger.

The charger is delivered with a plug-in power supply and is connected into an ordinary wall socket. For more information. See the *5603/5604/5607 Programmer Installation and Maintenance Guide*.



**Note:** Only use the charger within the temperature range of +5° C – +40° C.



**Caution:** Only use the provided power supply. See the *5603/5604 Programmer Installation and Operation Guide*.

---

### Rack Charger

The Charging Rack charges six 5603/5604/5607/5624 handsets simultaneously and is used for charging only.

For more information, see the *5603/5604/5607/5624 Rack Charger Installation and Operation Guide*.

## Contacting Emergency Services

If configured in the PDM/Device Manager, any one of up to five predefined emergency numbers can be called, even if the handset or keypad has been locked. For additional information, see sections [Phone Lock Settings](#) on page 42.

This handset, like any wireless phone, communicates using radio signals. As with any wireless phone, you may not be able to establish a connection under all conditions; therefore, you should not rely solely on a wireless telephone for essential, emergency communication. The key lock

feature disables the handset keypad and prevents the accidental dialing of numbers that may result in nuisance calls. It also prevents accidental calls to emergency services numbers like 911, 999, or 112.

To disable the key lock feature, press the \* key and then press **Select**.

Currently, mobile IP phones do not support Enhanced 911 (E911) operation. If emergency services are required, it is necessary to keep the system administrator and location database up-to-date.

## Tips for your Comfort and Safety

### *Don't cradle the handset!*

Prolonged use of the handset can lead to neck, shoulder, or back discomfort, especially if you cradle the handset between your ear and shoulder. If you use your phone a lot, you may find it more comfortable to use a headset. See the section on headset use for more information.

### *Protect your hearing*

Your phone has a control for adjusting the volume of the handset receiver or headset. Because continuous exposure to loud sounds can contribute to hearing loss, keep the volume at a moderate level.

## Frequency Range

The handset is a radio transmitter and receiver. When it is on, it receives and sends out radio frequency (RF) energy. The handset operates on different frequency ranges depending on market and employs commonly used modulation techniques:

EU	1880-1900 MHz
USA/CAN	1920-1930 MHz
LA	1910-1930 MHz
BR	1910-1920 MHz
--	1900-1920 MHz

## Exposure to Radio Frequency Signals

This equipment complies with FCC radiation exposure limits set forth for an uncontrolled environment. This device complies with FCC SAR limit of 1.6 W/kg. The maximum SAR value measured when used at the ear, and when worn on the body using belt clip is as follows:

	SAR values
Head	0.043 W/Kg
Body worn	0.037 W/Kg

This device must not be co-located or operating in conjunction with any other antenna or transmitter.

Use of non-Mitel approved accessories may violate the FCC RF exposure guidelines and should be avoided.

### Environmental Requirements

- Only use the handset in temperatures between 0° C to +40° C (32° F to 104° F).
- Avoid exposing the handset for direct sunlight or close to other heat sources.
- Avoid volume levels that may be harmful to your hearing. Exposure to excessive sound pressure from a handset's earpiece or headset may cause permanently hearing loss.
- Do not expose the handset to open flame.
- Keep the handset away from excessive heat and moisture.
- Avoid sudden temperature changes to prevent condensation in the handset. It is recommended to put the handset into an air tight plastic bag until the temperature is adjusted, for example, when entering or leaving a cold/heated building on a warm/cold day.
- Protect your handset from aggressive liquids and vapors.
- The handset may retain small metal objects around the mouth cap or ear cap region.
- Keep the handset away from strong electromagnetic fields.
- Do not place a cold handset in a charger.

### Chemical Resistance

The alpha and numeric characters printed on the exterior of the handset have been tested and found resistant to chipping, fading or wearing off when the handset is treated with common cleaners and disinfectants or perspiration. The following chemicals have shown no harmful effect:

- 3% Hydrochloric Acid
- M-alcohol (70% Methylated Ethanol)
- 60% Chlorhexidin 0.5mg/ml

Acetone can be damaging to the plastic casing of the handset and should not be used.

## Icons and Text in the Display

All functions and settings available to the user are shown as icons and text in the display. The icons and text in the display indicate functions and settings to which you have access. The display normally displays date and time, the Owner ID and handset number. The Owner ID can manually be set by the user.

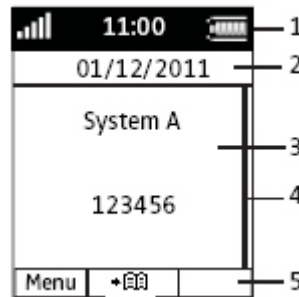

**Figure 3: Display Configuration in Standby Mode**

The Status bar (1) is used for icons which give the user information about signal strength, missed calls, new messages, phone lock, key lock, sound off, time and battery status. This row is always visible in all screens.



The Header bar (2) displays the current date, headset connection, and system connection.

















The Active area (3) is used for information such as the name of the system to which the handset is connected. A user identity provided from the system and/or an Owner ID can also be displayed if configured in the Settings menu. This is also the area for window text, for example "missed calls", or to confirm an action.



The Scroll bar (4) is placed to the right of the "Active area". It becomes visible when a menu screen has more than six menus, or if the complete text in a message cannot be displayed on the screen simultaneously.

The Soft key bar (5) is used for Soft keys that are located just beneath the display. The middle Soft key is configured to access the Contact list by default, but can be configured to access the Central Phonebook or the Contacts menu instead. The Soft key is configured in the handset using PDM/Device Manager. See the *Mitel 5603 Wireless Handset Configuration Guide*.

### Icons

	<p>"Signal strength" icon is visible in the upper left corner. The staples shown in display depends on the signal strength.</p>
	<p>"Full battery" icon appears in upper right corner.</p>
	<p>The "Low battery" icon appears when the battery has 10% or less remaining capacity left. In addition; a warning signal sounds every minute, the LED flashing orange, and the window "Battery low. Charge now!" appears.</p>

	The "Empty battery" icon is flashing when the battery has 5% or less remaining capacity left. In addition; a warning signal sounds every second, the LED flashing red, and the window "Battery empty. Shutting down." appears.
	"Sound off" icon appears when the Sound off key is pressed, and the handset (with the in-charger function "Sound off" enabled) is placed in a charger.
	"The Volume 0 ("Silent") icon is displayed when the volume has been set to "Silent".
	"Microphone off" icon indicates a silenced microphone. It appears after a long press on the Sound off key during a call.
	"Loudspeaking" icon appears in the soft key bar during a call. Pressing this icon will turn on the loudspeaker.
	"Loudspeaking off" icon appears after the soft key for Loudspeaking icon has been pressed. Pressing this icon will turn off the loudspeaker.
	"Key lock" icon indicates a locked keypad.
	"Locked entry" icon indicates that the contact cannot be edited or deleted by the user.
	"Phone lock" icon indicates a locked handset.
	"Headset" icon indicates that a corded headset is connected to the handset.
	"Outgoing call" icon is added to all outgoing calls in the call list.
	"Incoming call" icon is added to all answered calls in the call list.
	"Missed call" icon is added to all missed calls in the call list.
	"Missed call" icon is added in the status bar. This icon remains until the "Call list" is opened.
	"PDM/Device Manager communication" icon is visible when handset is communicating with PDM/Device Manager via advanced charger.
	"Voice mail" icon indicates that new voice mail has been received.
<b>Menu icons</b>	
	The "Contacts" menu contains all names/numbers in the local phonebook. In addition, a company phonebook with up to 500 entries can be downloaded to the phone via the PDM. you can to access a central phonebook* from the "Contact" menu.

	<p>The "Calls" menu contains call lists, call time, and call services*. Call services is configured in the PDM.</p>
	<p>The "Settings" menu contains personal handset settings such as changing the ringer volume, selecting language, etc.</p>

\* This feature is system dependent.

## Keys and Buttons

Some keys have different functions depending on the phone state or the length of time that you press a key.

**Short press** = Press and release the key in less than one second.

**Long press** = Press and hold down the key for longer than one second and then release.

### Off-hook Key

	<p>This key is used to answer calls, to pre-dial numbers and as a short cut to the Call list. One short press in standby mode opens the call list.</p>
--	--

### On-hook, and On/Off Key

	<p>This key is used to disconnect calls and return to the main screen. A long press in standby mode switches the handset on/off.</p>
---	--

### Navigation Key

	<p>Use this key to step in the menu, and when working in text mode. ◀, ▶, ▲, and ▼ are used for stepping left/right and up/down in the menu.</p>
---	--

### Sound off Key

	<p>A long press on the Sound off Key in idle mode toggles between ring signal on/off. When you receive an incoming call, a long press on the key silences the ring signal. During a call, a long press on the key changes between microphone on/off.</p>
---	--

### Key Lock, and Upper/Lower Case Key

	<p>This key locks the keypad in combination with the soft key "Lock". It is also used for switching between upper/lower case and digits.</p>
---	--

## Soft Keys

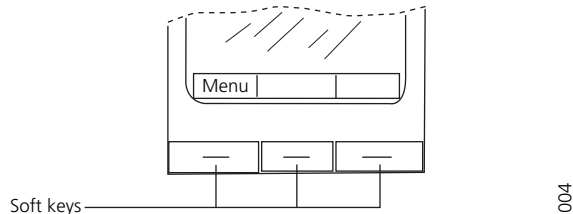

**Figure 4: Soft Keys**

The three soft keys are located just beneath the display. The function of each soft key is indicated by text in the display just above the keys.

In idle mode, the soft keys can be used for specific functions defined by the user of the handset.

## Volume Button

▲ and ▼ on the Navigation key are used for increasing/decreasing the earpiece, headset, and the loudspeaker volume.

## Alphanumeric Keys

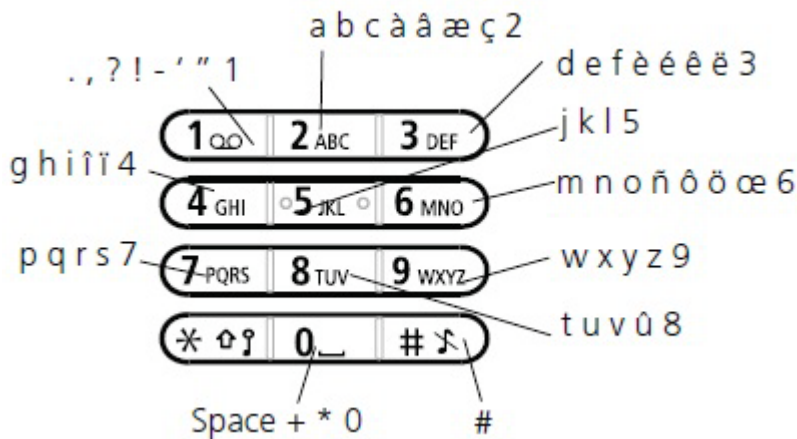

**Figure 5: Available Characters**



**Note:** Depending on the selected menu language, other characters can be available. This means that the character order can differ from the table above.

### *In standby mode, and number input mode*

- A short press on a key enter the digits “0” - “9” and the characters \* and #.
- Enter a pause in number input mode by a long press on the # -key. A pause is indicated by a "P" in the display.
- A long press on the \* - key changes the tone sender on. Tone sender on is indicated by a "T" in the display.



- The keys "0", "2" - "9" can be used for speed dialing. Press and hold any of the keys to access a contact beginning with a specific letter. For example, to access a contact beginning with the letter "A", press and hold the key "2" and then press "Call" to speed dial.

### *In text input mode*

- A short press on a key 0-9, displays the first available character on that specific key. The marked character is selected after a timeout, or when another key is pressed.
- To change to upper/lower case, press the \* key before entering the character. The \* key can also be used to display only the digits.
- To add space in the text, make a short press on key 0.
- The first character entered when adding/editing a name in the Contacts menu, will be an upper level character followed by lower level characters, unless the \* key is pressed before entering the character. To switch between Abc, ABC, abc, and 123 the \* key is pressed.
- A long press on the #-key displays special characters.

## Headset

If you will use your handset frequently, we recommended you use a headset so you have both hands free. The headset comes in two versions: microphone integrated in the cable and microphone on a boom.

In order to achieve optimal audio quality with your headset we recommend you select the corresponding headset profile. See the *Mitel 5603 Wireless Handset Configuration Guide* for more information.

The default setting is microphone on a boom; that is, the audio is optimized for using a headset with microphone on a boom. You can change the headset profile in the menu as follows:

1. Enter the menu by pressing the "Menu" soft key.
2. Select "Settings".
3. Press "Select".
4. Select "Headset".
5. Select the corresponding headset profile from list.
6. Press "Select".

If the pre-configured headset profiles do not match the headset in use, or the audio performance is poor, you can configure an own headset profile in the PDM. See the *Mitel 5603 Wireless Handset Configuration Guide*. You can select profiles configured in the PDM using the handset menu.

## Customizing Your Phone

### Switch the Handset On/Off

The handset is switched off:

1. Press and hold On-hook key .

When pressing the On-hook key, the handset will vibrate and the display lights up.

2. A window "Switch on" appears. Confirm by pressing "Yes".

The handset is in idle mode:

1. Press and hold On-hook key .

2. A window "Switch off" appears. Confirm by pressing "Yes".

### Turn the Audible Signal On/Off

A long press on  in idle mode, changes between ring signal on/off.

The  icon indicates a silenced handset.

### Lock/Unlock the Keypad

#### Lock/Unlock the Keypad in Idle Mode

To prevent accidentally pressing keys and making a call, the keys can be locked.

#### *Lock Keypad*

Press  and then "Lock".

#### *Unlock Keypad*

Press  and then "Yes".



**Note:** You can answer/close an incoming call while the keypad is locked. If configured in the PDM, you can to call an emergency call while the keypad is locked. See the *Mitel 5603 Wireless Handset Configuration Guide*.

## Lock/Unlock the Keypad during a Call

To prevent accidentally pressing keys you can lock them during a call. This can be useful when a headset is used and the handset is attached to a pocket or belt.

### Lock keypad

1. Press .
2. Press "Lock".

### Unlock keypad

1. Press .
2. Press "Yes".

## Lock/Unlock the Handset

You can protect the handset from unauthorized use. If you enable this function, you must enter a PIN code to switch on the handset to answer calls. You can change the default phone lock code (0000) to any 4 - 8 digit personalized code.

1. Press "Menu".
2. Select "Settings" .
3. Select "Locks".
4. Select "Phone lock".
5. Select "Auto phone lock".
6. Select "On", "On in charger", or "Off".





**Note:** If configured in the handset, any of the predefined emergency numbers can be called while the handset is locked. See the *Mitel 5603 Wireless Handset Configuration Guide*.

## Making and Answering Calls

### Make a Call

#### Pre-Dial

1. Enter the number.
2. Press  or "Call" to get the line. The number is shown on the display while dialling.

If required, press "Clear" to erase the number. You can use the Navigation key to step and add/delete a digit in the middle of a number. You can turn on the tone sender in a pre-dialed number by making a long press on .



An international number can be dialed from the handset by entering a + character followed by the country code and local number. To enter the + character, long press the 0 key until the character is shown in the display.



**Note:** The + character cannot be entered and international numbers cannot be dialed in the following circumstances:

- If the 0 key has been configured as a hot key.
- If the handset has been set up to perform advanced functions normally used by a system administrator, as described in [Admin Menu](#) on page 48.

#### Dial a Number from the Call list

1. Press  when in idle mode; or press "Menu", select "Calls" and then select "Call list".
2. Select a number.
3. Press  or "Call" to dial. The number can be edited before the call is started. Press "More" and select "Edit number".

#### Dial a Number from the Contacts

1. Press the "Menu" Soft key.
2. Select "Contacts".
3. Select "Call contact".
4. Select contact from list, or search name/number by entering characters in the "Search" field.
5. Press  or "Call" to make the call.

#### Dial a Number from the Local Phonebook

1. Press the "Menu" soft key.
2. Select "Contacts".

3. Select "Call contact".
4. Select contact from list, or search name/number by entering characters in the "Search" field.
5. Press  or "Call" to make the call.





**Note:** you can to access the Local phonebook by pressing the soft key  in idle mode.

### Dial a Name from the Central Phonebook<sup>1</sup>

1. Press the "Menu" soft key.
2. Select "Contacts".
3. Select "Central phonebook".
4. Select "Search by name".
5. Enter the first name and/or last name, the whole name does not have to be entered.
6. Press "Search".
7. Press  or the "Call" key to make the call.

### Dial a Number from the Company Phonebook

1. Press the "Menu" soft key.
2. Select "Contacts".
3. Select "Call contact".
4. The local and company phonebook appears in the same list but the company names are indicated by a "Locked entry" icon  in front of the name. Select contact from list, or search name/number by entering characters in the "Search" field.
5. Press  or the "Call" key to make the call.



**Note:** you can to access the Company phonebook by pressing the soft key  in idle mode.

## Answer a Call



The flashing LED, accompanied by a ring signal and/or a vibrating handset, notifies you of calls. The ring signal and vibrator can be disabled. The calling party's handset number or name is shown. The name will be shown if the calling party's handset number is stored in the local phonebook. When a headset is connected to the handset, the answering button on the headset can be used to answer the call.

Other answering methods can be specified in the Settings menu. See the *Mitel 5603 Wireless Handset Configuration Guide*. The answering methods are Automatically and Loudspeaking.

When "Automatically" is enabled, all incoming calls will be connected automatically.

1. This is a system dependent function.

## Answer a Call

When the signal sounds press  to answer the call, or press the  soft key to answer the call in loudspeaking mode. The name/number of the calling party appears if calling line information is available.

## End a Call

Press  to end the call. The duration of the call is shown in the display. The total time of the call can also be retrieved from the Calls menu > Call time.



## During a Call



**Note:** Some of these functions are system dependent. The options are set up in the Portable Device Manager (PDM). See the *Mitel 5603 Wireless Handset Configuration Guide* and *Portable Device Manager (PDM) Installation and Operation Guide*.

If configured in the PDM/Device Manager, you can call an emergency call while the handset/ keypad is locked. During the ongoing emergency call, the soft key "More" and the soft key "R" are disabled.

## Adjust the Volume during a Call

On the navigation key, press  and  to increase and decrease the volume, respectively. The handset will now store and keep the new volume level.

## Open Contacts during the Call

1. Press the "More" soft key during the call.
2. Select "Contacts".
3. Press "Select".
4. Select "Call contact" for searching a local or company phonebook contact, or select "Central phonebook" for searching a central phonebook contact.
5. Press "Select".
6. Select or search contact.



**Note:** You can call the selected contact by pressing "Call". When calling the contact, the first call will be put on hold. See also [Start a New Call during Conversation](#) on page 17.

## Turn the Microphone on/off during a Call



1. Press the "More" soft key during the call
2. Select "Microphone off"
3. Press "Select".

The  icon indicates a silenced microphone. This means that the other part in an ongoing call cannot hear you. To turn the microphone back on, do as follows:

1. Press the "More" soft key during the call.
2. Select "Microphone on".
3. Press "Select".

You can to turn the microphone off/on by a long press on .

### Start a New Call during Conversation

1. Press the "More" soft key during the call.
2. Select "New Call"<sup>1</sup>.
3. Press "Select".
4. Enter number, or press  to access the phonebook.
5. Press .

1. Visible if defined in the PDM.

## Call Handling for MiVoice Business

The In Call menu displays a list of functions that can be accessed during a call. To see the available functions, press the "More" soft key. Some functions are always provided and others may be made available by the administrator via the PDM/Device Manager. To use a function, navigate the In Call menu to highlight the required function and then press the "Select" soft key.



**Note:** If the handset is configured via PDM/Device Manager, any of the predefined emergency numbers can be called while the handset or the keypad is locked. When calling from a locked handset, only the Microphone on/off function in the In Call menu can be accessed. However, the entire In call menu is accessible when calling from a handset with locked keypad.

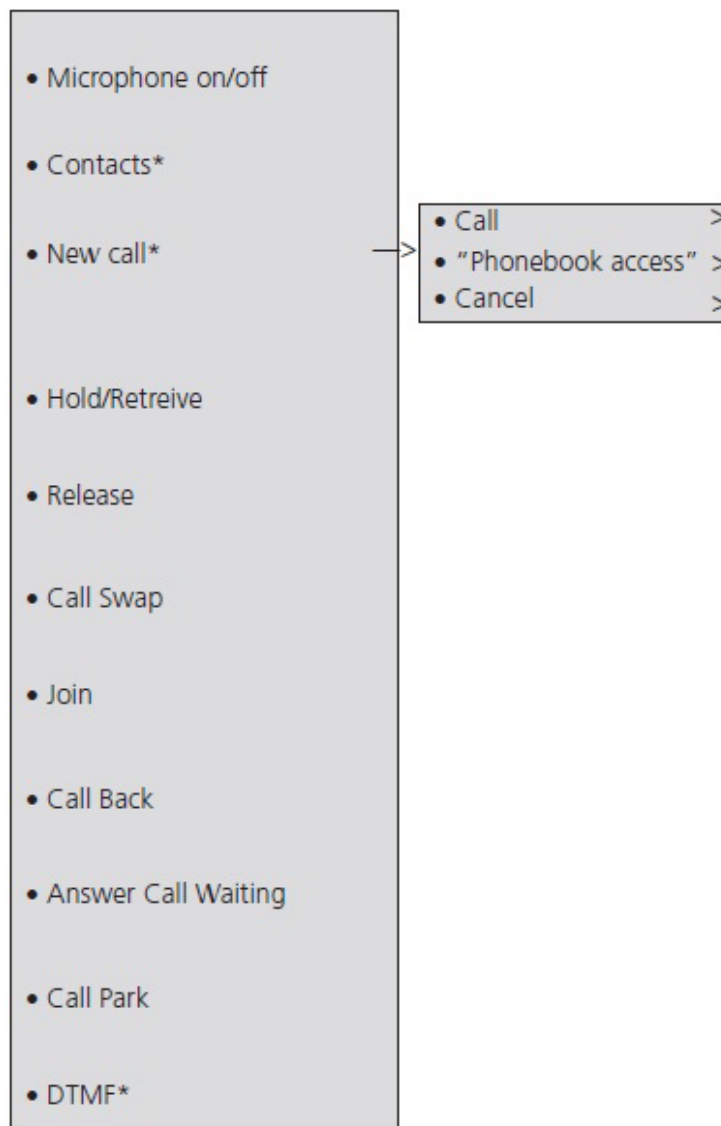

**Figure 6: Accessing Features**

\* Visible if enabled/defined in PDM/Device Manager.



You can also use these features by pressing the **R** key on the handset during a call. The table below lists the **In-Call** Menu features and the associated feature access code method.

In-Call Menu under More	Associated Feature Access Code
Contacts	
Microphone off	
New Call	R
Hold/Retrieve	R
Release	R4
Call Swap	R2
Join	RR + *80
Call Backl	5
Answer Call Waiting	R2
Call Park	RR + *7#

## Hold

1. During a call, press the "More" soft key.
2. Select "Hold/Retrieve" to put the call on hold.

### *To retrieve the Held Call*

1. Press the "More" soft key
2. Select "Hold/Retrieve" to retrieve the call.

## Transfer

1. During the call, press the "More" soft key.
2. Select "New Call".
3. Dial the number to which you want to transfer the call and then press the "Call" soft key.
4. Do one of the following:
  - to make a blind transfer, select "Release" to hang up and connect the other two parties.
  - to make a supervised transfer, wait for an answer, announce the transfer, and then select "Release" to hang up and connect the other two parties.
  - to terminate the transfer and return to the held call, press "More" and then select "Call Swap".

## Conference

To conference with another party during an active call:

1. During a call, press the "More" soft key.
2. Select "New Call" to put the current call on hold.
3. Dial the number of the third party.
4. Wait for an answer.
5. Press "More" and then select "Join" to conference all the parties together.

## Answer Call Waiting



**Note:** Depending on system setup and configuration, Call Waiting may be handled in one of two different ways.

### *Method 1*

While on a call, you hear a call waiting beep.

1. Press the "More" soft key.
2. Press "Answer Call Waiting" to answer the incoming call.

### *Method 2*

If a second caller calls during a phone call, the handset will beep and display the text "Internal call" for internal callers and "External call" for external callers. The handset will also show the name or phone number of the second caller. To answer the second caller:

1. Press the soft key "Accept".

The text "Switch" briefly appears on screen, and the handset transfers to the second call. The first call is put on hold.

2. When finished speaking with the first caller, select the "More" soft key.
3. Select "End Call".

The second call is closed and the first call is retrieved.



**Note:** It is possible to reject a second call by pressing the "Decline" soft key. The second caller will hear a busy tone, and the call will be logged as a missed call in the handset.

## Callback

Callback lets you request that the system notify you when a busy extension becomes free.

1. When a number/extension is busy, press the "More" soft key.
2. Select "Call Back" to set up the callback.
3. Your extension will ring when the called extension becomes free and automatically dial the extension back.

## Call Park

The Call Park feature allows you to place a call in a special hold state. You, or someone else, can then retrieve the call from any extension in the system. After parking the call, the system can automatically connect you to paging equipment so that you can announce the call to the requested party.

To park an active call:

1. During the call, press the "More" soft key.
2. Select "Call Park".
3. Dial the directory number on which to park the call
4. Inform the called party of the waiting call.

To retrieve a parked call:

1. Press "Call" .
2. Press "Call Services".
3. Select "Call Park - Retrieve" and enter the directory number on which the call is parked.

## Advanced Features for MiVoice Business

The following features are available from the "Calls -> Call services" menu:

- Call Forward
- Call Forward Cancel
- Do Not Disturb
- Do Not Disturb Cancel
- Call Pickup
- Call Park Retrieve
- Direct/Group Page
- Loudspeaker Page

To access the Call Services menu:

1. Enter the menu by pressing the "Menu" soft key.
2. Select  in the menu.
3. Press "Select".

### Call Forward

To set Call Forwarding:

1. Press the "More" soft key.
2. Select "Call Forward".
3. Enter the extension number to which you want to forward your calls.
4. Press "Call".
5. Listen for a confirmation tone and then hang up.

To cancel Call Forwarding:

1. Press the "More" soft key.
2. Select "Call Forward Cancel".
3. When you hear a re-order tone, press  to hang up. Forwarding is cancelled.

### Call Pickup

To answer a call that is ringing at another station in your Pickup Group:

1. Press the "More" soft key.
2. Select "Call Pickup".
3. Answer the call.

## Do Not Disturb

To activate Do Not Disturb:

1. Press the "More" soft key.
2. Select "Do Not Disturb".
3. When you hear a re-order tone, press  to hang up.

To deactivate Do Not Disturb:

1. Press the "More" soft key.
2. Select "Do Not Disturb Cancel".
3. When you hear a re-order tone, press  to hang up.

---

**IMPORTANT: Do not select an option from the active call menu during any of the Paging features. The options are not applicable and your call will be terminated if selected.**

---

## Direct Page

Direct Paging allows you to page a party through the party's handsfree speaker.

1. Press the "More" soft key.
2. Select "Direct/Group Page".
3. Dial the extension number, and announce the page.

## Group Page

Group Paging allows you to page a group of telephones through their built-in speakers.

1. Press the "More" soft key.
2. Press "Direct/Group Page".
3. Do one of the following:
  - To page your prime page group, press #.
  - To page a specific page group, dial the page group directory number.
4. Speak to the dialed party after the tone.

## Loudspeaker Page

1. Press the "More" soft key, and then press "Loudspeaker Page".
2. Dial the paging zone number, if required.
3. Wait for ringback and announce the page.



**Note:** Ask your Administrator for the paging zone number.

## Call Handling for the Mitel 5000 CP

 **Tip:** These feature descriptions apply to the use of the 5603 Wireless Handset on the Mitel 5000 CP Release 6.0 and higher.

During a call you may need to use features, such as Hold, Transfer, Conference, and Call Swap.

You access these features during a call by pressing the "More" soft key. It displays the "In Call" menu depicted in the following image.

**Note:** These options are visible if the Mitel 5000 menu template has been installed on the 5603 Wireless Handset. The default menus reflect the features that operate with MiVoice Business.

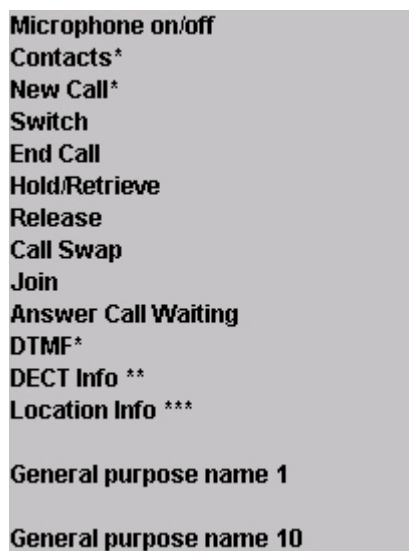

**Figure 7: Accessing Features**

\* Visible if enabled/defined in the PDM/WSM3

\*\* Visible if the Admin menu is activated.

\*\*\* Visible if the Admin menu is activated. You require the DECT location license.

You can also use these features by pressing the "R" key on the handset during a call. The following table lists the In-Call menu features and associated feature access code methods.

In-Call Menu under More	Associated Feature Access Code
Contacts	
Microphone off	
Hold	R
New Call	R
Release	R4
Join	RR + (5)
Answer Call Waiting	R2
Call Swap	R2
Switch	R2
End Call	R1

## Hold

1. Press the "More" soft key.
2. Select "Hold/Retrieve" to put the call on hold.

### *Retrieve a Held Call*

1. Press "More".
2. Select "Hold/Retrieve" to retrieve the call.

## Transfer

1. Press "More".
2. Select "New Call".
3. Dial the number to which you want to transfer the call and then press "Call".
4. Do one of the following:
  - to make a blind transfer, select "Release" to hang up and connect the other two parties.
  - to make a supervised transfer, wait for an answer, announce the transfer, and then select "Release" to hang up and connect the other two parties.
  - to terminate the transfer and return to the held call, press "More" and then select "End Call".

## Conference

To conference in another party while on a call:

1. Press "More"
2. Select "New Call" to put the current call on hold.
3. Dial the number of the third party.
4. Press "Call".
5. Wait for an answer.
6. Press "More".
7. Select "Join".

## Answer Call Waiting

While on a call, if you hear a call waiting beep:

1. Press "More"
2. Press "Answer Call Waiting" to answer the incoming call.

The new call is now connected, and the first call is on hold.



## Advanced Features for the 5000 CP



**Tip:** These feature descriptions apply to the use of the 5603 Wireless Handset on the Mitel 5000 CP Release 6.0 and higher.

The following features are available from the "Calls -> Call services" menu:

- Call Operator
- Config Assistant
- Reverse Transfer

These features are visible if the 5000 CP menu template has been installed on the 5603 Wireless Handset. The default menus reflect the features that operate with MiVoice Business. It may be necessary to re-program the feature access codes to match the codes used on the 5000 CP.

To access the Calls -> Call Services menu:

1. Enter the menu by pressing the "Menu" soft key.
2. Select  in the menu.
3. Press "Select". The "Calls" menu is displayed.
4. Select "Call Services".

### Call Operator

To call your switchboard operator:

- Access the Call Services menu.
- Select "Call Operator"

## Config Assistant

Configuration Assistant allows you to access this voice guided configuration portal that provides easy-to-use, remote access to the following phone configuration options:

- Dynamic Extension Express
- DND
- Manual Call Forwarding
- Meet-Me Conferencing

To use Config Assistant:

- Access the Call Services menu.
- Select "Config Assistant"

Follow the voice prompts to make the changes to the required features.

## Reverse Transfer

You can use Reverse Transfer (Call Pick Up) to answer calls that are ringing or holding at other extensions. For example, if you receive a call while you are away from your desk, you can pick up the call from another extension.

To use Reverse Transfer:

1. Access the Call Services menu.
2. Select "Reverse Transfer"
3. Dial the extension or hunt group number where the call is ringing or holding. The call is transferred to the phone you are using and you are connected to the caller.

## Voice Mail

### Receive a Voice Mail

When a new voice mail is received, the message alert signal sounds, and the voice mail icon  appears in the status bar. The new voice mail notification is also displayed in a window.

### Check the Voice Mail Inbox

Check the voice mail(s) by pressing "Call" from the window. If "Close" is selected, you can dial the Voice Mail by a long press on digit key "1" when in standby mode.

Follow the given instruction in the Voice Mail.





**Note:** In case the following message is shown: "Voice mail number not defined", the voice mail number needs to be configured to the voice mail button. Contact your system administrator.

## Contacts

The handset has a local phonebook with 250 entries, where names and numbers freely can be added, deleted, and edited by the user. The phonebook lists all names in alphabetical order, where three numbers can be added for each contact, that is, work number, mobile number, and other number.

For more information on how to add, edit, or delete a contact. See [Contact Menu](#) on page 37.

In addition, a company phonebook with up to 500 entries can be downloaded to the phone via the PDM. See [Software Upgrade and Additional Features](#) on page 49. The company phonebook name and numbers cannot be edited or deleted by the user. The phonebook lists all names in alphabetical order.

The local and company phonebook appears in the same list but the company contacts are indicated by a “Locked entry” icon  in front of the name. The company contact includes work number only. See [Dial a Number from the Company Phonebook](#) on page 15 for more information. The local and company phonebook can also be accessed by pressing the soft key  in idle mode.

you can to access a central phonebook<sup>1</sup>. See [Dial a Name from the Central Phonebook](#) on page 15. The user then sends a request to a messaging server with the first characters entered, and the messaging server will return a list of names and numbers that matches the search.

1. This is a system dependent function.

## Navigate the Menu

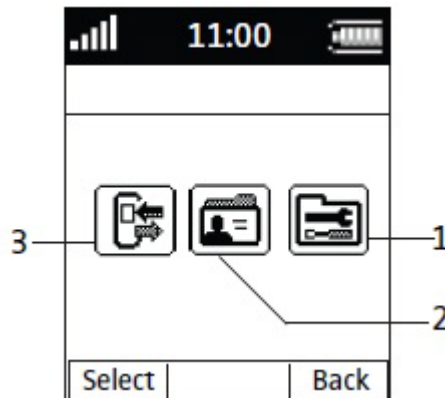

Figure 8: Main Menu

- Settings (1)
- Contacts (2)
- Calls (3)

## Enter/Exit the Menu Mode

Enter the menu by pressing the Menu soft key. The most recently used tab is highlighted. If the handset has been restarted, the Contacts tab appears.

1. Use the Left or Right navigation key to choose a menu tab and then press the Down navigation key to open it. The menu title appears and the first alternative is highlighted.
2. Use the Up or Down navigation keys to move through the list. Press the Right navigation key to select an alternative.

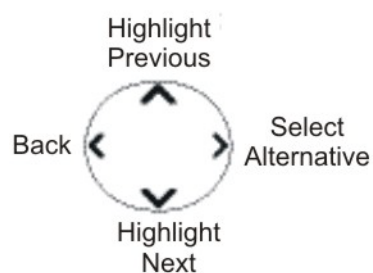
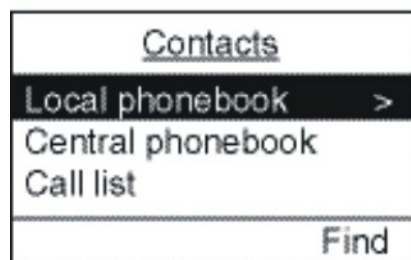

To back up in Menu mode:

- If you entered the menu using the Right navigation key, you can use the Left key to back up one step.
- If you entered the menu using the Menu soft key, use the **Back** soft key to back up.
- Press the **Menu** soft key again to exit the Menu and return to standby mode.

## Menu Tree

The following diagrams illustrate the menus for each tab.



**Note:** Some options are system-dependent and may not appear on your phone.

### Calls

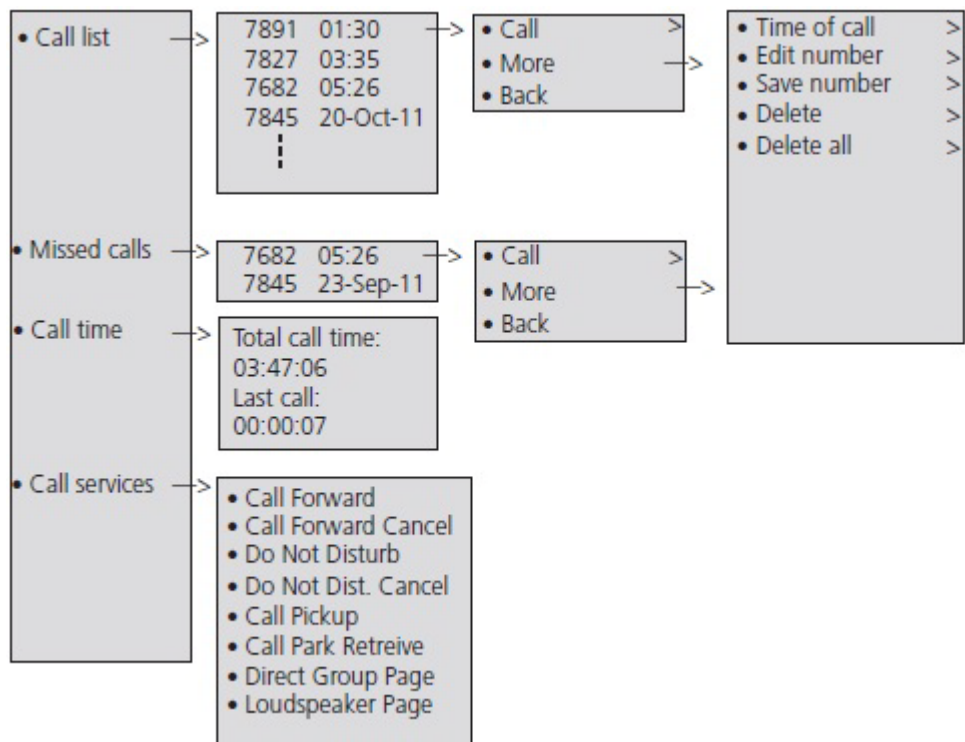

## Contacts

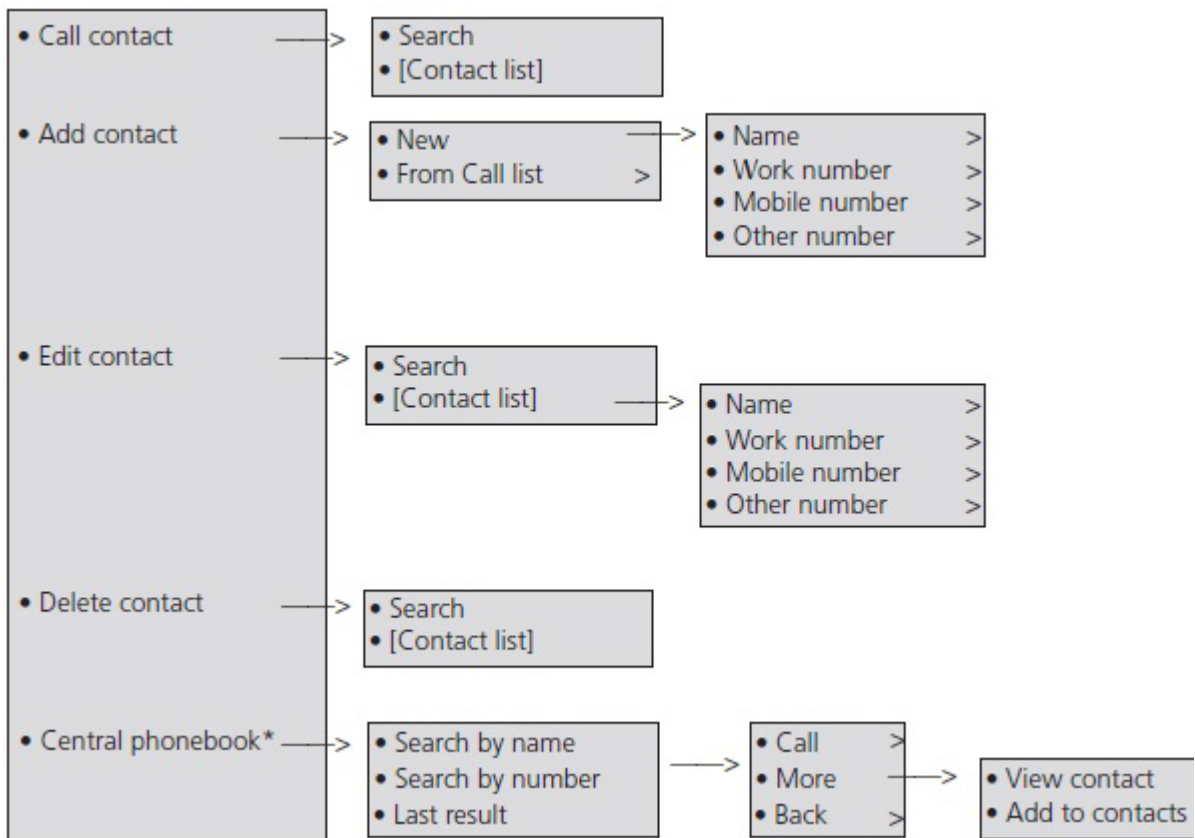

\* System dependent



**Note:** You can access the Call contacts menu by pressing the soft key  in idle mode.

Settings 

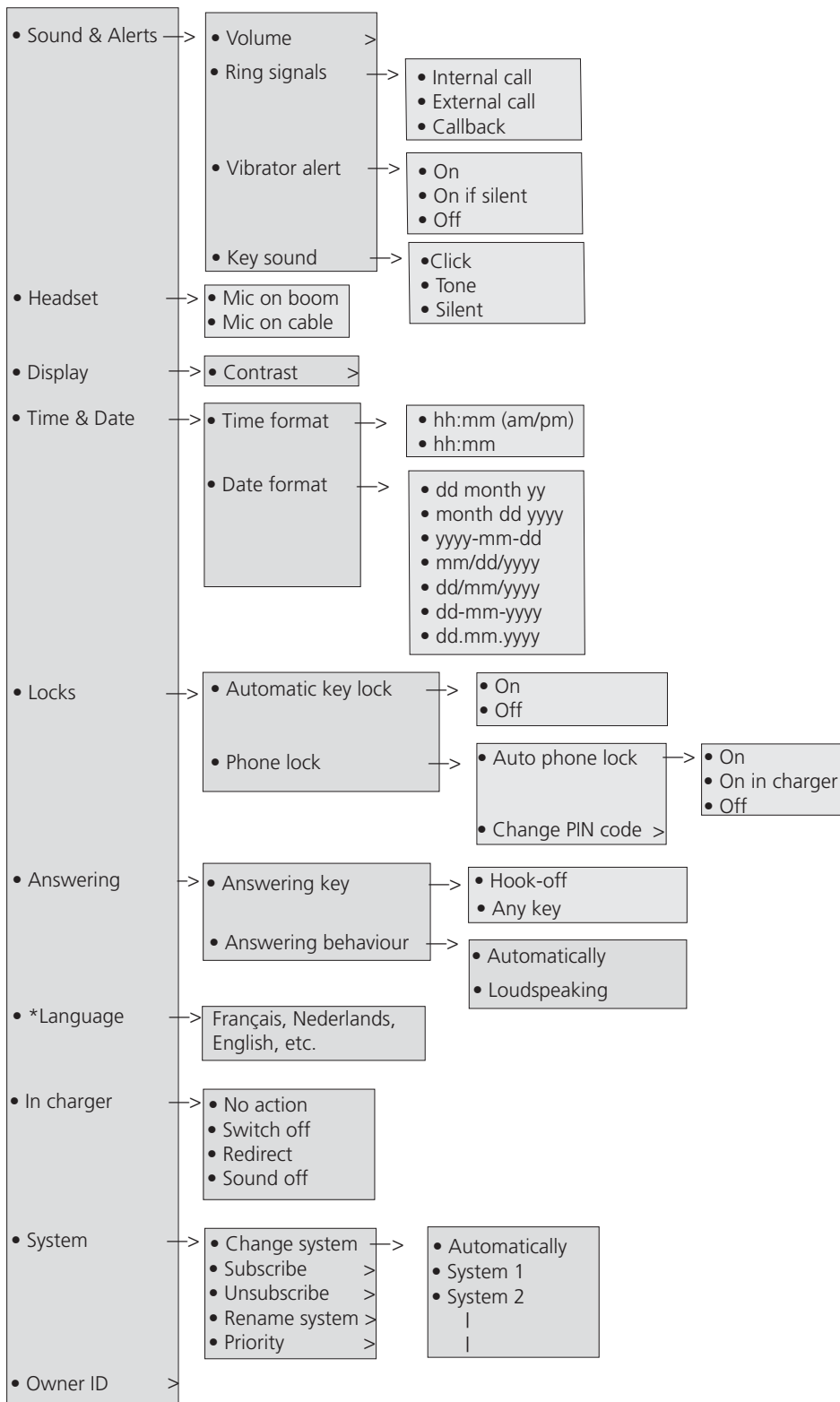



## In Call

The In Call menu can be reached during an ongoing call by pressing the "More" soft key. Some functions are always provided and others may be made available by the administrator via the PDM/Device Manager. To use a function, navigate the In Call menu to highlight the required function and then press the "Select" soft key.



**Note:** If configured in the PDM/Device Manager, any of the predefined emergency numbers can be called while the handset or the keypad is locked. When calling from a locked handset you can access the Microphone on/off function only from the In Call menu. During an ongoing emergency call you cannot access the In Call menu.

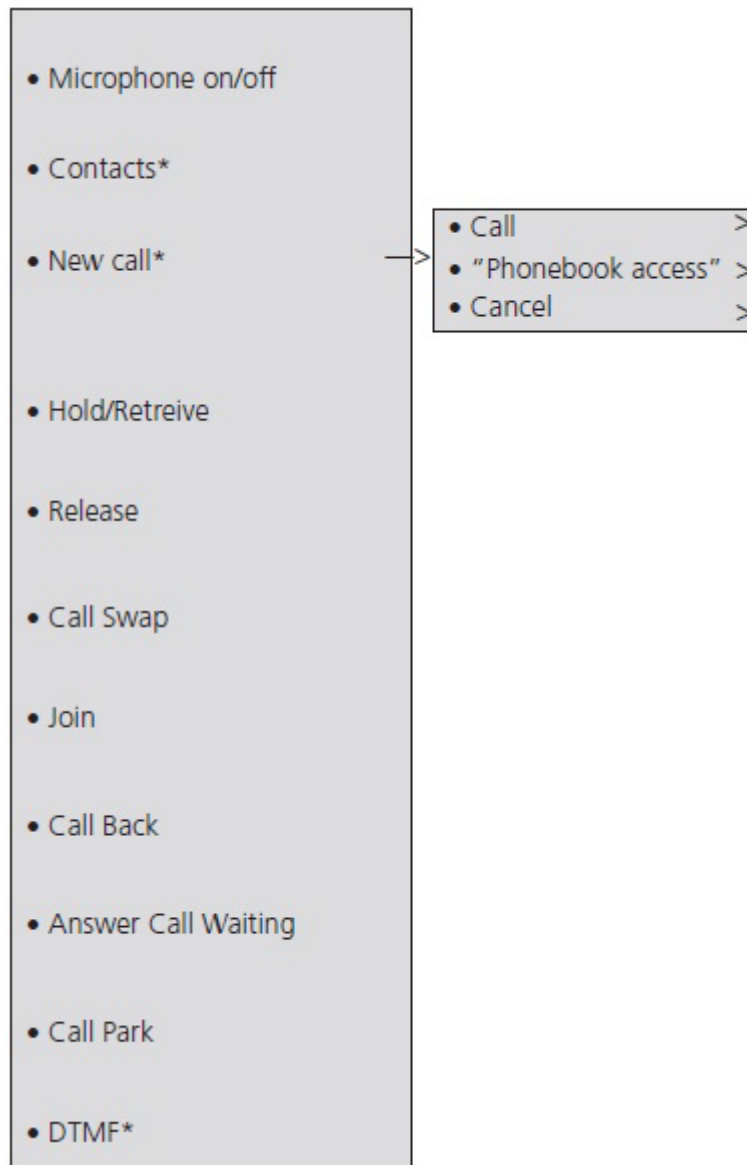

\* Visible if enabled/defined in PDM/Device Manager

## Call Menu

1. Enter the menu by pressing the "Menu" soft key.
2. Select  in the menu.
3. Press "Select".

## Call List

The 25 last received, dialed or missed calls are stored in a call list. If a number occurs more than once the last time stamp, together with the total number of occurrences, is shown.



**Note:** If supported by the system, the number's contact name can be displayed in the call list.

1. Select "Call list", and step with ▲ and ▼ to scroll in the list.

The "Call list" can also be opened by pressing  in idle mode.

### *Dial number from Call list*

1. Select a number to call.
2. Press "Call" to dial.

### *View the Time of a Call*

1. Press "More".
2. Select "Time of call". The time and date appears.

### *Edit Number from Call list*

1. Press the "More" soft key.
2. Select "Edit number".

### *Save Number*

1. Press the "More" soft key.
2. Select "Save number".

### *Delete Entry from the Call list*

1. Press the "More" soft key.
2. Select an entry to delete.
3. Select "Delete".
4. Select "Yes" to delete the entry from the list.

### Delete all Entries from the Call list

1. Press the "More" soft key.
2. Select "Delete all".
3. Select "Yes" to delete all the entries from the list.

### Missed Calls

A missed call is by default indicated by a Missed call dialog window, but it can be disabled in the handset via PDM/Device Manager.

1. Select "Missed calls".
2. Step with the ▲ and ▼ to scroll in the list.
3. Press "Call" to call back.

As in "Call list" there is a "More" soft key which can be used to view the time/date of the call, edit the received number, add to contacts, and delete received numbers. See [Call List](#) on page 36 for information about the functionality in the "More" soft key.



**Note:** If supported by the system, the number's contact name can be displayed in the list.

### Call Time

The total time of the previous call and last call appears by selecting "Call time".

## Contact Menu

1. Enter the menu by pressing the "Menu" soft key.
2. Select  in the menu.

### Call Contact



**Note:** Is it also possible to access Call contact by pressing the soft key  in idle mode.

1. Select "Call contact".
2. Select contact from the list, or enter name or number in the search field.
3. Press , or "Call".

you can to edit the contact by selecting "View" > "More". Note that it is not possible to edit a company phonebook contact. The company contacts are indicated by a "Locked entry" icon  in front of the name.

### Add Contact

1. Select "Add contact".

### Add New Contact

1. Select "New".
2. Select "Add", and enter the name of the contact. See [Alphanumeric Keys](#) on page 10.
3. Press "OK".
4. Select "Work number", "Mobile number", or "Other number".
5. Press "Add".
6. Enter the numbers. you can add tone "T" or pause "P" in phone numbers by pressing the Space key 5 times or 7 times, respectively.
7. Press "OK".
8. Press "Save" and then "Back".

### Add from Call List

1. Select "From call list".
2. Select a number.
3. Press "Add".
4. Select "Work number", "Mobile number", or "Other number".
5. Press "Select".
6. Press "Add", and enter name for the contact. See [Alphanumeric Keys](#) on page 10.
7. Press "OK".
8. Press "Save".

### Edit Contact



**Note:** It is not possible to edit a company phonebook contact. The company contacts are indicated by a "Locked entry" icon  in front of the name.

1. Select "Edit contact".
2. Select contact, and press "Edit" twice.
3. Enter new name/number. See [Alphanumeric Keys](#) on page 10. You can add tone "T" or pause "P" in phone numbers by pressing the Space key 5 times or 7 times, respectively.
4. Press "OK".
5. Press "Save".

## Delete Contact



**Note:** It is not possible to delete a company phonebook contact. The company contacts are indicated by a "Locked entry" icon  in front of the name.

1. Select "Delete contact".
2. Select a contact.
3. Press "Delete".
4. Press "Yes" to confirm.

## Central Phonebook

In the central phonebook you can search by name or number. The last search result can be displayed.

When the search result appears, you can view contact information, and add the number to new contact by pressing the "More" soft key. you can to dial the number by pressing , or the "Call" soft key.

1. Select "Central phonebook".

### *Search by Name*

1. Select "Search by name".
2. Enter first name and/or last name.
3. Press "Search". The search result will be displayed.

### *Search by Number*

1. Select "Search by number".
2. Enter the number.
3. Press "Search". The search result appears.

### *View Last Search Result*

Select "Last result". Only the last result will be displayed.

## Settings Menu

1. Enter the menu by pressing the "Menu" soft key.
2. Select  in the menu.

### Sound and Alert Settings

#### *Adjust the Ringer Volume*

1. Select "Sound & Alerts".
2. Select "Volume".
3. Adjust the volume by using ▲ and ▼ on the navigation key.
4. Press "Back" to save the setting.

#### *Select Ring Signals*

1. Select "Ring signals".
2. Select "Internal call", "External Call", or "Callback"<sup>1</sup>.
3. Press "Select".
4. Select ring signal. You can listen to the selected ring signal by pressing the "Play" soft key. The ring signal will be repeated until the "Stop" soft key is pressed.
5. Press "Select".

#### *Turn the Vibrator on/off*

1. Select "Vibrator alert".
2. Select "On", "On if silent" (i.e. the vibrator is on when the handset is muted), or "Off".
3. Press "Select".
4. Press "Back" to save the setting.

#### *Set the Key Sound*

This means that every time a key is used, a low sound is heard.

1. Select "Key sound".
2. Select "Silent", "Click", or "Tone".
3. Press "Back".

You can listen to the key sound by pressing the "Play" soft key.

1. "Callback" is only applicable if defined in the PDM/Device Manager.

## Select Headset Profile

1. Select "Headset".
2. Select "Mic on boom", "Mic on cable", or "Customized headset profile"<sup>1</sup>
3. Press "Select".

## Display Settings

### Contrast

1. Select "Display".
2. Select "Contrast".
3. Adjust the contrast by using the ▲ and ▼ on the navigation key.
4. Press "OK".
5. Press "Back".

## Screen Saver

The screen saver can be set to one of the following settings:

- Information: Displays status and identification information while the handset is idle.
- Black: The screen is black when the handset is idle.
- Black also in call: The screen is also black when the handset is in call.

To set the screen saver:

1. Select "Display" from the handset menu.
2. Select "Screen saver". The current setting is displayed under "Screen saver".
3. Select "Information", "Black", or "Black also in call".
4. Press "Back".



**Note:** When charging the handset in an advanced charger or rack charger, information is replaced by the large license indicator shield. When in the desktop charger it is the same as when out of the charger.



**Note:** When the handset with the screen saver set to "Information" is in a charger, the Owner ID is displayed even if the handset switched off. This simplifies identification when many handsets are in a charging rack.

## Time & Date Settings

The time and date displayed in the handset cannot be changed by the user. The IP-DECT system is solely responsible for keeping the time. The handset also synchronizes with the IP-DECT system time when:

1. "Customized headset profile" is only visible if the headset profile has been configured in the PDM/Device Manager.

- The handset is turned on after having been turned off. The handset requests the current IP-DECT system date and time.
- The handset remains on for longer than 24 hours. The handset requests the IP-DECT system time every 24 hours from the time it was last turned on.

The time and date formats displayed in the handset can be changed by the user as described in the following sections.

### *Set Time Format*

1. Select "Time & Date"
2. Press "Select".
3. Select time format. The actual time format will be displayed. Selectable time formats:
  - hh:mm (am/pm) (for example: 1:00pm)
  - hh:mm (for example 13:00)
4. Press "Select" to save the setting.

### *Set Date Format*

1. Select "Time & Date".
2. Press "Select".
3. Select "Date format"
4. Press "Select". Date formats:
  - DD/MM/YYYY, for example: 17/09/2008 (also called Europe)
  - MM/DD/YYYY, for example: 9/17/2008 (also called US)
  - YYYY-MM-DD, for example: 2008-09-17 (ISO 8601)
  - MMM DD YYYY, for example: Sep 17 2008
  - DD MMM YY, for example: 17 Sep 08
  - DD.MM.YYYY, for example: 17.09.2008
  - DD-MM-YYYY, for example: 17-09-2008
5. Press "Select" to save the setting.

## Phone Lock Settings

### *Activate the Automatic Key lock*

1. Select "Locks".
2. Select "Automatic key lock".
3. Select "On" for activation of automatic key lock.



**Note:** A call can be answered or ended while the keypad is locked. If configured in the PDM/Device Manager, any of the predefined emergency numbers can be called while the keypad is locked. See the *Mitel 5603 Wireless Handset Configuration Guide*.



### Activate the Phone Lock

The handset can be protected for unauthorized use. If this function is activated, a PIN code has to be entered at power on, or when the handset is placed in a charger - this behaviour will first be activated when the handset is placed in the charger. The default phone lock code (0000) can be changed to any 4-8 digit personalized code.



**Note:** If configured in the PDM/Device Manager, any of the predefined emergency numbers can be called while the handset is locked. See the *Mitel 5603 Wireless Handset Configuration Guide*.

1. Select "Locks".
2. Select "Auto phone lock".
3. Select "On", or "On in charger".
4. Enter a PIN code.
5. Press "OK".

If the PIN code is forgotten it can be removed by your distributor.

### Deactivate the Phone Lock

1. Select "Locks".
2. Select "Auto phone lock".
3. Select "Off".
4. Enter a PIN code.
5. Press "OK".

### Change PIN Code

1. Select "Change PIN code".
2. Enter the old PIN code.
3. Press "OK".
4. Enter new PIN code twice.
5. Press "Save".

## Answering

The default setting for the handset is to use the Off-hook key when answering a call. The answering behaviour can be configured to answer the call automatically, i.e. without pressing a key, and/or in loudspeaking mode. you can to set the answering behaviour to any key. If "Any key" is selected, any keys except the "On-hook" key and the "Sound off" key can be used to answer a call.

### Answering Key

The answering key is by default set to *Hook-off*.

1. Select "Answering".
2. Select "Answering key".
3. Select "Hook-off" or "Any key".
4. Press "Back" to save the setting.

### Answering Behaviour

1. Select "Answering".
2. Select "Answer behaviour".
3. Select "Automatically" and/or "Loudspeaking".
4. Press "Change" to change the setting. The check box will be marked.
5. Press "Back" to save the setting. To remove the setting, press "Change". The check box will be unmarked.

## Change the Menu Language

1. Select "Language". English, Español (Spanish), Français (French), Nederlands (Dutch), Deutsch (German), Russki (Russian).
2. Press "Back".



---

**Note:** You can download one additional language via the PDM/Device Manager. See [Software Upgrade and Additional Features](#) on page 49. Seven languages are available for download; Czech, Greek, Hungarian, Polish, Russian, Slovakian, and Turkish.

## Change Owner ID

The Owner ID is set to identify the handset.

1. Select "Owner ID".
2. Enter in identity.
3. Press "Save".

## In Charger

### Redirect Calls while Charging

Calls can be redirected to another extension when the handset is placed in a charger. The function is automatically cancelled when the handset is removed from the charger.

1. Select "In charger".

2. Select "Redirect".



**Note:** The settings in the system determines how the incoming calls will be handled. This is a system dependent feature.

### *Switch off While Charging*

When the handset is placed in the charger it can be switched off. When removed from the charger it will switch on again.

1. Select "In charger".
2. Select "Switch off".

### *Mute Handset While Charging*

When the handset is placed in the charger it can be muted while it is charging. When it is removed from the charger it will switch on the sound again.

1. Select "In charger".
2. Select "Sound off".

### *Deactivate the Charging Mode*

1. Select "In charger".
2. Select "No action".

## System



### *Change System*

Select "Automatic" or a specific system. If the handset is set to "Automatic" it selects a system according to the priority list. See [Priority](#) on page 47.

### *Subscribe Handset in IP-DECT System using Easy Registration*

A handset can subscribe to an IP-DECT system automatically if the following are fulfilled:

- The IP-DECT system is configured for Easy Registration; see the *Mitel IP-DECT Base Station Installation and Operation Guide*.
- The handset's extension number and IPEI are registered in the IP-DECT system, see the corresponding manual for the IP-DECT system.
- The handset is not subscribed to any systems.
- The handset software is version 4.0.2 or greater.

1. If needed, switch off the handset by pressing .
2. Switch on the handset by pressing .
3. Select language to be used or press "Cancel". If Cancel is pressed, the default language (English) will be used.

4. The handset starts to search for IP-DECT systems and will subscribe to the system when it is found.



**Note:** If no system is found within 2 minutes or "Cancel" is pressed, the handset's subscription menu is displayed. Continue with step 5 in the procedure [Subscribe Handset in IP-DECT System Manually](#) on page 46 for more information.

### *Notes about Subscribing Handsets and Hot Desking*

If the handset is subscribed, but not registered with MiVoice Business or 5000 CP, the handset will display the following message: "Please login".

- When subscribing the handset to the IP-DECT Base Station, enter the leading 0's of the PARK code. Removing the 0's will prevent subscription.
- After registering the handset with MiVoice Business or the 5000 CP using the System ID, Extension, and auth password, the "Please Login" message is removed from the handset.
- If you are unable to subscribe the handset, ask the administrator to remove the handset IPED from the user in the IP-DECT Base Station, if the IPED was pre-programmed for the user.

If the handset is configured as a Hot Desk handset, then "Please Login" appears for the user to enter hot desk information.

### *Subscribe Handset in IP-DECT System Manually*

To subscribe an IP-DECT system manually, the "Park:" (Portable Access Right Key) and "Ac:" (Authentication code) related to the system are needed. Contact the system administrator for more information. If the handset subscribes to an additional system, it must also be added manually.



**Note:** The PARK code may not be required if there is no alien DECT system within the coverage area.

The IPEI/IPED code is a unique code which has been assigned to the handset. See also [Admin Menu](#) on page 48.

1. Select "System".
2. Select "Subscribe".
3. Enter System name (optional). If no system name is entered, the default name will be used. That is System A, System B, depending on which system name is free.
4. Press "Next".
5. Enter PARK code (max. 31 digits). The PARK code may not be required if there is no alien DECT system within the coverage area.
6. Enter AC code. Press "Next".  
An information text "Protection on?" appears.
7. Select "Yes" if the new system needs to be protected. It is not possible to delete a protected subscription from the System menu<sup>1</sup>.

8. Press "OK". A searching mode starts.

### *Unsubscribe System*

1. Select "Unsubscribe"<sup>1</sup>.
2. Select the system to unsubscribe in the list.
3. Press "Select".
4. Press "Yes" to unsubscribe the system. Otherwise, press "No".

### *Rename System*

You can change the name of the system in the handset.

1. Select "Rename System".
2. Select the system to rename.
3. Press "Edit".
4. Enter new name.
5. Select "Save".

### *Priority*

The default order of priority is the order of entered subscriptions. This means that the first subscribed system has the highest priority. This list can be edited by the user. You can set the systems in priority by moving them up or down in the list.



**Note:** This is used in combination with system set to be "Automatic". See [Change System](#) on page 45.

1. Select "Priority".
2. Change the priority if required by selecting "Up" or "Down". The priority will be saved when "Back" is selected.

1. It is not possible to unsubscribe a protected system via the System menu. The unsubscription must be made via the Admin menu or the DECT system.

## Advanced Functions

### Admin Menu

The handset has a hidden menu for system administrators. See the *Mitel 5603 Wireless Handset Configuration Guide*.

The Admin menu contains:

- Software and hardware information, licence information, IPEI/IPDI, and User ID
- DECT link and system information
- Fault logging
- Centralized Management status
- Enhanced system menu with ability to alter protection
- Factory reset option

For quick access to the **Device Information (DI)** menu in idle mode, press the keys containing **\*#DI#** (that is **\*#34#** ). To view the IPEI/IPDI directly, press **\*#06#**. See the table below

Information	Code
Software version	*#34#
Hardware version	*#34#
IPEI/IPDI	*#34# or *#06#
User ID	*#34#

### Clear Lists in Charger

Via PDM/Device Manager you can set a parameter that will clear call lists that have been stored in the handset. When the parameter is activated to the handset, the lists will be deleted when placed in a charger. This is primarily useful to shift workers who share the same phone. See also the *Mitel 5603 Wireless Handset Configuration Guide*.

# System Handling

## Software Upgrade and Additional Features

Software and options in the 5603 handset can be upgraded by using the PDM or the WSM. See the *Portable Device Manager (PDM) Installation and Operation Guide* or the *WSM Installation and Operation Guide*.

Examples of additional features that can be downloaded/configured via PDM/Device Manager:

- Company phonebook
- Downloadable languages

Refer to the *Mitel 5603 Wireless Handset Configuration Guide* for more information.

To view the handset's software version, enter \*#34# in standby mode.

## Handset Updates via Charging Rack

From time to time, users are instructed to leave their handsets in a central charging rack to allow the handset to be updated with new features and functions. An ongoing update is indicated by the  in the handset header bar and an "Updating handset" message is displayed in the active area.

During the update, a message is displayed to indicate that an update is in progress as shown in [figure 9](#). The "OK" soft key can be selected to close the message.

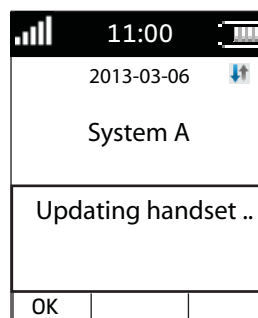

**Figure 9: Handset Update while in Charger**

If the handset removed from the charger and used, the update is suspended and resumed when it is returned to the charger.

When the update is complete, a "Handset is updated" message is displayed to indicate that the handset is available for use, as shown in [figure 10](#). Select the "OK" soft key to close the message.



**Figure 10: Update Completed while in Charger**



## Troubleshooting

This section contains information on how to solve common operational problems, and warnings you may receive.

Go through the following lists if you encounter any problems. If this checklist does not solve the problem, contact your system administrator.

If others have similar problems, there may be a system error.

### Operational Problems

Fault	Probable cause	Action or comment
No display	The battery level is low The screen saver is set to "Black also in call" The handset is defective.	Charge the battery Change the screen saver setting as described in <a href="#">Screen Saver</a> on page 41 Contact system administrator.
No ringing	The sound off icon is on, or ringer volume set to silent, or the handset is defective.	Long press the Sound off key, or increase volume, or contact system administrator.

### Error or Warning Messages

Display shows	Probable cause	Action or comment
No access	The network is in range, but no access rights.	Switch handset off and then switch it on again or contact system administrator.
No System. The handset beeps once a minute (during max 30 minutes) with a low tone followed by a high tone (if enabled, the vibrator also follows the beeps).	The handset is out of coverage or handset is defective.	Stop the beep with the Sound off key and go into range. Note: When re-entering the coverage area it can take a couple of minutes before the handset automatically has registered into the system. or contact system administrator.
SERVICE required options corrupt	The handset is defective.	Select reset option on the middle soft key if available or if no reset option is available or fault does not resolve the handset needs repair. Note: Display message only shown in English.

Display shows	Probable cause	Action or comment
SERVICE required Invalid IPDI <b>Note:</b> This display message is only shown in English.	Easy replacement procedure not followed correctly or failure during easy replacement procedure.	Send the handset for service.
Enter PIN code	The handset's lock is activated.	Enter the required PIN code. If PIN code lost enter new via PDM or do a factory reset via PDM.
Battery low, charge now	The battery level is low.	Charge or replace the battery.
Phonebook is not available at the moment.	The phonebook does not respond, not available at the moment.	Try again later or if fault persists do a factory reset via admin menu or PDM.
Voice mail number not defined	There is no Voice mail number defined in the handset.	Define a Voice mail number via PDM.
Could not encrypt connection	The parameter "Encryption Required" is enabled in the handset in combination with; 1. Unencrypted base station(s); and/or, 2. Unsupported base station(s).	1. Disable the "Encryption Required" parameter in handset; and/or, 2. Enable the encryption in the base station(s); and/or, <b>Note:</b> If base station(s) is used, the software version must be 3.1.x or later. 3. Use supported base station(s). Ask your supplier.
Page 2 of 2		

*LED Error Indications*

See also chapter *LED Indications during Easy Replacement* on page 59.

LED is flashing red, quick flash, (100 ms on, 800 ms off)

1. If a third handset, that is another handset than the "old" (the replaced handset) and "new" (the replacement headset) handset, is inserted into the charger during Easy Replacement, this error indication appears. Change to the correct handset.
2. The charger has found that Easy Replacement does not work. Change back to the "new" handset.

LED is flashing red, long flash (800 ms on, 100 ms off)

Error during Easy Replacement. *Both* telephones need to be sent for service.

---

## Operation Notice

### Accessibility and Voice Quality

The base network is not always available. If you do not get in contact with your system, contact your system administrator. For best voice quality, avoid positioning near computer, radio or similar equipment.

#### *Operating Area*

You can only use your handset in the area that is covered by your system. Outside this area you will lose contact with the system. The signal strength icon will be low and "Searching" will be displayed.

#### *Out of Range*

When you leave the system's coverage area a short beep will sound and the text "Searching" will appear in the display.



The out of range beep will be repeated every minute for 30 minutes. You can turn the sound off by long pressing .

When re-entering the coverage area it can take a couple of minutes before the handset automatically has registered into the system.

## Maintenance

### Maintenance of Batteries



#### Battery Warnings

	The "Low battery" icon appears when the battery has 10% or less remaining capacity left. In addition; a warning signal sounds every minute, the LED flashing orange, and the window "Battery low. Charge now." appears.
	The "Empty battery" icon is flashing when the battery has 5% or less remaining capacity left. In addition; a warning signal sounds every second, the LED flashing red, and the window "Battery empty. Shutting down." appears.

During a call, only the corresponding battery warning signal will notify the user. The warning signal cannot be silenced during a call. When not in call, the warning signal can be silenced by pressing .

#### Charge the Battery

Place the handset in the desktop charger or in the rack charger. The battery is being charged when the LED on the handset is steady orange. When the battery is fully charged the LED will be green.

An animated battery icon  is also shown in the display indicating charging by starting with its current charge and ending with the full charge. A filled battery icon  indicates a fully charged battery.



**Note:** Only use the prescribed chargers for charging.

#### Replace the Battery

If the standby time for the handset becomes too low, the battery should be replaced by a new one. Please contact your system administrator or your supplier, for information about new batteries. Attach the battery as described in the illustration below. The battery is easy to replace. It is attached inside the battery lid and is connected to the handset in such a way that no miss-contact is possible.



Figure 11: Easy Replaceable Battery

### Attach the Hinge-type Clip

Attach the hinge-type belt clip as described in the illustration below.

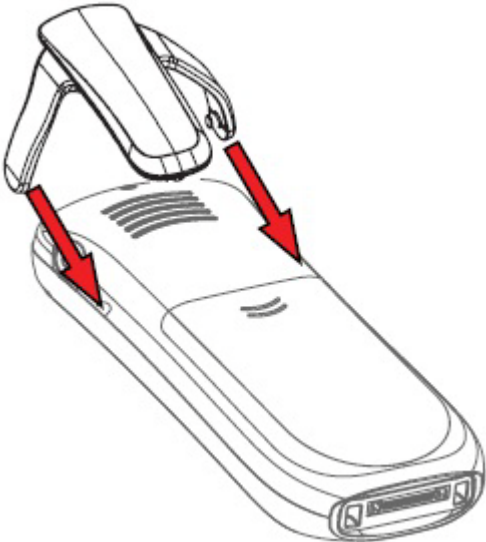
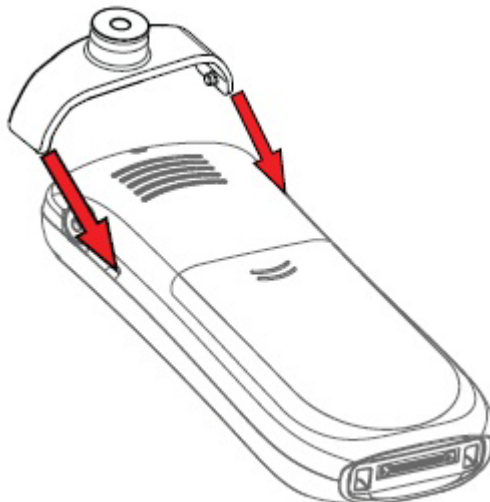

Figure 12: Attach the Hinge-type Clip into Position

## Attach the Swivel-type Clip

Attach the swivel-type belt clip as described in the illustration below.



**Figure 13: Attach the Swivel-type Clip into Position**

## Easy Replacement

Easy replacement can be used if a handset needs to be replaced. The easy replacement procedure is done via the handset display and the 5607 Programmer, or the rack charger.



**Note:** If the electrical connection is damaged, it is not possible to follow the Easy Replacement procedure. Depending on fault, it might work to do a replacement via PDM/Device Manager. See the *Mitel 5603 Wireless Handset Configuration Guide*.

The easy replacement procedure is done via the handset display and the 5603/4 Programmer or the 5603/4 Rack Charger.

The following settings are replaced during easy replacement:

- DECT registration
- User options (including User ID)
- Contacts
- The extension number is assigned to the new handset

The following settings are not replaced during the easy replacement:

- Call list

---

## Before Starting Easy Replacement Procedure

1. Check that both the old handset (that is, the handset to be replaced) and the new handset (that is, the replacement handset) are of the same device type (5603).



**Note:** You can perform Easy Replacement between different product licenses (that is; Basic and Advanced). The new handset's product license is not replaced by the old handset's variant license during the procedure<sup>1</sup>.

2. Make sure that the handset batteries are charged before starting the easy replacement procedure.
3. Switch off the **new** handset by long pressing .

## Easy Replacement Procedure

During the Easy Replacement procedure, the LEDs of the handset and the charger follow the same LED indications. This means that if the old handset has a broken display, the LED indications on the charger and on the handset can be used to follow the replacement procedure. Before and after easy replacement the LEDs may have different LED indications. For more details. See also [LED Indications during Easy Replacement](#) on page 59.

---

**IMPORTANT:** Never remove a handset from the charger until the instructions in the display or the LED tells you to do so (see status on the LED if the display is broken). If an error is indicated you may want to remove the handset. See [Troubleshooting](#) on page 51 for further instructions.

**After you place the old handset in the charger, you must place the new handset in the charger, regardless of whether the replacement was successful or not. Failing to do so may result in malfunction and the new handset will need servicing.**

---

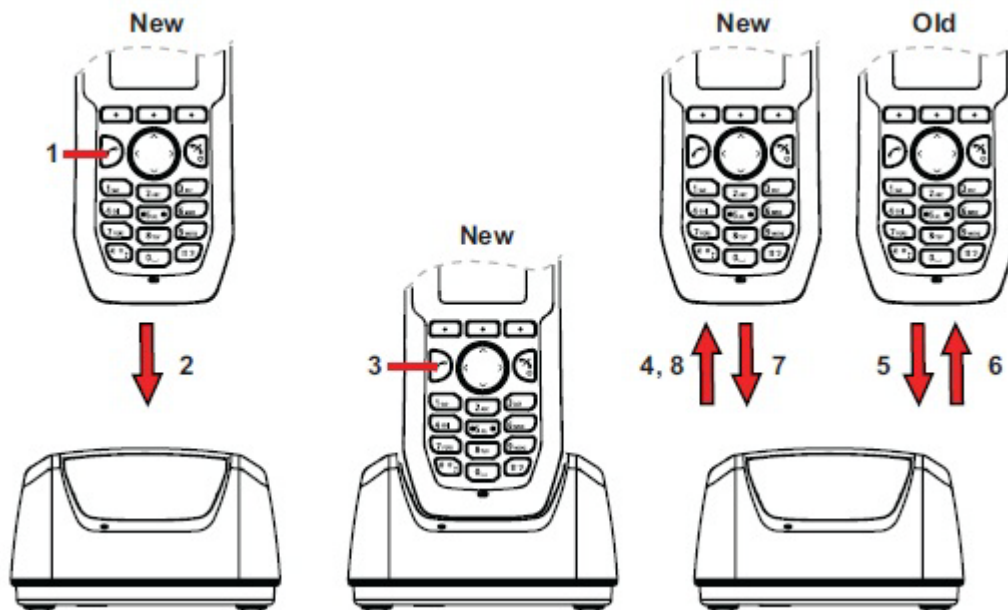





Figure 14: Easy Replacement Procedure using the 5603 Programmer

1	On the <b>new</b> handset, press and hold   <b>Note:</b> Do not release  until you are instructed to do so.
2	Put the new handset in the charger.
3	When the text "Start phone replacement?" appears, release  . Press "Yes" (left soft key). The text "Follow the instructions. Each step can take several minutes." appears in the display. Press "OK"(left soft key).
4, 5	When the text "Please insert old phone in charger" appears, replace the new handset with the <b>old</b> handset. The handset can either be switched on or off.  <b>Note:</b> If the rack charger is used, the <b>same</b> charging slot has to be used for both handsets.  The handset will be restarted and after a few seconds, the text "Saving settings. Do not remove phone from charger" appears. The charger LED changes to slow orange flashing.
<b>IMPORTANT:</b> If the old handset cannot communicate with the charger, put the new handset in the charger to restore its settings (that is, the handset's IPDI). If this step is not performed, the new handset must be sent for service. The old handset's settings might be transferred to the new handset by using PDM. See the <i>Mitel 5603 Wireless Handset User Guide</i> .	
6, 7	When the text "Please insert new phone in charger" appears, replace the old handset with the <b>new</b> handset. The text "Restoring settings" appears.
<b>IMPORTANT:</b> Do not remove the handset while the text "Restoring settings" appears.	
8	When the text "Phone successfully replaced. Please remove phone to restart." appears in the display, remove the handset from the charger. The handset is automatically restarted.



### LED Indications during Easy Replacement

The following table shows the LED indications that are used for the 5603 and the charger during the easy replacement procedure. See also [Troubleshooting](#) on page 51.

LED indication	Description
Orange, flashing (1 000 ms on, 1 000 ms off)	File transfer during Easy Replacement.
Orange, flashing (100 ms on, 800 ms off)	“Change phone” indication during Easy Replacement.
Red, flashing (100 ms on, 800 ms off)	Error indication during Easy Replacement. Put back old portable in charger.
Red, flashing (900 ms on, 100 ms off)	Error during Easy Replacement. Service required for <i>both</i> portables.

### Related Documents

- Mitel 5603 Wireless Handset Configuration Guide
- Mitel 5603 DECT Handset Data Sheet
- Mitel 5603 Wireless Handset Quick Reference Guide
- WSM3 Installation and Operation Guide
- Portable Device Manager (PDM) Windows Version Installation and Operation Guide



---

# Index

**A**

Antenna 3

**B**

Battery 3, 54  
low battery 54

**C**

C (Clear) button 9  
Call info 9, 22, 27, 32  
Calling  
answered call 8  
call a number from the call list 14  
dial a number 14  
missed call 8  
outgoing call 8  
quick call by a name in the phonebook 14  
Case 3  
Centralized phonebook 30  
Clip 3

**D**

Dialling  
International number 14

**E**

Earpiece 3

**H**

Handsfree key 1

**I**

Icons 7

**L**

LED indications 59  
Loudspeaker 3  
Loudspeaking 8, 16

**M**

Menu tabs 8  
Microphone 3  
Mute button 9

**N**

Navigation Key 9  
Number input mode 10

**O**

On/Off button 9  
Operating Area 53  
Out of Coverage 53

**P**

PIN code 43

**R**

Ring signal muted 8

**S**

Screen Saver  
settings 41  
Signal strength 7  
Speed dial 11  
Standby mode  
date 7  
time 7  
user identity 7

**T**

Text input mode 11

**W**

Writing Text/Numbers  
add space in text 11  
pause 10  
upper/lower case 11



---

GLOBAL HEADQUARTERS	U.S.	EMEA	CALA	ASIA PACIFIC
Tel: +1(613) 592-2122 Fax: +1(613) 592-4784	Tel: +1(480) 961-9000 Fax: +1(480) 961-1370	Tel: +44(0)1291-430000 Fax: +44(0)1291-430400	Tel: +1(613) 592-2122 Fax: +1(613) 592-7825	Tel: +61(0) 2 9023 9500 Fax: +61(0) 2 9023 9501

FOR MORE INFORMATION ON OUR WORLDWIDE OFFICE LOCATIONS, VISIT OUR WEBSITE AT [MITEL.COM/OFFICES](http://MITEL.COM/OFFICES)

THIS DOCUMENT IS PROVIDED TO YOU FOR INFORMATIONAL PURPOSES ONLY. The information furnished in this document, believed by Mitel to be accurate as of the date of its publication, is subject to change without notice. Mitel assumes no responsibility for any errors or omissions in this document and shall have no obligation to you as a result of having made this document available to you or based upon the information it contains.

M MITEL (design) is a registered trademark of Mitel Networks Corporation. All other products and services are the registered trademarks of their respective holders.

© Copyright 2014, Mitel Networks Corporation. All Rights Reserved.

mitel.com

