



MiVOICE BUSINESS AND 5000 COMMUNICATIONS PLATFORMS

**IP-DECT SYSTEM (GLOBAL)
MITEL 5604 WIRELESS HANDSET USER GUIDE**

NOTICE

The information contained in this document is believed to be accurate in all respects but is not warranted by Mitel Networks™ Corporation (MITEL®). The information is subject to change without notice and should not be construed in any way as a commitment by Mitel or any of its affiliates or subsidiaries. Mitel and its affiliates and subsidiaries assume no responsibility for any errors or omissions in this document. Revisions of this document or new editions of it may be issued to incorporate such changes.

No part of this document can be reproduced or transmitted in any form or by any means - electronic or mechanical - for any purpose without written permission from Mitel Networks Corporation.

Trademarks

Mitel is registered trademark of Mitel Networks Corporation.

Other product names mentioned in this document may be trademarks of their respective companies and are hereby acknowledged.

IP-DECT System (Global)
Mitel 5604 Wireless Handset User Guide
Release 7.0
June 2014

®,™ Trademark of Mitel Networks Corporation
© Copyright 2014, Mitel Networks Corporation
All rights reserved

About Your Phone	1
Elements of the Handset	3
Features and Functions	4
Chargers	5
Contacting Emergency Services	5
Tips for your Comfort and Safety	6
Frequency Range	6
Exposure to Radio Frequency Signals	6
Environmental Requirements	7
Chemical Resistance	7
Icons and Text in the Display	8
Keys and Buttons	11
Off-hook Key	11
On-hook and On/Off Keys	11
Navigation/Confirmation Key	11
Sound Off Key	11
Mute and PTT Button	11
Key Lock and Upper/Lower Case Key	11
Soft Keys	11
Hot Keys	12
Multifunction Button	12
Volume Button	12
Alphanumeric Keys	13
Headset	14
Customizing Your Phone	15
Switch the Handset On/Off	15
Log a Shared/Hot Desk Phone On/Off	15
Turn On/Off the Audible Signal	16
Lock/Unlock the Keypad	16
Lock/Unlock the Handset	17
Using the Loudspeaking Function	18
Making and Answering Calls	19
Call List	19
Make a Call	19
Pre-Dial	19
Dial Using a Pre-programmed Hot key, Soft key or Multifunction Button	19
Dial a Number from the Call List	20
Dial the Sender of a Message	20

- Dial a Number from the Local Phonebook20
- Dial a Name from the Central Phonebook20
- Dial a Number from the Company Phonebook21
- Answer a Call21
 - Answer a Call21
 - End a Call21
- During a Call22
 - Adjust the Volume during a Call22
 - Open Contacts during a Call22
 - Open Messaging during a Call22
 - Turn the Microphone on/off during a Call22
 - Lock/Unlock the Keypad during a Call23
 - Start a New Call during a Conversation23
 - Declining a Call with a Predefined Message23
- Call Handling for MiVoice Business 25
 - Hold26
 - Transfer26
 - Conference27
 - Answer Call Waiting27
 - Callback28
 - Call Park28
- Advanced Features for MiVoice Business 29
 - Calls29
 - Call Forward30
 - Call Pickup30
 - Do Not Disturb30
 - Direct Page31
 - Group Page31
 - Loudspeaker Page31
- Call Handling for the Mitel 5000 CP 32
 - Hold33
 - Transfer33
 - Conference34
 - Answer Call Waiting34
- Advanced Features for the 5000 CP 35
 - Calls35

Call Operator	36
Config Assistant	36
Reverse Transfer	36
Messaging	37
Message List	37
Receive a Message	37
Incoming Message for 5604 Services License	37
Incoming Message for all 5604's except for 5604 Services License	37
Write and Send a Message	39
Unsent Messages	40
Open a Sent Message	40
Review Inbox Content while Reading a Message	41
Send a Message to Another Destination	41
Receive a Message with Request for Answer	42
Accept/Reject a Message	42
Message Queuing and Message Priority	42
Message Priority and Call Priority	43
Message Indication Repetition	44
Interactive Messaging	44
Colored Messaging	46
Calling while Reading a Text Message	46
Calling the Message Sender	46
Calling a Different Party	47
Message Templates	47
The Templates Menu	48
Answering a Text Message with a Predefined Message	48
Mobile Data	49
Send Mobile Data	49
Send Mobile Data with a Prefix	49
Procedure Call	50
Voice Mail	51
Receive a Voice Mail	51
Check the Voice Mail Inbox	51
One Key Voice Mail Access	51
Alarm Operation	52
Push-button Alarm	52
Acoustic Location Signal	52
Test Alarm	52

- Alarm with Location Information52
 - Alarm with Data53
- Automatic Call after Alarm53
- Menu Tree 54
 - Customizing the Menu Tree54
 - Calls54
 - Contacts55
 - Profile56
 - Messaging57
 - Services57
 - Short cuts58
 - Connections59
 - Settings60
 - In Call61
 - Additional In Call Functions61
- Navigate the Menu 62
 - Connections Menu62
 - Headsets62
 - System62
 - In Charger65
 - Calls Menu67
 - Call List67
 - Missed Calls68
 - Call Time68
 - Push to Talk69
 - Short Cuts Menu71
 - Define a Soft Key71
 - Define a Hot Key72
 - Define a Navigation Key72
 - Define the Multifunction or Alarm Button73
 - Services Menu73
 - Add a Service73
 - Edit a Service74
 - Delete a Service74
 - Messaging74
 - Inbox74
 - Write a New Message75
 - Unsent Messages76

Sent Messages	76
Profiles Menu	77
Contacts Menu	79
Call a Contact	79
Add a Contact	79
Edit a Contact	80
Delete a Contact	80
Central Phonebook	81
Settings Menu	82
Sound and Alert Settings	82
Keypad Lock Settings	84
Phone Lock Settings	85
Display Settings	86
Time and Date Settings	87
Answering	88
Change Text Size for Messages	88
Change the Menu Language	89
Change the Owner ID	89
Advanced Functions	90
Admin Menu	90
Clear Lists in Charger	90
System Handling	91
Software Upgrade and Additional Features	91
Handset Updates via Charging Rack	91
Troubleshooting	93
Operation Notice	96
Accessibility and Voice Quality	96
Maintenance	97
Maintenance of Batteries	97
Battery Warnings	97
Charge the Battery	97
Charge Spare Batteries	97
Replace the Battery	97
Easy Replacement of Handset	98
Before Starting the Easy Replacement Procedure	98
Easy Replacement Procedure	99
Attach the Hinge-type Clip	101

Attach the Swivel-type Clip	101
Attach Cover for No Clip	102
Related Documents	102
Index	103

About Your Phone



Note: Mitel® Communications Director (MCD) product name has been changed to MiVoice Business for release 7.0 and up.

This guide contains feature descriptions for both the Mitel 5000 CP and the MiVoice Business.

- “Call Handling for MiVoice Business” on page 25 and “Advanced Features for MiVoice Business” on page 29.
- “Call Handling for the Mitel 5000 CP” on page 32 and “Advanced Features for the 5000 CP” on page 35.

This document describes the features and settings of the 5604 handset. This feature-rich handset has a color display, telephony, and messaging. It is designed for use in moderately demanding environments, such as hospitals, but also suited to office environments.

The 5604 handset is suited to users who must be readily reached and/or need mobile voice and messaging features. It is ideal for applications where the user needs either one way messaging or needs to interact with other users. The color display enhances and simplifies the use of the handset.

The 5604 Standard DECT Handset can be upgraded with the Services, Personal Alarm, and/or DECT Location licences.

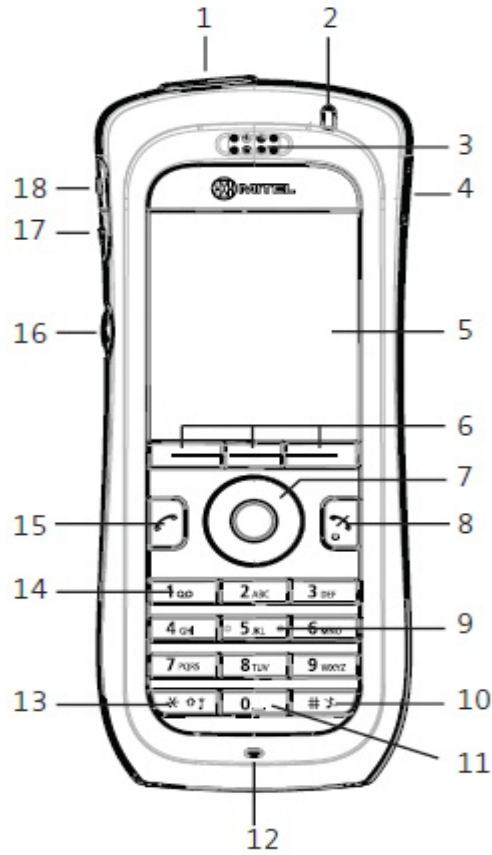

Figure 1:

Caution: The Handset/Headset must be fully charged before starting regular use.

Elements of the Handset

1	Top/Alarm button This button can be used as a short cut to functions; long or double press modes. In the 5604 Personal Alarm license, the button is used as a push button alarm only.
2	LED Indicates incoming call, messaging, low battery, and charging.
3	Earpiece speaker
4	Headset connector The headset connector is for connecting a headset. The connector is protected against dust by using the headset connector cover.
5	Color display The full graphic type display is 128 pixels wide and 160 pixels high. The display has multiple colors and backlighting.
6	Soft keys The 3 Soft keys can be pre-programmed or used with GUI
7	Four-way navigation key Navigation key with Left, Right, Up, Down, and Confirmation (in the middle). It is also possible to program these keys for short cuts, except the middle key.
8	On-hook and On/Off key Combined button; to end a call, to return to standby mode, and to switch the handset on/off by long press.
9	Tactile indicators There are two tactile indicators to indicate the centre of the key pad
10	Sound off key To turn on/off audible signals in idle mode, silencing the ring signal at incoming call, and to turn on/off the microphone during a call. Note: Incoming high priority messages will still be indicated with an audible signal when the handset is muted.
11	Space To add space between text
12	Microphone
13	Key lock and Upper/Lower case Combined key lock and Upper/Lower Case
14	Voice mail access* A quick access to the handset's Voice mail. * System dependent feature
15	Off-hook key To answer a call, to pre-dial a number, and as a short cut to the Call list.
16	Mute and PTT button To turn on/off audible signals in idle mode, silencing the ring signal at incoming call, and to turn on/off the microphone during a call.
17	Volume button (down) To decrease the speaker volume
18	Volume button (up) To increase the speaker volume

Features and Functions

IMPORTANT: The handset may retain small magnetic objects around the mouth cap or ear cap region.

Case

The plastic cover parts are made of durable PC/ABS material.

Antenna

The antenna is integrated inside the handset.

Loudspeaker

The handset has a separate loudspeaker for the Loudspeaker function. It is on the back side of the handset.

Microphone

The microphone is placed on the front bottom side of the handset.

Clip

There are two different belt clip options to the handset: a hinge-type clip (standard), and a swivel-type clip. See “Attach the Hinge-type Clip” on page 101, or “Attach the Swivel-type Clip” on page 101. Use the clip to attach the handset to a pocket or belt. You can use the handset without a clip on. See “Attach Cover for No Clip” on page 102.

Battery

The battery is a rechargeable Li-pol battery, placed under a battery cover. See “Replace the Battery” on page 97.

The battery is fully charged within four hours. See “Charge the Battery” on page 97.

The battery can be charged separately with a special battery charger. See “Charge Spare Batteries” on page 97.

Chargers

Desktop Charger

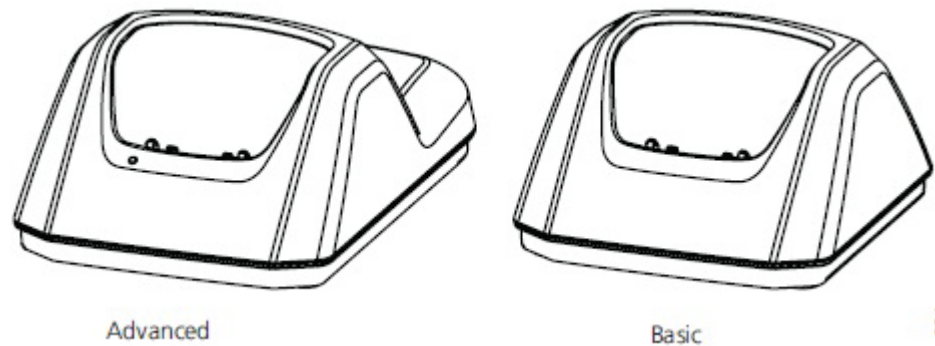

Figure 2: Desktop Chargers

There are two desktop chargers available: a basic one that will only charge the handset, and one with advanced functionality to download new software and to synchronize parameters. The handset is fully operational while placed in the charger.

The charger is delivered with a plug-in power supply and is connected into an ordinary wall socket. For more information, see the *5603/5604/5607 Programmer Installation and Maintenance Guide*.



Note: Use the charger only within the temperature range of +5° C – +40° C.



Caution: Use only the provided power supply. See the *5603/5604/5607 Programmer Installation and Maintenance Guide*.

Rack Charger

The Charging Rack charges six 5603/5604/5607/5624 handsets simultaneously and is used for charging only.

For more information, see the *5603/5604/5607/5624 Rack Charger Installation and Operation Guide*.

Contacting Emergency Services

This handset, like any wireless phone, communicates using radio signals. As with any wireless phone, you may not be able to establish a connection under all conditions; therefore, you should not rely solely on a wireless telephone for essential, emergency communication. The key lock feature disables the handset keypad and prevents the accidental dialing of numbers that may result in nuisance calls. It also prevents accidental calls to emergency services numbers like 911, 999, or 112.

To disable the key lock feature, press the * key and then press **Select**.

If configured, any one of up to five predefined emergency numbers can be called, even if the handset or keypad has been locked.

Currently, mobile IP phones do not support Enhanced 911 (E911) operation. If emergency services are required, it is necessary to keep the system administrator and location database up-to-date.

Tips for your Comfort and Safety

Don't Cradle the Handset!

Prolonged use of the handset can lead to neck, shoulder, or back discomfort, especially if you cradle the handset between your ear and shoulder. If you use your phone a lot, you may find it more comfortable to use a headset. See the section on headset usage elsewhere in this guide for more information.

Protect your Hearing

Your phone has a control for adjusting the volume of the handset receiver or headset. Because continuous exposure to loud sounds can contribute to hearing loss, keep the volume at a moderate level.

Frequency Range

The handset is a radio transmitter and receiver. When it is on, it receives and sends out radio frequency (RF) energy. The handset operates on different frequency ranges depending on market and employs commonly used modulation techniques:

EU	1880-1900 MHz
USA	1920-1930 MHz
LA	1910-1930 MHz
BR	1910-1920 MHz
--	1900-1920 MHz

Exposure to Radio Frequency Signals

This equipment complies with FCC radiation exposure limits set forth for an uncontrolled environment. This device complies with FCC SAR limit of 1.6 W/kg. The maximum SAR value measured when used at the ear and when worn on the body using a belt clip is as follows:

	SAR values
Head	0.072 W/Kg
Body worn	0.036 W/Kg

This device must not be co-located or operating in conjunction with any other antenna or transmitter.

Use of non-Ascom approved accessories may violate the FCC RF exposure guidelines and should be avoided.

Environmental Requirements

DECT Handset

- Only use the handset in temperatures between 0° C to +40° C (32° F to 104° F).
- Avoid exposing the handset for direct sunlight or close to other heat sources.
- Avoid volume levels that may be harmful to your hearing. Exposure to excessive sound pressure from a handset's earpiece or headset may cause permanently hearing loss.
- Do not expose the handset to open flame.
- Keep the handset away from excessive heat and moisture.
- Avoid sudden temperature changes to prevent condensation in the handset. It is recommended to put the handset into an air tight plastic bag until the temperature is adjusted, for example, when entering or leaving a cold/heated building on a warm/cold day.
- Protect your handset from aggressive liquids and vapors.
- The handset may retain small metal objects around the mouth cap or ear cap region.
- If the handset has been exposed for water or condense, remove the battery immediately and let it dry completely before re-inserting the battery.
- Keep the handset away from strong electromagnetic fields.
- Do not place a cold handset in a charger.

Chemical Resistance

The alpha and numeric characters printed on the exterior of the handset have been tested and found resistant to chipping, fading or wearing off when the handset is treated with common cleaners and disinfectants or perspiration. The following chemicals have shown no harmful effect:

- 3% Hydrochloric Acid
- M-alcohol (70% Methylated Ethanol)
- 60% Chlorhexidin 0.5mg/ml

Acetone can be damaging to the plastic casing of the handset and should not be used.

Icons and Text in the Display

All functions and settings available to the user are shown as icons and text in the display. The icons and text in the display indicate functions and settings to which you have access. The display normally displays date and time, the Owner ID and handset number. The Owner ID can manually be set by the user.

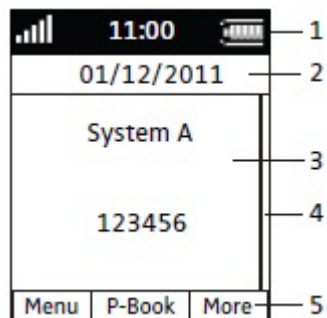

Figure 3: Display Configuration in Standby Mode

The Status bar (1) is used for icons which give the user information about signal strength, missed calls, new messages, phone lock, key lock, sound off, time and battery status. This row is always visible in all screens.

The Header bar (2) displays the current date, headset connection, Bluetooth connection, and system connection.



















The Active area (3) is used for information such as the name of the system to which the handset is connected. A user identity provided from the system and/or an Owner ID can also be displayed if configured in the Settings menu. This is also the area for dialog window text, for example "missed calls", or to confirm an action.

















The Scroll bar (4) is placed to the right of the "Active area". It becomes visible when a menu screen has more than six menus, or if the complete text in a message cannot be displayed on the screen simultaneously.

The Soft key bar (5) is used for soft keys which can be used as short cuts for functions in the handset. See "Soft Keys" on page 11.

Icons

	"Signal strength" icon is visible in the upper left corner. The staples shown in display depend on the signal strength.
	"Full battery" icon appears in upper right corner
	"Low battery warning" icon is shown when the battery has 10% or less remaining capacity left
	"Empty battery warning" icon flashes when the battery has 5% or less remaining capacity

	"Sound off" icon appears when the Sound off key or Mute button is pressed
	The Silent ("Volume 0") icon is displayed when the volume has been set to Silent.
	"Microphone off" icon indicates a silenced microphone. It appears after a long press on the Sound off key, Mute button during a call. During a PTT call, the microphone is silenced when the PTT button is released
	"Loudspeaking" icon appears in the soft key bar during a call. Pressing this icon turns on the loudspeaker.
	"Loudspeaking off" icon appears after the soft key for Loudspeaking icon is pressed. Pressing this icon turns off the loudspeaker.
	"New message" icon or "Interactive message" icon indicates that a new text message (or messages) has arrived. The icon remains in the status bar until all new messages in the inbox are read.
	"Request for answer" icon in front of a message indicates that this message must be acknowledge or rejected
	"Voice mail message" icon appears in the status bar when voice mails are received. The icon remains until you listen to your the voice mail.
	Voice mail message" icon appears in the message box when voice mails are received. The icon remains until you listen to your the voice mail.
	"Read message" icon or "Read Interactive message" icon in front of a message shows that this message once has been read
	"Unsent message" icon
	"Sent message" icon
	"New colored message" icon indicates that a new colored text message(s) has arrived. The messages can be labeled with different colors.
	"Read colored message" icon indicates that a colored text message(s) has been read. The messages can be labeled with different colors.
	"High priority" icon included with New message icon indicates message is of high priority
	"Alarm priority" icon included with New message icon indicates alarm priority of a message
	"Key lock" icon indicates a locked keypad
	"Locked entry" icon indicates that the contact cannot be edited or deleted by the user
	"Phone lock" icon indicates a locked handset

	"Headset" icon indicates that a corded headset is connected to the handset
	"Outgoing call" icon is added to all outgoing calls in the call list
	"Incoming call" icon is added to all answered calls in the call list
	"Push to talk" icon is added to all incoming, outgoing, missed and answered PTT calls in the call list/missed calls Note: The icon is added when a PTT invitation is managed as a call (that is PTT Voice Style) only
	"Missed call" icon is added to all missed calls in the call list
	"Missed call" icon indicates missed calls in the status bar
	"PDM/WSM communication" icon is visible when handset is communicating with PDM/WSM via advanced charger.
	"Profile active" icon
	"Personal Alarm" icon indicates that the handset is a 5604 Personal Alarm license
Menu icons	
	The "Contacts" menu contains all names/numbers in the local phonebook. In addition, a company phonebook* with up to 1000 entries can be downloaded to the handset via the PDM. It is also possible to access a central phonebook* from the "Contact" menu.
	The "Services" menu contains menu short cuts used to customize the phone menu of an individual phone
	The "Messaging" menu contains all message handling such as reading and writing messages
	The "Calls" menu contains call lists, call time, and call services*. Call services is configured in the PDM.
	The "Connections" menu contains headset selection, System selection, and In charger selection
	The "Short cuts" menu contains short cuts for the soft keys, hot keys, navigation keys, and the Multifunction button
	The "Short cuts" menu contains short cuts for the soft keys, hot keys, navigation keys, and the Multifunction button
	The "Profiles" menu allows you to add four different profiles. The "Normal" profile is active by default.

* System dependent.

Keys and Buttons

Off-hook Key



This key is used to answer calls, to pre-dial numbers and as a short cut to the Call list. One short press in standby mode opens the call list.

On-hook and On/Off Keys



This key is used to disconnect calls and return to the main screen. A long press in standby mode switches the handset on/off.

Navigation/Confirmation Key



Use this key to step in the menu and when working in text mode.

◀, ▶, ▲, and ▼ are used for stepping left/right and up/down in the menu. The navigation key can be programmed, the ▲ is by default a short cut to the Inbox, and ▼ is a short cut to Call contact. During a call it is possible to increase/decrease the volume by pressing ▲ and ▼.

Sound Off Key



A long press on the Sound off Key in idle mode toggles between ring signal on/off. When you receive an incoming call, a long press on the key silences the ring signal. During a call, a long press on the key changes between microphone on/off.

Mute and PTT Button



A long press on the Mute button in idle mode changes between ring signal on/off. When an incoming call is received a long press on the button silences the ring signal. During a call, a long press on the button changes between microphone on/off. During a PTT call, the microphone is silenced when the PTT button is released.

Key Lock and Upper/Lower Case Key



This key locks the keypad in combination with the "Lock" soft key. It is also used for switching between upper/lower case and digits.

Soft Keys

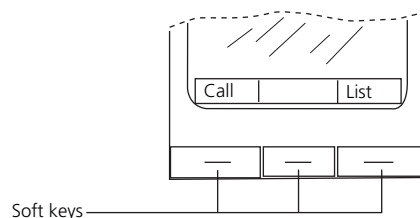

Figure 4: Soft Keys

003

The three soft keys are located just beneath the display. The function of each soft key is indicated by text in the display just above the keys.

In standby mode, the Soft keys can be used for specific functions defined by the user of the handset.

Hot Keys

Any key "0", "2" - "9" can be set to a Hot Key. A long press on any of these numbers in stand by mode provides a short cut to the Call contact list. The list is in alphabetic order. Which key you press depends on where the contact appears in the list.

A hot key can be programmed to give access to frequently used functions such as dialing a specific handset number, a short cut on the menu, or sending an SMS.

Multifunction Button



Note: This feature does not apply to 5604 Personal Alarm license.

This button can be used as a short cut to functions and has long and double press modes as defined by the user of the handset. If the button is defined, it can be used in standby mode only.

Volume Button

The two buttons placed on the upper left side of the handset are used for increasing/decreasing the earpiece, headset, and loudspeaker volume.

Alphanumeric Keys

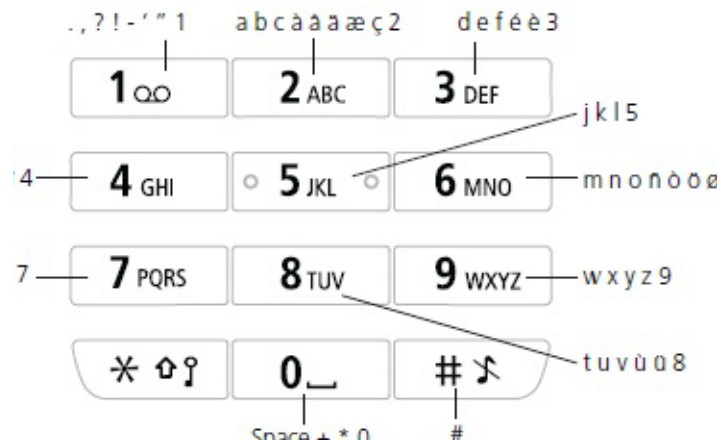

Figure 5: Available Characters



Note: Depending on the selected menu language, other characters can be available. This means that the character order can differ from the table above.

In Standby Mode, and Number Input Mode

- A short press on a key enables you to enter the digits “0” - “9” and the characters * and #.
- You enter a pause in the number input mode by a long press on the # key. A pause is indicated by a "P" in the display.
- A long press on the * key changes the tone sender. Tone sender On is indicated by a "T" in the display.

In Text Input Mode

- A short press on a key 0-9, displays the first available character on that specific key. The marked character is selected after a timeout, or when another key is pressed.
- You change to upper/lower case, by pressing the * key before entering the character. The * key can also be used to display only the digits.
- To add space in the text, make a short press on key 0.
- The first character entered in a message, or when adding/editing a name in the Contacts menu, will be an upper level character followed by lower level characters (unless the * key is pressed before you enter the character). To switch between Abc, ABC, abc, and 123 you press the * key.
- A long press on the #-key displays special characters.
- When entering text, press and hold the * key to display a list of languages. This makes it possible to switch writing language while entering text.



Note: Switching languages works only if the DECT base station is configured to support it.

Headset

If you will use your handset frequently, we recommended you use a headset so you have both hands free. The headset comes in three versions; microphone integrated in the cable, microphone on a boom and hearing protection.

In order to achieve optimal audio quality with your headset we recommend you select the corresponding headset profile.



Note: It is possible to configure the headset button with a specific function, such as hook off, dial last called number, or dial a predefined number. See the *Mitel 5604 Wireless Handset Configuration Guide* for more information.

The default setting is microphone on a boom, that is, the audio is optimized for using a headset with microphone on a boom. The headset profile can be changed in the menu by do as follows:

1. Enter the menu by pressing the "Menu" soft key, or the confirmation button on the Navigation key.
2. Select "Connections".
3. Press "Select", or the confirmation button on the Navigation key.
4. Select "Headset".
5. Select the corresponding headset profile from list, that is, "Mic on boom", "Mic on cable", or "Hearing protection".
6. Press "Select", or the confirmation button on the Navigation key.

If the pre-configured headset profiles do not match the headset in use, or the audio performance is bad, it is possible to configure an own headset profile. This is done in the PDM, see the *Mitel 5604 Wireless Handset Configuration Guide*. If an own profile is configured in the PDM, it will be selectable in the handset menu.

Customizing Your Phone

Switch the Handset On/Off



Note: If a handset restriction is enabled, it might not be possible to switch off the handset. See the *Mitel 5604 Wireless Handset Configuration Guide*.

When the handset is switched off:

1. Press and hold the On-hook key .

When pressing the On-hook key, the handset vibrates and the display lights up.

2. A dialog window "Switch on?" appears.
3. Press "Yes" to confirm.

When the handset is in idle mode:



Note: If the handset is a shared/Hot Desk phone, it must first be logged out to be able to switch off the handset. See "Log a Shared/Hot Desk Phone On/Off" on page 15".

1. Press and hold the On-hook key .

The "Switch off?" window appears.

2. Press "Yes" to confirm.

Log a Shared/Hot Desk Phone On/Off



Note: This feature requires that the parameter "Phone mode" is set to "Personal". See the *Mitel 5604 Wireless Handset Configuration Guide*.

The shared/Hot Desk phone feature allows more than one user to use a handset. When a handset is configured to be a shared phone/hot desk, it can be used by any shared phone/hot desk user in the system. The message and call lists are deleted when a user logs off of a handset.

Log on a Handset

Before you log on to the handset ensure it has been switched on. See "Switch the Handset On/Off" on page 15 for more information.

1. If your handset display is lit, you will see "Please Login."
2. Press any key. The "Login?" prompt appears.
3. Press "Yes".
4. Enter your extension number and user PIN.
5. Press "Login"

You are logged in and will see your extension number in the idle display.



Note: If the IP-DECT system supports Hot Desking and the feature is enabled in the handset via PDM/Device Manager, the handset's call list will also be downloaded to the handset. Calls made by the same person with other devices over the same IP-DECT system will be listed.

Log off a Handset

1. Press and hold .
2. When the "Logout?" window appears, press "Yes".

If the "Logout in Charger" option is selected, either on the handset or via PDM, the user is logged out when the handset is placed in the charger.

A user is also logged out from the handset when logging on using a different device but the same user account.



Note: If a phone is shared and one of the users logs off the shared phone/hot desk, the lock that prevents the handset from unauthorized use is deactivated. For additional information, see *Lock/Unlock the Handset* on page 17.

Turn On/Off the Audible Signal

A long press on the  or  in idle mode toggles the ring signal on/off.

The  icon indicates a silenced handset.

Lock/Unlock the Keypad

Lock/Unlock the Keypad in Idle Mode

You can lock keys to prevent you from accidentally pressing them.

Lock the Keypad

1. Press .
2. Press "Lock".

Unlock keypad

1. Press .
2. Press "Yes".



Note: You can answer/close an incoming call and/or press the alarm button while the keypad is locked. If configured in the PDM, you can call a pre-defined emergency numbers while the keypad is locked. See the *Mitel 5604 Wireless Handset Configuration Guide*.

Lock/Unlock the Keypad during a Call

To prevent accidentally pressing keys you can lock keys during a call. This is useful when wearing a headset and a handset attached to a pocket or belt.

Lock the Keypad

1. Press .
2. Press "Lock".

Unlock the Keypad

1. Press .
2. Press "Yes".



Note: You can press the volume buttons and the mute button during the call. If the 5604 Personal Alarm license is used it is also possible to press the alarm button.

Lock/Unlock the Handset

The handset can be protected for unauthorized use. If this function is activated, a PIN code has to be entered for example to switch on the handset, to answer an incoming call, etc. The default phone lock code (0000) can be changed to any 4 - 8 digit personalized code.



Note: If a phone is shared and one of the users logs off the shared phone/hot desk, the lock that prevents the handset from unauthorized use is deactivated. For additional information, see *Log a Shared/Hot Desk Phone On/Off* on page 15.



1. Enter the "Settings" menu. See "Settings Menu" on page 82.
2. Select "Locks"
3. Select "Phone lock".
4. Select "Auto phone lock"
5. Select "On", "On in charger", or "Off".
6. Enter your PIN code.
7. Press "OK".



Note: If configured in the handset, any predefined emergency number can be called while the handset is locked. See the *Mitel 5604 Wireless Handset Configuration Guide*. If the 5604 Personal Alarm is used, the Alarm button can also be used.

Using the Loudspeaking Function



There are several options to activate the loudspeaking function:

- Press a Navigation key, Hot key or Soft key defined as short cut to a Phone call  function. When pressing the key, a predefined number is called, see "Short Cuts Menu" on page 71.
- When receiving a call, press the soft key 
- During a call, press the soft key 

This function can also be activated by selecting another answering method, that is, "Automatically" and/or "Loudspeaking" See "Answer a Call" on page 21.

Making and Answering Calls

Call List

1. Press "Menu",
2. Select "Calls" .
3. Select "Call list".
4. Select a number.
5. Press  or the "Call" soft key to dial. The number can be edited before the call is dialed. Press "More" and select "Edit number". The 25 last received, dialed or missed calls are stored in a call list. See "Calls" on page 29.

Make a Call

Pre-Dial

Enter the number and press  to get the line. The number is shown on the display while dialing. If required, you can press the Soft key "Clear" to erase the number. You can use the navigation key to step and add/delete a digit in the middle of a number.

An international number can be dialed from the handset by entering a + character followed by the country code and local number. To enter the + character, long press the 0 key until the character is shown in the display.



Note: The + character cannot be entered and international numbers cannot be dialed in the following circumstances:

- If the 0 key has been configured as a hot key.
- If the handset has been set up to perform advanced functions normally used by a system administrator, as described in *Admin Menu* on page 90.

You can turn on the tone sender in a pre-dialed number by making a long press on the * key.

Dial Using a Pre-programmed Hot key, Soft key or Multifunction Button



Note: The Multifunction button does not apply to the 5604 Personal Alarm license.

The Multifunction button, hot keys, and soft keys can be programmed with a handset number. Press the pre-programmed hot key, soft key or Multifunction button to dial the number. The call will automatically be connected.

Dial a Number from the Call List

1. Press .
2. Select a number and press  or the "Call" soft key to dial.

The number can be edited before the call starts.

3. Press "More".
4. Select "Edit number".

Dial the Sender of a Message

You can call the sender of a message stored in the message list, from the Messaging menu.

1. Open the menu by pressing the confirmation button, or the soft key "Menu".
2. Select "Messaging".
3. Select "Inbox".
4. Select a message from the list.
5. Select "View".
6. Select "More".
7. Select "Call sender".

Dial a Number from the Local Phonebook

1. Press "Menu".
2. Select "Contacts".
3. Select "Call contact".
4. Select contact from list, or search name/number by entering characters in the "Search" field.
5. Press the "Call" or the Off-hook soft key to make the call.

Dial a Name from the Central Phonebook

1. Press "Menu".
2. Select "Contacts".
3. Select "Central phonebook".
4. Select "Search by name".
5. Enter the first name and/or the last name. The whole name does not have to be entered.
6. Press "Search".
7. Press the "Call" or the Off-hook soft key to make the call.

Dial a Number from the Company Phonebook

1. Press "Menu".
2. Select "Contacts".
3. Select "Call contact".
4. The local and company phonebook appears in the same list but the company names are indicated by a "Locked entry" icon  in front of the name. Select a contact from the list or search for the name/number by entering characters in the "Search" field.
5. Press the "Call" or the Off-hook soft key to make the call.



Answer a Call

The flashing LED, accompanied by a ring signal and/or a vibrating handset, give you notice of a call. Ring signal and vibrator can be disabled. The calling party's handset number or name is shown. The name will be shown if the calling party's handset number is stored in the local phonebook. Press the Off-hook key to answer the call. When a headset is connected to the handset, the answering button on the headset can be used to answer the call.

Other answering methods can be specified in the Settings menu. See "Settings" on page 60. The answering methods are Automatically and Loudspeaking.

When "Automatically" is enabled, all incoming calls are connected automatically.

Answer a Call

When the signal sounds press  to answer the call, or press the  soft key to answer the call in loud-speaking mode. The name/number of the calling party appears if calling line information is available.



Tip: When a headset is connected to the handset, the answering button on the headset can be used to answer the call.

A call may also be answered in the following ways:

- Automatically and Loudspeaking: When Automatically is enabled, all incoming calls are connected automatically. For additional information, see *Settings* on page 60.
- With a predefined message. This lets the use decline the call, but still acknowledge its receipt, by sending a predefined text message to the caller. See *Answering a Text Message with a Predefined Message* on page 48.

End a Call

Press  to end the call. The duration of the call is shown in the display. The total time of the call can also be retrieved from the Calls menu > Call time.

During a Call



Note: Some of these functions are system dependent. The parameters are set up in the Portable Device Manager (PDM). See *Mitel 5604 Wireless Handset Configuration Guide*, and *Portable Device Manager (PDM) Installation and Operation Guide*.

If the handset is configured via PDM/Device Manager, it is possible to call a predefined emergency number while the handset/keypad is locked. When calling from a locked handset, it is only possible to access the Microphone on/off function by pressing the soft key "More". However, the entire ' menu is accessible when calling from a handset with locked keypad.

Adjust the Volume during a Call

Press the "Volume up" button to increase the volume, and the "Volume down" button to decrease the volume. The handset will now store and keep the new volume level. It is also possible to use the navigation key, ▲ and ▼ to adjust the volume.

Open Contacts during a Call

1. Press the "More" soft key.
2. Select "Contacts".
3. Press "Select".
4. Select "Call contact" to search a local or company phonebook contact, or select "Central phonebook" to search a central phonebook contact.
5. Press "Select".
6. Select a contact.



Note: You can call the selected contact by pressing "Call". When calling the contact, the first call will be put on hold. See "Start a New Call during a Conversation" on page 23.

Open Messaging during a Call

The Messaging menu can be accessed during an ongoing call by pressing the soft key "More".

1. Press the soft key "More" during the call.
2. Select "Messaging".

See "Messaging" on page 37 for more information about messaging.

Turn the Microphone on/off during a Call

1. Press "More".
2. Select "Microphone off".
3. Press "Select".

The icon  indicates a silenced microphone. This means that the other part in an ongoing call cannot hear you.

To turn the microphone back on:

1. Press "More".
2. Select "Microphone on".
3. Press "Select".

It is also possible to turn the microphone off/on by a long press on .

Lock/Unlock the Keypad during a Call

To prevent accidentally pressing keys, you can lock the keys during a call. This can be useful when a headset is used and the handset is attached to a pocket or belt.

Lock the Keypad



1. Press .
2. Press "Lock".

Unlock the Keypad

1. Press .
2. Press "Yes".

You can press the volume buttons and the mute button during the call. If the 5604 Personal Alarm license is used, it is also possible to press the alarm button.

Start a New Call during a Conversation

1. Press "More".
2. Select "New Call".
3. Press "Select".
4. Enter number, or press  to access the phonebook.
5. Press .

Declining a Call with a Predefined Message

A call may be declined with a predefined message by the called party provided that both parties are connected via an IP-DECT system. To decline a call with a predefined message when the handset rings, perform the following steps:

1. In response to the "Reply with a message template?" prompt, press the "Yes" soft key to send a message to the caller. A list of predefined messages is displayed in the "Templates" menu.
2. Select, and if required, edit the message as described in *The Templates Menu* on page 48.

3. Click the soft key "Send". The calling party number is displayed in the handset display.
4. Click the soft key "Send". A "Message sent" confirmation is displayed and the message is sent to the caller.

Call Handling for MiVoice Business



Tip: These feature descriptions apply to the use of the 5604 Wireless Handset on MiVoice Business. For information on the Call Handling features on the Mitel 5000, see "Call Handling for the Mitel 5000 CP" on page 32.

During a call you may need to use features, such as Hold, Transfer, Conference, Call Swap, Callback, and Call Park.

You access these features during a call by pressing the "More" soft key. It displays the "In Call" menu depicted in the following image.

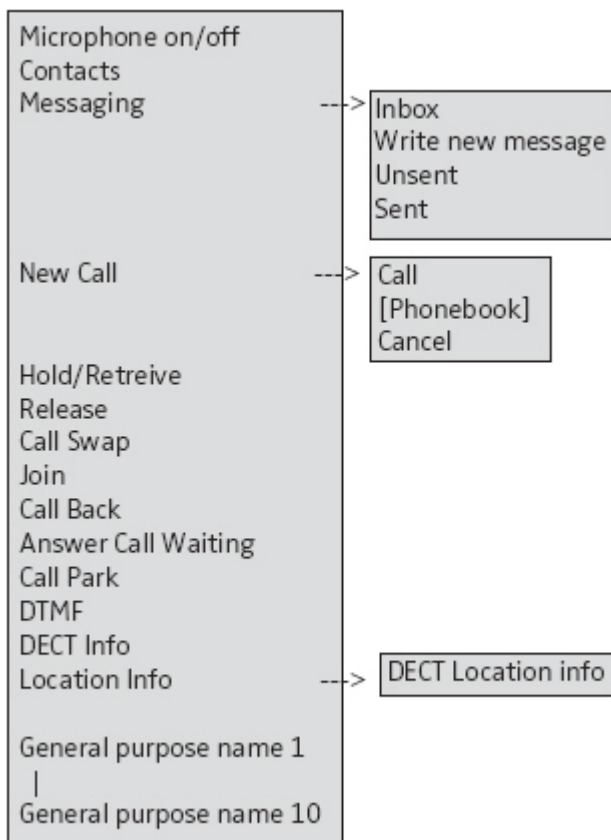

Figure 6: Accessing Features

Note: Some functions are system dependent and/or require configuration in the handset via PDM/WSM3.

You can also use these features by pressing the "R" key on the handset during a call. The following table lists the In-Call menu features and associated feature access code methods.

In-Call Menu under More	Associated Feature Access Code
Contacts	
Microphone off	
New Call	R
Hold/Retrieve	R
Release	R4
Call Swap	R2
Join	RR + *80
Call Back	5
Answer Call Waiting	R2
Call Park	RR + *7#

Hold

1. Press the "More" soft key.
2. Select "Hold/Retrieve" to put the call on hold.

Retrieve a Held Call

1. Press "More".
2. Select "Hold/Retrieve" to retrieve the call.

Transfer

1. Press "More".
2. Select "New Call".
3. Dial the number to which you want to transfer the call and then press "Call".
4. Do one of the following:
 - to make a blind transfer, select "Release" to hang up and connect the other two parties.
 - to make a supervised transfer, wait for an answer, announce the transfer, and then select "Release" to hang up and connect the other two parties.
 - to terminate the transfer and return to the held call, press "More" and then select "Call Swap".

Conference

To conference in another party while on a call:

1. Press "More"
2. Select "New Call" to put the current call on hold.
3. Dial the number of the third party.
4. Wait for an answer.
5. Press "More".
6. Select "Join".

Answer Call Waiting

Depending on system setup and configuration, Call Waiting may be handled in one of two different ways:

Method 1

If a second caller calls during a phone call, the handset will beep and display the text "Internal call" for internal callers and "External call" for external callers. The handset will also show the name or phone number of the second caller. To answer the second caller:

1. Press the soft key "Accept".

The text "Switch" briefly appears on screen, and the handset transfers to the second call. The first call is put on hold.

2. When finished speaking with the first caller, select the "More" soft key.
3. Select "End Call".

The second call is closed and the first call is retrieved.



Note: It is possible to reject a second call by pressing the "Decline" soft key. The second caller will hear a busy tone, and the call will be logged as a missed call in the handset.

Method 2

While on a call, if you hear a call waiting beep:

1. Press "More"
2. Press "Answer Call Waiting" to answer the incoming call.
3. Press "Select". The new call is now connected, and the first call is on hold.

When the line is free, the call on hold will automatically be dialed again. This is a system-dependent feature.

Callback

Callback lets you request that the system notify you when a busy extension becomes available.

To request a callback when a number/extension is busy:

1. Press "More".
2. Select "Call Back".
3. Press "Select".
4. Press "On-hook" and wait for the handset alert.
5. Press "Off-hook" to answer the call.

Your extension will ring when the called extension becomes free and automatically dial the extension back.

Call Park

The Call Park feature allows you to place a call in a special hold state. You, or someone else, can then retrieve the call from any extension in the system. After parking the call, the system can automatically connect you to paging equipment so that you can announce the call to the requested party.

To park a in-progress call:

1. Press "More".
2. Select "Call Park".
3. Dial the directory number on which to park the call.
4. Inform the called party of the waiting call.

To retrieve a parked call:

1. Press "Call -> Call Services".
2. Select "Call Park - Retrieve" and enter the directory number on which the call is parked.

Advanced Features for MiVoice Business



Tip: These feature descriptions apply to the use of the 5604 Wireless Handset on MiVoice Business. For information on the Advanced features on the Mitel 5000, see “Advanced Features for the 5000 CP” on page 35.

Calls

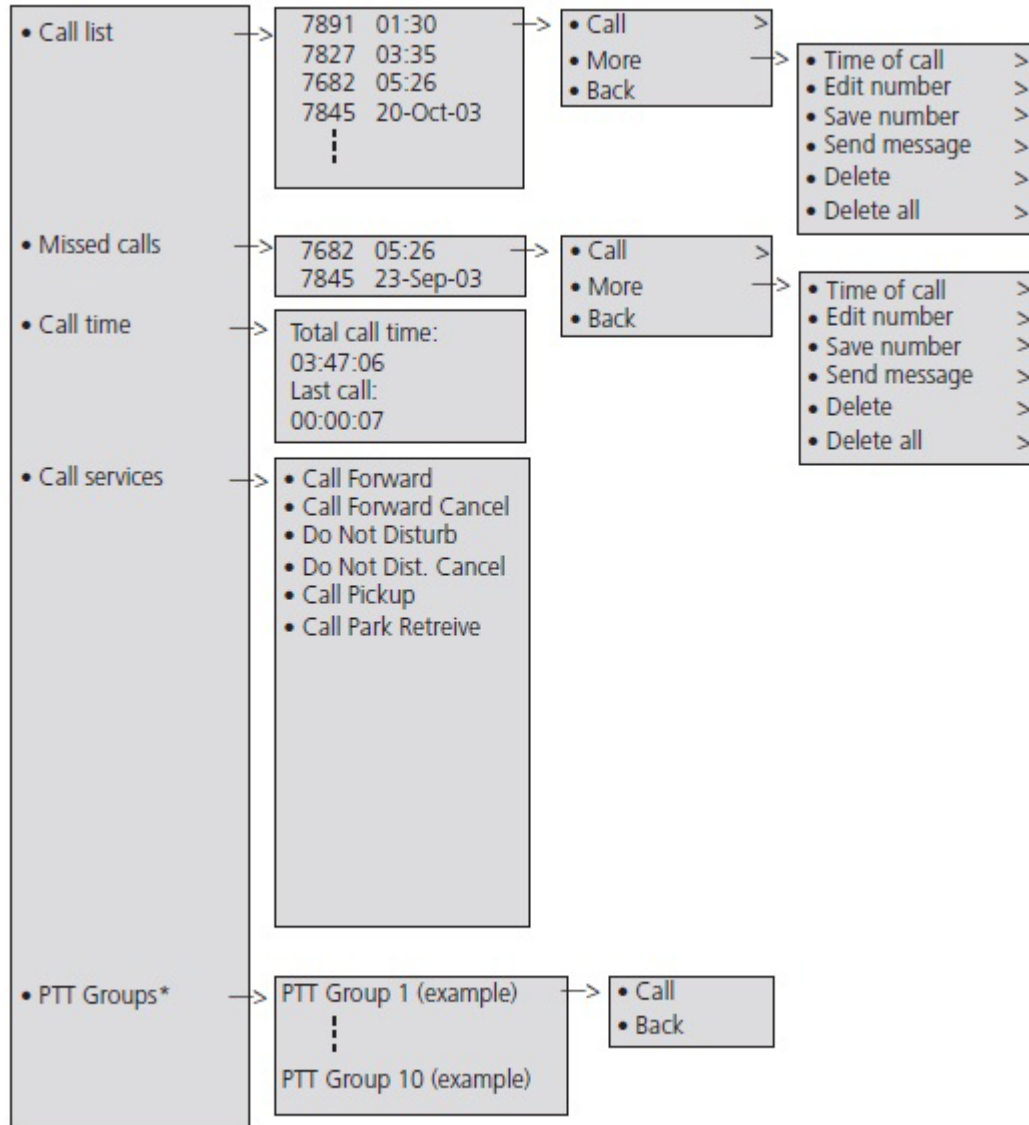

Figure 7: Calls Menu

* Visible if defined in the PDM

The following features are available from the Calls, Call Services menu:

- Call Forward

- Call Forward Cancel
- Do Not Disturb
- Do Not Disturb Cancel
- Call Pickup
- Call Park Retrieve
- Direct/Group Page
- Loudspeaker Page

To access the Call Services menu:

- Press "More".

Call Forward

To set Call Forwarding:

1. Press "More".
2. Select "Call Forward".
3. Enter the extension number to which you will forward your calls.
4. Press "Call".
5. Listen for a confirmation tone and then hang up.

To cancel call forwarding:

1. Press "More".
2. Select "Call Forward Cancel".
3. When you hear a re-order tone, press  to hang up.

Call Pickup

To answer a call that is ringing at another station in your Pickup Group:

1. Press "More".
2. Select "Call Pickup".
3. Answer the call.

Do Not Disturb

To activate Do Not Disturb:

1. Press "More".
2. Select "Do Not Disturb".
3. When you hear a re-order tone, press  to hang up. Do Not Disturb is activated.

To deactivate Do Not Disturb:

1. Press "More".
2. Select "Do Not Dist. Cancel".
3. When you hear a re-order tone, press  to hang up.

Do Not Disturb is deactivated.

IMPORTANT: Do not select an option from the active call menu during any of the Paging features. The options are not applicable and your call will be terminated if selected.

Direct Page

Direct Paging allows you to page a party through the party's hands free speaker.

1. Press "More".
2. Select "Direct/Group Page".
3. Dial the extension number.
4. Announce the page.

Group Page

Group Paging allows you to page a group of telephones through their built-in speakers.

1. Press "More".
2. Select "Direct/Group Page".
3. Do one of the following:
 - To page your prime page group, press #.
 - To page a specific page group, dial the page group directory number.
4. Speak to the dialed party after the tone.

Loudspeaker Page

1. Press "More".
2. Select "Loudspeaker Page".
3. Dial the paging zone number, if required.
4. Wait for the ring back and announce the page.



Note: Ask your Administrator for the paging zone number.

Call Handling for the Mitel 5000 CP

 **Tip:** These feature descriptions apply to the use of the 5604 Wireless Handset on the Mitel 5000 CP Release 6.0 and higher.

During a call you may need to use features, such as Hold, Transfer, Conference, and Call Swap.

You access these features **during a call** by pressing the "More" soft key. It displays the "In Call" menu depicted in the following image.

Note: These options are visible if the Mitel 5000 menu template has been installed on the 5604 Wireless Handset. The default menus reflect the features that operate with MiVoice Business.

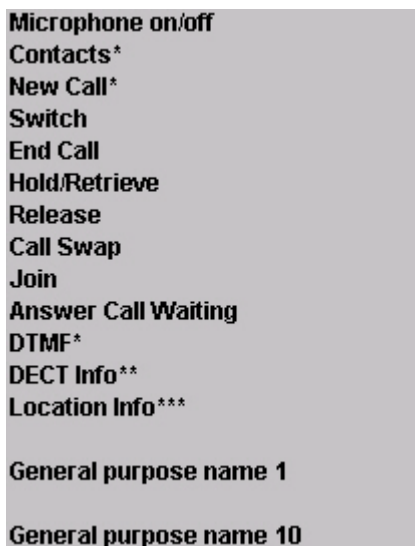

Figure 8: Accessing Features

* Visible if enabled/defined in the PDM/WSM3

** Visible if the Admin menu is activated.

*** Visible if the Admin menu is activated. You require the DECT location license.

You can also use these features by pressing the "R" key on the handset during a call. The following table lists the In-Call menu features and associated feature access code methods.

In-Call Menu under More	Associated Feature Access Code
Contacts	
Microphone off	
Hold	R
New Call	R
Release	R4
Join	RR + (5)
Answer Call Waiting	R2
Call Swap	R2
Switch	R2
End Call	R1

Hold

1. Press the "More" soft key.
2. Select "Hold/Retrieve" to put the call on hold.

Retrieve a Held Call

1. Press "More".
2. Select "Hold/Retrieve" to retrieve the call.

Transfer

1. Press "More".
2. Select "New Call".
3. Dial the number to which you want to transfer the call and then press "Call".
4. Do one of the following:
 - to make a blind transfer, select "Release" to hang up and connect the other two parties.
 - to make a supervised transfer, wait for an answer, announce the transfer, and then select "Release" to hang up and connect the other two parties.
 - to terminate the transfer and return to the held call, press "More" and then select "End Call".

Conference

To conference in another party while on a call:

1. Press "More"
2. Select "New Call" to put the current call on hold.
3. Dial the number of the third party.
4. Press "Call".
5. Wait for an answer.
6. Press "More".
7. Select "Join".

Answer Call Waiting

If a second caller calls during a phone call, the handset will beep and display the text "Internal call" for internal callers and "External call" for external callers. The handset will also show the name or phone number of the second caller. To answer the second caller:

1. Press the soft key "Accept" or press R2.

The text "Switch" briefly appears on screen, and the handset transfers to the second call. The first call is put on hold.



Note: It is possible to reject a second call by pressing the "Decline" soft key. The second caller will hear a busy tone, and the call will be logged as a missed call in the handset.

Advanced Features for the 5000 CP

 **Tip:** These feature descriptions apply to the use of the 5604 Wireless Handset on the Mitel 5000 CP Release 6.0 and higher.

Calls

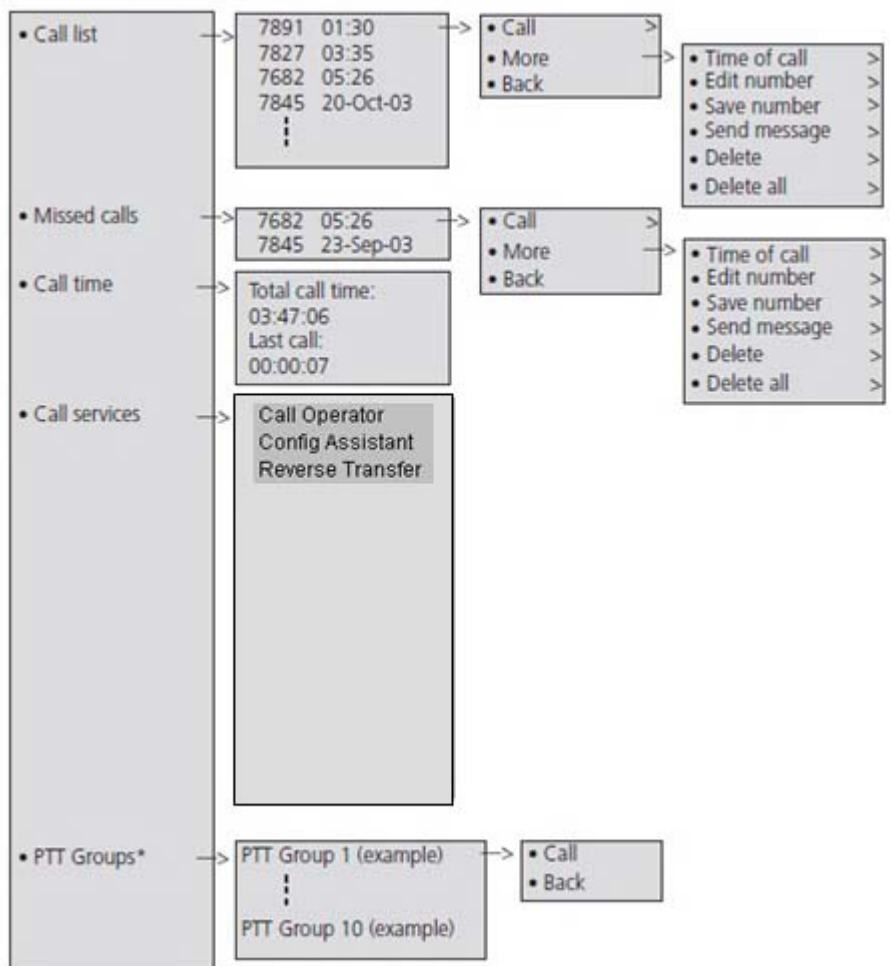

Figure 9: Calls Menu

* Visible if the 5000 CP menu template has been installed on the 5604 Wireless Handset. The default menus reflect the features that operate with MiVoice Business. It may be necessary to re-program the feature access codes to match the codes used on the 5000 CP.

The following features are available from the Calls, Call Services menu:

- Call Operator
- Config Assistant

- Reverse Transfer

To access the Call Services menu:

- Press "More".

Call Operator

To call your switchboard operator:

- Press "More".
- Select "Call Operator"

Config Assistant

Configuration Assistant allows you to access a voice-guided configuration portal that provides easy-to-use, remote access to the following phone configuration options:

- Dynamic Extension Express
- DND
- Manual Call Forwarding
- Meet-Me Conferencing

To use Config Assistant:

- Press "More".
- Select "Config Assistant"

Follow the voice prompts to make the changes to the required features.

Reverse Transfer

You can use Reverse Transfer (Call Pick Up) to answer calls that are ringing or holding at other extensions. For example, if you receive a call while you are away from your desk, you can pick up the call from another extension.

To use Reverse Transfer:

1. Press "More".
2. Select "Reverse Transfer"
3. Dial the extension or hunt group number where the call is ringing or holding. The call is transferred to the phone you are using and you are connected to the caller.

Messaging

Message List

The thirty last received messages are stored in a list. The message list is located in the Messaging menu "Inbox". Time and date information is included in the message.

Receive a Message

Incoming Message for 5604 Services License

When a text message is received, the LED starts flashing and the message alert signal sounds. The "New message" icon, and the content of the received message are automatically displayed. The icon will remain in the display until all new messages are opened. If the message is received during a call a beep notifies the user.

It is possible to reply, forward the message, call the sender and call number included in a text. It is also possible to read the message later by selecting "Close". A received message is stored in the Inbox.

Incoming Message for all 5604's except for 5604 Services License

When a text message is received, the LED starts flashing and the message alert signal sounds. The "New message" icon, and a text with information of received message are displayed. The icon will remain in the display until all new messages are opened. If the message is received during a call a beep notifies the user.

You can select "Yes" to read the message and reply to it, forward it, call the sender, or call the number in text. Alternately, you can select "No" and read the message later. The message is stored in the Inbox.



Note: New messages and information about incoming calls can be displayed upside down. This can be useful if you wear the handset in a belt and want to read the message/call information without rotating the handset. When pressing any key, the messages will be displayed in the normal way. See the *Mitel 5604 Configuration Guide* for more information.

Read a Stored Message

1. Press "Menu".
2. Select "Messaging".
3. Select "Inbox".
4. Select a stored message from the list.
5. Press "View".

Reply to a Message

1. Press "Reply".
2. Enter message.
3. Press "Send".
4. if required, edit the number.
5. Press "Send".

Delete a Message(s)

1. Select "Inbox".
2. Select a message to delete.
3. Press "More".
4. Select "Delete"
5. Press "Yes" to confirm.

Forward a Message

1. Select "Inbox"
2. Select a message.
3. Press "View".
4. Press "More".
5. Select "Forward"
6. If required, write additional text.
7. Enter the number to which you will forward the message or press the middle soft key to open the phonebook and select a number.
8. Press "Send" to forward the message.

Call the Sender of the Message

1. Select "Inbox".
2. Select a message.
3. Press "More".
4. Select "Call sender".

Call a Number Included in a Message

If the sender has written a number in the message you can call the number without dialing it.

1. Select "View".
2. Select "More".
3. Select "Call no. in text"¹.

4. Select a number in the list.
5. Press "Call".

Save a Number

1. Select "Inbox".
2. Select a message.
3. Select "View".
4. Press "More".
5. Select "Save number".
6. Select "Work number", "Mobile number", or "Other number".
7. Add a name and press "OK".
8. Press "Save".

The number will be added to the contact list.

Write and Send a Message

A message can be constructed from scratch, or from a predefined template that can be used as it is or edited. For additional information about message templates, see *Message Templates* on page 47. The maximum message length is normally 140 characters but may be less depending on the character set used.

The first character entered is always upper-case, followed by lower-case character. However, this may be overridden by pressing the * -key before entering the character.

When pressing a key, the first available character for that key is displayed, see See *Alphanumeric Keys* on page 13. To enter the other characters supported by the key, press the key until that character appears in the display.

The keys 0-9, * or # can be used. Keys 0 and 1 contains special characters, see See *Alphanumeric Keys* on page 13 to see all characters.

For example, to enter the character E, press key 3 twice. "E" appears in the display and is selected after a timeout or when another key is pressed.

To delete a character, press "Clear".

To construct and send a message, perform the following steps:

1. Select  .
2. Select "Write new message".
3. Write the message from scratch or select a message template by pressing the "More" soft key and, if required, edit the message as described in *The Templates Menu* on page 48.

1. This option is visible only if the number consists of a minimum of 3 digits.



Note: The "More" key is not displayed if no message templates have been defined.

4. Press "Send".
5. Enter the call number.
6. Press "Send" to send the message.

Unsent Messages

1. Select  in the menu.
2. Select "Unsent" to view the list.
3. Select message to edit/send.
4. Select "Edit", edit text and/or just select "Send".

Delete/Delete All

1. Select  in the menu.
2. Select "Unsent"
3. Select message in the list.
4. Select "More".
5. Select "Delete" or "Delete all".
6. Select "Yes" if the unsent message(s) shall be deleted.

Open a Sent Message

1. In the "Messaging" menu
2. Select 
3. Select "Sent".
4. Select message.
5. Press "View" to read the message.

Forward message

1. Select  in the menu.
2. Select "Sent" to view the list.
3. Select message in the list.
4. Press "View".
5. Enter additional text if needed.
6. Enter number, or press the middle soft key to access contacts in the local phonebook and the company phonebook.

7. Select "Send".

Delete Message

1. Select  in the menu.
2. Select "Sent" to view the list.
3. Select message in the list
4. Press "View".
5. Select "Delete".
6. Select "Yes" to delete the message.

Delete/Delete All

1. Select  in the menu.
2. Select "Sent" to view the list.
3. Select "More".
4. Select "Delete" or "Delete all".
5. Select "Yes" if the message(s) shall be deleted.

Review Inbox Content while Reading a Message

To review the content of the inbox while reading a received message, perform the following steps:

1. Press the "More" soft key
2. From the pop-up menu, select "Inbox". The message summaries contained in the inbox are displayed.
3. To return to the message previously being read, press the "Back" soft key.

Send a Message to Another Destination

1. In the "Messaging" menu, select "Inbox" or "Sent".
2. Select message.
3. Press "More".
4. Select "Forward".
5. Press "Send".
6. Enter the number.
7. Press "Send".

Receive a Message with Request for Answer

In the status bar, a message with request for answer is indicated the same way as an ordinary message, see “Receive a Message” on page 37.

In the message list, the message with request for answer is indicated by the  icon.

Accept/Reject a Message

Press the soft key “Accept” or “Reject”.

When an acknowledged message has been replied to, the icon  is shown in the message list. The text “Accepted” or “Rejected”, and time and date is also added to the acknowledged message.



Note: The option “Delete” is not available for a message with request for answer. An unacknowledged message can be deleted only from the message list.

Message Queuing and Message Priority



Note: This feature applies to the 5604 Services license only.

The default settings is that each message will be displayed without being interrupted by another message, except if the new message is of higher priority. Messages that are not shown yet are placed in a queue and the priority and time of reception determine the position in the queue. There are 9 levels of the priority. 1 is highest priority and 9 is lowest priority.

If several of the messages have the same priority the message that was received first is shown first. If a new message with a higher priority is received while another message is read the new message will replace the old message in the display. The old message will be placed in the queue. If a new message with equal or lower priority is received while another message is read the new message will be placed in the queue.

You can specify how long a message will be displayed. See the *Mitel 5604 Wireless Handset Configuration Guide*.

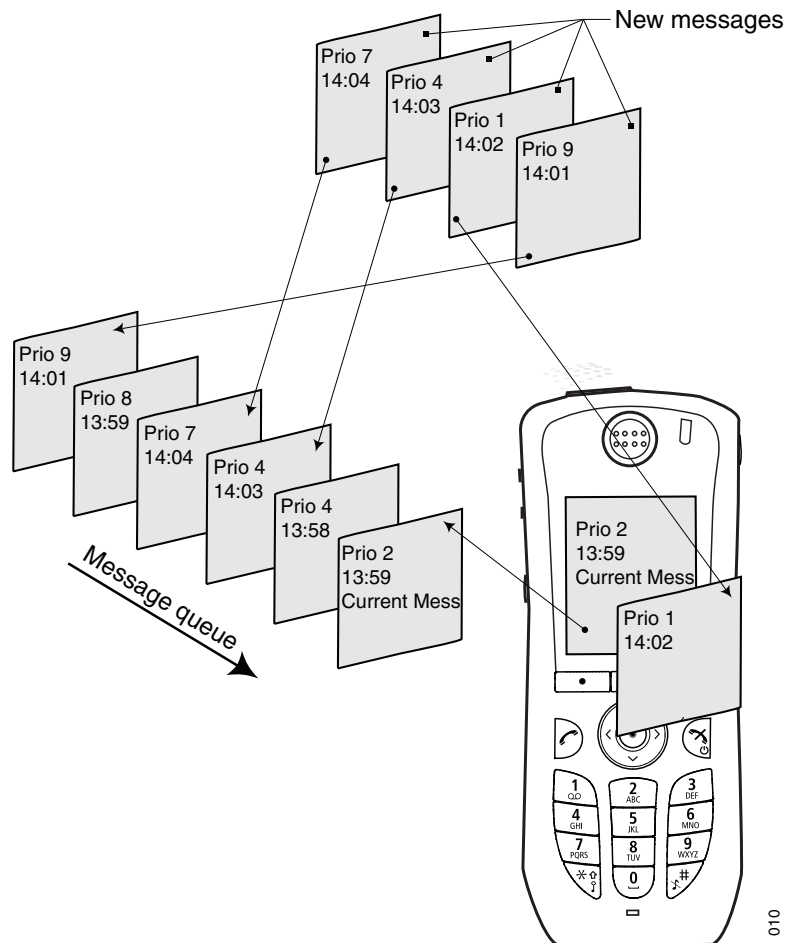

Figure 10: Message Queuing and Priority

Message Priority and Call Priority

Note: This feature requires settings in the PDM/Device Manager. See the *Mitel 5604 Wireless Handset Configuration Guide*.

The default setting is that the call information dialog always shall be visible in front of a message at incoming calls. It is possible to configure if a message with a certain priority shall be displayed without being interrupted by a call. By setting a call priority, the handset compares the call priority with the message priority in order to determine which information to be displayed, that is, the call information dialogue or the message. If the message priority and the call priority are equal, the message will be displayed.

Message Indication Repetition

By default, when a new message is received/displayed, the LED starts flashing green once and the message alert signal sounds. It is possible to configure the handset to repeat the alert signal for an unread message every 7th second as long it is displayed. See the *Mitel 5604 Wireless Handset Configuration Guide* for message settings.

Priority 1 messages with certain system-defined properties are handled as extra important and therefore will the alert signal be repeated every 10th second in 5 minutes, or until any key is pressed. Note that this is a system/application dependent feature and cannot be configured in the handset.

Interactive Messaging



Note: This system dependent feature applies to the 5604 Services license only.

Interactive Messaging (IM) is a function that extends basic messaging. It makes it possible for a user of a handset to access information from a client application in the system.

For example, customized applications can be accessed from the handset. A list of actions can be included in the message sent from the application to the handset.

An IM is indicated and viewed the same way as an ordinary message, see "Receive a Message" on page 37. It is saved along with other messages in the message list.

When you read an IM it can display several options. Mark the appropriate IM and press "Select". If the selected option requests input, enter the information required and press "OK". Pressing the middle soft key changes the mode to digit or text input depending on the format of the message. A read message is indicated the same way as an ordinary message.



Note: If a handset receives an IM update and the original message was deleted, the handset sends a negative acknowledge (NAK) to the system.

Figure 9 illustrates a basic interactive message. The options depend on the configuration of the client application.



Figure 11: Interactive Message

Mobile data from the handset can instruct the application to send the interactive message. See “Mobile Data” on page 49. You can then select an action from the list, such as sending a message back to the application and/or dialing a specific number.

Colored Messaging



Note: This is a system dependent feature for the 5604 Services license only.

You can send colored messages to handsets. The application sending the message determines the color of the message. Colored messaging is useful for categorizing messages. In figure 12, there are two colored messages—a new message, and a read message—in the message inbox (left in the figure). The messages are indicated by a gradient color bar behind the envelopes. When reading a message, a gradient color bar is appears below the envelop (right in the figure).

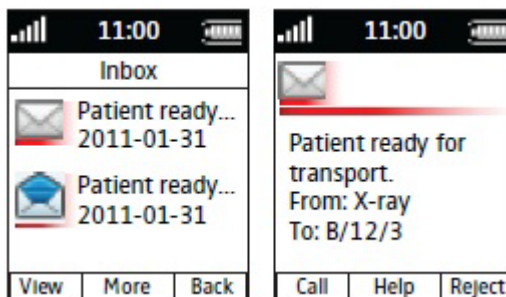

Figure 12: Colored Message

To enable colored messaging, see the corresponding manual for the application used. In addition, colored labels can be mapped to message beep codes. See the *IP-DECT WSM Installation and Operation Guide*.

Calling while Reading a Text Message

A user can make a call while reading a text message to review and discuss the message with the called party. The called party may be either:

- The message sender, that is, the same party that sent the text message
- A different party.

The user can activate the loudspeaker function during the call to make it easier to read the received text message while talking to the called party.

Calling the Message Sender

To call the message sender while reading and reviewing a received text message, perform the following steps:

1. Receive the text message and call the message sender as described in *Call the Sender of the Message* on page 38.
2. Wait for the called party to reply. The message is replaced by the ongoing call details. The user may now:
 - Continue with the call without referring back to the received message.

- Redisplay the message and continue the call to further review and discuss the message. See *Redisplay the Message and Continue with the Call* on page 47.
- Redisplay the message and terminate the call. See *Redisplay the Message and Terminate the Call* on page 47.

Calling a Different Party

To call another party to read and review a received text message, perform the following steps:

1. Open the message and press the "More" soft key.
2. From the pop-up menu, navigate to the "Call" menu item and press the "Select" soft key. The pre-dial screen is displayed. Enter the number of the party to be called or select a number from the handset call list or local or central phone books.
3. Press the "Call" soft key and wait for the called party to reply. The message is replaced by the ongoing call detail. The user may now:
 - Continue with the call without referring back to the received message.
 - Redisplay the message and continue the call to further review and discuss the message. See *Redisplay the Message and Continue with the Call* on page 47.
 - Redisplay the message and terminate the call. See *Redisplay the Message and Terminate the Call* on page 47.

Redisplay the Message and Continue with the Call

1. To redisplay the message while the call is ongoing, select the "More" soft key.
2. From the pop-up menu, select "Messaging".
3. From the Messaging menu, select "Inbox". The received message summary is displayed.
4. Press the "View" soft key to display the message in full. If required, use the four-way navigation key to scroll up and down a long text message to reveal the content while reviewing and discussing the message with the called party.

Redisplay the Message and Terminate the Call

1. Press . The call is terminated and the ongoing call summary details are replaced by the redisplayed text message.

Message Templates

Predefined messages contained in message templates can be used in a number of different situations to quickly construct a message rather than having to construct the message completely from scratch.

Up to five predefined messages can be configured for the handset in the PDM/Device Manager. This lets the user select and send a message appropriate to the current situation, such as "I am in a meeting" or "I am in the operating theatre".

How to use the PDM/Device Manager to create store predefined messages the handset is described in the Message Templates section of the *Mitel 5604 Wireless Handset Configuration Guide*.

Before a message is sent, the user may edit, add, or remove text from the message. For example, the message "I am in a meeting" could be appended with " - please call back after 1500".

The message template function can be used in the following contexts:

- When a call is received that the user wishes to decline, but still acknowledge with a message, without having to type a completely new message. See *Declining a Call with a Predefined Message* on page 23.
- When a text message is received that the user wishes to answer with a text message without having to type a completely new message. See *Answering a Text Message with a Predefined Message* on page 48.
- When the user is writing a message using the handset Messaging function without having to type a completely new message. See *Write and Send a Message* on page 39

The Templates Menu

To access a template and use it in one of the ways described above, perform the following steps:

1. Open the "Templates" menu as described in the context in which the template is being used.
2. Select the required message from the "Templates" menu.
3. To edit the message, use the handset navigation key to move to different parts of the message, the handset key pad to add additional text, and the "Clear" soft key to delete unwanted text

Answering a Text Message with a Predefined Message

To respond to an incoming text message with a predefined message, perform the following steps:

1. Press the soft key "Reply"
2. Press the "More" soft key. The "Templates" option is displayed.
3. Press the soft key "Select". A list of predefined message templates is displayed.
4. Navigate to the required message template and press the "Select" soft key. If required, edit the message as described in *The Templates Menu* on page 48.
5. Press the soft key "Send". The message sender's number is displayed in the handset display.
6. Press the soft key "Send". A "Message sent" confirmation is displayed and the message is sent to the caller.

Mobile Data



Note: This is a system dependent feature for the 5604 Services license only.

Send Mobile Data

You can send user entered data from the handset by pressing a pre-programmed hot key or soft key, or selecting a service. Mobile data can be used for actions such as opening a door, or starting or stopping a machine. The data can either be predefined, or entered after the hot key/soft key is pressed or service is selected.

The data can be predefined when programming the soft/hot key or service. See “Define a Soft Key” on page 71, “Define a Hot Key” on page 72, or “Add a Service” on page 73.

Send Mobile Data with a Prefix

Mobile data with a prefix is sent from the handset by entering data and then pressing a pre-programmed hot key or soft key or selecting a service. Mobile data with a prefix can be used to send information to an application in the system.

You define the prefix when you program the hot/soft key or service. See “Define a Hot Key” on page 72.

Procedure Call

When configuring the functions Call services, In Call menu, Contacts, or a shortcut/service to the Phone call function, the data added in these functions is static. When entering the data for the function to be used, it is possible to add a variable/character U that allows the user to enter additional numerical characters before calling the number/sending the data to a system.

See the following example for more information.

Example of configuration:

A user wants to create a service with the Phone call function. The PBX requires that a prefix must be added to a phone number. In this case, the user can pre-program the prefix and then enter the applicable phone number when using the Phone call function.

1. Press "Menu", or the confirmation button.
2. Select "Services".
3. Select "Add new".
4. In the Name field, enter "Call no.".
5. Select the function "Phone call".
6. In the Number field, enter the prefix to be used followed by the character "U". In this case, the text string is as follows *21*U. The character U represents an Enter number dialog where the user can enter the phone number.
7. Press "Save".

When using the function, an Enter number dialog appears. If the user enters "123" (or selects a contact with this number by pressing ) and presses "OK", the number *21*123 will be dialed. Note that no call is established before the user presses "OK", that is, post-dial.

Voice Mail



Note: This feature is available only if configured in the system.

Receive a Voice Mail

When receiving a voice mail, the content of the voice mail notification appears automatically on the screen, and is also indicated by the “Voice mail message” icon  in the status bar.

If the content of the notification appears, press “Call” to dial the voice mail. If “Close” is selected, you can dial the voice mail by a long press on digit key “1” in standby mode or from the Inbox menu.

Information is stored in the “Messaging” inbox until you listen to the voice mail messages.

Check the Voice Mail Inbox

The voice mail is indicated by a “Voice mail message” icon  in the front of the voice mail message, and is also displayed first in the inbox list.

1. In the “Messaging” menu, select “Inbox”.
2. Select the voice mail message.
3. Press “View”.
4. Press “Call”.

Voice mail will be displayed with one entry in the message list regardless of the number of voice mail received.

One Key Voice Mail Access

A long press on digit key “1” in standby mode will call your voice mail. If the extension number is not available the “Voice mail number not defined” window appears.



Note: Some systems require the mailbox extension number to be downloaded to the handset. See the *Mitel 5604 Wireless Handset Configuration Guide*.

Alarm Operation



Note: The following system dependent features apply to the 5604 Personal Alarm license only. See the *Mitel 5604 Wireless Handset Configuration Guide*.

Push-button Alarm

You press the red alarm button twice within two seconds to activate the alarm. By default the text “Personal Alarm” appears. The alarm is sent to the alarm centre that distributes it further. After that the handset returns to stand-by mode. Note that you can always trigger the alarm when you are speaking, editing your settings, or while the handset is locked.

Acoustic Location Signal

An alarm can be followed by an Acoustic Location Signal (ALS). The ALS is a signal from the handset that sounds for a predefined period of time. You silence the signal by pressing the Mute button on the handset.

Test Alarm

If you press and hold the red alarm button until the (default) “Test Alarm” text appears the following occurs depending on the options specified:

- A beep is heard.
- The orange LED flashes twice.
- The vibrator stirs.
- The handset receives a notification that the alarm has been received by the system.
- If configured, the Acoustic Location Signal (ALS) is activated after the alarm has been sent, or a call is established to a pre-defined number.

If the parameter “Silent alarm” is set, ALS will not be triggered and you will not be notified that the alarm was sent.

- information about the handset’s location is sent along with the alarm.

Alarm with Location Information

Information about the handset’s location can be sent along with an alarm. The location can be added as follows;

- Manually added (see “Alarm with Data” on page 53), or
- An approximately location given by the closest Base Station (see the *Mitel 5604 Wireless Handset Configuration Guide*) or

- A precise location given by the DECT location devices (see the *Mitel 5604 Wireless Handset Configuration Guide*).

Alarm with Data

You must manually define and store the data. To use the function, one soft/hot key/Navigation key in the handset must be defined as a shortcut to the menu "Edit alarm data". See "Short Cuts Menu" on page 71. The stored data is added to all types of alarm at transmission.

Automatic Call after Alarm

You can configure a handset to call a pre-defined number after an alarm has been sent. Depending on the settings, the call can be established in the following modes;

- loud-speaking mode, or
- Monitor mode, or
- Normal mode.

See the *Mitel 5604 Wireless Handset Configuration Guide* for more information.

Menu Tree

Customizing the Menu Tree

You can customize the menu tree, hiding any functions that you do not use. The functions to be hidden are defined in the PDM. See the *Mitel 5604 Wireless Handset Configuration Guide*.

Calls

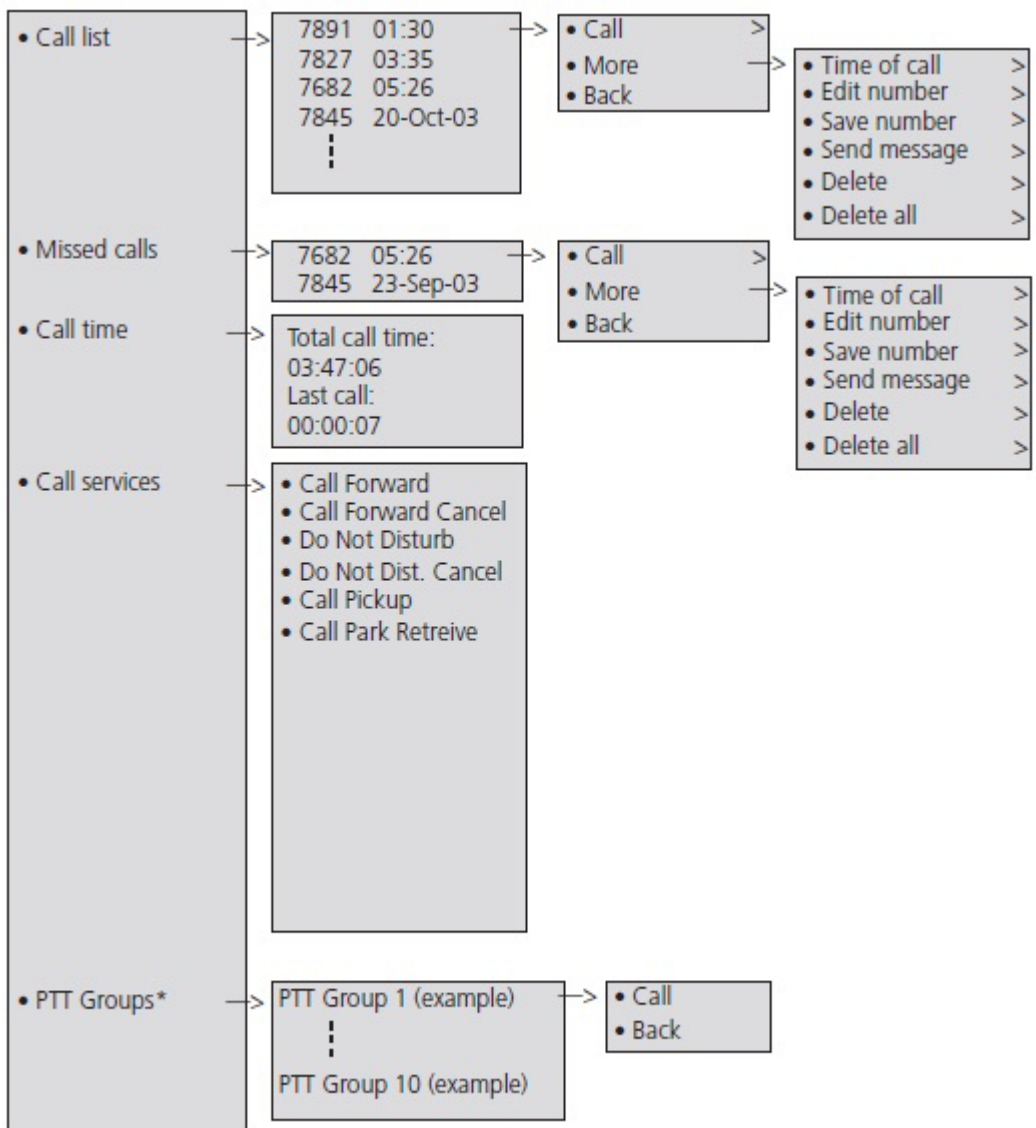

* Visible if defined in the PDM

Contacts 

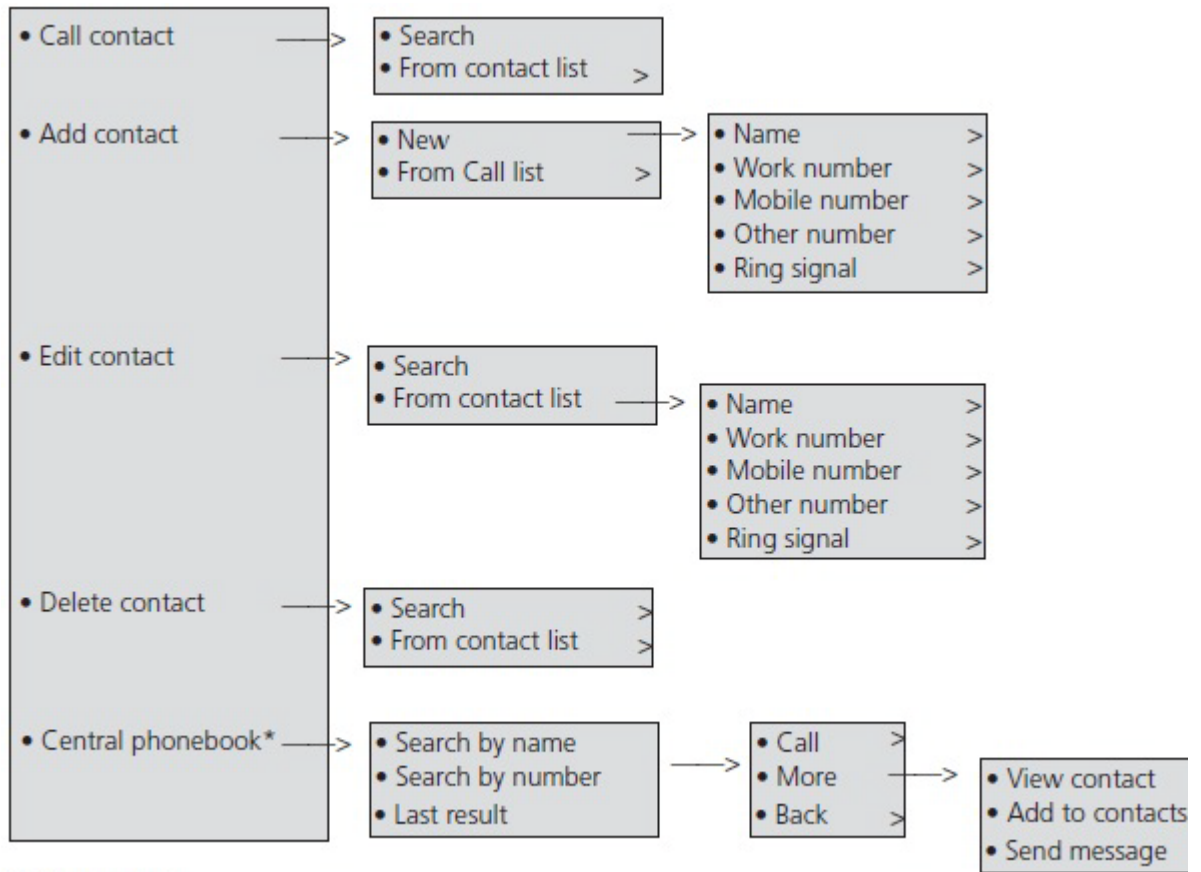

* System dependent

Profile

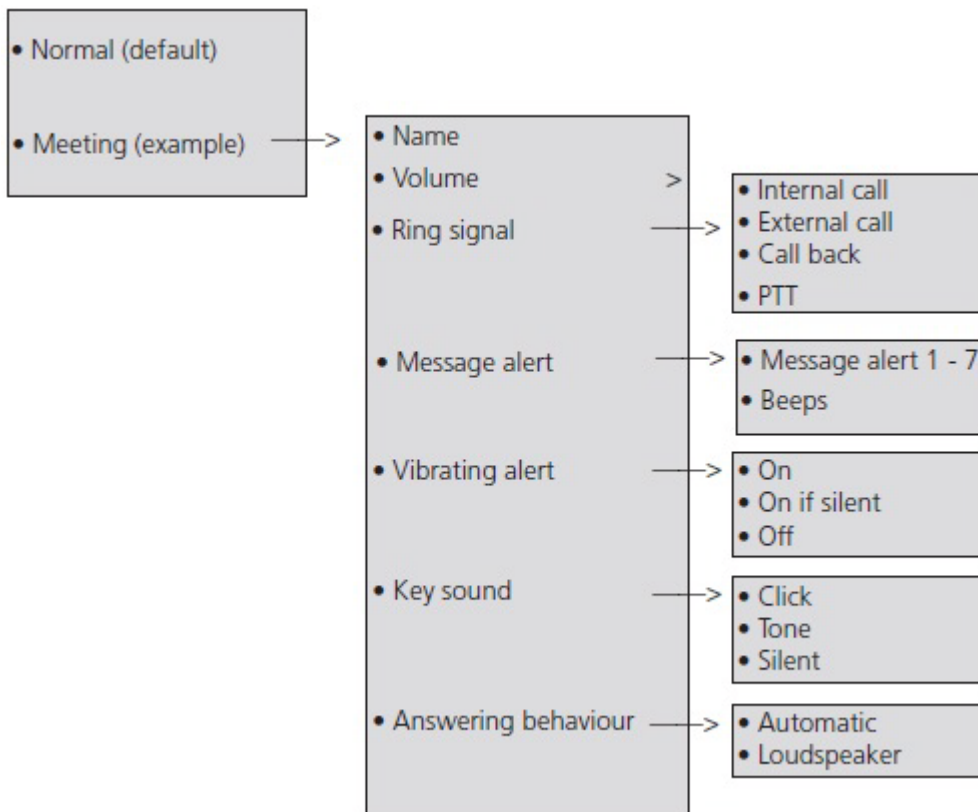

This profile does not contain all of the applicable settings.

Messaging 

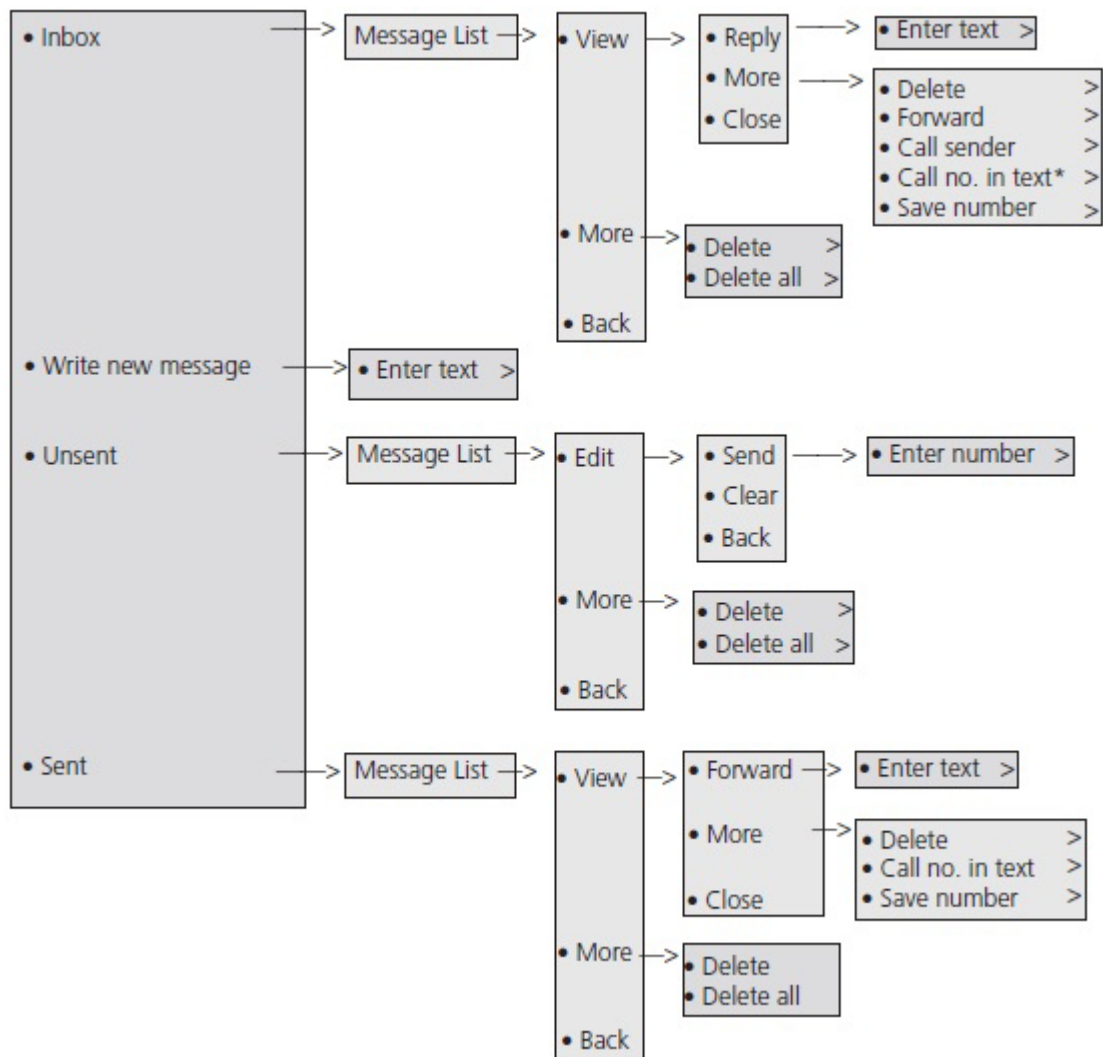

* Visible if the number consists of a minimum of 3 digits

Services 

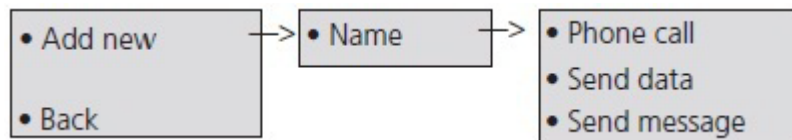

Short cuts

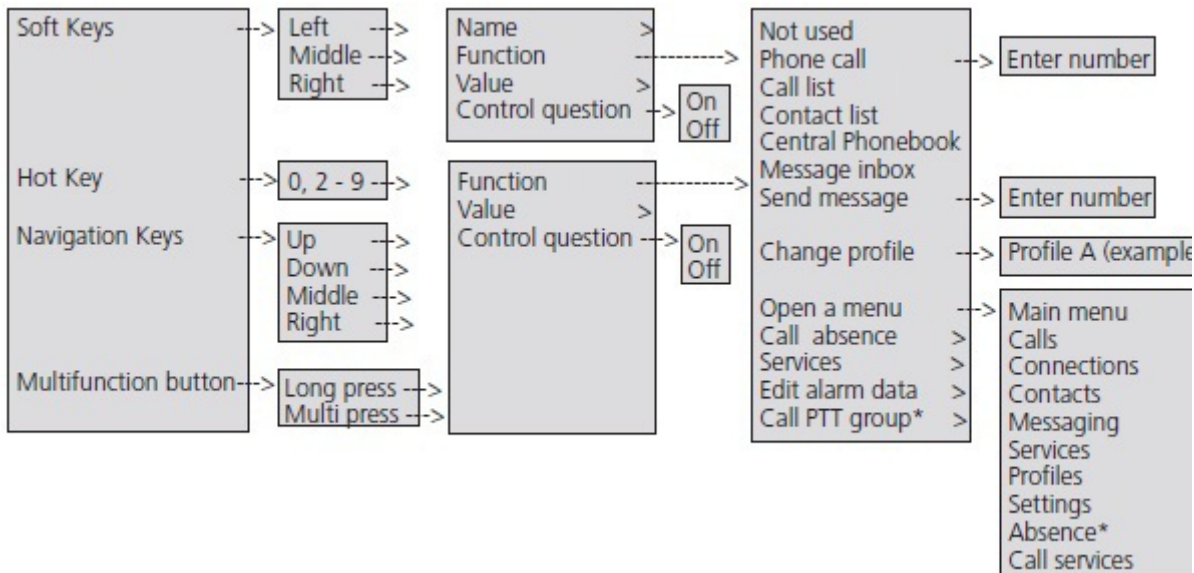

* Visible if defined in the PDM

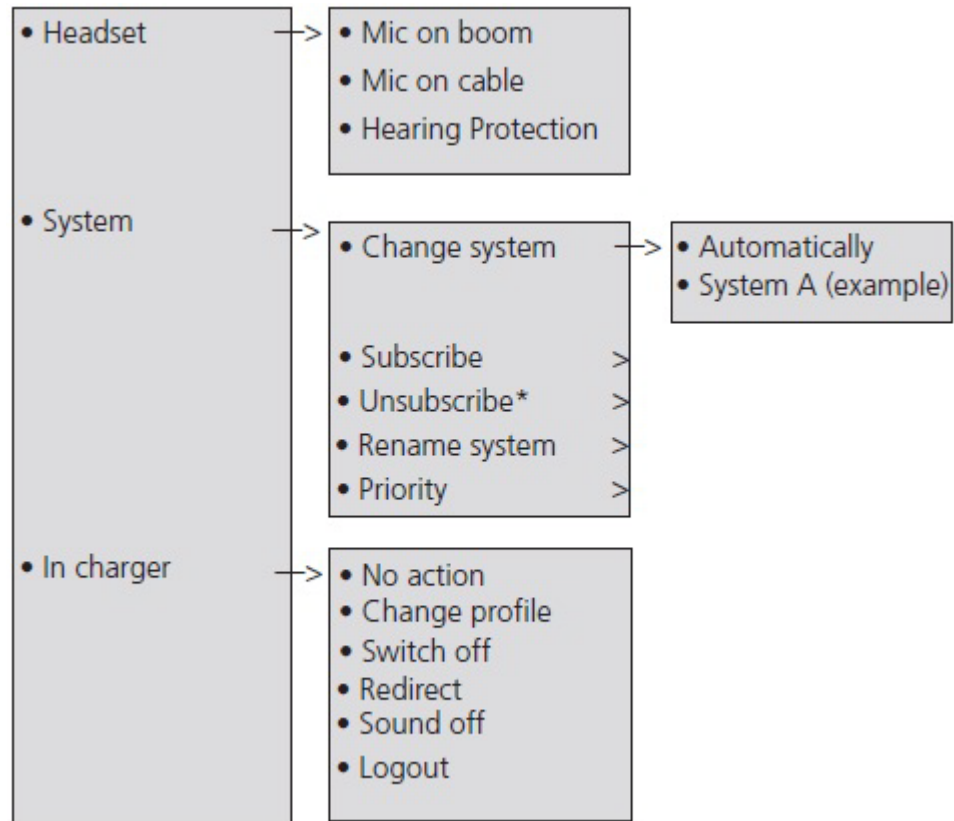
Connections 

You cannot unsubscribe a protected system using the System menu: use the Admin menu or the DECT system.

Settings 

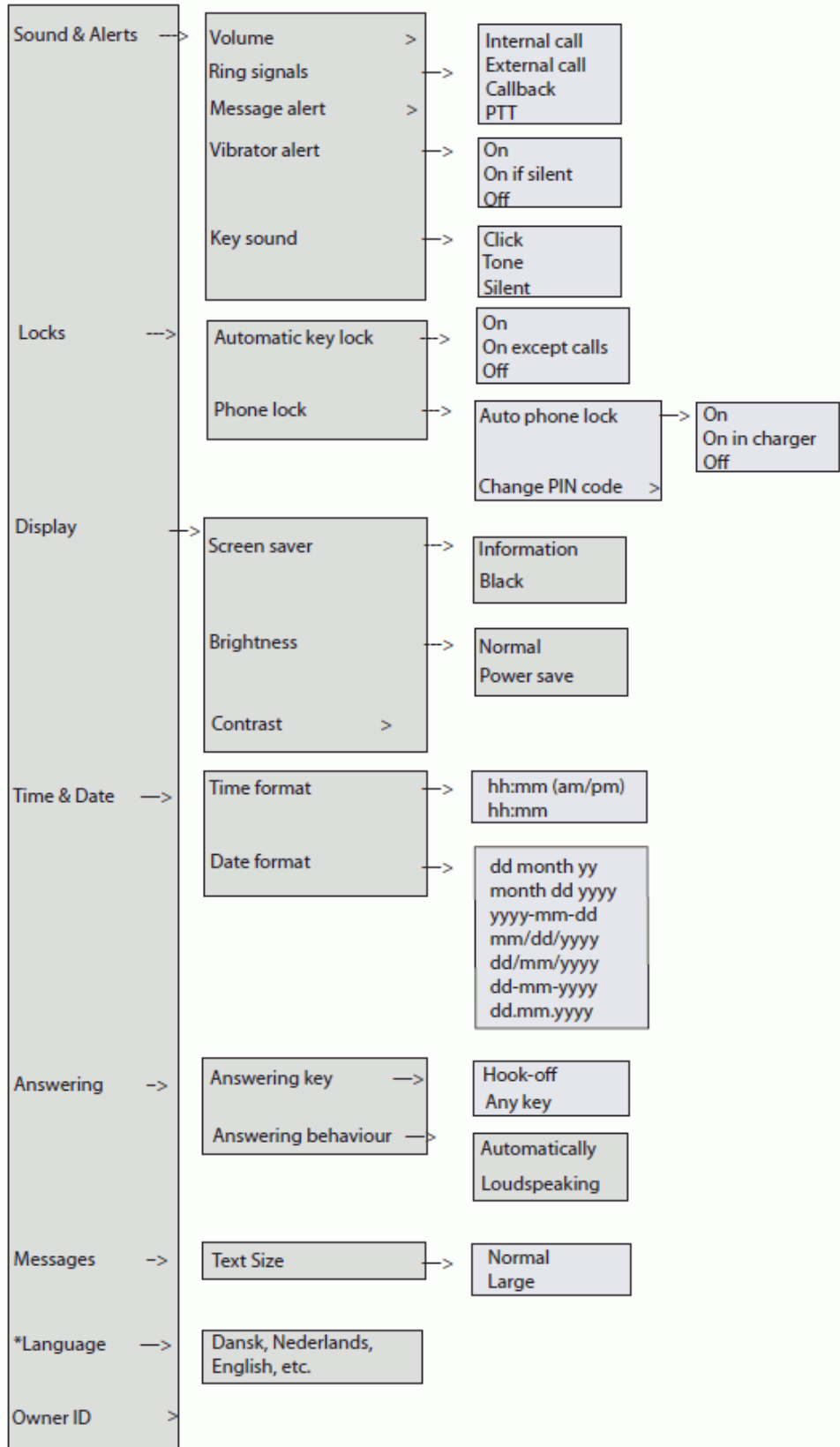

In Call

You access the In Call menu during a call by pressing the "More" soft key.

If the handset is configured via PDM/WSM, you can access a particular function in the In call menu directly by pressing the right soft key.

The In call function can be used in combination with the Procedure call function, see "Procedure Call" on page 50. See "Call Handling for the Mitel 5000 CP" on page 32 for an illustration of the In Call menu.



Note: If the handset is configured via PDM/WSM, you can call a pre-defined emergency number while the handset is locked or the keypad is locked. If calling from a locked handset, you can only access the Microphone on/off function in the In Call menu. However, you can access the entire In Call menu when calling from a handset with a locked keypad.

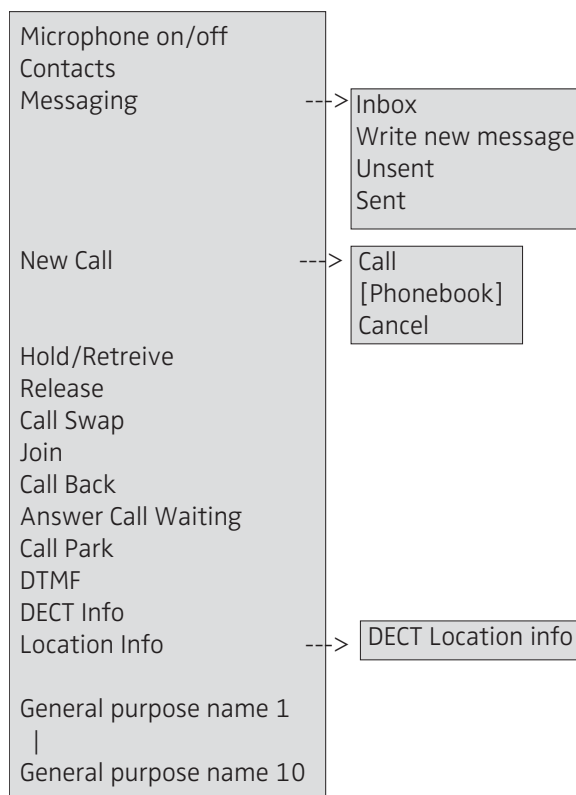

* Visible if enabled/defined in the PDM/WSM

** Visible if the Admin menu is activated. You require the DECT location license.

Additional In Call Functions

In addition to the default In Call functions, you can define 10 system specific codes for general purposes. See the *5603/5604/5607 Programmer and Installation and Maintenance Guide*.

Navigate the Menu

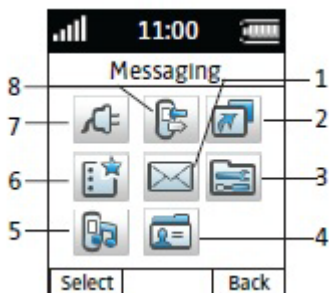



Figure 13: Main Menu

- | | |
|----------------|-----------------|
| (1) Messaging | (5) Profiles |
| (2) Short cuts | (6) Services |
| (3) Settings | (7) Connections |
| (4) Contacts | (8) Calls |

Connections Menu

1. Enter the menu by pressing the "Menu" soft key, or the confirmation button on the Navigation key.
2. Select  in the menu, and press the confirmation button or the "Select" soft key.

Headsets

In order to achieve optimal audio quality we recommend you specify a headset type: Mic on boom, Mic on cable or Hearing protection. Additional headsets¹ might be visible in the list.

To specify a headset type:

1. Select "Headset".
2. Select a headset type from list.
3. Press "Select".

System



Change System

Select "Automatic" or a specific system. If the handset is set to "Automatic" it selects a system according to the priority list. See "Priority" on page 65.

Subscribe to IP-DECT System (Release 4.x or higher)

A handset can subscribe to an IP-DECT system automatically if the following are fulfilled:

1. Only visible if the headset profile has been configured in the PDM/WSM.

- The IP-DECT system is configured for Easy Registration; see the *Mitel IP-DECT Base Station Installation and Operation Guide*.
 - The handset's extension number and IPEI are registered in the IP-DECT system, see the corresponding manual for the IP-DECT system.
 - The handset is not subscribed to any systems.
 - The handset software is version 4.0.x or greater.
1. If needed, switch off the handset by pressing .
 2. Switch on the handset by pressing .
 3. Select language to be used or press "Cancel". If Cancel is pressed, the default language (English) will be used.
 4. The handset starts to search for IP-DECT systems and will subscribe to the system when it is found.



Note: If no system is found within 2 minutes or "Cancel" is pressed, the handset's subscription menu is displayed. Continue with step 5 in the procedure "Subscribe to Other System" on page 63 for more information.

Notes about Subscribing Handsets and Hot Desking

If the handset is subscribed, but not registered with MiVoice Business or 5000 CP, the handset will display the following message: "Please login".

- When subscribing the handset to the IP-DECT Base Station, enter the leading 0's of the PARK code. Removing the 0's will prevent subscription.
- After registering the handset with MiVoice Business or the 5000 CP using the System ID, Extension, and auth password, the "Please Login" message is removed from the handset.
- If you are unable to subscribe the handset, ask the administrator to remove the handset IPED from the user in the IP-DECT Base Station, if the IPED was pre-programmed for the user.

If the handset is configured as a Hot Desk handset, then "Please Login" appears for the user to enter hot desk information.

Subscribe to Other System

The handset can subscribe up to eight different systems. To subscribe a new system, you require the "Park:" (Portable Access Right Key) and "Ac:" (Authentication code) related to the system. Contact your system administrator for more information.



Note: The PARK code may not be required if there is no alien DECT system within the coverage area. The handset supports IP-DECT systems configured for Easy Registration.

The IPDI code is a unique code which has been assigned to the handset. See "Admin Menu" on page 90.

1. Enter the menu by pressing the "Menu" soft key.
2. Select  in the menu.

3. Select "System".
4. Select "Subscribe".
5. Press "Next".
6. Enter a System name (optional).

If no system name is entered, the default name, such as System A or System B, will be used, depending on system name availability.

7. Press "Next".
8. Enter the PARK code (max. 31 digits).

The PARK code may not be required if there is no alien DECT system within the coverage area.

9. Enter an AC code.

The AC code length must be between 1 - 8 digits.

10. Press "Next".
11. An information text "Protection on?" appears.
12. Select "Yes" if the new system is to be protected.

You cannot delete a protected subscription from the System menu¹.

13. Press "OK" to search.

Unsubscribe System

1. Press "Menu".
2. Select  in the menu.
3. Select "System".
4. Select "Unsubscribe"¹.
5. Select the system to unsubscribe.
6. Press "Yes to unsubscribe the system."

Rename System

You can change the name of the system in the handset.

1. Select "Rename System".
2. Select a system to rename.
3. Enter new name.
4. Select "Save".

¹ It is not possible to unsubscribe a protected system via the System menu. The un-subscription must be made via the Admin menu or the DECT system.

Priority

The default order of priority is the order of entered subscriptions. This means that the first subscribed system has the highest priority. You can edit this list and can set the systems in priority by moving them up or down in the list.



Note: This is used in combination with system set to be "Automatic", see "Change System" on page 62.

1. Select "Priority".
2. Select "Up" or "Down" to change the priority.
3. Select "Back" to save the priority.

In Charger

Redirect Calls While Charging

You can redirect calls to another extension when the handset is placed in the charger. Redirecting calls enables message absence. See "Messages Absence While Charging" on page 66 for more information. The function is automatically cancelled when the handset is removed from the charger.



Note: The extension where the calls will be redirected to is configured in the PBX.

1. Select "In charger".
2. Select "Redirect".

Switch off While Charging

When you place the handset in the charger it can be switched off while it is charging. When you remove it from the charger it will switch on again.

1. Select "In charger".
2. Select "Switch off".

End Call When put In Charger

The handset can be configured to end an ongoing call when put in the charger.

1. Select "In charger".
2. Select "Call behavior".
3. Select "End Call".

Mute Handset While Charging

When you place the handset in the charger it can be muted while it is charging. When it is removed from the charger it will switch on the sound again.

1. Select "In charger".
2. Select "Sound off".

Loudspeaking (Handsfree) While Charging

1. Select "In charger".
2. Select "Loudspeaking".

Log Off Handset While Charging



Note: This feature is license dependent and applicable in IP-DECT systems only.

Note: This feature requires that the parameter "Phone mode" is configured. See the *Mitel 5604 Wireless Handset Configuration Guide*.

When you place the handset in the charger it can be logged off while it is charging. Call list and message list will be deleted when the handset is logged out. When it is removed from the charger you need to log on again.

1. Select "In charger".
2. Select "Logout".

Change Profile While Charging

When you place the handset in the charger it can change profile while it is charging. By default, the "Normal" profile will be activated. It is possible to change to another profile if configured. See "Profiles Menu" on page 77

1. Select "In charger".
2. Select "Change profile".
3. if required, select "Edit" to change the profile to be activated when the handset is placed in a charger.

Messages Absence While Charging

When you place the handset in the charger message absence can be enabled while it is charging. See also "Redirect Calls While Charging" on page 65. The function is automatically cancelled when the handset is removed from the charger.

When an application/system sends a message to a handset it will receive an indication that the handset is absent. If a handset is absent the application/system determines if the message will be sent to the handset or not, or redirected to another handset.



Note: If a message is sent from a handset it will not receive an indication that the recipient is absent.

1. Select "In charger".
2. Select "Message Absence".

Deactivate the Charging Mode

1. Select "In charger".
2. Select "No action".
3. Press "Select" to save the setting.

Calls Menu

1. Enter the menu by pressing the "Menu" soft key, or the confirmation button on the Navigation key.
2. Select  in the menu, and press the confirmation button or the "Select" soft key.

Call List

The 25 last received, dialed or missed calls are stored in a call list. If a number occurs more than once, the last time stamp and the total number of occurrences are shown.



Note: If supported by the system, the number's contact name can be displayed in the call list.

This option can be disabled so handset does not store any calls in the call list¹. This can for example be used to allow privacy for users sharing the same handset.(This feature requires configuration in the handset via PDM/Device Manager.)

1. Select Call list, and step with the ▲ and ▼ to scroll in the list.

Dial a Number from the Call List

1. Select a number to call.
2. Press the "Call" soft key to dial.

View the Time of a Call

1. Press the "More" soft key.
2. Select "Time of call".

The time and date are displayed.

Edit a Number from the Call List

1. Press the "More" soft key.
2. Select "Edit number".

¹. These feature requires configuration in the handset via PDM/Device Manager.

Save a Number

1. Press the "More" soft key.
2. Select "Save number".

Send a Message

1. Press the "More" soft key.
2. Select "Send message".

Delete an Entry from the Call List

1. Press the "More" soft key.
2. Select an entry to delete.
3. Select "Delete".
4. Select "Yes" to delete the entry from the list.

Delete all Entries from the Call List

1. Press the "More" soft key.
2. Select "Delete all".
3. Select "Yes" to delete all the entries from the list.

Missed Calls

1. Select Missed calls, and step with the ▲ and ▼ to scroll in the list.
2. Press the "Call" soft key to call back.

You can use the "More" soft key to view the time/date of the call, edit the received number, add contacts and delete received numbers. See "Call List" on page 67 for information about the functionality in "More" soft key.



Note: If supported by the system, the number's contact name can be displayed in the call list. It is possible to turn off the dialog window that appears for a missed call. Additionally, it is also possible to turn off that the handset stores any calls in the call list. The latter feature can for example be used to allow privacy for users sharing the same handset.

Call Time

The total time of the previous call and last call appears.

1. Select "Call time".

Push to Talk

The Push-to-Talk (PTT) function enables a pre-defined group of mobile staff to participate in a call whereby they all listen to the group's call activity, typically in loudspeaker (Handsfree) mode. Participants press and hold a button in order to speak.

For PTT to function, the PTT-capable handsets in the PTT group must be configured on the Wireless Messaging Services (WSM) Gateway. Additionally, a conference bridge, such as Mitel's Audio & Web Conferencing (AWC) must be configured to support the PTT calls.

Two types of PTT calls can be made:

- PTT Voice Style (initiated by the handset)
- PTT Message Style (initiated by the system)

PTT Voice Style Calls (Handset initiated)

Each member of a PTT group is able to initiate a PTT call via a PTT request. This PTT Call request is typically programmed onto a soft key, hot key or multi-function button on the handset for quick access.

After a PTT Call request is made, the system invites the other members of the PTT group into the PTT call. The invitation typically barges onto the invited members' handsets following brief alerting of the incoming PTT call; manual PTT Call acceptance can be configured optionally.

After the PPT group members have received/accepted their PTT invitations, the system automatically dials them onto the configured conference bridge and they become active in the PTT call.



Note: Depending on the configuration, it may take 10 seconds or more for all members to be active on the PTT call from the time a user initiates a PTT request.



Note: Multiple PTT groups are supported; if a handset is a member in multiple groups, the PTT Groups can be programmed onto the handset menu to enable selection of the appropriate PTT group Call request.

Accept a PTT Invitation - Voice Style

The PTT invitation is indicated by a  icon and is received as an incoming call. In the dialog window, a message containing maximum 24 characters can also be shown.

1. Press .

The handset may accept the invitation automatically and start in inverted mute and loud-speaking mode, depending on the configuration of the received PTT invitation.

2. Press and hold the Mute button to open the microphone for transmitting.

The microphone is muted again when the Mute button is released.

Reject a PTT Invitation - Voice Style

Press  to reject the PTT invitation. The handset will return to the previously shown screen. See also "Re-join a PTT Group" on page 70.

PTT Message Style (System/Application Initiated)

This mode is typically used in conjunction with an application that triggers the PTT call based on a alarm or communication escalation.



Note: This method requires an additional Alarm Management Server (AMS) module.

Accept a PTT Invitation - Message Style



Note: This feature applies to the 5604 Services license only.

The PTT invitation is received as a message, can contain up to 1000 characters, and is viewed the same way as an ordinary message.

1. Press the "Call" soft key.
The handset may accept the invitation automatically and start in inverted mute and loud-speaking mode, depending on the configuration of the received PTT invitation.
2. Press and hold the Mute button to open the microphone for transmitting.
The microphone is muted again when the Mute button is released.

Reject a PTT Invitation - Message Style ²



Note: This feature applies to the 5604 Services license only.

- Press the "Close" soft key to reject the PTT invitation.
The handset will return to the previously shown screen. See "Re-join a PTT Group" on page 70.

Re-join a PTT Group

If a PTT invitation (PTT Voice Style) is rejected or missed, the PTT group can be dialed from the Call list or from Missed calls, respectively. The PTT invitation is indicated by the  icon in the list. See "Call List" on page 67, or "Missed Calls" on page 68.

If a PTT invitation (PTT Message Style) is rejected, the PTT group can be dialed by selecting the message indicated by the  icon in the Messaging inbox and pressing the "Call" soft key.

Call a PTT Group



Note: PTT group(s) must be defined in the PDM and Messaging Group(s) in WSM to be able to use this function. See the *Mitel 5604 Wireless Handset Configuration Guide*, and the *WSM Installation and Operation Guide*.

When calling a PTT group, the members in the defined PTT group will receive a PTT invitation as an incoming call (PTT Voice Style).

1. Press "Menu".
2. Select "Calls".
3. Select "PTT groups"¹.
4. Select a PTT group.
5. Press "Call", or the Off-hook key.

Short Cuts Menu

Predefined functions can be set as short cuts for the soft keys, hot keys, navigation keys, and the Multifunction button. For example, you can to define a soft key to make a call, as a short cut for sending a message, or as a short cut to a menu.

1. Enter the menu by pressing the "Menu" soft key, or the confirmation button on the Navigation key.
2. Select  in the menu, and press the confirmation button or the "Select" soft key.

Define a Soft Key

1. Select "Soft keys".
2. Select "Left", "Middle", or "Right".
3. Press "Select" to enter a name for the Soft key.
4. Press "OK".
5. Select "Function".
6. Press "Select" to select function for the soft key.
7. Select function from list.
8. Press "Back".
9. Select "Value" (applies only to some functions).
10. Press "Select".
11. Enter a value (for example, enter a handset number).
12. Press "Back".
13. Select "Control question".
14. Press "Select".

¹. Only available if a PTT group is defined in the PDM/WSM.

15. Press "Back".
16. Press "Save".

Define a Hot Key

1. Select "Hot keys".
2. Select "0", "2" to "9".
3. Select "Function".
4. Press "Select".
5. Select a function from list.
6. Press "Back".
7. Select "Value" (applies only to some functions).
8. Press "Select".
9. Enter a value (for example, enter a handset number).
10. Press "Back".
11. Select "Control question".
12. Press "Select".
13. Press "Save".

Define a Navigation Key

1. Select "Navigation keys".
2. Select "Up", "Down", "Left", or "Right".
3. Select "Function".
4. Press "Select".
5. Select a function from list.
6. Press "Back".
7. Select "Value" (applies only to some functions).
8. Press "Select".
9. Enter a value for example a handset number.
10. Press "Back".
11. Select "Control question".
12. Press "Select".
13. Press "Save".

Define the Multifunction or Alarm¹ Button

The Multi-function button can be defined with two different functions: a long press activates one function, and a double press activates another function.

1. Select "Multi-function button"/"Alarm button¹".
2. Select "Long press", or "Multi press".
3. Select "Function".
4. Press "Select".
5. Select a function from list.
6. Press "Back".
7. Select "Value" (applies only to some functions).
8. Press "Select".
9. Enter a value (for example, enter a handset number).
10. Press "Back".
11. Select "Control question".
12. Press "Select".
13. Press "Save".

Services Menu

A list of predefined menu functions are available. Using the Services menu you can customize the menu with functions you use often.

1. Enter the menu by pressing the "Menu" soft key, or the confirmation button on the Navigation key.
2. Select  in the menu, and press the confirmation button or the "Select" soft key.

Add a Service

1. Select "Add new".
2. Enter a name of the service in the field>
3. Press "OK"
4. Select a function by using the ▲ and ▼ on the navigation key.
5. Press "Select", or the confirmation button.
6. If necessary, enter values in the fields (applies only to some functions)
7. Press "Back".

1. Applies to the 5604 Personal Alarm license only.

Edit a Service

1. Select a service by using the ▲ and ▼ on the navigation key.
2. Press "More"
3. Select "Edit".
4. Edit the service parameters.
5. Press "Back".

Delete a Service

1. Select a service by using the ▲ and ▼ on the navigation key.
2. Press "More".
3. Mark "Delete" by using ▼ on the navigation key.
4. Press "Select".
5. Press "Yes" to delete the service.
6. Press "Back".

Messaging

1. Enter the menu by pressing the "Menu" soft key, or the confirmation button on the Navigation key.
2. Select  in the menu, and press the confirmation button or the "Select" soft key.

Inbox

1. Select "Inbox" to view the message list.
2. Select a message by using the ▲ and ▼ on the navigation key.

Reply to Sender

1. Select "View".
2. Select "Reply".
3. Enter text.
4. Select "Send".

Delete a Message

1. Select "More".
2. Select "Delete".
3. Select "Yes" to delete the message.

Forward a Message

1. Select "More".
2. Select "Forward".
3. Enter additional text if required.
4. Select "Send".
5. Enter number.
6. Select "Send" to forward the message.

Call a Sender

1. Select "View".
2. Select "More".
3. Select "Call Sender".

Call a Number in Text

1. Select "View".
2. Select "More".
3. Select "Call (No. in text)"¹.
4. Select a number from the list.
5. Select "Call".

Save a Number

1. Select "View".
2. Select "More".
3. Select "Save number".
4. Select "Work Number"/"Mobile number"/"Other number".
5. Press "Add".
6. Enter name for the contact.
7. Press "OK".
8. Press "Save". The number will be saved in the contact list.

Write a New Message

1. Select "Write new message".
2. Enter text, and press "Send". See also "Messaging" on page 37.
It is possible to save the message and send it later by pressing the soft key "Back" and select "Yes". The message will be stored under Unsent messages.
3. Enter number, or press middle soft key to get number from contact list.
4. Press "Send".

¹. Only visible if the number consists of minimum 3 digits.

Unsent Messages

1. Select "Unsent" to view the list.
2. Select message to edit/send.
3. Select "Edit", edit text and/or just select "Send".

Delete/Delete All

1. Select "More".
2. Select "Delete" or "Delete all".
3. Select "Yes" if the unsent message shall be deleted.

Sent Messages

1. Select "Sent" to view the list.
2. Select "View".

Forward a Message

1. Enter additional text if required.
2. Enter a number or press the middle soft key to open the phonebook.
3. Select "Send".

Delete a Message

1. Select "Delete".
2. Select "Yes" to delete the message.

Delete/Delete All

1. Select "More".
2. Select "Delete" or "Delete all".
3. Select "Yes" to delete the unsent message.

Profiles Menu

You can set up your own profiles for incoming calls, message alerts, vibrating alerts and key sounds. This can be useful when there are many users on the same handset and they want different sound profiles. It can also be used for temporarily settings, for example to silence the ring tone for incoming calls while in a meeting. You can readily switch between different profiles.

1. Enter the menu by pressing the "Menu" soft key, or the confirmation button on the Navigation key.
2. Select  in the menu.

Add a New Profile

1. Press "Add new".
2. Enter name of the profile.
3. Select "Save".
4. Press "More"
5. Select "Add settings".
6. Select the settings to be added to the profile.
7. Repeat steps 3 to 6 to add additional settings.
8. Select a setting and press "Edit" to make the changes.

Create a Profile based on Another Profile

1. Press "Add new".
2. Enter a name for the profile.
3. Press "Save".
4. Press "More".
5. Select the profile from which settings will be used for the new profile.
6. Press "More".
7. Select "Import from".
8. Select an option to be added/imported/removed, if required.
9. Select a setting.
10. Press "Edit" to make the changes.

Activate a Profile

1. Select profile from list and change profile as wanted.

When a profile is activated, the icon  is displayed in idle mode.

Delete a Profile

1. Select a profile from list.
2. Press "More".
3. Select "Delete" from the list.
4. Press "Delete".
5. Press "Yes" to confirm.

Edit a Profile

1. Select a profile from list.
2. Press "More".
3. Select "Edit" from the menu.
4. Select the information to be edited.
5. Press "Edit".
6. Perform any of the following options:
 - Edit a setting by marking it and then press "Edit".
 - Add additional settings by pressing "More" and selecting "Add setting" or "Import from".
 - Remove a setting by selecting it and selecting "More > Remove setting".
7. Make changes.
8. Press "Save" to confirm.

Contacts Menu

The handset has a local phonebook with 250 entries: you can add, delete, or edit names and numbers. The phonebook lists all names in alphabetical order. three numbers can be added for each contact: work number, mobile number, and other number.

In addition, you can download a company phonebook to the handset via the PDM/WSM. See “Software Upgrade and Additional Features” on page 91. You cannot edit or delete the company phonebook names and numbers. The phonebook lists all names in alphabetical order. The local and company phonebooks appear in the same list but the company names are indicated by a “Locked entry” icon  in front of the name. The contact will include only the work number. See “Dial a Number from the Company Phonebook” on page 21 for more information.

You can also access a central phonebook¹. See “Dial a Name from the Central Phonebook” on page 20. You send a request to a messaging server with the first characters entered and the messaging server returns a list of names and numbers that matches the search.

1. Enter the menu by pressing the “Menu” soft key, or the confirmation button on the Navigation key.
2. Select  in the menu. See “Contacts” on page 55.

Call a Contact

1. Select "Call contact".
2. Select contact from the list or enter name or number in the search field.
3. Press the "Call" soft key.

You can select "View" > "More" to edit the contact and send a message.

Add a Contact

1. Select "Add contact".

Add a New Contact

1. Select "New".
2. Select "Add".
3. Enter the name of the contact.
4. Press "OK".
5. Select "Work Number"/"Mobile number"/"Other number".
6. Press "Add".
7. Enter a number.
8. Press "OK".
9. Press "Save".

¹. This is a system dependent function.

10. Press "Back".

Different ring signals can be set to distinguish between contacts.

Add from the Call List

1. Select "From call list".
2. Select a number.
3. Press "Add".
4. Select a number type.
5. Press "Select".
6. Press "Add", and enter name for the contact.
7. Press "OK".
8. Press "Save".

Edit a Contact

1. Select "Edit contact".
2. Select a contact.
3. Press "Edit" twice.
4. Enter a new name/number.
5. Press "OK".
6. Press "Save".

Delete a Contact

1. Select "Delete contact".
2. Select a contact.
3. Press "Delete".
4. Press "Yes" to confirm.

Central Phonebook

In the Central Phonebook it is possible to search by name or number.

When the search result is ready you can view contact information, add the number to new contact, or send a message by selecting the "More" soft key. You can also call the number by selecting the "Call" soft key.

- Select "Central phonebook".

Search by Name

1. Select Search by name.
2. Enter a first name and/or a last name.
3. Select "Search".

The search result appears.

Search by Number

1. Select "Search by number".
2. Enter a handset number.
3. Select "Search".

The search result appears.

View Last Search Result

1. Select "Last result".



Only the last result appears.

Settings Menu

1. Enter the menu by pressing the "Menu" soft key, or the confirmation button on the Navigation key.
2. Select  in the menu. See "Settings Menu" on page 82.

Sound and Alert Settings

Adjust the Ringer Volume

1. Select "Sound & Alerts."
2. Select "Volume".
3. Step with  to increase the volume and with  to decrease it.
4. Press "Back" to save the setting.



Note: If handset's restrictions are enabled, it might not possible to set the ring volume to "Silent". See the *Mitel 5604 Wireless Handset Configuration Guide*.

Set Ring Signals for Internal Calls, External Calls and Call Backs

1. Select "Sound & Alerts".
2. Select "Ring signals".

You can set different signals for internal calls, external calls and call backs.

3. Select "Internal call", "External call", or "Callback".

The handset has 14 different ring signals.

4. Select a sound.

You can press "Play" to listen to the different sounds.

5. Press "Back".

Set Message Alerts for Mail

1. Select "Sound & Alerts."
2. Select "Message alert".

You can select from 8 different message alerts. See "Settings Menu" on page 82.

3. Select message alert from list.

You can press "Play" to listen to the different sounds. "Play" is not available for Enhanced Beep. Instead, send a message to the handset to listen to the sound.

4. Press "Back".



Note: By default, the message volume follows the ring volume setting, but it is possible to set another message volume in the handset, see the *Mitel 5604 Wireless Handset Configuration Guide*.

Turn the Vibrator On/Off

If the vibrator is activated, it will vibrate at incoming call and message. In addition, it is possible to activate the vibrator when receiving a message during a call. See the *Mitel 5604 Wireless Handset Configuration Manual*.

1. Select "Sound & Alerts".
2. Select "Vibrator alert".
3. Select "On", "On if silent" (that is, the vibrator is on when the handset is muted), or "Off".
4. Press "Back".

Set the Key Sound

When you set the sound key, every time a key is used the handset produces a faint sound.

1. Select "Sound & Alerts".
2. Select "Key sound".
3. Select "Silent", "Click", or "Tone".
4. Select a key sound.
5. Press "Back".

You can listen to the key sound by pressing the "Play" soft key.

Keypad Lock Settings

The handset keypad can be locked to minimize the risk of accidentally pressing keys or buttons while the handset is not in use. When Automatic key lock is set to "On", the keypad is automatically locked if the handset is out of use for a specified time. The length of time is set by the "Auto lock time" parameter. The shortest time that can be set before the key lock is applied is 5 seconds and the longest time is 3 minutes.

The automatic key lock can be configured by the administrator in the PDM/Device Manager. For additional information, see the *Mitel 5604 Wireless Handset Configuration Manual*. The user may also select one of the following for the automatic key lock:

"On": the keypad is automatically locked if it is not used before the specified lock time elapses.

"On, except calls": the keypad is automatically locked if it is not used for the specified lock time. If the user is in call when the lock time elapses, the keypad remains unlocked until the user has completed the call.

"Off": the keypad is never automatically locked.



Note: A call can be answered or ended while the keypad is locked. For the 5604 Personal Alarm, the alarm button can be pressed while the keypad is locked. If configured in the PDM/Device Manager, any one of up to five predefined emergency numbers can be called while the keypad is locked. See the *Mitel 5604 Wireless Handset Configuration Guide*.

Activate the Automatic Key Lock

The user activates the automatic key lock and sets the Auto lock time from the handset "Settings" menu in the following way:

1. Select "Locks".
2. Select "Automatic key lock" and select "On" or "On, except calls".
3. Press the "Back" soft key to redisplay the "Locks" menu.
4. Select "Auto lock time" and press the "Select" soft key.
5. Select the required lock time and press the "Select" soft key.

Deactivate the Automatic Key Lock

1. Select "Locks".
2. Select "Automatic key lock" and select "Off".

Automatic Key Unlock

The user can configure a locked keypad to unlock automatically when a call or message is received. After the user has serviced the call or message, the keypad is locked again after the specified Auto lock time expires.

Phone Lock Settings

The handset can be protected for unauthorized use by activating the phone lock. The phone lock may be set to:

- "On": The handset is automatically locked if not used for the specified automatic lock time or when it is first turned on.
- "On in charger": The handset is locked immediately when placed in the charger. When removed from the charger and unlocked by the PIN, the handset remains unlocked
- "Off": The handset is never locked.

The phone lock is activated when the handset is placed in the charger. The default phone lock code (0000) can be changed to any 4 -8 digit code.

The length of time before the handset locks automatically is set by the "Auto lock time" parameter. The shortest time that can be set before the handset locks is 5 seconds and the longest time is 3 minutes.



Note: If configured in the PDM/Device Manager, any one of up to five predefined emergency numbers can be called while the keypad is locked. See the *Mitel 5604 Wireless Handset Configuration Guide*.

Activate the Phone Lock

3. Select "Locks > "Phone Lock" > "Auto phone lock".
4. Select "On", or "On in charger".
5. Enter a PIN code.
6. Press "OK".

If the PIN code is forgotten it can be removed by your distributor.

Deactivate the Phone Lock

1. Select "Locks > "Phone Lock" > "Auto phone lock".
2. Select "Off".
3. Enter a PIN code.
4. Press "OK".

Change the PIN Code

1. Select "Locks > "Phone Lock" .
2. Select "Change PIN code".
3. Enter the old PIN code and press "OK".
4. Enter a new PIN code twice.
5. Press "Save".

Display Settings

Screen Saver

The screen saver can be set to one of the following settings:

- Information: Displays status and identification information while the handset is idle.
- Black: The screen is black when the handset is idle.
- Black also in call: The screen is also black when the handset is in call.

To set the screen saver:

1. Select "Display" from the handset menu.
2. Select "Screen saver". The current setting is displayed under "Screen saver".
3. Select "Information", "Black", or "Black also in call".
4. Press "Back".



Note: When charging the handset in an advanced charger or rack charger, information is replaced by the large license indicator shield. When in the desktop charger it is the same as when out of the charger.



Note: When the handset with the screen saver set to "Information" is in a charger, the Owner ID is displayed even if the handset switched off. This simplifies identification when many handsets are in a charging rack.

Brightness

1. Select "Display".
2. Select "Brightness".
3. Select "Normal" or "Power save".
4. Press "Back".

Contrast

1. Select "Display".
2. Select "Contrast".
3. Increase/decrease the contrast by pressing ▲ and ▼ on the Navigation key.
4. Press "Back".

Time and Date Settings

The time and date displayed in the handset cannot be changed by the user. The DECT system is solely responsible for keeping the time. The handset also synchronizes with the DECT system time when:

- The handset is turned on after having been turned off. The handset requests the current DECT system date and time.
- The handset remains on for longer than 24 hours. The handset requests the DECT system time every 24 hours from the time it was last turned on.

The time and date formats displayed in the handset can be changed by the user as described in the following sections.

Set a Time Format

1. Select "Time & Date".
2. Press "Select".
3. Select a time format.

The actual time format will be displayed. The time formats include:

- 12:00 (AM/PM)
 - 24:00
4. Press "Select" to save the setting.

Set a Date Format

1. Select "Time & Date".
2. Press "Select".
3. Select "Date format".
4. Press "Select".

The date formats include:

- DD/MM/YYYY, i.e. 17/09/2011 (also called Europe)
 - MM/DD/YYYY, i.e. 9/17/2011 (also called US)
 - YYYY-MM-DD, i.e. 2011-09-17 (ISO 8601)
 - MMM DD YYYY, i.e. Sep 17 2011
 - DD MMM YY, i.e. 17 Sep 11
 - DD.MM.YYYY, i.e. 17.09.2011
 - DD-MM-YYYY, i.e. 17-09-2011
5. Press "Select" to save the setting.

Answering

By default the handset uses the Off-hook key when answering calls. You can configure the handset to answer calls automatically (without pressing a key) and can set loud-speaking mode. You can associate the answering behavior with any key. If you select "Any key", any key except the "On-hook" and "Sound off" keys, can be used to answer a call.

1. Select  in the menu. See "Settings Menu" on page 82.
2. Select "Answering".

Answering Key

By default the answering key is set to *Hook-off*.

1. Select "Answering key"
2. Select "Hook-off" or "Any key".
3. Press "Back" to save the setting.

Press "Back" to save the setting.

Answering Behaviour

1. Select "Answering behaviour".
2. Select "Automatically" and/or "Loudspeaking".
3. Press "Change" to change the setting.
The check box will be selected.
4. Press "Back" to save the setting.
5. To optionally remove the setting, press "Change".
The check box will be cleared.

Change Text Size for Messages

1. Select "Messages".
2. Select "Text size Normal".
The default text size is "Normal".
3. Select "Normal" or "Large".
4. Press "Back".

Change the Menu Language

1. Select "Language".
2. Select the language to be used: Brazilian Português (Brazilian Portuguese), (Czech), Dansk (Danish), Deutsch (German), English, Español (Spanish), Français (French), (Greek), (Hungarian), Italiano (Italian), Nederlands (Dutch), Norska (Norwegian), (Polish), (Russian), (Slovakian), Suomi (Finish), Svenska (Swedish), or (Turkish).
3. Press "Back".



Note: The languages mentioned above are the default languages. You can download an additional language to the handset. See "Software Upgrade and Additional Features" on page 91.

Change the Owner ID

The Owner ID is set to identify the handset.

1. Select "Owner ID".
2. Enter a name/identity.
3. Press "Save".

Advanced Functions

Admin Menu

The handset has a hidden menu for system administrators. See the *Mitel 5604 Wireless Handset Configuration Guide*.

The Admin menu contains:

- Software and hardware information, licence information, IPEI/IPDI, and User ID
- DECT link and system information
- DECT location information¹
- Centralized Management status
- Site survey tool
- Licence upgrade menu
- Fault logging
- Enhanced system menu with ability to alter protection
- Factory reset option

For quick access to the Device Information (DI) menu in idle mode, press the keys containing ***#DI#** (that is ***#34#**). For quick access to the IPEI/IPDI, press ***#06#** in idle mode. See the table below.

Information	Code
Software version	*#34#
Hardware version	*#34#
License information	*#34#
IPEI/IPDI	*#34# or *#06#
User ID	*#34#

Clear Lists in Charger

Via PDM/WSM it is possible to set a parameter that will clear messaging lists and call lists stored in the handset. When the parameter is activated and the function has been downloaded to the handset, the lists will be deleted when the handset is placed in the charger. This can be useful during administration of handsets for new users. See the *Mitel 5604 Wireless Handset Configuration Guide*.

¹. This feature applies to 5604 DECT Location license only.

System Handling

Software Upgrade and Additional Features

You can upgrade the software and features of the 5604 handset using the PDM or the WSM. See the *Portable Device Manager (PDM) Installation and Operation Guide* or *WSM Installation and Operation Guide*.

Examples of additional features that can be downloaded/configured via PDM/WSM:

- Company phonebook
- Downloadable languages
- Customizing the Menu Tree
- Licences¹

See the *Mitel 5604 Wireless Handset Configuration Guide* for more information.

To view the handset's software version, enter *#34# in idle mode.

Handset Updates via Charging Rack

From time to time, users are instructed to leave their handsets in a central charging rack to allow the handset to be updated with new features and functions. An ongoing update is indicated by the  in the handset header bar and an "Updating handset" message is displayed in the active area.

During the update, a message is displayed to indicate that an update is in progress as shown in figure 14. The "OK" soft key can be selected to close the message.



Figure 14: Handset Update while in Charger

If the handset removed from the charger and used, the update is suspended and resumed when it is returned to the charger.

1. The licence(s) can also be added via the Admin menu in the handset.

When the update is complete, a "Handset is updated" message is displayed to indicate that the handset is available for use, as shown in figure 15. Select the "OK" soft key to close the message.



Figure 15: Update Completed while in Charger

Troubleshooting

This section contains information on how to solve common operational problems and warnings you may receive. If you cannot resolve the issue contact your system administrator. If others are experiencing similar problems there may be a system error.

Operational Problems

Fault	Probable cause	Action or comment
No display	The battery level is low The screen saver is set to "Black also in call" The battery level is low or the handset is defective.	Charge the battery Change the screen saver setting as described in <i>Screen Saver</i> on page 86. Charge the battery or contact system administrator.
No ringing	The sound off icon is on, or the ringer volume set to silent, or the handset is defective.	Long press the Sound off key, increase volume, or contact the system administrator.

Error or Warning Messages

Display shows	Probable cause	Action or comment
No access	The network is in range but there are no access rights.	Switch off the handset and then switch it on again or contact your system administrator.
No System. The handset beeps once a minute (during max 30 minutes) with a low tone followed by a high tone (if enabled, the vibrator also follows the beeps).	The handset is out of coverage or handset is defective.	Stop the beep with the Sound off key and go into range. Note: When re-entering the coverage area it can take a couple of minutes before the handset automatically has registered into the system. or contact the system administrator.
SERVICE NEEDED Parameters corrupt	The handset is defective.	Select the reset option on the middle soft key if available. If no reset option is available or fault does not resolve the issue the handset needs repair.
SERVICE NEEDED Invalid IPDI Note: This display message is only shown in English.	Easy replacement procedure not followed correctly or failure during easy replacement procedure.	Send the handset for service.
Enter PIN code	The handset's lock is activated.	Enter the required PIN code. If the PIN code is lost enter a new one via PDM or do a factory reset via the PDM.
Battery low, charge now	The battery level is low.	Charge or replace the battery.
Phonebook is not available at the moment	The phonebook does not respond, not available at the moment.	Try again later. If the fault persists do a factory reset via the Admin menu or PDM.
Voice mail number not defined	There is no Voice mail number defined in the handset.	Define a Voice mail number via the PDM.
Could not encrypt connection	The parameter "Encryption Required" is enabled in the handset in combination with; 1. Un-encrypted base station(s); and/or, 2. Unsupported base station(s).	1. Disable the "Encryption Required" parameter in handset; and/or, 2. Enable the encryption in the base station(s); and/or, Note: If base station(s) is used, the software version must be 3.1.x or later. 3. Use supported base station(s). Ask your supplier.

LED Error Indications

See also "LED Indications during Easy Replacement" on page 100.

LED is flashing red, quick flash, (100 ms on, 800 ms off)

1. If a third handset, that is another handset than the "old" (the replaced handset) and "new" (the replacement headset) handset, is inserted into the charger during Easy Replacement, this error indication appears. Change to the correct handset.
2. The charger has found that Easy Replacement does not work. Change back to the "new" handset.

LED is flashing red, long flash (800 ms on, 100 ms off)

Error during Easy Replacement. *Both* telephones need to be sent for service.

Operation Notice

Accessibility and Voice Quality



The base network is not always available. If you do not get in contact with your system, contact your system administrator. For best voice quality, avoid positioning near computer, radio or similar equipment.

Operating Area

You can only use the handset in the area that is covered by your system. Outside this area you will lose contact with the system. The signal strength icon will be low and “Searching” will appear.

Out of Range

When you leave the system's coverage area a short beep will sound and the text “Searching” will appear in the display.



The out of range beep will be repeated every minute for 30 minutes. You can turn off the sound by long pressing , or .



When re-entering the coverage area it can take a couple of minutes before the handset automatically registers with the system.

Maintenance

Maintenance of Batteries



Battery Warnings

	<p>The "Low battery" icon appears when the battery has 10% or less remaining capacity. In addition; a warning signal sounds every minute, the LED flashes orange, and the dialog window shows "Battery low". "Charge now" appears.</p>
	<p>The "Empty battery" icon flashes when the battery has 5% or less remaining capacity. In addition; a warning signal sounds every second, the LED flashes red, and the dialog window "Battery empty. Shutting down." appears.</p>

During a call, only the corresponding battery warning signal will notify the user. The warning signal cannot be silenced during a call. When not in call, the warning signal can be silenced by pressing  or .

Charge the Battery

Place the handset in the desktop charger or in the rack charger. The battery is being charged when the LED on the handset is steady orange. When the battery is fully charged the LED will be green.

An animated battery icon  appears in the display and indicates the battery is charging. A filled battery icon  indicates a fully charged battery.



Note: Only use the prescribed chargers for charging.

Charge Spare Batteries

Spear batteries can be charged with a separate battery pack charger. It can charge six batteries at the same time.

Replace the Battery

If the standby time for the handset becomes too low you must replace the battery with a new one. Contact your system administrator or your supplier to obtain new batteries.

Attach the battery as described in the following illustration. You attach the battery inside the battery lid. It is connected it to the handset in such a way that "no miss-contact" is possible.

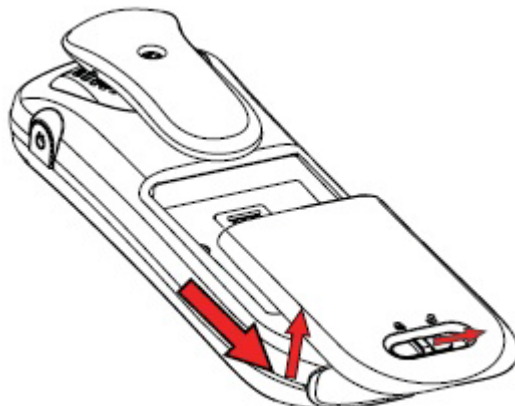

Figure 16: Easy Replaceable Battery - Unlock the Lid and Remove the Battery

Easy Replacement of Handset

Easy replacement can be used if a handset needs to be replaced due to, for example, a broken display. The easy replacement procedure is done via the handset display and the 5603/4/7 Programmer, or the rack charger.

The following settings are replaced during easy replacement:

- DECT registration
- User parameters (including User ID)
- Contacts
- The extension number is assigned to the new handset.

The following settings are not replaced during the easy replacement:

- Call list
- Messages
- License(s)¹

Before Starting the Easy Replacement Procedure

1. Check that both the old handset (that is, the handset to be replaced) and the new handset (that is, the replacement handset) are of the same device type (5604).



Note: It is possible to perform Easy Replacement between different licenses (that is; 5604 Standard, 5604 Services, 5604 Personal Alarm, and 5604 Dect Location). The new handset's license is not replaced by the old handset's license during the procedure¹.

2. Make sure that the handset batteries are charged before starting the easy replacement procedure.
3. Switch off the **new** handset by long pressing .

1. A license (that includes the handset variant and/or license dependent features) can be moved to another handset using PDM/WSM.

Easy Replacement Procedure

During the Easy Replacement procedure, the LEDs of the handset and the charger follow the same LED indications. This means that if the old handset has a broken display, the LED indications on the charger and on the handset can be used to follow the replacement procedure. Before and after easy replacement, the LEDs may have different LED indications. For more details, see "LED Indications during Easy Replacement" on page 100.

IMPORTANT: Never remove a handset from the charger until the instructions in the display or the LED tells you to do so. (See the status on the LED if the display is broken). If an error is indicated you may be able to remove the handset. See the *Mitel 5604 Wireless Handset Configuration Guide* for further instructions.

After you place the old handset in the charger, you must place the new handset in the charger, regardless of whether the replacement was successful or not. Failing to do so may result in malfunction and the new handset will need servicing.

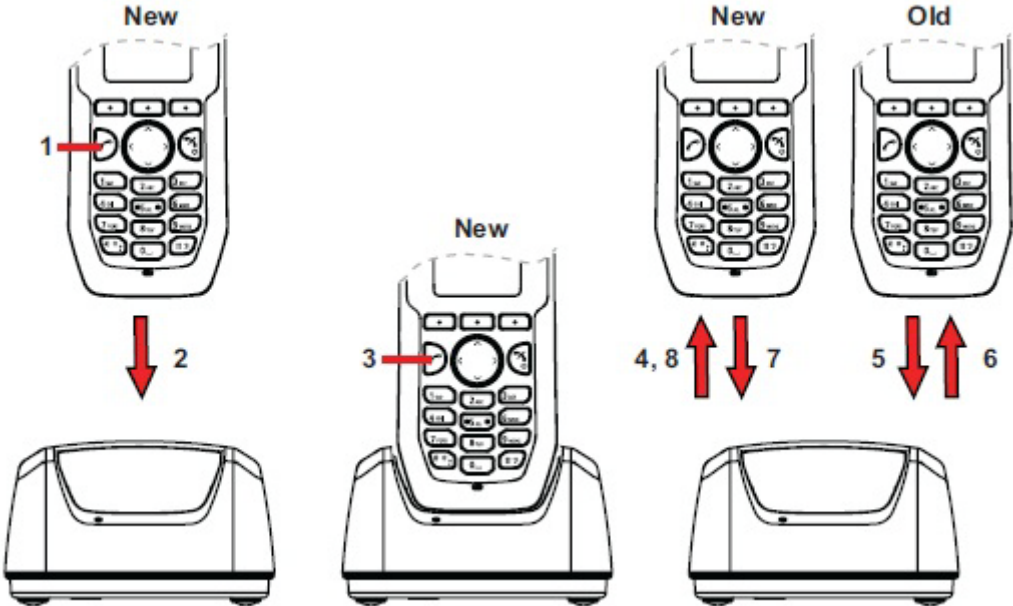





Figure 17: Easy Replacement using the 5604 Programmer

1	On the new handset, press and hold  Note: Do not release  until you are instructed to do so.
2	Put the new handset in the charger.
3	When the text "Start phone replacement?" appears, release  . Press "Yes" (left soft key). The text "Follow the instructions. Each step can take several minutes." appears. Press "OK"(left soft key).

4, 5	<p>When the text "Please insert old phone in charger" appears, replace the new handset with the old handset.</p> <p>The handset can either be switched on or off.</p> <p>Note: If the rack charger is used, the same charging slot has to be used for both handsets.</p> <p>The handset will be restarted and after a few seconds. The text "Saving settings. Do not remove phone from charger" appears.</p> <p>The charger LED changes to slow orange flashing.</p>
<p>IMPORTANT: Do not remove the handset while the text "Saving settings. Do not remove phone from charger" appears. It may take several minutes.</p>	
6, 7	<p>When the text "Please insert new phone in charger" appears, replace the old handset with the new handset.</p> <p>The text "Restoring settings" appears.</p>
<p>IMPORTANT: Do not remove the handset while the text "Restoring settings" appears</p>	
8	<p>When the text "Phone successfully replaced. Please remove phone to restart." appears, remove the handset from the charger. The handset is automatically restarted.</p>

LED Indications during Easy Replacement

The following table shows the LED indications that are used for the 5604 and the charger during the easy replacement procedure.

LED indication	Description
Orange, flashing (1 000 ms on, 1 000 ms off)	File transfer during Easy Replacement
Orange, flashing (100 ms on, 800 ms off)	"Change phone" indication during Easy Replacement
Red, flashing (100 ms on, 800 ms off)	Error indication during Easy Replacement. Put back old handset in charger
Red, flashing (900 ms on, 100 ms off)	Error during Easy Replacement. Service needed for <i>both</i> handsets

See also "Troubleshooting" on page 93.

Attach the Hinge-type Clip

Attach the hinge-type belt clip as described in the illustration below.

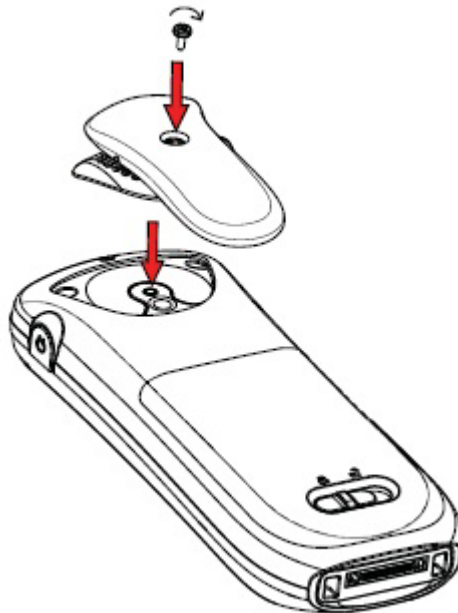

Figure 18: Screw the Hinge-type Clip into Position

Attach the Swivel-type Clip

Attach the swivel-type belt clip as described in the illustration below.

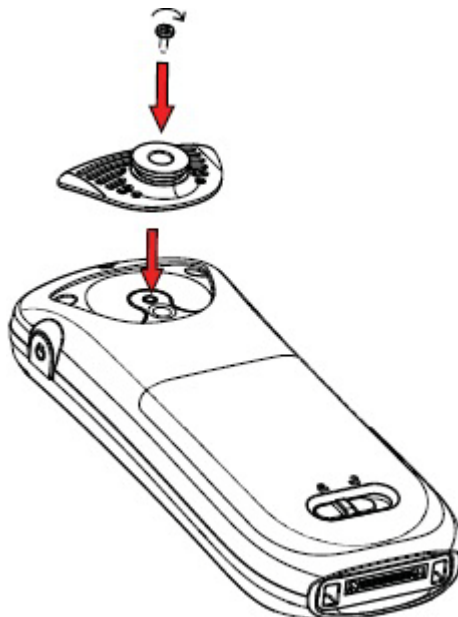

Figure 19: Screw the Swivel-type Clip into Position

Attach Cover for No Clip

Attach the enclosed cover as described in the illustration below when no clip is to be used.

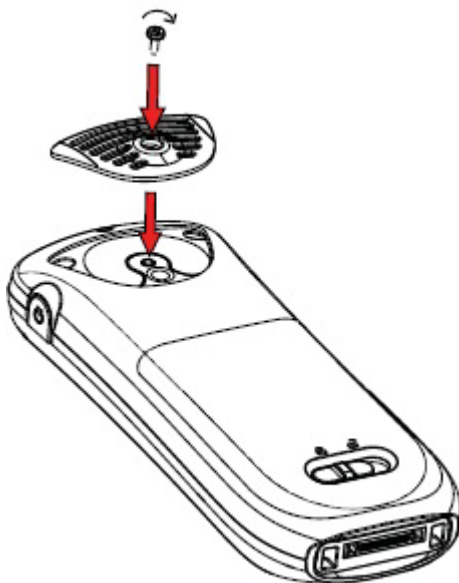

Figure 20: Screw the Cover into Position

Related Documents

- Mitel 5604 DECT Handset Data Sheet
- Mitel 5604 Wireless Handset Quick Reference Guide
- Mitel 5604 Wireless Handset Configuration Guide
- Portable Device Manager (PDM) Windows Version Installation and Operation Guide
- WSM 3 Installation and Operation Guide

Index

NUMERICS

3rd party 10

A

Antenna 4

B

Battery 4, 97
low battery 8, 97

C

C (Clear) button 11
Call info 10, 30, 36, 54
call priority 43
Call service 10
Calling
answered call 10
call a number from the call list 19
dial a number 19
missed call 10
outgoing call 10
quick call by a name in the phonebook 20
Case 4
Centralized phonebook 79
Chemical resistance 7
Clip 4

D

DECT Location 53
Delete a Text Message 38
Dialling
International number 19

E

Earpiece 4
Easy replacement 98

F

Forward a Text Message 38

I

Icons 8

L

LED indications 100

Loudspeaker 4
Loudspeaking 9, 21

M

Menu tabs 10
Message
new message 9, 37
old message 9
template
answer text message 48
voice message 9
Microphone 4
Mute button 11

N

Navigation Key 11
Number input mode 13

O

On/Off button 11
Ongoing call 10
Operating Area 96
Out of Coverage 96

P

PIN code 85
Push to Talk 69

R

Reply to a Text Message 38
Ring signal muted 9

S

Signal strength 8
Special characters 39
Standby mode
date 8
time 8
user identity 8

T

Text input mode 13

W

Writing Text/Numbers
add space in text 13
pause 13
upper/lower case 13



GLOBAL HEADQUARTERS	U.S.	EMEA	CALA	ASIA PACIFIC
Tel: +1(613) 592-2122	Tel: +1(480) 961-9000	Tel: +44(0)1291-430000	Tel: +1(613) 592-2122	Tel: +61(0) 2 9023 9500
Fax: +1(613) 592-4784	Fax: +1(480) 961-1370	Fax: +44(0)1291-430400	Fax: +1(613) 592-7825	Fax: +61(0) 2 9023 9501

FOR MORE INFORMATION ON OUR WORLDWIDE OFFICE LOCATIONS, VISIT OUR WEBSITE AT MITEL.COM/OFFICES

THIS DOCUMENT IS PROVIDED TO YOU FOR INFORMATIONAL PURPOSES ONLY. The information furnished in this document, believed by Mitel to be accurate as of the date of its publication, is subject to change without notice. Mitel assumes no responsibility for any errors or omissions in this document and shall have no obligation to you as a result of having made this document available to you or based upon the information it contains.

M MITEL (design) is a registered trademark of Mitel Networks Corporation. All other products and services are the registered trademarks of their respective holders.

© Copyright 2012, Mitel Networks Corporation. All Rights Reserved.

mitel.com

