

B222s

LTE Outdoor CPE

User's Guide



Default Login Details

Web Address	http://192.168.1.1
User Name	admin
Password	1234

Edition 1, 6/2012

www.huawei.com



Graphics in this book may differ slightly from the product due to differences in operating systems, operating system versions, or if you installed updated firmware/software for your device. Every effort has been made to ensure that the information in this manual is accurate.

Related Documentation

- Quick Start Guide

The Quick Start Guide shows how to connect the LTE Device and access the Web Configurator wizards. (See the wizard real time help for information on configuring each screen.) It also contains a connection diagram and package contents list.

Note: It is recommended you use the Web Configurator to configure the LTE Device.

Contents Overview

User's Guide	13
Introduction	15
Introducing the Web Configurator	21
Technical Reference	27
Connection Status and System Info	29
Broadband	35
Wireless	43
Home Networking	69
Routing	75
DNS Route	79
Quality of Service (QoS)	83
Network Address Translation (NAT)	95
Dynamic DNS	103
Firewall	105
MAC Filter	115
Parental Control	117
VoIP	121
Logs	145
Traffic Status	149
User Account	155
Remote MGMT	157
System	159
Time Setting	161
Log Setting	163
Firmware Upgrade	165
Backup/Restore	167
Diagnostic	171
Troubleshooting	173

Table of Contents

Contents Overview	3
Table of Contents	5
Part I: User's Guide	13
Chapter 1	
Introduction.....	15
1.1 Overview	15
1.2 Applications for the LTE Device	15
1.2.1 Internet Access	15
1.2.2 VoIP Features	16
1.2.3 Wireless Connection	16
1.3 The WLAN Button	16
1.4 Ways to Manage the LTE Device	18
1.5 Good Habits for Managing the LTE Device	18
1.6 LEDs (Lights)	18
1.7 The RESET Button	20
Chapter 2	
Introducing the Web Configurator	21
2.1 Overview	21
2.1.1 Accessing the Web Configurator	21
2.2 The Web Configurator Layout	23
2.2.1 Title Bar	23
2.2.2 Main Window	24
2.2.3 Traffic Status	24
2.2.4 User Account	24
2.2.5 Navigation Panel	24
Part II: Technical Reference.....	27
Chapter 3	
Connection Status and System Info	29
3.1 Overview	29
3.2 The Connection Status Screen	29

3.3 The System Info Screen	31
Chapter 4	
Broadband.....	35
4.1 Overview	35
4.1.1 What You Can Do in this Chapter	35
4.1.2 What You Need to Know	35
4.1.3 Before You Begin	38
4.2 The Broadband Screen	38
4.2.1 Add/Edit Internet Connection	39
4.3 Technical Reference	41
Chapter 5	
Wireless.....	43
5.1 Overview	43
5.1.1 What You Can Do in this Chapter	43
5.1.2 Wireless Network Overview	43
5.1.3 Before You Begin	45
5.2 The Wireless General Screen	45
5.2.1 No Security	47
5.2.2 Basic (Static WEP/Shared WEP Encryption)	47
5.2.3 More Secure (WPA(2)-PSK)	49
5.2.4 WPA(2) Authentication	50
5.3 The More AP Screen	51
5.3.1 Edit More AP	52
5.4 The WPS Screen	53
5.5 The WMM Screen	55
5.6 Scheduling Screen	57
5.7 Technical Reference	57
5.7.1 Additional Wireless Terms	58
5.7.2 Wireless Security Overview	58
5.7.3 Signal Problems	60
5.7.4 BSS	61
5.7.5 MBSSID	61
5.7.6 WiFi Protected Setup (WPS)	62
Chapter 6	
Home Networking.....	69
6.1 Overview	69
6.1.1 What You Can Do in this Chapter	69
6.1.2 What You Need To Know	69
6.2 The LAN Setup Screen	71
6.3 The Static DHCP Screen	72

6.3.1 Before You Begin	72
6.4 The UPnP Screen	73
Chapter 7	
Routing	75
7.1 Overview	75
7.2 Configuring Static Route	76
7.2.1 Add/Edit Static Route	77
Chapter 8	
DNS Route	79
8.1 Overview	79
8.1.1 What You Can Do in this Chapter	79
8.2 The DNS Route Screen	80
8.2.1 Add/Edit DNS Route Edit	80
Chapter 9	
Quality of Service (QoS).....	83
9.1 Overview	83
9.1.1 What You Can Do in this Chapter	83
9.1.2 What You Need to Know	83
9.2 The QoS General Screen	84
9.3 The Queue Setup Screen	86
9.3.1 Add/Edit a QoS Queue	87
9.4 The Class Setup Screen	87
9.4.1 Add/Edit QoS Class	89
9.5 The QoS Monitor Screen	92
9.6 QoS Technical Reference	92
9.6.1 IEEE 802.1p	93
9.6.2 IP Precedence	93
9.6.3 DiffServ	93
Chapter 10	
Network Address Translation (NAT).....	95
10.1 Overview	95
10.1.1 What You Can Do in this Chapter	95
10.1.2 What You Need To Know	95
10.2 The Port Forwarding Screen	96
10.2.1 The Port Forwarding Screen	97
10.2.2 The Port Forwarding Edit Screen	98
10.3 The DMZ Screen	99
10.4 The Sessions Screen	99
10.5 Technical Reference	100

10.5.1 NAT Definitions	100
10.5.2 What NAT Does	101
10.5.3 How NAT Works	101
Chapter 11	
Dynamic DNS	103
11.1 Overview	103
11.1.1 What You Need To Know	103
11.2 The Dynamic DNS Screen	104
Chapter 12	
Firewall	105
12.1 Overview	105
12.1.1 What You Can Do in this Chapter	105
12.1.2 What You Need to Know	106
12.2 The General Screen	107
12.3 The Services Screen	108
12.3.1 The Add New Services Entry Screen	108
12.4 The Access Control Screen	109
12.4.1 The Add New ACL Rule/Edit Screen	110
12.5 The DoS Screen	111
12.6 Firewall Technical Reference	112
12.6.1 Guidelines For Enhancing Security With Your Firewall	112
12.6.2 Security Considerations	112
Chapter 13	
MAC Filter	115
13.1 Overview	115
13.1.1 What You Need to Know	115
13.2 The MAC Filter Screen	115
Chapter 14	
Parental Control	117
14.1 Overview	117
14.2 The Parental Control Screen	117
14.2.1 Add/Edit a Parental Control Rule	118
Chapter 15	
VoIP	121
15.1 Overview	121
15.1.1 What You Can Do in this Chapter	121
15.1.2 What You Need to Know	121
15.1.3 Before You Begin	123

15.2 The SIP Service Provider Screen	123
15.3 The SIP Account Screen	129
15.3.1 Add/Edit SIP Account	130
15.4 Multiple SIP Accounts	132
15.5 Phone Screen	133
15.5.1 Edit Phone Device	133
15.6 The Phone Region Screen	134
15.7 The Call Rule Screen	134
15.8 Technical Reference	136
15.8.1 VoIP	136
15.8.2 SIP	136
15.8.3 Quality of Service (QoS)	140
15.8.4 Phone Services Overview	141
Chapter 16	
Logs	145
16.1 Overview	145
16.1.1 What You Can Do in this Chapter	145
16.1.2 What You Need To Know	145
16.2 The System Log Screen	146
16.3 The Phone Log Screen	147
16.4 The VoIP Call History Screen	147
Chapter 17	
Traffic Status	149
17.1 Overview	149
17.1.1 What You Can Do in this Chapter	149
17.2 The WAN Status Screen	149
17.3 The LAN Status Screen	150
17.4 The NAT Status Screen	151
17.5 The VoIP Status Screen	152
Chapter 18	
User Account	155
18.1 Overview	155
18.2 The User Account Screen	155
Chapter 19	
Remote MGMT	157
19.1 Overview	157
19.1.1 What You Need to Know	157
19.2 The Remote MGMT Screen	157

Chapter 20
System 159

 20.1 Overview 159

 20.1.1 What You Need to Know 159

 20.2 The System Screen 159

Chapter 21
Time Setting 161

 21.1 Overview 161

 21.2 The Time Setting Screen 161

Chapter 22
Log Setting 163

 22.1 Overview 163

 22.2 The Log Setting Screen 163

Chapter 23
Firmware Upgrade 165

 23.1 Overview 165

 23.2 The Firmware Upgrade Screen 165

Chapter 24
Backup/Restore 167

 24.1 Overview 167

 24.2 The Backup/Restore Screen 167

 24.3 The Reboot Screen 169

Chapter 25
Diagnostic 171

 25.1 Overview 171

 25.2 The Ping/TraceRoute Screen 171

Chapter 26
Troubleshooting..... 173

 26.1 Overview 173

 26.2 Power, Hardware Connections, and LEDs 173

 26.3 LTE Device Access and Login 174

 26.4 Internet Access 175

 26.5 Wireless Internet Access 176

 26.6 Phone Calls and VoIP 177

 26.7 UPnP 178

Appendix A IP Addresses and Subnetting..... 179

Appendix B Setting Up Your Computer's IP Address 189

Appendix C Pop-up Windows, JavaScript and Java Permissions 219

Appendix D Wireless LANs..... 229

Appendix E Common Services 249

Appendix F Legal Information..... 253

Index 255

PART I

User's Guide

Introduction

1.1 Overview

The Device is an LTE (Long Term Evolution) device including an outdoor unit (ODU) and an indoor unit (IDU). The LTE Device supports Voice over IP (VoIP) communication capabilities to allow you to use a traditional analog telephone to make Internet calls. The LTE Device also provides a complete security solution with a robust firewall based on Stateful Packet Inspection (SPI) technology and Denial of Service (DoS).

See the chapter on product specifications for a full list of features.

1.2 Applications for the LTE Device

Here are some example uses for which the LTE Device is well suited.

1.2.1 Internet Access

Your LTE Device provides Internet access by connecting to an LTE network wirelessly.

Computers can connect to the LTE Device's **ETHERNET** ports (or wirelessly).

Figure 1 LTE Device's Internet Access Application

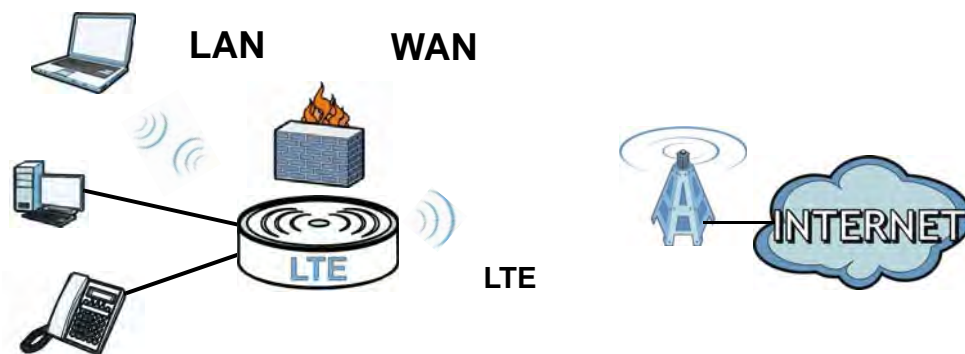

1.2.2 VoIP Features

You can register 1 SIP (Session Initiation Protocol) profile (2 accounts for that profile) and use the LTE Device to make and receive VoIP telephone calls:

Figure 2 LTE Device's VoIP Application

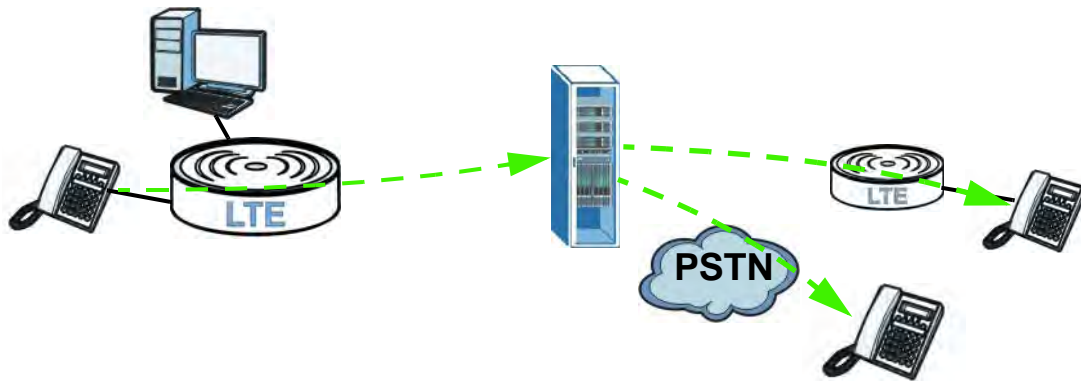

The LTE Device sends your call to a VoIP service provider's SIP server which forwards your calls to either VoIP or PSTN phones.

1.2.3 Wireless Connection

By default, the wireless LAN (WLAN) is enabled on the LTE Device. Once Wireless is enabled, IEEE 802.11b/g/n compliant clients can wirelessly connect to the LTE Device to access network resources. You can set up a wireless network with WPS (WiFi Protected Setup) or manually add a client to your wireless network.

Figure 3 Wireless Connection Application

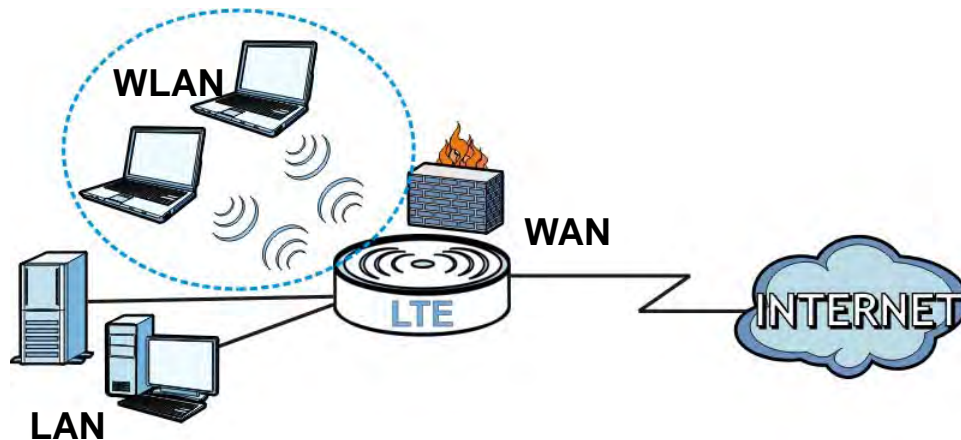

1.3 The WLAN Button

You can use the **WIRELESS On/Off** button on top of the device to turn the wireless LAN on or off. You can also use it to activate WPS in order to quickly set up a wireless network with strong security.

Turn the Wireless LAN On or Off

- 1 Make sure the **PWR/SYS** LED is on (not blinking).
- 2 Press the **WIRELESS On/Off** button for one second and release it. The **WLAN/WPS** LED should change from on to off or vice versa.

Activate WPS

- 1 Make sure the **PWR/SYS** LED is on (not blinking).
- 2 Press the **WIRELESS On/Off** button for more than five seconds and release it. Press the WPS button on another WPS -enabled device within range of the LTE Device. The **WLAN/WPS** LED should flash while the LTE Device sets up a WPS connection with the wireless device.

Note: You must activate WPS in the LTE Device and in another wireless device within two minutes of each other. See [Chapter 5 on page 62](#) for more information.

1.4 Ways to Manage the LTE Device

- Web Configurator. This is for management of the LTE Device using a (supported) web browser.

1.5 Good Habits for Managing the LTE Device

Do the following things regularly to make the LTE Device more secure and to manage the LTE Device more effectively.

- Change the password. Use a password that's not easy to guess and that consists of different types of characters, such as numbers and letters.
- Write down the password and put it in a safe place.
- Back up the configuration (and make sure you know how to restore it). Restoring an earlier working configuration may be useful if the device becomes unstable or even crashes. If you forget your password to access the Web Configurator, you will have to reset the LTE Device to its factory default settings. If you backed up an earlier configuration file, you would not have to totally re-configure the LTE Device. You could simply restore your last configuration. Keep in mind that backing up a configuration file will not back up passwords used to set up PPPoE and VoIP. Write down any information your ISP provides you.

1.6 LEDs (Lights)

The following graphic displays the labels of the LEDs.

Figure 4 LEDs on the Top of the Device



Figure 5 LEDs on the Ethernet Ports

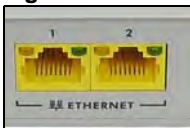

None of the LEDs are on if the LTE Device is not receiving power.

Table 1 LED Descriptions (From Left To Right)

LED	COLOR	STATUS	DESCRIPTION
PWR/SYS	Green	On	The LTE Device is receiving power and ready for use.
		Blinking	The LTE Device is booting up.
	Red	On	The LTE Device detected an error while self-testing, or there is a device malfunction.
		Blinking	The LTE Device is upgrading the firmware.
Off		The LTE Device is not receiving power.	

Table 1 LED Descriptions (From Left To Right) (continued)

LED	COLOR	STATUS	DESCRIPTION
LINK	Green	On	The LTE Device has an LTE connection on the WAN.
		Blinking	The LTE Device is searching for a frequency channel or is performing network entry.
	Off		The LTE Device does not have an LTE connection on the WAN.
LTE			The LTE LEDs display the Received Signal Strength Indication (RSSI) of the LTE connection. Three signals on at the same time means best signal quality, two means medium signal quality, and one means low signal quality.
		No Signal LEDs	There is no LTE connection.
	Green	Signal 1 On	The signal strength is less than -90 dBm if signal 1 is on only.
		Signal 2 On	The signal strength is between -90 dBm and -70 dBm if both signals 1 and 2 are on.
		Signal 3 On	The signal strength is -70 dBm or greater if three signals are all on.
WLAN/WPS	Green	On	The wireless network is activated and is operating in IEEE 802.11 "b", "g" or "n" mode.
		Blinking	The LTE Device is communicating with other wireless clients.
	Orange	Blinking	The LTE Device is setting up a WPS connection.
	Off		The wireless network is not activated.
PHONE	Green	On	A SIP account is registered for the phone port.
		Blinking	A telephone connected to the phone port has its receiver off of the hook or there is an incoming call.
	Orange	On	A SIP account is registered for the phone port and there is a voice message in the corresponding SIP account.
		Blinking	A telephone connected to the phone port has its receiver off of the hook and there is a voice message in the corresponding SIP account.
	Off		The phone port does not have a SIP account registered.
ETHERNET1-2	Yellow (Giga Ethernet)	On	The LTE Device has a successful 1000 Mbps Ethernet connection with a device on the Local Area Network (LAN).
		Blinking	The LTE Device is sending or receiving data to/from the LAN at 1000 Mbps.
	Green (Fast Ethernet)	On	The LTE Device has a successful 10/100 Mbps Ethernet connection with a device on the Local Area Network (LAN).
		Blinking	The LTE Device is sending or receiving data to/from the LAN at 10/100 Mbps.
	Off		The LTE Device does not have an Ethernet connection with the LAN.

Refer to the Quick Start Guide for information on hardware connections.

1.7 The RESET Button

If you forget your password or cannot access the web configurator, you will need to use the **RESET** button at the back of the device to reload the factory-default configuration file. This means that you will lose all configurations that you had previously and the passwords will be reset to the defaults.

- 1 Make sure the **POWER** LED is on (not blinking).
- 2 To set the device back to the factory default settings, press the **RESET** button for 5 seconds or until the **POWER** LED begins to blink and then release it. When the **POWER** LED begins to blink, the defaults have been restored and the device restarts.

Introducing the Web Configurator

2.1 Overview

The web configurator is an HTML-based management interface that allows easy device setup and management via Internet browser. Use Internet Explorer 6.0 and later versions, Mozilla Firefox 3 and later versions, or Safari 2.0 and later versions. The recommended screen resolution is 1024 by 768 pixels.

In order to use the web configurator you need to allow:

- Web browser pop-up windows from your device. Web pop-up blocking is enabled by default in Windows XP SP (Service Pack) 2.
- JavaScript (enabled by default).
- Java permissions (enabled by default).

See [Appendix C on page 219](#) if you need to make sure these functions are allowed in Internet Explorer.

2.1.1 Accessing the Web Configurator

- 1 Make sure your LTE Device hardware is properly connected (refer to the Quick Start Guide).
- 2 Launch your web browser.
- 3 Type "192.168.1.1" as the URL.
- 4 A password screen displays. Type "admin" as the default Username and "1234" as the default password to access the device's Web Configurator. Click **Login**. If you have changed the password, enter your password and click **Login**.

Figure 6 Password Screen

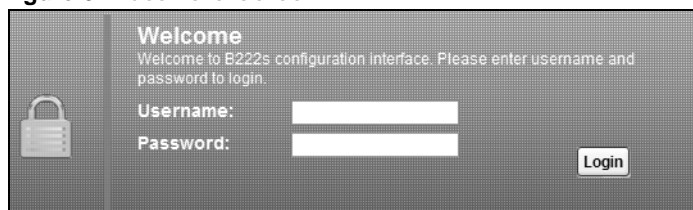

Note: For security reasons, the LTE Device automatically logs you out if you do not use the web configurator for five minutes (default). If this happens, log in again.

- The following screen displays if you have not yet changed your password. It is strongly recommended you change the default password. Enter a new password, retype it to confirm and click **Apply**; alternatively click **Skip** to proceed to the main menu if you do not want to change the password now.

Figure 7 Change Password Screen

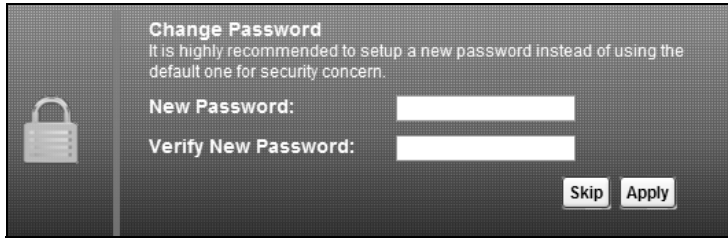

- The **Connection Status** screen appears.

Figure 8 Connection Status



- Click **System Info** to display the **System Info** screen, where you can view the LTE Device's interface and system information.

2.2 The Web Configurator Layout

Click **Connection Status > System Info** to show the following screen. (See [Section 3.3](#) on page 31 for more information.)

Figure 9 Web Configurator Layout



As illustrated above, the main screen is divided into these parts:

- A - title bar
- B - main window
- C - navigation panel

2.2.1 Title Bar

The title bar shows the following icon in the upper right corner.



Click this icon to log out of the web configurator.

2.2.2 Main Window

The main window displays information and configuration fields. It is discussed in the rest of this document.

After you click **System Info** on the **Connection Status** screen, the **System Info** screen is displayed. See [Chapter 3 on page 31](#) for more information about the **System Info** screen.

If you click **LAN Device** on the **System Info** screen (a in [Figure 9 on page 23](#)), the **Connection Status** screen appears. See [Chapter 3 on page 29](#) for more information about the **Connection Status** screen.

If you click **Virtual Device** on the **System Info** screen (b in [Figure 9 on page 23](#)), a visual graphic appears, showing the connection status of the LTE Device's ports. The connected ports are in color and disconnected ports are gray.

Figure 10 Virtual Device

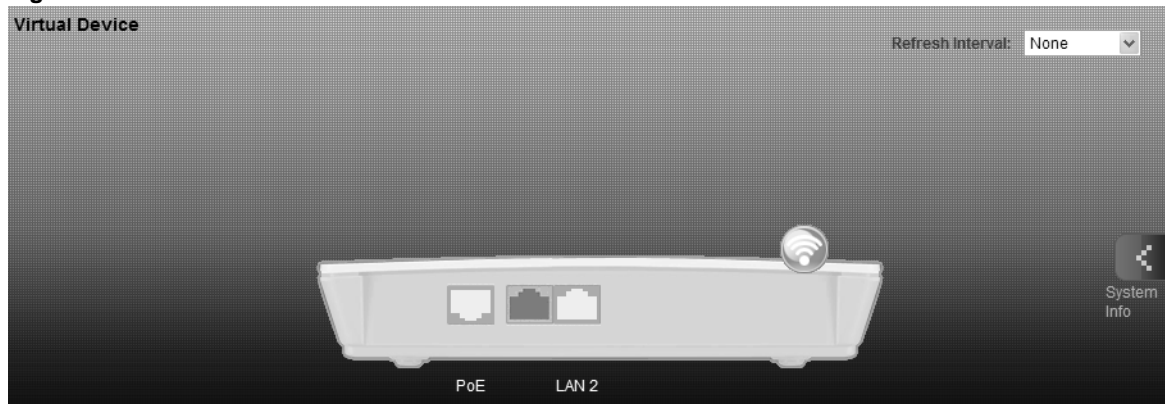

2.2.3 Traffic Status

Use the **Maintenance > Traffic Status** screens to look at network traffic status and statistics of the WAN, LAN interfaces and NAT. See [Chapter 20 on page 159](#) for more information.

2.2.4 User Account

Use the **Maintenance > User Accounts** screen to configure system password for different user accounts. See [Chapter 18 on page 155](#) for more information.

2.2.5 Navigation Panel

Use the menu items on the navigation panel to open screens to configure LTE Device features. The following table describes each menu item.

Table 2 Navigation Panel Summary

LINK	TAB	FUNCTION
Connection Status		This screen shows the network status of the LTE Device and computers/devices connected to it.
Network Setting		

Table 2 Navigation Panel Summary (continued)

LINK	TAB	FUNCTION
Broadband	Broadband	Use this screen to view and modify your WAN interface. You can also configure ISP parameters, WAN IP address assignment, DNS servers and other advanced properties.
Wireless	General	Use this screen to turn the wireless connection on or off, specify the SSID(s) and configure the wireless LAN settings and WLAN authentication/security settings.
	More AP	Use this screen to configure multiple BSSs on the LTE Device.
	WPS	Use this screen to use WPS (Wi-Fi Protected Setup) to establish a wireless connection.
	WMM	Use this screen to enable or disable Wi-Fi MultiMedia (WMM).
	Scheduling	Use this screen to configure when the LTE Device enables or disables the wireless LAN.
Home Networking	LAN Setup	Use this screen to configure LAN TCP/IP settings, and other advanced properties.
	Static DHCP	Use this screen to assign specific IP addresses to individual MAC addresses.
	UPnP	Use this screen to enable the UPnP function.
Static Route	Static Route	Use this screen to view and set up static routes on the LTE Device.
DNS Route	DNS Route	Use this screen to view and configure DNS routes.
QoS	General	Use this screen to enable QoS and decide allowable bandwidth using QoS.
	Queue Setup	Use this screen to configure QoS queue assignment.
	Class Setup	Use this screen to set up classifiers to sort traffic into different flows and assign priority and define actions to be performed for a classified traffic flow.
	Monitor	Use this screen to view each queue's statistics.
NAT	Port Forwarding	Use this screen to make your local servers visible to the outside world.
	DMZ	Use this screen to configure the IP address of the LTE Device's DMZ interface.
	Sessions	Use this screen to limit the number of NAT sessions a single client can establish.
Dynamic DNS	Dynamic DNS	Use this screen to allow a static hostname alias for a dynamic IP address.
Security		
Firewall	General	Use this screen to activate/deactivate the firewall.
	Services	Use this screen to view and configure services.
	Access Control	Use this screen to view and configure filter rules for incoming and outgoing traffic.
	DoS	Use this screen to activate/deactivate Denial of Service (DoS) protection.
MAC Filter	MAC Filter	Use this screen to allow specific devices to access the LTE Device.
Parental Control	Parental Control	Use this screen to define time periods and days during which the LTE Device performs parental control and/or block web sites with the specific URL.
VoIP		

Table 2 Navigation Panel Summary (continued)

LINK	TAB	FUNCTION
SIP	SIP Service Provider	Use this screen to configure your LTE Device's Voice over IP settings.
	SIP Account	Use this screen to set up information about your SIP account and configure audio settings such as volume levels for the phones connected to the LTE Device.
Phone	Phone Device	Use this screen to set which phone ports use which SIP accounts.
	Region	Use this screen to select your location.
Call Rule	Speed Dial	Use this screen to configure speed dial for SIP phone numbers that you call often.
System Monitor		
Log	System Log	Use this screen to view the system logs for the categories that you select.
	Phone Log	Use this screen to view the LTE Device's phone logs.
	VoIP Call History	Use this screen to view the LTE Device's VoIP call history.
Traffic Status	WAN	Use this screen to view the status of all network traffic going through the WAN port of the LTE Device.
	LAN	Use this screen to view the status of all network traffic going through the LAN ports of the LTE Device.
	NAT	Use this screen to view the status of NAT sessions on the LTE Device.
VoIP Status	VoIP Status	Use this screen to view the SIP, phone, and call status of the LTE Device.
Maintenance		
Users Account	Users Account	Use this screen to configure the passwords your user accounts.
Remote MGMT	Remote MGMT	Use this screen to enable specific traffic directions for network services.
System	System	Use this screen to configure the LTE Device's name, domain name, management inactivity time-out.
Time Setting	Time Setting	Use this screen to change your LTE Device's time and date.
Log Setting	Log Setting	Use this screen to select which logs and/or immediate alerts your device is to record. You can also set it to e-mail the logs to you.
Firmware Upgrade	Firmware Upgrade	Use this screen to upload firmware to your device.
Backup/Restore	Backup/Restore	Use this screen to backup and restore your device's configuration (settings) or reset the factory default settings.
Reboot	Reboot	Use this screen to reboot the LTE Device without turning the power off.
Diagnostic	Ping/TraceRoute	Use this screen to test the connections to other devices.
Auto Provision	Auto Provision	Use this screen to configure auto provision which automatically updates the latest firmware and configuration to the LTE Device.

PART II

Technical Reference

The appendices provide general information. Some details may not apply to your LTE Device.

Connection Status and System Info

3.1 Overview

After you log into the web configurator, the **Connection Status** screen appears. This shows the network connection status of the LTE Device and clients connected to it.

Use the **System Info** screen to look at the current status of the device, system resources, interfaces (LAN, WAN and WLAN), and SIP accounts. You can also register and unregister SIP accounts.

If you click **Virtual Device** on the **System Info** screen, a visual graphic appears, showing the connection status of the LTE Device's ports. See [Section 2.2.2 on page 24](#) for more information.

3.2 The Connection Status Screen

Use this screen to view the network connection status of the device and its clients. A warning message appears if there is a connection problem.

If you prefer to view the status in a list, click **List View** in the **Viewing mode** selection box. You can configure how often you want the LTE Device to update this screen in **Refresh Interval**.

Figure 11 Connection Status: Icon View

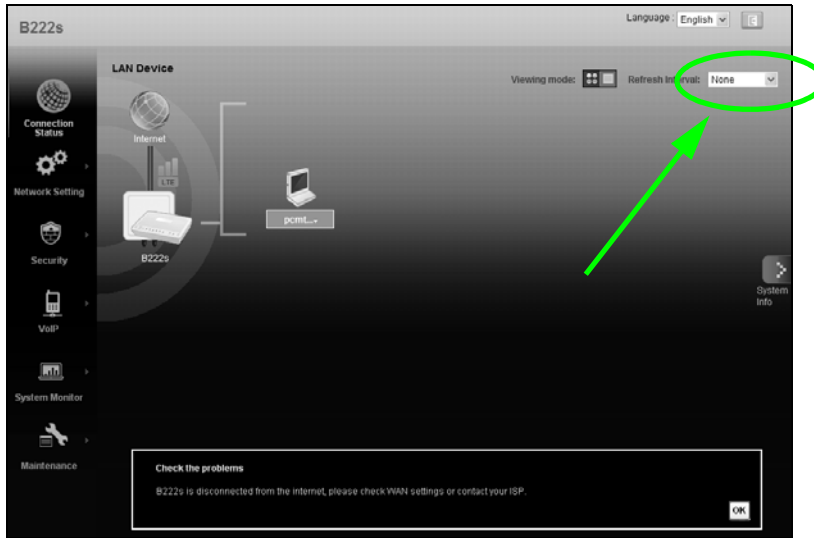

Figure 12 Connection Status: List View

#	Device Name	IP Address	MAC Address	Address Source	Connection Type
1	pc01	192.168.1.37	00:24:21:70:f8:44	DHCP	Ethernet

In **Icon View**, if you want to view information about a client, click the client's name and **Info**. Click the IP address if you want to change it. If you want to change the name or icon of the client, click **Change name/icon**.

In **List View**, you can also view the client's information.

3.3 The System Info Screen

Click **Connection Status > System Info** to open this screen.

Figure 13 System Info Screen

The screenshot shows the 'System Info' screen with a 'Refresh Interval' dropdown set to 'None'. The screen is divided into several sections:

- Device Information:** A list of fields including Host Name (router), Model Name (M4G-331M2W-IDU), MAC Address (00:13:49:11:66:8f), Firmware Version (V3.11(VKA.0)b3-Huawei), WAN Information (LTE WAN), LAN Information (IP Address: 192.168.1.1, Subnet Mask: 255.255.255.0, DHCP Server: Server), WLAN Information (Channel: N/A, WPS Status: Unconfigured), and four SSID entries (SSID1-4) with their respective SSIDs, statuses, and security modes.
- LTE Status:** A table showing LTE Status (Down), Signal Strength (N/A), Service Provider (N/A), Frequency Band (N/A), Connection Uptime (0 Day(s), 0 Hour(s), 0 Minute(s), 0 Second(s)), ODU F/W Version (N/A), Module F/W Version (N/A), IMEI (N/A), and IMSI (N/A).
- Interface Status:** A table with columns Interface, Status, and Rate. It lists LTE WAN (Down, N/A), LAN 1 (Down, N/A), LAN 2 (Up, 1000Mbps), and WLAN (Down, N/A).
- System Status:** A table showing System Up Time (1:30), Current Date/Time (Sat Jan 1 02:29:59 CET 2000), System Resource (CPU Usage: 0.0%, Memory Usage: 58.8%), and progress bars for each resource.
- Registration Status:** A table with columns Account, Action, Account Status, and URI. It lists SIP 1 and SIP 2, both with 'Register' buttons, 'In-Active' status, and 'ChangeMe@ChangeMe' URIs.

Each field is described in the following table.

Table 3 System Info Screen

LABEL	DESCRIPTION
Language	Select the web configurator language from the drop-down list box.
Refresh Interval	Select how often you want the LTE Device to update this screen from the drop-down list box.
Device Information	
Host Name	This field displays the LTE Device system name. It is used for identification. You can change this in the Maintenance > System screen's Host Name field.
Model Name	This is the model name of your device.
MAC Address	This is the MAC (Media Access Control) or Ethernet address unique to your LTE Device.

Table 3 System Info Screen (continued)

LABEL	DESCRIPTION
Firmware Version	This field displays the current version of the firmware inside the device. It also shows the date the firmware version was created. Go to the Maintenance > Firmware Upgrade screen to change it.
WAN Information	
Mode	This is the method of encapsulation used by your ISP.
IP Address	This field displays the current IP address of the LTE Device in the WAN.
LAN Information	
IP Address	This field displays the current IP address of the LTE Device in the LAN.
IP Subnet Mask	This field displays the current subnet mask in the LAN.
DHCP Server	This field displays what DHCP services the LTE Device is providing to the LAN. Choices are: Server - The LTE Device is a DHCP server in the LAN. It assigns IP addresses to other computers in the LAN. None - The LTE Device is not providing any DHCP services to the LAN.
WLAN Information	
Channel	This is the channel number used by the LTE Device now.
WPS Status	Configured displays when a wireless client has connected to the LTE Device or WPS is enabled and wireless or wireless security settings have been configured. Unconfigured displays if WPS is disabled or wireless security settings have not been configured.
SSID (1~4) Information	
SSID	This is the descriptive name used to identify the LTE Device in the wireless LAN.
Status	This shows whether or not the SSID is enabled (on).
Security Mode	This displays the type of security the LTE Device is using in the wireless LAN.
LTE Status	
Status	This displays 4G LTE if there is an LTE connection, otherwise, it displays N/A .
Signal Strength	This displays the strength of the LTE connection that the LTE Device has with the base station which is also known as eNodeB or eNB.
Service Provider	This displays the service provider's name of the connected LTE network.
Frequency Band	This displays LTE if there is an LTE connection.
Connection Uptime	This displays how long the LTE connection has been available since it was last established successfully.
ODU F/W Version	This displays the firmware version of the outdoor unit.
Module F/W Version	This displays the firmware version of LTE module.
IMEI	This displays the LTE Device's International Mobile Equipment Identity number (IMEI). An IMEI is a unique ID used to identify a mobile device.
IMSI	This displays the International Mobile Subscriber Identity (IMSI) of the SIM card inserted in the outdoor unit. An IMSI is a unique ID used to identify a mobile subscriber in a mobile network.
Interface Status	
Interface	This column displays each interface the LTE Device has.

Table 3 System Info Screen (continued)

LABEL	DESCRIPTION
Status	<p>This field indicates whether or not the LTE Device is using the interface.</p> <p>For the LTE WAN interface, this field displays Up when the LTE Device is connected to an LTE network and Down when the LTE Device does not have an LTE connection.</p> <p>For the LAN interface, this field displays Up when the LTE Device is using the interface and Down when the LTE Device is not using the interface.</p> <p>For the WLAN interface, it displays Up when WLAN is enabled or Down when WLAN is disabled.</p>
Rate	<p>For the LTE WAN interface, this displays 4G LTE if there is an LTE connection.</p> <p>For the LAN interface, this displays the port speed and duplex setting.</p> <p>For the WLAN interface, it displays the maximum transmission rate when WLAN is enabled or N/A when WLAN is disabled.</p>
System Status	
System Up Time	<p>This field displays how long the LTE Device has been running since it last started up. The LTE Device starts up when you plug it in, when you restart it (Maintenance > Reboot), or when you reset it (see Section 1.7 on page 20).</p>
Current Date/Time	<p>This field displays the current date and time in the LTE Device. You can change this in Maintenance > Time Setting.</p>
System Resource	
CPU Usage	<p>This field displays what percentage of the LTE Device's processing ability is currently used. When this percentage is close to 100%, the LTE Device is running at full load, and the throughput is not going to improve anymore. If you want some applications to have more throughput, you should turn off other applications.</p>
Memory Usage	<p>This field displays what percentage of the LTE Device's memory is currently used. Usually, this percentage should not increase much. If memory usage does get close to 100%, the LTE Device is probably becoming unstable, and you should restart the device. See Chapter 24 on page 169, or turn off the device (unplug the power) for a few seconds.</p>
Registration Status	
Account	<p>This column displays each SIP account in the LTE Device.</p>
Action	<p>This field displays the current registration status of the SIP account. You have to register SIP accounts with a SIP server to use VoIP.</p> <p>If the SIP account is already registered with the SIP server,</p> <ul style="list-style-type: none"> • Click Unregister to delete the SIP account's registration in the SIP server. This does not cancel your SIP account, but it deletes the mapping between your SIP identity and your IP address or domain name. • The second field displays Registered. <p>If the SIP account is not registered with the SIP server,</p> <ul style="list-style-type: none"> • Click Register to have the LTE Device attempt to register the SIP account with the SIP server. • The second field displays the reason the account is not registered. <p>Inactive - The SIP account is not active. You can activate it in VoIP > SIP > SIP Settings.</p> <p>Register Fail - The last time the LTE Device tried to register the SIP account with the SIP server, the attempt failed. The LTE Device automatically tries to register the SIP account when you turn on the LTE Device or when you activate it.</p>

Table 3 System Info Screen (continued)

LABEL	DESCRIPTION
Account Status	This shows Active when the SIP account has been registered and ready for use or In-Active when the SIP account is not yet registered.
URI	This field displays the account number and service domain of the SIP account. You can change these in VoIP > SIP > SIP Settings .

Broadband

4.1 Overview

This chapter discusses the LTE Device's **Broadband** screens. Use these screens to configure your LTE Device for Internet access.

A WAN (Wide Area Network) connection is an outside connection to another network or the Internet. It connects your private networks, such as a LAN (Local Area Network) and other networks, so that a computer in one location can communicate with computers in other locations.

This LTE Device supports LTE connection for the WAN only.

Figure 14 LAN and WAN

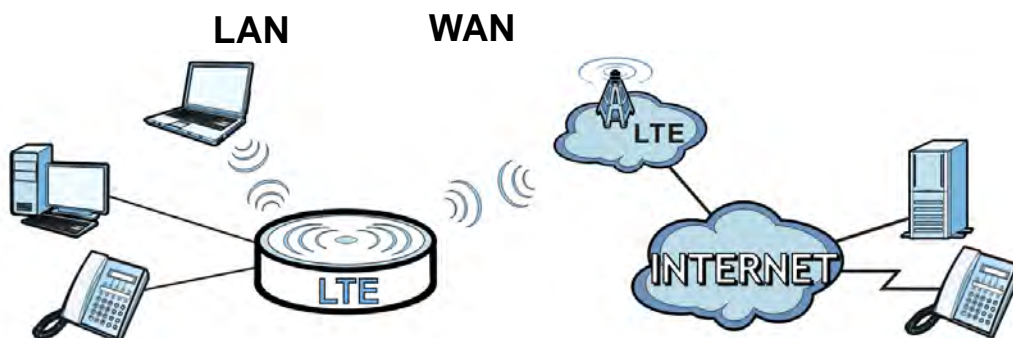

4.1.1 What You Can Do in this Chapter

- Use the **Broadband** screen to view, remove or add an LTE WAN interface. You can also configure the WAN settings on the LTE Device for Internet access ([Section 4.2 on page 38](#)).

4.1.2 What You Need to Know

The following terms and concepts may help as you read this chapter.

Encapsulation Method

Encapsulation is used to include data from an upper layer protocol into a lower layer protocol. To set up a WAN connection to the Internet, you need to use the same encapsulation method used by your ISP (Internet Service Provider).

WAN IP Address

The WAN IP address is an IP address for the LTE Device, which makes it accessible from an outside network. It is used by the LTE Device to communicate with other devices in other networks. It can be static (fixed) or dynamically assigned by the ISP each time the LTE Device tries to access the Internet.

If your ISP assigns you a static WAN IP address, they should also assign you the subnet mask and DNS server IP address(es).

APN

Access Point Name (APN) is a unique string which indicates an LTE network. An APN is required for LTE stations to enter the LTE network and then the Internet.

CAPWAP

The LTE Device supports CAPWAP. This is ZyXEL's implementation of the CAPWAP protocol (RFC 5415).

The CAPWAP dataflow is protected by Datagram Transport Layer Security (DTLS).

The following figure illustrates a CAPWAP wireless network. You (**U**) configure the AP controller (**C**), which then automatically updates the configurations of the managed APs (**M1 ~ M4**).

Figure 15 CAPWAP Network Example

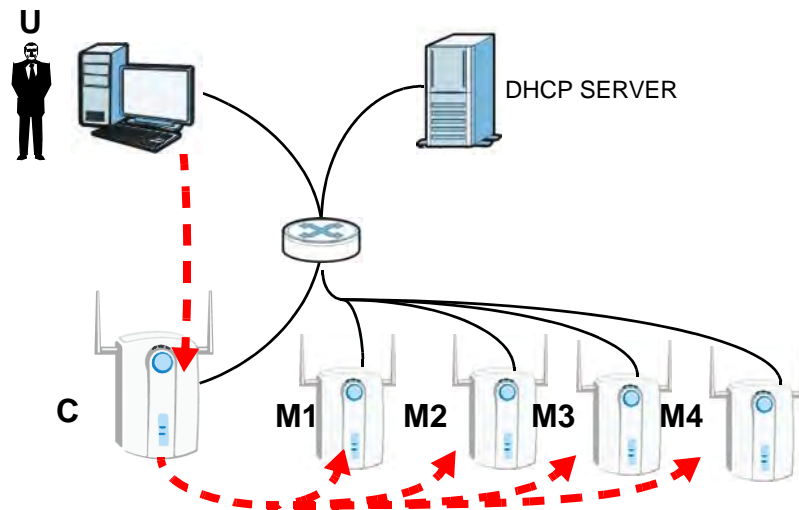

Note: The LTE Device can be a standalone AP (default), a CAPWAP managed AP, or a CAPWAP AP controller.

CAPWAP Discovery and Management

The link between CAPWAP-enabled access points proceeds as follows:

- 1 An AP in managed AP mode joins a wired network (receives a dynamic IP address).

- 2 The AP sends out a discovery request, looking for an AP in CAPWAP AP controller mode.
- 3 If there is an AP controller on the network, it receives the discovery request. If the AP controller is in **Manual** mode it adds the details of the AP to its **Unmanaged Access Points** list, and you decide which available APs to manage. If the AP is in **Always Accept** mode, it automatically adds the AP to its **Managed Access Points** list and provides the managed AP with default configuration information, as well as securely transmitting the DTLS pre-shared key. The managed AP is ready for association with wireless clients.

Managed AP Finds the Controller

A managed LTE Device can find the controller in one of the following ways:

- Manually specify the controller's IP address using the commands. See the LTE Device CLI Reference Guide for details.
- Get the controller's IP address from a DHCP server with the controller's IP address configured as option 138.
- Broadcasting to discover the controller within the broadcast domain.

The AP controller must have a static IP address; it cannot be a DHCP client.

CAPWAP and IP Subnets

By default, CAPWAP works only between devices with IP addresses in the same subnet (see the appendices for information on IP addresses and subnetting).

However, you can configure CAPWAP to operate between devices with IP addresses in different subnets by doing the following.

- Activate DHCP. Your network's DHCP server must support option 138 defined in RFC 5415.
- Configure DHCP option 138 with the IP address of the CAPWAP AP controller on your network.

DHCP Option 138 allows the CAPWAP management request (from the AP in managed AP mode) to reach the AP controller in a different subnet, as shown in the following figure.

Figure 16 CAPWAP and DHCP Option 138

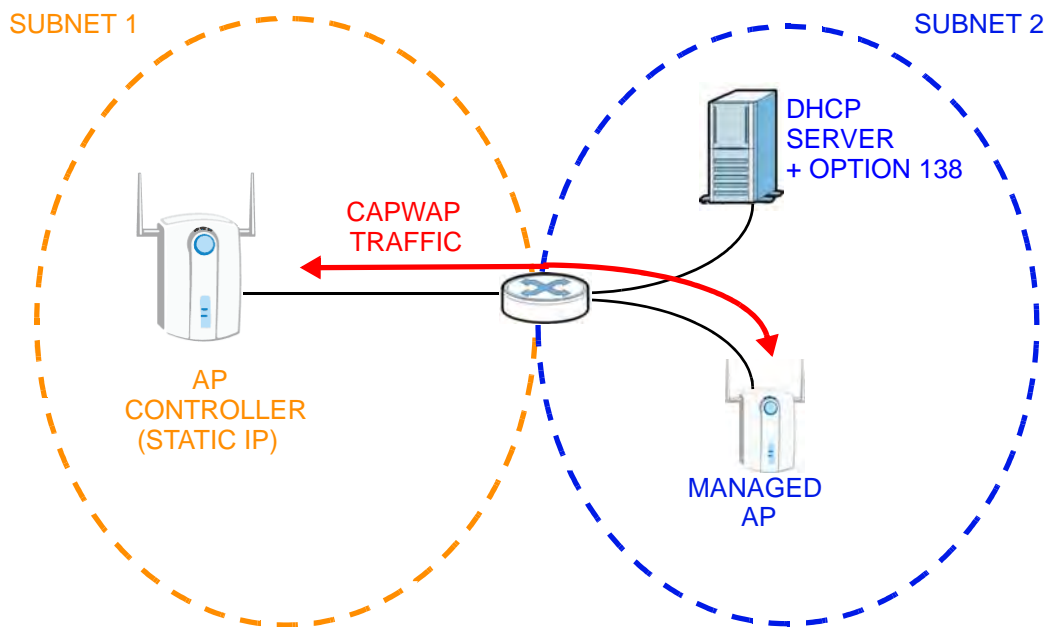

Notes on CAPWAP

This section lists some additional features of ZyXEL's implementation of the CAPWAP protocol.

- When the AP controller uses its internal Remote Authentication Dial In User Service (RADIUS) server, managed APs also use the AP controller's authentication server to authenticate wireless clients.
- If a managed AP's link to the AP controller is broken, the managed AP continues to use the wireless settings with which it was last provided.

4.1.3 Before You Begin

You may need to know your Internet access settings such as LTE APN, WAN IP address and SIM card's PIN code if the **INTERNET** light on your LTE Device is off. Get this information from your service provider.

4.2 The Broadband Screen

The LTE Device must have a WAN interface to allow users to use the LTE connection to access the Internet. Use the **Broadband** screen to view or modify a WAN interface. You can also configure the LTE Device as part of a Control And Provisioning of Wireless Access Points (CAPWAP) network in this screen.

Click **Network Setting > Broadband**. The following screen opens.

Figure 17 Network Setting > Broadband

The following table describes the fields in this screen.

Table 4 Network Setting > Broadband

LABEL	DESCRIPTION
CAPWAP Setting	
CAPWAP Enable	Select this to activate ??
CAPWAP AC Server	Enter the IP address of the AC server.??
Apply	Click this to save the change in this section.
Cancel	Click this to restore your previously saved settings in this section.
Internet Setup	
Name	This is the service name of the connection.
APN	This is the name of the LTE network to which the LTE Device will connect.
Encapsulation	This shows the method of encapsulation used by this connection.
NAT	This shows whether NAT is activated or not for this connection. NAT is not available when the connection uses the bridging service.
Default Gateway	This shows whether the LTE Device uses the interface of this connection as the system default gateway.
Modify	Click the Edit icon to configure the connection. Click the Delete icon to delete this connection from the Device. A window displays asking you to confirm that you want to delete the connection.

4.2.1 Add/Edit Internet Connection

Use this screen to configure a WAN connection. The screen varies depending on the interface type, encapsulation, and WAN service type you select.

Click the **Add new WAN Interface** in the **Network Setting > Broadband** screen or the **Edit** icon next to the connection you want to configure, the screen displays as shown next.

Figure 18 Broadband Add/Edit

The screenshot shows a configuration window for a Broadband WAN interface. It is organized into several sections:

- General:** Contains input fields for 'Name', 'APN', and 'Dial String'. Below these is a dropdown menu for 'IPv6/IPv4 Mode' currently set to 'IPv4 Only'.
- MTU:** Contains an input field for 'MTU' with the value '1500'.
- Routing Feature:** Contains two checkboxes: 'NAT Enable' and 'Apply as Default Gateway', both of which are currently unchecked.
- 6 to 4 Tunnel:** Contains a checkbox for '6to4 Tunneling', which is currently unchecked.

At the bottom right of the window, there are two buttons: 'Apply' and 'Back'.

The following table describes the fields in this screen.

Table 5 Broadband Add/Edit

LABEL	DESCRIPTION
Name	Specify the name for this WAN interface.??
APN	Enter the Access Point Name (APN) of an LTE network, which your service provider gave you.??
Dial String	Enter the dial string of your 3G net card.??
IPv6/IPv4 Mode	Select IPv4 Only if you just connect this WAN interface to an IPv4 network. Select IPv6/IPv4 Dual Stack if you connect this WAN interface to both an IPv6 and an IPv4 networks. Select IPv6 Only if you just connect this WAN interface to an IPv6 network.??
MTU	The Maximum Transmission Unit (MTU) defines the size of the largest packet allowed on an interface or connection. Enter the MTU for this WAN interface in this field.
NAT Enable	Select this to activate NAT on the WAN.
Apply as Default Gateway	??
6to4 Tunneling	Select this if you need to transmit IPv6 packets over the IPv4 network through this WAN interface, the IPv6 packets are encapsulated inside IPv4 packets.??
Apply	Click Apply to save your changes.
Back	Click Back to return to the previous screen.

4.3 Technical Reference

The following section contains additional technical information about the LTE Device features described in this chapter.

Encapsulation

Be sure to use the encapsulation method required by your ISP. The LTE Device supports the following methods:

IP Address Assignment

A static IP is a fixed IP that your ISP gives you. A dynamic IP is not fixed; the ISP assigns you a different one each time. The Single User Account feature can be enabled or disabled if you have either a dynamic or static IP. However the encapsulation method assigned influences your choices for IP address and default gateway.

DNS Server Address Assignment

Use Domain Name System (DNS) to map a domain name to its corresponding IP address and vice versa, for instance, the IP address of www.zyxel.com is 204.217.0.2. The DNS server is extremely important because without it, you must know the IP address of a computer before you can access it.

The LTE Device can get the DNS server addresses in the following ways.

- 1 The ISP tells you the DNS server addresses, usually in the form of an information sheet, when you sign up. If your ISP gives you DNS server addresses, manually enter them in the DNS server fields.
- 2 If your ISP dynamically assigns the DNS server IP addresses (along with the LTE Device's WAN IP address), set the DNS server fields to get the DNS server address from the ISP.

LTE Frequency Band Table

See the following table for the frequency bands used in LTE wireless technologies.

Table 6 LTE Wireless Technologies

BAND	UPLINK (UL) OPERATING BAND	DOWNLINK (DL) OPERATING BAND	DUPLEX MODE
	BASE STATION RECEIVE CPE TRANSMIT	BASE STATION TRANSMIT CPE RECEIVE	
	UL (LOW - HIGH)	DL (LOW - HIGH)	
1	1920 MHz – 1980 MHz	2110 MHz – 2170 MHz	FDD
2	1850 MHz – 1910 MHz	1930 MHz – 1990 MHz	FDD
3	1710 MHz – 1785 MHz	1805 MHz – 1880 MHz	FDD
4	1710 MHz – 1755 MHz	2110 MHz – 2155 MHz	FDD
5	824 MHz – 849 MHz	869 MHz – 894MHz	FDD
6	830 MHz – 840 MHz	875 MHz – 885 MHz	FDD
7	2500 MHz – 2570 MHz	2620 MHz – 2690 MHz	FDD

Table 6 LTE Wireless Technologies

BAND	UPLINK (UL) OPERATING BAND		DOWNLINK (DL) OPERATING BAND		DUPLEX MODE
	BASE STATION RECEIVE		BASE STATION TRANSMIT		
	CPE TRANSMIT		CPE RECEIVE		
	UL (LOW - HIGH)		DL (LOW - HIGH)		
8	880 MHz – 915 MHz		925 MHz – 960 MHz		FDD
9	1749.9 MHz – 1784.9 MHz		1844.9 MHz – 1879.9 MHz		FDD
10	1710 MHz – 1770 MHz		2110 MHz – 2170 MHz		FDD
11	1427.9 MHz – 1447.9 MHz		1475.9 MHz – 1495.9 MHz		FDD
12	699 MHz – 716 MHz		729 MHz – 746 MHz		FDD
13	777 MHz – 787 MHz		746 MHz – 756 MHz		FDD
14	788 MHz – 798 MHz		758 MHz – 768 MHz		FDD
15	Reserved		Reserved		FDD
16	Reserved		Reserved		FDD
17	704 MHz – 716 MHz		734 MHz – 746 MHz		FDD
18	815 MHz – 830 MHz		860 MHz – 875 MHz		FDD
19	830 MHz – 845 MHz		875 MHz – 890 MHz		FDD
20	832 MHz – 862 MHz		791 MHz – 821 MHz		FDD
21	1447.9 MHz – 1462.9 MHz		1495.9 MHz – 1510.9 MHz		FDD
...					
24	1626.5 MHz – 1660.5 MHz		1525 MHz – 1559 MHz		FDD
...					
33	1900 MHz – 1920 MHz		1900 MHz – 1920 MHz		TDD
34	2010 MHz – 2025 MHz		2010 MHz – 2025 MHz		TDD
35	1850 MHz – 1910 MHz		1850 MHz – 1910 MHz		TDD
36	1930 MHz – 1990 MHz		1930 MHz – 1990 MHz		TDD
37	1910 MHz – 1930 MHz		1910 MHz – 1930 MHz		TDD
38	2570 MHz – 2620 MHz		2570 MHz – 2620 MHz		TDD
39	1880 MHz – 1920 MHz		1880 MHz – 1920 MHz		TDD
40	2300 MHz – 2400 MHz		2300 MHz – 2400 MHz		TDD
41	2496 MHz – 2690 MHz		2496 MHz – 2690 MHz		TDD
42	3400 MHz – 3600 MHz		3400 MHz – 3600 MHz		TDD
43	3600 MHz – 3800 MHz		3600 MHz – 3800 MHz		TDD

Note 1: Band 6 is not applicable

5.1 Overview

This chapter describes the LTE Device's **Network Setting > Wireless** screens. Use these screens to set up your LTE Device's wireless connection.

5.1.1 What You Can Do in this Chapter

- Use the **General** screen to enable the Wireless LAN, enter the SSID and select the wireless security mode ([Section 5.2 on page 45](#)).
- Use the **More AP** screen to set up multiple wireless networks on your LTE Device ([Section 5.3 on page 51](#)).
- Use the **WPS** screen to enable or disable WPS, view or generate a security PIN (Personal Identification Number) ([Section 5.4 on page 53](#)).
- Use the **WMM** screen to enable Wi-Fi MultiMedia (WMM) to ensure quality of service in wireless networks for multimedia applications ([Section 5.5 on page 55](#)).
- Use the **Scheduling** screen to schedule a time period for the wireless LAN to operate each day ([Section 5.6 on page 57](#)).

You don't necessarily need to use all these screens to set up your wireless connection. For example, you may just want to set up a network name, a wireless radio channel and some security in the **General** screen.

5.1.2 Wireless Network Overview

Wireless networks consist of wireless clients, access points and bridges.

- A wireless client is a radio connected to a user's computer.
- An access point is a radio with a wired connection to a network, which can connect with numerous wireless clients and let them access the network.
- A bridge is a radio that relays communications between access points and wireless clients, extending a network's range.

Traditionally, a wireless network operates in one of two ways.

- An "infrastructure" type of network has one or more access points and one or more wireless clients. The wireless clients connect to the access points.
- An "ad-hoc" type of network is one in which there is no access point. Wireless clients connect to one another in order to exchange information.

The following figure provides an example of a wireless network.

Figure 19 Example of a Wireless Network

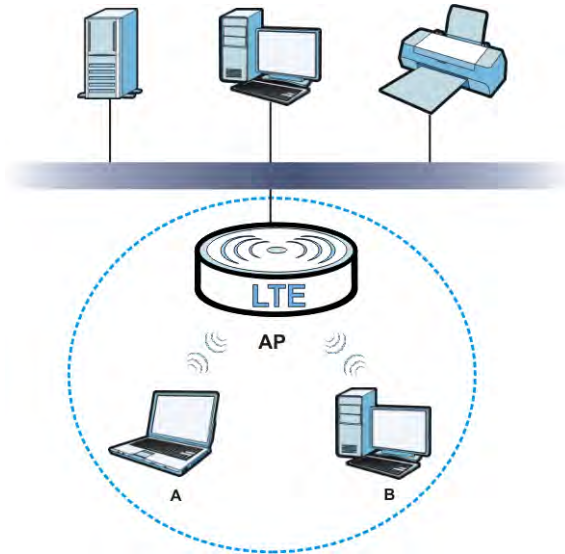

The wireless network is the part in the blue circle. In this wireless network, devices **A** and **B** use the access point (**AP**) to interact with the other devices (such as the printer) or with the Internet. Your LTE Device is the AP.

Every wireless network must follow these basic guidelines.

- Every device in the same wireless network must use the same SSID.
The SSID is the name of the wireless network. It stands for Service Set IDentifier.
- If two wireless networks overlap, they should use a different channel.
Like radio stations or television channels, each wireless network uses a specific channel, or frequency, to send and receive information.
- Every device in the same wireless network must use security compatible with the AP.
- Security stops unauthorized devices from using the wireless network. It can also protect the information that is sent in the wireless network.

Radio Channels

In the radio spectrum, there are certain frequency bands allocated for unlicensed, civilian use. For the purposes of wireless networking, these bands are divided into numerous channels. This allows a variety of networks to exist in the same place without interfering with one another. When you create a network, you must select a channel to use.

Since the available unlicensed spectrum varies from one country to another, the number of available channels also varies.

A channel is the radio frequency(ies) used by wireless devices to transmit and receive data. Channels available depend on your geographical area. You may have a choice of channels (for your region) so you should use a channel different from an adjacent AP (access point) to reduce

interference. Interference occurs when radio signals from different access points overlap causing interference and degrading performance.

Adjacent channels partially overlap however. To avoid interference due to overlap, your AP should be on a channel at least five channels away from a channel that an adjacent AP is using. For example, if your region has 11 channels and an adjacent AP is using channel 1, then you need to select a channel between 6 or 11.

5.1.3 Before You Begin

Before you start using these screens, ask yourself the following questions. See [Section 5.7 on page 57](#) if some of the terms used here do not make sense to you.

- What wireless standards do the other wireless devices support (IEEE 802.11g, for example)? What is the most appropriate standard to use?
- What security options do the other wireless devices support (WPA-PSK, for example)? What is the best one to use?
- Do the other wireless devices support WPS (Wi-Fi Protected Setup)? If so, you can set up a well-secured network very easily.

Even if some of your devices support WPS and some do not, you can use WPS to set up your network and then add the non-WPS devices manually, although this is somewhat more complicated to do.

- What advanced options do you want to configure, if any? If you want to configure advanced options, ensure that you know precisely what you want to do. If you do not want to configure advanced options, leave them alone.

5.2 The Wireless General Screen

Use this screen to enable the Wireless LAN, enter the SSID and select the wireless security mode.

Note: If you are configuring the LTE Device from a computer connected to the wireless LAN and you change the LTE Device's SSID or security settings, you will lose your wireless connection when you press **Apply** to confirm. You must then change the wireless settings of your computer to match the LTE Device's new settings.

Click **Network Setting > Wireless** to open the **General** screen. Select the **Enable Wireless LAN** checkbox to show the Wireless configurations.

Figure 20 Network Setting > Wireless > General

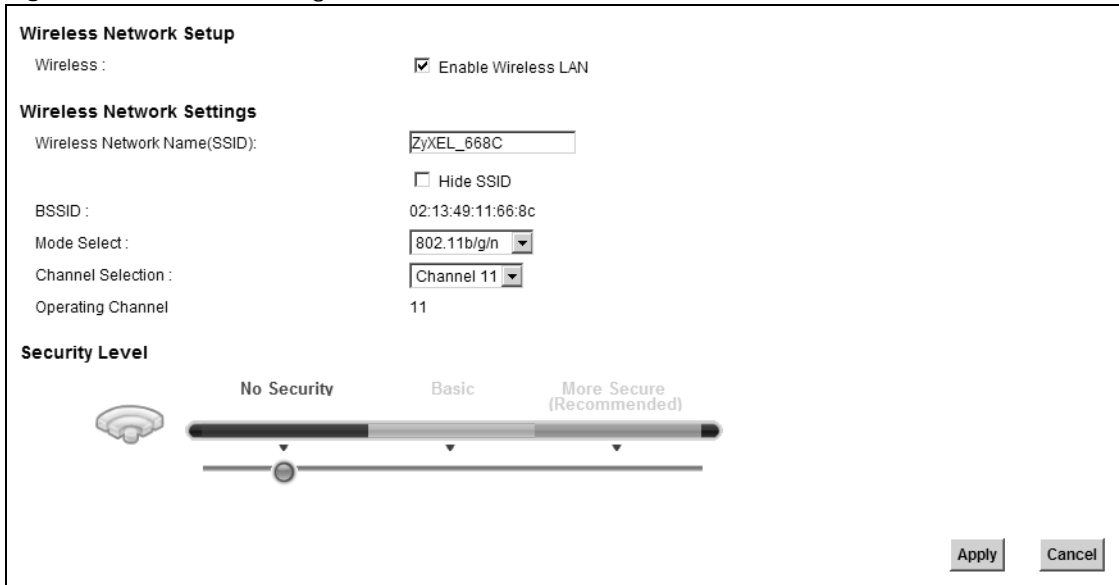

The following table describes the labels in this screen.

Table 7 Network > Wireless LAN > General

LABEL	DESCRIPTION
Wireless Network Setup	
Wireless	Select the Enable Wireless LAN check box to activate the wireless LAN.
Wireless Network Settings	
Wireless Network Name (SSID)	The SSID (Service Set IDentity) identifies the service set with which a wireless device is associated. Wireless devices associating to the access point (AP) must have the same SSID. Enter a descriptive name (up to 32 English keyboard characters) for the wireless LAN.
Hide SSID	Select this check box to hide the SSID in the outgoing beacon frame so a station cannot obtain the SSID through scanning using a site survey tool.
BSSID	This shows the MAC address of the wireless interface on the LTE Device when wireless LAN is enabled.
Mode Select	This makes sure that only compliant WLAN devices can associate with the LTE Device. Select 802.11b/g/n to allow IEEE802.11b, IEEE802.11g and IEEE802.11n compliant WLAN devices to associate with the LTE Device. The transmission rate of your LTE Device might be reduced. Select 802.11b/g to allow both IEEE802.11b and IEEE802.11g compliant WLAN devices to associate with the LTE Device. The transmission rate of your LTE Device might be reduced. Select 802.11g Only to allow only IEEE 802.11g compliant WLAN devices to associate with the LTE Device. Select 802.11n only in 2.4G band to allow only IEEE 802.11n compliant WLAN devices with the same frequency range (2.4 GHz) to associate with the LTE Device.

Table 7 Network > Wireless LAN > General (continued)

LABEL	DESCRIPTION
Channel Selection	Set the channel depending on your particular region. Select a channel or use Auto to have the LTE Device automatically determine a channel to use. If you are having problems with wireless interference, changing the channel may help. Try to use a channel that is as many channels away from any channels used by neighboring APs as possible. The channel number which the LTE Device is currently using then displays in the Operating Channel field.
Operating Channel	This is the channel currently being used by your AP.
Security Level	
Security Mode	Select Basic or More Secure to add security on this wireless network. The wireless clients which want to associate to this network must have same wireless security settings as the LTE Device. When you select to use a security, additional options appears in this screen. Or you can select No Security to allow any client to associate this network without any data encryption or authentication. See the following sections for more details about wireless security modes.
Apply	Click Apply to save your changes back to the LTE Device.
Cancel	Click Cancel to restore your previously saved settings.

5.2.1 No Security

Select **No Security** to allow wireless stations to communicate with the access points without any data encryption or authentication.

Note: If you do not enable any wireless security on your LTE Device, your network is accessible to any wireless networking device that is within range.

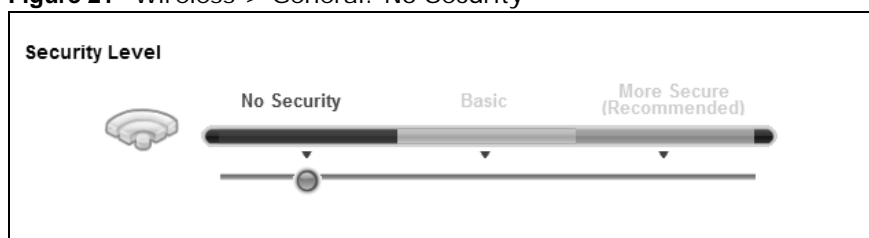
Figure 21 Wireless > General: No Security

The following table describes the labels in this screen.

Table 8 Wireless > General: No Security

LABEL	DESCRIPTION
Security Level	Choose No Security from the sliding bar.

5.2.2 Basic (Static WEP/Shared WEP Encryption)

WEP encryption scrambles the data transmitted between the wireless stations and the access points (AP) to keep network communications private. Both the wireless stations and the access points must use the same WEP key.

There are two types of WEP authentication namely, Open System (**Static WEP**) and Shared Key (**Shared WEP**).

Open system is implemented for ease-of-use and when security is not an issue. The wireless station and the AP or peer computer do not share a secret key. Thus the wireless stations can associate with any AP or peer computer and listen to any transmitted data that is not encrypted.

Shared key mode involves a shared secret key to authenticate the wireless station to the AP or peer computer. This requires you to enable the wireless LAN security and use same settings on both the wireless station and the AP or peer computer.

In order to configure and enable WEP encryption, click **Network Settings > Wireless** to display the **General** screen. Select **Basic** as the security level. Then select **Static WEP** or **Shared WEP** from the **Security Mode** list.

Figure 22 Wireless > General: Basic (Static WEP/Shared WEP)

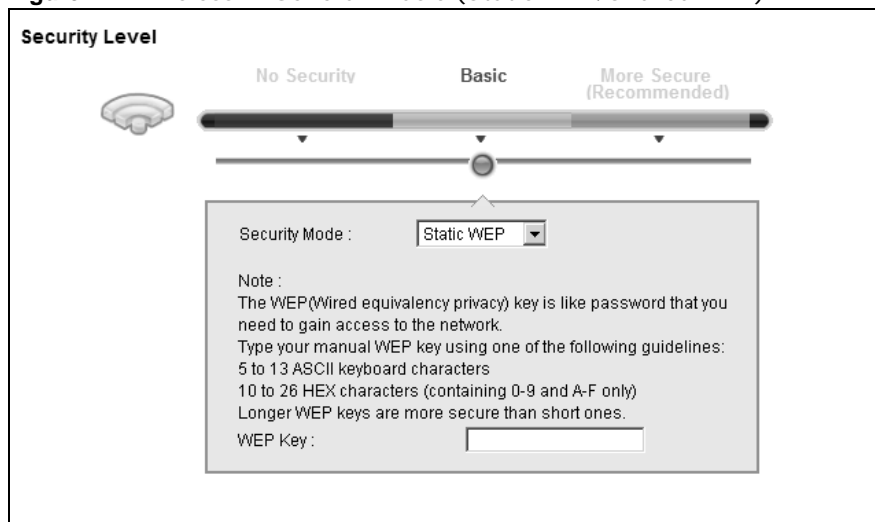

The following table describes the labels in this screen.

Table 9 Wireless > General: Basic (Static WEP/Shared WEP)

LABEL	DESCRIPTION
Security Mode	Choose Static WEP or Shared WEP from the drop-down list box. <ul style="list-style-type: none"> • Select Static WEP to have the LTE Device allow association with wireless clients that use Open System mode. Data transfer is encrypted as long as the wireless client has the correct WEP key for encryption. The LTE Device authenticates wireless clients using Shared Key mode that have the correct WEP key. • Select Shared WEP to have the LTE Device authenticate only those wireless clients that use Shared Key mode and have the correct WEP key.
WEP Key	Enter a WEP key that will be used to encrypt data. Both the LTE Device and the wireless stations must use the same WEP key for data transmission. If you want to manually set the WEP key, enter any 5 or 13 characters (ASCII string) or 10 or 26 hexadecimal characters ("0-9", "A-F") for a 64-bit or 128-bit WEP key respectively.

5.2.3 More Secure (WPA(2)-PSK)

The WPA-PSK security mode provides both improved data encryption and user authentication over WEP. Using a Pre-Shared Key (PSK), both the LTE Device and the connecting client share a common password in order to validate the connection. This type of encryption, while robust, is not as strong as WPA, WPA2 or even WPA2-PSK. The WPA2-PSK security mode is a newer, more robust version of the WPA encryption standard. It offers slightly better security, although the use of PSK makes it less robust than it could be.

Click **Network Settings** > **Wireless** to display the **General** screen. Select **More Secure** as the security level. Then select **WPA-PSK** or **WPA2-PSK** from the **Security Mode** list.

Figure 23 Wireless > General: More Secure: WPA(2)-PSK

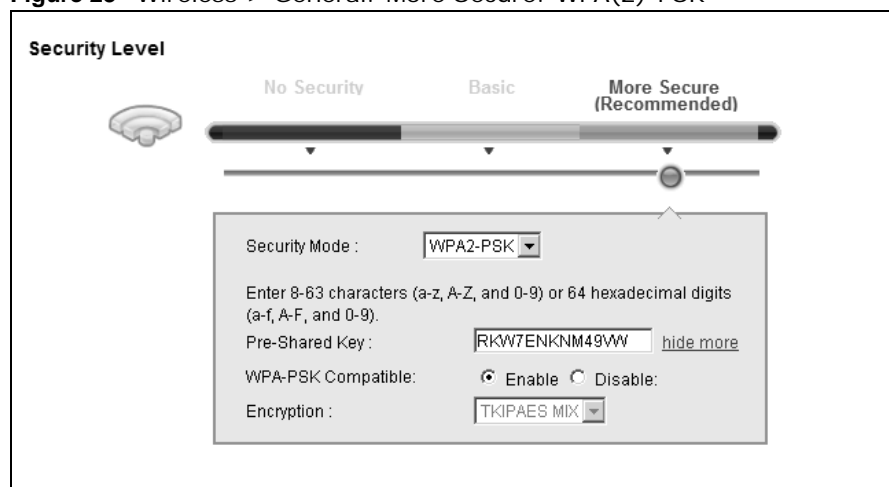

The following table describes the labels in this screen.

Table 10 Wireless > General: WPA(2)-PSK

LABEL	DESCRIPTION
Security Level	Select More Secure to enable WPA(2)-PSK data encryption.
Security Mode	Select WPA-PSK or WPA2-PSK from the drop-down list box.
Pre-Shared Key	The encryption mechanisms used for WPA/WPA2 and WPA-PSK/WPA2-PSK are the same. The only difference between the two is that WPA-PSK/WPA2-PSK uses a simple common password, instead of user-specific credentials. Type a pre-shared key from 8 to 63 case-sensitive ASCII characters or 64 hexadecimal digits.
more.../hide more	Click more... to show more fields in this section. Click hide more to hide them.

Table 10 Wireless > General: WPA(2)-PSK (continued)

LABEL	DESCRIPTION
WPA-PSK Compatible	This field appears when you choose WPA-PSK2 as the Security Mode . Check this field to allow wireless devices using WPA-PSK security mode to connect to your LTE Device. The LTE Device supports WPA-PSK and WPA2-PSK simultaneously.
Encryption	If the security mode is WPA-PSK , the encryption mode is set to TKIP to enable Temporal Key Integrity Protocol (TKIP) security on your wireless network. If the security mode is WPA-PSK2 and WPA-PSK Compatible is disabled, the encryption mode is set to AES to enable Advanced Encryption System (AES) security on your wireless network. AES provides superior security to TKIP. If the security mode is WPA-PSK2 and WPA-PSK Compatible is enabled, the encryption mode is set to TKIPAES MIX to allow both TKIP and AES types of security in your wireless network.

5.2.4 WPA(2) Authentication

The WPA2 security mode is currently the most robust form of encryption for wireless networks. It requires a RADIUS server to authenticate user credentials and is a full implementation the security protocol. Use this security option for maximum protection of your network. However, it is the least backwards compatible with older devices.

The WPA security mode is a security subset of WPA2. It requires the presence of a RADIUS server on your network in order to validate user credentials. This encryption standard is slightly older than WPA2 and therefore is more compatible with older devices.

Click **Network Settings > Wireless** to display the **General** screen. Select **More Secure** as the security level. Then select **WPA** or **WPA2** from the **Security Mode** list.

Figure 24 Wireless > General: More Secure: WPA(2)

Security Level

No Security Basic **More Secure (Recommended)**

Security Mode : WPA2

Authentication Server

IP Address :

Port Number : 1812

Shared Secret : [hide more](#)

WPA Compatible : Enable Disable

Group Key Update Timer: 0 sec

Encryption : AES

The following table describes the labels in this screen.

Table 11 Wireless > General: More Secure: WPA(2)

LABEL	DESCRIPTION
Security Level	Select More Secure to enable WPA(2)-PSK data encryption.
Security Mode	Choose WPA or WPA2 from the drop-down list box.
Authentication Server	
IP Address	Enter the IP address of the external authentication server in dotted decimal notation.
Port Number	Enter the port number of the external authentication server. The default port number is 1812 . You need not change this value unless your network administrator instructs you to do so with additional information.
Shared Secret	Enter a password (up to 128 alphanumeric characters) as the key to be shared between the external authentication server and the LTE Device. The key must be the same on the external authentication server and your LTE Device. The key is not sent over the network.
more.../hide more	Click more... to show more fields in this section. Click hide more to hide them.
WPA Compatible	This field is only available for WPA2. Select this if you want the LTE Device to support WPA and WPA2 simultaneously.
Group Key Update Timer	The Group Key Update Timer is the rate at which the RADIUS server sends a new group key out to all clients. If the value is set to "0", the update timer function is disabled.
Encryption	If the security mode is WPA , the encryption mode is set to TKIP to enable Temporal Key Integrity Protocol (TKIP) security on your wireless network. If the security mode is WPA2 , the encryption mode is set to AES to enable Advanced Encryption System (AES) security on your wireless network. AES provides superior security to TKIP.







5.3 The More AP Screen

The LTE Device can broadcast up to four wireless network names at the same time. This means that users can connect to the LTE Device using different SSIDs. You can secure the connection on each SSID profile so that wireless clients connecting to the LTE Device using different SSIDs cannot communicate with each other.

This screen allows you to enable and configure multiple Basic Service Sets (BSSs) on the LTE Device.

Click **Network Settings > Wireless > More AP**. The following screen displays.

Figure 25 Network Settings > Wireless > More AP

#	Active	SSID	Security	Modify
2		ZyXEL_668D	WPA2-PSK mixed	
3		ZyXEL_668E	WPA2-PSK mixed	
4		ZyXEL_668F	WPA2-PSK mixed	

The following table describes the labels in this screen.

Table 12 Network Settings > Wireless > More AP

LABEL	DESCRIPTION
#	This is the index number of the entry.
Active	This field indicates whether this SSID is active. A yellow bulb signifies that this SSID is active. A gray bulb signifies that this SSID is not active.
SSID	An SSID profile is the set of parameters relating to one of the LTE Device's BSSs. The SSID (Service Set IDentifier) identifies the Service Set with which a wireless device is associated. This field displays the name of the wireless profile on the network. When a wireless client scans for an AP to associate with, this is the name that is broadcast and seen in the wireless client utility.
Security	This field indicates the security mode of the SSID profile.
Modify	Click the Edit icon to configure the SSID profile.

5.3.1 Edit More AP

Use this screen to edit an SSID profile. Click the **Edit** icon next to an SSID in the **More AP** screen. The following screen displays.

Figure 26 Wireless > More AP: Edit

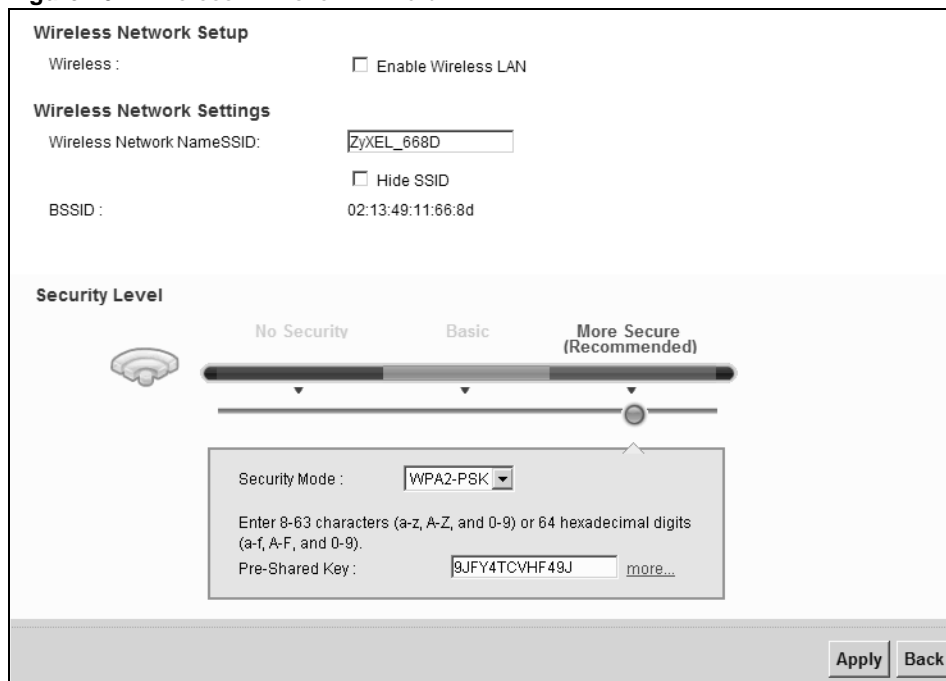

The following table describes the fields in this screen.

Table 13 Wireless > More AP: Edit

LABEL	DESCRIPTION
Wireless Network Setup	
Wireless	Select the Enable Wireless LAN check box to activate the wireless LAN.
Wireless Network Settings	

Table 13 Wireless > More AP: Edit (continued)

LABEL	DESCRIPTION
Wireless Network Name (SSID)	The SSID (Service Set IDentity) identifies the service set with which a wireless device is associated. Wireless devices associating to the access point (AP) must have the same SSID. Enter a descriptive name (up to 32 English keyboard characters) for the wireless LAN.
Hide SSID	Select this check box to hide the SSID in the outgoing beacon frame so a station cannot obtain the SSID through scanning using a site survey tool.
BSSID	This shows the MAC address of the wireless interface on the LTE Device when wireless LAN is enabled.
Security Level	
Security Mode	Select Basic (WEP) or More Secure (WPA(2)-PSK, WPA(2)) to add security on this wireless network. The wireless clients which want to associate to this network must have same wireless security settings as the LTE Device. After you select to use a security, additional options appears in this screen. Or you can select No Security to allow any client to associate this network without any data encryption or authentication. See Section 5.2.1 on page 47 for more details about this field.
Apply	Click Apply to save your changes.
Back	Click Back to exit this screen without saving.

5.4 The WPS Screen

Use this screen to configure WiFi Protected Setup (WPS) on your LTE Device.

WPS allows you to quickly set up a wireless network with strong security, without having to configure security settings manually. Set up each WPS connection between two devices. Both devices must support WPS. See [Section 5.7.6.3 on page 64](#) for more information about WPS.

Note: The LTE Device applies the security settings of the **SSID1** profile (see [Section 5.2 on page 45](#)). If you want to use the WPS feature, make sure you have set the security mode of **SSID1** to **WPA-PSK, WPA2-PSK** or **No Security**.

Click **Network Setting > Wireless > WPS**. The following screen displays. Select **Enable** and click **Apply** to activate the WPS function. Then you can configure the WPS settings in this screen.

Figure 27 Network Setting > Wireless > WPS

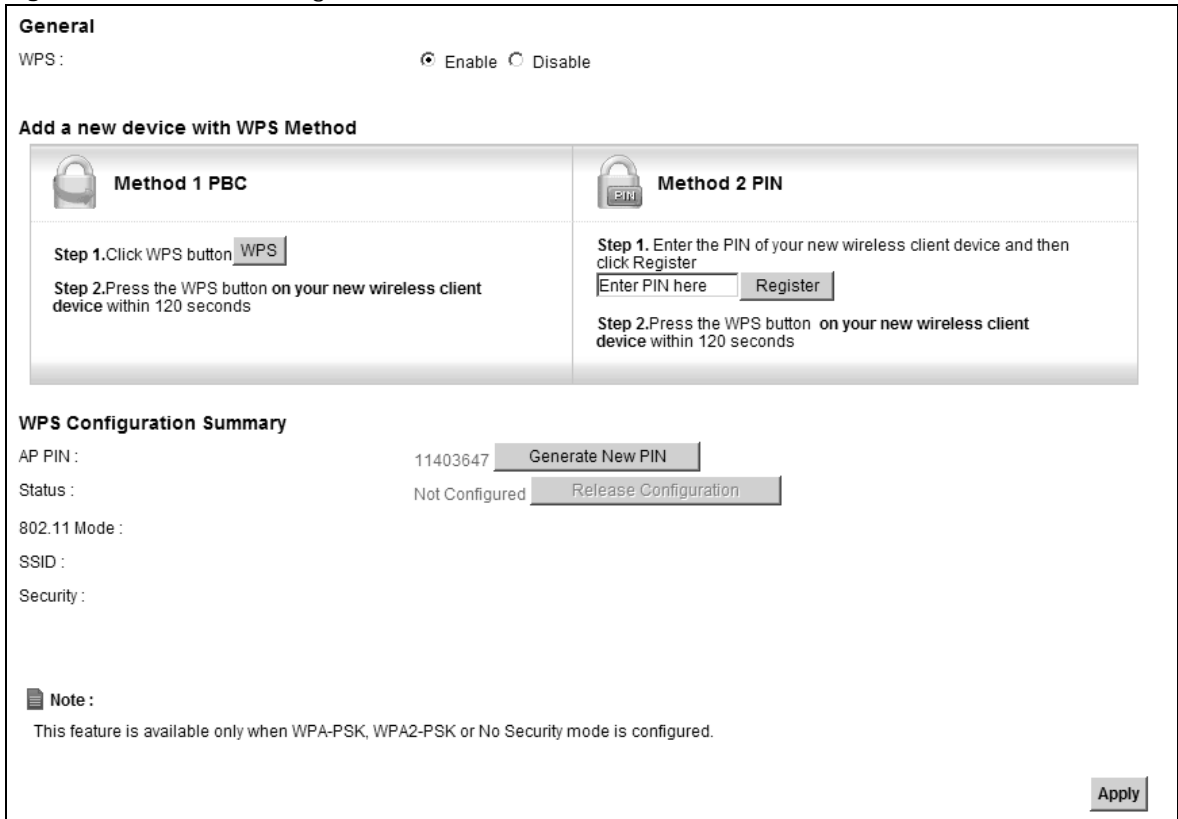

The following table describes the labels in this screen.

Table 14 Network Setting > Wireless > WPS

LABEL	DESCRIPTION
Enable WPS	Select Enable to activate WPS on the LTE Device.
Add a new device with WPS Method	
Method 1 PBC	Use this section to set up a WPS wireless network using Push Button Configuration (PBC).
WPS	Click this button to add another WPS-enabled wireless device (within wireless range of the LTE Device) to your wireless network. This button may either be a physical button on the outside of device, or a menu button similar to the WPS button on this screen. Note: You must press the other wireless device's WPS button within two minutes of pressing this button.
Method 2 PIN	Use this section to set up a WPS wireless network by entering the PIN (Personal Identification Number) of the client into the LTE Device.

Table 14 Network Setting > Wireless > WPS (continued)

LABEL	DESCRIPTION
Register	<p>Enter the PIN of the device that you are setting up a WPS connection with and click Register to authenticate and add the wireless device to your wireless network.</p> <p>You can find the PIN either on the outside of the device, or by checking the device's settings.</p> <p>Note: You must also activate WPS on that device within two minutes to have it present its PIN to the LTE Device.</p>
WPS Configuration Summary	
AP PIN	<p>The PIN of the LTE Device is shown here. Enter this PIN in the configuration utility of the device you want to connect to using WPS.</p> <p>The PIN is not necessary when you use WPS push-button method.</p> <p>Click the Generate New PIN button to have the LTE Device create a new PIN.</p>
Status	<p>This displays Configured when the LTE Device has connected to a wireless network using WPS or Enable WPS is selected and wireless or wireless security settings have been changed. The current wireless and wireless security settings also appear in the screen.</p> <p>This displays Not Configured when there is no wireless or wireless security changes on the LTE Device or you click Release Configuration to remove the configured wireless and wireless security settings.</p>
Release Configuration	<p>This button is available when the WPS status is Configured.</p> <p>Click this button to remove all configured wireless and wireless security settings for WPS connections on the LTE Device.</p>
802.11 Mode	This is the 802.11 mode used. Only compliant WLAN devices can associate with the LTE Device.
SSID	This is the name of the wireless network.
Security	This is the type of wireless security employed by the network.
Apply	Click Apply to save your changes.

5.5 The WMM Screen

Use this screen to enable or disable Wi-Fi MultiMedia (WMM) wireless networks for multimedia applications.

Click **Network Setting > Wireless > WMM**. The following screen displays.

Figure 28 Network Setting > Wireless > WMM

WMM (WiFi MultiMedia)

- Enable WMM of SSID1
- Enable WMM of SSID2
- Enable WMM of SSID3
- Enable WMM of SSID4
- Enable WMM Automatic Power Save Delivery(APSD)

Apply **Cancel**

The following table describes the labels in this screen.

Table 15 Network Setting > Wireless > WMM

LABEL	DESCRIPTION
Enable WMM of SSID1~4	This enables the LTE Device to automatically give a service a priority level according to the ToS value in the IP header of packets it sends. WMM QoS (Wifi MultiMedia Quality of Service) gives high priority to voice and video, which makes them run more smoothly.
Enable WMM Automatic Power Save Deliver (APSD)	Click this to increase battery life for battery-powered wireless clients. APSD uses a longer beacon interval when transmitting traffic that does not require a short packet exchange interval.
Apply	Click Apply to save your changes.
Cancel	Click Cancel to restore your previously saved settings.

5.6 Scheduling Screen

Click **Network Setting > Wireless > Scheduling** to open the **Wireless LAN Scheduling** screen. Use this screen to configure when the LTE Device enables or disables the wireless LAN.

Figure 29 Network Setting > Wireless > Scheduling

Wireless LAN Scheduling : Enable Disable

WLAN Status	Day	Between the following times (24-Hour Format)
<input type="radio"/> On <input checked="" type="radio"/> Off	<input type="checkbox"/> Everyday	00 (hour) 00 (min) ~ 00 (hour) 00 (min)
<input type="radio"/> On <input checked="" type="radio"/> Off	<input type="checkbox"/> Mon.	00 (hour) 00 (min) ~ 00 (hour) 00 (min)
<input type="radio"/> On <input checked="" type="radio"/> Off	<input type="checkbox"/> Tue.	00 (hour) 00 (min) ~ 00 (hour) 00 (min)
<input type="radio"/> On <input checked="" type="radio"/> Off	<input type="checkbox"/> Wed.	00 (hour) 00 (min) ~ 00 (hour) 00 (min)
<input type="radio"/> On <input checked="" type="radio"/> Off	<input type="checkbox"/> Thu.	00 (hour) 00 (min) ~ 00 (hour) 00 (min)
<input type="radio"/> On <input checked="" type="radio"/> Off	<input type="checkbox"/> Fri.	00 (hour) 00 (min) ~ 00 (hour) 00 (min)
<input type="radio"/> On <input checked="" type="radio"/> Off	<input type="checkbox"/> Sat.	00 (hour) 00 (min) ~ 00 (hour) 00 (min)
<input type="radio"/> On <input checked="" type="radio"/> Off	<input type="checkbox"/> Sun.	00 (hour) 00 (min) ~ 00 (hour) 00 (min)

Note :
Specify the same begin time and end time means the whole day schedule.

The following table describes the labels in this screen.

Table 16 Network Setting > Wireless > Scheduling

LABEL	DESCRIPTION
Wireless LAN Scheduling	Select Enable to activate wireless LAN scheduling on your LTE Device.
WLAN status	Select On or Off to enable or disable the wireless LAN.
Day	Select the day(s) you want to turn the wireless LAN on or off.
Between the following times	Specify the time period during which to apply the schedule. For example, you want the wireless network to be only available during work hours. Check Mon ~ Fri in the day column, and specify 8:00 ~ 18:00 in the time table.
Apply	Click Apply to save your changes.
Cancel	Click Cancel to restore your previously saved settings.

5.7 Technical Reference

This section discusses wireless LANs in depth. For more information, see the appendix.

5.7.1 Additional Wireless Terms

The following table describes some wireless network terms and acronyms used in the LTE Device's web configurator.

Table 17 Additional Wireless Terms

TERM	DESCRIPTION
RTS/CTS Threshold	<p>In a wireless network which covers a large area, wireless devices are sometimes not aware of each other's presence. This may cause them to send information to the AP at the same time and result in information colliding and not getting through.</p> <p>By setting this value lower than the default value, the wireless devices must sometimes get permission to send information to the LTE Device. The lower the value, the more often the devices must get permission.</p> <p>If this value is greater than the fragmentation threshold value (see below), then wireless devices never have to get permission to send information to the LTE Device.</p>
Preamble	A preamble affects the timing in your wireless network. There are two preamble modes: long and short. If a device uses a different preamble mode than the LTE Device does, it cannot communicate with the LTE Device.
Authentication	The process of verifying whether a wireless device is allowed to use the wireless network.
Fragmentation Threshold	A small fragmentation threshold is recommended for busy networks, while a larger threshold provides faster performance if the network is not very busy.

5.7.2 Wireless Security Overview

By their nature, radio communications are simple to intercept. For wireless data networks, this means that anyone within range of a wireless network without security can not only read the data passing over the airwaves, but also join the network. Once an unauthorized person has access to the network, he or she can steal information or introduce malware (malicious software) intended to compromise the network. For these reasons, a variety of security systems have been developed to ensure that only authorized people can use a wireless data network, or understand the data carried on it.

These security standards do two things. First, they authenticate. This means that only people presenting the right credentials (often a username and password, or a "key" phrase) can access the network. Second, they encrypt. This means that the information sent over the air is encoded. Only people with the code key can understand the information, and only people who have been authenticated are given the code key.

These security standards vary in effectiveness. Some can be broken, such as the old Wired Equivalent Protocol (WEP). Using WEP is better than using no security at all, but it will not keep a determined attacker out. Other security standards are secure in themselves but can be broken if a user does not use them properly. For example, the WPA-PSK security standard is very secure if you use a long key which is difficult for an attacker's software to guess - for example, a twenty-letter long string of apparently random numbers and letters - but it is not very secure if you use a short key which is very easy to guess - for example, a three-letter word from the dictionary.

Because of the damage that can be done by a malicious attacker, it's not just people who have sensitive information on their network who should use security. Everybody who uses any wireless network should ensure that effective security is in place.

A good way to come up with effective security keys, passwords and so on is to use obscure information that you personally will easily remember, and to enter it in a way that appears random and does not include real words. For example, if your mother owns a 1970 Dodge Challenger and her favorite movie is Vanishing Point (which you know was made in 1971) you could use “70dodchal71vanpoi” as your security key.

The following sections introduce different types of wireless security you can set up in the wireless network.

5.7.2.1 SSID

Normally, the LTE Device acts like a beacon and regularly broadcasts the SSID in the area. You can hide the SSID instead, in which case the LTE Device does not broadcast the SSID. In addition, you should change the default SSID to something that is difficult to guess.

This type of security is fairly weak, however, because there are ways for unauthorized wireless devices to get the SSID. In addition, unauthorized wireless devices can still see the information that is sent in the wireless network.

5.7.2.2 MAC Address Filter

Every device that can use a wireless network has a unique identification number, called a MAC address.¹ A MAC address is usually written using twelve hexadecimal characters²; for example, 00A0C5000002 or 00:A0:C5:00:00:02. To get the MAC address for each device in the wireless network, see the device’s User’s Guide or other documentation.

You can use the MAC address filter to tell the LTE Device which devices are allowed or not allowed to use the wireless network. If a device is allowed to use the wireless network, it still has to have the correct information (SSID, channel, and security). If a device is not allowed to use the wireless network, it does not matter if it has the correct information.

This type of security does not protect the information that is sent in the wireless network. Furthermore, there are ways for unauthorized wireless devices to get the MAC address of an authorized device. Then, they can use that MAC address to use the wireless network.

5.7.2.3 User Authentication

Authentication is the process of verifying whether a wireless device is allowed to use the wireless network. You can make every user log in to the wireless network before using it. However, every device in the wireless network has to support IEEE 802.1x to do this.

For wireless networks, you can store the user names and passwords for each user in a RADIUS server. This is a server used in businesses more than in homes. If you do not have a RADIUS server, you cannot set up user names and passwords for your users.

Unauthorized wireless devices can still see the information that is sent in the wireless network, even if they cannot use the wireless network. Furthermore, there are ways for unauthorized wireless users to get a valid user name and password. Then, they can use that user name and password to use the wireless network.

-
1. Some wireless devices, such as scanners, can detect wireless networks but cannot use wireless networks. These kinds of wireless devices might not have MAC addresses.
 2. Hexadecimal characters are 0, 1, 2, 3, 4, 5, 6, 7, 8, 9, A, B, C, D, E, and F.

5.7.2.4 Encryption

Wireless networks can use encryption to protect the information that is sent in the wireless network. Encryption is like a secret code. If you do not know the secret code, you cannot understand the message.

The types of encryption you can choose depend on the type of authentication. (See [Section 5.7.2.3 on page 59](#) for information about this.)

Table 18 Types of Encryption for Each Type of Authentication

	NO AUTHENTICATION	RADIUS SERVER
Weakest 	No Security	WPA
	Static WEP	
	WPA-PSK	
Strongest	WPA2-PSK	WPA2

For example, if the wireless network has a RADIUS server, you can choose **WPA** or **WPA2**. If users do not log in to the wireless network, you can choose no encryption, **Static WEP**, **WPA-PSK**, or **WPA2-PSK**.

Usually, you should set up the strongest encryption that every device in the wireless network supports. For example, suppose you have a wireless network with the LTE Device and you do not have a RADIUS server. Therefore, there is no authentication. Suppose the wireless network has two devices. Device A only supports WEP, and device B supports WEP and WPA. Therefore, you should set up **Static WEP** in the wireless network.

Note: It is recommended that wireless networks use **WPA-PSK**, **WPA**, or stronger encryption. The other types of encryption are better than none at all, but it is still possible for unauthorized wireless devices to figure out the original information pretty quickly.

When you select **WPA2** or **WPA2-PSK** in your LTE Device, you can also select an option (**WPA compatible**) to support WPA as well. In this case, if some of the devices support WPA and some support WPA2, you should set up **WPA2-PSK** or **WPA2** (depending on the type of wireless network login) and select the **WPA compatible** option in the LTE Device.

Many types of encryption use a key to protect the information in the wireless network. The longer the key, the stronger the encryption. Every device in the wireless network must have the same key.

5.7.3 Signal Problems

Because wireless networks are radio networks, their signals are subject to limitations of distance, interference and absorption.

Problems with distance occur when the two radios are too far apart. Problems with interference occur when other radio waves interrupt the data signal. Interference may come from other radio transmissions, such as military or air traffic control communications, or from machines that are coincidental emitters such as electric motors or microwaves. Problems with absorption occur when physical objects (such as thick walls) are between the two radios, muffling the signal.

5.7.4 BSS

A Basic Service Set (BSS) exists when all communications between wireless stations or between a wireless station and a wired network client go through one access point (AP).

Intra-BSS traffic is traffic between wireless stations in the BSS. When Intra-BSS traffic blocking is disabled, wireless station A and B can access the wired network and communicate with each other. When Intra-BSS traffic blocking is enabled, wireless station A and B can still access the wired network but cannot communicate with each other.

Figure 30 Basic Service set

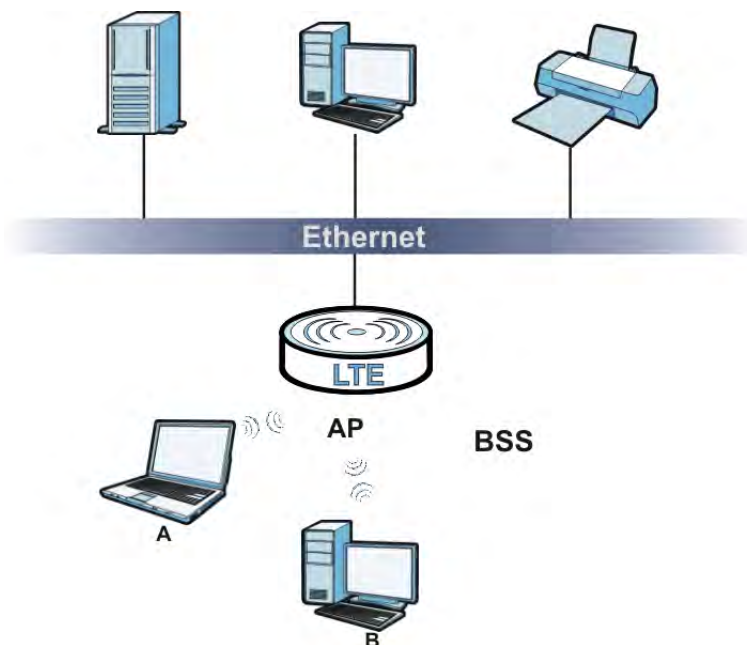

5.7.5 MBSSID

Traditionally, you need to use different APs to configure different Basic Service Sets (BSSs). As well as the cost of buying extra APs, there is also the possibility of channel interference. The LTE Device's MBSSID (Multiple Basic Service Set IDentifier) function allows you to use one access point to provide several BSSs simultaneously. You can then assign varying QoS priorities and/or security modes to different SSIDs.

Wireless devices can use different BSSIDs to associate with the same AP.

5.7.5.1 Notes on Multiple BSSs

- A maximum of eight BSSs are allowed on one AP simultaneously.
- You must use different keys for different BSSs. If two wireless devices have different BSSIDs (they are in different BSSs), but have the same keys, they may hear each other's communications (but not communicate with each other).
- MBSSID should not replace but rather be used in conjunction with 802.1x security.

5.7.6 WiFi Protected Setup (WPS)

Your LTE Device supports WiFi Protected Setup (WPS), which is an easy way to set up a secure wireless network. WPS is an industry standard specification, defined by the WiFi Alliance.

WPS allows you to quickly set up a wireless network with strong security, without having to configure security settings manually. Each WPS connection works between two devices. Both devices must support WPS (check each device's documentation to make sure).

Depending on the devices you have, you can either press a button (on the device itself, or in its configuration utility) or enter a PIN (a unique Personal Identification Number that allows one device to authenticate the other) in each of the two devices. When WPS is activated on a device, it has two minutes to find another device that also has WPS activated. Then, the two devices connect and set up a secure network by themselves.

5.7.6.1 Push Button Configuration

WPS Push Button Configuration (PBC) is initiated by pressing a button on each WPS-enabled device, and allowing them to connect automatically. You do not need to enter any information.

Not every WPS-enabled device has a physical WPS button. Some may have a WPS PBC button in their configuration utilities instead of or in addition to the physical button.

Take the following steps to set up WPS using the button.

- 1 Ensure that the two devices you want to set up are within wireless range of one another.
- 2 Look for a WPS button on each device. If the device does not have one, log into its configuration utility and locate the button (see the device's User's Guide for how to do this - for the LTE Device, see [Section 5.4 on page 53](#)).
- 3 Press the button on one of the devices (it doesn't matter which). For the LTE Device you must press the WPS button for more than three seconds.
- 4 Within two minutes, press the button on the other device. The registrar sends the network name (SSID) and security key through an secure connection to the enrollee.

If you need to make sure that WPS worked, check the list of associated wireless clients in the AP's configuration utility. If you see the wireless client in the list, WPS was successful.

5.7.6.2 PIN Configuration

Each WPS-enabled device has its own PIN (Personal Identification Number). This may either be static (it cannot be changed) or dynamic (in some devices you can generate a new PIN by clicking on a button in the configuration interface).

Use the PIN method instead of the push-button configuration (PBC) method if you want to ensure that the connection is established between the devices you specify, not just the first two devices to activate WPS in range of each other. However, you need to log into the configuration interfaces of both devices to use the PIN method.

When you use the PIN method, you must enter the PIN from one device (usually the wireless client) into the second device (usually the Access Point or wireless router). Then, when WPS is activated

on the first device, it presents its PIN to the second device. If the PIN matches, one device sends the network and security information to the other, allowing it to join the network.

Take the following steps to set up a WPS connection between an access point or wireless router (referred to here as the AP) and a client device using the PIN method.

- 1** Ensure WPS is enabled on both devices.
- 2** Access the WPS section of the AP's configuration interface. See the device's User's Guide for how to do this.
- 3** Look for the client's WPS PIN; it will be displayed either on the device, or in the WPS section of the client's configuration interface (see the device's User's Guide for how to find the WPS PIN - for the LTE Device, see [Section 5.4 on page 53](#)).
- 4** Enter the client's PIN in the AP's configuration interface.
- 5** If the client device's configuration interface has an area for entering another device's PIN, you can either enter the client's PIN in the AP, or enter the AP's PIN in the client - it does not matter which.
- 6** Start WPS on both devices within two minutes.
- 7** Use the configuration utility to activate WPS, not the push-button on the device itself.
- 8** On a computer connected to the wireless client, try to connect to the Internet. If you can connect, WPS was successful.

If you cannot connect, check the list of associated wireless clients in the AP's configuration utility. If you see the wireless client in the list, WPS was successful.

The following figure shows a WPS-enabled wireless client (installed in a notebook computer) connecting to the WPS-enabled AP via the PIN method.

Figure 31 Example WPS Process: PIN Method

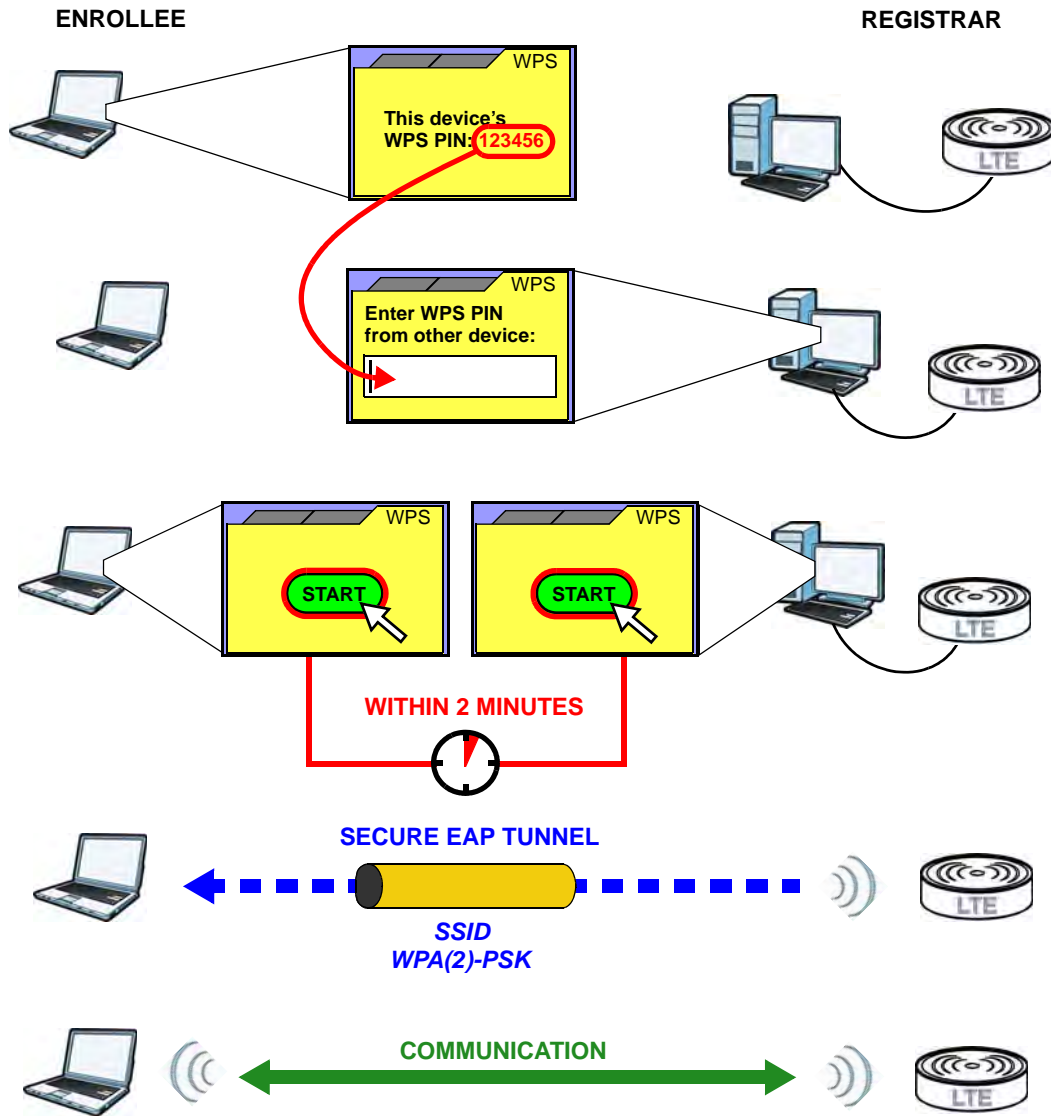

5.7.6.3 How WPS Works

When two WPS-enabled devices connect, each device must assume a specific role. One device acts as the registrar (the device that supplies network and security settings) and the other device acts as the enrollee (the device that receives network and security settings). The registrar creates a secure EAP (Extensible Authentication Protocol) tunnel and sends the network name (SSID) and the WPA-PSK or WPA2-PSK pre-shared key to the enrollee. Whether WPA-PSK or WPA2-PSK is used depends on the standards supported by the devices. If the registrar is already part of a network, it sends the existing information. If not, it generates the SSID and WPA(2)-PSK randomly.

The following figure shows a WPS-enabled client (installed in a notebook computer) connecting to a WPS-enabled access point.

Figure 32 How WPS works

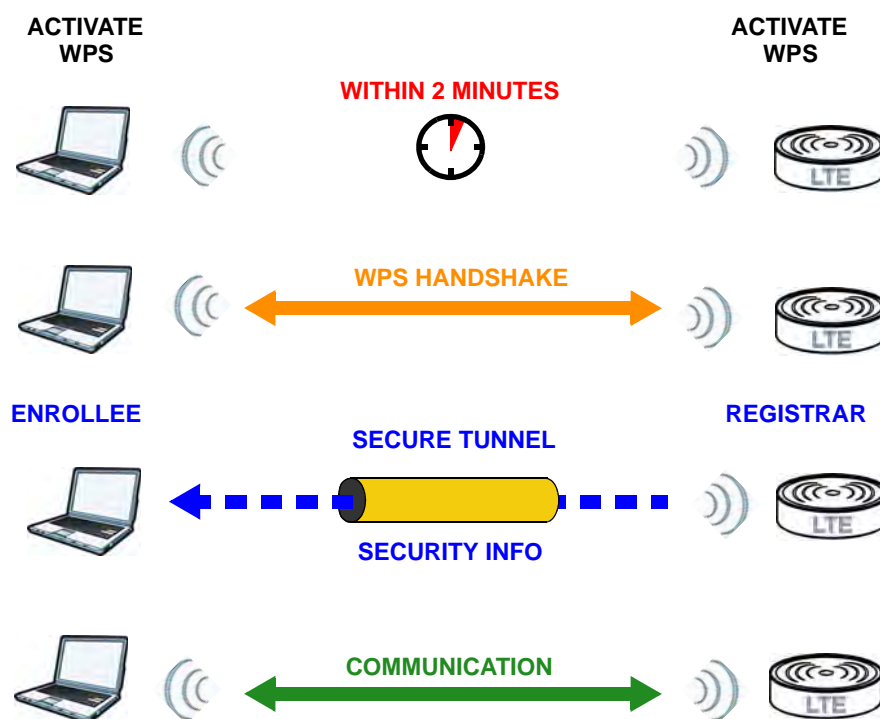

The roles of registrar and enrollee last only as long as the WPS setup process is active (two minutes). The next time you use WPS, a different device can be the registrar if necessary.

The WPS connection process is like a handshake; only two devices participate in each WPS transaction. If you want to add more devices you should repeat the process with one of the existing networked devices and the new device.

Note that the access point (AP) is not always the registrar, and the wireless client is not always the enrollee. All WPS-certified APs can be a registrar, and so can some WPS-enabled wireless clients.

By default, a WPS device is “unconfigured”. This means that it is not part of an existing network and can act as either enrollee or registrar (if it supports both functions). If the registrar is unconfigured, the security settings it transmits to the enrollee are randomly-generated. Once a WPS-enabled device has connected to another device using WPS, it becomes “configured”. A configured wireless client can still act as enrollee or registrar in subsequent WPS connections, but a configured access point can no longer act as enrollee. It will be the registrar in all subsequent WPS connections in which it is involved. If you want a configured AP to act as an enrollee, you must reset it to its factory defaults.

5.7.6.4 Example WPS Network Setup

This section shows how security settings are distributed in an example WPS setup.

The following figure shows an example network. In step **1**, both **AP1** and **Client 1** are unconfigured. When WPS is activated on both, they perform the handshake. In this example, **AP1**

is the registrar, and **Client 1** is the enrollee. The registrar randomly generates the security information to set up the network, since it is unconfigured and has no existing information.

Figure 33 WPS: Example Network Step 1

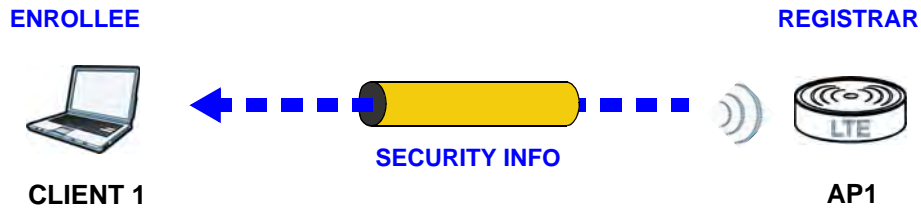

In step 2, you add another wireless client to the network. You know that **Client 1** supports registrar mode, but it is better to use **AP1** for the WPS handshake with the new client since you must connect to the access point anyway in order to use the network. In this case, **AP1** must be the registrar, since it is configured (it already has security information for the network). **AP1** supplies the existing security information to **Client 2**.

Figure 34 WPS: Example Network Step 2

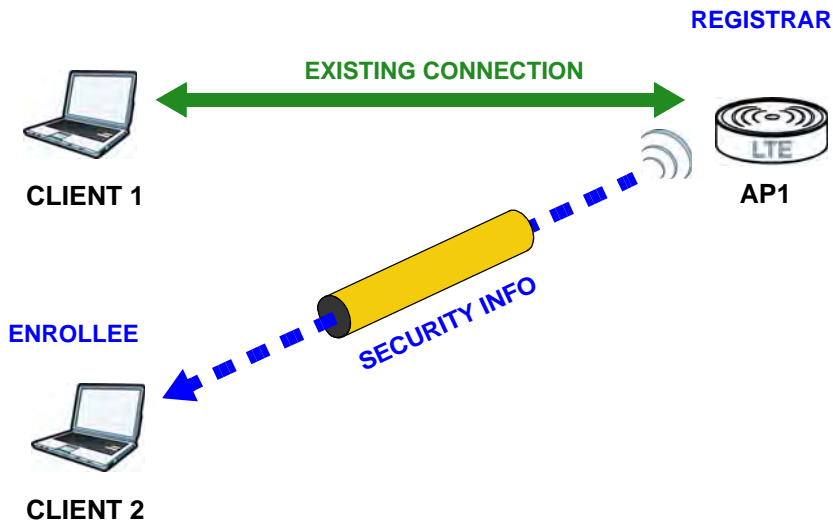

In step 3, you add another access point (**AP2**) to your network. **AP2** is out of range of **AP1**, so you cannot use **AP1** for the WPS handshake with the new access point. However, you know that **Client 2** supports the registrar function, so you use it to perform the WPS handshake instead.

Figure 35 WPS: Example Network Step 3

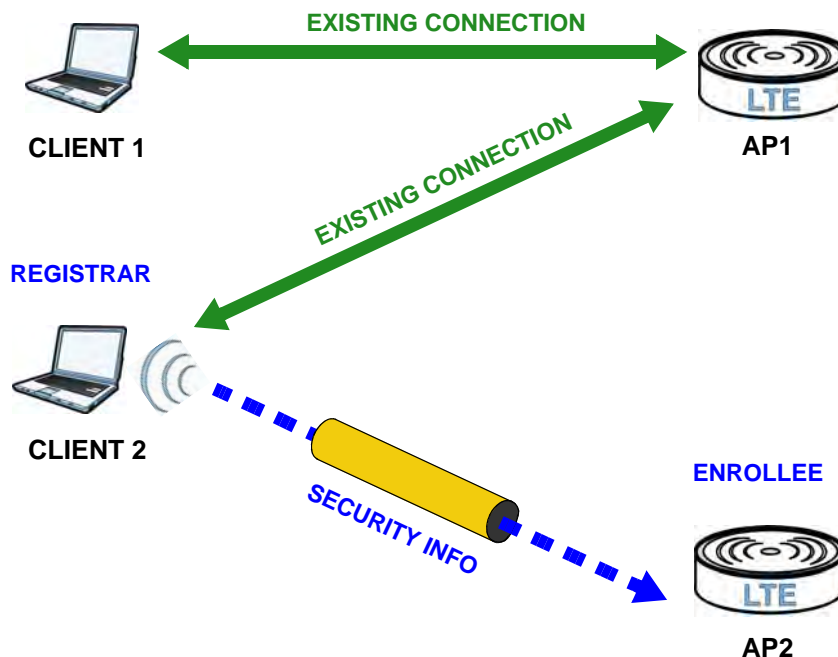

5.7.6.5 Limitations of WPS

WPS has some limitations of which you should be aware.

- WPS works in Infrastructure networks only (where an AP and a wireless client communicate). It does not work in Ad-Hoc networks (where there is no AP).
- When you use WPS, it works between two devices only. You cannot enroll multiple devices simultaneously, you must enroll one after the other.

For instance, if you have two enrollees and one registrar you must set up the first enrollee (by pressing the WPS button on the registrar and the first enrollee, for example), then check that it successfully enrolled, then set up the second device in the same way.

- WPS works only with other WPS-enabled devices. However, you can still add non-WPS devices to a network you already set up using WPS.

WPS works by automatically issuing a randomly-generated WPA-PSK or WPA2-PSK pre-shared key from the registrar device to the enrollee devices. Whether the network uses WPA-PSK or WPA2-PSK depends on the device. You can check the configuration interface of the registrar device to discover the key the network is using (if the device supports this feature). Then, you can enter the key into the non-WPS device and join the network as normal (the non-WPS device must also support WPA-PSK or WPA2-PSK).

- When you use the PBC method, there is a short period (from the moment you press the button on one device to the moment you press the button on the other device) when any WPS-enabled device could join the network. This is because the registrar has no way of identifying the “correct” enrollee, and cannot differentiate between your enrollee and a rogue device. This is a possible way for a hacker to gain access to a network.

You can easily check to see if this has happened. WPS works between only two devices simultaneously, so if another device has enrolled your device will be unable to enroll, and will not have access to the network. If this happens, open the access point’s configuration interface and look at the list of associated clients (usually displayed by MAC address). It does not matter if the access point is the WPS registrar, the enrollee, or was not involved in the WPS handshake; a rogue device must still associate with the access point to gain access to the network. Check the MAC addresses of your wireless clients (usually printed on a label on the bottom of the device). If there is an unknown MAC address you can remove it or reset the AP.

Home Networking

6.1 Overview

A Local Area Network (LAN) is a shared communication system to which many computers are attached. A LAN is usually located in one immediate area such as a building or floor of a building.

The LAN screens can help you configure a LAN DHCP server and manage IP addresses.

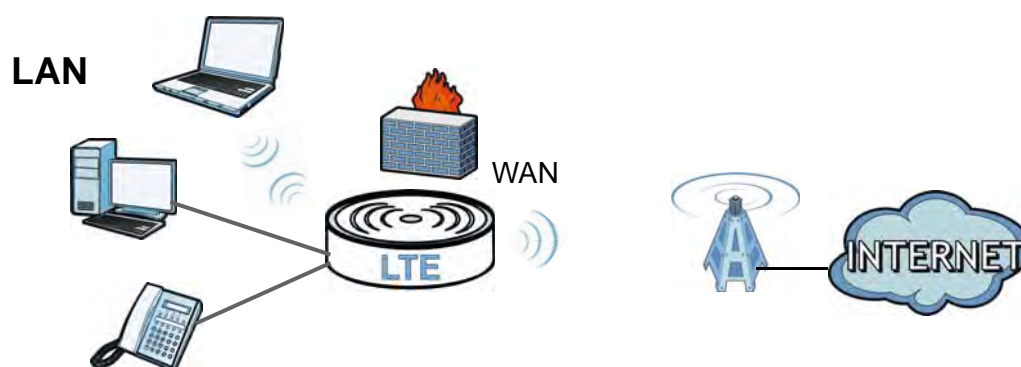

6.1.1 What You Can Do in this Chapter

- Use the **LAN Setup** screen to set the LAN IP address, subnet mask, and DHCP settings ([Section 6.2 on page 71](#)).
- Use the **Static DHCP** screen to assign IP addresses on the LAN to specific individual computers based on their MAC Addresses ([Section 6.3 on page 72](#)).
- Use the **UPnP** screen to enable UPnP ([Section 6.4 on page 73](#)).

6.1.2 What You Need To Know

The following terms and concepts may help as you read this chapter.

6.1.2.1 About LAN

IP Address

Similar to the way houses on a street share a common street name, so too do computers on a LAN share one common network number. This is known as an Internet Protocol address.

Subnet Mask

The subnet mask specifies the network number portion of an IP address. Your LTE Device will compute the subnet mask automatically based on the IP address that you entered. You don't need to change the subnet mask computed by the LTE Device unless you are instructed to do otherwise.

DHCP

DHCP (Dynamic Host Configuration Protocol) allows clients to obtain TCP/IP configuration at start-up from a server. This LTE Device has a built-in DHCP server capability that assigns IP addresses and DNS servers to systems that support DHCP client capability.

DNS

DNS (Domain Name System) maps a domain name to its corresponding IP address and vice versa. The DNS server is extremely important because without it, you must know the IP address of a computer before you can access it. The DNS server addresses you enter when you set up DHCP are passed to the client machines along with the assigned IP address and subnet mask.

6.1.2.2 About UPnP

How do I know if I'm using UPnP?

UPnP hardware is identified as an icon in the Network Connections folder (Windows XP). Each UPnP compatible device installed on your network will appear as a separate icon. Selecting the icon of a UPnP device will allow you to access the information and properties of that device.

Cautions with UPnP

The automated nature of NAT traversal applications in establishing their own services and opening firewall ports may present network security issues. Network information and configuration may also be obtained and modified by users in some network environments.

When a UPnP device joins a network, it announces its presence with a multicast message. For security reasons, the LTE Device allows multicast messages on the LAN only.

All UPnP-enabled devices may communicate freely with each other without additional configuration. Disable UPnP if this is not your intention.

6.2 The LAN Setup Screen

Click **Network Setting > Home Networking** to open the **LAN Setup** screen. Use this screen to set the Local Area Network IP address and subnet mask of your LTE Device and configure the DNS server information that the LTE Device sends to the DHCP client devices on the LAN.

Figure 36 Network Setting > Home Networking > LAN Setup

The screenshot shows the LAN Setup screen with the following fields and values:

- LAN IP Setup**
 - IP Address: 192.168.1.1
 - Subnet Mask: 255.255.255.0
- DHCP Server State**
 - DHCP: Enable Disable
- IP Addressing Values**
 - IP Pool Starting Address: 192.168.1.33
 - Pool Size: 32
- DNS Values**
 - DNS Server 1: From ISP (dropdown), 192.168.1.1 (text)
 - DNS Server 2: None (dropdown), (empty text)
 - DNS Server 3: None (dropdown), (empty text)

Buttons for **Apply** and **Cancel** are located at the bottom right.

The following table describes the fields in this screen.

Table 19 Network Setting > Home Networking > LAN Setup

LABEL	DESCRIPTION
LAN IP Setup	
IP Address	Enter the LAN IP address you want to assign to your LTE Device in dotted decimal notation, for example, 192.168.1.1 (factory default).
IP Subnet Mask	Type the subnet mask of your network in dotted decimal notation, for example 255.255.255.0 (factory default). Your LTE Device automatically computes the subnet mask based on the IP address you enter, so do not change this field unless you are instructed to do so.
DHCP Server State	
DHCP	Select Enable to have your LTE Device assign IP addresses, an IP default gateway and DNS servers to LAN computers and other devices that are DHCP clients. If you select Disable , you need to manually configure the IP addresses of the computers and other devices on your LAN. When DHCP is used, the following fields need to be set.
IP Addressing Values	
IP Pool Starting Address	This field specifies the first of the contiguous addresses in the IP address pool.
Pool Size	This field specifies the size, or count of the IP address pool.
DNS Values	

Table 19 Network Setting > Home Networking > LAN Setup (continued)

LABEL	DESCRIPTION
DNS Server 1-3	Select From ISP if your ISP dynamically assigns DNS server information (and the LTE Device's WAN IP address). Select DNS-Proxy if Select User-Defined if you have the IP address of a DNS server. Enter the DNS server's IP address in the field to the right. If you chose User-Defined , but leave the IP address set to 0.0.0.0, User-Defined changes to None after you click Apply . If you set a second choice to User-Defined , and enter the same IP address, the second User-Defined changes to None after you click Apply . Select None if you do not want to configure DNS servers. You must have another DHCP sever on your LAN, or else the computers must have their DNS server addresses manually configured. If you do not configure a DNS server, you must know the IP address of a computer in order to access it.
Apply	Click Apply to save your changes.
Cancel	Click Cancel to restore your previously saved settings.

6.3 The Static DHCP Screen

This table allows you to assign IP addresses on the LAN to specific individual computers based on their MAC Addresses.

Every Ethernet device has a unique MAC (Media Access Control) address. The MAC address is assigned at the factory and consists of six pairs of hexadecimal characters, for example, 00:AO:C5:00:00:02.

6.3.1 Before You Begin

Find out the MAC addresses of your network devices if you intend to add them to the **Static DHCP** screen.

Use this screen to change your LTE Device's static DHCP settings. Click **Network Setting > Home Networking > Static DHCP** to open the following screen.

Figure 37 Network Setting > Home Networking > Static DHCP

Add new static lease					
#	Status	Host Name	MAC Address	IP Address	Reserve
1	💡	pc02	00:24:21:7e:20:96	192.168.1.58	<input type="checkbox"/>

Apply Cancel Refresh

The following table describes the labels in this screen.

Table 20 Network Setting > Home Networking > Static DHCP

LABEL	DESCRIPTION
Add new static lease	Click this to add a new static DHCP entry.
#	This is the index number of the entry.
Status	This field displays whether the client is connected to the LTE Device.

Table 20 Network Setting > Home Networking > Static DHCP (continued)

LABEL	DESCRIPTION
Host Name	This field displays the client host name.
MAC Address	The MAC (Media Access Control) or Ethernet address on a LAN (Local Area Network) is unique to your computer (six pairs of hexadecimal notation). A network interface card such as an Ethernet adapter has a hardwired address that is assigned at the factory. This address follows an industry standard that ensures no other adapter has a similar address.
IP Address	This field displays the IP address relative to the # field listed above.
Reserve	Select the check box in the heading row to automatically select all check boxes or select the check box(es) in each entry to have the LTE Device always assign the selected entry(ies)'s IP address(es) to the corresponding MAC address(es) (and host name(s)). You can select up to 128 entries in this table.
Apply	Click Apply to save your changes.
Cancel	Click Cancel to restore your previously saved settings.
Refresh	Click Refresh to reload the DHCP table.

If you click **Add new static lease** in the **Static DHCP** screen, the following screen displays.

Figure 38 Static DHCP: Add

The following table describes the labels in this screen.

Table 21 Static DHCP: Add

LABEL	DESCRIPTION
MAC Address	Enter the MAC address of a computer on your LAN.
IP Address	Enter the IP address that you want to assign to the computer on your LAN with the MAC address that you will also specify.
Apply	Click Apply to save your changes.
Back	Click Back to exit this screen without saving.

6.4 The UPnP Screen

Universal Plug and Play (UPnP) is a distributed, open networking standard that uses TCP/IP for simple peer-to-peer network connectivity between devices. A UPnP device can dynamically join a network, obtain an IP address, convey its capabilities and learn about other devices on the network. In turn, a device can leave a network smoothly and automatically when it is no longer in use.

See [page 74](#) for more information on UPnP.

Use the following screen to configure the UPnP settings on your LTE Device. Click **Network Setting > Home Networking > Static DHCP > UPnP** to display the screen shown next.

Figure 39 Network Setting > Home Networking > UPnP



UPnP State

UPnP: Enable Disable

Apply

The following table describes the labels in this screen.

Table 22 Network Settings > Home Networking > UPnP

LABEL	DESCRIPTION
UPnP	Select Enable to activate UPnP. Be aware that anyone could use a UPnP application to open the web configurator's login screen without entering the LTE Device's IP address (although you must still enter the password to access the web configurator).
Apply	Click Apply to save your changes.

Routing

7.1 Overview

The LTE Device usually uses the default gateway to route outbound traffic from computers on the LAN to the Internet. To have the LTE Device send data to devices not reachable through the default gateway, use static routes.

For example, the next figure shows a computer (**A**) connected to the LTE Device's LAN interface. The LTE Device routes most traffic from **A** to the Internet through the LTE Device's default gateway (**R1**). You create one static route to connect to services offered by your ISP behind router **R2**. You create another static route to communicate with a separate network behind a router **R3** connected to the LAN.

Figure 40 Example of Static Routing Topology

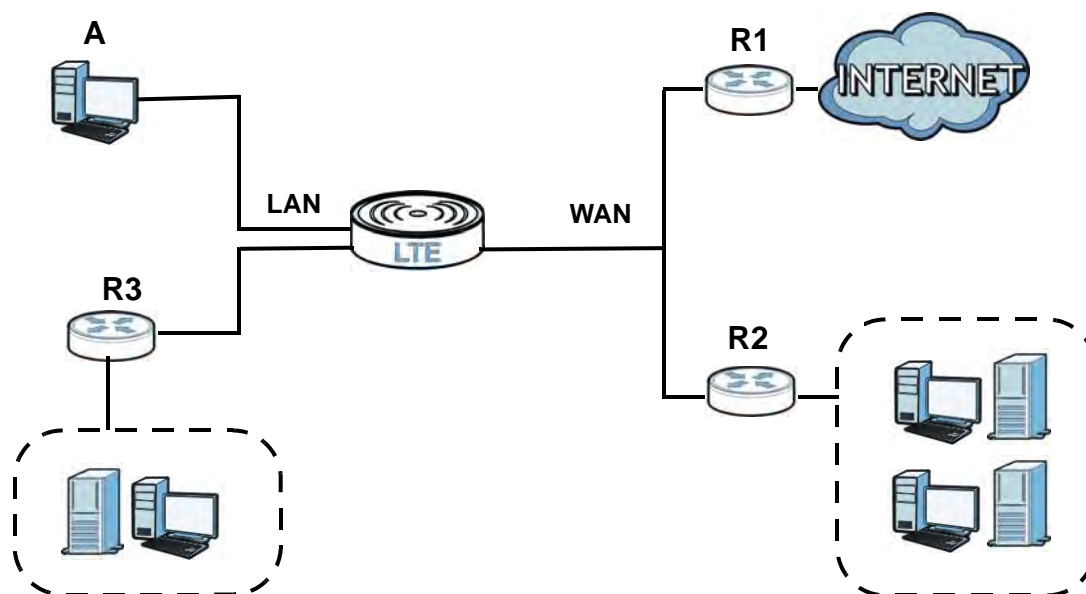

7.2 Configuring Static Route

Use this screen to view and configure IP static routes on the LTE Device. Click **Network Setting > Static Route** to open the following screen.

Figure 41 Network Setting > Static Route

#	Active	Status	Name	Destination IP	Gateway	Subnet Mask	Interface	Modify
---	--------	--------	------	----------------	---------	-------------	-----------	--------

The following table describes the labels in this screen.

Table 23 Network Setting > Static Route

LABEL	DESCRIPTION
Add New Static Route	Click this to set up a new static route on the LTE Device.
#	This is the number of an individual static route.
Active	This indicates whether the rule is active or not. A yellow bulb signifies that this static route is active. A gray bulb signifies that this static route is not active.
Status	This shows whether the static route is currently in use or not. A yellow bulb signifies that this static route is in use. A gray bulb signifies that this static route is not in use.
Name	This is the name that describes or identifies this route.
Destination IP	This parameter specifies the IP network address of the final destination. Routing is always based on network number.
Gateway	This is the IP address of the gateway. The gateway is a router or switch on the same network segment as the device's LAN or WAN port. The gateway helps forward packets to their destinations.
Subnet Mask	This parameter specifies the IP network subnet mask of the final destination.
Interface	This indicates which interface handles the traffic forwarded by this route.
Modify	Click the Edit icon to go to the screen where you can set up a static route on the LTE Device. Click the Delete icon to remove a static route from the LTE Device.

7.2.1 Add/Edit Static Route

Click **add new Static Route** in the **Routing** screen or click the **Edit** icon next to a rule. The following screen appears. Use this screen to configure the required information for a static route.

Figure 42 Routing: Add/Edit

Active

Route Name :

Destination IP Address :

IP Subnet Mask :

Gateway IP Address :

Bound Interface NotAvailiable ▾

Note :
The Destination IP Address and IP Subnet Mask fields must be matched; e.g. host/255.255.255.255 or subnet/255.255.255.0.

Apply Back

The following table describes the labels in this screen.

Table 24 Routing: Add/Edit

LABEL	DESCRIPTION
Active	Click this to activate this static route.
Route Name	Enter the name of the IP static route. Leave this field blank to delete this static route.
Destination IP Address	This parameter specifies the IP network address of the final destination. Routing is always based on network number. If you need to specify a route to a single host, use a subnet mask of 255.255.255.255 in the subnet mask field to force the network number to be identical to the host ID.
IP Subnet Mask	Enter the IP subnet mask here.
Gateway IP Address	You can decide if you want to forward packets to a gateway IP address or a bound interface. If you want to configure Gateway IP Address , enter the IP address of the next-hop gateway. The gateway is a router or switch on the same network segment as the device's LAN or WAN port. The gateway helps forward packets to their destinations.
Bound Interface	You can decide if you want to forward packets to a gateway IP address or a bound interface. If you want to configure Bound Interface , select the check box and choose an interface through which the traffic is sent.
Apply	Click Apply to save your changes.
Back	Click Back to exit this screen without saving.

DNS Route

8.1 Overview

DNS (Domain Name System) is for mapping a domain name to its corresponding IP address and vice versa. The DNS server is extremely important because without it, you must know the IP address of a machine before you can access it.

In addition to the system DNS server(s), each WAN interface (service) is set to have its own static or dynamic DNS server list. You can configure a DNS static route to forward DNS queries for certain domain names through a specific WAN interface to its DNS server(s). The LTE Device uses a system DNS server (in the order you specify in the **Broadband** screen) to resolve domain names that do not match any DNS routing entry. After the LTE Device receives a DNS reply from a DNS server, it creates a new entry for the resolved IP address in the routing table.

In the following example, the DNS server 168.92.5.1 obtained from the WAN interface atm0.100 is set to be the system DNS server. The DNS server 10.10.23.7 is obtained from the WAN interface ppp1.123. You configure a DNS route for *example.com to have the LTE Device forward DNS requests for the domain name mail.example.com through the WAN interface ppp1.123 to the DNS server 10.10.23.7.

Figure 43 Example of DNS Routing Topology

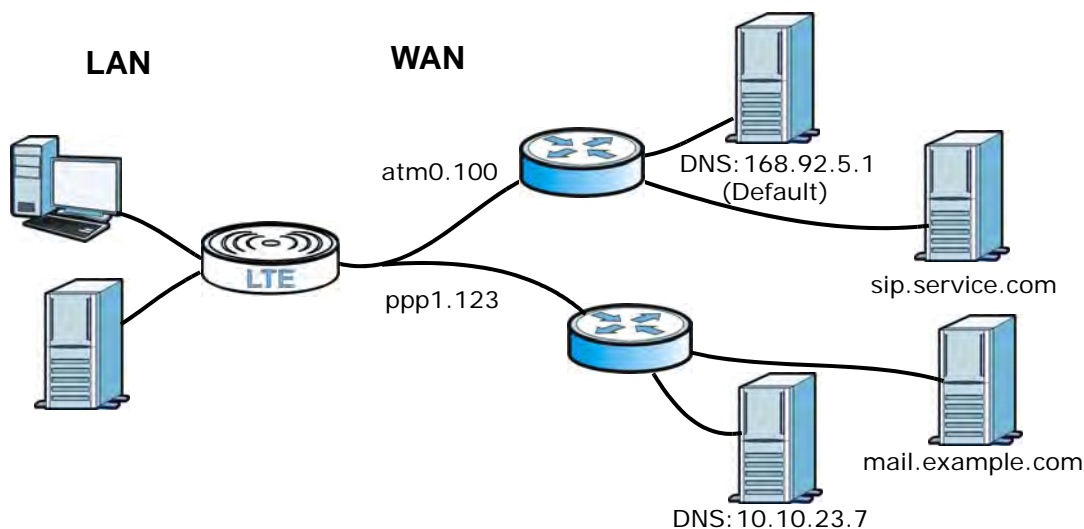

8.1.1 What You Can Do in this Chapter

The **DNS Route** screens let you view and configure DNS routes on the LTE Device ([Section 8.2 on page 80](#)).

8.2 The DNS Route Screen

The **DNS Route** screens let you view and configure DNS routes on the LTE Device. Click **Network Setting > DNS Route** to open the **DNS Route** screen.

Figure 44 Network Setting > DNS Route

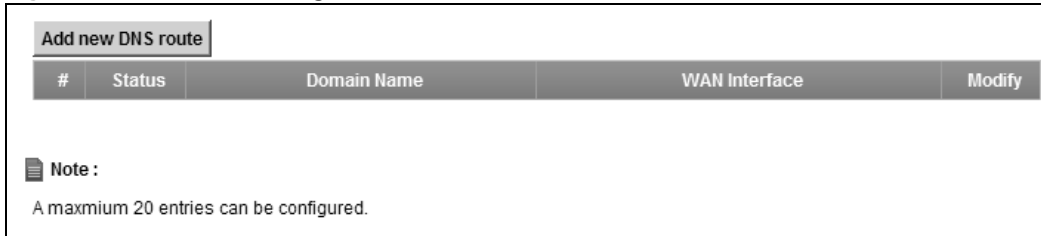

Add new DNS route

#	Status	Domain Name	WAN Interface	Modify
---	--------	-------------	---------------	--------

Note :
A maximum 20 entries can be configured.

The following table describes the labels in this screen.

Table 25 Network Setting > DNS Route

LABEL	DESCRIPTION
Add new DNS route	Click this to create a new entry.
#	This is the number of an individual DNS route.
Status	This shows whether the DNS route is currently in use or not. A yellow bulb signifies that this DNS route is in use. A gray bulb signifies that this DNS route is not in use.
Domain Name	This is the domain name to which the DNS route applies.
WAN Interface	This is the WAN interface through which the matched DNS request is routed.
Modify	Click the Edit icon to configure a DNS route on the LTE Device. Click the Delete icon to remove a DNS route from the LTE Device.

8.2.1 Add/Edit DNS Route Edit

Click **Add new DNS route** in the **DNS Route** screen or the **Edit** icon next to an existing DNS route. Use this screen to configure the required information for a DNS route.

Figure 45 DNS Route: Add/Edit



Active

Domain Name :

WAN Interface :

Note :
Must select one WAN interface.

Apply **Back**

The following table describes the labels in this screen.

Table 26 DNS Route: Add/Edit

LABEL	DESCRIPTION
Active	Select this to activate this DNS route.
Domain Name	Enter the domain name you want to resolve. You can use the wildcard character, an "*" (asterisk) as the left most part of a domain name, such as *.example.com. The LTE Device forwards DNS queries for any domain name ending in example.com to the WAN interface specified in this route.
WAN Interface	Select a WAN interface through which the matched DNS query is sent. You must have the WAN interface(s) already configured in the Broadband screen.
Apply	Click Apply to save your changes.
Back	Click Back to exit this screen without saving.

Quality of Service (QoS)

9.1 Overview

This chapter discusses the LTE Device's **QoS** screens. Use these screens to set up your LTE Device to use QoS for traffic management.

Quality of Service (QoS) refers to both a network's ability to deliver data with minimum delay, and the networking methods used to control the use of bandwidth. QoS allows the LTE Device to group and prioritize application traffic and fine-tune network performance.

Without QoS, all traffic data is equally likely to be dropped when the network is congested. This can cause a reduction in network performance and make the network inadequate for time-critical application such as video-on-demand.

The LTE Device assigns each packet a priority and then queues the packet accordingly. Packets assigned a high priority are processed more quickly than those with low priority if there is congestion, allowing time-sensitive applications to flow more smoothly. Time-sensitive applications include both those that require a low level of latency (delay) and a low level of jitter (variations in delay) such as Internet gaming, and those for which jitter alone is a problem such as Internet radio or streaming video.

Note: The LTE Device has built-in configurations for Voice over IP (IP). The Quality of Service (QoS) feature does not affect VoIP traffic.

- See [Section 9.6 on page 92](#) for advanced technical information on SIP.

9.1.1 What You Can Do in this Chapter

- Use the **General** screen to enable QoS, set the bandwidth, and allow the LTE Device to automatically assign priority to upstream traffic according to the IEEE 802.1p priority level, IP precedence or packet length ([Section 9.2 on page 84](#)).
- Use the **Queue Setup** screen to configure QoS queue assignment ([Section 9.3 on page 86](#)).
- Use the **Class Setup** screen to set up classifiers to sort traffic into different flows and assign priority and define actions to be performed for a classified traffic flow ([Section 9.4 on page 87](#)).
- Use the **Monitor** screen to view the LTE Device's QoS-related packet statistics ([Section 9.5 on page 92](#)).

9.1.2 What You Need to Know

The following terms and concepts may help as you read this chapter.

QoS versus Cos

QoS is used to prioritize source-to-destination traffic flows. All packets in the same flow are given the same priority. CoS (class of service) is a way of managing traffic in a network by grouping similar types of traffic together and treating each type as a class. You can use CoS to give different priorities to different packet types.

CoS technologies include IEEE 802.1p layer 2 tagging and DiffServ (Differentiated Services or DS). IEEE 802.1p tagging makes use of three bits in the packet header, while DiffServ is a new protocol and defines a new DS field, which replaces the eight-bit ToS (Type of Service) field in the IP header.

Tagging and Marking

In a QoS class, you can configure whether to add or change the DSCP (DiffServ Code Point) value and IEEE 802.1p priority level in a matched packet. When the packet passes through a compatible network, the networking device, such as a backbone switch, can provide specific treatment or service based on the tag or marker.

9.2 The QoS General Screen

Use this screen to enable or disable QoS, set the bandwidth, and select to have the LTE Device automatically assign priority to upstream traffic according to the IEEE 802.1p priority level, IP precedence or packet length.

Click **Network Setting** > **QoS** to open the **General** screen.

Figure 46 Network Setting > QoS > General

Active QoS

WAN Managed Upstream Bandwidth : (kbps)

Traffic priority will be automatically assigned by

Active upstream hardware Queue if available

Note :

You can assign the upstream bandwidth manually.
 If the field is empty, the CPE set the value automatically.
 If Enable QoS checkbox is selected, choose an automapping type to assign traffic priority automatically.

The following table describes the labels in this screen.

Table 27 Network Setting > QoS > General

LABEL	DESCRIPTION
Active QoS	<p>Select the check box to turn on QoS to improve your network performance.</p> <p>You can give priority to traffic that the LTE Device forwards out through the WAN interface. Give high priority to voice and video to make them run more smoothly. Similarly, give low priority to many large file downloads so that they do not reduce the quality of other applications.</p>
WAN Managed Upstream Bandwidth	<p>Enter the amount of bandwidth for the WAN interface that you want to allocate using QoS.</p> <p>The recommendation is to set this speed to match the interface's actual transmission speed. For example, set the WAN interface speed to 1000 kbps if your Internet connection has an upstream transmission speed of 1 Mbps.</p> <p>Setting this number higher than the interface's actual transmission speed will stop lower priority traffic from being sent if higher priority traffic uses all of the actual bandwidth.</p> <p>If you set this number lower than the interface's actual transmission speed, the LTE Device will not use some of the interface's available bandwidth.</p> <p>Leave this field blank to have the LTE Device set this value automatically.</p>
Traffic priority will be automatically assigned by	<p>These fields are ignored if upstream traffic matches a class you configured in the Class Setup screen.</p> <p>If you select Ethernet Priority, IP Precedence or Packet Length and traffic does not match a class configured in the Class Setup screen, the LTE Device assigns priority to unmatched traffic based on the IEEE 802.1p priority level, IP precedence or packet length.</p> <p>See Section 9.6.1 on page 93 for more information.</p>
Active upstream hardware Queue if available	??
Apply	Click Apply to save your changes.
Cancel	Click Cancel to restore your previously saved settings.

9.3 The Queue Setup Screen

Use this screen to configure QoS queue assignment. Click **Network Setting > QoS > Queue Setup** to open the screen as shown next.

Figure 47 Network Setting > QoS > Queue Setup

Add new Queue								
#	Status	Name	Interface	Priority	Weight	Buffer Management	Rate Limit (kbps)	Modify
1		WAN_Default_Queue	WAN	4	1	DT		
2		LAN_Default_Queue	LAN	4	1	DT		
3		Fast	WAN	7	3	DT		
4		Active user	WAN	5	3	DT		
5		Passive user	WAN	3	3	DT		
6		Slow	WAN	1	3	DT		

Note :
Maximum 8 user configurable entries.

The following table describes the labels in this screen.

Table 28 Network Setting > QoS > Queue Setup

LABEL	DESCRIPTION
Add new Queue	Click this to create a new entry.
#	This is the index number of this entry.
Status	This indicates whether the queue is active or not. A yellow bulb signifies that this queue is active. A gray bulb signifies that this queue is not active.
Name	This shows the descriptive name of this queue.
Interface	This shows the name of the LTE Device's interface through which traffic in this queue passes.
Priority	This shows the priority of this queue.
Weight	This shows the weight of this queue.
Buffer Management	This shows the queue management algorithm used by the LTE Device.
Rate Limit (kbps)	This shows the maximum transmission rate allowed for traffic on this queue.
Modify	Click the Edit icon to edit the queue. Click the Delete icon to delete an existing queue. Note that subsequent rules move up by one when you take this action.

9.3.1 Add/Edit a QoS Queue

Use this screen to configure a queue. Click **Add new queue** in the **Queue Setup** screen or the **Edit** icon next to an existing queue.

Figure 48 Queue Setup: Add/Edit

The following table describes the labels in this screen.

Table 29 Queue Setup: Add/Edit

LABEL	DESCRIPTION
Active	Select to enable or disable this queue.
Name	Enter the descriptive name of this queue.
Interface	This shows the interface of this queue.
Priority	Select the priority level (from 1 to 7) of this queue. The larger the number, the higher the priority level. Traffic assigned to higher priority queues gets through faster while traffic in lower priority queues is dropped if the network is congested.
Weight	Select the weight (from 1 to 15) of this queue. If two queues have the same priority level, the LTE Device divides the bandwidth across the queues according to their weights. Queues with larger weights get more bandwidth than queues with smaller weights.
Rate Limit	Specify the maximum transmission rate (in Kbps) allowed for traffic on this queue.
Apply	Click Apply to save your changes.
Back	Click Back to return to the previous screen without saving.

9.4 The Class Setup Screen

Use this screen to add, edit or delete QoS classifiers. A classifier groups traffic into data flows according to specific criteria such as the source address, destination address, source port number, destination port number or incoming interface. For example, you can configure a classifier to select traffic from the same protocol port (such as Telnet) to form a flow.

You can give different priorities to traffic that the LTE Device forwards out through the WAN interface. Give high priority to voice and video to make them run more smoothly. Similarly, give low priority to many large file downloads so that they do not reduce the quality of other applications.

Click **Network Setting > QoS > Class Setup** to open the following screen.

Figure 49 Network Setting > QoS > Class Setup

Add new Classifier								
Order	Status	Class Name	Classification Criteria	Forward to	DSCP Mark	802.1P Mark	To Queue	Modify
1		From device	Interface: Local	UnChange	UnChange	UnChange	Fast	
2		ICMP	Ether Type: IP Protocol: ICMP	UnChange	UnChange	UnChange	Fast	
3		HTTP	Ether Type: IP Protocol: TCP Destination Port: 80	UnChange	UnChange	UnChange	Active user	
4		HTTP-Proxy	Ether Type: IP Protocol: TCP Destination Port: 8080	UnChange	UnChange	UnChange	Active user	
5		HTTPS	Ether Type: IP Protocol: TCP Destination Port: 443	UnChange	UnChange	UnChange	Active user	
6		LAN or WLAN TCP po...	Ether Type: IP Protocol: TCP Destination Port: 1024:...	UnChange	UnChange	UnChange	Slow	
7		LAN or WLAN UDP po...	Ether Type: IP Protocol: UDP Destination Port: 1024:...	UnChange	UnChange	UnChange	Slow	

The following table describes the labels in this screen.

Table 30 Network Setting > QoS > Class Setup

LABEL	DESCRIPTION
Add new Classifier	Click this to create a new classifier.
Order	This field displays the order number of the classifier.
Status	This indicates whether the classifier is active or not. A yellow bulb signifies that this classifier is active. A gray bulb signifies that this classifier is not active.
Class Name	This is the name of the classifier.
Classification Criteria	This shows criteria specified in this classifier, for example the interface from which traffic of this class should come and the source MAC address of traffic that matches this classifier.
Forward to	This is the interface through which traffic that matches this classifier is forwarded out.
DSCP Mark	This is the DSCP number added to traffic of this classifier.
802.1p Mark	This is the IEEE 802.1p priority level assigned to traffic of this classifier.
To Queue	This is the name of the queue in which traffic of this classifier is put.
Modify	Click the Edit icon to edit the classifier. Click the Delete icon to delete an existing classifier. Note that subsequent rules move up by one when you take this action.

9.4.1 Add/Edit QoS Class

Click **Add new Classifier** in the **Class Setup** screen or the **Edit** icon next to an existing classifier to configure it.

Figure 50 Class Setup: Add/Edit

Class Configuration

Active :

Class Name :

Classification Order :

Forward To Interface :

DSCP Mark : (0-63)

802.1P : Mark :

To Queue :

Criteria Configuration

Use the configurations below to specify the characteristics of a data flow need to be managed by this QoS rule

- **Basic**
 - From Interface
 - Ether Type
- **Source**
 - MAC Address MAC Mask Exclude
 - IP Address IP Subnet Mask Exclude
 - Port Range ~ (1-65535) Exclude
- **Destination**
 - MAC Address MAC Mask Exclude
 - IP Address IP Subnet Mask Exclude
 - Port Range ~ (1-65535) Exclude
- **Others**
 - 802.1P Exclude
 - IP Protocol Exclude
 - IP Packet Length ~ (46-1504) Exclude
 - DSCP Exclude
 - TCP ACK Exclude
 - DHCP Exclude
 - Class ID (String)
 - Service Exclude

The following table describes the labels in this screen.

Table 31 Class Setup: Add/Edit

LABEL	DESCRIPTION
Class Configuration	
Active	Select to enable this classifier.
Class Name	Enter a descriptive name of up to 32 printable English keyboard characters, including spaces.
Classification Order	Select an existing number for where you want to put this classifier to move the classifier to the number you selected after clicking Apply . Select Last to put this rule in the back of the classifier list.

Table 31 Class Setup: Add/Edit (continued)

LABEL	DESCRIPTION
Forward to Interface	Select a WAN interface through which traffic of this class will be forwarded out. If you select Unchange , the LTE Device forward traffic of this class according to the default routing table.
DSCP Mark	<p>This field is available only when you select the Ether Type check box in Criteria Configuration-Basic section.</p> <p>If you select Mark, enter a DSCP value with which the LTE Device replaces the DSCP field in the packets.</p> <p>If you select Unchange, the LTE Device keep the DSCP field in the packets.</p>
802.1p Mark	<p>Select a priority level with which the LTE Device replaces the IEEE 802.1p priority field in the packets.</p> <p>If you select Unchange, the LTE Device keep the 802.1p priority field in the packets.</p>
To Queue	<p>Select a queue that applies to this class.</p> <p>You should have configured a queue in the Queue Setup screen already.</p>
<p>Criteria Configuration</p> <p>Use the following fields to configure the criteria for traffic classification.</p>	
Basic	
From Interface	Select whether the traffic class comes from the LAN or a wireless interface.
Ether Type	<p>Select a predefined application to configure a class for the matched traffic.</p> <p>If you select IP, you also need to configure source or destination MAC address, IP address, DHCP options, DSCP value or the protocol type.</p> <p>If you select 8021Q, you can configure an 802.1p priority level in the Others section.</p>
Source	
MAC Address	Select the check box and enter the source MAC address of the packet.
MAC Mask	<p>Type the mask for the specified MAC address to determine which bits a packet's MAC address should match.</p> <p>Enter "f" for each bit of the specified source MAC address that the traffic's MAC address should match. Enter "0" for the bit(s) of the matched traffic's MAC address, which can be of any hexadecimal character(s). For example, if you set the MAC address to 00:13:49:00:00:00 and the mask to ff:ff:ff:00:00:00, a packet with a MAC address of 00:13:49:12:34:56 matches this criteria.</p>
IP Address	Select the check box and enter the source IP address in dotted decimal notation. A blank source IP address means any source IP address.
IP Subnet Mask	Enter the source subnet mask.
Port Range	If you select TCP or UDP in the IP Protocol field, select the check box and enter the port number(s) of the source.
Exclude	Select this option to exclude the packets that match the specified criteria from this classifier.
Destination	
MAC Address	Select the check box and enter the destination MAC address of the packet.
MAC Mask	<p>Type the mask for the specified MAC address to determine which bits a packet's MAC address should match.</p> <p>Enter "f" for each bit of the specified source MAC address that the traffic's MAC address should match. Enter "0" for the bit(s) of the matched traffic's MAC address, which can be of any hexadecimal character(s). For example, if you set the MAC address to 00:13:49:00:00:00 and the mask to ff:ff:ff:00:00:00, a packet with a MAC address of 00:13:49:12:34:56 matches this criteria.</p>

Table 31 Class Setup: Add/Edit (continued)

LABEL	DESCRIPTION
IP Address	Select the check box and enter the destination IP address in dotted decimal notation. A blank source IP address means any source IP address.
IP Subnet Mask	Enter the destination subnet mask.
Port Range	If you select TCP or UDP in the IP Protocol field, select the check box and enter the port number(s) of the source.
Exclude	Select this option to exclude the packets that match the specified criteria from this classifier.
Others	
802.1p	This field is available only when you select 802.1Q in the Ether Type field. Select this option and select a priority level (between 0 and 7) from the drop down list box. "0" is the lowest priority level and "7" is the highest.
IP Protocol	This field is available only when you select IP in the Ether Type field. Select this option and select the protocol (service type) from TCP or UDP . If you select User defined , enter the protocol (service type) number.
IP Packet Length	This field is available only when you select IP in the Ether Type field. Select this option and enter the minimum and maximum packet length (from 46 to 1504) in the fields provided.
DSCP	This field is available only when you select IP in the Ether Type field. Select this option and specify a DSCP (DiffServ Code Point) number between 0 and 63 in the field provided.
TCP ACK	This field is available only when you select IP in the Ether Type field. If you select this option, the matched TCP packets must contain the ACK (Acknowledge) flag.
DHCP	This field is available only when you select IP in the Ether Type field, and UDP in the IP Protocol field. Select this option and select a DHCP option. If you select Vendor Class ID (DHCP Option 60) , enter the Class ID of the matched traffic, such as the type of the hardware or firmware. If you select ClientID (DHCP Option 61) , enter the Type of the matched traffic and Client ID of the DHCP client. If you select User Class ID (DHCP Option 77) , enter the User Class Data , which is a string that identifies the user's category or application type in the matched DHCP packets. If you select VendorSpecificIntro (DHCP Option 125) , enter the Enterprise Number of the software of the matched traffic and Vendor Class Data used by all the DHCP clients.
Service	Select the service classification of the traffic.
Exclude	Select this option to exclude the packets that match the specified criteria from this classifier.
Apply	Click Apply to save your changes.
Back	Click Back to return to the previous screen without saving.

9.5 The QoS Monitor Screen

To view the LTE Device's QoS packet statistics, click **Network Setting > QoS > Monitor**. The screen appears as shown.

Figure 51 Network Setting > QoS > Monitor

The screenshot shows the QoS Monitor screen with the following elements:

- Monitor** section: Refresh Interval set to "No Refresh".
- Status :**
 - Interface Monitor** table:

#	Name	Pass Rate(bps)
1	ptm0.3900	
 - Queue Monitor** table:

#	Name	Interface	Pass Rate(bps)	Drop Rate(bps)
1	WAN_Default_Queue	WAN	0	0
2	LAN_Default_Queue	LAN	0	0
3	Fast	WAN	0	0
4	Active user	WAN	0	0
5	Passive user	WAN	0	0
6	Slow	WAN	0	0

The following table describes the labels in this screen.

Table 32 Network Setting > QoS > Monitor

LABEL	DESCRIPTION
Monitor	
Refresh Interval	Select how often you want the LTE Device to update this screen. Select No Refresh to stop refreshing statistics.
Status	
#	This is the index number of the entry.
Name	This shows the name of the WAN interface on the LTE Device.
Pass Rate (bps)	This shows how much traffic (bps) forwarded to this interface are transmitted successfully.
Queue Monitor	
#	This is the index number of the entry.
Name	This shows the name of the queue.
Pass Rate (bps)	This shows how much traffic (bps) assigned to this queue are transmitted successfully.
Drop Rate (bps)	This shows how much traffic (bps) assigned to this queue are dropped.

9.6 QoS Technical Reference

This section provides some technical background information about the topics covered in this chapter.

9.6.1 IEEE 802.1p

IEEE 802.1p specifies the user priority field and defines up to eight separate traffic types. The following table describes the traffic types defined in the IEEE 802.1d standard (which incorporates the 802.1p).

Table 33 IEEE 802.1p Priority Level and Traffic Type

PRIORITY LEVEL	TRAFFIC TYPE
Level 7	Typically used for network control traffic such as router configuration messages.
Level 6	Typically used for voice traffic that is especially sensitive to jitter (jitter is the variations in delay).
Level 5	Typically used for video that consumes high bandwidth and is sensitive to jitter.
Level 4	Typically used for controlled load, latency-sensitive traffic such as SNA (Systems Network Architecture) transactions.
Level 3	Typically used for "excellent effort" or better than best effort and would include important business traffic that can tolerate some delay.
Level 2	This is for "spare bandwidth".
Level 1	This is typically used for non-critical "background" traffic such as bulk transfers that are allowed but that should not affect other applications and users.
Level 0	Typically used for best-effort traffic.

9.6.2 IP Precedence

Similar to IEEE 802.1p prioritization at layer-2, you can use IP precedence to prioritize packets in a layer-3 network. IP precedence uses three bits of the eight-bit ToS (Type of Service) field in the IP header. There are eight classes of services (ranging from zero to seven) in IP precedence. Zero is the lowest priority level and seven is the highest.

9.6.3 DiffServ

QoS is used to prioritize source-to-destination traffic flows. All packets in the flow are given the same priority. You can use CoS (class of service) to give different priorities to different packet types.

DiffServ (Differentiated Services) is a class of service (CoS) model that marks packets so that they receive specific per-hop treatment at DiffServ-compliant network devices along the route based on the application types and traffic flow. Packets are marked with DiffServ Code Points (DSCPs) indicating the level of service desired. This allows the intermediary DiffServ-compliant network devices to handle the packets differently depending on the code points without the need to negotiate paths or remember state information for every flow. In addition, applications do not have to request a particular service or give advanced notice of where the traffic is going.

DSCP and Per-Hop Behavior

DiffServ defines a new DS (Differentiated Services) field to replace the Type of Service (TOS) field in the IP header. The DS field contains a 2-bit unused field and a 6-bit DSCP field which can define up to 64 service levels. The following figure illustrates the DS field.

DSCP is backward compatible with the three precedence bits in the ToS octet so that non-DiffServ compliant, ToS-enabled network device will not conflict with the DSCP mapping.

DSCP (6 bits)	Unused (2 bits)
---------------	-----------------

The DSCP value determines the forwarding behavior, the PHB (Per-Hop Behavior), that each packet gets across the DiffServ network. Based on the marking rule, different kinds of traffic can be marked for different kinds of forwarding. Resources can then be allocated according to the DSCP values and the configured policies.

Network Address Translation (NAT)

10.1 Overview

NAT (Network Address Translation - NAT, RFC 1631) is the translation of the IP address of a host in a packet, for example, the source address of an outgoing packet, used within one network to a different IP address known within another network.

10.1.1 What You Can Do in this Chapter

- Use the **Port Forwarding** screen to configure forward incoming service requests to the server(s) on your local network ([Section 10.2 on page 96](#)).
- Use the **DMZ** screen to view and configure the IP address of your network DMZ. ([Section 10.3 on page 99](#)).
- Use the **Sessions** screen to limit the number of concurrent NAT sessions each client can use ([Section 10.4 on page 99](#)).

10.1.2 What You Need To Know

The following terms and concepts may help as you read this chapter.

Inside/Outside and Global/Local

Inside/outside denotes where a host is located relative to the LTE Device, for example, the computers of your subscribers are the inside hosts, while the web servers on the Internet are the outside hosts.

Global/local denotes the IP address of a host in a packet as the packet traverses a router, for example, the local address refers to the IP address of a host when the packet is in the local network, while the global address refers to the IP address of the host when the same packet is traveling in the WAN side.

NAT

In the simplest form, NAT changes the source IP address in a packet received from a subscriber (the inside local address) to another (the inside global address) before forwarding the packet to the WAN side. When the response comes back, NAT translates the destination address (the inside global address) back to the inside local address before forwarding it to the original inside host.

Port Forwarding

A port forwarding set is a list of inside (behind NAT on the LAN) servers, for example, web or FTP, that you can make visible to the outside world even though NAT makes your whole inside network appear as a single computer to the outside world.

Finding Out More

See [Section 10.5 on page 100](#) for advanced technical information on NAT.

10.2 The Port Forwarding Screen

Use the **Port Forwarding** screen to forward incoming service requests to the server(s) on your local network.

You may enter a single port number or a range of port numbers to be forwarded, and the local IP address of the desired server. The port number identifies a service; for example, web service is on port 80 and FTP on port 21. In some cases, such as for unknown services or where one server can support more than one service (for example both FTP and web service), it might be better to specify a range of port numbers. You can allocate a server IP address that corresponds to a port or a range of ports.

The most often used port numbers and services are shown in [Appendix E on page 249](#). Please refer to RFC 1700 for further information about port numbers.

Note: Many residential broadband ISP accounts do not allow you to run any server processes (such as a Web or FTP server) from your location. Your ISP may periodically check for servers and may suspend your account if it discovers any active services at your location. If you are unsure, refer to your ISP.

Configuring Servers Behind Port Forwarding (Example)

Let's say you want to assign ports 21-25 to one FTP, Telnet and SMTP server (**A** in the example), port 80 to another (**B** in the example) and assign a default server IP address of 10.0.0.35 to a third (**C** in the example). You assign the LAN IP addresses and the ISP assigns the WAN IP address. The NAT network appears as a single host on the Internet.

Figure 52 Multiple Servers Behind NAT Example

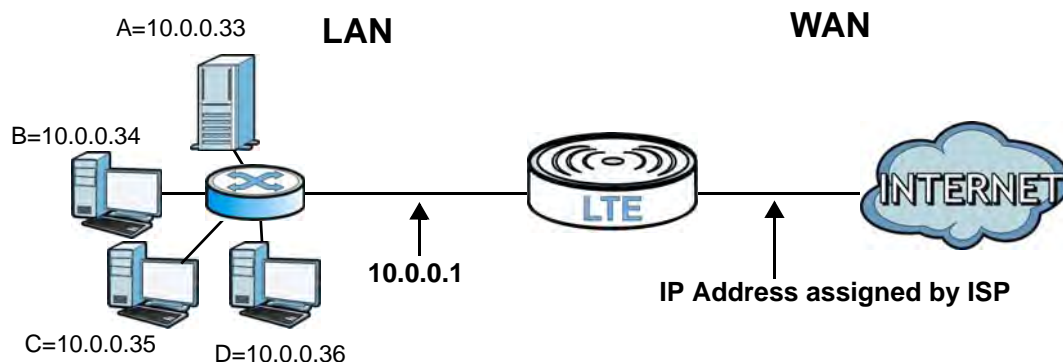

10.2.1 The Port Forwarding Screen

Click **Network Setting > NAT** to open the **Port Forwarding** screen.

See [Appendix E on page 249](#) for port numbers commonly used for particular services.

Figure 53 Network Setting > NAT > Port Forwarding

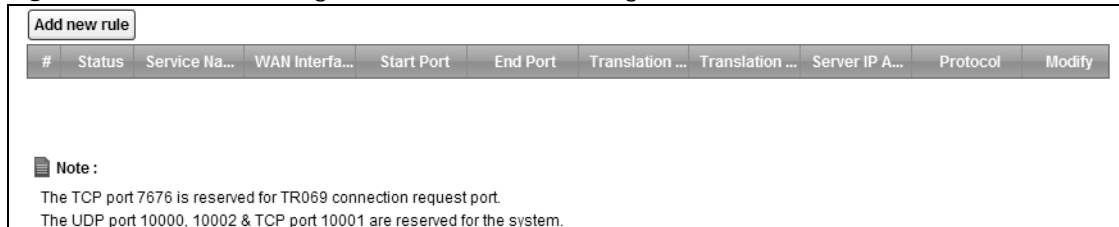

The screenshot shows a web interface for port forwarding. At the top left is a button labeled "Add new rule". Below it is a table with the following columns: #, Status, Service Name, WAN Interface, Start Port, End Port, Translation Start Port, Translation End Port, Server IP Address, Protocol, and Modify. Below the table is a "Note" section with a document icon, stating: "The TCP port 7676 is reserved for TR069 connection request port. The UDP port 10000, 10002 & TCP port 10001 are reserved for the system."

The following table describes the fields in this screen.

Table 34 Network Setting > NAT > Port Forwarding

LABEL	DESCRIPTION
Add new rule	Click this to add a new port forwarding rule.
#	This is the index number of the entry.
Status	This field indicates whether the rule is active or not. A yellow bulb signifies that this rule is active. A gray bulb signifies that this rule is not active.
Service Name	This is the service's name. This shows User Defined if you manually added a service. You can change this by clicking the edit icon.
WAN Interface	This shows the WAN interface through which the service is forwarded.
Start Port	This is the first external port number that identifies a service.
End Port	This is the last external port number that identifies a service.
Translation Start Port	This is the first internal port number that identifies a service.
Translation End Port	This is the last internal port number that identifies a service.
Server IP Address	This is the server's IP address.
Protocol	This shows the IP protocol supported by this virtual server, whether it is TCP, UDP, or TCP/UDP .
Modify	Click the Edit icon to edit the port forwarding rule. Click the Delete icon to delete an existing port forwarding rule. Note that subsequent address mapping rules move up by one when you take this action.
Apply	Click Apply to save your changes.
Cancel	Click Cancel to restore your previously saved settings.

10.2.2 The Port Forwarding Edit Screen

This screen lets you create or edit a port forwarding rule. Click **Add new rule** in the **Port Forwarding** screen or the **Edit** icon next to an existing rule to open the following screen.

Figure 54 Port Forwarding: Add/Edit

The screenshot shows a web-based form for configuring port forwarding. The fields are as follows:

- Service Name:** A dropdown menu set to "User Defined" followed by a text input field.
- WAN Interface:** A dropdown menu.
- Start Port:** A text input field.
- End Port:** A text input field.
- Translation Start Port:** A text input field.
- Translation End Port:** A text input field.
- Server IP Address:** A text input field.
- Protocol:** A dropdown menu set to "TCP".

Below the form is a **Note** section with a document icon. The note text reads: "To translate the port to internal server, enter the translated port number of internal server in Translation Start Port and Translation End Port. If you do not need to translate the port, keep the Translation Start Port and Translation End Port the same as Start Port and End Port (one to one mapping)." At the bottom right of the form are two buttons: "Apply" and "Back".

The following table describes the labels in this screen.

Table 35 Port Forwarding: Add/Edit

LABEL	DESCRIPTION
Service Name	Enter a name to identify this rule using keyboard characters (A-Z, a-z, 1-2 and so on).
WAN Interface	Select the WAN interface through which the service is forwarded.
Start Port	Enter the original destination port for the packets. To forward only one port, enter the port number again in the External End Port field. To forward a series of ports, enter the start port number here and the end port number in the External End Port field.
End Port	Enter the last port of the original destination port range. To forward only one port, enter the port number in the External Start Port field above and then enter it again in this field. To forward a series of ports, enter the last port number in a series that begins with the port number in the External Start Port field above.
Translation Start Port	This shows the port number to which you want the LTE Device to translate the incoming port. For a range of ports, enter the first number of the range to which you want the incoming ports translated.
Translation End Port	This shows the last port of the translated port range.
Server IP Address	Enter the inside IP address of the virtual server here.
Protocol Type	Select the protocol supported by this virtual server. Choices are TCP , UDP , or TCP/UDP .
Apply	Click Apply to save your changes.
Back	Click Back to return to the previous screen without saving.

10.3 The DMZ Screen

Use this page to set the IP address of your network DMZ (if you have one) for the LTE Device. All incoming packets received by this LTE Device's WAN interface will be forwarded to the default server you set.

Click **Network Setting > NAT > DMZ** to display the following screen.

Note: The configuration you set in this screen takes priority than the **Network Setting > NAT > Port Forwarding** screen.

Figure 55 Network Setting > NAT > DMZ

Default Server Setup

Default Server Address

Note :
Enter IP Address and click "Apply" to activate the DMZ host.
Clear the IP address field and click "Apply" to deactivate the DMZ host.

Apply Cancel

The following table describes the fields in this screen.

Table 36 Network Setting > NAT > DMZ

LABEL	DESCRIPTION
Default Server Address	Enter the IP address of your network DMZ host, if you have one. 0.0.0.0 means this feature is disabled.
Apply	Click Apply to save your changes.
Cancel	Click Cancel to restore your previously saved settings.

10.4 The Sessions Screen

Use the **Sessions** screen to limit the number of concurrent NAT sessions each client can use.

Click **Network Setting > NAT > Sessions** to display the following screen.

Figure 56 Network Setting > NAT > Sessions

MAX NAT Sessions Per Host: (512 - 20480)

Apply Cancel

The following table describes the fields in this screen.

Table 37 Network Setting > NAT > Sessions

LABEL	DESCRIPTION
MAX NAT Session	Use this field to set a common limit to the number of concurrent NAT sessions each client computer can have. If only a few clients use peer to peer applications, you can raise this number to improve their performance. With heavy peer to peer application use, lower this number to ensure no single client uses too many of the available NAT sessions.
Apply	Click Apply to save your changes.
Cancel	Click Cancel to restore your previously saved settings.

10.5 Technical Reference

This section provides some technical background information about the topics covered in this chapter.

10.5.1 NAT Definitions

Inside/outside denotes where a host is located relative to the LTE Device, for example, the computers of your subscribers are the inside hosts, while the web servers on the Internet are the outside hosts.

Global/local denotes the IP address of a host in a packet as the packet traverses a router, for example, the local address refers to the IP address of a host when the packet is in the local network, while the global address refers to the IP address of the host when the same packet is traveling in the WAN side.

Note that inside/outside refers to the location of a host, while global/local refers to the IP address of a host used in a packet. Thus, an inside local address (ILA) is the IP address of an inside host in a packet when the packet is still in the local network, while an inside global address (IGA) is the IP address of the same inside host when the packet is on the WAN side. The following table summarizes this information.

Table 38 NAT Definitions

ITEM	DESCRIPTION
Inside	This refers to the host on the LAN.
Outside	This refers to the host on the WAN.
Local	This refers to the packet address (source or destination) as the packet travels on the LAN.
Global	This refers to the packet address (source or destination) as the packet travels on the WAN.

NAT never changes the IP address (either local or global) of an outside host.

10.5.2 What NAT Does

In the simplest form, NAT changes the source IP address in a packet received from a subscriber (the inside local address) to another (the inside global address) before forwarding the packet to the WAN side. When the response comes back, NAT translates the destination address (the inside global address) back to the inside local address before forwarding it to the original inside host. Note that the IP address (either local or global) of an outside host is never changed.

The global IP addresses for the inside hosts can be either static or dynamically assigned by the ISP. In addition, you can designate servers, for example, a web server and a Telnet server, on your local network and make them accessible to the outside world. If you do not define any servers, NAT offers the additional benefit of firewall protection. With no servers defined, your LTE Device filters out all incoming inquiries, thus preventing intruders from probing your network. For more information on IP address translation, refer to *RFC 1631, The IP Network Address Translator (NAT)*.

10.5.3 How NAT Works

Each packet has two addresses – a source address and a destination address. For outgoing packets, the ILA (Inside Local Address) is the source address on the LAN, and the IGA (Inside Global Address) is the source address on the WAN. For incoming packets, the ILA is the destination address on the LAN, and the IGA is the destination address on the WAN. NAT maps private (local) IP addresses to globally unique ones required for communication with hosts on other networks. It replaces the original IP source address (and TCP or UDP source port numbers for Many-to-One and Many-to-Many Overload NAT mapping) in each packet and then forwards it to the Internet. The LTE Device keeps track of the original addresses and port numbers so incoming reply packets can have their original values restored. The following figure illustrates this.

Figure 57 How NAT Works

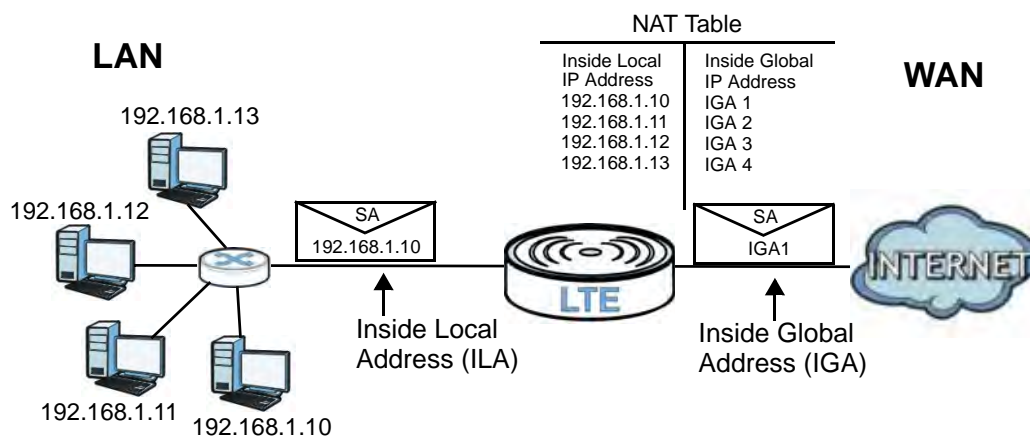

Dynamic DNS

11.1 Overview

This chapter discusses how to configure your LTE Device to use Dynamic DNS.

Dynamic DNS allows you to update your current dynamic IP address with one or many dynamic DNS services so that anyone can contact you (in applications such as NetMeeting and CU-SeeMe). You can also access your FTP server or Web site on your own computer using a domain name (for instance myhost.dns.org, where myhost is a name of your choice) that will never change instead of using an IP address that changes each time you reconnect. Your friends or relatives will always be able to call you even if they don't know your IP address.

First of all, you need to have registered a dynamic DNS account with www.dyndns.org. This is for people with a dynamic IP from their ISP or DHCP server that would still like to have a domain name. The Dynamic DNS service provider will give you a password or key.

11.1.1 What You Need To Know

DYNDNS Wildcard

Enabling the wildcard feature for your host causes *.yourhost.dyndns.org to be aliased to the same IP address as yourhost.dyndns.org. This feature is useful if you want to be able to use, for example, www.yourhost.dyndns.org and still reach your hostname.

If you have a private WAN IP address, then you cannot use Dynamic DNS.

11.2 The Dynamic DNS Screen

Use the **Dynamic DNS** screen to enable DDNS and configure the DDNS settings on the LTE Device. To change your LTE Device's DDNS, click **Network Setting > Dynamic DNS**. The screen appears as shown.

Figure 58 Network Setting > Dynamic DNS

The following table describes the fields in this screen.

Table 39 Network Setting > DNS

LABEL	DESCRIPTION
Dynamic DNS Configuration	
Active Dynamic DNS	Select this check box to use dynamic DNS.
Service Provider	Select the name of your Dynamic DNS service provider.
Dynamic DNS Type	Select the type of service that you are registered for from your Dynamic DNS service provider.
Host Name	Type the domain name assigned to your LTE Device by your Dynamic DNS provider. You can specify up to two host names in the field separated by a comma (",").
User Name	Type your user name.
Password	Type the password assigned to you.
Apply	Click Apply to save your changes.
Cancel	Click Cancel to restore your previously saved settings.

12.1 Overview

Use the LTE Device firewall screens to enable and configure the firewall that protects your LTE Device and network from attacks by hackers on the Internet and control access to it. By default the firewall:

- Allows traffic that originates from your LAN and WLAN computers to go to all other networks.
- Blocks traffic that originates on other networks from going to the LAN and WLAN.

The following figure illustrates the default firewall action. User **A** can initiate an IM (Instant Messaging) session from the LAN to the WAN (**1**). Return traffic for this session is also allowed (**2**). However other traffic initiated from the WAN is blocked (**3** and **4**).

Figure 59 Default Firewall Action

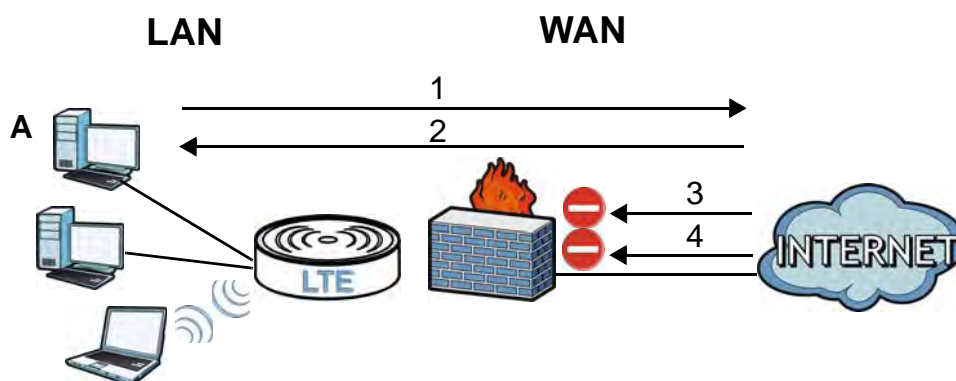

12.1.1 What You Can Do in this Chapter

- Use the **General** screen to enable or disable the LTE Device's firewall ([Section 12.2 on page 107](#)).
- Use the **Services** screen to view the configured firewall rules and add, edit or remove a firewall rule ([Section 12.3 on page 108](#)).
- Use the **Access Control** screen to view and configure incoming/outgoing filtering rules ([Section 12.4 on page 109](#)).
- Use the **DoS** screen to enable or disable Denial of Service (DoS) protection ([Section 12.4 on page 109](#)).

12.1.2 What You Need to Know

DoS

Denials of Service (DoS) attacks are aimed at devices and networks with a connection to the Internet. Their goal is not to steal information, but to disable a device or network so users no longer have access to network resources. The ZyXEL Device is pre-configured to automatically detect and thwart all known DoS attacks.

Firewall

The LTE Device's firewall feature physically separates the LAN/WLAN and the WAN and acts as a secure gateway for all data passing between the networks.

It is designed to protect against Denial of Service (DoS) attacks when activated. The LTE Device's purpose is to allow a private Local Area Network (LAN) to be securely connected to the Internet. The LTE Device can be used to prevent theft, destruction and modification of data, as well as log events, which may be important to the security of your network.

The LTE Device is installed between the LAN/WLAN and a broadband modem connecting to the Internet. This allows it to act as a secure gateway for all data passing between the Internet and the LAN.

The LTE Device has one Ethernet WAN port and four Ethernet LAN ports, which are used to physically separate the network into two areas. The WAN (Wide Area Network) port attaches to the broadband (cable or DSL) modem to the Internet.

The LAN (Local Area Network) port attaches to a network of computers, which needs security from the outside world. These computers will have access to Internet services such as e-mail, FTP and the World Wide Web. However, "inbound access" is not allowed (by default) unless the remote host is authorized to use a specific service.

ICMP

Internet Control Message Protocol (ICMP) is a message control and error-reporting protocol between a host server and a gateway to the Internet. ICMP uses Internet Protocol (IP) datagrams, but the messages are processed by the TCP/IP software and directly apparent to the application user.

Finding Out More

See [Section 12.6 on page 112](#) for advanced technical information on firewall.

12.2 The General Screen

Use this screen to enable or disable the LTE Device's firewall. Click **Security > Firewall** to open the **General** screen.

Figure 60 Security > Firewall > General

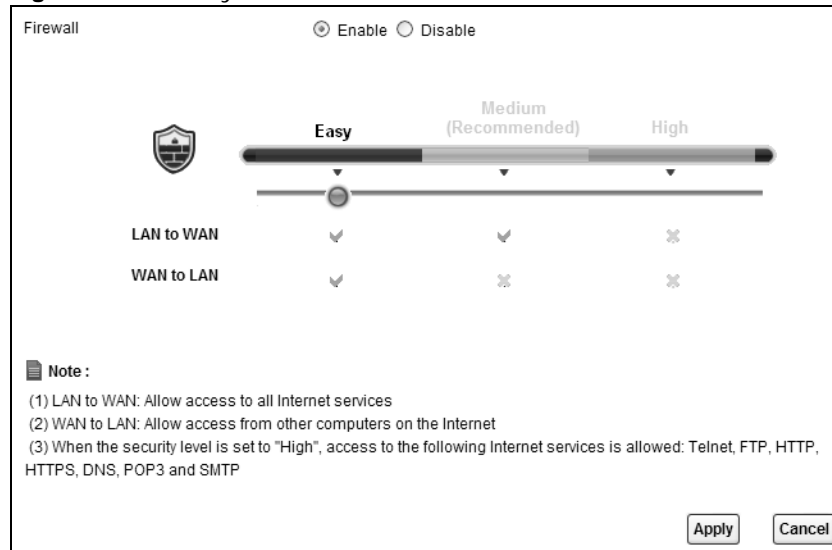

The following table describes the labels in this screen.

Table 40 Security > Firewall > General

LABEL	DESCRIPTION
Firewall	Select Enable to activate the firewall. The LTE Device performs access control and protects against Denial of Service (DoS) attacks when the firewall is activated.
Easy, Medium, High	Select Easy to have the firewall allow both LAN-to-WAN and WAN-to-LAN traffic to flow through the LTE Device. Select Medium to have the firewall only allow traffic sent from the LAN to the WAN. All traffic sent or access from the WAN will be blocked. Select High to have the firewall only allow Telnet, FTP, HTTP, HTTPS, DNS, POP3, and SMTP traffic sent from the LAN to the WAN. Other traffic will be blocked.
Apply	Click Apply to save your changes.
Cancel	Click Cancel to restore your previously saved settings.

12.3 The Services Screen

Use this screen to view the configured service list. To access this screen, click **Security > Firewall > Services**. You have to configure at least one service in this screen before configuring the **Security > Firewall > Access Control > Add New ACL Rule/Edit** screen.

Figure 61 Security > Firewall > Services

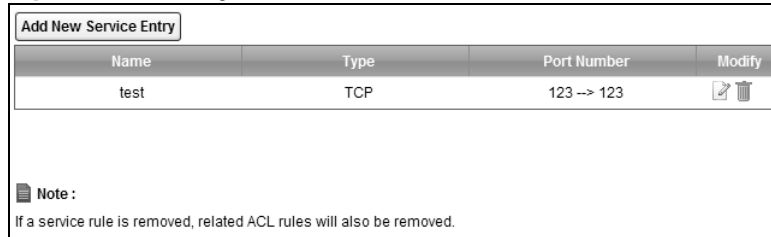

Name	Type	Port Number	Modify
test	TCP	123 --> 123	

Note :
If a service rule is removed, related ACL rules will also be removed.

Each field is described in the following table.

Table 41 Security > Firewall > Services

LABEL	DESCRIPTION
Add New Service Entry	Click this to define a new service.
Name	This is the name of a configured service.
Type	This is the protocol type (TCP , UDP , ICMP or Others) of the service.
Port Number	This displays a range of port numbers that defines the service.
Modify	Click the Edit icon to edit the service. Click the Delete icon to delete the service. Note that subsequent rules move up by one when you take this action. Deleting a service rule also deletes the related ACL rules which are configured in the Security > Firewall > Access Control screen.

12.3.1 The Add New Services Entry Screen

Use this screen to configure a service that you want to use in an ACL rule in the **Security > Firewall > Access Control > Add New ACL Rule/Edit** screen. To access this screen, click **Security > Firewall > Services** and then the **Add New Service Entry** button.

Figure 62 Security > Firewall > Services > Add New Service Entry

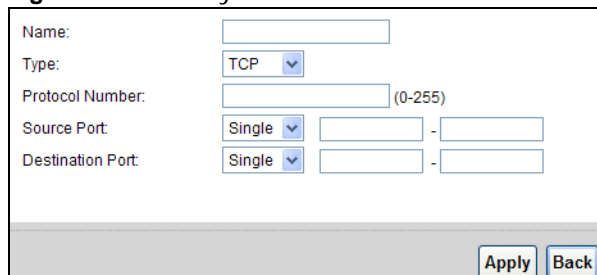

Name:

Type:

Protocol Number: (0-255)

Source Port: -

Destination Port: -

Each field is described in the following table.

Table 42 Security > Firewall > Services > Add New Service Entry

LABEL	DESCRIPTION
Name	Type a descriptive name for the service.
Type	Select the protocol type (TCP , UDP or ICMP or Others) of the service.
Protocol Number	Enter the protocol number of the service type.
Source Port, Destination Port	The source port defines from which port number(s) the service traffic is sent. The destination port defines the port number(s) the destination hosts use to receive the service traffic. Select Single if the service uses one and only one source or destination port, then enter the port number. Select Multiple if the service uses two or more source or destination ports, then enter a port range. For example, suppose you want to define the Gnutella service. Select TCP type and enter a port range of 6345-6349 .
Apply	Click Apply to save your changes.
Back	Click Back to exit this screen without saving your changes.

12.4 The Access Control Screen

Click **Security > Firewall > Access Control** to display the following screen. This screen displays a list of the configured incoming or outgoing filtering rules.

Figure 63 Security > Firewall > Access Control

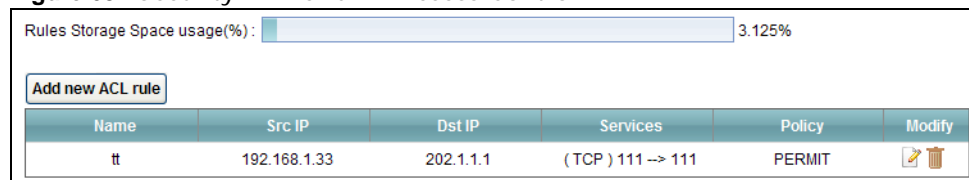

Each field is described in the following table.

Table 43 Security > Firewall > Access Control

LABEL	DESCRIPTION
Rules Storage Space usage(%)	This bar shows the percentage of the LTE Device's space has been used. If the usage is almost full, you may need to remove an existing filter rule before you create a new one.
Add new ACL rule	Click this to go to add a filter rule for incoming or outgoing IP traffic.
Name	This displays the name of the rule.
Src IP	This displays the source IP addresses to which this rule applies. Please note that a blank source address is equivalent to Any .
Dst IP	This displays the destination IP addresses to which this rule applies. Please note that a blank destination address is equivalent to Any .
Services	This displays the protocol type and a port range that define the service to which this rule applies.

Table 43 Security > Firewall > Access Control (continued)

LABEL	DESCRIPTION
Policy	This field displays whether the rule silently discards packets (DROP), discards packets and sends a TCP reset packet or an ICMP destination-unreachable message to the sender (REJECT) or allows the passage of packets (PERMIT).
Modify	Click the Edit icon to edit the rule. Click the Delete icon to delete an existing rule. Note that subsequent rules move up by one when you take this action.

12.4.1 The Add New ACL Rule/Edit Screen

Click **Add New ACL Rule** or the **Edit** icon next to an existing ACL rule in the **Access Control** screen. The following screen displays.

Figure 64 Security > Firewall > Access Control > Add New ACL Rule/Edit

The screenshot shows a configuration form for an ACL rule. The fields are as follows:

- Filter Name:
- Source Address Type: (dropdown)
- Source IP Address Start:
- Source IP Address End:
- Destination Address Type: (dropdown)
- Destination IP Address Start:
- Destination IP Address End:
- Select Protocol: (dropdown)
- Protocol: (dropdown)
- Protocol Number: (0-255)
- Source Port: (dropdown) -
- Destination Port: (dropdown) -
- Policy: (dropdown)
- Direction: (dropdown)

Buttons:

Each field is described in the following table.

Table 44 Security > Firewall > Access Control > Add New ACL Rule/Edit

LABEL	DESCRIPTION
Filter Name	Enter a descriptive name of up to 16 alphanumeric characters, not including spaces, underscores, and dashes. You must enter the filter name to add an ACL rule. This field is read-only if you are editing the ACL rule.
Source Address Type	Select Single or Range depending on whether you want to enter a single or a range of source IP address(es) to which the ACL rule applies. Select Any to indicate any source IP address.
Source IP Address Start	Enter an IP address or the starting IP address of the source IP range.
Source IP Address End	Enter the ending IP address of the source IP range.
Destination Address Type	Select Single or Range depending on whether you want to enter a single or a range of destination IP address(es) to which the ACL rule applies. Select Any to indicate any destination IP address.

Table 44 Security > Firewall > Access Control > Add New ACL Rule/Edit (continued)

LABEL	DESCRIPTION
Destination IP Address Start	Enter an IP address or the starting IP address of the destination IP range.
Destination IP Address End	Enter the ending IP address of the destination IP range.
Select Protocol	Select the name of a configured service or select Select Service to define a new service in this screen.
Protocol	This field is available when you select Select Service in Select Protocol . Choose the protocol type (TCP , UDP , ICMP or Others) of the service.
Protocol Number	This field is available when you select Others in Protocol . Enter the protocol number of the service type to which this ACL rule applies.
Source Port	This field is displayed only when you select Select Service in Select Protocol and TCP or UDP in Protocol . Select Single or Range and then enter a single port number or the range of port numbers of the source. Select Any to indicate any source port.
Destination Port	This field is displayed only when you select Select Service in Select Protocol and TCP or UDP in Protocol . Select Single or Range and then enter a single port number or the range of port numbers of the destination. Select Any to indicate any destination port.
Policy	Use the drop-down list box to select whether to silently discard (DROP), deny and send an ICMP destination-unreachable message to the sender of (REJECT) or allow the passage of (PERMIT) packets that match this rule.
Direction	Use the drop-down list box to select the direction of traffic to which this rule applies. The possible options are LAN to DEVICE , LAN to WAN , WAN to LAN , and WAN to DEVICE .
Apply	Click Apply to save your changes.
Back	Click Back to exit this screen without saving your changes.

12.5 The DoS Screen

Click **Security > Firewall > DoS** to display the following screen. Use this screen to enable or disable Denial of Service (DoS) protection.

Figure 65 Security > Firewall > DoS

DoS Protection Blocking: Enable Disable

Apply Cancel

Each field is described in the following table.

Table 45 Security > Firewall > DoS

LABEL	DESCRIPTION
DoS Protection Blocking	DoS (Denial of Service) attacks can flood your Internet connection with invalid packets and connection requests, using so much bandwidth and so many resources that Internet access becomes unavailable. Select Enable to enable protection against DoS attacks or Disable to disable it.
Apply	Click Apply to save the DoS Protection settings.
Cancel	Click Cancel to restore your previously saved settings.

12.6 Firewall Technical Reference

This section provides some technical background information about the topics covered in this chapter.

12.6.1 Guidelines For Enhancing Security With Your Firewall

- 1 Change the default password via web configurator.
- 2 Think about access control before you connect to the network in any way.
- 3 Limit who can access your LTE Device.
- 4 Don't enable any local service (such as Telnet or FTP) that you don't use. Any enabled service could present a potential security risk. A determined hacker might be able to find creative ways to misuse the enabled services to access the firewall or the network.
- 5 For local services that are enabled, protect against misuse. Protect by configuring the services to communicate only with specific peers, and protect by configuring rules to block packets for the services at specific interfaces.
- 6 Keep the firewall in a secured (locked) room.

12.6.2 Security Considerations

Note: Incorrectly configuring the firewall may block valid access or introduce security risks to the LTE Device and your protected network. Use caution when creating or deleting firewall rules and test your rules after you configure them.

Consider these security ramifications before creating a rule:

- 1 Does this rule stop LAN users from accessing critical resources on the Internet? For example, if IRC is blocked, are there users that require this service?
- 2 Is it possible to modify the rule to be more specific? For example, if IRC is blocked for all users, will a rule that blocks just certain users be more effective?

- 3 Does a rule that allows Internet users access to resources on the LAN create a security vulnerability? For example, if FTP ports (TCP 20, 21) are allowed from the Internet to the LAN, Internet users may be able to connect to computers with running FTP servers.
- 4 Does this rule conflict with any existing rules?

Once these questions have been answered, adding rules is simply a matter of entering the information into the correct fields in the web configurator screens.

MAC Filter

13.1 Overview

This chapter discusses MAC address filtering.

You can configure the LTE Device to permit access to clients based on their MAC addresses in the **MAC Filter** screen. This applies to wired and wireless connections.

13.1.1 What You Need to Know

Every Ethernet device has a unique MAC (Media Access Control) address. The MAC address is assigned at the factory and consists of six pairs of hexadecimal characters, for example, 00:A0:C5:00:00:02. You need to know the MAC address of the devices to configure this screen.

13.2 The MAC Filter Screen

Use the **MAC Filter** screen to allow wireless and LAN clients access to the LTE Device. To change your LTE Device's MAC filter settings, click **Security > MAC Filter**. The screen appears as shown.

Figure 66 Security > MAC Filter

MAC Address Filter: Enable Disable

Set	Allow	MAC Address
1	<input type="checkbox"/>	00:24:21:7E:20:96
2	<input type="checkbox"/>	
3	<input type="checkbox"/>	
4	<input type="checkbox"/>	
5	<input type="checkbox"/>	
29	<input type="checkbox"/>	
30	<input type="checkbox"/>	
31	<input type="checkbox"/>	
32	<input type="checkbox"/>	

Note:
Only devices listed here are granted access to the network.

Apply Cancel

The following table describes the labels in this menu.

Table 46 Security > MAC Filter

LABEL	DESCRIPTION
MAC Address Filter	Select Enable to activate MAC address filtering.
Set	This is the index number of the MAC address.
Allow	Select Allow to permit access to the LTE Device. MAC addresses not listed will be denied access to the LTE Device. If you clear this, the MAC Address field for this set clears.
MAC Address	Enter the MAC addresses of the wireless station and LAN devices that are allowed access to the LTE Device in these address fields. Enter the MAC addresses in a valid MAC address format, that is, six hexadecimal character pairs, for example, 12:34:56:78:9a:bc.
Apply	Click Apply to save your changes.
Cancel	Click Cancel to restore your previously saved settings.

Parental Control

14.1 Overview

Parental control allows you to block web sites with the specific URL. You can also define time periods and days during which the LTE Device performs parental control on a specific user.

14.2 The Parental Control Screen

Use this screen to enable parental control, view the parental control rules and schedules.

Click **Security > Parental Control** to open the following screen.

Figure 67 Security > Parental Control

The screenshot shows the 'Parental Control' screen. At the top, there is a 'General' section with a toggle for 'Parental Control' set to 'Disable'. Below this is an 'Add new PCP' button. A table lists the following rule:

#	Status	PCP Name	Home Network User (MAC)	Internet Access Schedule	Network Service	Website Blocked	Modify
1		PCP1	All	M T W T F S S 01:30-23:59	configured	None	

At the bottom right of the screen are 'Apply' and 'Cancel' buttons.

The following table describes the fields in this screen.

Table 47 Parental Control > Parental Control

LABEL	DESCRIPTION
Parental Control	Select Enable to activate parental control.
Add new PCP	Click this if you want to configure a new parental control rule.
#	This shows the index number of the rule.
Status	This indicates whether the rule is active or not. A yellow bulb signifies that this rule is active. A gray bulb signifies that this rule is not active.
PCP Name	This shows the name of the rule.
Home Network User (MAC)	This shows the MAC address of the LAN user's computer to which this rule applies.
Internet Access Schedule	This shows the day(s) and time on which parental control is enabled.
Network Service	This shows whether the network service is configured. If not, None will be shown.
Website Block	This shows whether the website block is configured. If not, None will be shown.

Table 47 Parental Control > Parental Control (continued)

LABEL	DESCRIPTION
Modify	Click the Edit icon to go to the screen where you can edit the rule. Click the Delete icon to delete an existing rule.
Add	Click Add to create a new schedule.
Apply	Click Apply to save your changes back to the LTE Device.

14.2.1 Add/Edit a Parental Control Rule

Click **Add new PCP** in the **Parental Control** screen to add a new rule or click the **Edit** icon next to an existing rule to edit it. Use this screen to configure a restricted access schedule and/or URL filtering settings to block the users on your network from accessing certain web sites.

Figure 68 Add/Edit Parental Control Rule

The screenshot shows the 'Add new PCP' screen with the following sections:

- General:**
 - Active
 - Parental Control Profile Name: [Text Input]
 - Home Network User: [Dropdown Menu: All]
- Internet Access Schedule:**
 - Day: Everyday Monday Tuesday Wednesday Thursday Friday Saturday Sunday
 - Time (Start - End): 00:00 - 24:00
 - [Slider: 00:00 to 24:00]
 - No access Authorized access
- Network Service:**
 - Network Service Setting: [Block] selected service(s)
 - [Add new service]
 - Table with columns: #, [checkbox], Service Name, Protocol:Port, Modify
- Blocked Site/URL Keyword:**
 - [Add] [Delete]
 - [Text Input Area]

Buttons at the bottom: [Apply] [Back]

The following table describes the fields in this screen.

Table 48 Add/Edit Parental Control Rule

LABEL	DESCRIPTION
General	
Active	Select the checkbox to activate this parental control rule.
Parental Control Profile Name	Enter a descriptive name for the rule.

Table 48 Add/Edit Parental Control Rule (continued)

LABEL	DESCRIPTION
Home Network User	Select the LAN user that you want to apply this rule to from the drop-down list box. If you select Custom , enter the LAN user's MAC address. If you select All , the rule applies to all LAN users.
Internet Access Schedule	
Day	Select check boxes for the days that you want the LTE Device to perform parental control.
Start Blocking Time End Blocking Time	Enter the time period of each day, in 24-hour format, during which parental control will be enforced.
Time	Drag the time bar to define the time that the LAN user is allowed access.
Network Service	
Network Service Setting	If you select Block , the LTE Device prohibits the users from viewing the Web sites with the URLs listed below. If you select Access , the LTE Device blocks access to all URLs except ones listed below.
Add new service	Click this to show a screen in which you can add a new service rule. You can configure the Service Name , Protocol , and Name of the new rule.
#	This shows the index number of the rule. Select the checkbox next to the rule to activate it.
Service Name	This shows the name of the rule.
Protocol:Port	This shows the protocol and the port of the rule.
Modify	Click the Edit icon to go to the screen where you can edit the rule. Click the Delete icon to delete an existing rule.
Blocked Site/URL Keyword	Click Add to show a screen to enter the URL of web site or URL keyword to which the LTE Device blocks access. Click Delete to remove it.
Apply	Click this button to save your settings back to the LTE Device.
Back	Click this button to return to the previous screen without saving any changes.

15.1 Overview

Use this chapter to:

- Connect an analog phone to the LTE Device.
- Make phone calls over the Internet, as well as the regular phone network.
- Configure settings such as speed dial.
- Configure network settings to optimize the voice quality of your phone calls.

15.1.1 What You Can Do in this Chapter

These screens allow you to configure your LTE Device to make phone calls over the Internet and your regular phone line, and to set up the phones you connect to the LTE Device.

- Use the **SIP Service Provider** screen to configure the SIP server information, QoS for VoIP calls, the numbers for certain phone functions ([Section 15.2 on page 123](#)).
- Use the **SIP Account** screen to set up information about your SIP account, control which SIP accounts the phones connected to the LTE Device use and configure audio settings such as volume levels for the phones connected to the LTE Device ([Section 15.3 on page 129](#)).
- Use the **Phone Device** screen to control which SIP accounts the phones connected to the LTE Device use ([Section 15.5 on page 133](#)).
- Use the **Region** screen to change settings that depend on the country you are in ([Section 15.6 on page 134](#)).
- Use the **Call Rule** screen to set up shortcuts for dialing frequently-used (VoIP) phone numbers ([Section 15.7 on page 134](#)).

You don't necessarily need to use all these screens to set up your account. In fact, if your service provider did not supply information on a particular field in a screen, it is usually best to leave it at its default setting.

15.1.2 What You Need to Know

The following terms and concepts may help as you read this chapter.

VoIP

VoIP stands for Voice over IP. IP is the Internet Protocol, which is the message-carrying standard the Internet runs on. So, Voice over IP is the sending of voice signals (speech) over the Internet (or another network that uses the Internet Protocol).

SIP

SIP stands for Session Initiation Protocol. SIP is a signalling standard that lets one network device (like a computer or the LTE Device) send messages to another. In VoIP, these messages are about phone calls over the network. For example, when you dial a number on your LTE Device, it sends a SIP message over the network asking the other device (the number you dialed) to take part in the call.

SIP Accounts

A SIP account is a type of VoIP account. It is an arrangement with a service provider that lets you make phone calls over the Internet. When you set the LTE Device to use your SIP account to make calls, the LTE Device is able to send all the information about the phone call to your service provider on the Internet.

Strictly speaking, you don't need a SIP account. It is possible for one SIP device (like the LTE Device) to call another without involving a SIP service provider. However, the networking difficulties involved in doing this make it tremendously impractical under normal circumstances. Your SIP account provider removes these difficulties by taking care of the call routing and setup - figuring out how to get your call to the right place in a way that you and the other person can talk to one another.

Voice Activity Detection/Silence Suppression

Voice Activity Detection (VAD) detects whether or not speech is present. This lets the LTE Device reduce the bandwidth that a call uses by not transmitting "silent packets" when you are not speaking.

Comfort Noise Generation

When using VAD, the LTE Device generates comfort noise when the other party is not speaking. The comfort noise lets you know that the line is still connected as total silence could easily be mistaken for a lost connection.

Echo Cancellation

G.168 is an ITU-T standard for eliminating the echo caused by the sound of your voice reverberating in the telephone receiver while you talk.

Use this screen to maintain basic information about each SIP account. You can also enable and disable each SIP account, configure the volume, echo cancellation and VAD (Voice Activity Detection) settings for each individual phone port on the LTE Device.

How to Find Out More

See [Chapter 3 on page 33](#) for a tutorial showing how to set up these screens in an example scenario.

See [Section on page 135](#) for advanced technical information on SIP.

15.1.3 Before You Begin

- Before you can use these screens, you need to have a VoIP account already set up. If you don't have one yet, you can sign up with a VoIP service provider over the Internet.
- You should have the information your VoIP service provider gave you ready, before you start to configure the LTE Device.

15.2 The SIP Service Provider Screen

Use this screen to configure the SIP server information, QoS for VoIP calls, the numbers for certain phone functions and dialing plan. Click **VoIP > SIP** to open the **SIP Service Provider** screen.

Note: Click **more...** to see all the fields in the screen. You don't necessarily need to use all these fields to set up your account. Click **hide more** to see and configure only the fields needed for this feature.

Figure 69 VoIP > SIP > SIP Service Provider

SIP Service Provider Selection

Service Provider Selection : ChangeMe Delete

General

SIP Service Provider : Enable SIP Service Provider

SIP Service Provider Name :

SIP Local Port : (1025-65535)

Main SIP Server Address :

SIP Server Port : (1025-65535)

REGISTER Server Address :

REGISTER Server Port : (1025-65535)

SIP Service Domain :

[hide more](#)

Bound Interface Name

Bound Interface Name : AnyWAN

RFC Support

PRACK (RFC 3262) : Supported

DNS SRV Enabled (RFC 3263)

Session Timer (RFC 4028)

VoIP IOP Flags

Replace dial digit '#' to '%23' in SIP messages

Remove ':5060' and 'transport=udp' from request-uri in SIP messages

Remove the 'Route' header in SIP messages

Don't send re-Invite to the remote party when there are multiple codecs answered in the SDP

Remove the 'Authentication' header in SIP ACK message

RTP Port Range

Start Port : (1025-65535)

End Port : (1025-65535)

DTMF Mode	
DTMF Mode :	<input type="text" value="RFC 2833"/>
Transport Type	
Transport Type :	<input type="text" value="UDP"/>
FAX Option	
<input checked="" type="radio"/> G711 Fax Passthrough	<input type="radio"/> T38 Fax Relay
Outbound Proxy	
<input type="checkbox"/> Enable	
Server Address :	<input type="text"/>
Server Port :	<input type="text"/> (1025-65535)
QoS Tag	
SIP TOS Priority Setting :	<input type="text" value="0"/> (0-255)
RTP TOS Priority Setting :	<input type="text" value="0"/> (0-255)
Timer Setting	
Expiration Duration :	<input type="text" value="3600"/> (60-65535) second
Register Re-send timer :	<input type="text" value="512"/> (180-65535) second
Session Expires :	<input type="text" value="180"/> (100-3600) second
Min-SE :	<input type="text" value="90"/> (90-1800) second
Dialing Interval Selection	
Dialing Interval Selection :	<input type="text" value="3"/> second
Phone Key Config	
Call Return	<input type="text" value="*92#"/>
Caller Display Call	<input type="text" value="*30#"/>
Caller Hidden Call	<input type="text" value="#30#"/>
One Shot Caller Display Call	<input type="text" value="#31#"/>
One Shot Caller Hidden Call	<input type="text" value="*31#"/>
Call Waiting Enable	<input type="text" value="*43#"/>
Call Waiting Disable	<input type="text" value="#43#"/>
One Shot Call Waiting Enable	<input type="text" value="*44#"/>
One Shot Call Waiting Disable	<input type="text" value="#44#"/>
Internal Call	<input type="text" value="#####"/>
Call Transfer	<input type="text" value="*98#"/>
Unconditional Call Forward Enable	<input type="text" value="*21#"/>
Unconditional Call Forward Disable	<input type="text" value="#21#"/>
No Answer Call Forward Enable	<input type="text" value="*61#"/>
No Answer Call Forward Disable	<input type="text" value="#61#"/>
Call Forward When Busy Enable	<input type="text" value="*67#"/>
Call Forward When Busy Disable	<input type="text" value="#67#"/>
Do Not Disturb Enable	<input type="text" value="*95#"/>
Do Not Disturb Disable	<input type="text" value="#95#"/>
<input type="button" value="Apply"/> <input type="button" value="Cancel"/>	

The following table describes the labels in this screen.

Table 49 VoIP > SIP > SIP Service Provider

LABEL	DESCRIPTION
SIP Service Provider Selection	
Service Provider Selection	Select the SIP service provider profile you want to use for the SIP account you configure in this screen. If you change this field, the screen automatically refreshes.
General	
SIP Service Provider	Select this if you want the LTE Device to use this SIP provider. Clear it if you do not want the LTE Device to use this SIP provider.
SIP Service Provider Name	Enter the name of your SIP service provider.
SIP Local Port	Enter the LTE Device's listening port number, if your VoIP service provider gave you one. Otherwise, keep the default value.
Main SIP Server Address	Enter the IP address or domain name of the SIP server provided by your VoIP service provider. You can use up to 95 printable ASCII characters. It does not matter whether the SIP server is a proxy, redirect or register server.
SIP Server Port	Enter the SIP server's listening port number, if your VoIP service provider gave you one. Otherwise, keep the default value.
REGISTER Server Address	Enter the IP address or domain name of the SIP register server, if your VoIP service provider gave you one. Otherwise, enter the same address you entered in the SIP Server Address field. You can use up to 95 printable ASCII characters.
REGISTER Server Port	Enter the SIP register server's listening port number, if your VoIP service provider gave you one. Otherwise, enter the same port number you entered in the SIP Server Port field.
SIP Service Domain	Enter the SIP service domain name. In the full SIP URI, this is the part after the @ symbol. You can use up to 127 printable ASCII Extended set characters.
RFC Support	
PRACK (RFC 3262)	<p>RFC 3262 defines a mechanism to provide reliable transmission of SIP provisional response messages, which convey information on the processing progress of the request. This uses the option tag 100rel and the Provisional Response ACKnowledgement (PRACK) method.</p> <p>Select Supported or Required to have the LTE Device include a SIP Require/Supported header field with the option tag 100rel in all INVITE requests. When the LTE Device receives a SIP response message indicating that the phone it called is ringing, the LTE Device sends a PRACK message to have both sides confirm the message is received.</p> <p>If you select Supported, the peer device supports the option tag 100rel to send provisional responses reliably.</p> <p>If you select Required, the peer device requires the option tag 100rel to send provisional responses reliably.</p> <p>Select Disabled to turn off this function.</p>
DNS SRV Enabled (RFC 3263)	<p>Select this option to have the LTE Device use DNS procedures to resolve the SIP domain and find the SIP server's IP address, port number and supported transport protocol(s).</p> <p>The LTE Device first uses DNS Name Authority Pointer (NAPTR) records to determine the transport protocols supported by the SIP server. It then performs DNS Service (SRV) query to determine the port number for the protocol. The LTE Device resolves the SIP server's IP address by a standard DNS address record lookup.</p>
Session Timer (RFC 4028)	<p>Select this to have the LTE Device support RFC 4028.</p> <p>This makes sure that SIP sessions do not hang and the SIP line can always be available for use.</p>
RTP Port Range	

Table 49 VoIP > SIP > SIP Service Provider (continued)

LABEL	DESCRIPTION
Start Port End Port	<p>Enter the listening port number(s) for RTP traffic, if your VoIP service provider gave you this information. Otherwise, keep the default values.</p> <p>To enter one port number, enter the port number in the Start Port and End Port fields.</p> <p>To enter a range of ports,</p> <ul style="list-style-type: none"> • enter the port number at the beginning of the range in the Start Port field. • enter the port number at the end of the range in the End Port field.
DTMF Mode	<p>Control how the LTE Device handles the tones that your telephone makes when you push its buttons. You should use the same mode your VoIP service provider uses.</p> <p>RFC2833 - send the DTMF tones in RTP packets.</p> <p>PCM - send the DTMF tones in the voice data stream. This method works best when you are using a codec that does not use compression (like G.711). Codecs that use compression (like G.729 and G.726) can distort the tones.</p> <p>SIP INFO - send the DTMF tones in SIP messages.</p>
Transport Type	
Transport Type	Select the transport layer protocol UDP or TCP (usually UDP) used for SIP.
FAX Option	This field controls how the LTE Device handles fax messages.
G711 Fax Passthrough	Select this if the LTE Device should use G.711 to send fax messages. The peer devices must also use G.711.
T38 Fax Relay	Select this if the LTE Device should send fax messages as UDP or TCP/IP packets through IP networks. This provides better quality, but it may have inter-operability problems. The peer devices must also use T.38.
Outbound Proxy	
Enable	Select this if your VoIP service provider has a SIP outbound server to handle voice calls. This allows the LTE Device to work with any type of NAT router and eliminates the need for STUN or a SIP ALG. Turn off any SIP ALG on a NAT router in front of the LTE Device to keep it from re-translating the IP address (since this is already handled by the outbound proxy server).
Server Address	Enter the IP address or domain name of the SIP outbound proxy server.
Server Port	Enter the SIP outbound proxy server's listening port, if your VoIP service provider gave you one. Otherwise, keep the default value.
QoS Tag	
SIP TOS Priority Setting	Enter the DSCP (DiffServ Code Point) number for SIP message transmissions. The LTE Device creates Class of Service (CoS) priority tags with this number to SIP traffic that it transmits.
RTP TOS Priority Setting	Enter the DSCP (DiffServ Code Point) number for RTP voice transmissions. The LTE Device creates Class of Service (CoS) priority tags with this number to RTP traffic that it transmits.
Timer Setting	
Expiration Duration	Enter the number of seconds your SIP account is registered with the SIP register server before it is deleted. The LTE Device automatically tries to re-register your SIP account when one-half of this time has passed. (The SIP register server might have a different expiration.)
Register Re-send timer	Enter the number of seconds the LTE Device waits before it tries again to register the SIP account, if the first try failed or if there is no response.
Session Expires	Enter the number of seconds the LTE Device lets a SIP session remain idle (without traffic) before it automatically disconnects the session.

Table 49 VoIP > SIP > SIP Service Provider (continued)

LABEL	DESCRIPTION
Min-SE	Enter the minimum number of seconds the LTE Device lets a SIP session remain idle (without traffic) before it automatically disconnects the session. When two SIP devices start a SIP session, they must agree on an expiration time for idle sessions. This field is the shortest expiration time that the LTE Device accepts.
Dialing Interval Selection	
Dialing Interval Selection	Enter the number of seconds the LTE Device should wait after you stop dialing numbers before it makes the phone call. The value depends on how quickly you dial phone numbers.
Phone Key Config Use this section to customize the phone keypad combinations you use to access certain features on the LTE Device.	
Call Return	This code is used to turn the call return feature on. With call return, you can place a call to the last number that called you (either answered or missed).
Caller Display Call	This code is used to display the caller ID for outgoing calls.
Caller Hidden Call	This code is used to hide the caller ID for outgoing calls.
One Shot Caller Display Call	This code is used to display the caller ID only for the phone call your are going to make.
One Shot Caller Hidden Call	This code is used to hide the caller ID only for the phone call your are going to make.
Call Waiting Enable	This code is used to turn the Call Waiting feature on. With call waiting, you hear a special beep notifying another incoming call while you are answering a call. It allows you to place the first incoming call on hold and answer the second call so that you won't miss any important calls.
Call Waiting Disable	This code is used to turn the Call Waiting feature off.
One Shot Call Waiting Enable	This code is used to enable call waiting only for the phone call your are going to make. See the description for the Call Waiting Enable field for more information.
One Shot Call Waiting Disable	This code is used to disable one shot call waiting.
Internal Call	This code is used to enable internal calls that allows you to call from one phone to another phone connected to the LTE Device.
Call Transfer	This code is used to enable call transfer that allows you to transfer an incoming call (that you have answered) to another phone.
Unconditional Call Forward Enable	This code is used to enable unconditional call forwarding. Incoming calls are always forwarded to a specified number without any condition.
Unconditional Call Forward Disable	This code is used to disable unconditional call forwarding.
No Answer Call Forward Enable	This code is used to enable call forwarding when there is no answer at a SIP number.
No Answer Call Forward Disable	This code is used to disable call forwarding when there is no answer at a SIP number.
Call Forward When Busy Enable	This code is used to enable call forwarding when the phone is busy.
Call Forward When Busy Disable	This code is used to disable call forwarding when the phone is busy.
Do Not Disturb Enable	This code is used to turn the Do Not Disturb feature on. This has the LTE Device not forward calls to the phone line.

Table 49 VoIP > SIP > SIP Service Provider (continued)

LABEL	DESCRIPTION
Do Not Disturb Disable	This code is used to turn the Do Not Disturb feature off.
Apply	Click Apply to save your changes.
Cancel	Click Cancel to restore your previously saved settings.

15.3 The SIP Account Screen

The LTE Device uses a SIP account to make outgoing VoIP calls and check if an incoming call's destination number matches your SIP account's SIP number. In order to make or receive a VoIP call, you need to enable and configure a SIP account, and map it to a phone port. The SIP account contains information that allows your LTE Device to connect to your VoIP service provider.

See [Section 15.3 on page 129](#) for how to map a SIP account to a phone port.

To access the following screen, click **VoIP > SIP > SIP Account**.

Figure 70 VoIP > SIP > SIP Account

Add new SIP account					
#	Active	SIP Account	SIP Service Provider	Account No.	Modify
1		SIP 1	ChangeMe	ChangeMe	
2		SIP 2	ChangeMe	ChangeMe	

The following table describes the labels in this screen.

Table 50 VoIP > SIP > SIP Account

LABEL	DESCRIPTION
#	This is the index number of the entry.
Active	This shows whether the SIP account is activated or not. A yellow bulb signifies that this SIP account is activated. A gray bulb signifies that this SIP account is activated.
SIP Account	This shows the name of the SIP account.
SIP Service Provider	This shows the name of the SIP service provider.
Account No.	This shows the SIP number.
Modify	Click the Edit icon to configure the SIP account. Click the Delete icon to delete this SIP account from the LTE Device.

15.3.1 Add/Edit SIP Account

You can configure a new SIP account or edit one. To access this screen, click **Add new SIP Account** in the **SIP Account** screen or **Edit** icon next to an existing account.

Figure 71 SIP Account: Add/Edit

SIP Service Provider Selection

Service Provider Selection :

General

SIP Account : Active SIP Account

SIP Account Number :

Authenticaton

Username :

Password :

URL Type

URL Type :

Voice Features

Primary Compression Type :

Second Compression Type :

Third Compression Type :

Speaking Volume Control :

Listening Volume Control :

Active G.168(Echo Cancellation)

Active VAD(Voice Active Detector)

Note :
VAD will not be active while G.722 is used.

Call Features

Send Caller ID

Active Call Transfer

Active Call Waiting :

Active Call Waiting Reject Time : (10-60) second

Active Unconditional Forward To Number :

Active Busy Forward To Number :

Active No Answer Forward To Number :

No Answer Ring Time (10~180) Second

Hot Line / Warm Line Enable

Warm Line Hot Line

Hot Line / Warm Line number :

Warm Line Timer (sec) : (5~300)Second

Active Anonymous Call Block

Each field is described in the following table.

Table 51 SIP Account: Edit

LABEL	DESCRIPTION
SIP Service Provider Selection	
Service Provider Selection	Select the SIP service provider profile you want to use for the SIP account you configure in this screen. This field is view-only if you are editing the SIP account.
SIP Account Selection	
SIP Account Selection	This shows the SIP account you are configuring.
General	
SIP Account	Select the Active SIP Account check box if you want to use this account. Clear it if you do not want to use this account.
SIP Account Number	Enter your SIP number. In the full SIP URI, this is the part before the @ symbol. You can use up to 127 printable ASCII characters.
Authentication	
Username	Enter the user name for registering this SIP account, exactly as it was given to you. You can use up to 95 printable ASCII characters.
Password	Enter the password for registering this SIP account, exactly as it was given to you. You can use up to 95 printable ASCII characters.
URL Type	
URL Type	Select whether or not to include the SIP service domain name when the LTE Device sends the SIP number. SIP - include the SIP service domain name. TEL - do not include the SIP service domain name.
Voice Features	
Primary Compression Type	Select the type of voice coder/decoder (codec) that you want the LTE Device to use. G.711 provides higher voice quality but requires more bandwidth (64 kbps).
Secondary Compression Type	<ul style="list-style-type: none"> G.711MuLaw is typically used in North America and Japan. G.711ALaw is typically used in Europe. G.729 only requires 8 kbps. G.726-32 operates at 16, 24, 32 or 40 kbps. G.722 operates at 48, 56 and 64 kbps. The LTE Device must use the same codec as the peer. When two SIP devices start a SIP session, they must agree on a codec.
Third Compression Type	Select the LTE Device's first choice for voice coder/decoder. Select the LTE Device's second choice for voice coder/decoder. Select None if you only want the LTE Device to accept the first choice. Select the LTE Device's third choice for voice coder/decoder. Select None if you only want the LTE Device to accept the first or second choice.
Speaking Volume Control	Enter the loudness that the LTE Device uses for speech that it sends to the peer device. Minimum is the quietest, and Maximum is the loudest.
Listening Volume Control	Enter the loudness that the LTE Device uses for speech that it receives from the peer device. Minimum is the quietest, and Maximum is the loudest.
Active G.168 (Echo Cancellation)	Select this if you want to eliminate the echo caused by the sound of your voice reverberating in the telephone receiver while you talk.

Table 51 SIP Account: Edit (continued)

LABEL	DESCRIPTION
Active VAD (Voice Active Detector)	Select this if the LTE Device should stop transmitting when you are not speaking. This reduces the bandwidth the LTE Device uses.
Call Features	
Send Caller ID	Select this if you want to send identification when you make VoIP phone calls. Clear this if you do not want to send identification.
Active Call Transfer	Select this to enable call transfer on the LTE Device. This allows you to transfer an incoming call (that you have answered) to another phone.
Active Call Waiting	Select this to enable call waiting on the LTE Device. This allows you to place a call on hold while you answer another incoming call on the same telephone (directory) number.
Active Call Waiting Reject Time	Specify a time of seconds that the LTE Device waits before rejecting the second call if you do not answer it.
Active Unconditional Forward	Select this if you want the LTE Device to forward all incoming calls to the specified phone number. Specify the phone number in the To Number field on the right.
Active Busy Forward	Select this if you want the LTE Device to forward incoming calls to the specified phone number if the phone port is busy. Specify the phone number in the To Number field on the right. If you have call waiting, the incoming call is forwarded to the specified phone number if you reject or ignore the second incoming call.
Active No Answer Forward	Select this if you want the LTE Device to forward incoming calls to the specified phone number if the call is unanswered. (See No Answer Time .) Specify the phone number in the To Number field on the right.
No Answer Ring Time	This field is used by the Active No Answer Forward feature. Enter the number of seconds the LTE Device should wait for you to answer an incoming call before it considers the call is unanswered.
Hot Line/Warm Line Enable	Enable Warm Line or Hot Line feature on the LTE Device. A hot line or warm line number is a phone number.
Hot Line/Warm Line number	Enter the number to be dialed once the phone is off the hook immediately (Hot Line) or after the time the phone remains off the hook has surpassed the delay period (Warm Line).
Warm Line Timer (sec)	Enter the duration the phone can remain off the hook before automatically dialing the warm line number. You can set the delay from 1 to 15 seconds.
Active Anonymous Call Block	Select this if you do not want the phone to ring when someone tries to call you with caller ID deactivated.
Apply	Click Apply to save your changes.
Back	Click Back to return to the previous screen without saving.

15.4 Multiple SIP Accounts

You can set up two SIP accounts on your LTE Device and your LTE Device is equipped with two phone ports. By default, SIP1 of the LTE Device maps to phone port 1 for incoming and outgoing, and SIP2 maps to phone port 2 for incoming and outgoing.

15.5 Phone Screen

Use this screen to control which SIP accounts the phone uses. Click **VoIP > Phone** to access the **Phone Device** screen.

Figure 72 VoIP > Phone > Phone Device

Analog Phone			
#	Phone ID	Outgoing SIP Number	Modify
1	Analog Phone 1	ChangeMe	

The following table describes the labels in this screen.

Table 52 VoIP > Phone > Phone Device

LABEL	DESCRIPTION
#	This is the index number of the entry.
Phone ID	This is the phone device number.
Outgoing SIP Number	This is the outgoing SIP number of the phone device.
Modify	Click the Edit icon to configure the SIP account.

15.5.1 Edit Phone Device

You can decide which SIP accounts the phone connected to the LTE Device use by clicking the **Edit** icon next to a Phone ID. The following screen displays.

You cannot edit the account if it is not activated. Go to **VoIP > SIP > SIP Account > Edit** to activate a SIP account (see [Section 15.3 on page 129](#) for more information).

Figure 73 Phone Device: Edit

SIP Account to Make Outgoing Call			
SIP Account	SIP Number	SIP Account	SIP Number
<input checked="" type="radio"/> SIP 1	ChangeMe	<input type="radio"/> SIP 2	ChangeMe

SIP Account(s) to Receive Incoming Call			
SIP Account	SIP Number	SIP Account	SIP Number
<input checked="" type="checkbox"/> SIP 1	ChangeMe	<input type="checkbox"/> SIP 2	ChangeMe

The following table describes the labels in this screen.

Table 53 Phone Device: Edit

LABEL	DESCRIPTION
SIP Account to Make Outgoing Call	
SIP Account	Select the SIP account you want to use when making outgoing calls with the analog phone connected to this phone port.
SIP Number	This shows the SIP account number.
SIP Account(s) to Receive Incoming Call	

Table 53 Phone Device: Edit (continued)

LABEL	DESCRIPTION
SIP Account	Select a SIP account if you want to receive phone calls for the selected SIP account on this phone port. If you select more than one SIP account for incoming calls, there is no way to distinguish between them when you receive phone calls. If you do not select a source for incoming calls, you cannot receive any calls on this phone port.
SIP Number	This shows the SIP account number.
Apply	Click Apply to save your changes.
Back	Click Back to return to the previous screen without saving.

15.6 The Phone Region Screen

Use this screen to maintain settings that depend on which region of the world the LTE Device is in. To access this screen, click **VoIP > Phone > Region**.

Figure 74 VoIP > Phone > Region

Region Settings :

Call Service Mode :

Note :
Caution: When Region Settings is changed, you need to reboot device to take settings effect.

Each field is described in the following table.

Table 54 VoIP > Phone > Region

LABEL	DESCRIPTION
Region Settings	Select the place in which the LTE Device is located.
Call Service Mode	Select the mode for supplementary phone services (call hold, call waiting, call transfer and three-way conference calls) that your VoIP service provider supports. <ul style="list-style-type: none"> • Europe Type - use supplementary phone services in European mode. • USA Type - use supplementary phone services American mode. You might have to subscribe to these services to use them. Contact your VoIP service provider.
Apply	Click this to save your changes and to apply them to the LTE Device.
Cancel	Click this to set every field in this screen to its last-saved value.

15.7 The Call Rule Screen

Use this screen to add, edit, or remove speed-dial numbers for outgoing calls. Speed dial provides shortcuts for dialing frequently-used (VoIP) phone numbers. You also have to create speed-dial entries if you want to call SIP numbers that contain letters. Once you have configured a speed dial

rule, you can use a shortcut (the speed dial number, #01 for example) on your phone's keypad to call the phone number.

To access this screen, click **VoIP > Call Rule**.

Figure 75 VoIP > Call Rule

The screenshot shows the 'VoIP > Call Rule' configuration interface. It features two primary sections: 'Speed Dial' and 'Phone Book'.
 The 'Speed Dial' section contains a table with the following columns: '#', 'Number', 'Description', and 'SIPNumber'. Below this table is an 'Add' button.
 The 'Phone Book' section contains a table with the following columns: '#', 'Number', 'Description', and 'Modify'. Below this table are 'Clear' and 'Cancel' buttons.

Each field is described in the following table.

Table 55 VoIP > Call Rule

LABEL	DESCRIPTION
Speed Dial	Use this section to create or edit speed-dial entries.
#	Select the speed-dial number you want to use for this phone number.
Number	Enter the SIP number you want the LTE Device to call when you dial the speed-dial number.
Description	Enter a short description to identify the party you call when you dial the speed-dial number. You can use up to 127 printable ASCII characters.
Add	Click this to use the information in the Speed Dial section to update the Speed Dial Phone Book section.
Phone Book	Use this section to look at all the speed-dial entries and to erase them.
#	This field displays the speed-dial number you should dial to use this entry.
Number	This field displays the SIP number the LTE Device calls when you dial the speed-dial number.
Description	This field displays a short description of the party you call when you dial the speed-dial number.
Modify	Use this field to edit or erase the speed-dial entry. Click the Edit icon to copy the information for this speed-dial entry into the Speed Dial section, where you can change it. Click Add when you finish editing to change the configurations. Click the Delete icon to erase this speed-dial entry.
Clear	Click this to erase all the speed-dial entries.
Cancel	Click this to set every field in this screen to its last-saved value.

15.8 Technical Reference

This section contains background material relevant to the **VoIP** screens.

15.8.1 VoIP

VoIP is the sending of voice signals over Internet Protocol. This allows you to make phone calls and send faxes over the Internet at a fraction of the cost of using the traditional circuit-switched telephone network. You can also use servers to run telephone service applications like PBX services and voice mail. Internet Telephony Service Provider (ITSP) companies provide VoIP service.

Circuit-switched telephone networks require 64 kilobits per second (Kbps) in each direction to handle a telephone call. VoIP can use advanced voice coding techniques with compression to reduce the required bandwidth.

15.8.2 SIP

The Session Initiation Protocol (SIP) is an application-layer control (signaling) protocol that handles the setting up, altering and tearing down of voice and multimedia sessions over the Internet.

SIP signaling is separate from the media for which it handles sessions. The media that is exchanged during the session can use a different path from that of the signaling. SIP handles telephone calls and can interface with traditional circuit-switched telephone networks.

SIP Identities

A SIP account uses an identity (sometimes referred to as a SIP address). A complete SIP identity is called a SIP URI (Uniform Resource Identifier). A SIP account's URI identifies the SIP account in a way similar to the way an e-mail address identifies an e-mail account. The format of a SIP identity is SIP-Number@SIP-Service-Domain.

SIP Number

The SIP number is the part of the SIP URI that comes before the “@” symbol. A SIP number can use letters like in an e-mail address (johndoe@your-ITSP.com for example) or numbers like a telephone number (1122334455@VoIP-provider.com for example).

SIP Service Domain

The SIP service domain of the VoIP service provider is the domain name in a SIP URI. For example, if the SIP address is 1122334455@VoIP-provider.com, then “VoIP-provider.com” is the SIP service domain.

SIP Registration

Each LTE Device is an individual SIP User Agent (UA). To provide voice service, it has a public IP address for SIP and RTP protocols to communicate with other servers.

A SIP user agent has to register with the SIP registrar and must provide information about the users it represents, as well as its current IP address (for the routing of incoming SIP requests).

After successful registration, the SIP server knows that the users (identified by their dedicated SIP URIs) are represented by the UA, and knows the IP address to which the SIP requests and responses should be sent.

Registration is initiated by the User Agent Client (UAC) running in the VoIP gateway (the LTE Device). The gateway must be configured with information letting it know where to send the REGISTER message, as well as the relevant user and authorization data.

A SIP registration has a limited lifespan. The User Agent Client must renew its registration within this lifespan. If it does not do so, the registration data will be deleted from the SIP registrar's database and the connection broken.

The LTE Device attempts to register all enabled subscriber ports when it is switched on. When you enable a subscriber port that was previously disabled, the LTE Device attempts to register the port immediately.

Authorization Requirements

SIP registrations (and subsequent SIP requests) require a username and password for authorization. These credentials are validated via a challenge / response system using the HTTP digest mechanism (as detailed in RFC3261, "SIP: Session Initiation Protocol").

SIP Servers

SIP is a client-server protocol. A SIP client is an application program or device that sends SIP requests. A SIP server responds to the SIP requests.

When you use SIP to make a VoIP call, it originates at a client and terminates at a server. A SIP client could be a computer or a SIP phone. One device can act as both a SIP client and a SIP server.

SIP User Agent

A SIP user agent can make and receive VoIP telephone calls. This means that SIP can be used for peer-to-peer communications even though it is a client-server protocol. In the following figure, either **A** or **B** can act as a SIP user agent client to initiate a call. **A** and **B** can also both act as a SIP user agent to receive the call.

Figure 76 SIP User Agent

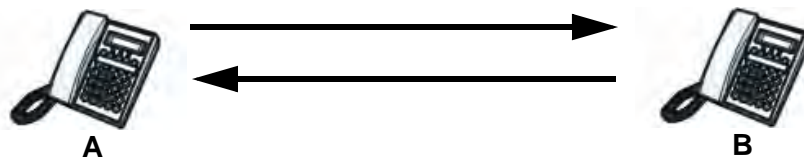

SIP Proxy Server

A SIP proxy server receives requests from clients and forwards them to another server.

In the following example, you want to use client device **A** to call someone who is using client device **C**.

- 1 The client device (**A** in the figure) sends a call invitation to the SIP proxy server **B**.

- 2 The SIP proxy server forwards the call invitation to **C**.

Figure 77 SIP Proxy Server

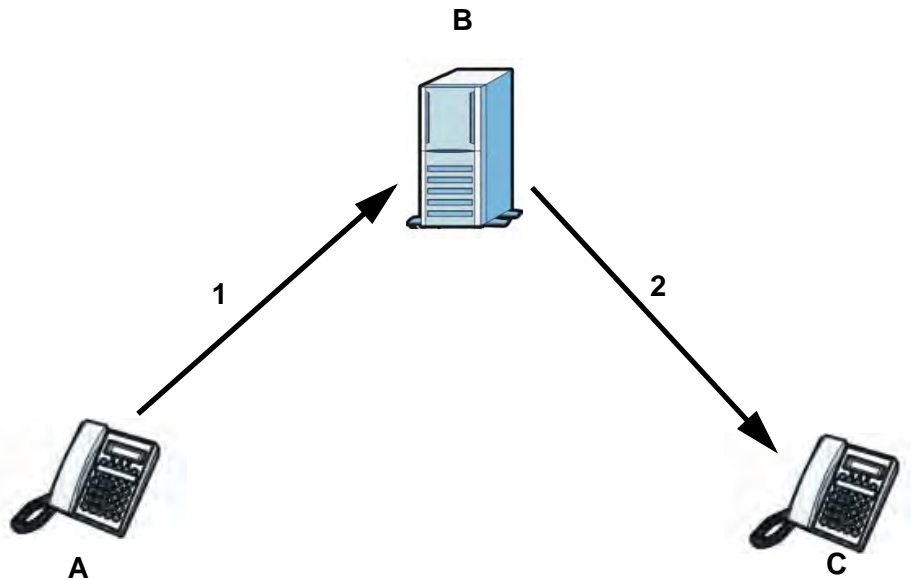

SIP Redirect Server

A SIP redirect server accepts SIP requests, translates the destination address to an IP address and sends the translated IP address back to the device that sent the request. Then the client device that originally sent the request can send requests to the IP address that it received back from the redirect server. Redirect servers do not initiate SIP requests.

In the following example, you want to use client device **A** to call someone who is using client device **C**.

- 1 Client device **A** sends a call invitation for **C** to the SIP redirect server **B**.
- 2 The SIP redirect server sends the invitation back to **A** with **C**'s IP address (or domain name).

- 3 Client device **A** then sends the call invitation to client device **C**.

Figure 78 SIP Redirect Server

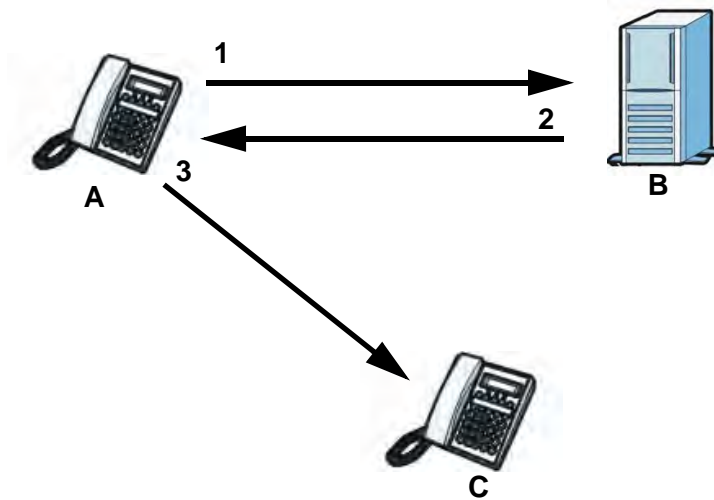

SIP Register Server

A SIP register server maintains a database of SIP identity-to-IP address (or domain name) mapping. The register server checks your user name and password when you register.

RTP

When you make a VoIP call using SIP, the RTP (Real time Transport Protocol) is used to handle voice data transfer. See RFC 3550 for details on RTP.

Pulse Code Modulation

Pulse Code Modulation (PCM) measures analog signal amplitudes at regular time intervals and converts them into bits.

SIP Call Progression

The following figure displays the basic steps in the setup and tear down of a SIP call. A calls B.

Table 56 SIP Call Progression

A		B
1. INVITE	→	
	←	2. Ringing
	←	3. OK
4. ACK	→	
	5. Dialogue (voice traffic)	
6. BYE	→	
	←	7. OK

- 1 **A** sends a SIP INVITE request to **B**. This message is an invitation for **B** to participate in a SIP telephone call.
- 2 **B** sends a response indicating that the telephone is ringing.
- 3 **B** sends an OK response after the call is answered.
- 4 **A** then sends an ACK message to acknowledge that **B** has answered the call.
- 5 Now **A** and **B** exchange voice media (talk).
- 6 After talking, **A** hangs up and sends a BYE request.
- 7 **B** replies with an OK response confirming receipt of the BYE request and the call is terminated.

Voice Coding

A codec (coder/decoder) codes analog voice signals into digital signals and decodes the digital signals back into analog voice signals. The LTE Device supports the following codecs.

- G.711 is a Pulse Code Modulation (PCM) waveform codec. PCM measures analog signal amplitudes at regular time intervals and converts them into digital samples. G.711 provides very good sound quality but requires 64 kbps of bandwidth.
- G.726 is an Adaptive Differential PCM (ADPCM) waveform codec that uses a lower bitrate than standard PCM conversion. ADPCM converts analog audio into digital signals based on the difference between each audio sample and a prediction based on previous samples. The more similar the audio sample is to the prediction, the less space needed to describe it. G.726 operates at 16, 24, 32 or 40 kbps.
- G.729 is an Analysis-by-Synthesis (AbS) hybrid waveform codec that uses a filter based on information about how the human vocal tract produces sounds. G.729 provides good sound quality and reduces the required bandwidth to 8 kbps.

MWI (Message Waiting Indication)

Enable Message Waiting Indication (MWI) enables your phone to give you a message–waiting (beeping) dial tone when you have a voice message(s). Your VoIP service provider must have a messaging system that sends message waiting status SIP packets as defined in RFC 3842.

15.8.3 Quality of Service (QoS)

Quality of Service (QoS) refers to both a network's ability to deliver data with minimum delay, and the networking methods used to provide bandwidth for real-time multimedia applications.

Type of Service (ToS)

Network traffic can be classified by setting the ToS (Type of Service) values at the data source (for example, at the LTE Device) so a server can decide the best method of delivery, that is the least cost, fastest route and so on.

DiffServ

DiffServ is a class of service (CoS) model that marks packets so that they receive specific per-hop treatment at DiffServ-compliant network devices along the route based on the application types and traffic flow. Packets are marked with DiffServ Code Points (DSCP) indicating the level of service desired. This allows the intermediary DiffServ-compliant network devices to handle the packets differently depending on the code points without the need to negotiate paths or remember state information for every flow. In addition, applications do not have to request a particular service or give advanced notice of where the traffic is going.³

DSCP and Per-Hop Behavior

DiffServ defines a new DS (Differentiated Services) field to replace the Type of Service (TOS) field in the IP header. The DS field contains a 2-bit unused field and a 6-bit DSCP field which can define up to 64 service levels. The following figure illustrates the DS field.

DSCP is backward compatible with the three precedence bits in the ToS octet so that non-DiffServ compliant, ToS-enabled network device will not conflict with the DSCP mapping.

Figure 79 DiffServ: Differentiated Service Field

DSCP (6-bit)	Unused (2-bit)
-----------------	-------------------

The DSCP value determines the forwarding behavior, the PHB (Per-Hop Behavior), that each packet gets across the DiffServ network. Based on the marking rule, different kinds of traffic can be marked for different priorities of forwarding. Resources can then be allocated according to the DSCP values and the configured policies.

15.8.4 Phone Services Overview

Supplementary services such as call hold, call waiting, and call transfer, are generally available from your VoIP service provider. The LTE Device supports the following services:

- Call Hold
- Call Waiting
- Making a Second Call
- Call Transfer
- Three-Way Conference
- Internal Calls
- Do not Disturb

Note: To take full advantage of the supplementary phone services available through the LTE Device's phone ports, you may need to subscribe to the services from your VoIP service provider.

3. The LTE Device does not support DiffServ at the time of writing.

The Flash Key

Flashing means to press the hook for a short period of time (a few hundred milliseconds) before releasing it. On newer telephones, there should be a "flash" key (button) that generates the signal electronically. If the flash key is not available, you can tap (press and immediately release) the hook by hand to achieve the same effect. However, using the flash key is preferred since the timing is much more precise. With manual tapping, if the duration is too long, it may be interpreted as hanging up by the LTE Device.

You can invoke all the supplementary services by using the flash key.

Europe Type Supplementary Phone Services

This section describes how to use supplementary phone services with the **Europe Type Call Service Mode**. Commands for supplementary services are listed in the table below.

After pressing the flash key, if you do not issue the sub-command before the default sub-command time-out (2 seconds) expires or issue an invalid sub-command, the current operation will be aborted.

Table 57 European Flash Key Commands

COMMAND	SUB-COMMAND	DESCRIPTION
Flash		Put a current call on hold to place a second call. Switch back to the call (if there is no second call).
Flash	0	Drop the call presently on hold or reject an incoming call which is waiting for answer.
Flash	1	Disconnect the current phone connection and answer the incoming call or resume with caller presently on hold.
Flash	2	1. Switch back and forth between two calls. 2. Put a current call on hold to answer an incoming call. 3. Separate the current three-way conference call into two individual calls (one is on-line, the other is on hold).
Flash	3	Create three-way conference connection.
Flash	*98#	Transfer the call to another phone.

European Call Hold

Call hold allows you to put a call (**A**) on hold by pressing the flash key.

If you have another call, press the flash key and then "2" to switch back and forth between caller **A** and **B** by putting either one on hold.

Press the flash key and then "0" to disconnect the call presently on hold and keep the current call on line.

Press the flash key and then "1" to disconnect the current call and resume the call on hold.

If you hang up the phone but a caller is still on hold, there will be a remind ring.

European Call Waiting

This allows you to place a call on hold while you answer another incoming call on the same telephone (directory) number.

If there is a second call to a telephone number, you will hear a call waiting tone. Take one of the following actions.

- Reject the second call.
Press the flash key and then press "0".
- Disconnect the first call and answer the second call.
Either press the flash key and press "1", or just hang up the phone and then answer the phone after it rings.
- Put the first call on hold and answer the second call.
Press the flash key and then "2".

European Call Transfer

Do the following to transfer a call (that you have answered) to another phone number.

- 1 Press the flash key to put the caller on hold.
- 2 When you hear the dial tone, dial "**98#" followed by the number to which you want to transfer the call. to operate the Intercom.
- 3 After you hear the ring signal or the second party answers it, hang up the phone.

European Three-Way Conference

Use the following steps to make three-way conference calls.

- 1 When you are on the phone talking to someone, press the flash key to put the call on hold and get a dial tone.
- 2 Dial a phone number directly to make another call.
- 3 When the second call is answered, press the flash key and press "3" to create a three-way conversation.
- 4 Hang up the phone to drop the connection.
- 5 If you want to separate the activated three-way conference into two individual connections (one is on-line, the other is on hold), press the flash key and press "2".

16.1 Overview

The web configurator allows you to choose which categories of events and/or alerts to have the LTE Device log and then display the logs or have the LTE Device send them to an administrator (as e-mail) or to a syslog server.

16.1.1 What You Can Do in this Chapter

- Use the **System Log** screen to see the system logs for the categories that you select ([Section 16.2 on page 146](#)).
- Use the **Phone Log** screen to view phone logs and alert messages ([Section 16.3 on page 147](#)).
- Use The **VoIP Call History** screen to view the details of the calls performed on the LTE Device ([Section 16.4 on page 147](#)).

16.1.2 What You Need To Know

The following terms and concepts may help as you read this chapter.

Alerts and Logs

An alert is a type of log that warrants more serious attention. They include system errors, attacks (access control) and attempted access to blocked web sites. Some categories such as **System Errors** consist of both logs and alerts. You may differentiate them by their color in the **View Log** screen. Alerts display in red and logs display in black.

Syslog Overview

The syslog protocol allows devices to send event notification messages across an IP network to syslog servers that collect the event messages. A syslog-enabled device can generate a syslog message and send it to a syslog server.

Syslog is defined in RFC 3164. The RFC defines the packet format, content and system log related information of syslog messages. Each syslog message has a facility and severity level. The syslog facility identifies a file in the syslog server. Refer to the documentation of your syslog program for details. The following table describes the syslog severity levels.

Table 58 Syslog Severity Levels

CODE	SEVERITY
0	Emergency (EMERG): The system is unusable.
1	Alert (ALERT): Action must be taken immediately.
2	Critical (CRIT): The system condition is critical.

Table 58 Syslog Severity Levels

CODE	SEVERITY
3	Error (ERROR): There is an error condition on the system.
4	Warning (WARNING): There is a warning condition on the system.
5	Notice (NOTICE): There is a normal but significant condition on the system.
6	Informational (INFO): The syslog contains an informational message.
7	Debug (DEBUG): The message is intended for debug-level purposes.

16.2 The System Log Screen

Click **System Monitor > Log** to open the **System Log** screen. Use the **System Log** screen to see the system logs for the categories that you select in the upper left drop-down list box.

Figure 80 System Monitor > Log > System Log

The screenshot shows the System Log interface. At the top, there is a search filter area with a dropdown menu set to 'All Logs', a 'Level:' dropdown set to 'ALL', and two buttons: 'Refresh' and 'Clear Logs'. Below this is a table with the following columns: '#', 'Time', 'Level', and 'Message'. The table contains one entry:

#	Time	Level	Message
1	Jan 1 01:01:22	info	WAN Physical Link Down

The following table describes the fields in this screen.

Table 59 System Monitor > Log > System Log

LABEL	DESCRIPTION
	Select the type of the logs that you want to search in the first drop-down list box.
Level	Select a severity level from this drop-down list box. This filters search results according to the severity level you have selected. When you select a severity, the LTE Device searches through all logs of that severity or higher. See Table 58 on page 145 for more information about severity levels.
Refresh	Click this to renew the log screen.
Clear Logs	Click this to delete all the logs.
#	This field is a sequential value and is not associated with a specific entry.
Time	This field displays the date and time the log was recorded.
Level	This field displays the severity level of the logs that the device is to send to this syslog server.
Message	This field states the reason for the log.

16.3 The Phone Log Screen

Click **System Monitor > Log** to open the **Phone Log** screen. Use this screen to view phone logs and alert messages. You can select the type of log and level of severity to display.

Figure 81 System Monitor > Log > Phone Log

#	Time	Level	Message
1	Aug 20 07:37:17	err	SIP Registration: SIP:12875: Register Fail, error_cause 43
2	Aug 20 07:37:40	info	[ChangeMe] [FXS2] Phone Event: OFFHOOK
3	Aug 20 07:37:43	info	[ChangeMe] [FXS2] Phone Event: ONHOOK
4	Aug 20 07:37:43	info	[ChangeMe] [FXS2] Phone Event: idle
5	Aug 20 07:39:05	info	[ChangeMe] [FXS2] Phone Event: OFFHOOK
6	Aug 20 07:39:28	info	[ChangeMe] [FXS2] Phone Event: ONHOOK
7	Aug 20 07:39:28	info	[ChangeMe] [FXS2] Phone Event: idle
8	Aug 20 07:41:14	info	SIP Registration: SIP:128752: Register Success
9	Aug 20 07:41:49	info	[ChangeMe] [FXS2] Phone Event: OFFHOOK
10	Aug 20 07:41:56	info	[ChangeMe] [FXS2] Phone Event: ONHOOK

The following table describes the fields in this screen.

Table 60 System Monitor > Log > Phone Log

LABEL	DESCRIPTION
	Select a category of logs to view from the drop-down list box. select All Logs to view all logs.
Level	Select the severity level that you want to view.
Refresh	Click this to renew the log screen.
Clear Logs	Click this to delete all the logs.
#	This field is a sequential value and is not associated with a specific entry.
Time	This field displays the time the log was recorded.
Level	This field displays the severity level of the logs that the device is to send to this syslog server.
Message	This field states the reason for the log.

16.4 The VoIP Call History Screen

Click **System Monitor > Log > VoIP Call History** to open the **VoIP Call History** screen. Use this screen to see the details of the calls performed on the LTE Device.

Figure 82 System Monitor > Log > VoIP Call History

#	Time	Local Number	Peer Number	Interface	Duration
1	08/20/2010 09:43:52	128752	1353699	SIP	0:00:00
2	08/20/2010 09:43:07	128752	1353699	SIP	0:00:06
3	08/20/2010 09:42:11	128752	1353699	SIP	0:00:37

The following table describes the fields in this screen.

Table 61 System Monitor > Log > VoIP Call History

LABEL	DESCRIPTION
	Select a category of call records to view from the drop-down list box. select All Call History to view all call records.
Refresh	Click this to renew the log screen.
Clear Logs	Click this to delete all the logs.
#	This field is a sequential value and is not associated with a specific entry.
Time	This field displays the time the call was recorded.
Local Number	This field displays the phone number you used to make or receive this call.
Peer Number	This field displays the phone number you called or from which this call is made.
Interface	This field displays the type of the call.
Duration	This field displays how long the call lasted.

Traffic Status

17.1 Overview

Use the **Traffic Status** screens to look at network traffic status and statistics of the WAN, LAN interfaces and NAT.

17.1.1 What You Can Do in this Chapter

- Use the **WAN** screen to view the WAN traffic statistics ([Section 17.2 on page 149](#)).
- Use the **LAN** screen to view the LAN traffic statistics ([Section 17.3 on page 150](#)).
- Use the **NAT** screen to view the NAT status of the LTE Device's client(s) ([Section 17.4 on page 151](#)).
- Use the **VoIP Status** screen to view the VoIP traffic statistics ([Section 17.5 on page 152](#)).

17.2 The WAN Status Screen

Click **System Monitor > Traffic Status** to open the **WAN** screen. You can view the WAN traffic statistics in this screen.

Figure 83 System Monitor > Traffic Status > WAN

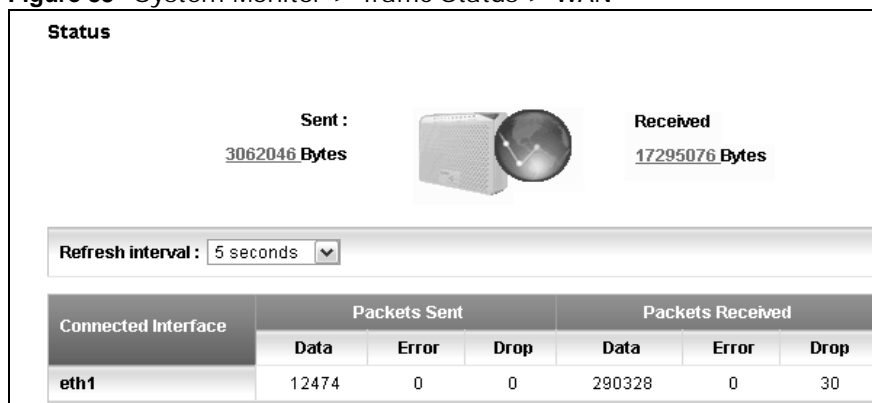

The following table describes the fields in this screen.

Table 62 System Monitor > Traffic Status > WAN

LABEL	DESCRIPTION
Status	This shows the number of bytes received and sent through the WAN interface of the LTE Device.
Refresh Interval	Select how often you want the LTE Device to update this screen from the drop-down list box.

Table 62 System Monitor > Traffic Status > WAN (continued)

LABEL	DESCRIPTION
Connected Interface	This shows the name of the WAN interface that is currently connected.
Packets Sent	
Data	This indicates the number of transmitted packets on this interface.
Error	This indicates the number of frames with errors transmitted on this interface.
Drop	This indicates the number of outgoing packets dropped on this interface.
Packets Received	
Data	This indicates the number of received packets on this interface.
Error	This indicates the number of frames with errors received on this interface.
Drop	This indicates the number of received packets dropped on this interface.

17.3 The LAN Status Screen

Click **System Monitor > Traffic Status > LAN** to open the following screen. You can view the LAN traffic statistics in this screen.

Figure 84 System Monitor > Traffic Status > LAN

Refresh interval: 5 seconds				
Interface		LAN1	LAN2	Wireless
Bytes Sent		0	1236940	0
Bytes Received		0	701803	0
Interface		LAN1	LAN2	Wireless
Sent (Packet)	Data	0	3222	0
	Error	0	0	0
	Drop	0	0	0
Received (Packet)	Data	0	8838	0
	Error	0	0	0
	Drop	0	0	0

The following table describes the fields in this screen.

Table 63 System Monitor > Traffic Status > LAN

LABEL	DESCRIPTION
Refresh Interval	Select how often you want the LTE Device to update this screen from the drop-down list box.
Interface	This shows the LAN or WLAN interface.
Bytes Sent	This indicates the number of bytes transmitted on this interface.
Bytes Received	This indicates the number of bytes received on this interface.
Interface	This shows the LAN or WLAN interface.
Sent (Packet)	
Data	This indicates the number of transmitted packets on this interface.
Error	This indicates the number of frames with errors transmitted on this interface.

Table 63 System Monitor > Traffic Status > LAN (continued)

LABEL	DESCRIPTION
Drop	This indicates the number of outgoing packets dropped on this interface.
Received (Packet)	
Data	This indicates the number of received packets on this interface.
Error	This indicates the number of frames with errors received on this interface.
Drop	This indicates the number of received packets dropped on this interface.

17.4 The NAT Status Screen

Click **System Monitor > Traffic Status > NAT** to open the following screen. You can view the NAT status of the LTE Device's client(s) in this screen.

Figure 85 System Monitor > Traffic Status > NAT

Refresh interval :	5 seconds ▾		
Device Name	IP Address	MAC Address	No. of Open Session
pc02	192.168.1.58	00:24:21:7e:20:96	142
			Total : 142

The following table describes the fields in this screen.

Table 64 System Monitor > Traffic Status > NAT

LABEL	DESCRIPTION
Refresh Interval	Select how often you want the LTE Device to update this screen from the drop-down list box.
Device Name	This shows the name of the client.
IP Address	This shows the IP address of the client.
MAC Address	This shows the MAC address of the client.
No. of Open Session	This shows the number of NAT sessions used by the client.

17.5 The VoIP Status Screen

Click **System Monitor > VoIP Status** to open the following screen. You can view the VoIP traffic statistics in this screen.

Figure 86 System Monitor > VoIP Status

Refresh interval : 5 seconds ▾						
SIP Status						
Account	Registration	Last Registration	URI	Message Waiting	Last Incoming Number	Last Outgoing Number
Call Status						
Account	Duration	Status	Codec	Peer Number		
Phone Status						
Account	Outgoing Number	Incoming Number	Phone State			
Phone 1	ChangeMe	N/A				

The following table describes the fields in this screen.

Table 65 System Monitor > VoIP Status

LABEL	DESCRIPTION
Refresh Interval	Select how often you want the LTE Device to update this screen from the drop-down list box.
SIP Status	
Account	This column displays each SIP account in the LTE Device.
Registration	This field displays the current registration status of the SIP account. You can change this in the Status screen. Registered - The SIP account is registered with a SIP server. Not Registered - The last time the LTE Device tried to register the SIP account with the SIP server, the attempt failed. The LTE Device automatically tries to register the SIP account when you turn on the LTE Device or when you activate it. Inactive - The SIP account is not active. You can activate it in VoIP > SIP > SIP Account .
Last Registration	This field displays the last time you successfully registered the SIP account. The field is blank if you never successfully registered this account.
URI	This field displays the account number and service domain of the SIP account. You can change these in the VoIP > SIP screens.
Message Waiting	This field indicates whether or not there are any messages waiting for the SIP account.
Last Incoming Number	This field displays the last number that called the SIP account. The field is blank if no number has ever dialed the SIP account.
Last Outgoing Number	This field displays the last number the SIP account called. The field is blank if the SIP account has never dialed a number.
Call Status	
Account	This column displays the SIP account in the LTE Device.
Duration	This field displays how long the current call has lasted.

Table 65 System Monitor > VoIP Status (continued)

LABEL	DESCRIPTION
Status	<p>This field displays the current state of the phone call.</p> <p>Idle - There are no current VoIP calls, incoming calls or outgoing calls being made.</p> <p>Dial - The callee's phone is ringing.</p> <p>Ring - The phone is ringing for an incoming VoIP call.</p> <p>Process - There is a VoIP call in progress.</p> <p>DISC - The callee's line is busy, the callee hung up or your phone was left off the hook.</p>
Codec	This field displays what voice codec is being used for a current VoIP call through a phone port.
Peer Number	This field displays the SIP number of the party that is currently engaged in a VoIP call through a phone port.
Phone Status	
Account	This field displays the phone accounts of the LTE Device.
Outgoing Number	This field displays the SIP number that you use to make calls on this phone port.
Incoming Number	This field displays the SIP number that you use to receive calls on this phone port.
Phone State	This field shows whether or the phone connected to the subscriber port is on-hook (ONHOOK) or off-hook (OFFHOOK).

User Account

18.1 Overview

You can configure system password for different user accounts in the **User Account** screen.

18.2 The User Account Screen

Use the **User Account** screen to configure system password.

Click **Maintenance > User Account** to open the following screen.

Figure 87 Maintenance > User Account

The screenshot shows a web form with the following elements:

- User Name :** A dropdown menu with 'admin' selected.
- Old Password :** A text input field.
- New Password :** A text input field.
- Retype to Confirm :** A text input field.
- Apply** and **Cancel** buttons at the bottom right.

The following table describes the labels in this screen.

Table 66 Maintenance > User Account

LABEL	DESCRIPTION
User Name	You can configure the password for the Power User and Admin accounts.
Old Password	Type the default password or the existing password you use to access the system in this field.
New Password	Type your new system password (up to 30 characters). Note that as you type a password, the screen displays a (*) for each character you type. After you change the password, use the new password to access the LTE Device.
Retype to Confirm	Type the new password again for confirmation.
Apply	Click Apply to save your changes.
Cancel	Click Cancel to restore your previously saved settings.

Remote MGMT

19.1 Overview

Remote MGMT allows you to manage your LTE Device from a remote location through the following interfaces:

- LAN and WLAN
- WAN only

Note: The LTE Device is managed using the web configurator.

19.1.1 What You Need to Know

The following terms and concepts may help as you read this chapter

19.2 The Remote MGMT Screen

Use this screen to decide what services you may use to access which LTE Device interface. Click **Maintenance > Remote MGMT** to open the following screen.

Figure 88 Maintenance > Remote MGMT

Services	LAN/WLAN	WAN	Port
HTTP	<input checked="" type="checkbox"/> Enable	<input checked="" type="checkbox"/> Enable	80
TELNET	<input checked="" type="checkbox"/> Enable	<input type="checkbox"/> Enable	23
FTP	<input checked="" type="checkbox"/> Enable	<input type="checkbox"/> Enable	21
ICMP	<input checked="" type="checkbox"/> Enable	<input checked="" type="checkbox"/> Enable	N/A

The following table describes the fields in this screen.

Table 67 Maintenance > Remote MGMT

LABEL	DESCRIPTION
Services	This is the service you may use to access the LTE Device.
LAN/WLAN	Select the Enable check box for the corresponding services that you want to allow access to the LTE Device from the LAN and WLAN.
WAN	Select the Enable check box for the corresponding services that you want to allow access to the LTE Device from the WAN.
Port	You may change the server port number for a service if needed, however you must use the same port number in order to use that service for remote management.

Table 67 Maintenance > Remote MGMT (continued)

LABEL	DESCRIPTION
Apply	Click Apply to save your changes.
Cancel	Click Cancel to restore your previously saved settings.

20.1 Overview

You can configure system settings, including the host name, domain name and the inactivity time-out interval in the **System** screen.

20.1.1 What You Need to Know

The following terms and concepts may help as you read this chapter.

Domain Name

This is a network address that identifies the owner of a network connection. For example, in the network address "www.example.com/support/files", the domain name is "www.example.com".

20.2 The System Screen

Use the **System** screen to configure the system's host name, domain name, and inactivity time-out interval.

The **Host Name** is for identification purposes. However, because some ISPs check this name you should enter your computer's "Computer Name". Find the system name of your Windows computer.

In Windows XP, click **start, My Computer, View system information** and then click the **Computer Name** tab. Note the entry in the **Full computer name** field and enter it as the LTE Device **System Name**.

Click **Maintenance > System** to open the following screen.

Figure 89 Maintenance > System

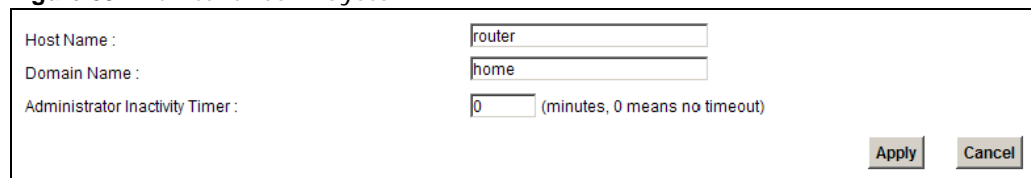

The screenshot shows a configuration window with three input fields and two buttons. The first field is labeled "Host Name:" and contains the text "router". The second field is labeled "Domain Name:" and contains the text "home". The third field is labeled "Administrator Inactivity Timer:" and contains the number "0", with a note "(minutes, 0 means no timeout)" to its right. At the bottom right of the window are two buttons: "Apply" and "Cancel".

The following table describes the labels in this screen.

Table 68 Maintenance > System

LABEL	DESCRIPTION
Host Name	Choose a descriptive name for identification purposes. It is recommended you enter your computer's "Computer name" in this field. This name can be up to 30 alphanumeric characters long. Spaces are not allowed, but dashes "-" and underscores "_" are accepted.
Domain Name	Enter the domain name (if you know it) here. If you leave this field blank, the ISP may assign a domain name via DHCP. The domain name entered by you is given priority over the ISP assigned domain name.
Administrator Inactivity Timer	Type how many minutes a management session (either via the web configurator) can be left idle before the session times out. The default is 5 minutes. After it times out you have to log in with your password again. Very long idle timeouts may have security risks. A value of "0" means a management session never times out, no matter how long it has been left idle (not recommended).
Apply	Click this to save your changes back to the LTE Device.
Cancel	Click this to begin configuring this screen afresh.

Time Setting

21.1 Overview

You can configure the system's time and date in the **Time Setting** screen.

21.2 The Time Setting Screen

To change your LTE Device's time and date, click **Maintenance > Time**. The screen appears as shown. Use this screen to configure the LTE Device's time based on your local time zone.

Figure 90 Maintenance > Time Setting

The screenshot shows the 'Time Setting' screen with the following fields and options:

- Current Date/Time:**
 - Current Time : 03:34:19
 - Current Date : 2000-01-01
- Time and Date Setup:**
 - Time Protocol : NTP
 - Time Server Address : europe.pool.ntp.org
- Time Zone:**
 - Time Zone : (GMT+01:00) Berlin, Stockholm, Rome, Bern, Brussels, Vienna
 - Daylight Savings
 - Start Date : Last Sun. Of March (2000-03-26) at 1 o'clock
 - End Date : Last Sun. Of October (2000-10-29) at 1 o'clock

Buttons: Apply, Reset

The following table describes the fields in this screen.

Table 69 Maintenance > System > Time Setting

LABEL	DESCRIPTION
Current Date/Time	
Current Time	This field displays the time of your LTE Device.
Current Date	This field displays the date of your LTE Device.
Time and Date Setup	
Time Protocol	This shows the time service protocol that your time server sends when you turn on the LTE Device.
Time Server Address	Enter the IP address or URL (up to 31 extended ASCII characters in length) of your time server. Check with your ISP/network administrator if you are unsure of this information.
Time Zone	Choose the time zone of your location. This will set the time difference between your time zone and Greenwich Mean Time (GMT).

Table 69 Maintenance > System > Time Setting (continued)

LABEL	DESCRIPTION
Daylight Savings	Daylight saving is a period from late spring to early fall when many countries set their clocks ahead of normal local time by one hour to give more daytime light in the evening. Select this option if you use Daylight Saving Time.
Start Date	<p>Configure the day and time when Daylight Saving Time starts if you selected Daylight Savings. The o'clock field uses the 24 hour format. Here are a couple of examples:</p> <p>Daylight Saving Time starts in most parts of the United States on the second Sunday of March. Each time zone in the United States starts using Daylight Saving Time at 2 A.M. local time. So in the United States you would select Second, Sunday, March and type 2 in the o'clock field.</p> <p>Daylight Saving Time starts in the European Union on the last Sunday of March. All of the time zones in the European Union start using Daylight Saving Time at the same moment (1 A.M. GMT or UTC). So in the European Union you would select Last, Sunday, March. The time you type in the o'clock field depends on your time zone. In Germany for instance, you would type 2 because Germany's time zone is one hour ahead of GMT or UTC (GMT+1).</p>
End Date	<p>Configure the day and time when Daylight Saving Time ends if you selected Daylight Savings. The o'clock field uses the 24 hour format. Here are a couple of examples:</p> <p>Daylight Saving Time ends in the United States on the first Sunday of November. Each time zone in the United States stops using Daylight Saving Time at 2 A.M. local time. So in the United States you would select First, Sunday, November and type 2 in the o'clock field.</p> <p>Daylight Saving Time ends in the European Union on the last Sunday of October. All of the time zones in the European Union stop using Daylight Saving Time at the same moment (1 A.M. GMT or UTC). So in the European Union you would select Last, Sunday, October. The time you type in the o'clock field depends on your time zone. In Germany for instance, you would type 2 because Germany's time zone is one hour ahead of GMT or UTC (GMT+1).</p>
Apply	Click Apply to save your changes.
Reset	Click Reset to begin configuring this screen afresh.

Log Setting

22.1 Overview

You can configure where the LTE Device sends logs and which logs and/or immediate alerts the LTE Device records in the **Log Setting** screen.

22.2 The Log Setting Screen

To change your LTE Device's log settings, click **Maintenance > Log Setting**. The screen appears as shown.

Figure 91 Maintenance > Log Setting

Syslog Setting

Syslog Logging : Enable Disable

Syslog Server : (IP Address)

UDP Port : (Server Port)

Active Log and Select Level

Log Category	Log Level
VoIP	
<input type="checkbox"/> VoIP-Call Statistics	ALL
<input checked="" type="checkbox"/> VoIP-SIP Call Signaling	ALL
<input checked="" type="checkbox"/> VoIP-SIP Registrations	ALL
<input type="checkbox"/> VoIP-Phone Event	ALL
<input type="checkbox"/> VoIP-Misc	ALL
System	
<input type="checkbox"/> WAN-DHCP	ALL
<input checked="" type="checkbox"/> ETHER	ALL
<input checked="" type="checkbox"/> System Maintenance	ALL
<input type="checkbox"/> Remote Management	ALL
<input checked="" type="checkbox"/> TR-069	ALL
<input type="checkbox"/> NTP	ALL
<input type="checkbox"/> DDNS	ALL
<input type="checkbox"/> NAT	ALL
<input type="checkbox"/> Attack	EMERG
<input type="checkbox"/> ACL	EMERG

The following table describes the fields in this screen.

Table 70 Maintenance > Log Setting

LABEL	DESCRIPTION
Syslog Setting	
Syslog Logging	The LTE Device sends a log to an external syslog server. Select the Enable check box to enable syslog logging.
Syslog Server	Enter the server name or IP address of the syslog server that will log the selected categories of logs.
UDP Port	Enter the port number used by the syslog server.
Active Log and Select Level	
Log Category	Select the categories of logs that you want to record.
Log Level	Select the severity level of logs that you want to record. If you want to record all logs, select ALL .
Apply	Click Apply to save your changes.
Cancel	Click Cancel to restore your previously saved settings.

Firmware Upgrade

23.1 Overview

This chapter explains how to upload new firmware to your LTE Device. You can download new firmware releases from your nearest Huawei FTP site (or www.huawei.com) to use to upgrade your device's performance.

Only use firmware for your device's specific model. Refer to the label on the bottom of your LTE Device.

23.2 The Firmware Upgrade Screen

Click **Maintenance > Firmware Upgrade** to open the following screen. The upload process uses HTTP (Hypertext Transfer Protocol) and may take up to three minutes. After a successful upload, the system will reboot.

Do NOT turn off the LTE Device while firmware upload is in progress!

Figure 92 Maintenance > Firmware Upgrade

The following table describes the labels in this screen.

Table 71 Maintenance > Firmware Upgrade

LABEL	DESCRIPTION
Current Firmware Version	This is the present Firmware version.
File Path	Type in the location of the file you want to upload in this field or click Browse ... to find it.
Browse...	Click this to find the .bin file you want to upload. Remember that you must decompress compressed (.zip) files before you can upload them.
Upload	Click this to begin the upload process. This process may take up to three minutes.

After you see the firmware updating screen, wait a few minutes before logging into the LTE Device again.

Figure 93 Firmware Uploading

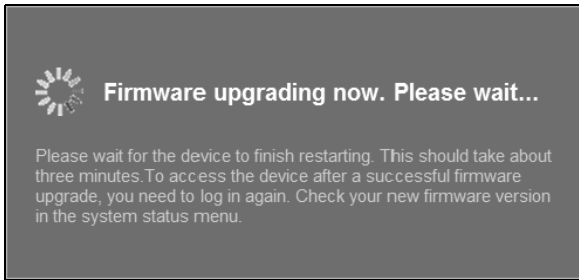

The LTE Device automatically restarts in this time causing a temporary network disconnect. In some operating systems, you may see the following icon on your desktop.

Figure 94 Network Temporarily Disconnected



After two minutes, log in again and check your new firmware version in the **Status** screen.

If the upload was not successful, an error screen will appear. Click **OK** to go back to the **Firmware Upgrade** screen.

Figure 95 Error Message

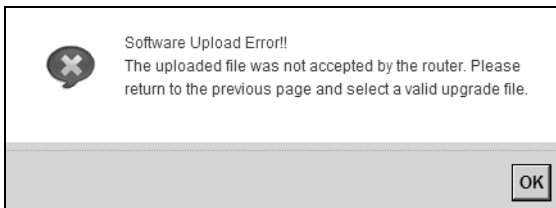

Backup/Restore

24.1 Overview

The **Backup/Restore** screen allows you to backup and restore device configurations. You can also reset your device settings back to the factory default.

24.2 The Backup/Restore Screen

Click **Maintenance > Backup/Restore**. Information related to factory defaults, backup configuration, and restoring configuration appears in this screen, as shown next.

Figure 96 Maintenance > Backup/Restore

Backup Configuration
Click Backup to save the current configuration of your system to your computer.

Restore Configuration
To restore a previously saved configuration file to your system, browse to the location of the configuration file and click Upload.
FilePath :

Back to Factory Defaults
Click Reset to clear all user-entered configuration information and return to factory defaults. After resetting, the LAN IP address will be 192.168.1.1 DHCP will be reset to server

Backup Configuration

Backup Configuration allows you to back up (save) the LTE Device's current configuration to a file on your computer. Once your LTE Device is configured and functioning properly, it is highly recommended that you back up your configuration file before making configuration changes. The backup configuration file will be useful in case you need to return to your previous settings.

Click **Backup** to save the LTE Device's current configuration to your computer.

Restore Configuration

Restore Configuration allows you to upload a new or previously saved configuration file from your computer to your LTE Device.

Table 72 Restore Configuration

LABEL	DESCRIPTION
File Path	Type in the location of the file you want to upload in this field or click Browse ... to find it.
Browse...	Click this to find the file you want to upload. Remember that you must decompress compressed (.ZIP) files before you can upload them.
Upload	Click this to begin the upload process.
Reset	Click this to reset your device settings back to the factory default.

Do not turn off the LTE Device while configuration file upload is in progress.

After the LTE Device configuration has been restored successfully, the login screen appears. Login again to restart the LTE Device.

The LTE Device automatically restarts in this time causing a temporary network disconnect. In some operating systems, you may see the following icon on your desktop.

Figure 97 Network Temporarily Disconnected



If you restore the default configuration, you may need to change the IP address of your computer to be in the same subnet as that of the default device IP address (192.168.1.1). See [Appendix B on page 189](#) for details on how to set up your computer's IP address.

If the upload was not successful, an error screen will appear. Click **OK** to go back to the **Configuration** screen.

Reset to Factory Defaults

Click the **Reset** button to clear all user-entered configuration information and return the LTE Device to its factory defaults. The following warning screen appears.

Figure 98 Reset Warning Message

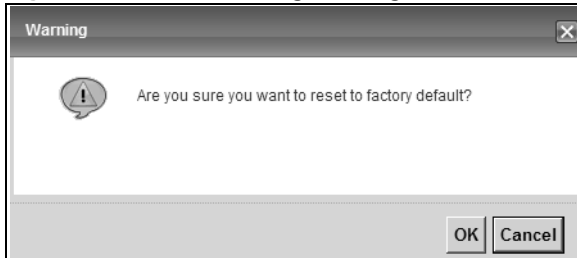
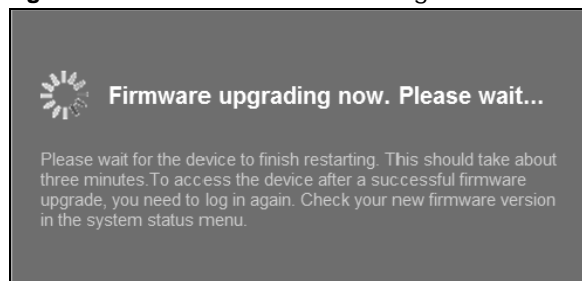

Figure 99 Reset In Process Message



You can also press the **RESET** button on the back panel to reset the factory defaults of your LTE Device. Refer to [Section 1.7 on page 20](#) for more information on the **RESET** button.

24.3 The Reboot Screen

System restart allows you to reboot the LTE Device remotely without turning the power off. You may need to do this if the LTE Device hangs, for example.

Click **Maintenance > Reboot**. Click the **Reboot** button to have the LTE Device reboot. This does not affect the LTE Device's configuration.

Diagnostic

25.1 Overview

You can use different diagnostic methods to test a connection and see the detailed information. These read-only screens display information to help you identify problems with the LTE Device.

25.2 The Ping/TraceRoute Screen

Ping and traceroute help check availability of remote hosts and also help troubleshoot network or Internet connections. Click **Maintenance > Diagnostic** to open the **Ping/TraceRoute** screen shown next.

Figure 100 Maintenance > Diagnostic > Ping/TraceRoute

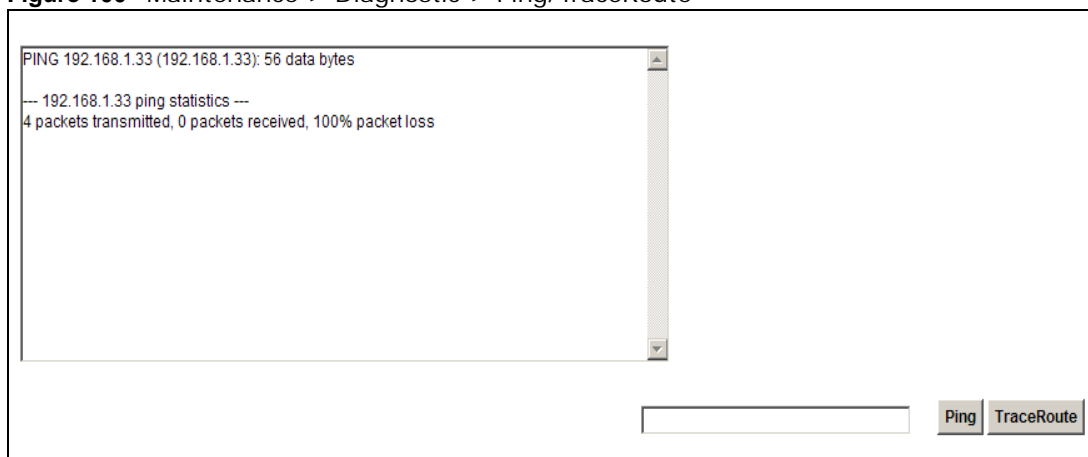

The following table describes the fields in this screen.

Table 73 Maintenance > Diagnostic > Ping/TraceRoute

LABEL	DESCRIPTION
Ping	Type the IP address of a computer that you want to ping in order to test a connection. Click Ping and the ping statistics will show in the diagnostic .
TraceRoute	Click this button to perform the traceroute function. This determines the path a packet takes to the specified host.

Troubleshooting

26.1 Overview

This chapter offers some suggestions to solve problems you might encounter. The potential problems are divided into the following categories.

- [Power, Hardware Connections, and LEDs](#)
- [LTE Device Access and Login](#)
- [Internet Access](#)
- [Wireless Internet Access](#)
- [Phone Calls and VoIP](#)
- [UPnP](#)

26.2 Power, Hardware Connections, and LEDs

The LTE Device does not turn on. None of the LEDs turn on.

- 1 Make sure the LTE Device is turned on.
- 2 Make sure you are using the power adaptor or cord included with the LTE Device.
- 3 Make sure the power adaptor or cord is connected to the LTE Device and plugged in to an appropriate power source. Make sure the power source is turned on.
- 4 Turn the LTE Device off and on.
- 5 If the problem continues, contact the vendor.

One of the LEDs does not behave as expected.

- 1 Make sure you understand the normal behavior of the LED. See [Section 1.6 on page 18](#).
- 2 Check the hardware connections. See the Quick Start Guide.
- 3 Inspect your cables for damage. Contact the vendor to replace any damaged cables.

- 4 Turn the LTE Device off and on.
- 5 If the problem continues, contact the vendor.

26.3 LTE Device Access and Login

I forgot the IP address for the LTE Device.

- 1 The default IP address is 192.168.1.1.
- 2 If you changed the IP address and have forgotten it, you might get the IP address of the LTE Device by looking up the IP address of the default gateway for your computer. To do this in most Windows computers, click **Start > Run**, enter **cmd**, and then enter **ipconfig**. The IP address of the **Default Gateway** might be the IP address of the LTE Device (it depends on the network), so enter this IP address in your Internet browser.
- 3 If this does not work, you have to reset the device to its factory defaults. See [Section 1.7 on page 20](#).

I forgot the password.

- 1 The default admin password is **1234** and the default user password is **1234**.
- 2 If you can't remember the password, you have to reset the device to its factory defaults. See [Section 1.7 on page 20](#).

I cannot see or access the **Login** screen in the web configurator.

- 1 Make sure you are using the correct IP address.
 - The default IP address is 192.168.1.1.
 - If you changed the IP address, use the new IP address.
 - If you changed the IP address and have forgotten it, see the troubleshooting suggestions for [I forgot the IP address for the LTE Device](#).
- 2 Check the hardware connections, and make sure the LEDs are behaving as expected. See the Quick Start Guide.
- 3 Make sure your Internet browser does not block pop-up windows and has JavaScript and Java enabled. See [Appendix C on page 219](#).

- 4 Reset the device to its factory defaults, and try to access the LTE Device with the default IP address. See [Section 1.7 on page 20](#).
- 5 If the problem continues, contact the network administrator or vendor, or try one of the advanced suggestions.

Advanced Suggestions

- Try to access the LTE Device using another service, such as Telnet. If you can access the LTE Device, check the remote management settings and firewall rules to find out why the LTE Device does not respond to HTTP.
- If your computer is connected to the **WAN** port or is connected wirelessly, use a computer that is connected to a **ETHERNET** port.

I can see the **Login** screen, but I cannot log in to the LTE Device.

- 1 Make sure you have entered the user name and password correctly. The default user name is **admin**. These fields are case-sensitive, so make sure [Caps Lock] is not on.
- 2 You cannot log in to the web configurator while someone is using Telnet to access the LTE Device. Log out of the LTE Device in the other session, or ask the person who is logged in to log out.
- 3 Turn the LTE Device off and on.
- 4 If this does not work, you have to reset the device to its factory defaults. See [Section 26.2 on page 173](#).

26.4 Internet Access

I cannot access the Internet.

- 1 Check the hardware connections, and make sure the LEDs are behaving as expected. See the Quick Start Guide and [Section 1.6 on page 18](#).
- 2 Make sure you entered your service provider's LTE APN information correctly.
- 3 If you are trying to access the Internet wirelessly, make sure the wireless settings in the wireless client are the same as the settings in the AP.
- 4 If you are trying to access the Internet wirelessly, make sure you have enabled the wireless LAN by the **WPS/WLAN** button or the **Network Setting > Wireless > General** screen.
- 5 Disconnect all the cables from your device, and follow the directions in the Quick Start Guide again.
- 6 If the problem continues, contact your ISP.

I cannot access the Internet anymore. I had access to the Internet (with the LTE Device), but my Internet connection is not available anymore.

- 1 Check the hardware connections, and make sure the LEDs are behaving as expected. See the Quick Start Guide and [Section 1.6 on page 18](#).
- 2 Turn the LTE Device off and on.
- 3 If the problem continues, contact your ISP.

The Internet connection is slow or intermittent.

- 1 There might be a lot of traffic on the network. Look at the LEDs, and check [Section 1.6 on page 18](#). If the LTE Device is sending or receiving a lot of information, try closing some programs that use the Internet, especially peer-to-peer applications.
- 2 Turn the LTE Device off and on.
- 3 If the problem continues, contact the network administrator or vendor, or try one of the advanced suggestions.

Advanced Suggestions

- Check the settings for QoS. If it is disabled, you might consider activating it. If it is enabled, you might consider raising or lowering the priority for some applications.

26.5 Wireless Internet Access

What factors may cause intermittent or unstabled wireless connection? How can I solve this problem?

The following factors may cause interference:

- Obstacles: walls, ceilings, furniture, and so on.
- Building Materials: metal doors, aluminum studs.
- Electrical devices: microwaves, monitors, electric motors, cordless phones, and other wireless devices.

To optimize the speed and quality of your wireless connection, you can:

- Move your wireless device closer to the AP if the signal strength is low.

- Reduce wireless interference that may be caused by other wireless networks or surrounding wireless electronics such as cordless phones.
- Place the AP where there are minimum obstacles (such as walls and ceilings) between the AP and the wireless client.
- Reduce the number of wireless clients connecting to the same AP simultaneously, or add additional APs if necessary.
- Try closing some programs that use the Internet, especially peer-to-peer applications. If the wireless client is sending or receiving a lot of information, it may have too many programs open that use the Internet.

What wireless security modes does my LTE Device support?

Wireless security is vital to your network. It protects communications between wireless stations, access points and the wired network.

The available security modes in your device are as follows:

- **WPA2-PSK:** (recommended) This uses a pre-shared key with the WPA2 standard.
- **WPA-PSK:** This has the device use either WPA-PSK or WPA2-PSK depending on which security mode the wireless client uses.
- **WPA2:** WPA2 (IEEE 802.11i) is a wireless security standard that defines stronger encryption, authentication and key management than WPA. It requires the use of a RADIUS server and is mostly used in business networks.
- **WPA:** Wi-Fi Protected Access (WPA) is a subset of the IEEE 802.11i standard. It requires the use of a RADIUS server and is mostly used in business networks.
- **WEP:** Wired Equivalent Privacy (WEP) encryption scrambles the data transmitted between the wireless stations and the access points to keep network communications private.

26.6 Phone Calls and VoIP

The telephone port won't work or the telephone lacks a dial tone.

- 1 Check the telephone connection and telephone wire.

I can access the Internet, but cannot make VoIP calls.

- 1 The **PHONE** light should come on. Make sure that your telephone is connected to the **PHONE** port.
- 2 You can also check the VoIP status in the **System Info** screen.

- 3 If the VoIP settings are correct, use speed dial to make peer-to-peer calls. If you can make a call using speed dial, there may be something wrong with the SIP server, contact your VoIP service provider.

26.7 UPnP

When using UPnP and the LTE Device reboots, my computer cannot detect UPnP and refresh **My Network Places > Local Network**.

- 1 Disconnect the Ethernet cable from the LTE Device's LAN port or from your computer.
- 2 Re-connect the Ethernet cable.

The **Local Area Connection** icon for UPnP disappears in the screen.

Restart your computer.

I cannot open special applications such as white board, file transfer and video when I use the MSN messenger.

- 1 Wait more than three minutes.
- 2 Restart the applications.

IP Addresses and Subnetting

This appendix introduces IP addresses and subnet masks.

IP addresses identify individual devices on a network. Every networking device (such as computers, servers, routers, and printers) needs an IP address to communicate across the network. These networking devices are also known as hosts.

Subnet masks determine the maximum number of possible hosts on a network. You can also use subnet masks to divide one network into multiple sub-networks.

Introduction to IP Addresses

One part of the IP address is the network number, and the other part is the host ID. In the same way that houses on a street share a common street name, the hosts on a network share a common network number. Similarly, as each house has its own house number, each host on the network has its own unique identifying number - the host ID. Routers use the network number to send packets to the correct network, while the host ID determines to which host on the network the packets are delivered.

Structure

An IP address is made up of four parts, written in dotted decimal notation (for example, 192.168.1.1). Each of these four parts is known as an octet. An octet is an eight-digit binary number (for example 11000000, which is 192 in decimal notation).

Therefore, each octet has a possible range of 00000000 to 11111111 in binary, or 0 to 255 in decimal.

The following figure shows an example IP address in which the first three octets (192.168.1) are the network number, and the fourth octet (16) is the host ID.

Figure 101 Network Number and Host ID

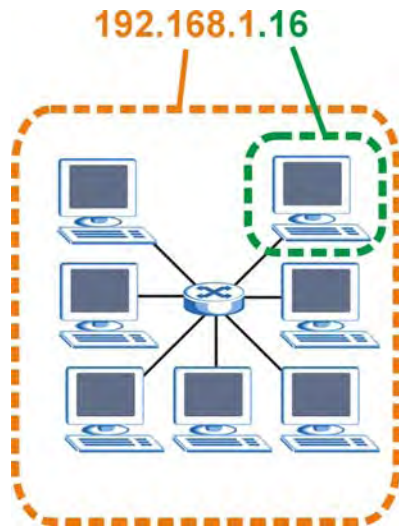

How much of the IP address is the network number and how much is the host ID varies according to the subnet mask.

Subnet Masks

A subnet mask is used to determine which bits are part of the network number, and which bits are part of the host ID (using a logical AND operation). The term “subnet” is short for “sub-network”.

A subnet mask has 32 bits. If a bit in the subnet mask is a “1” then the corresponding bit in the IP address is part of the network number. If a bit in the subnet mask is “0” then the corresponding bit in the IP address is part of the host ID.

The following example shows a subnet mask identifying the network number (in bold text) and host ID of an IP address (192.168.1.2 in decimal).

Table 74 IP Address Network Number and Host ID Example

	1ST OCTET: (192)	2ND OCTET: (168)	3RD OCTET: (1)	4TH OCTET (2)
IP Address (Binary)	11000000	10101000	00000001	00000010
Subnet Mask (Binary)	11111111	11111111	11111111	00000000
Network Number	11000000	10101000	00000001	
Host ID				00000010

By convention, subnet masks always consist of a continuous sequence of ones beginning from the leftmost bit of the mask, followed by a continuous sequence of zeros, for a total number of 32 bits.

Subnet masks can be referred to by the size of the network number part (the bits with a “1” value). For example, an “8-bit mask” means that the first 8 bits of the mask are ones and the remaining 24 bits are zeroes.

Subnet masks are expressed in dotted decimal notation just like IP addresses. The following examples show the binary and decimal notation for 8-bit, 16-bit, 24-bit and 29-bit subnet masks.

Table 75 Subnet Masks

	BINARY				DECIMAL
	1ST OCTET	2ND OCTET	3RD OCTET	4TH OCTET	
8-bit mask	11111111	00000000	00000000	00000000	255.0.0.0
16-bit mask	11111111	11111111	00000000	00000000	255.255.0.0
24-bit mask	11111111	11111111	11111111	00000000	255.255.255.0
29-bit mask	11111111	11111111	11111111	11111000	255.255.255.248

Network Size

The size of the network number determines the maximum number of possible hosts you can have on your network. The larger the number of network number bits, the smaller the number of remaining host ID bits.

An IP address with host IDs of all zeros is the IP address of the network (192.168.1.0 with a 24-bit subnet mask, for example). An IP address with host IDs of all ones is the broadcast address for that network (192.168.1.255 with a 24-bit subnet mask, for example).

As these two IP addresses cannot be used for individual hosts, calculate the maximum number of possible hosts in a network as follows:

Table 76 Maximum Host Numbers

SUBNET MASK		HOST ID SIZE		MAXIMUM NUMBER OF HOSTS
8 bits	255.0.0.0	24 bits	$2^{24} - 2$	16777214
16 bits	255.255.0.0	16 bits	$2^{16} - 2$	65534
24 bits	255.255.255.0	8 bits	$2^8 - 2$	254
29 bits	255.255.255.248	3 bits	$2^3 - 2$	6

Notation

Since the mask is always a continuous number of ones beginning from the left, followed by a continuous number of zeros for the remainder of the 32 bit mask, you can simply specify the number of ones instead of writing the value of each octet. This is usually specified by writing a “/” followed by the number of bits in the mask after the address.

For example, 192.1.1.0 /25 is equivalent to saying 192.1.1.0 with subnet mask 255.255.255.128.

The following table shows some possible subnet masks using both notations.

Table 77 Alternative Subnet Mask Notation

SUBNET MASK	ALTERNATIVE NOTATION	LAST OCTET (BINARY)	LAST OCTET (DECIMAL)
255.255.255.0	/24	0000 0000	0
255.255.255.128	/25	1000 0000	128
255.255.255.192	/26	1100 0000	192
255.255.255.224	/27	1110 0000	224
255.255.255.240	/28	1111 0000	240
255.255.255.248	/29	1111 1000	248
255.255.255.252	/30	1111 1100	252

Subnetting

You can use subnetting to divide one network into multiple sub-networks. In the following example a network administrator creates two sub-networks to isolate a group of servers from the rest of the company network for security reasons.

In this example, the company network address is 192.168.1.0. The first three octets of the address (192.168.1) are the network number, and the remaining octet is the host ID, allowing a maximum of $2^8 - 2$ or 254 possible hosts.

The following figure shows the company network before subnetting.

Figure 102 Subnetting Example: Before Subnetting

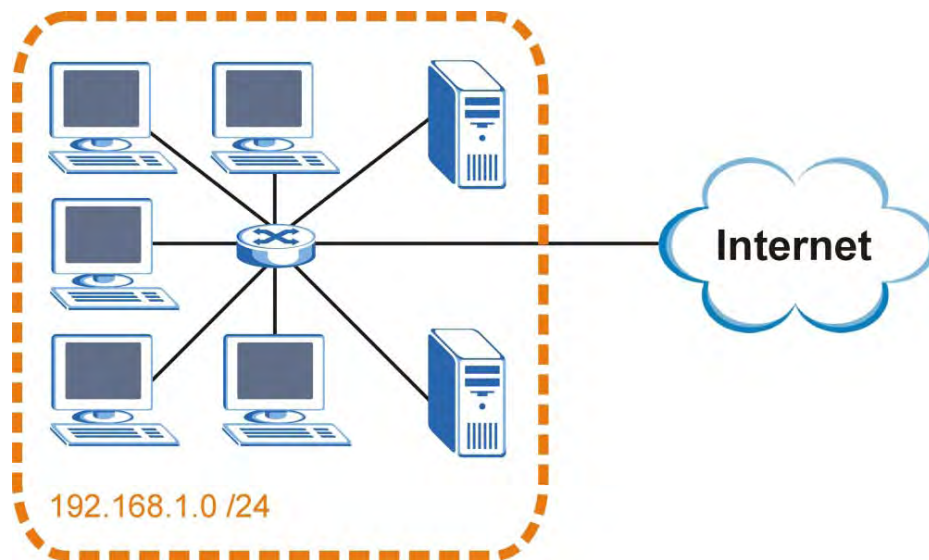

You can “borrow” one of the host ID bits to divide the network 192.168.1.0 into two separate sub-networks. The subnet mask is now 25 bits (255.255.255.128 or /25).

The “borrowed” host ID bit can have a value of either 0 or 1, allowing two subnets; 192.168.1.0 /25 and 192.168.1.128 /25.

The following figure shows the company network after subnetting. There are now two sub-networks, **A** and **B**.

Figure 103 Subnetting Example: After Subnetting

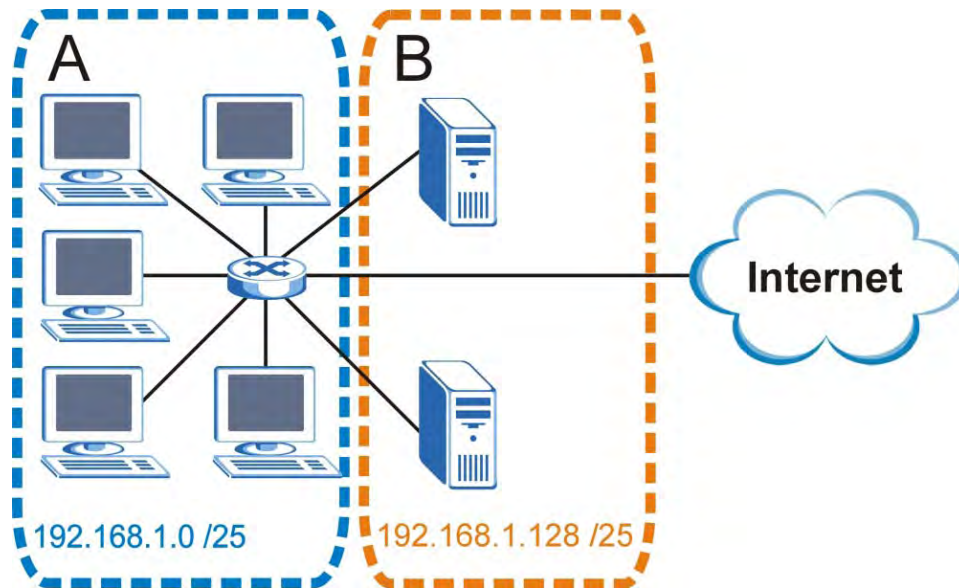

In a 25-bit subnet the host ID has 7 bits, so each sub-network has a maximum of $2^7 - 2$ or 126 possible hosts (a host ID of all zeroes is the subnet's address itself, all ones is the subnet's broadcast address).

192.168.1.0 with mask 255.255.255.128 is subnet **A** itself, and 192.168.1.127 with mask 255.255.255.128 is its broadcast address. Therefore, the lowest IP address that can be assigned to an actual host for subnet **A** is 192.168.1.1 and the highest is 192.168.1.126.

Similarly, the host ID range for subnet **B** is 192.168.1.129 to 192.168.1.254.

Example: Four Subnets

The previous example illustrated using a 25-bit subnet mask to divide a 24-bit address into two subnets. Similarly, to divide a 24-bit address into four subnets, you need to "borrow" two host ID bits to give four possible combinations (00, 01, 10 and 11). The subnet mask is 26 bits (11111111.11111111.11111111.11000000) or 255.255.255.192.

Each subnet contains 6 host ID bits, giving $2^6 - 2$ or 62 hosts for each subnet (a host ID of all zeroes is the subnet itself, all ones is the subnet's broadcast address).

Table 78 Subnet 1

IP/SUBNET MASK	NETWORK NUMBER	LAST OCTET BIT VALUE
IP Address (Decimal)	192.168.1.	0
IP Address (Binary)	11000000.10101000.00000001.	00000000
Subnet Mask (Binary)	11111111.11111111.11111111.	11000000

Table 78 Subnet 1 (continued)

IP/SUBNET MASK	NETWORK NUMBER	LAST OCTET BIT VALUE
Subnet Address: 192.168.1.0	Lowest Host ID: 192.168.1.1	
Broadcast Address: 192.168.1.63	Highest Host ID: 192.168.1.62	

Table 79 Subnet 2

IP/SUBNET MASK	NETWORK NUMBER	LAST OCTET BIT VALUE
IP Address	192.168.1.	64
IP Address (Binary)	11000000.10101000.00000001.	01000000
Subnet Mask (Binary)	11111111.11111111.11111111.	11000000
Subnet Address: 192.168.1.64	Lowest Host ID: 192.168.1.65	
Broadcast Address: 192.168.1.127	Highest Host ID: 192.168.1.126	

Table 80 Subnet 3

IP/SUBNET MASK	NETWORK NUMBER	LAST OCTET BIT VALUE
IP Address	192.168.1.	128
IP Address (Binary)	11000000.10101000.00000001.	10000000
Subnet Mask (Binary)	11111111.11111111.11111111.	11000000
Subnet Address: 192.168.1.128	Lowest Host ID: 192.168.1.129	
Broadcast Address: 192.168.1.191	Highest Host ID: 192.168.1.190	

Table 81 Subnet 4

IP/SUBNET MASK	NETWORK NUMBER	LAST OCTET BIT VALUE
IP Address	192.168.1.	192
IP Address (Binary)	11000000.10101000.00000001.	11000000
Subnet Mask (Binary)	11111111.11111111.11111111.	11000000
Subnet Address: 192.168.1.192	Lowest Host ID: 192.168.1.193	
Broadcast Address: 192.168.1.255	Highest Host ID: 192.168.1.254	

Example: Eight Subnets

Similarly, use a 27-bit mask to create eight subnets (000, 001, 010, 011, 100, 101, 110 and 111).

The following table shows IP address last octet values for each subnet.

Table 82 Eight Subnets

SUBNET	SUBNET ADDRESS	FIRST ADDRESS	LAST ADDRESS	BROADCAST ADDRESS
1	0	1	30	31
2	32	33	62	63
3	64	65	94	95
4	96	97	126	127
5	128	129	158	159
6	160	161	190	191
7	192	193	222	223
8	224	225	254	255

Subnet Planning

The following table is a summary for subnet planning on a network with a 24-bit network number.

Table 83 24-bit Network Number Subnet Planning

NO. "BORROWED" HOST BITS	SUBNET MASK	NO. SUBNETS	NO. HOSTS PER SUBNET
1	255.255.255.128 (/25)	2	126
2	255.255.255.192 (/26)	4	62
3	255.255.255.224 (/27)	8	30
4	255.255.255.240 (/28)	16	14
5	255.255.255.248 (/29)	32	6
6	255.255.255.252 (/30)	64	2
7	255.255.255.254 (/31)	128	1

The following table is a summary for subnet planning on a network with a 16-bit network number.

Table 84 16-bit Network Number Subnet Planning

NO. "BORROWED" HOST BITS	SUBNET MASK	NO. SUBNETS	NO. HOSTS PER SUBNET
1	255.255.128.0 (/17)	2	32766
2	255.255.192.0 (/18)	4	16382
3	255.255.224.0 (/19)	8	8190
4	255.255.240.0 (/20)	16	4094
5	255.255.248.0 (/21)	32	2046
6	255.255.252.0 (/22)	64	1022
7	255.255.254.0 (/23)	128	510
8	255.255.255.0 (/24)	256	254
9	255.255.255.128 (/25)	512	126
10	255.255.255.192 (/26)	1024	62
11	255.255.255.224 (/27)	2048	30
12	255.255.255.240 (/28)	4096	14

Table 84 16-bit Network Number Subnet Planning (continued)

NO. "BORROWED" HOST BITS	SUBNET MASK	NO. SUBNETS	NO. HOSTS PER SUBNET
13	255.255.255.248 (/29)	8192	6
14	255.255.255.252 (/30)	16384	2
15	255.255.255.254 (/31)	32768	1

Configuring IP Addresses

Where you obtain your network number depends on your particular situation. If the ISP or your network administrator assigns you a block of registered IP addresses, follow their instructions in selecting the IP addresses and the subnet mask.

If the ISP did not explicitly give you an IP network number, then most likely you have a single user account and the ISP will assign you a dynamic IP address when the connection is established. If this is the case, it is recommended that you select a network number from 192.168.0.0 to 192.168.255.0. The Internet Assigned Number Authority (IANA) reserved this block of addresses specifically for private use; please do not use any other number unless you are told otherwise. You must also enable Network Address Translation (NAT) on the LTE Device.

Once you have decided on the network number, pick an IP address for your LTE Device that is easy to remember (for instance, 192.168.1.1) but make sure that no other device on your network is using that IP address.

The subnet mask specifies the network number portion of an IP address. Your LTE Device will compute the subnet mask automatically based on the IP address that you entered. You don't need to change the subnet mask computed by the LTE Device unless you are instructed to do otherwise.

Private IP Addresses

Every machine on the Internet must have a unique address. If your networks are isolated from the Internet (running only between two branch offices, for example) you can assign any IP addresses to the hosts without problems. However, the Internet Assigned Numbers Authority (IANA) has reserved the following three blocks of IP addresses specifically for private networks:

- 10.0.0.0 — 10.255.255.255
- 172.16.0.0 — 172.31.255.255
- 192.168.0.0 — 192.168.255.255

You can obtain your IP address from the IANA, from an ISP, or it can be assigned from a private network. If you belong to a small organization and your Internet access is through an ISP, the ISP can provide you with the Internet addresses for your local networks. On the other hand, if you are part of a much larger organization, you should consult your network administrator for the appropriate IP addresses.

Regardless of your particular situation, do not create an arbitrary IP address; always follow the guidelines above. For more information on address assignment, please refer to RFC 1597, Address Allocation for Private Internets and RFC 1466, Guidelines for Management of IP Address Space.

IP Address Conflicts

Each device on a network must have a unique IP address. Devices with duplicate IP addresses on the same network will not be able to access the Internet or other resources. The devices may also be unreachable through the network.

Conflicting Computer IP Addresses Example

More than one device can not use the same IP address. In the following example computer **A** has a static (or fixed) IP address that is the same as the IP address that a DHCP server assigns to computer **B** which is a DHCP client. Neither can access the Internet. This problem can be solved by assigning a different static IP address to computer **A** or setting computer **A** to obtain an IP address automatically.

Figure 104 Conflicting Computer IP Addresses Example

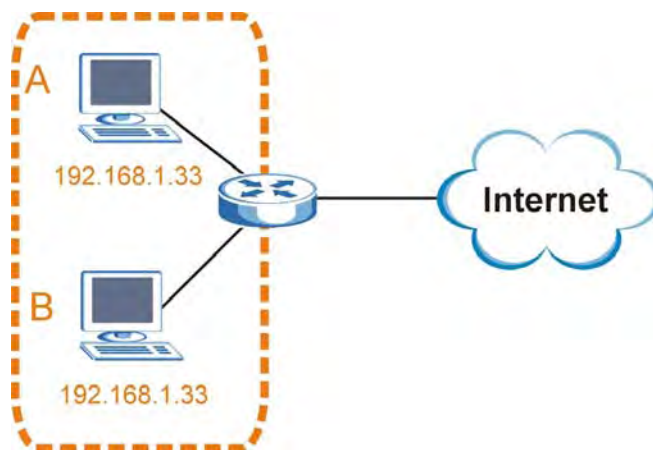

Conflicting Router IP Addresses Example

Since a router connects different networks, it must have interfaces using different network numbers. For example, if a router is set between a LAN and the Internet (WAN), the router's LAN and WAN addresses must be on different subnets. In the following example, the LAN and WAN are on the same subnet. The LAN computers cannot access the Internet because the router cannot route between networks.

Figure 105 Conflicting Computer IP Addresses Example

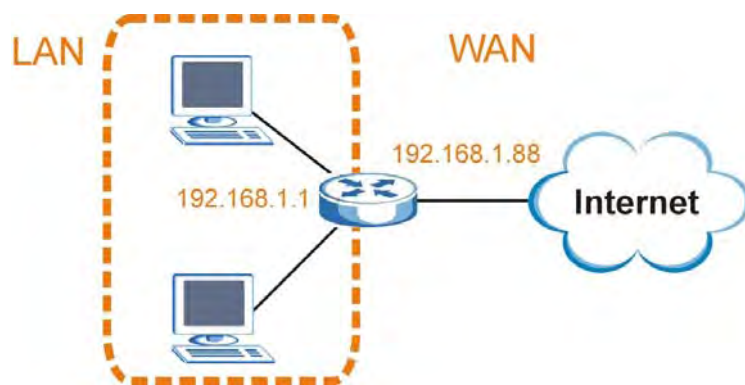

Conflicting Computer and Router IP Addresses Example

More than one device can not use the same IP address. In the following example, the computer and the router's LAN port both use 192.168.1.1 as the IP address. The computer cannot access the Internet. This problem can be solved by assigning a different IP address to the computer or the router's LAN port.

Figure 106 Conflicting Computer and Router IP Addresses Example

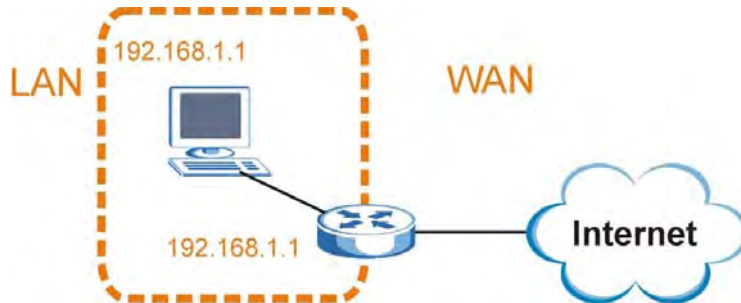

Setting Up Your Computer's IP Address

Note: Your specific LTE Device may not support all of the operating systems described in this appendix. See the product specifications for more information about which operating systems are supported.

This appendix shows you how to configure the IP settings on your computer in order for it to be able to communicate with the other devices on your network. Windows Vista/XP/2000, Mac OS 9/ OS X, and all versions of UNIX/LINUX include the software components you need to use TCP/IP on your computer.

If you manually assign IP information instead of using a dynamic IP, make sure that your network's computers have IP addresses that place them in the same subnet.

In this appendix, you can set up an IP address for:

- [Windows XP/NT/2000 on page 189](#)
- [Windows Vista on page 193](#)
- [Windows 7 on page 197](#)
- [Mac OS X: 10.3 and 10.4 on page 201](#)
- [Mac OS X: 10.5 on page 204](#)
- [Linux: Ubuntu 8 \(GNOME\) on page 208](#)
- [Linux: openSUSE 10.3 \(KDE\) on page 212](#)

Windows XP/NT/2000

The following example uses the default Windows XP display theme but can also apply to Windows 2000 and Windows NT.

- 1 Click **Start > Control Panel**.

Figure 107 Windows XP: Start Menu

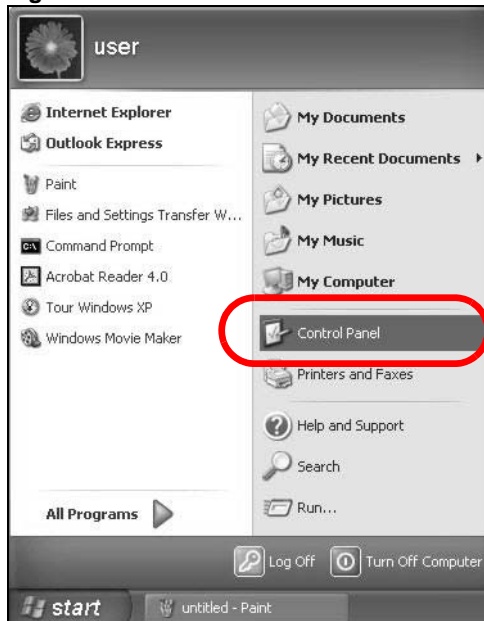

- 2 In the **Control Panel**, click the **Network Connections** icon.

Figure 108 Windows XP: Control Panel

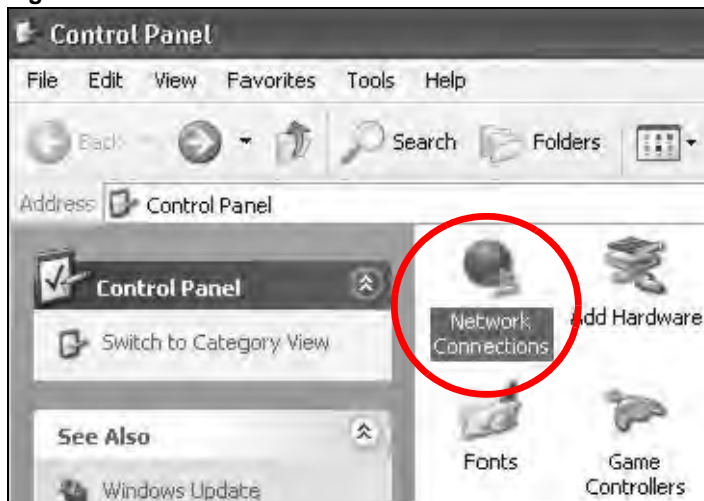

- 3 Right-click **Local Area Connection** and then select **Properties**.

Figure 109 Windows XP: Control Panel > Network Connections > Properties

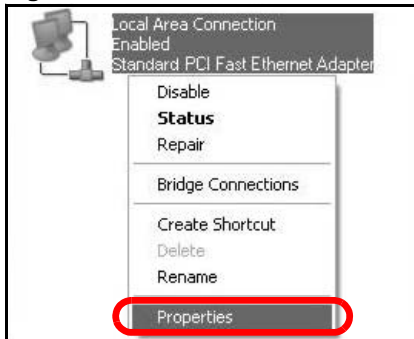

- 4 On the **General** tab, select **Internet Protocol (TCP/IP)** and then click **Properties**.

Figure 110 Windows XP: Local Area Connection Properties

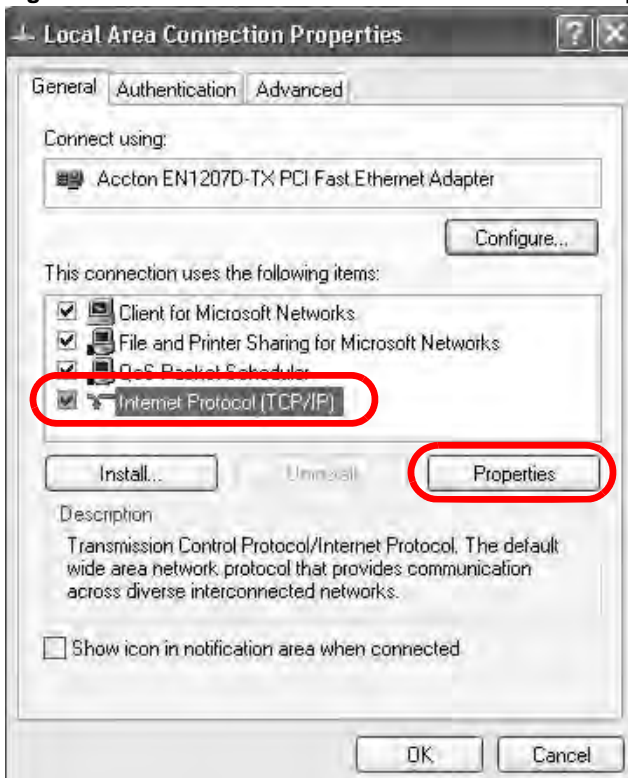

- 5 The **Internet Protocol TCP/IP Properties** window opens.

Figure 111 Windows XP: Internet Protocol (TCP/IP) Properties

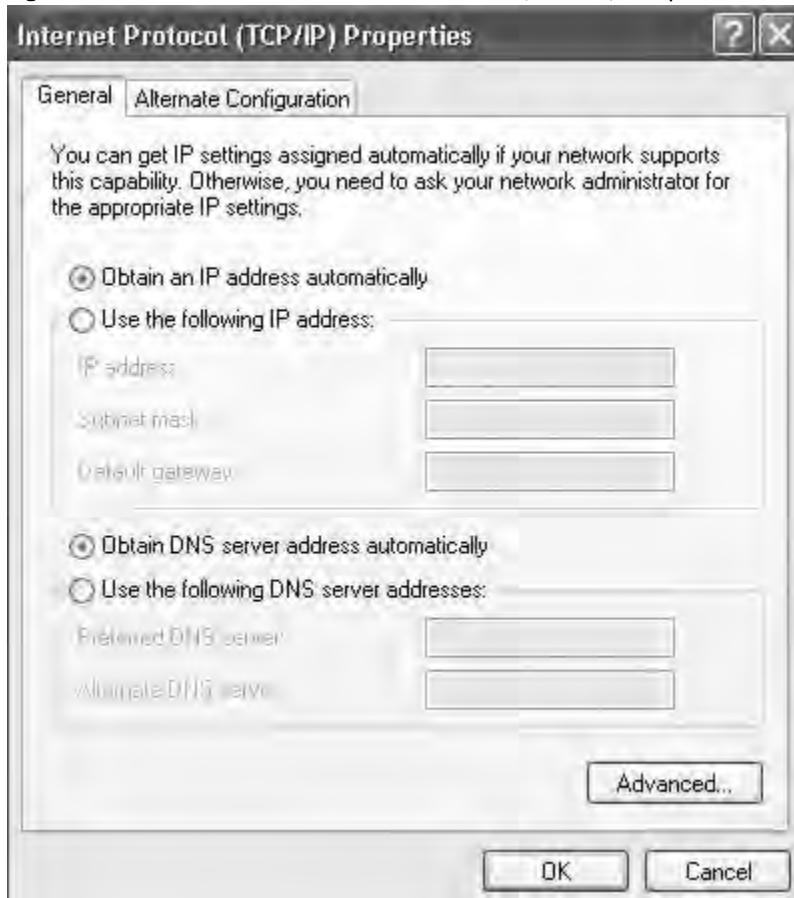

- 6 Select **Obtain an IP address automatically** if your network administrator or ISP assigns your IP address dynamically.

Select **Use the following IP Address** and fill in the **IP address**, **Subnet mask**, and **Default gateway** fields if you have a static IP address that was assigned to you by your network administrator or ISP. You may also have to enter a **Preferred DNS server** and an **Alternate DNS server**, if that information was provided.

- 7 Click **OK** to close the **Internet Protocol (TCP/IP) Properties** window.
- 8 Click **OK** to close the **Local Area Connection Properties** window.

Verifying Settings

- 1 Click **Start > All Programs > Accessories > Command Prompt**.
- 2 In the **Command Prompt** window, type "ipconfig" and then press [ENTER].

You can also go to **Start > Control Panel > Network Connections**, right-click a network connection, click **Status** and then click the **Support** tab to view your IP address and connection information.

Windows Vista

This section shows screens from Windows Vista Professional.

- 1 Click **Start > Control Panel**.

Figure 112 Windows Vista: Start Menu

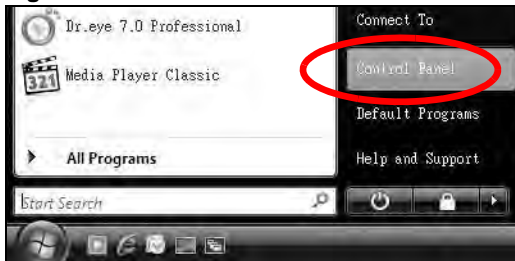

- 2 In the **Control Panel**, click the **Network and Internet** icon.

Figure 113 Windows Vista: Control Panel

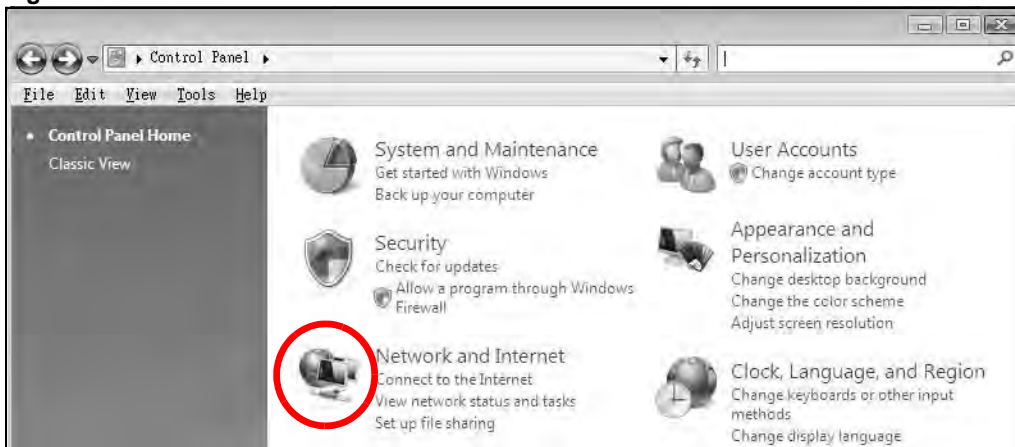

- 3 Click the **Network and Sharing Center** icon.

Figure 114 Windows Vista: Network And Internet

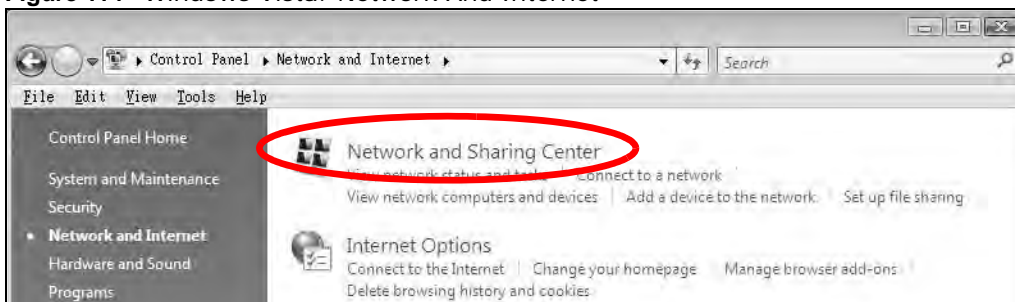

- 4 Click **Manage network connections**.

Figure 115 Windows Vista: Network and Sharing Center

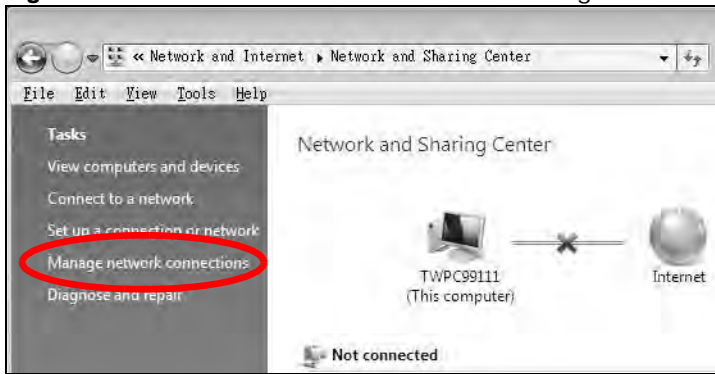

- 5 Right-click **Local Area Connection** and then select **Properties**.

Figure 116 Windows Vista: Network and Sharing Center



Note: During this procedure, click **Continue** whenever Windows displays a screen saying that it needs your permission to continue.

- 6 Select **Internet Protocol Version 4 (TCP/IPv4)** and then select **Properties**.

Figure 117 Windows Vista: Local Area Connection Properties

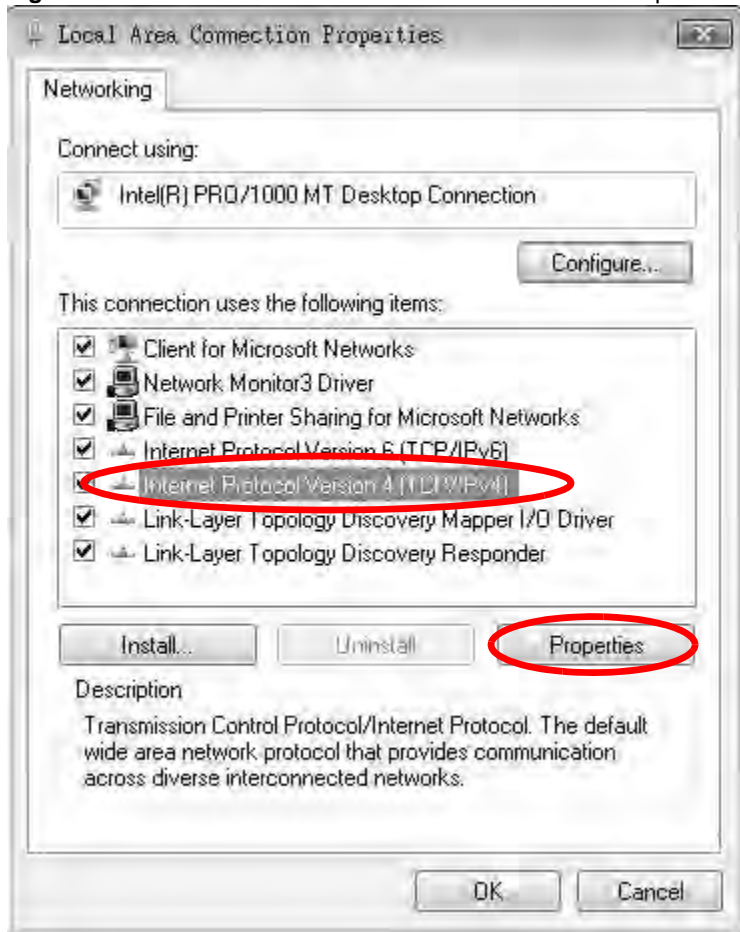

- 7 The **Internet Protocol Version 4 (TCP/IPv4) Properties** window opens.

Figure 118 Windows Vista: Internet Protocol Version 4 (TCP/IPv4) Properties

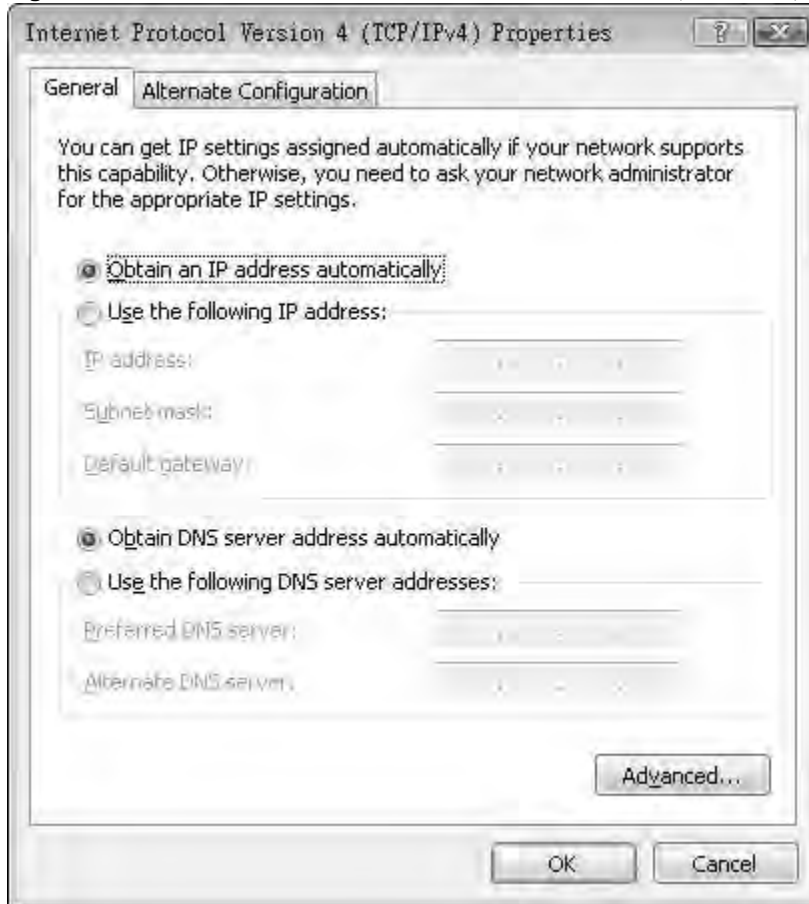

- 8 Select **Obtain an IP address automatically** if your network administrator or ISP assigns your IP address dynamically.

Select **Use the following IP Address** and fill in the **IP address**, **Subnet mask**, and **Default gateway** fields if you have a static IP address that was assigned to you by your network administrator or ISP. You may also have to enter a **Preferred DNS server** and an **Alternate DNS server**, if that information was provided. Click **Advanced**.

- 9 Click **OK** to close the **Internet Protocol (TCP/IP) Properties** window.
- 10 Click **OK** to close the **Local Area Connection Properties** window.

Verifying Settings

- 1 Click **Start > All Programs > Accessories > Command Prompt**.
- 2 In the **Command Prompt** window, type "ipconfig" and then press [ENTER].

You can also go to **Start > Control Panel > Network Connections**, right-click a network connection, click **Status** and then click the **Support** tab to view your IP address and connection information.

Windows 7

This section shows screens from Windows 7 Enterprise.

- 1 Click **Start > Control Panel**.

Figure 119 Windows 7: Start Menu

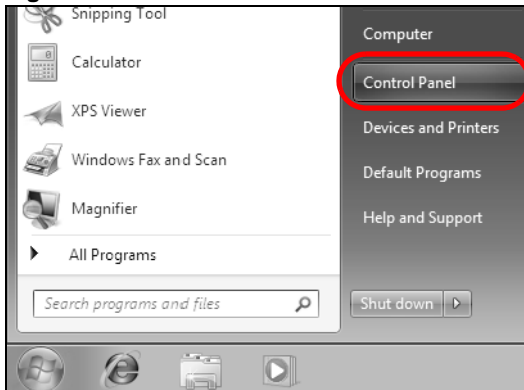

- 2 In the **Control Panel**, click **View network status and tasks** under the **Network and Internet** category.

Figure 120 Windows 7: Control Panel

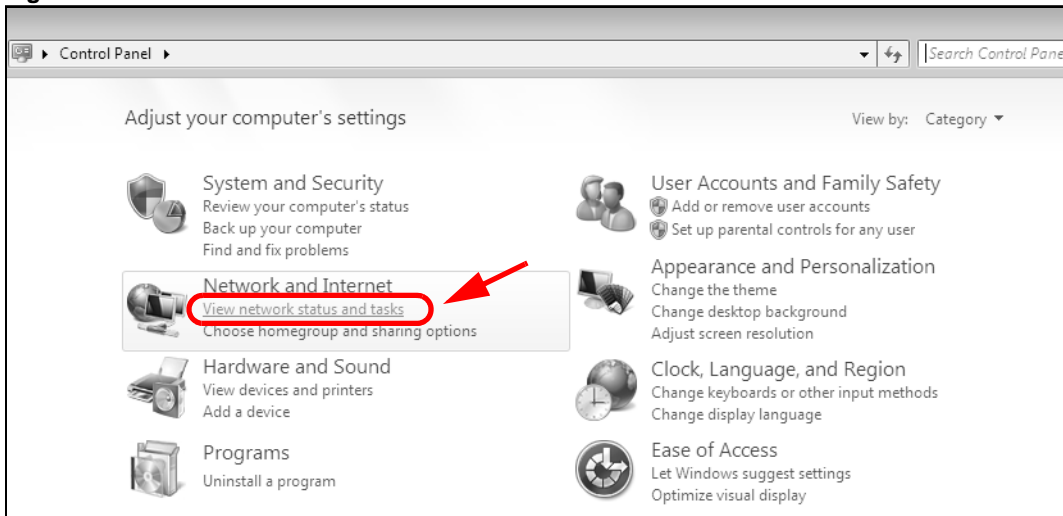

- 3 Click **Change adapter settings**.

Figure 121 Windows 7: Network And Sharing Center

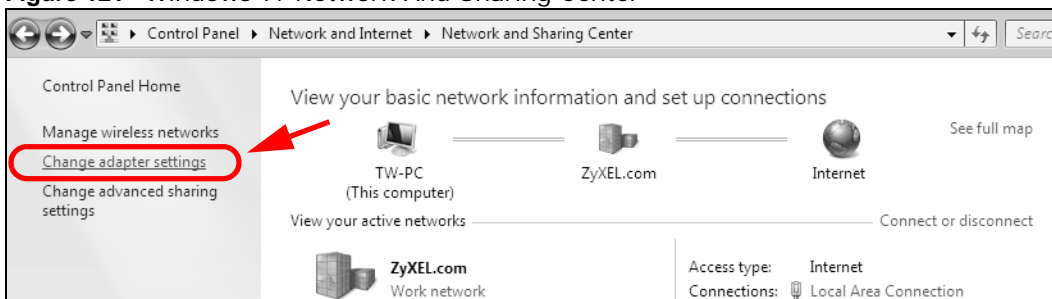

- 4 Double click **Local Area Connection** and then select **Properties**.

Figure 122 Windows 7: Local Area Connection Status

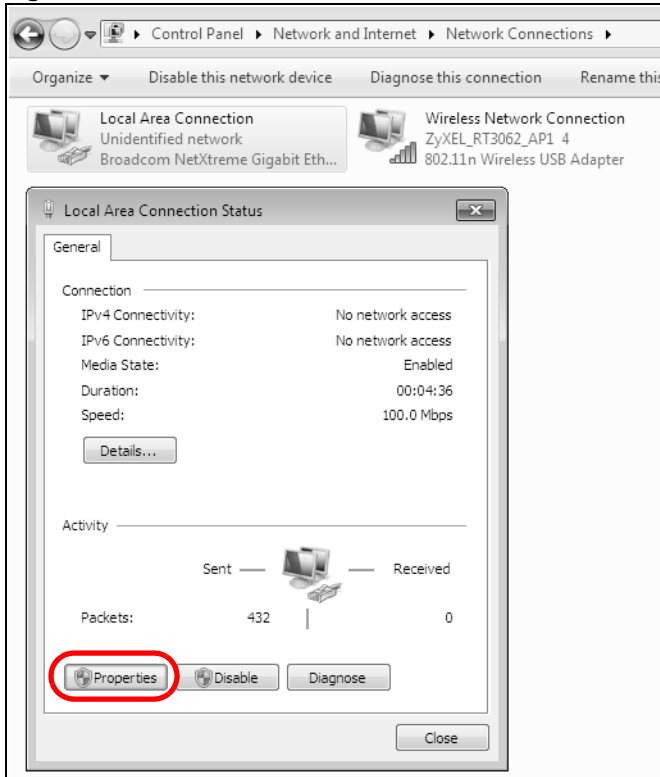

Note: During this procedure, click **Continue** whenever Windows displays a screen saying that it needs your permission to continue.

- 5 Select **Internet Protocol Version 4 (TCP/IPv4)** and then select **Properties**.

Figure 123 Windows 7: Local Area Connection Properties

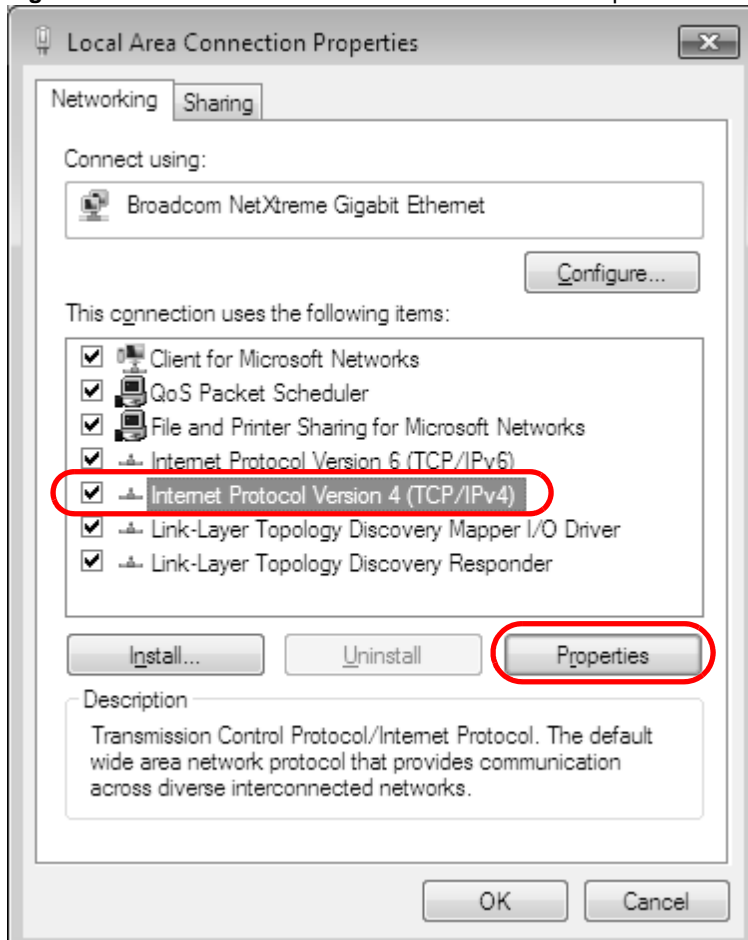

- The **Internet Protocol Version 4 (TCP/IPv4) Properties** window opens.

Figure 124 Windows 7: Internet Protocol Version 4 (TCP/IPv4) Properties

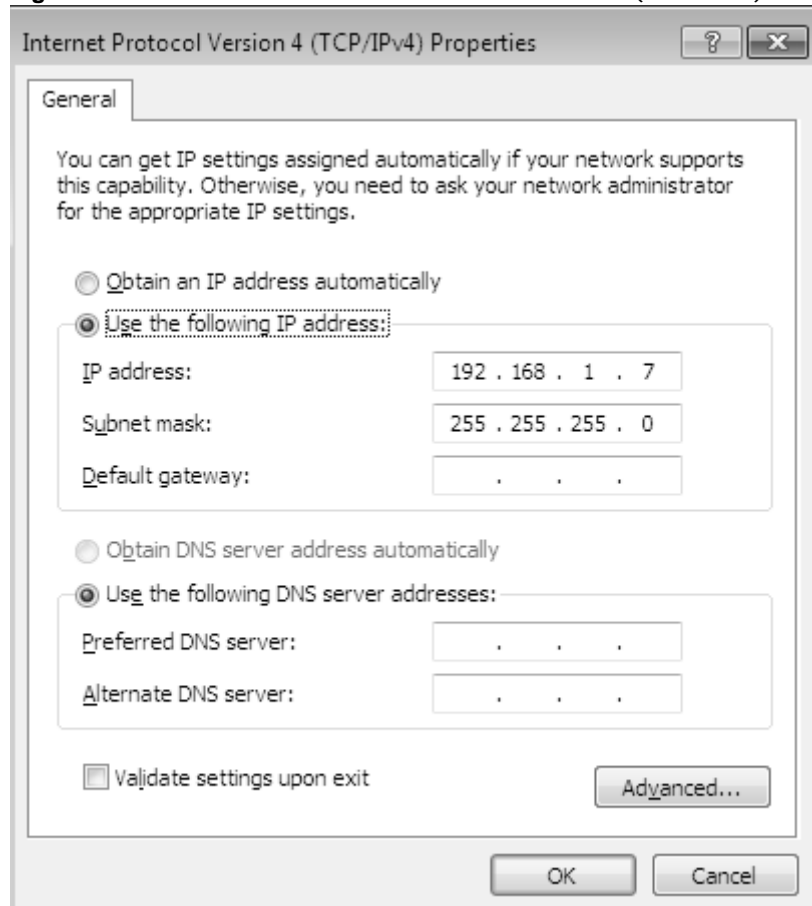

- Select **Obtain an IP address automatically** if your network administrator or ISP assigns your IP address dynamically.

Select **Use the following IP Address** and fill in the **IP address**, **Subnet mask**, and **Default gateway** fields if you have a static IP address that was assigned to you by your network administrator or ISP. You may also have to enter a **Preferred DNS server** and an **Alternate DNS server**, if that information was provided. Click **Advanced** if you want to configure advanced settings for IP, DNS and WINS.

- Click **OK** to close the **Internet Protocol (TCP/IP) Properties** window.
- Click **OK** to close the **Local Area Connection Properties** window.

Verifying Settings

- Click **Start > All Programs > Accessories > Command Prompt**.
- In the **Command Prompt** window, type "ipconfig" and then press [ENTER].

- 3 The IP settings are displayed as follows.

Figure 125 Windows 7: Internet Protocol Version 4 (TCP/IPv4) Properties

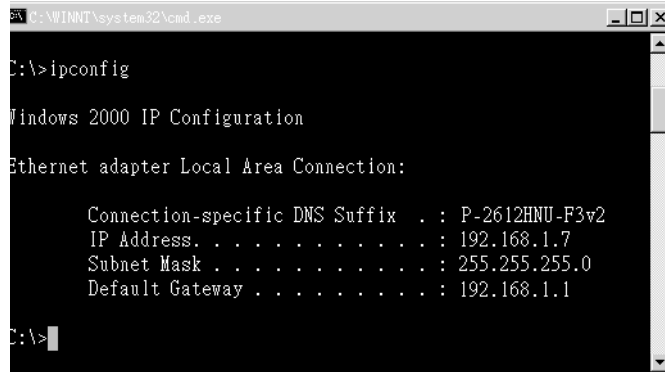

```
C:\WINNT\system32\cmd.exe
C:\>ipconfig

Windows 2000 IP Configuration

Ethernet adapter Local Area Connection:

    Connection-specific DNS Suffix  . : P-2612HNU-F3v2
    IP Address. . . . . : 192.168.1.7
    Subnet Mask . . . . . : 255.255.255.0
    Default Gateway . . . . . : 192.168.1.1

C:\>
```

Mac OS X: 10.3 and 10.4

The screens in this section are from Mac OS X 10.4 but can also apply to 10.3.

- 1 Click **Apple > System Preferences**.

Figure 126 Mac OS X 10.4: Apple Menu



- 2 In the **System Preferences** window, click the **Network** icon.

Figure 127 Mac OS X 10.4: System Preferences



- 3 When the **Network** preferences pane opens, select **Built-in Ethernet** from the network connection type list, and then click **Configure**.

Figure 128 Mac OS X 10.4: Network Preferences

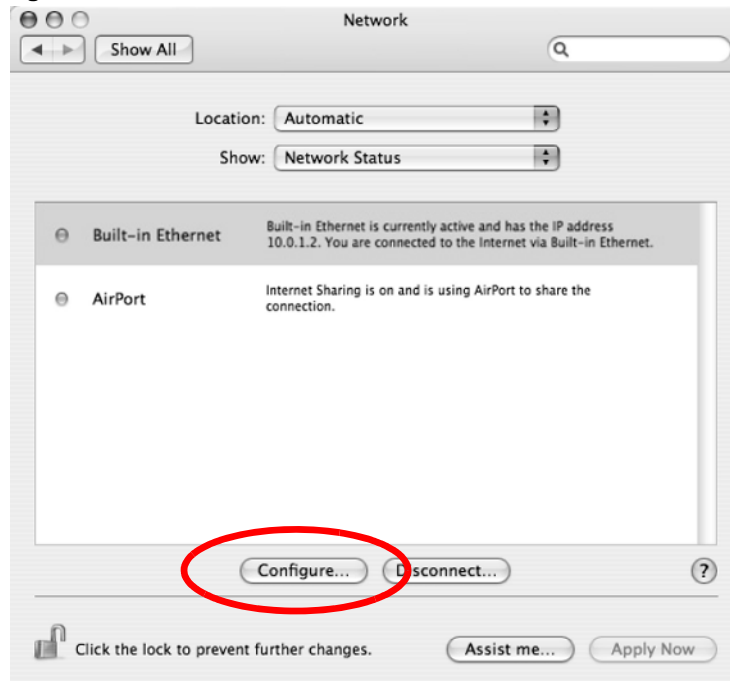

- For dynamically assigned settings, select **Using DHCP** from the **Configure IPv4** list in the **TCP/IP** tab.

Figure 129 Mac OS X 10.4: Network Preferences > TCP/IP Tab.

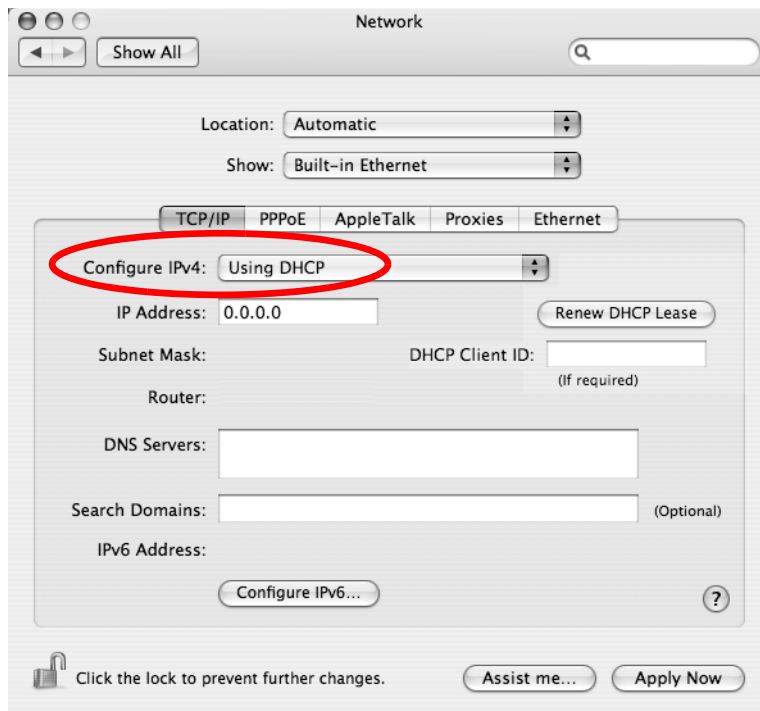

- For statically assigned settings, do the following:
 - From the **Configure IPv4** list, select **Manually**.
 - In the **IP Address** field, type your IP address.
 - In the **Subnet Mask** field, type your subnet mask.

- In the **Router** field, type the IP address of your device.

Figure 130 Mac OS X 10.4: Network Preferences > Ethernet

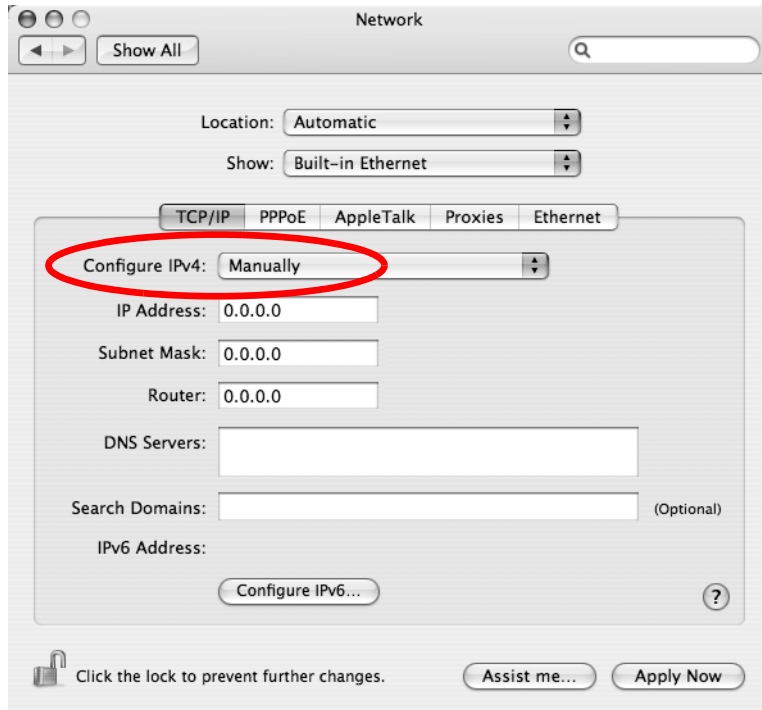

- 6 Click **Apply Now** and close the window.

Verifying Settings

Check your TCP/IP properties by clicking **Applications > Utilities > Network Utilities**, and then selecting the appropriate **Network Interface** from the **Info** tab.

Figure 131 Mac OS X 10.4: Network Utility

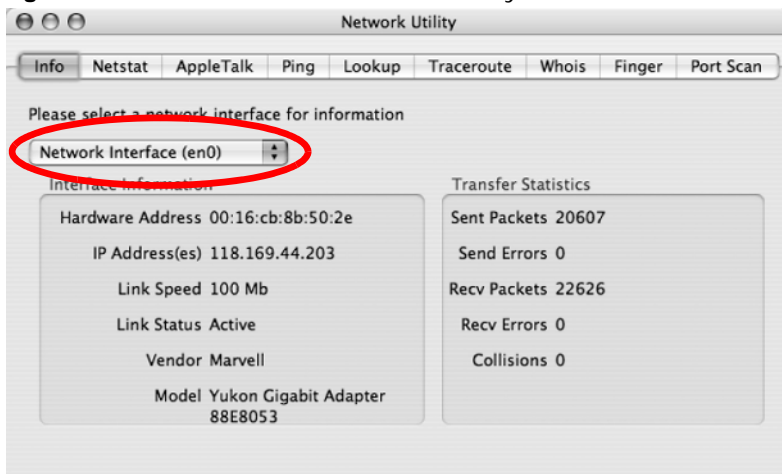

Mac OS X: 10.5

The screens in this section are from Mac OS X 10.5.

- 1 Click **Apple** > **System Preferences**.

Figure 132 Mac OS X 10.5: Apple Menu

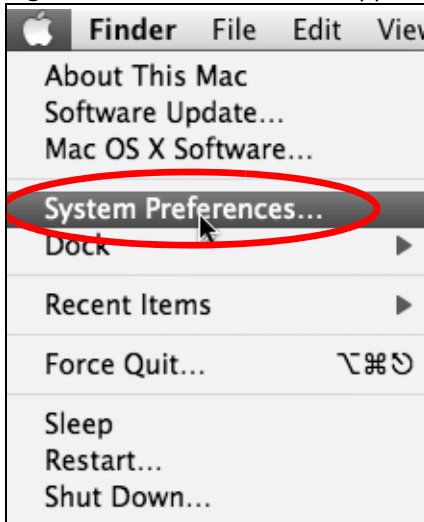

- 2 In **System Preferences**, click the **Network** icon.

Figure 133 Mac OS X 10.5: Systems Preferences



- 3 When the **Network** preferences pane opens, select **Ethernet** from the list of available connection types.

Figure 134 Mac OS X 10.5: Network Preferences > Ethernet

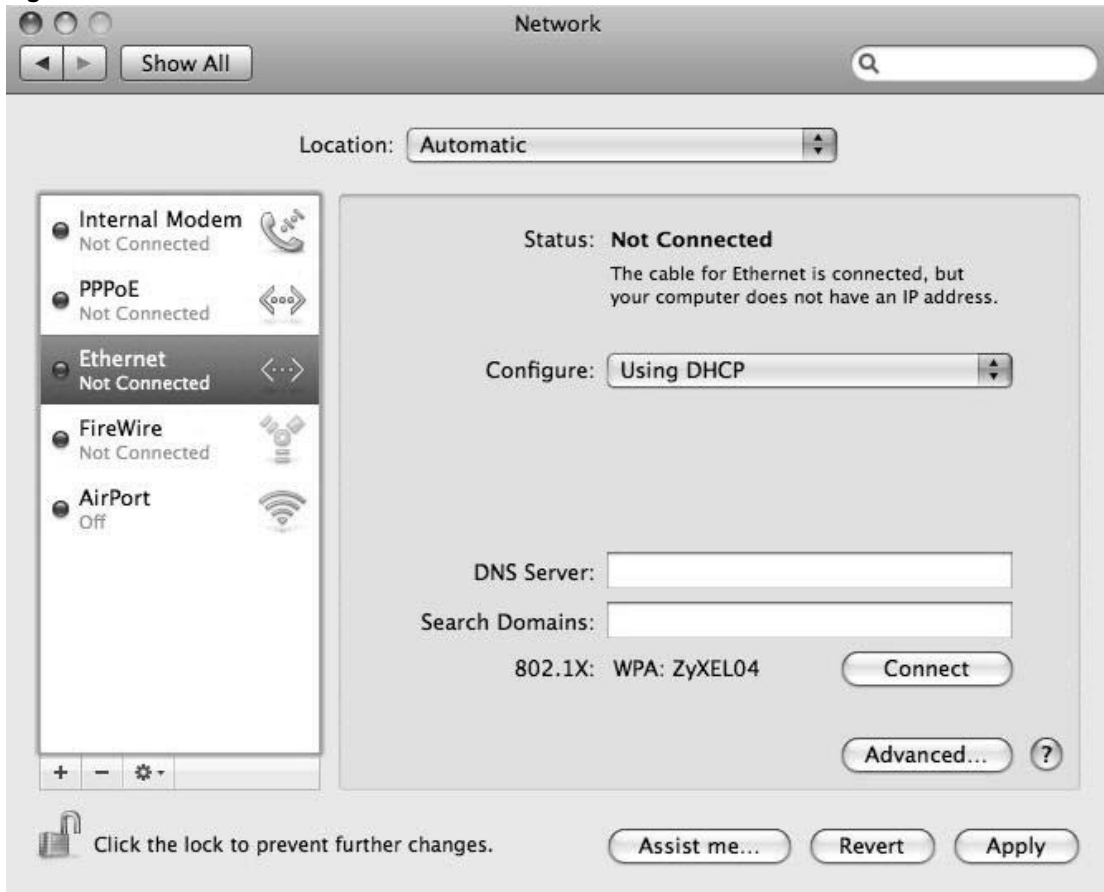

- 4 From the **Configure** list, select **Using DHCP** for dynamically assigned settings.
- 5 For statically assigned settings, do the following:
 - From the **Configure** list, select **Manually**.
 - In the **IP Address** field, enter your IP address.
 - In the **Subnet Mask** field, enter your subnet mask.

- In the **Router** field, enter the IP address of your LTE Device.

Figure 135 Mac OS X 10.5: Network Preferences > Ethernet

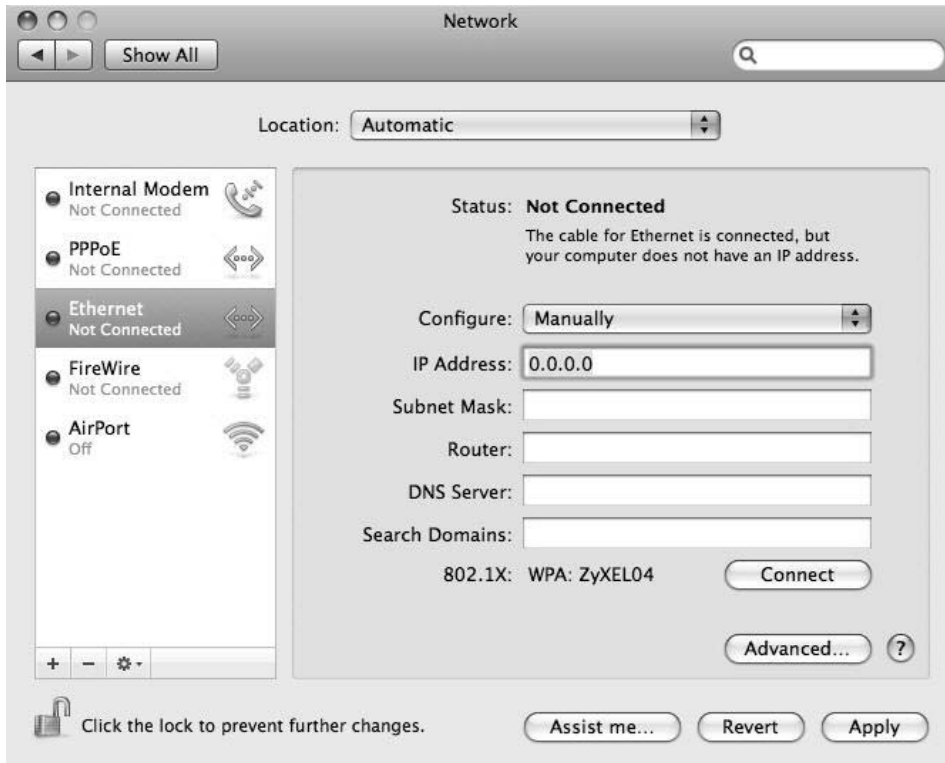

- 6 Click **Apply** and close the window.

Verifying Settings

Check your TCP/IP properties by clicking **Applications > Utilities > Network Utilities**, and then selecting the appropriate **Network interface** from the **Info** tab.

Figure 136 Mac OS X 10.5: Network Utility

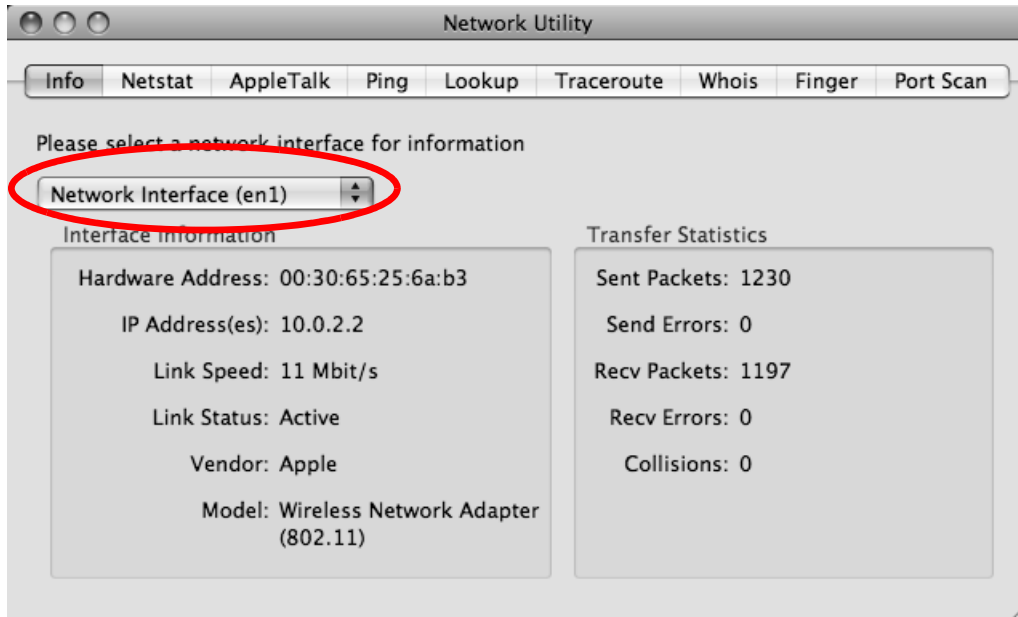

Linux: Ubuntu 8 (GNOME)

This section shows you how to configure your computer's TCP/IP settings in the GNU Object Model Environment (GNOME) using the Ubuntu 8 Linux distribution. The procedure, screens and file locations may vary depending on your specific distribution, release version, and individual configuration. The following screens use the default Ubuntu 8 installation.

Note: Make sure you are logged in as the root administrator.

Follow the steps below to configure your computer IP address in GNOME:

- 1 Click **System > Administration > Network**.

Figure 137 Ubuntu 8: System > Administration Menu

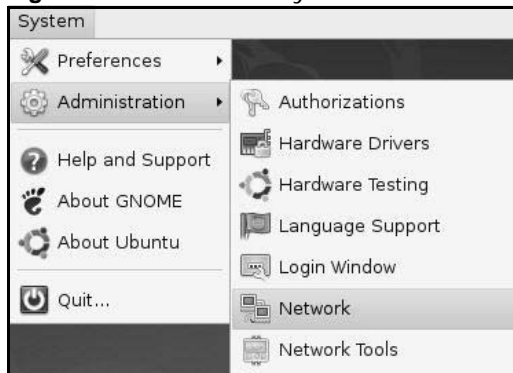

- When the **Network Settings** window opens, click **Unlock** to open the **Authenticate** window. (By default, the **Unlock** button is greyed out until clicked.) You cannot make changes to your configuration unless you first enter your admin password.

Figure 138 Ubuntu 8: Network Settings > Connections

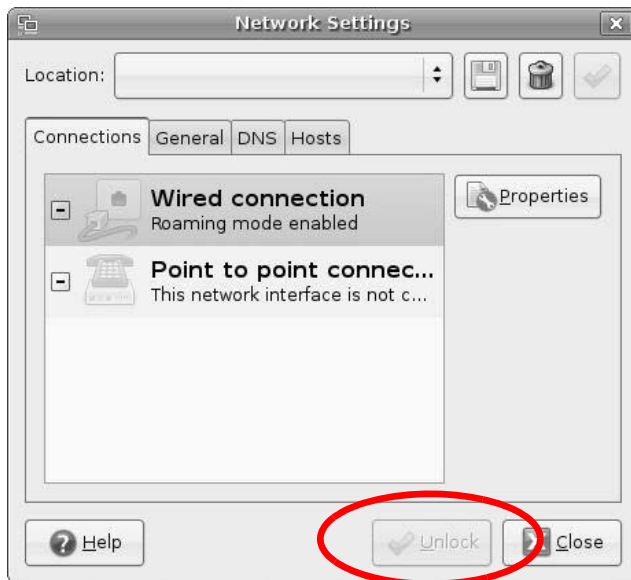

- In the **Authenticate** window, enter your admin account name and password then click the **Authenticate** button.

Figure 139 Ubuntu 8: Administrator Account Authentication



- 4 In the **Network Settings** window, select the connection that you want to configure, then click **Properties**.

Figure 140 Ubuntu 8: Network Settings > Connections

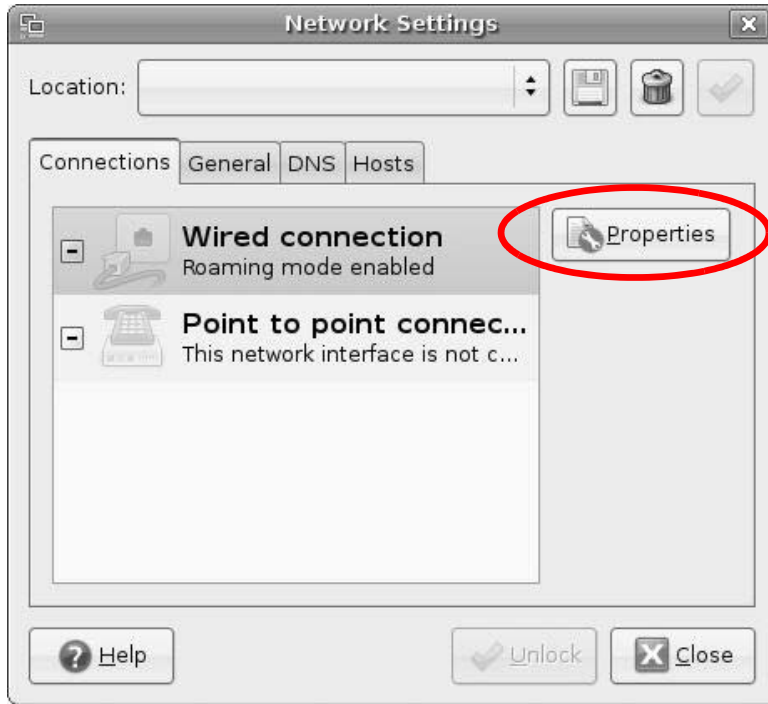

- 5 The **Properties** dialog box opens.

Figure 141 Ubuntu 8: Network Settings > Properties

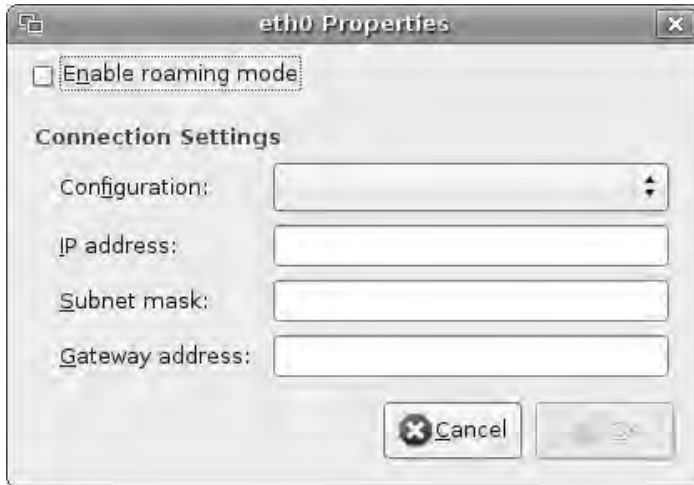

- In the **Configuration** list, select **Automatic Configuration (DHCP)** if you have a dynamic IP address.
 - In the **Configuration** list, select **Static IP address** if you have a static IP address. Fill in the **IP address**, **Subnet mask**, and **Gateway address** fields.
- 6 Click **OK** to save the changes and close the **Properties** dialog box and return to the **Network Settings** screen.

- 7 If you know your DNS server IP address(es), click the **DNS** tab in the **Network Settings** window and then enter the DNS server information in the fields provided.

Figure 142 Ubuntu 8: Network Settings > DNS

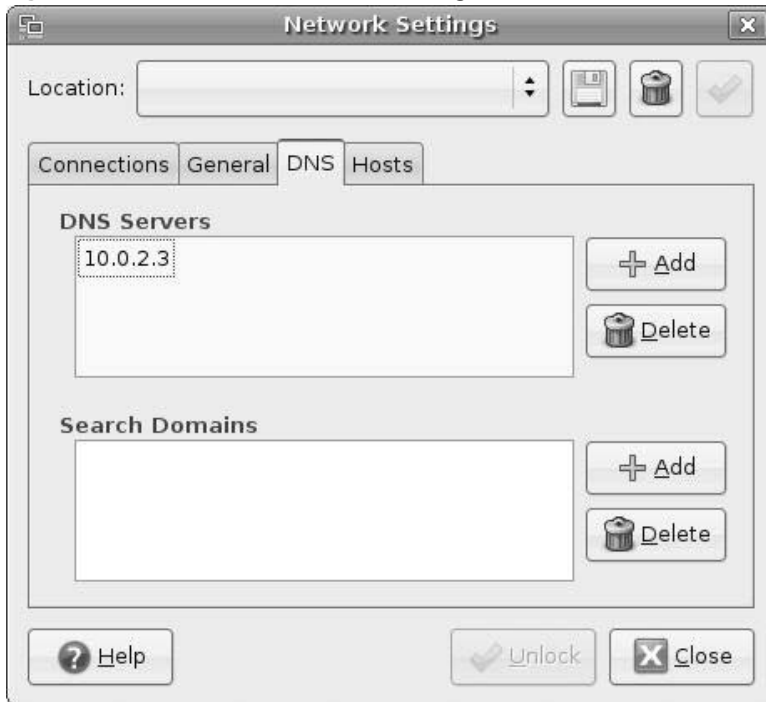

- 8 Click the **Close** button to apply the changes.

Verifying Settings

Check your TCP/IP properties by clicking **System > Administration > Network Tools**, and then selecting the appropriate **Network device** from the **Devices** tab. The **Interface Statistics** column shows data if your connection is working properly.

Figure 143 Ubuntu 8: Network Tools

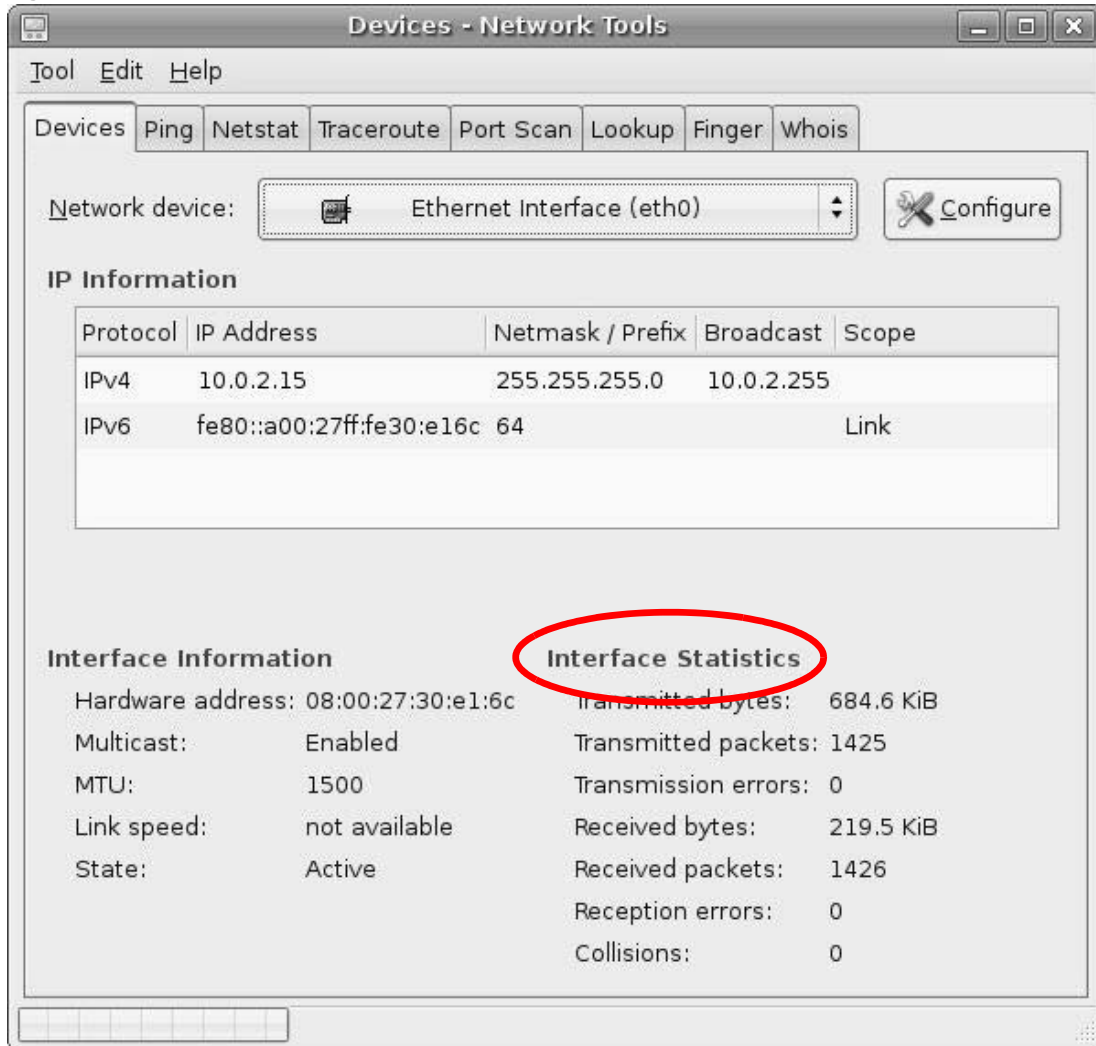

Linux: openSUSE 10.3 (KDE)

This section shows you how to configure your computer's TCP/IP settings in the K Desktop Environment (KDE) using the openSUSE 10.3 Linux distribution. The procedure, screens and file locations may vary depending on your specific distribution, release version, and individual configuration. The following screens use the default openSUSE 10.3 installation.

Note: Make sure you are logged in as the root administrator.

Follow the steps below to configure your computer IP address in the KDE:

- 1 Click **K Menu > Computer > Administrator Settings (YaST)**.

Figure 144 openSUSE 10.3: K Menu > Computer Menu

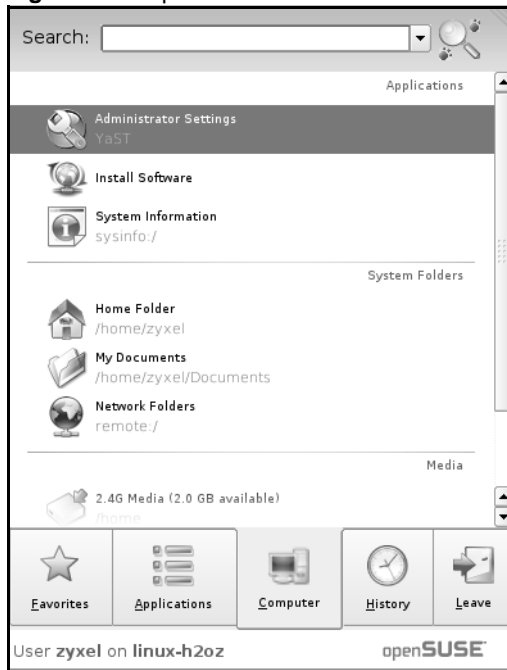

- 2 When the **Run as Root - KDE su** dialog opens, enter the admin password and click **OK**.

Figure 145 openSUSE 10.3: K Menu > Computer Menu

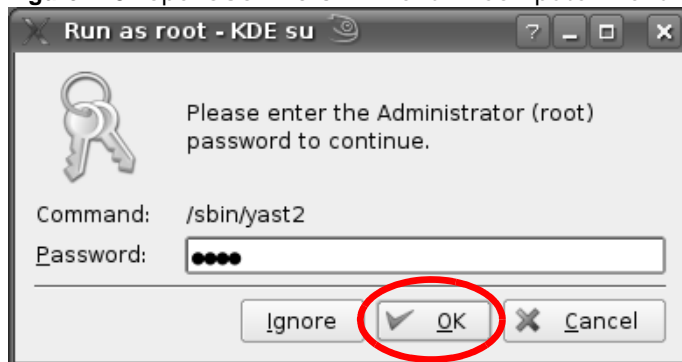

- When the **YaST Control Center** window opens, select **Network Devices** and then click the **Network Card** icon.

Figure 146 openSUSE 10.3: YaST Control Center

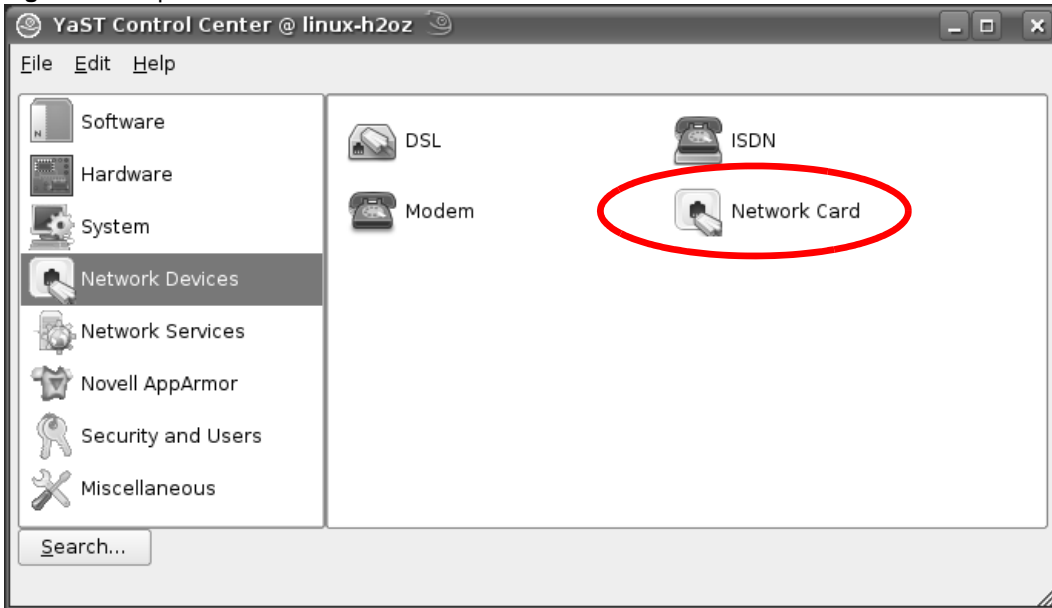

- When the **Network Settings** window opens, click the **Overview** tab, select the appropriate connection **Name** from the list, and then click the **Configure** button.

Figure 147 openSUSE 10.3: Network Settings

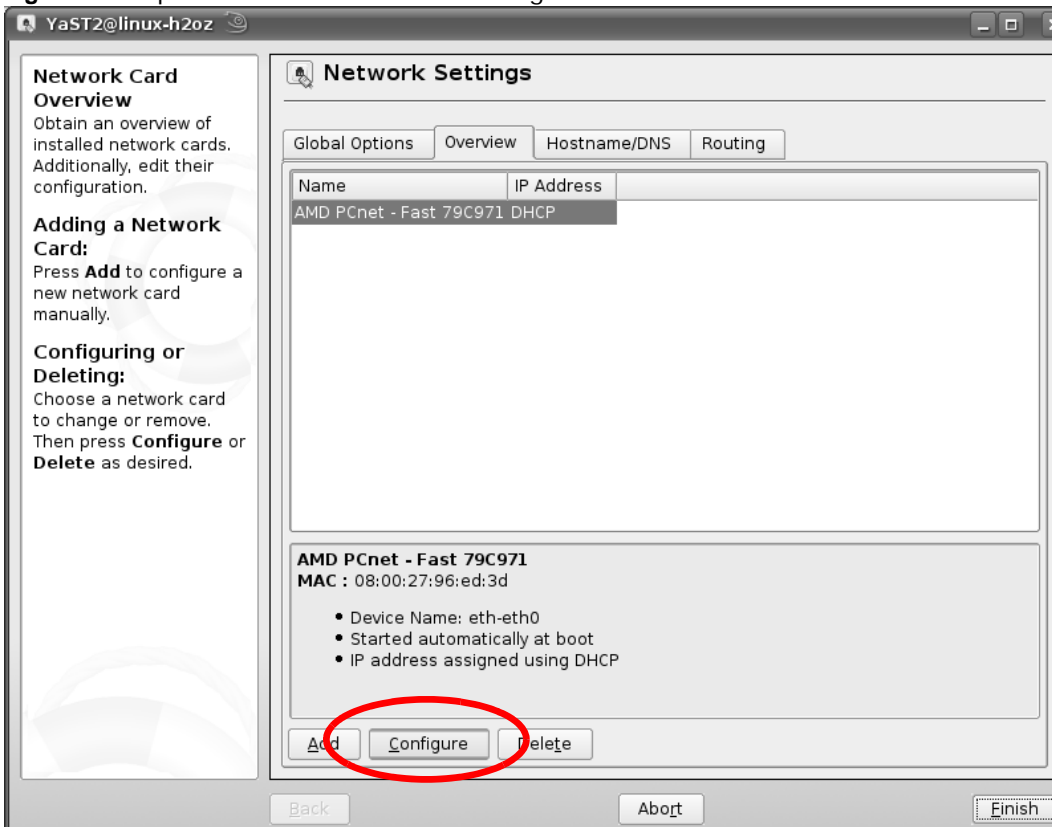

- 5 When the **Network Card Setup** window opens, click the **Address** tab

Figure 148 openSUSE 10.3: Network Card Setup

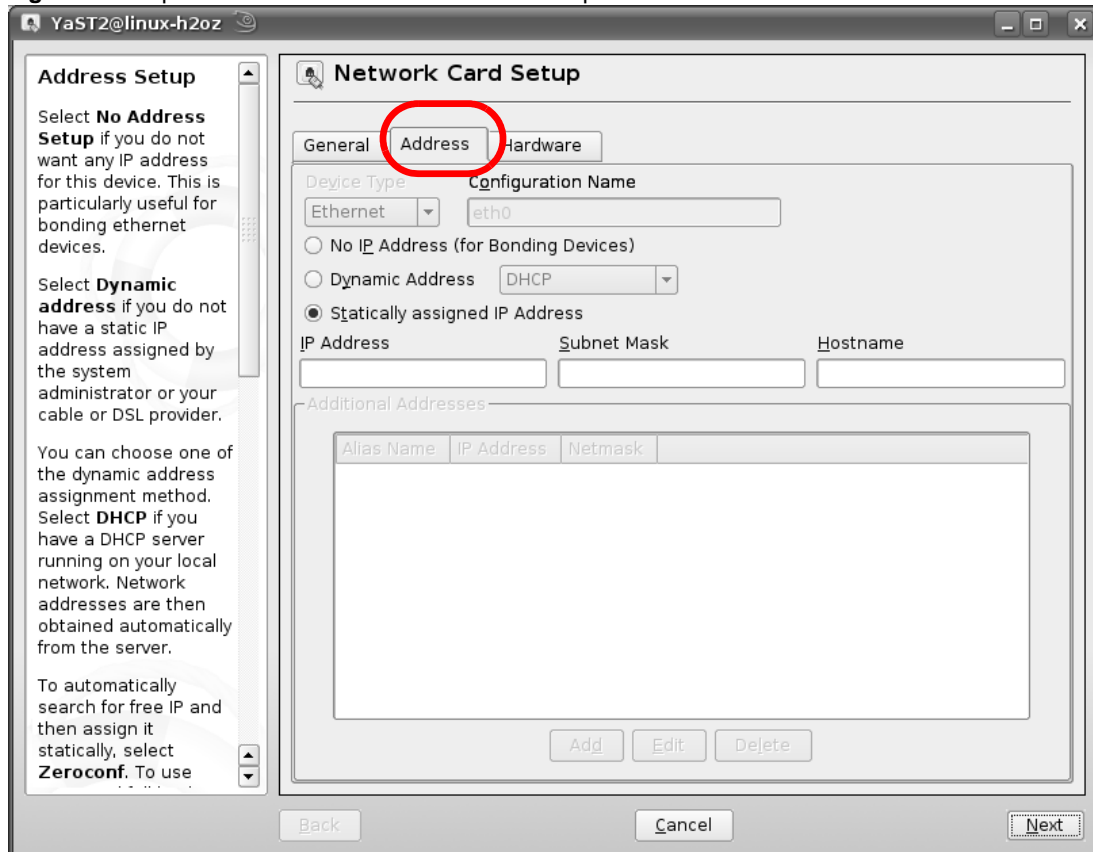

- 6 Select **Dynamic Address (DHCP)** if you have a dynamic IP address.
Select **Statically assigned IP Address** if you have a static IP address. Fill in the **IP address**, **Subnet mask**, and **Hostname** fields.
- 7 Click **Next** to save the changes and close the **Network Card Setup** window.

- 8 If you know your DNS server IP address(es), click the **Hostname/DNS** tab in **Network Settings** and then enter the DNS server information in the fields provided.

Figure 149 openSUSE 10.3: Network Settings

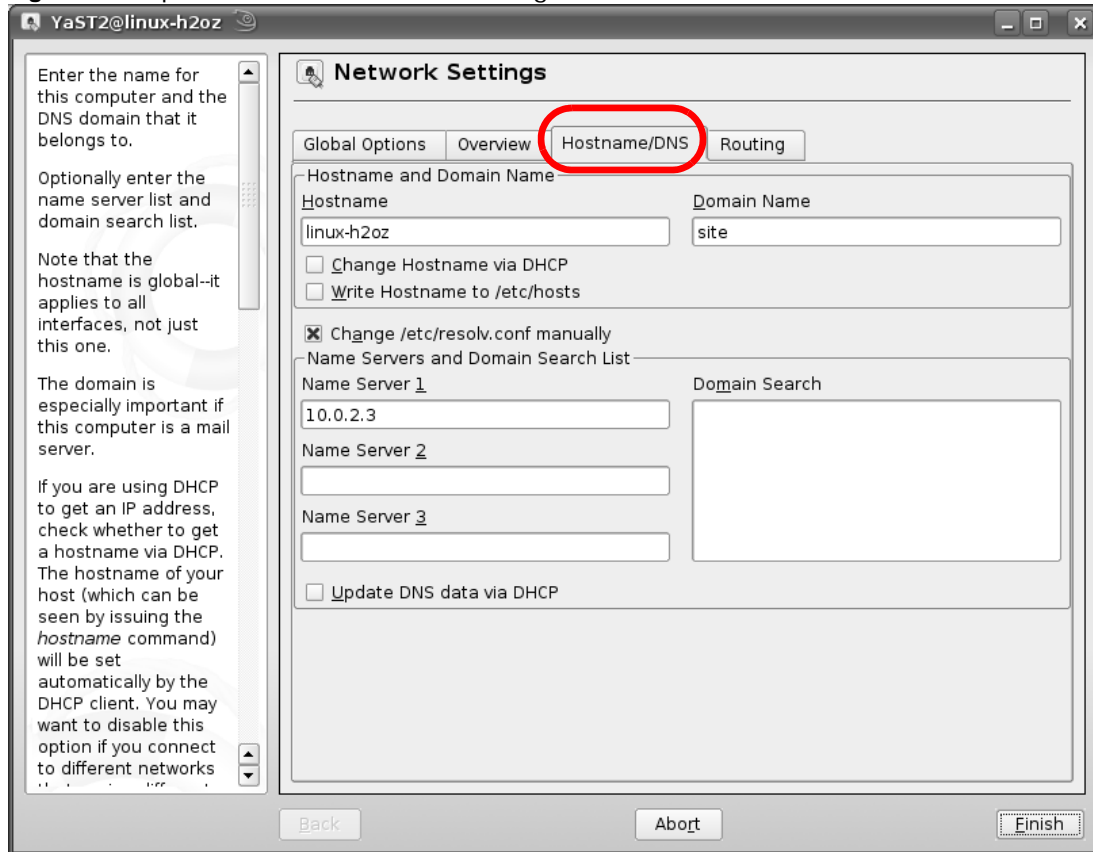

- 9 Click **Finish** to save your settings and close the window.

Verifying Settings

Click the **KNetwork Manager** icon on the **Task bar** to check your TCP/IP properties. From the **Options** sub-menu, select **Show Connection Information**.

Figure 150 openSUSE 10.3: KNetwork Manager

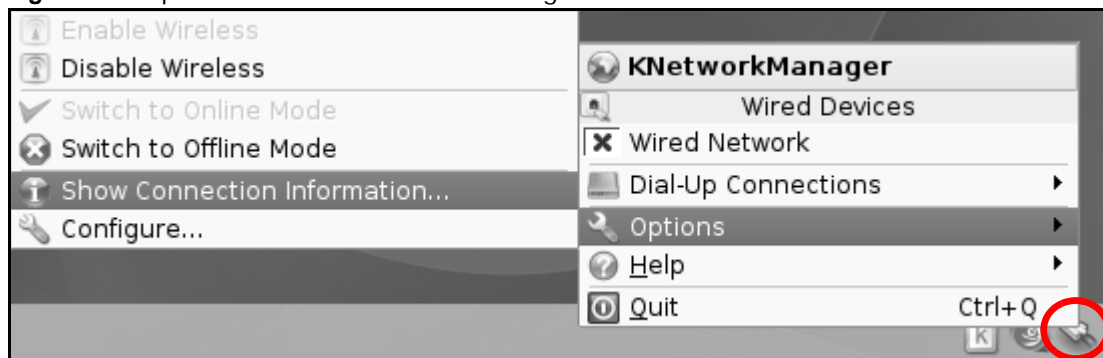

When the **Connection Status - KNetwork Manager** window opens, click the **Statistics** tab to see if your connection is working properly.

Figure 151 openSUSE: Connection Status - KNetwork Manager

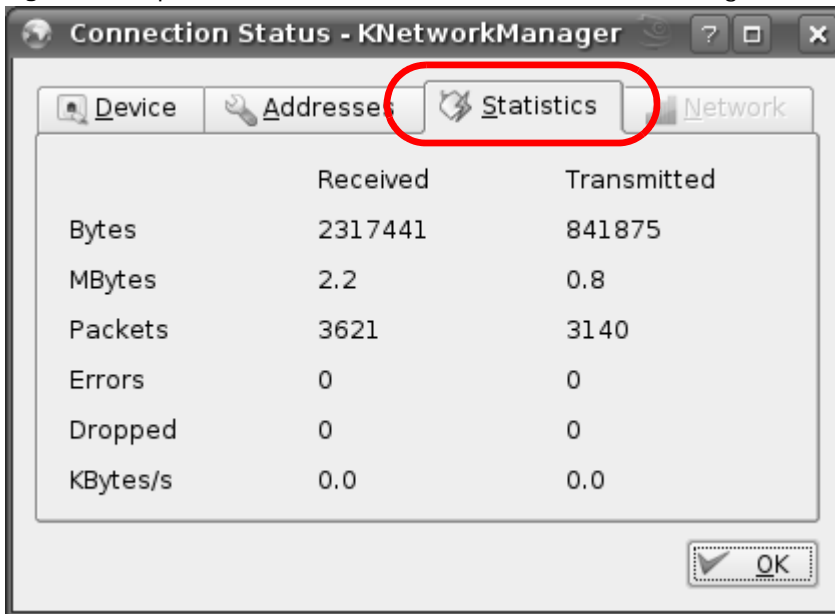

Pop-up Windows, JavaScript and Java Permissions

In order to use the web configurator you need to allow:

- Web browser pop-up windows from your device.
- JavaScript (enabled by default).
- Java permissions (enabled by default).

Note: Internet Explorer 6 screens are used here. Screens for other Internet Explorer versions may vary.

Internet Explorer Pop-up Blockers

You may have to disable pop-up blocking to log into your device.

Either disable pop-up blocking (enabled by default in Windows XP SP (Service Pack) 2) or allow pop-up blocking and create an exception for your device's IP address.

Disable Pop-up Blockers

- 1 In Internet Explorer, select **Tools**, **Pop-up Blocker** and then select **Turn Off Pop-up Blocker**.

Figure 152 Pop-up Blocker

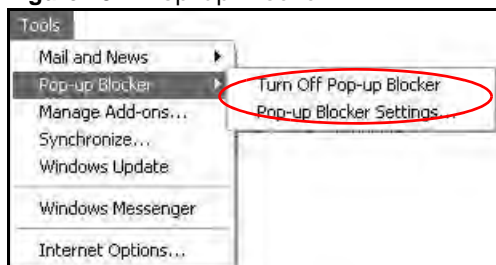

You can also check if pop-up blocking is disabled in the **Pop-up Blocker** section in the **Privacy** tab.

- 1 In Internet Explorer, select **Tools**, **Internet Options**, **Privacy**.

- 2 Clear the **Block pop-ups** check box in the **Pop-up Blocker** section of the screen. This disables any web pop-up blockers you may have enabled.

Figure 153 Internet Options: Privacy



- 3 Click **Apply** to save this setting.

Enable Pop-up Blockers with Exceptions

Alternatively, if you only want to allow pop-up windows from your device, see the following steps.

- 1 In Internet Explorer, select **Tools**, **Internet Options** and then the **Privacy** tab.

- 2 Select **Settings...** to open the **Pop-up Blocker Settings** screen.

Figure 154 Internet Options: Privacy

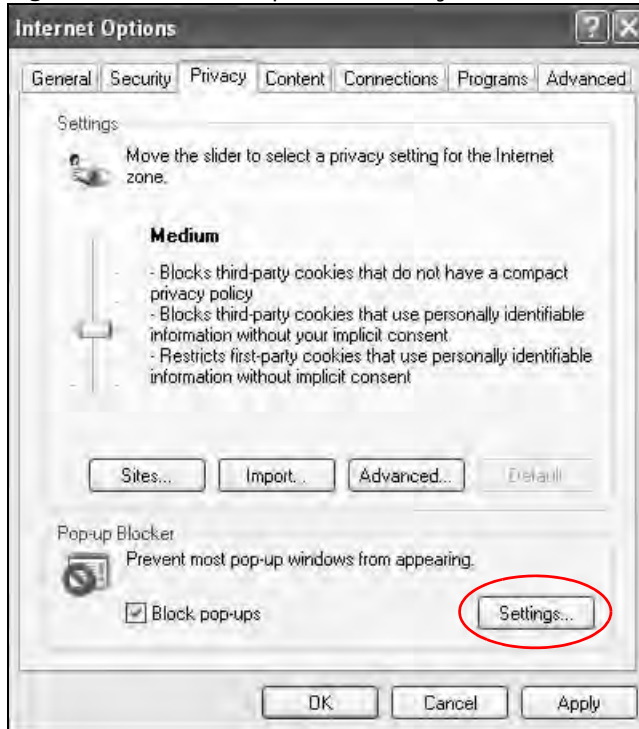

- 3 Type the IP address of your device (the web page that you do not want to have blocked) with the prefix "http://". For example, http://192.168.167.1.

- 4 Click **Add** to move the IP address to the list of **Allowed sites**.

Figure 155 Pop-up Blocker Settings

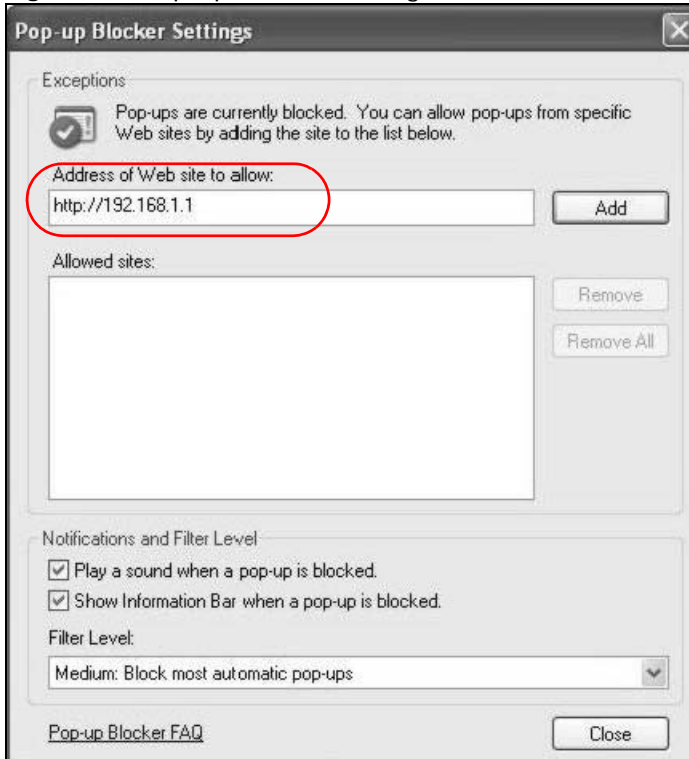

- 5 Click **Close** to return to the **Privacy** screen.
- 6 Click **Apply** to save this setting.

JavaScript

If pages of the web configurator do not display properly in Internet Explorer, check that JavaScript are allowed.

- 1 In Internet Explorer, click **Tools, Internet Options** and then the **Security** tab.

Figure 156 Internet Options: Security

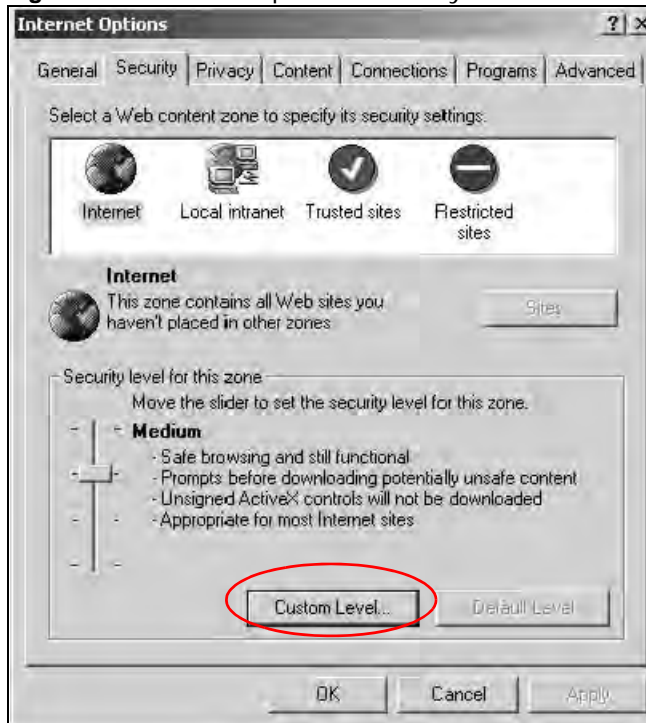

- 2 Click the **Custom Level...** button.
- 3 Scroll down to **Scripting**.
- 4 Under **Active scripting** make sure that **Enable** is selected (the default).
- 5 Under **Scripting of Java applets** make sure that **Enable** is selected (the default).

- 6 Click **OK** to close the window.

Figure 157 Security Settings - Java Scripting

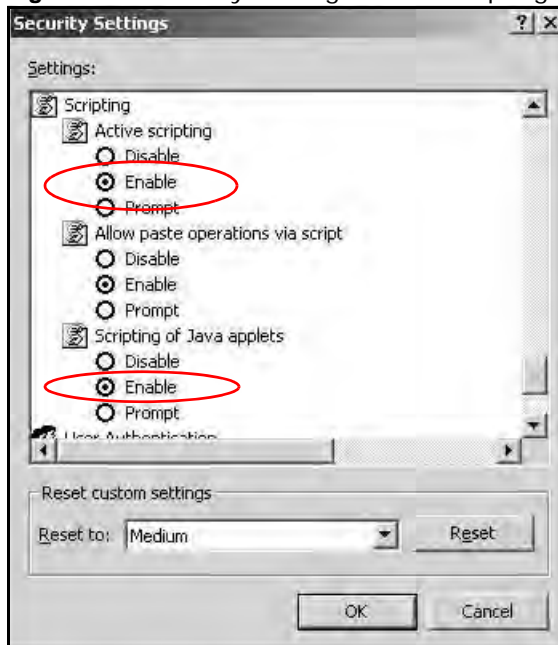

Java Permissions

- 1 From Internet Explorer, click **Tools, Internet Options** and then the **Security** tab.
- 2 Click the **Custom Level...** button.
- 3 Scroll down to **Microsoft VM**.
- 4 Under **Java permissions** make sure that a safety level is selected.

- 5 Click **OK** to close the window.

Figure 158 Security Settings - Java

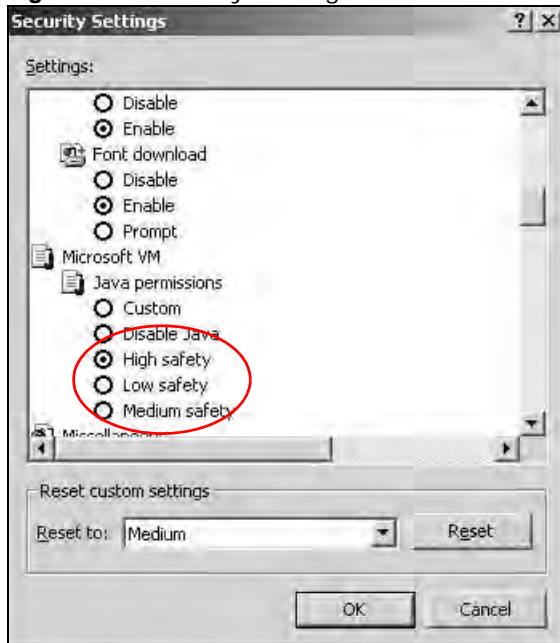

JAVA (Sun)

- 1 From Internet Explorer, click **Tools, Internet Options** and then the **Advanced** tab.
- 2 Make sure that **Use Java 2 for <applet>** under **Java (Sun)** is selected.

- 3 Click **OK** to close the window.

Figure 159 Java (Sun)

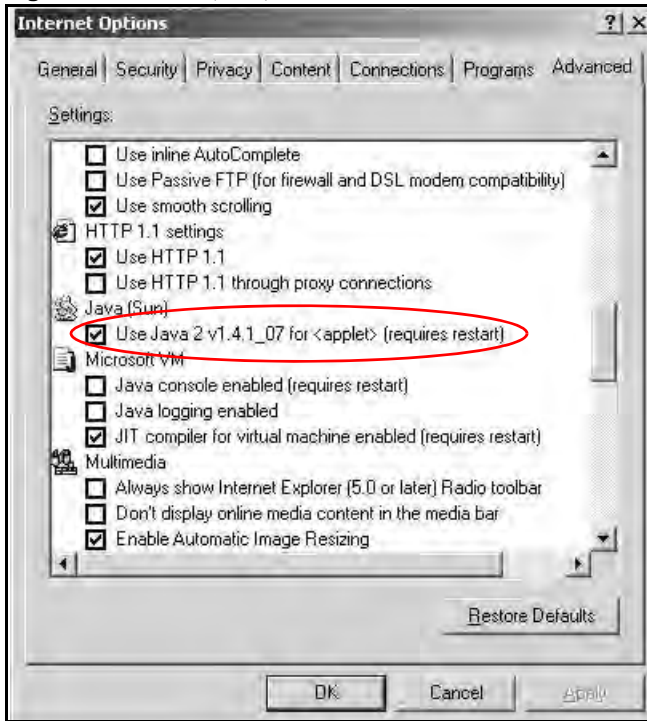

Mozilla Firefox

Mozilla Firefox 2.0 screens are used here. Screens for other versions may vary.

You can enable Java, JavaScript and pop-ups in one screen. Click **Tools**, then click **Options** in the screen that appears.

Figure 160 Mozilla Firefox: Tools > Options

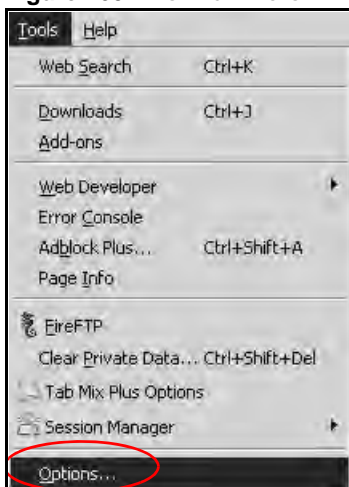

Click **Content** to show the screen below. Select the check boxes as shown in the following screen.

Figure 161 Mozilla Firefox Content Security

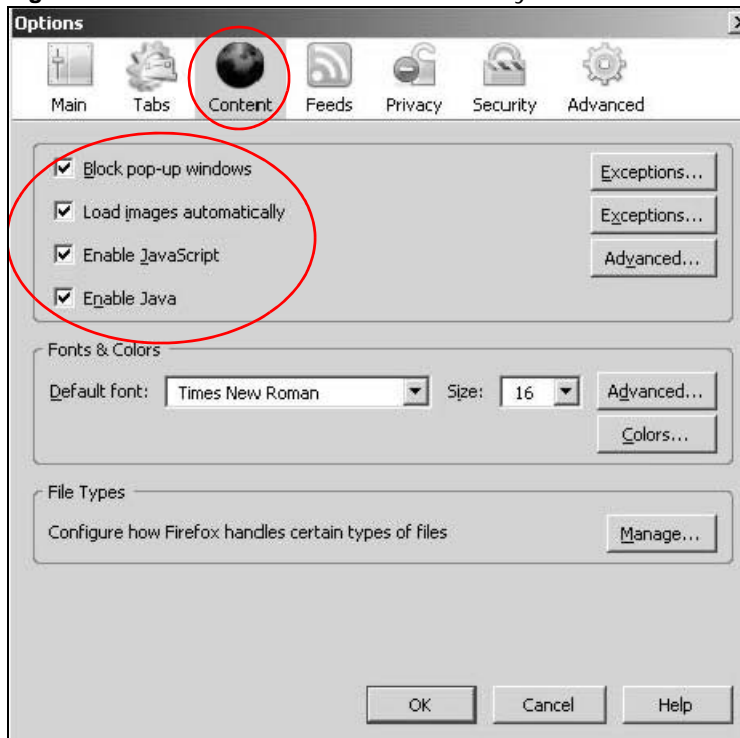

Wireless LANs

Wireless LAN Topologies

This section discusses ad-hoc and infrastructure wireless LAN topologies.

Ad-hoc Wireless LAN Configuration

The simplest WLAN configuration is an independent (Ad-hoc) WLAN that connects a set of computers with wireless adapters (A, B, C). Any time two or more wireless adapters are within range of each other, they can set up an independent network, which is commonly referred to as an ad-hoc network or Independent Basic Service Set (IBSS). The following diagram shows an example of notebook computers using wireless adapters to form an ad-hoc wireless LAN.

Figure 162 Peer-to-Peer Communication in an Ad-hoc Network

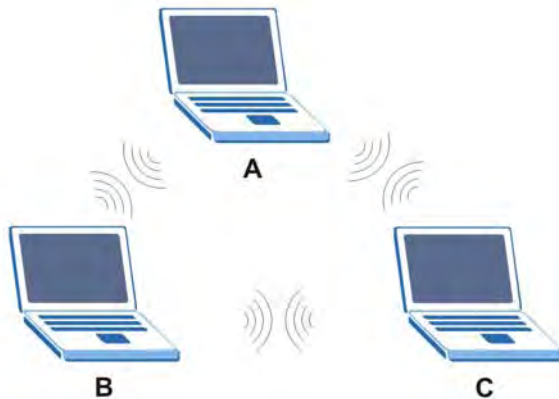

BSS

A Basic Service Set (BSS) exists when all communications between wireless clients or between a wireless client and a wired network client go through one access point (AP).

Intra-BSS traffic is traffic between wireless clients in the BSS. When Intra-BSS is enabled, wireless client **A** and **B** can access the wired network and communicate with each other. When Intra-BSS is

disabled, wireless client **A** and **B** can still access the wired network but cannot communicate with each other.

Figure 163 Basic Service Set

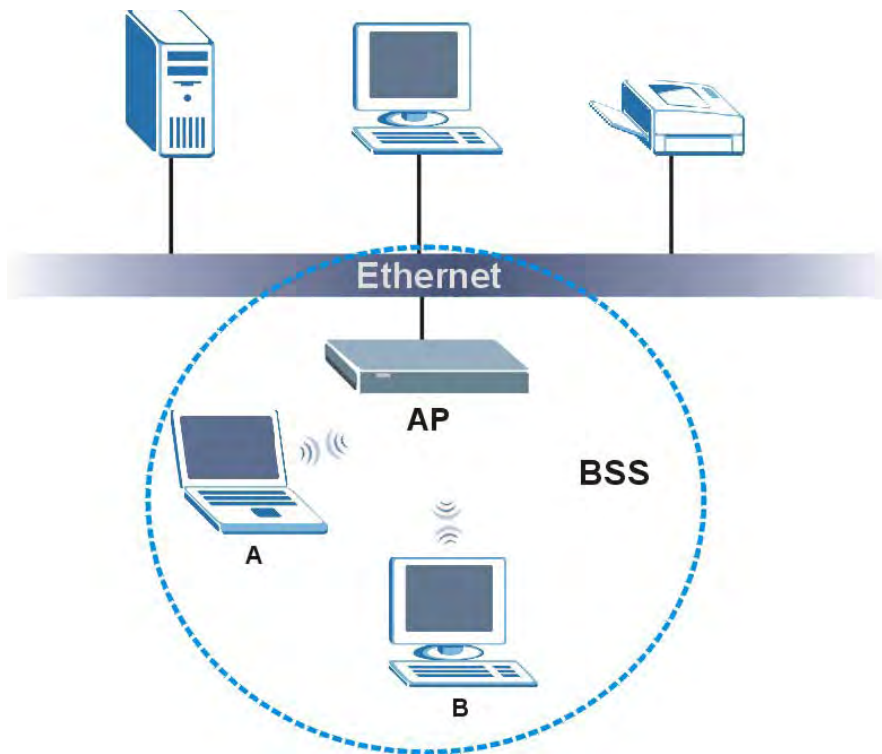

ESS

An Extended Service Set (ESS) consists of a series of overlapping BSSs, each containing an access point, with each access point connected together by a wired network. This wired connection between APs is called a Distribution System (DS).

This type of wireless LAN topology is called an Infrastructure WLAN. The Access Points not only provide communication with the wired network but also mediate wireless network traffic in the immediate neighborhood.

An ESSID (ESS IDentification) uniquely identifies each ESS. All access points and their associated wireless clients within the same ESS must have the same ESSID in order to communicate.

Figure 164 Infrastructure WLAN

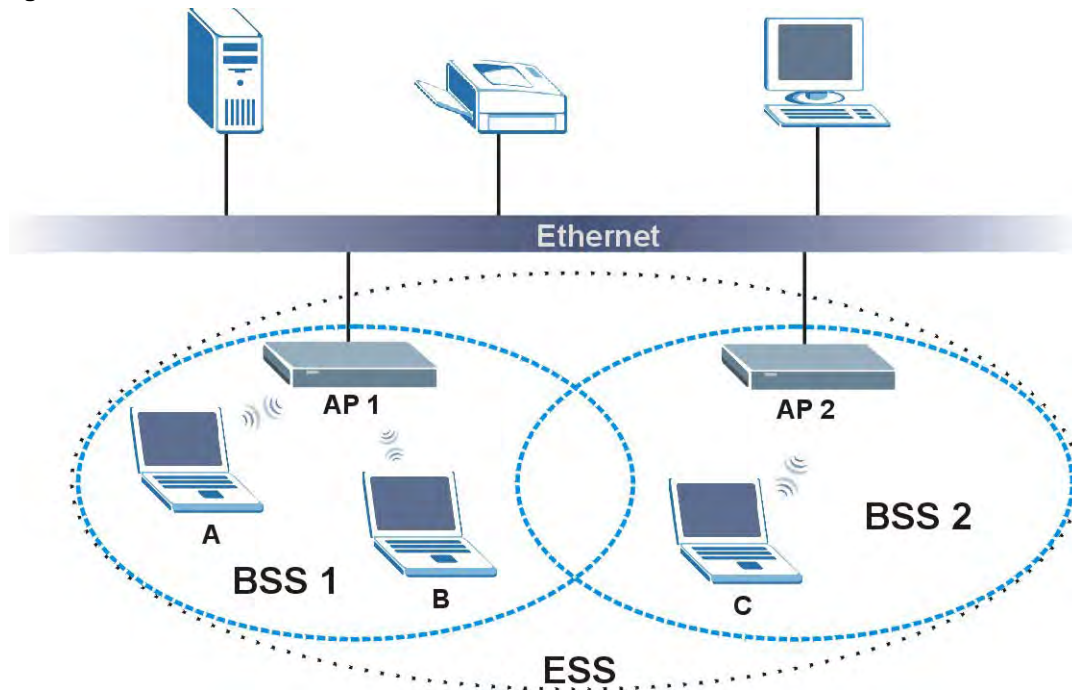

Channel

A channel is the radio frequency(ies) used by wireless devices to transmit and receive data. Channels available depend on your geographical area. You may have a choice of channels (for your region) so you should use a channel different from an adjacent AP (access point) to reduce interference. Interference occurs when radio signals from different access points overlap causing interference and degrading performance.

Adjacent channels partially overlap however. To avoid interference due to overlap, your AP should be on a channel at least five channels away from a channel that an adjacent AP is using. For example, if your region has 11 channels and an adjacent AP is using channel 1, then you need to select a channel between 6 or 11.

RTS/CTS

A hidden node occurs when two stations are within range of the same access point, but are not within range of each other. The following figure illustrates a hidden node. Both stations (STA) are within range of the access point (AP) or wireless gateway, but out-of-range of each other, so they

cannot "hear" each other, that is they do not know if the channel is currently being used. Therefore, they are considered hidden from each other.

Figure 165 RTS/CTS

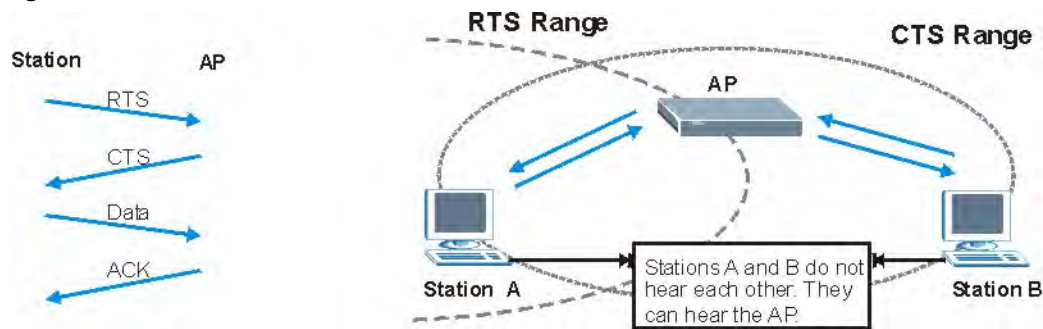

When station **A** sends data to the AP, it might not know that the station **B** is already using the channel. If these two stations send data at the same time, collisions may occur when both sets of data arrive at the AP at the same time, resulting in a loss of messages for both stations.

RTS/CTS is designed to prevent collisions due to hidden nodes. An **RTS/CTS** defines the biggest size data frame you can send before an RTS (Request To Send)/CTS (Clear to Send) handshake is invoked.

When a data frame exceeds the **RTS/CTS** value you set (between 0 to 2432 bytes), the station that wants to transmit this frame must first send an RTS (Request To Send) message to the AP for permission to send it. The AP then responds with a CTS (Clear to Send) message to all other stations within its range to notify them to defer their transmission. It also reserves and confirms with the requesting station the time frame for the requested transmission.

Stations can send frames smaller than the specified **RTS/CTS** directly to the AP without the RTS (Request To Send)/CTS (Clear to Send) handshake.

You should only configure **RTS/CTS** if the possibility of hidden nodes exists on your network and the "cost" of resending large frames is more than the extra network overhead involved in the RTS (Request To Send)/CTS (Clear to Send) handshake.

If the **RTS/CTS** value is greater than the **Fragmentation Threshold** value (see next), then the RTS (Request To Send)/CTS (Clear to Send) handshake will never occur as data frames will be fragmented before they reach **RTS/CTS** size.

Note: Enabling the RTS Threshold causes redundant network overhead that could negatively affect the throughput performance instead of providing a remedy.

Fragmentation Threshold

A **Fragmentation Threshold** is the maximum data fragment size (between 256 and 2432 bytes) that can be sent in the wireless network before the AP will fragment the packet into smaller data frames.

A large **Fragmentation Threshold** is recommended for networks not prone to interference while you should set a smaller threshold for busy networks or networks that are prone to interference.

If the **Fragmentation Threshold** value is smaller than the **RTS/CTS** value (see previously) you set then the RTS (Request To Send)/CTS (Clear to Send) handshake will never occur as data frames will be fragmented before they reach **RTS/CTS** size.

Preamble Type

Preamble is used to signal that data is coming to the receiver. Short and long refer to the length of the synchronization field in a packet.

Short preamble increases performance as less time sending preamble means more time for sending data. All IEEE 802.11 compliant wireless adapters support long preamble, but not all support short preamble.

Use long preamble if you are unsure what preamble mode other wireless devices on the network support, and to provide more reliable communications in busy wireless networks.

Use short preamble if you are sure all wireless devices on the network support it, and to provide more efficient communications.

Use the dynamic setting to automatically use short preamble when all wireless devices on the network support it, otherwise the LTE Device uses long preamble.

Note: The wireless devices **MUST** use the same preamble mode in order to communicate.

IEEE 802.11g Wireless LAN

IEEE 802.11g is fully compatible with the IEEE 802.11b standard. This means an IEEE 802.11b adapter can interface directly with an IEEE 802.11g access point (and vice versa) at 11 Mbps or lower depending on range. IEEE 802.11g has several intermediate rate steps between the maximum and minimum data rates. The IEEE 802.11g data rate and modulation are as follows:

Table 85 IEEE 802.11g

DATA RATE (MBPS)	MODULATION
1	DBPSK (Differential Binary Phase Shift Keyed)
2	DQPSK (Differential Quadrature Phase Shift Keying)
5.5 / 11	CCK (Complementary Code Keying)
6/9/12/18/24/36/48/ 54	OFDM (Orthogonal Frequency Division Multiplexing)

Wireless Security Overview

Wireless security is vital to your network to protect wireless communication between wireless clients, access points and the wired network.

Wireless security methods available on the LTE Device are data encryption, wireless client authentication, restricting access by device MAC address and hiding the LTE Device identity.

The following figure shows the relative effectiveness of these wireless security methods available on your LTE Device.

Table 86 Wireless Security Levels

SECURITY LEVEL	SECURITY TYPE
Least Secure	Unique SSID (Default)
	Unique SSID with Hide SSID Enabled
	MAC Address Filtering
	WEP Encryption
	IEEE802.1x EAP with RADIUS Server Authentication
	Wi-Fi Protected Access (WPA)
Most Secure	WPA2

Note: You must enable the same wireless security settings on the LTE Device and on all wireless clients that you want to associate with it.

IEEE 802.1x

In June 2001, the IEEE 802.1x standard was designed to extend the features of IEEE 802.11 to support extended authentication as well as providing additional accounting and control features. It is supported by Windows XP and a number of network devices. Some advantages of IEEE 802.1x are:

- User based identification that allows for roaming.
- Support for RADIUS (Remote Authentication Dial In User Service, RFC 2138, 2139) for centralized user profile and accounting management on a network RADIUS server.
- Support for EAP (Extensible Authentication Protocol, RFC 2486) that allows additional authentication methods to be deployed with no changes to the access point or the wireless clients.

RADIUS

RADIUS is based on a client-server model that supports authentication, authorization and accounting. The access point is the client and the server is the RADIUS server. The RADIUS server handles the following tasks:

- Authentication
Determines the identity of the users.
- Authorization
Determines the network services available to authenticated users once they are connected to the network.
- Accounting
Keeps track of the client's network activity.

RADIUS is a simple package exchange in which your AP acts as a message relay between the wireless client and the network RADIUS server.

Types of RADIUS Messages

The following types of RADIUS messages are exchanged between the access point and the RADIUS server for user authentication:

- Access-Request
Sent by an access point requesting authentication.
- Access-Reject
Sent by a RADIUS server rejecting access.
- Access-Accept
Sent by a RADIUS server allowing access.
- Access-Challenge
Sent by a RADIUS server requesting more information in order to allow access. The access point sends a proper response from the user and then sends another Access-Request message.

The following types of RADIUS messages are exchanged between the access point and the RADIUS server for user accounting:

- Accounting-Request
Sent by the access point requesting accounting.
- Accounting-Response
Sent by the RADIUS server to indicate that it has started or stopped accounting.

In order to ensure network security, the access point and the RADIUS server use a shared secret key, which is a password, they both know. The key is not sent over the network. In addition to the shared key, password information exchanged is also encrypted to protect the network from unauthorized access.

Types of EAP Authentication

This section discusses some popular authentication types: EAP-MD5, EAP-TLS, EAP-TTLS, PEAP and LEAP. Your wireless LAN device may not support all authentication types.

EAP (Extensible Authentication Protocol) is an authentication protocol that runs on top of the IEEE 802.1x transport mechanism in order to support multiple types of user authentication. By using EAP to interact with an EAP-compatible RADIUS server, an access point helps a wireless station and a RADIUS server perform authentication.

The type of authentication you use depends on the RADIUS server and an intermediary AP(s) that supports IEEE 802.1x.

For EAP-TLS authentication type, you must first have a wired connection to the network and obtain the certificate(s) from a certificate authority (CA). A certificate (also called digital IDs) can be used to authenticate users and a CA issues certificates and guarantees the identity of each certificate owner.

EAP-MD5 (Message-Digest Algorithm 5)

MD5 authentication is the simplest one-way authentication method. The authentication server sends a challenge to the wireless client. The wireless client 'proves' that it knows the password by encrypting the password with the challenge and sends back the information. Password is not sent in plain text.

However, MD5 authentication has some weaknesses. Since the authentication server needs to get the plaintext passwords, the passwords must be stored. Thus someone other than the authentication server may access the password file. In addition, it is possible to impersonate an authentication server as MD5 authentication method does not perform mutual authentication. Finally, MD5 authentication method does not support data encryption with dynamic session key. You must configure WEP encryption keys for data encryption.

EAP-TLS (Transport Layer Security)

With EAP-TLS, digital certifications are needed by both the server and the wireless clients for mutual authentication. The server presents a certificate to the client. After validating the identity of the server, the client sends a different certificate to the server. The exchange of certificates is done in the open before a secured tunnel is created. This makes user identity vulnerable to passive attacks. A digital certificate is an electronic ID card that authenticates the sender's identity. However, to implement EAP-TLS, you need a Certificate Authority (CA) to handle certificates, which imposes a management overhead.

EAP-TTLS (Tunneled Transport Layer Service)

EAP-TTLS is an extension of the EAP-TLS authentication that uses certificates for only the server-side authentications to establish a secure connection. Client authentication is then done by sending username and password through the secure connection, thus client identity is protected. For client authentication, EAP-TTLS supports EAP methods and legacy authentication methods such as PAP, CHAP, MS-CHAP and MS-CHAP v2.

PEAP (Protected EAP)

Like EAP-TTLS, server-side certificate authentication is used to establish a secure connection, then use simple username and password methods through the secured connection to authenticate the clients, thus hiding client identity. However, PEAP only supports EAP methods, such as EAP-MD5, EAP-MSCHAPv2 and EAP-GTC (EAP-Generic Token Card), for client authentication. EAP-GTC is implemented only by Cisco.

LEAP

LEAP (Lightweight Extensible Authentication Protocol) is a Cisco implementation of IEEE 802.1x.

Dynamic WEP Key Exchange

The AP maps a unique key that is generated with the RADIUS server. This key expires when the wireless connection times out, disconnects or reauthentication times out. A new WEP key is generated each time reauthentication is performed.

If this feature is enabled, it is not necessary to configure a default encryption key in the wireless security configuration screen. You may still configure and store keys, but they will not be used while dynamic WEP is enabled.

Note: EAP-MD5 cannot be used with Dynamic WEP Key Exchange

For added security, certificate-based authentications (EAP-TLS, EAP-TTLS and PEAP) use dynamic keys for data encryption. They are often deployed in corporate environments, but for public deployment, a simple user name and password pair is more practical. The following table is a comparison of the features of authentication types.

Table 87 Comparison of EAP Authentication Types

	EAP-MD5	EAP-TLS	EAP-TTLS	PEAP	LEAP
Mutual Authentication	No	Yes	Yes	Yes	Yes
Certificate – Client	No	Yes	Optional	Optional	No
Certificate – Server	No	Yes	Yes	Yes	No
Dynamic Key Exchange	No	Yes	Yes	Yes	Yes
Credential Integrity	None	Strong	Strong	Strong	Moderate
Deployment Difficulty	Easy	Hard	Moderate	Moderate	Moderate
Client Identity Protection	No	No	Yes	Yes	No

WPA and WPA2

Wi-Fi Protected Access (WPA) is a subset of the IEEE 802.11i standard. WPA2 (IEEE 802.11i) is a wireless security standard that defines stronger encryption, authentication and key management than WPA.

Key differences between WPA or WPA2 and WEP are improved data encryption and user authentication.

If both an AP and the wireless clients support WPA2 and you have an external RADIUS server, use WPA2 for stronger data encryption. If you don't have an external RADIUS server, you should use WPA2-PSK (WPA2-Pre-Shared Key) that only requires a single (identical) password entered into each access point, wireless gateway and wireless client. As long as the passwords match, a wireless client will be granted access to a WLAN.

If the AP or the wireless clients do not support WPA2, just use WPA or WPA-PSK depending on whether you have an external RADIUS server or not.

Select WEP only when the AP and/or wireless clients do not support WPA or WPA2. WEP is less secure than WPA or WPA2.

Encryption

Both WPA and WPA2 improve data encryption by using Temporal Key Integrity Protocol (TKIP), Message Integrity Check (MIC) and IEEE 802.1x. WPA and WPA2 use Advanced Encryption Standard (AES) in the Counter mode with Cipher block chaining Message authentication code Protocol (CCMP) to offer stronger encryption than TKIP.

TKIP uses 128-bit keys that are dynamically generated and distributed by the authentication server. AES (Advanced Encryption Standard) is a block cipher that uses a 256-bit mathematical algorithm

called Rijndael. They both include a per-packet key mixing function, a Message Integrity Check (MIC) named Michael, an extended initialization vector (IV) with sequencing rules, and a re-keying mechanism.

WPA and WPA2 regularly change and rotate the encryption keys so that the same encryption key is never used twice.

The RADIUS server distributes a Pairwise Master Key (PMK) key to the AP that then sets up a key hierarchy and management system, using the PMK to dynamically generate unique data encryption keys to encrypt every data packet that is wirelessly communicated between the AP and the wireless clients. This all happens in the background automatically.

The Message Integrity Check (MIC) is designed to prevent an attacker from capturing data packets, altering them and resending them. The MIC provides a strong mathematical function in which the receiver and the transmitter each compute and then compare the MIC. If they do not match, it is assumed that the data has been tampered with and the packet is dropped.

By generating unique data encryption keys for every data packet and by creating an integrity checking mechanism (MIC), with TKIP and AES it is more difficult to decrypt data on a Wi-Fi network than WEP and difficult for an intruder to break into the network.

The encryption mechanisms used for WPA(2) and WPA(2)-PSK are the same. The only difference between the two is that WPA(2)-PSK uses a simple common password, instead of user-specific credentials. The common-password approach makes WPA(2)-PSK susceptible to brute-force password-guessing attacks but it's still an improvement over WEP as it employs a consistent, single, alphanumeric password to derive a PMK which is used to generate unique temporal encryption keys. This prevents all wireless devices sharing the same encryption keys. (a weakness of WEP)

User Authentication

WPA and WPA2 apply IEEE 802.1x and Extensible Authentication Protocol (EAP) to authenticate wireless clients using an external RADIUS database. WPA2 reduces the number of key exchange messages from six to four (CCMP 4-way handshake) and shortens the time required to connect to a network. Other WPA2 authentication features that are different from WPA include key caching and pre-authentication. These two features are optional and may not be supported in all wireless devices.

Key caching allows a wireless client to store the PMK it derived through a successful authentication with an AP. The wireless client uses the PMK when it tries to connect to the same AP and does not need to go through the authentication process again.

Pre-authentication enables fast roaming by allowing the wireless client (already connecting to an AP) to perform IEEE 802.1x authentication with another AP before connecting to it.

Wireless Client WPA Supplicants

A wireless client supplicant is the software that runs on an operating system instructing the wireless client how to use WPA. At the time of writing, the most widely available supplicant is the WPA patch for Windows XP, Funk Software's Odyssey client.

The Windows XP patch is a free download that adds WPA capability to Windows XP's built-in "Zero Configuration" wireless client. However, you must run Windows XP to use it.

WPA(2) with RADIUS Application Example

To set up WPA(2), you need the IP address of the RADIUS server, its port number (default is 1812), and the RADIUS shared secret. A WPA(2) application example with an external RADIUS server looks as follows. "A" is the RADIUS server. "DS" is the distribution system.

- 1 The AP passes the wireless client's authentication request to the RADIUS server.
- 2 The RADIUS server then checks the user's identification against its database and grants or denies network access accordingly.
- 3 A 256-bit Pairwise Master Key (PMK) is derived from the authentication process by the RADIUS server and the client.
- 4 The RADIUS server distributes the PMK to the AP. The AP then sets up a key hierarchy and management system, using the PMK to dynamically generate unique data encryption keys. The keys are used to encrypt every data packet that is wirelessly communicated between the AP and the wireless clients.

Figure 166 WPA(2) with RADIUS Application Example

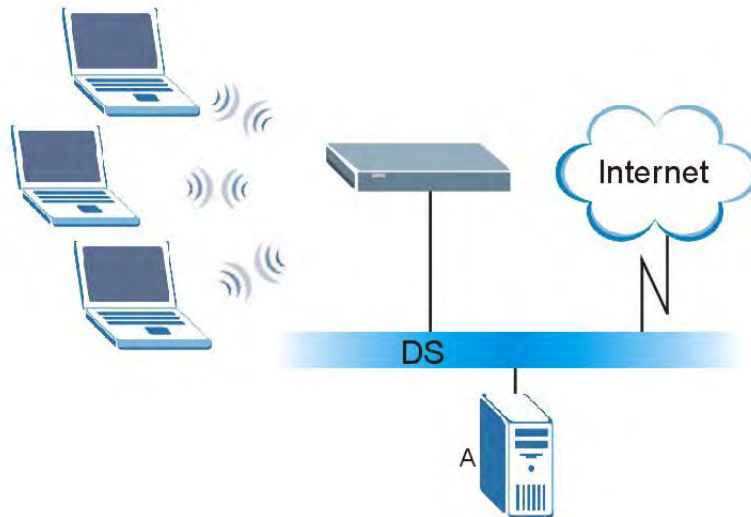

WPA(2)-PSK Application Example

A WPA(2)-PSK application looks as follows.

- 1 First enter identical passwords into the AP and all wireless clients. The Pre-Shared Key (PSK) must consist of between 8 and 63 ASCII characters or 64 hexadecimal characters (including spaces and symbols).
- 2 The AP checks each wireless client's password and allows it to join the network only if the password matches.
- 3 The AP and wireless clients generate a common PMK (Pairwise Master Key). The key itself is not sent over the network, but is derived from the PSK and the SSID.

- The AP and wireless clients use the TKIP or AES encryption process, the PMK and information exchanged in a handshake to create temporal encryption keys. They use these keys to encrypt data exchanged between them.

Figure 167 WPA(2)-PSK Authentication

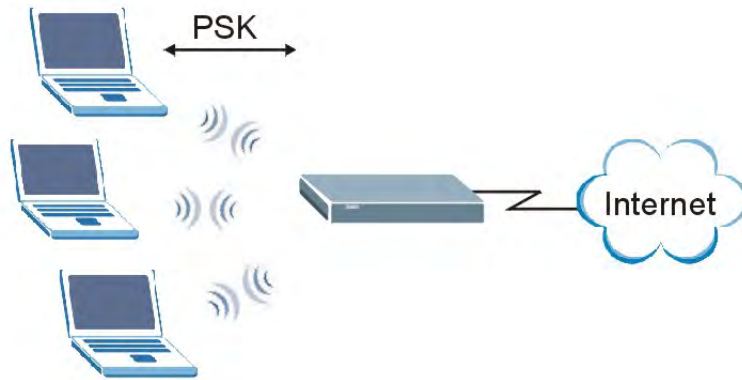

Security Parameters Summary

Refer to this table to see what other security parameters you should configure for each authentication method or key management protocol type. MAC address filters are not dependent on how you configure these security features.

Table 88 Wireless Security Relational Matrix

AUTHENTICATION METHOD/ KEY MANAGEMENT PROTOCOL	ENCRYPTION METHOD	ENTER MANUAL KEY	IEEE 802.1X
Open	None	No	Disable
			Enable without Dynamic WEP Key
Open	WEP	No	Enable with Dynamic WEP Key
		Yes	Enable without Dynamic WEP Key
		Yes	Disable
Shared	WEP	No	Enable with Dynamic WEP Key
		Yes	Enable without Dynamic WEP Key
		Yes	Disable
WPA	TKIP/AES	No	Enable
WPA-PSK	TKIP/AES	Yes	Disable
WPA2	TKIP/AES	No	Enable
WPA2-PSK	TKIP/AES	Yes	Disable

Antenna Overview

An antenna couples RF signals onto air. A transmitter within a wireless device sends an RF signal to the antenna, which propagates the signal through the air. The antenna also operates in reverse by capturing RF signals from the air.

Positioning the antennas properly increases the range and coverage area of a wireless LAN.

Antenna Characteristics

Frequency

An antenna in the frequency of 2.4GHz (IEEE 802.11b and IEEE 802.11g) or 5GHz (IEEE 802.11a) is needed to communicate efficiently in a wireless LAN

Radiation Pattern

A radiation pattern is a diagram that allows you to visualize the shape of the antenna's coverage area.

Antenna Gain

Antenna gain, measured in dB (decibel), is the increase in coverage within the RF beam width. Higher antenna gain improves the range of the signal for better communications.

For an indoor site, each 1 dB increase in antenna gain results in a range increase of approximately 2.5%. For an unobstructed outdoor site, each 1dB increase in gain results in a range increase of approximately 5%. Actual results may vary depending on the network environment.

Antenna gain is sometimes specified in dBi, which is how much the antenna increases the signal power compared to using an isotropic antenna. An isotropic antenna is a theoretical perfect antenna that sends out radio signals equally well in all directions. dBi represents the true gain that the antenna provides.

Types of Antennas for WLAN

There are two types of antennas used for wireless LAN applications.

- Omni-directional antennas send the RF signal out in all directions on a horizontal plane. The coverage area is torus-shaped (like a donut) which makes these antennas ideal for a room environment. With a wide coverage area, it is possible to make circular overlapping coverage areas with multiple access points.
- Directional antennas concentrate the RF signal in a beam, like a flashlight does with the light from its bulb. The angle of the beam determines the width of the coverage pattern. Angles typically range from 20 degrees (very directional) to 120 degrees (less directional). Directional antennas are ideal for hallways and outdoor point-to-point applications.

Positioning Antennas

In general, antennas should be mounted as high as practically possible and free of obstructions. In point-to-point application, position both antennas at the same height and in a direct line of sight to each other to attain the best performance.

For omni-directional antennas mounted on a table, desk, and so on, point the antenna up. For omni-directional antennas mounted on a wall or ceiling, point the antenna down. For a single AP application, place omni-directional antennas as close to the center of the coverage area as possible.

For directional antennas, point the antenna in the direction of the desired coverage area.

WiFi Protected Setup

Your LTE Device supports WiFi Protected Setup (WPS), which is an easy way to set up a secure wireless network. WPS is an industry standard specification, defined by the WiFi Alliance.

WPS allows you to quickly set up a wireless network with strong security, without having to configure security settings manually. Each WPS connection works between two devices. Both devices must support WPS (check each device's documentation to make sure).

Depending on the devices you have, you can either press a button (on the device itself, or in its configuration utility) or enter a PIN (a unique Personal Identification Number that allows one device to authenticate the other) in each of the two devices. When WPS is activated on a device, it has two minutes to find another device that also has WPS activated. Then, the two devices connect and set up a secure network by themselves.

Push Button Configuration

WPS Push Button Configuration (PBC) is initiated by pressing a button on each WPS-enabled device, and allowing them to connect automatically. You do not need to enter any information.

Not every WPS-enabled device has a physical WPS button. Some may have a WPS PBC button in their configuration utilities instead of or in addition to the physical button.

Take the following steps to set up WPS using the button.

- 1 Ensure that the two devices you want to set up are within wireless range of one another.
- 2 Look for a WPS button on each device. If the device does not have one, log into its configuration utility and locate the button (see the device's User's Guide for how to do this - for the LTE Device, see [Section 5.4 on page 53](#)).
- 3 Press the button on one of the devices (it doesn't matter which).
- 4 Within two minutes, press the button on the other device. The registrar sends the network name (SSID) and security key through an secure connection to the enrollee.

If you need to make sure that WPS worked, check the list of associated wireless clients in the AP's configuration utility. If you see the wireless client in the list, WPS was successful.

PIN Configuration

Each WPS-enabled device has its own PIN (Personal Identification Number). This may either be static (it cannot be changed) or dynamic (you can change it to a new random number by clicking on a button in the configuration interface).

When you use the PIN method, you must enter the enrollee's PIN into the registrar. Then, when WPS is activated on the enrollee, it presents its PIN to the registrar. If the PIN matches, the registrar sends the network and security information to the enrollee, allowing it to join the network.

The advantage of using the PIN method rather than the PBC method is that you can ensure that the connection is established between the devices you specify, not just the first two devices to activate WPS in the area. However, you need to log into the configuration interfaces of both devices.

Take the following steps to set up WPS using the PIN method.

- 1** Decide which device you want to be the registrar (usually the AP) and which you want to be the enrollee (usually the client).
- 2** Look for the enrollee's WPS PIN; it may be displayed on the device. If you don't see it, log into the enrollee's configuration interface and locate the PIN. Select the PIN connection mode (not PBC connection mode). See the device's User's Guide for how to do this - for the LTE Device, see [Section 5.4 on page 53](#).
- 3** Log into the configuration utility of the registrar. Select the PIN connection mode (not the PBC connection mode). Locate the place where you can enter the enrollee's PIN (if you are using the LTE Device, see [Section 5.4 on page 53](#)). Enter the PIN from the enrollee device.
- 4** Activate WPS on both devices within two minutes.

Note: Use the configuration utility to activate WPS, not the push-button on the device itself.

- 5** On a computer connected to the wireless client, try to connect to the Internet. If you can connect, WPS was successful.
If you cannot connect, check the list of associated wireless clients in the AP's configuration utility. If you see the wireless client in the list, WPS was successful.

The following figure shows a WPS-enabled wireless client (installed in a notebook computer) connecting to the WPS-enabled AP via the PIN method.

Figure 168 Example WPS Process: PIN Method

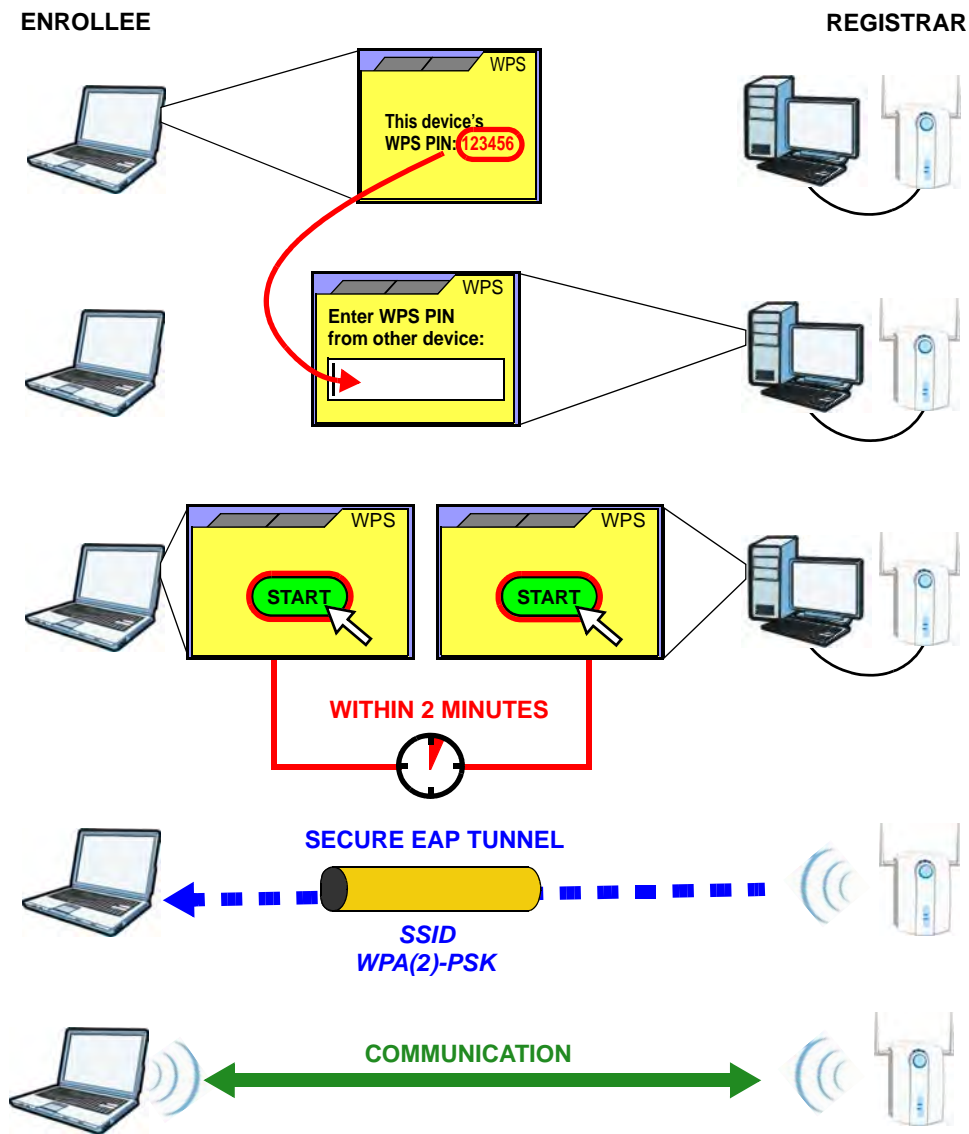

How WPS Works

When two WPS-enabled devices connect, each device must assume a specific role. One device acts as the registrar (the device that supplies network and security settings) and the other device acts as the enrollee (the device that receives network and security settings). The registrar creates a secure EAP (Extensible Authentication Protocol) tunnel and sends the network name (SSID) and the WPA-PSK or WPA2-PSK pre-shared key to the enrollee. Whether WPA-PSK or WPA2-PSK is used depends on the standards supported by the devices. If the registrar is already part of a network, it sends the existing information. If not, it generates the SSID and WPA(2)-PSK randomly.

The following figure shows a WPS-enabled client (installed in a notebook computer) connecting to a WPS-enabled access point.

Figure 169 How WPS works

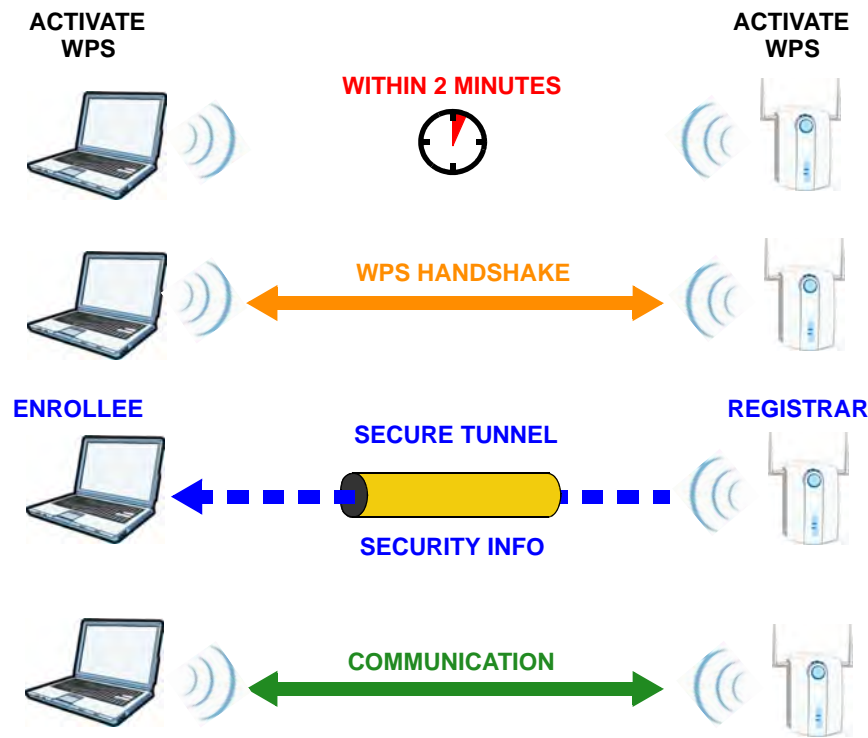

The roles of registrar and enrollee last only as long as the WPS setup process is active (two minutes). The next time you use WPS, a different device can be the registrar if necessary.

The WPS connection process is like a handshake; only two devices participate in each WPS transaction. If you want to add more devices you should repeat the process with one of the existing networked devices and the new device.

Note that the access point (AP) is not always the registrar, and the wireless client is not always the enrollee. All WPS-certified APs can be a registrar, and so can some WPS-enabled wireless clients.

By default, a WPS device is “unconfigured”. This means that it is not part of an existing network and can act as either enrollee or registrar (if it supports both functions). If the registrar is unconfigured, the security settings it transmits to the enrollee are randomly-generated. Once a WPS-enabled device has connected to another device using WPS, it becomes “configured”. A configured wireless client can still act as enrollee or registrar in subsequent WPS connections, but a configured access point can no longer act as enrollee. It will be the registrar in all subsequent WPS connections in which it is involved. If you want a configured AP to act as an enrollee, you must reset it to its factory defaults.

Example WPS Network Setup

This section shows how security settings are distributed in an example WPS setup.

The following figure shows an example network. In step **1**, both **AP1** and **Client 1** are unconfigured. When WPS is activated on both, they perform the handshake. In this example, **AP1**

is the registrar, and **Client 1** is the enrollee. The registrar randomly generates the security information to set up the network, since it is unconfigured and has no existing information.

Figure 170 WPS: Example Network Step 1

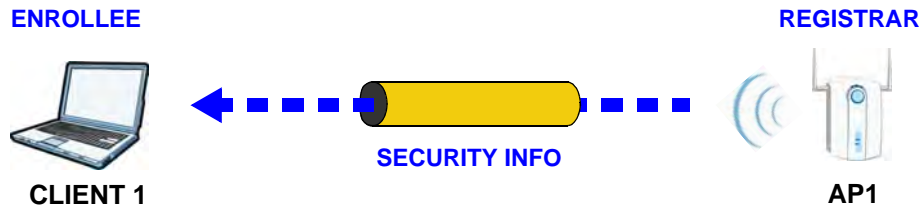

In step 2, you add another wireless client to the network. You know that **Client 1** supports registrar mode, but it is better to use **AP1** for the WPS handshake with the new client since you must connect to the access point anyway in order to use the network. In this case, **AP1** must be the registrar, since it is configured (it already has security information for the network). **AP1** supplies the existing security information to **Client 2**.

Figure 171 WPS: Example Network Step 2

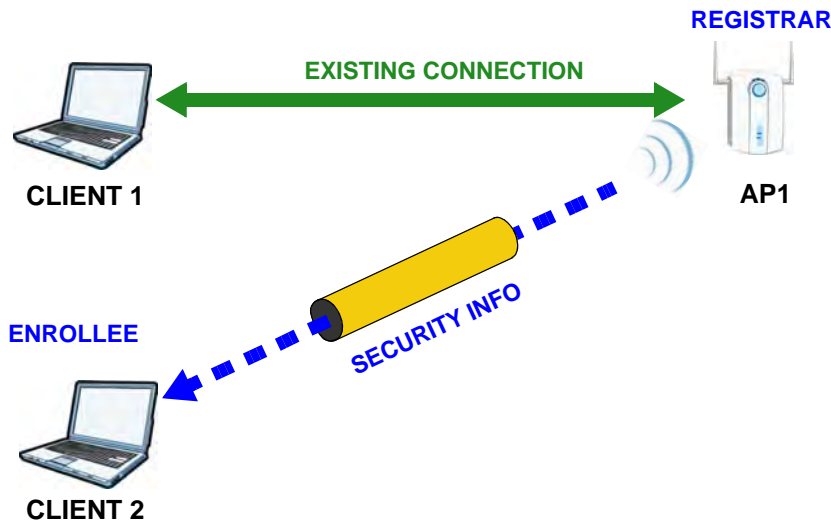

In step 3, you add another access point (**AP2**) to your network. **AP2** is out of range of **AP1**, so you cannot use **AP1** for the WPS handshake with the new access point. However, you know that **Client 2** supports the registrar function, so you use it to perform the WPS handshake instead.

Figure 172 WPS: Example Network Step 3

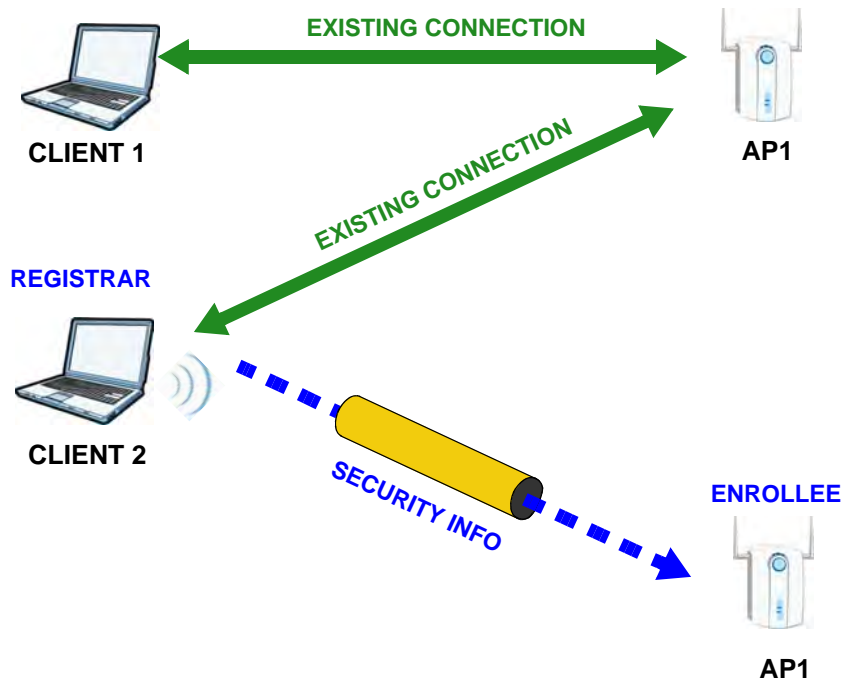

Limitations of WPS

WPS has some limitations of which you should be aware.

- WPS works in Infrastructure networks only (where an AP and a wireless client communicate). It does not work in Ad-Hoc networks (where there is no AP).
- When you use WPS, it works between two devices only. You cannot enroll multiple devices simultaneously, you must enroll one after the other.

For instance, if you have two enrollees and one registrar you must set up the first enrollee (by pressing the WPS button on the registrar and the first enrollee, for example), then check that it successfully enrolled, then set up the second device in the same way.

- WPS works only with other WPS-enabled devices. However, you can still add non-WPS devices to a network you already set up using WPS.

WPS works by automatically issuing a randomly-generated WPA-PSK or WPA2-PSK pre-shared key from the registrar device to the enrollee devices. Whether the network uses WPA-PSK or WPA2-PSK depends on the device. You can check the configuration interface of the registrar device to discover the key the network is using (if the device supports this feature). Then, you can enter the key into the non-WPS device and join the network as normal (the non-WPS device must also support WPA-PSK or WPA2-PSK).

- When you use the PBC method, there is a short period (from the moment you press the button on one device to the moment you press the button on the other device) when any WPS-enabled device could join the network. This is because the registrar has no way of identifying the "correct" enrollee, and cannot differentiate between your enrollee and a rogue device. This is a possible way for a hacker to gain access to a network.

You can easily check to see if this has happened. WPS works between only two devices simultaneously, so if another device has enrolled your device will be unable to enroll, and will not have access to the network. If this happens, open the access point's configuration interface and look at the list of associated clients (usually displayed by MAC address). It does not matter if the access point is the WPS registrar, the enrollee, or was not involved in the WPS handshake; a rogue device must still associate with the access point to gain access to the network. Check the MAC addresses of your wireless clients (usually printed on a label on the bottom of the device). If there is an unknown MAC address you can remove it or reset the AP.

Common Services

The following table lists some commonly-used services and their associated protocols and port numbers. For a comprehensive list of port numbers, ICMP type/code numbers and services, visit the IANA (Internet Assigned Number Authority) web site.

- **Name:** This is a short, descriptive name for the service. You can use this one or create a different one, if you like.
- **Protocol:** This is the type of IP protocol used by the service. If this is **TCP/UDP**, then the service uses the same port number with TCP and UDP. If this is **USER-DEFINED**, the **Port(s)** is the IP protocol number, not the port number.
- **Port(s):** This value depends on the **Protocol**. Please refer to RFC 1700 for further information about port numbers.
 - If the **Protocol** is **TCP, UDP, or TCP/UDP**, this is the IP port number.
 - If the **Protocol** is **USER**, this is the IP protocol number.
- **Description:** This is a brief explanation of the applications that use this service or the situations in which this service is used.

Table 89 Commonly Used Services

NAME	PROTOCOL	PORT(S)	DESCRIPTION
AH (IPSEC_TUNNEL)	User-Defined	51	The IPSEC AH (Authentication Header) tunneling protocol uses this service.
AIM/New-ICQ	TCP	5190	AOL's Internet Messenger service. It is also used as a listening port by ICQ.
AUTH	TCP	113	Authentication protocol used by some servers.
BGP	TCP	179	Border Gateway Protocol.
BOOTP_CLIENT	UDP	68	DHCP Client.
BOOTP_SERVER	UDP	67	DHCP Server.
CU-SEEME	TCP UDP	7648 24032	A popular videoconferencing solution from White Pines Software.
DNS	TCP/UDP	53	Domain Name Server, a service that matches web names (for example www.example.com) to IP numbers.
ESP (IPSEC_TUNNEL)	User-Defined	50	The IPSEC ESP (Encapsulation Security Protocol) tunneling protocol uses this service.
FINGER	TCP	79	Finger is a UNIX or Internet related command that can be used to find out if a user is logged on.
FTP	TCP TCP	20 21	File Transfer Program, a program to enable fast transfer of files, including large files that may not be possible by e-mail.
H.323	TCP	1720	NetMeeting uses this protocol.
HTTP	TCP	80	Hyper Text Transfer Protocol - a client/server protocol for the world wide web.
HTTPS	TCP	443	HTTPS is a secured http session often used in e-commerce.

Table 89 Commonly Used Services (continued)

NAME	PROTOCOL	PORT(S)	DESCRIPTION
ICMP	User-Defined	1	Internet Control Message Protocol is often used for diagnostic or routing purposes.
ICQ	UDP	4000	This is a popular Internet chat program.
IGMP (MULTICAST)	User-Defined	2	Internet Group Management Protocol is used when sending packets to a specific group of hosts.
IKE	UDP	500	The Internet Key Exchange algorithm is used for key distribution and management.
IRC	TCP/UDP	6667	This is another popular Internet chat program.
MSN Messenger	TCP	1863	Microsoft Networks' messenger service uses this protocol.
NEW-ICQ	TCP	5190	An Internet chat program.
NEWS	TCP	144	A protocol for news groups.
NFS	UDP	2049	Network File System - NFS is a client/server distributed file service that provides transparent file sharing for network environments.
NNTP	TCP	119	Network News Transport Protocol is the delivery mechanism for the USENET newsgroup service.
PING	User-Defined	1	Packet INternet Groper is a protocol that sends out ICMP echo requests to test whether or not a remote host is reachable.
POP3	TCP	110	Post Office Protocol version 3 lets a client computer get e-mail from a POP3 server through a temporary connection (TCP/IP or other).
PPTP	TCP	1723	Point-to-Point Tunneling Protocol enables secure transfer of data over public networks. This is the control channel.
PPTP_TUNNEL (GRE)	User-Defined	47	PPTP (Point-to-Point Tunneling Protocol) enables secure transfer of data over public networks. This is the data channel.
RCMD	TCP	512	Remote Command Service.
REAL_AUDIO	TCP	7070	A streaming audio service that enables real time sound over the web.
REXEC	TCP	514	Remote Execution Daemon.
RLOGIN	TCP	513	Remote Login.
RTELNET	TCP	107	Remote Telnet.
RTSP	TCP/UDP	554	The Real Time Streaming (media control) Protocol (RTSP) is a remote control for multimedia on the Internet.
SFTP	TCP	115	Simple File Transfer Protocol.
SMTP	TCP	25	Simple Mail Transfer Protocol is the message-exchange standard for the Internet. SMTP enables you to move messages from one e-mail server to another.
SNMP	TCP/UDP	161	Simple Network Management Program.
SNMP-TRAPS	TCP/UDP	162	Traps for use with the SNMP (RFC:1215).
SQL-NET	TCP	1521	Structured Query Language is an interface to access data on many different types of database systems, including mainframes, midrange systems, UNIX systems and network servers.
SSH	TCP/UDP	22	Secure Shell Remote Login Program.
STRM WORKS	UDP	1558	Stream Works Protocol.
SYSLOG	UDP	514	Syslog allows you to send system logs to a UNIX server.

Table 89 Commonly Used Services (continued)

NAME	PROTOCOL	PORT(S)	DESCRIPTION
TACACS	UDP	49	Login Host Protocol used for (Terminal Access Controller Access Control System).
TELNET	TCP	23	Telnet is the login and terminal emulation protocol common on the Internet and in UNIX environments. It operates over TCP/IP networks. Its primary function is to allow users to log into remote host systems.
TFTP	UDP	69	Trivial File Transfer Protocol is an Internet file transfer protocol similar to FTP, but uses the UDP (User Datagram Protocol) rather than TCP (Transmission Control Protocol).
VDOLIVE	TCP	7000	Another videoconferencing solution.

Legal Information

L'utilisation de cet équipement (2.4GHz wireless LAN) est soumise à certaines restrictions: cet équipement peut être utilisé à l'intérieur d'un bâtiment en utilisant toutes les fréquences de 2400 à 2483.5MHz (Chaîne 1-13). Pour une utilisation en environnement extérieur, les fréquences comprises entre 2400-2454 MHz peuvent être utilisées. Pour les dernières restrictions, voir <http://www.art-telecom.fr>.

For 2.4-GHz wireless LAN operation of this product, certain restrictions apply. This equipment may use the entire-2400-MHz to 2483.5-MHz frequency band (channels 1 through 13) for indoor applications. For outdoor use, only 2400-2454 MHz frequency band may be used. For the latest requirements, see <http://www.art-telecom.fr>.

CE 0682 ①

Certifications (Class B)

Federal Communications Commission (FCC) Interference Statement

The device complies with Part 15 of FCC rules. Operation is subject to the following two conditions:

- This device may not cause harmful interference.
- This device must accept any interference received, including interference that may cause undesired operations.

This device has been tested and found to comply with the limits for a Class B digital device pursuant to Part 15 of the FCC Rules. These limits are designed to provide reasonable protection against harmful interference in a residential installation. This device generates, uses, and can radiate radio frequency energy, and if not installed and used in accordance with the instructions, may cause harmful interference to radio communications. However, there is no guarantee that interference will not occur in a particular installation.

If this device does cause harmful interference to radio/television reception, which can be determined by turning the device off and on, the user is encouraged to try to correct the interference by one or more of the following measures:

- 1 Reorient or relocate the receiving antenna.
- 2 Increase the separation between the equipment and the receiver.
- 3 Connect the equipment into an outlet on a circuit different from that to which the receiver is connected.
- 4 Consult the dealer or an experienced radio/TV technician for help.

FCC Caution: Any changes or modifications not expressly approved by the party responsible for compliance could void the user's authority to operate this equipment.



FCC Radiation Exposure Statement

The ODU must be fixed-mounted on outdoor permanent structures to satisfy RF exposure requirements.

- This device meets the government's requirements for exposure to radio waves.
- This device is designed and manufactured not to exceed the emission limits for exposure to radio frequency (RF) energy set by the Federal Communications Commission of the U.S. Government.
- This device complies with FCC radiation exposure limits set forth for an uncontrolled environment. In order to avoid the possibility of exceeding the FCC radio frequency exposure limits, human proximity to the indoor device (IDU) antenna shall not be less than 20cm; to the outdoor device (ODU) antenna shall not be less than 35cm during normal operation.
- This transmitter must not be co-located or operating in conjunction with any other antenna or transmitter.
- IEEE 802.11b, 802.11g or 802.11n(20MHz) operation of this product in the U.S.A. is firmware-limited to channels 1 through 11. IEEE 802.11n(40MHz) operation of this product in the U.S.A. is firmware-limited to channels 3 through 9.
- IEEE 802.11b or 802.11g operation of this product in the U.S.A. is firmware-limited to channels 1 through 11.

注意！

依據 低功率電波輻射性電機管理辦法
第十二條 經型式認證合格之低功率射頻電機，非經許可，公司、商號或使用
者均不得擅自變更頻率、加大功率或變更原設計之特性及功能。

第十四條 低功率射頻電機之使用不得影響飛航安全及干擾合法通信；經發現
有干擾現象時，應立即停用，並改善至無干擾時方得繼續使用。
前項合法通信，指依電信規定作業之無線電信。低功率射頻電機須忍
受合法通信或工業、科學及醫療用電波輻射性電機設備之干擾。

本機限在不干擾合法電臺與不受被干擾保障條件下於室內使用。
減少電磁波影響，請妥適使用。

Notices

Changes or modifications not expressly approved by the party responsible for compliance could void the user's authority to operate the equipment.

This device is designed for the WLAN 2.4 GHz and/or 5 GHz networks throughout the EC region and Switzerland, with restrictions in France.

Ce produit est conçu pour les bandes de fréquences 2,4 GHz et/ou 5 GHz conformément à la législation Européenne. En France métropolitaine, suivant les décisions n°03-908 et 03-909 de l'ARCEP, la puissance d'émission ne devra pas dépasser 10 mW (10 dB) dans le cadre d'une installation WiFi en extérieur pour les fréquences comprises entre 2454 MHz et 2483,5 MHz.

This Class B digital apparatus complies with Canadian ICES-003.

Cet appareil numérique de la classe B est conforme à la norme NMB-003 du Canada.

Safety Warnings

- Do NOT use this product near water, for example, in a wet basement or near a swimming pool.
- Do NOT expose your device to dampness, dust or corrosive liquids.
- Do NOT store things on the device.
- Do NOT install, use, or service this device during a thunderstorm. There is a remote risk of electric shock from lightning.
- Connect ONLY suitable accessories to the device.
- Do NOT open the device or unit. Opening or removing covers can expose you to dangerous high voltage points or other risks. ONLY qualified service personnel should service or disassemble this device. Please contact your vendor for further information.
- Make sure to connect the cables to the correct ports.
- Place connecting cables carefully so that no one will step on them or stumble over them.
- Always disconnect all cables from this device before servicing or disassembling.
- Use ONLY an appropriate power adaptor or cord for your device.
- Connect the power adaptor or cord to the right supply voltage (for example, 110V AC in North America or 230V AC in Europe).
- Do NOT remove the plug and connect it to a power outlet by itself; always attach the plug to the power adaptor first before connecting it to a power outlet.
- Do NOT allow anything to rest on the power adaptor or cord and do NOT place the product where anyone can walk on the power adaptor or cord.
- Do NOT use the device if the power adaptor or cord is damaged as it might cause electrocution.
- If the power adaptor or cord is damaged, remove it from the device and the power source.
- Do NOT attempt to repair the power adaptor or cord. Contact your local vendor to order a new one.
- Do not use the indoor device (IDU) outside, and make sure all the connections are indoors. There is a remote risk of electric shock from lightning.
- Do NOT obstruct the device ventilation slots, as insufficient airflow may harm your device.
- Use only No. 26 AWG (American Wire Gauge) or larger telecommunication line cord.
- If you wall mount your device, make sure that no electrical lines, gas or water pipes will be damaged.

Your product is marked with this symbol, which is known as the WEEE mark. WEEE stands for Waste Electronics and Electrical Equipment. It means that used electrical and electronic products should not be mixed with general waste. Used electrical and electronic equipment should be treated separately.



Index

A

ACK message [140](#)

activation

- SSID [52](#)
- wireless LAN
 - scheduling [57](#)

administrator password [21](#)

Advanced Encryption Standard, see AES

AES [237](#)

alternative subnet mask notation [182](#)

antenna

- directional [241](#)
- gain [241](#)
- omni-directional [241](#)

AP (Access Point) [231](#)

applications

- Internet access [15](#)
- VoIP [16](#)

authentication [58, 59](#)

- RADIUS server [59](#)

automatic logout [21](#)

B

backup

- configuration [167](#)

bandwidth management [83](#)

Basic Service Set, see BSS

blinking LEDs [18](#)

Broadband [35](#)

BSS [61, 229](#)

- example [61](#)

BYE request [140](#)

C

CA [236](#)

call hold [142](#)

call rule [134](#)

call service mode [142](#)

call transfer [143](#)

call waiting [143](#)

CAPWAP [36, 38](#)

Certificate Authority, see CA

certifications [253](#)

- notices [254](#)

channel [231](#)

- interference [231](#)

channel scan [47](#)

channel, wireless LAN [44](#)

Class of Service [141](#)

Class of Service, see CoS

client list [72](#)

client-server protocol [137](#)

comfort noise generation [122](#)

configuration

- backup [167](#)
- reset [169](#)
- restoring [168](#)

Control and Provisioning of Wireless Access Points

- See CAPWAP

copyright [253](#)

CoS [93, 141](#)

CTS (Clear to Send) [232](#)

CTS threshold [58](#)

D

data fragment threshold [58](#)

default LAN IP address [21](#)

Denials of Service, see DoS

DHCP [32, 70, 103](#)

diagnostic [171](#)

differentiated services [141](#)

Differentiated Services, see DiffServ

DiffServ (Differentiated Services) [141](#)
 code points [141](#)
 marking rule [94, 141](#)
DNS [70, 79](#)
DNS server address assignment [41](#)
documentation
 related [2](#)
domain name system, see DNS
Domain Name System. See DNS.
DoS [106](#)
DS (Differentiated Services) [93](#)
DS field [93, 141](#)
DSCP [93, 141](#)
DTLS [36](#)
dynamic DNS [103](#)
Dynamic Host Configuration Protocol, see DHCP
dynamic WEP key exchange [236](#)
DYNDNS wildcard [103](#)

E

EAP Authentication [235](#)
echo cancellation [122](#)
Encapsulation [41](#)
encapsulation [35](#)
encryption [60, 237](#)
ESS [230](#)
Europe type call service mode [142](#)
Extended Service Set IDentification [46, 53](#)
Extended Service Set, see ESS

F

FCC interference statement [253](#)
filters
 MAC address [59](#)
firewalls [105](#)
 configuration [108](#)
 DoS [106](#)
 security [112](#)
firmware [165](#)
flash key [142](#)

flashing [142](#)
fragmentation threshold [58, 232](#)
FTP [96](#)

G

G.168 [122](#)
Guide
 Quick Start [2](#)

H

hidden node [231](#)
host [155](#)
host name [31](#)

I

IANA [186](#)
IBSS [229](#)
IEEE 802.11g [233](#)
Independent Basic Service Set, see IBSS
initialization vector (IV) [238](#)
Internet access [15](#)
Internet Assigned Numbers Authority, see IANA
Internet Service Provider, see ISP
IP address [32](#)
 default [21](#)
 WAN [36](#)
IP Address Assignment [41](#)
IP pool [71](#)
ISP [35](#)
ITU-T [122](#)

L

LAN [69](#)
 client list [72](#)
 MAC address [73](#)
limitations

- wireless LAN [60](#)
- WPS [67](#)
- listening port [127](#)
- Local Area Network, see LAN
- login
 - passwords [21](#)
- logout [21](#)
 - automatic [21](#)
- logs [145, 163](#)

M

- MAC [31, 115](#)
- MAC address [73](#)
 - filter [59](#)
- MAC address filtering [115](#)
- MAC filter [115](#)
- Management Mode
 - CAPWAP and DHCP [37](#)
 - CAPWAP and IP Subnets [37](#)
 - managed AP [36](#)
- managing the device
 - good habits [18](#)
 - using FTP. See FTP.
- MBSSID [61](#)
- Media access control [115](#)
- Media Access Control, see MAC Address
- Message Integrity Check, see MIC
- MIC [237](#)
- model name [31](#)
- multimedia [136](#)
- Multiple BSS, see MBSSID

N

- NAT [96, 186](#)
 - definitions [100](#)
 - how it works [101](#)
 - what it does [101](#)
- Network Address Translation, see NAT
- network map [24](#)
- non-proxy calls [134](#)

O

- OK response [140](#)
- other documentation [2](#)

P

- Pairwise Master Key (PMK) [238, 239](#)
- passphrase [48](#)
- passwords [21](#)
- PBC [62](#)
- peer-to-peer calls [134](#)
- Per-Hop Behavior, see PHB
- PHB [94, 141](#)
- phone book
 - speed dial [134](#)
- PIN, WPS [62](#)
 - example [64](#)
- ports [18](#)
- PPP over Ethernet, see PPPoE
- PPPoE [35](#)
- preamble [58](#)
- preamble mode [233](#)
- protocol [35](#)
- PSK [238](#)
- Push Button Configuration, see PBC
- push button, WPS [62](#)

Q

- QoS [83, 84, 93, 140](#)
- Quality of Service, see QoS
- Quick Start Guide [2, 21](#)

R

- RADIUS [234](#)
 - message types [235](#)
 - messages [235](#)
 - shared secret key [235](#)
- RADIUS server [59](#)

Real time Transport Protocol, see RTP
related documentation [2](#)
Request To Send, see RTS
reset [169](#)
RESET button [20](#)
restart [169](#)
restoring configuration [168](#)
RFC 1631 [95](#)
RFC 1889 [139](#)
RFC 3164 [145](#)
router features [15](#)
RTP [139](#)
RTS (Request To Send) [232](#)
 threshold [231](#), [232](#)
RTS threshold [58](#)

S

safety warnings [254](#)
scan [47](#)
scheduling
 wireless LAN [57](#)
security
 wireless LAN [58](#)
security, network [112](#)
service access control [157](#)
Service Set [46](#), [53](#)
Session Initiation Protocol, see SIP
silence suppression [122](#)
SIP [136](#)
 account [136](#)
 call progression [139](#)
 client [137](#)
 identities [136](#)
 INVITE request [140](#)
 number [136](#)
 proxy server [137](#)
 redirect server [138](#)
 register server [139](#)
 servers [137](#)
 service domain [136](#)
 URI [136](#)
 user agent [137](#)
speed dial [134](#)

SSID [59](#)
 activation [52](#)
 MBSSID [61](#)
static route [75](#)
status [29](#)
status indicators [18](#)
subnet [179](#)
subnet mask [180](#)
subnetting [182](#)
supplementary services [141](#)
syslog
 protocol [145](#)
 severity levels [145](#)
system
 firmware [165](#)
 passwords [21](#)
 status [29](#)
System Info [31](#)
system name [31](#), [160](#)

T

Temporal Key Integrity Protocol, see TKIP
The [36](#)
three-way conference [143](#)
thresholds
 data fragment [58](#)
 RTS/CTS [58](#)
TKIP [237](#)
ToS [140](#)
Type of Service, see ToS

U

Uniform Resource Identifier [136](#)
Universal Plug and Play, see UPnP
upgrading firmware [165](#)
UPnP [73](#)
 security issues [70](#)

V

VAD [122](#)
 version
 firmware
 version [32](#)
 voice activity detection [122](#)
 voice coding [140](#)
 VoIP [136](#)
 features [16](#)
 peer-to-peer calls [134](#)
 VoIP features [16](#)
 VoIP status [152](#)

W

WAN
 Wide Area Network, see WAN [35](#)
 warnings [254](#)
 Web Configurator [21](#)
 web configurator
 passwords [21](#)
 WEP [48, 60](#)
 WEP Encryption [49](#)
 Wi-Fi Protected Access, see WPA
 wireless
 security [233](#)
 wireless client WPA supplicants [238](#)
 wireless LAN [43](#)
 authentication [58, 59](#)
 BSS [61](#)
 example [61](#)
 channel [44](#)
 encryption [60](#)
 example [44](#)
 fragmentation threshold [58](#)
 limitations [60](#)
 MAC address filter [59](#)
 MBSSID [61](#)
 preamble [58](#)
 RADIUS server [59](#)
 RTS/CTS threshold [58](#)
 scheduling [57](#)
 security [58](#)
 SSID [59](#)
 activation [52](#)
 WEP [60](#)
 WPA [60](#)
 WPA-PSK [60](#)
 WPS [62, 64](#)
 example [65](#)
 limitations [67](#)
 PIN [62](#)
 push button [62](#)
 wireless network
 example [43](#)
 wireless security [233](#)
 WLAN [43](#)
 auto-scan channel [47](#)
 interference [231](#)
 passphrase [48](#)
 scheduling [57](#)
 security parameters [240](#)
 see also wireless.
 WEP [48](#)
 WLAN button [17](#)
 WPA [60, 237](#)
 key caching [238](#)
 pre-authentication [238](#)
 user authentication [238](#)
 vs WPA-PSK [238](#)
 wireless client supplicant [238](#)
 with RADIUS application example [239](#)
 WPA2 [237](#)
 user authentication [238](#)
 vs WPA2-PSK [238](#)
 wireless client supplicant [238](#)
 with RADIUS application example [239](#)
 WPA2-Pre-Shared Key, see WPA2-PSK
 WPA2-PSK [237, 238](#)
 application example [239](#)
 WPA-PSK [60, 237, 238](#)
 application example [239](#)
 WPS [62, 64](#)
 example [65](#)
 limitations [67](#)
 PIN [62](#)
 example [64](#)
 push button [62](#)