**DIGITAL RECORDER
INSTALLATION AND
OPERATION MANUAL**

MODEL

DX-TL950E

SLD Security & Communications
The Old Forge, Ockham Lane, Ockham, Surrey GU23 6PH England
Phone +44.1483225633 · Fax +44.1483225634
sales@sld.co.uk · www.sld.co.uk



THIS INSTRUCTION MANUAL IS IMPORTANT TO YOU. PLEASE READ IT BEFORE USING YOUR DIGITAL RECORDER.

Features

Built-in duplex 9 channel multiplexer

- The screen mode can be switched on the monitor such as single screen, split4 screen, split9 screen and sequential screen, split4 sequential screen. (☞ see page 36)
- The unit is equipped with the 2 type-output connector to display the different mode split screen on the each of different monitors. (☞ see page 37)
- Convenient simultaneous recording-playback function. Live picture from all cameras can be recorded continuously while the recording of desired camera is played back.
- The unit can neither record nor display on the monitor the camera image legally prohibited.

Recording

• Recording rate 50 pps (picture per second)

50 pps recording which is becoming the industrial standard is available on the 9 ch unit. 3 pps recording per each camera is also available even using 9 cameras.

- Built-in 250GB HDD or higher. Furthermore 2 HDDs can be built in the unit by installing 1 additional HDD.

• Various record setting

Recording interval and picture quality of each camera can be set individually to both normal recording and alarm recording. (☞ see pages 41-43)

• Flexible alarm recording

Any camera number for alarm recording of 3 modes such as Alarm Channel, Alarm Plus and Alarm25 can be assigned. 4 triggers are also selectable out of various combination such as external alarm input and motion detection, external alarm input or motion detection, only external alarm input or only motion detection.

(☞ see pages 41-43)

• Partition recording

Alarm images can be recorded in a designated area within HDD to keep alarm images longer term than normal recording. The partition area can be set from 10% to 90% of HDD capacity. (☞ see page 75)

• Mirror recording

Mirror recording for prevention against a data loss in case of HDD crash. (☞ see pages 74,75)

⦿ When using a MIRRORING function, two sets of HDD are required. It does not function in one HDD. Please consult with the retailer, when you add HDD.

• Built-in motion detection

It is available the high-fidelity detection setting by the detection area of 192 (12 x 16) dots.

(☞ see pages 39,40)

• Wavelet compression

Wavelet method with compression of higher-rate than JPEG.

- 1ch PCM audio recording. (☞ see page 48)

Network

- From the personal computer connected to Internet using the Microsoft Internet Explorer, the image screen such as live images, search and playback image can be displayed. (☞ see pages 77-82)

• LAN software for applications in grate variety

Optional software with high-quality communication functions.

Ease of use**• Auto set-up**

By selecting only the recording period of 24, 96 or 168 hrs. and 14 or 30 days, the unit assigns automatically recording interval and picture grade for all channels and other menu settings are set to the default.

(☞ see pages 17,18)

Microsoft is either registered trademarks or trademarks of Microsoft Corporation in the United States and/or other countries.

Compact Flash™ is a trademark of SanDisk Corporation.

☞ Storage capacity is indicated in gigabytes (GB). (1GB = 1000 x 1000 x 1000 bytes.)

Caution and care

HEAVY OBJECTS SHOULD NEVER BE PLACED ON THE UNIT (E.G., TV)

NEVER TOUCH OR INSERT ANY OBJECT INSIDE THE UNIT

Touching the inside of the cabinet or inserting foreign objects of any kind not only creates a safety hazard but can also cause extensive damage.

PROTECT THE POWER CORD

Damage to the power cord may cause fire or shock hazard. If the mains cord is damaged, switch off the mains outlet and carefully unplug the cord by holding the mains plug.

UNPLUG THE POWER CORD DURING A LONG ABSENCE

Turn off the power and unplug the power cord during a long absence.

MAINTAIN GOOD VENTILATION

Do not obstruct the many ventilation holes on the unit. For maximum ventilation, leave some space around the unit and place the unit on a hard level surface only, and ensure it is not covered during use. Heavy objects should never be placed on the unit.

WHEN NOT IN USE

When not in use always turn OFF the MAIN switch.

CABINET CARE

Never use petroleum-based cleaners. Clean with a soft cloth moistened with soap and water and wipe dry. PVC cables or leads should not be left in contact with the cabinet surface for long periods.

INSTALLATION LOCATION

For excellent performance and lasting reliability install in a location that is:-

1. Well ventilated, out of direct sunlight and away from direct heat.
2. A solid vibration-free surface.
3. Free from high humidity, excessive dust and away from magnetic fields.
4. Please ensure that the ventilation fan located on the unit's back panel is not blocked.

UNSUITABLE LOCATIONS

Placing the unit in the following places might shorten the product life:

- Extremely cold places, such as refrigerated warehouses and ice houses
- Places where excessive hydrogen sulfide is likely to be generated, such as hot-springs areas
- Places or locations with salt air environment.

WARNING: TO PREVENT FIRE OR SHOCK HAZARD, DO NOT EXPOSE THIS APPARATUS TO RAIN OR MOISTURE. THIS APPARATUS MUST BE GROUNDED.

MAINS LEAD CONNECTION

The mains lead on this Unit is fitted with a non-rewireable mains plug, incorporating a 5A fuse. If you need to replace the fuse, use a 5A fuse approved by BSI or ASTA to BS 1362, ensuring you refit the fuse cover. If the mains plug is not suitable for the sockets in your home, and you require to remove the plug, remove the fuse, cut off the plug then dispose of the plug immediately, to avoid a possible electric shock hazard. To refit a new plug, follow these instructions; Green-and-yellow: Earth, Blue: Neutral and Brown: Live. As the colours in the mains lead of this Unit may not correspond with the coloured markings identifying the terminals in your plug, proceed as follows.

- The wire which is coloured green-and-yellow must be connected to the terminal in the plug which is marked by the letter E or by the safety earth symbol \perp or coloured green or green-and-yellow.
- The wire which is coloured blue must be connected to the terminal which is marked with the letter N or coloured black.
- The wire which is coloured brown must be connected to the terminal which is marked with the letter L or coloured red.

This Unit complies with the requirements of the EC Directive 89/336/EEC, “EMC Directive” and 73/23/EEC, “Low Voltage Directive”, as amended by Directive 93/68/EEC. The requirements for the susceptibility according to EN 55024 and the requirements for interference according to EN 55022 are observed for the operation on residential areas, business, light industrial premises and in small scale enterprises, inside as well as outside of the building. All places of operation are characterised by their connection to the public low voltage power supply system. This unit is manufactured in accordance with EN 60950.

There may be cases when the unit’s built-in MOTION DETECTION function does not operate properly due to external condition or video input signal or other factors.

The user will not be indemnified for problems (e.g., recording failure or playback failure) that occur with either the unit or a connected device during operation. It is recommended that backups of important recordings are made regularly as a precaution against possible breakdowns and accidents.

Recordable time and product warranty

Continuous recordable time and the estimated time displayed on the menu screen is the continuous recordable time when operating this unit and is not the product warranty period. Furthermore, it is not the period that guarantees life time at the unit.

- This unit has a built-in hard disk, which is a precision device. Please handle this unit with sufficient care.
- Do not subject this unit to vibrations or shocks. This may cause trouble specially when the unit is switched on or when the hard disk is being accessed, and sufficient care is required.
- Do not disconnect the power plug while the unit is switched on or while recording or playing.
- For early detection of faults, we recommend that you request inspection once a year.
- Please do not move the unit at least one minute after turning off the power.

- The hard disk and cooling fan are not permanent items and will need replacement with time. When operated in an ambient temperature of 25°C, it is recommended that both the hard disk and fan be replaced after 30,000 hours.
(This figure is only a guide, and should not be taken as a guaranteed lifespan of the products. Use the “ELAPSED TIME” on the <INFORMATION/SERVICE> screen as a guide to performing checkups.)

Contents

Features	2,3	SEQUENCE SETTING	38
Caution and care	4,5	INTERLACE	38
Contents	6,7	<MOTION DETECTION SETTINGS>	39,40
Flowchart	8,9	SELECTION CAMERA NUMBER	39
Flowchart for connection and settings	8,9	DETECTION MASK SETTING	39
Major operations and their functions	10-14	SENSITIVITY	40
Front View	10,11	MOTION THRESHOLD	40
Front View (Inside of the door)	11,12	TEST MODE	40
Inserting/Ejecting Compact Flash Card	11	<RECORD SETTINGS>	41-43
Rear View	13,14	Settings concerning normal recording	
Connections	15,16	and alarm recording	41
Connecting to CCTV camera, monitor, sensor	15	Recording mode settings for normal recording	
EMERGENCY/ALARM IN/REC/		and alarm recording	41,42
CLOCK ADJ Input terminal	15	ALARM REC DURATION	43
MODE OUT1 - 5 Output terminal	15	PRE ALARM REC	43
CALL OUT Output terminal	15	MOTION DET REC	43
Alarm Recording Connection	16	<TIMER PROGRAM SETTINGS>	44-46
Connecting with analog video recorder	16	TIMER PROGRAM SETTINGS	44
AUTO SET UP	17,18	TIMER PROGRAM	44,45
AUTO SET UP	17,18	Structure of the <TIMER PROGRAM> screen	44,45
Initial settings	18	HOLIDAY SETTING	46
INITIALIZATION	18	Recording mode settings A ~ D	
HDD SETTING	18	for normal recording/alarm recording	46
INITIALIZATION	18	MOTION DET REC	46
Basic Operations	19-25	ALARM REC DURATION	46
Multiplexer functions	19	Overlapping Timer settings	46
Multiplexer buttons	19	<INITIAL SET UP/INFORMATION>	47-58
Menu settings	19-21	HDD SETTINGS	47,48
To return to the normal screen from a menu screen ...	20	HDD REPEAT REC MAIN/HDD REPEAT REC SUB ..	47
DAYLIGHT SAVING/DAYLIGHT SETTING	20	HDD REPEAT PLAY	47
TIME DATE ADJUST	20,21	IM-CHECK PLAY	47
Present time display	21	SEQUENTIAL PLAY	48
Recorded capacity display function	21	AUDIO RECORDING	48
Basic manual recording	21-23	REAR TERMINAL SETTINGS	49-51
Setting the recording interval and recording		MODE OUT 1 ~ MODE OUT 5	49
picture quality for normal recording	22,23	KEY SOUND	49
Basic playback	23,24	BUZZER	49,50
Basic search	24,25	REMAIN HDD	50
TIME DATE SEARCH	24,25	CALL OUT SETTINGS	50,51
LANGUAGE SELECTION	25	HDD MAIN REMAIN/HDD SUB REMAIN	50,51
Menu functions	26-31	HDD MAIN FULL/HDD SUB FULL	51
MENU SETTING	26-30	EMERGENCY REC DURATION	51
COPY MENU	31	COMMUNICATION PORT SETTINGS	51-54
SEARCH SELECTION MENU	31	RS-232C	51,52
<TIME DATE/DISPLAY SETTINGS>	32-34	MODE	51
TIME DATE ADJUST	32	SETTINGS	52
DISPLAY MODE	32	ETHERNET	52-54
CLOCK LOCATION SETTING	32	E-MAIL ADDRESS	52
CAMERA DISPLAY	32	SERVICE PORT SETTING	53
CAMERA TITLE/MEMO SETTING	32,33	ALARM NOTIFICATION SETTING	53,54
DUPLEX MODE DISPLAY	34	INFORMATION/SERVICE	54-56
<MPX DISPLAY SETTINGS>	35-38	HDD INFORMATION/CFC INFORMATION	54
Multiplexer function related button		WARNING LOG LIST	54,55
operations/operation table	35	RESET TO FACTORY SETTINGS	55
Camera number button operations	35	DATA CLEAR	55,56
SPLIT/SEQUENCE button operations	35	PASSWORD	56-58
ZOOM button operations	35	SIMPLE LOCK	56
The function of the SPLIT/SEQUENCE button,		PASSWORD LOCK	56-58
ZOOM button, and camera number buttons	36	LANGUAGE SELECTION	58
MPX DISPLAY SETTINGS	37	<QUICK SETTINGS>	59
SPLIT4 SCREEN SETTING	37	QUICK SETTINGS	59
SPLIT9 SCREEN SETTING	37,38	To update menu settings of this unit	59
		To save menu settings of this unit	
		to a Compact Flash Card	59

Operation examples	60-63	With Audio recording	84
Operation example 1	60	Troubleshooting	85,86
Operation example 2	61,62	Warnings and CALL OUT output	87,88
Operation example 3	62,63	Warnings and their appropriate countermeasures	87,88
Various recordings	64	Glossary	89
PRE ALARM RECORDINGS	64	Glossary	89
EMERGENCY RECORDINGS	64	Relation of recording operation to the number of cameras and recording interval settings	89
Various playback functions	65,66	Specifications	90
Playing still frames	65		
Shuttle viewing/direct shuttle viewing	65		
Shuttle hold	65		
Frame-by-frame playback	65		
Reverse playback	65		
High-speed fast-forward/high-speed rewind	65		
Changing playback intervals	65,66		
Simultaneous playback during recording	66		
Various search	67-71		
SEARCH SELECTION	67		
SEARCH TYPE	67		
SELECTION CAMERA NUMBER	67		
DATE/TIME	67		
PLAYBACK DEVICE	67		
TIME DATE SEARCH	67		
INDEX SEARCH/ALARM INDEX SEARCH	68,69		
ALARM SKIP SEARCH	69,70		
ALARM LIST SEARCH	70,71		
START/END SEARCH	71		
Making Copy/Restore	72,73		
Making Copy/Restore	72,73		
Copying from unit to videotape	73		
Other convenient functions	74-76		
Power failure compensation circuit	74		
Power failure reset recording	74		
Log function for when power failure occurs while the unit is in operation or the MAIN switch on the rear of the unit is turned OFF	74		
RESET button	74		
HDD SETTING	74,75		
MIRRORING	74,75		
PARTITION/PARTITION SIZE	75		
COVERT CAMERA SETTING	76		
ALARM DISPLAY	76		
Communications by Web Browser	77-82		
Communications by Web Browser	77-82		
The personal computer product requirements	77		
Connections	77		
AUTHENTICATION	77,78		
Welcome	78-82		
Live monitor	78,79		
Playback	79,80		
Time Search	80		
Alarm Search	80		
Index Search	80		
User maintenance	80,81		
Log out	81		
Change log in user	81,82		
Recording time table	83,84		
Continuous recording time table	83,84		
HDD continuous recording time (for 250GB drive)	83		
Without Audio recording	83		
With Audio recording	83		
Compact Flash Card continuous recording time (for 64MB)	84		
Without Audio recording	84		

How to read this manual

• Viewing displays

 (Refer to this information when operating)
Reference information concerning operation is described.

 (Caution required)
Cautionary items concerning operation are described.

 (See reference page)
Reference item and page number are indicated.

INFORMATION (Reference)

Other reference information is described.

• Finding desired information

There is an index on the each right page of this manual. There is also "Contents" at the beginning of this manual. In addition, reference pages are indicated throughout this manual.

• Troubleshooting

Read Troubleshooting (pages 85,86) for possible remedies to the problem.

Flowchart

■ Flowchart for connection and settings

Installation example :

This is an example operational flowchart of the following : making connections at the rear of the terminal ; setting HDD mode to PARTITION ; making default settings ; making an Alarm recording with Timer mode ; searching recorded data with ALARM LIST SEARCH ; using playback, and copying to a Compact Flash Card.

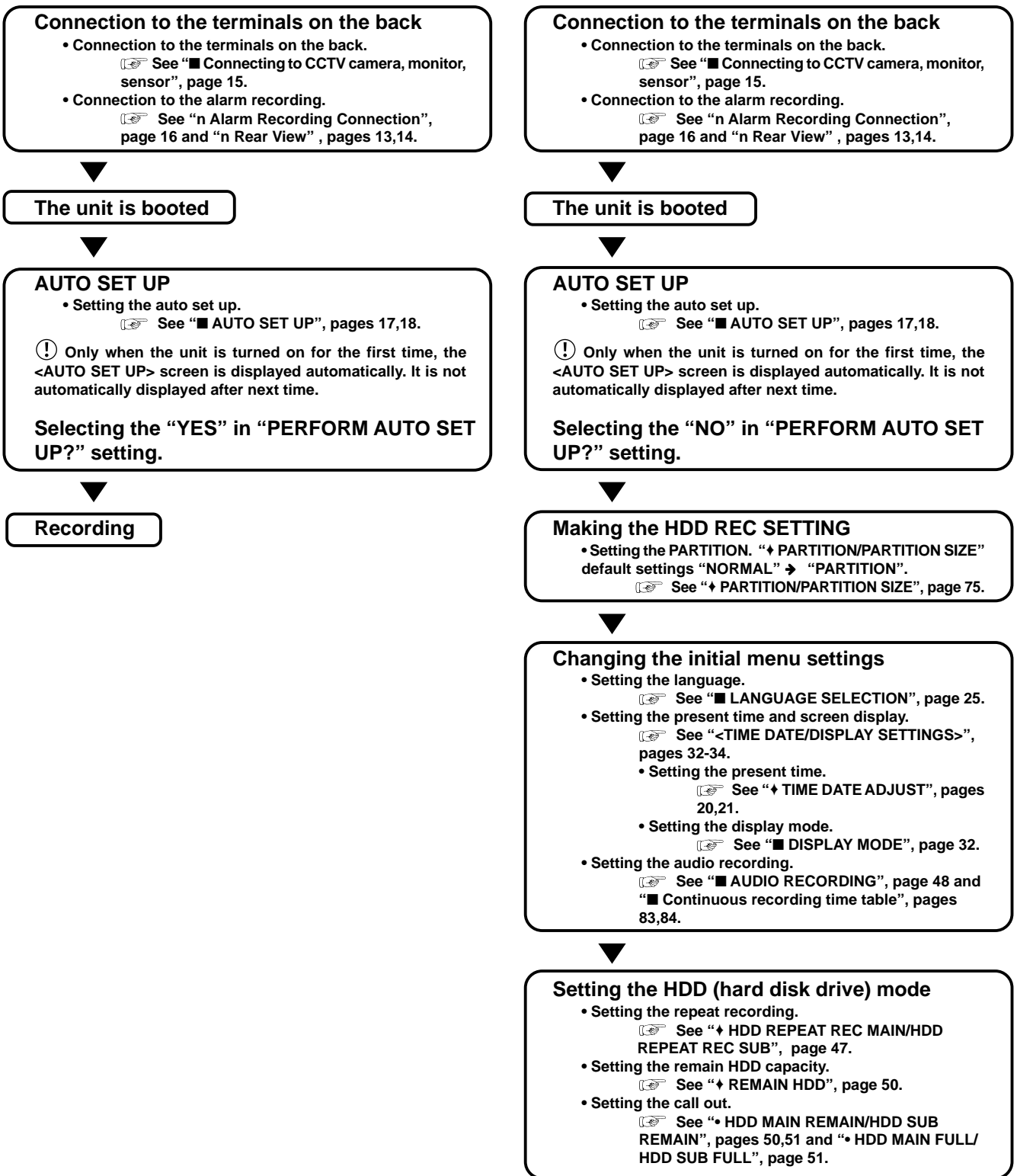

Changing the multiplexer function

- Changing the split4 , split9 screen settings.
 - ☞ See “■ SPLIT4 SCREEN SETTING”, page 37, “■ SPLIT9 SCREEN SETTING”, pages 37,38.
- Changing the sequence setting.
 - ☞ See “■ SEQUENCE SETTING”, page 38.

Setting other various functions

- Changing the display mode.
 - ☞ See “■ CLOCK LOCATION SETTING”, page 32 and “■ DUPLEX MODE DISPLAY”, page 34.
- Setting the camera title/memo.
 - ☞ See “■ CAMERA TITLE/MEMO SETTING”, pages 32,33 and “■ CAMERA DISPLAY”, page 32.
- Setting to output signals of the unit status.
 - ☞ See “♦ MODE OUT 1 ~ MODE OUT 5”, page 49.
- Setting the buzzer.
 - ☞ See “♦ BUZZER”, pages 49,50.

Setting the motion detection

- Selecting the camera number.
 - ☞ See “■ SELECTION CAMERA NUMBER”, page 39.
- Setting the active/inactive of detection function.
 - ☞ See “■ Recording mode settings for normal recording and alarm recording”, pages 41,42.
- Setting the detection areas.
 - ☞ See “■ DETECTION MASK SETTING”, page 39.
- Setting the sensitivity.
 - ☞ See “■ SENSITIVITY”, page 40.
- Setting the minimum number of dots for starting the motion detection operation.
 - ☞ See “■ MOTION THRESHOLD”, page 40.

Setting the timer recording

Setting the recording

- Selecting the normal & alarm recording or pre-alarm recording.
 - ☞ See “■ Recording mode settings A ~ D for normal recording/alarm recording”, page 46.
- Setting the recording mode.
 - Setting the motion detection recording.
 - ☞ See “■ MOTION DET REC”, page 46.
 - Selecting the camera selection during the alarm recording.
 - ☞ See “■ Recording mode settings for normal recording and alarm recording”, pages 41,42.
 - Setting the interval/picture grade for normal recording.
 - ☞ See “♦ Setting the recording interval and recording picture quality for normal recording”, pages 22,23.
 - Setting the interval/picture grade for alarm recording.
 - ☞ See “♦ Setting the recording interval and recording picture quality for normal recording”, pages 22,23.
- Setting the duration of alarm recording.
 - ☞ See “■ ALARM REC DURATION”, page 46.
- Setting the duration of pre-alarm recording.
 - ☞ See “■ PRE ALARM REC”, page 43.

Setting the timer recording (continued)

- Setting the timer program mode.
 - ☞ See “<TIMER PROGRAM SETTINGS>”, pages 44-46.
- Setting the holiday.
 - ☞ See “■ HOLIDAY SETTING”, page 46.
- Selecting the timer program.
 - ☞ See “♦ Structure of the <TIMER PROGRAM> screen”, pages 44,45.
- Setting the timer recording.
 - Selecting the day.
 - Selecting the start time.
 - Selecting the end time.
 - Selecting the recording mode.
 - Selecting the motion detection mode.

Timer recording is executed/completed

- ☞ See “■ Warnings and their appropriate countermeasures”, pages 87,88.

Searching the recorded data

- Setting the device of searching.
 - ☞ See “♦ PLAYBACK DEVICE”, page 67.
- Selecting the camera number of searching.
 - ☞ See “♦ SELECTION CAMERA NUMBER”, page 67.
- Selecting the search mode.
 - ☞ See “♦ SEARCH TYPE”, page 67.
- Setting the alarm list search.
 - ☞ See “■ ALARM LIST SEARCH”, pages 70,71.
- Setting the search time and date of alarm list.
 - ☞ See “♦ DATE/TIME”, page 67.

The search is completed/The search result is displayed

Playback the search result

- Selecting the camera number of playback.
 - ☞ See “<MPX DISPLAY SETTINGS>”, pages 35-38.
- Selecting the sequence screen.
 - ☞ See “♦ SPLIT/SEQUENCE button operations”, page 35.
- Playback
 - ☞ See “■ Basic playback”, pages 23,24.
- Selecting the speed of playback.
 - ☞ See “Various playback functions”, pages 65, 66.

Copy the data

- Inserting the Compact Flash Card.
 - ☞ See “■ Inserting/Ejecting Compact Flash Card”, page 11.
- Setting the copy function.
 - ☞ See “Making Copy/Restore”, pages 72,73.

Major operations and their functions

■ Front View

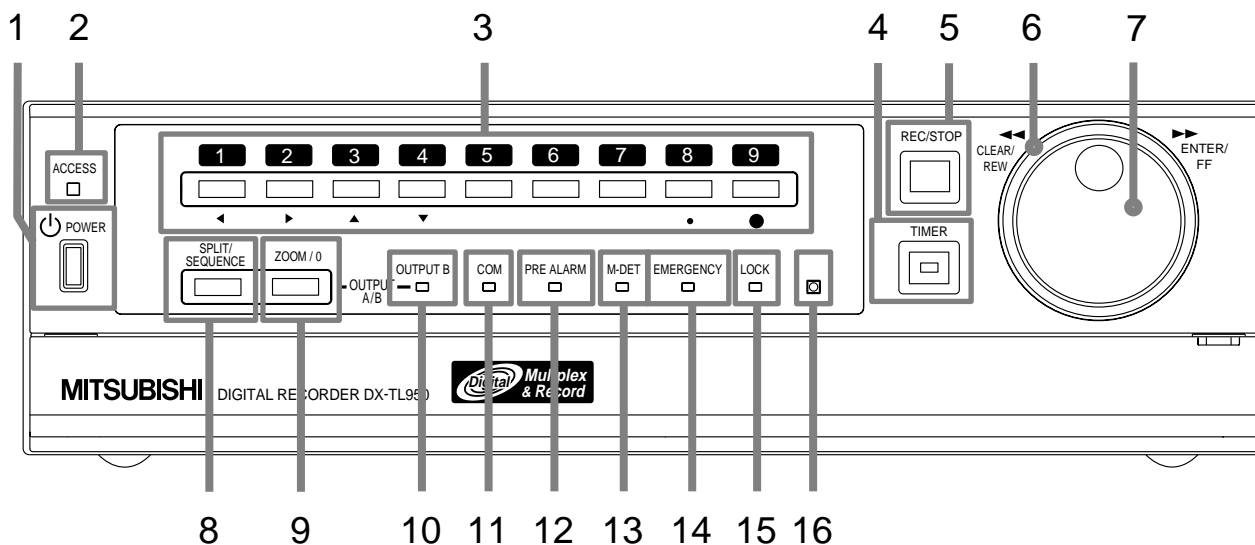

1. POWER button

When pressing this button while the MAIN switch on the rear of this unit is set to ON, the power turns on and the button lights. When the button is pressed again, the unit will be in stand-by and the light will turn off. When the unit is in operational transition such as booting, the button will flash and other operations are not accepted.

2. ACCESS indicator

Illuminates during access to hard disk drive or Compact Flash Card.

3. Camera number buttons (1 to 9)

Press the button to display the image from the camera connected to this input on to the monitor.

4. TIMER button

When pressing this button, the unit is set to timer recording/stand-by and the TIMER button lights. When pressing this button for more than 1 second, timer recording/stand-by is cancelled and the TIMER button turns off.

5. REC/STOP button

When pressing this button, recording starts and the button lights. When pressing the button for more than 1 second, the recording stops and the light turns off. When pressing this button for more than 1 second during alarm recording, recording stops. During timer recording, recording will not stop even if the button is pressed.

6. SHUTTLE ring

Used to set various menus and search functions, adjusting the playback speed, and rewinding or forwarding the recording images.

7. JOG dial

Used to set various menus and search functions, forwarding or rewinding the image during playback (field-by-field).

8. SPLIT/SEQUENCE button

Press the button to display SPLIT9, SPLIT4 screen or SEQUENCE screen setting on multiplexer functions.

9. ZOOM button

When pressing this button once during single screen display, the screen is magnified by 100%. In the same way, pressing the button twice magnifies the screen by 200% and pressing the button three times magnifies the screen by 400%. The magnification center point (X) is displayed in the center of the screen in screen display 1. Press the camera number buttons (1, 2, 3, 4) to move the magnification location. When the ZOOM button is kept pressed for one second or longer, the operation of the camera number buttons and the SPLIT/SEQUENCE button is switched between operation for OUTPUT A (screen of the monitor connected to the OUTPUT A connector and the VIDEO OUT connector) and operation for OUTPUT B (screen of the monitor connected to the OUTPUT B connector).

☞ To display image of the monitor connected to OUTPUT B, set to "ON" in the setting of the "OUTPUT B ON/OFF" of the <MPX DISPLAY SETTINGS> screen.
☞ see page 37.

10. OUTPUT B indicator

This is not lit when the operation of the camera number buttons and the SPLIT/SEQUENCE button is set to OUTPUT A, and it lights with switching to OUTPUT B.

11. COM (COMMUNICATION) indicator

Illuminates when establishing the communication with personal computer.

12. PRE ALARM indicator

Illuminates during pre-alarm recording mode.

13. M-DET indicator

Illuminates when the motion detection function is on.

■ Front View (Inside of the door)

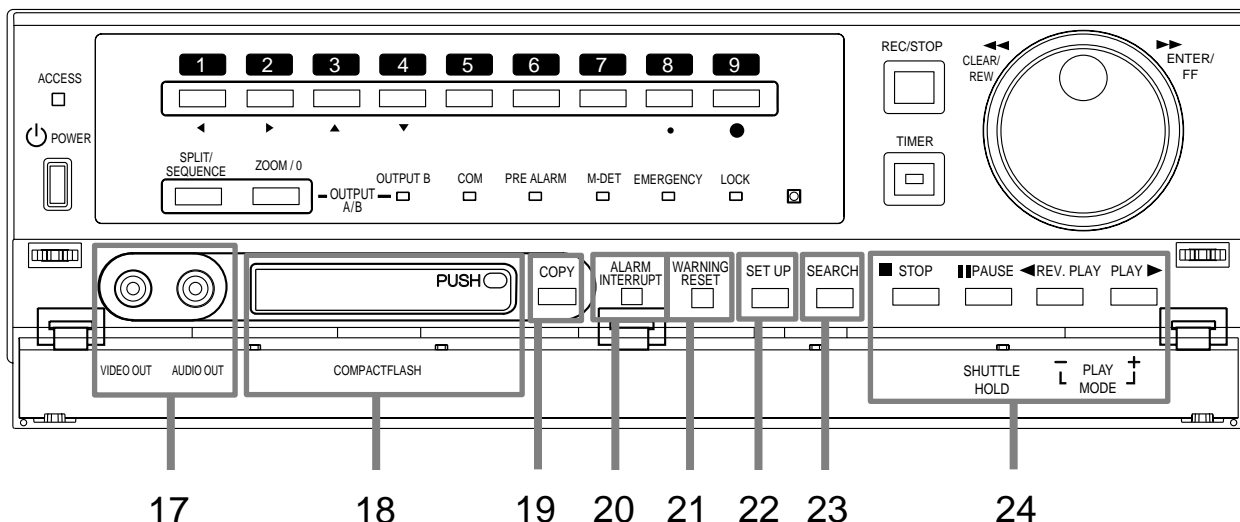

14. EMERGENCY indicator

Flashes during emergency recording and lights when recording is completed.

15. LOCK indicator

Illuminates when simple lock or password lock is on.

16. LOCK button

Pressing it with a pointed object (such as a ballpoint pen) while the MAIN switch (main power) on the rear of the unit is on, will activate the simple lock or password lock. Moreover, the PASSWORD can be set on the <PASSWORD SETTING> screen. The indicator will light while the lock is active.

17. ANALOGUE OUT connectors

VIDEO OUT connector

Output connector for video signal (RCA pin).

AUDIO OUT connector

Output connector for audio signal (RCA pin).

18. COMPACT FLASH slot

Compact Flash Card can be used for saving/loading data and menus. When not using the slot, attach the COMPACT FLASH slot cover to prevent dust from entering within the unit.

■ Inserting/Ejecting Compact Flash Card

⚠ Before using the Card, read the cautionary notes described in the manual included with Compact Flash Card.

<Inserting Card>

1. Remove the COMPACT FLASH slot cover attached to the unit.
2. Please turn down the side which contains notch in right and left, securely insert the Card until the CFC EJECT button pops out.

⚠ Do not eject the Card when copying/restoring, copying/loading menus, or immediately after inserting the Card. The Card or the contained data may become damaged.

⚠ Securely insert the Compact Flash Card. Otherwise, the unit may not work properly.

⚠ Please use the Compact Flash Card which we recommend. When a non recommended Card is used, there is a possibility that reading and writing of data may not operate correctly.

⚠ For usable Compact Flash Card check with your dealer of purchase.

⚠ When using a new Card, be sure to execute CFC DATA CLEAR in the <INFORMATION/SERVICE> screen.

<Ejecting Card>

1. Press the CFC EJECT button and eject the Card.
2. Attach the COMPACT FLASH slot cover.

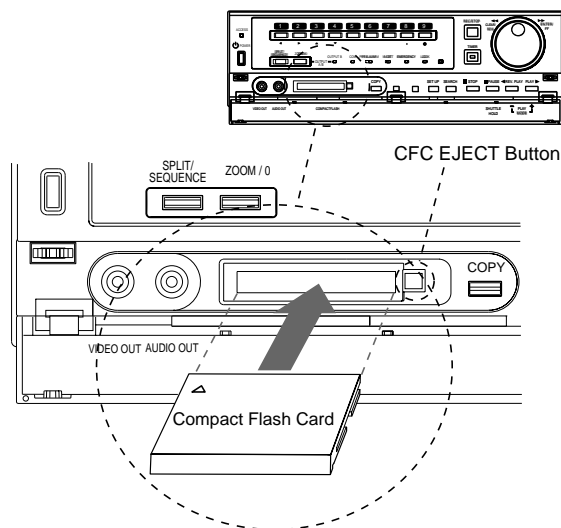

■ Front View (Inside of the door) (continued)

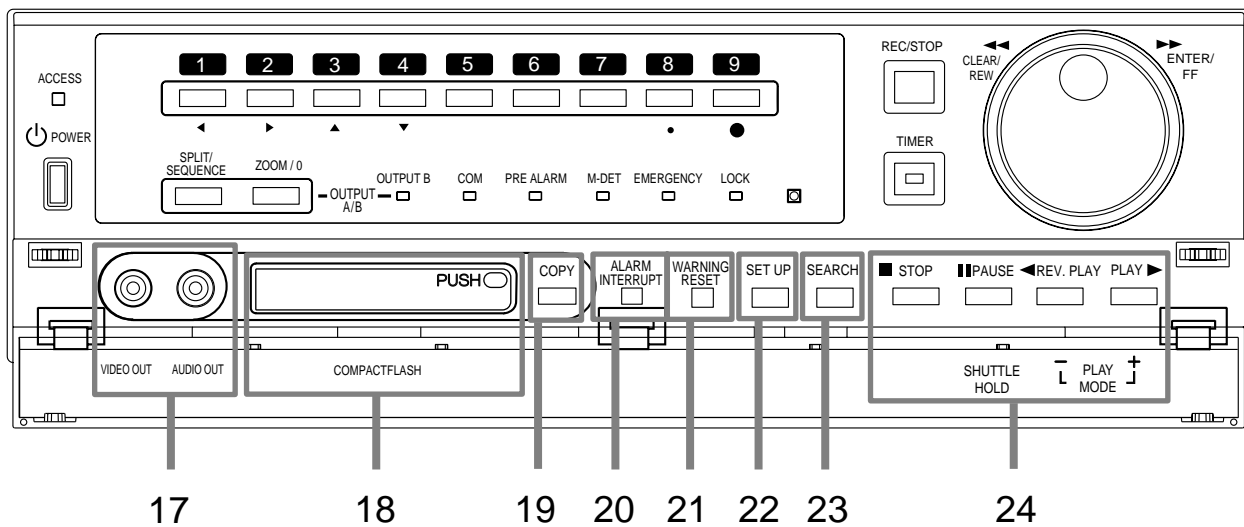

19. COPY button

Press this button to display <COPY> menu. This button lights when performing copy operation. Copies cannot be made when a card is not in the COMPACT FLASH slot.

20. ALARM INTERRUPT button

When pressing this button, the unit will not accept alarm signals or motion detection for 5 minutes. During this time, the button will flash.

21. WARNING RESET button

This button is used to clear on-screen warning display and clear data.

22. SET UP button

Press this button to display the <SETTINGS> menu.

23. SEARCH button

Press this button to display the <SEARCH > menu.

24. OPERATION buttons

STOP button

Press to stop playback.

PAUSE / SHUTTLE HOLD button

When pressing this button during playback, the unit switches to still frame playback and the button lights. When pressing this button again, the unit resumes playback and the button turns off. When pressing this button during shuttle playback, the set playback speed is maintained even when letting go of the SHUTTLE ring. (SHUTTLE HOLD)

REV. PLAY (REVERSE PLAY) button

When pressing this button, the unit switches to reverse playback and the button lights.

PLAY button

When pressing this button, the unit starts playback and the button lights.

PLAY MODE buttons

The playback interval can be changed during normal and reverse playback by pressing PLAY(+) or REV. PLAY(-).

■ Rear View

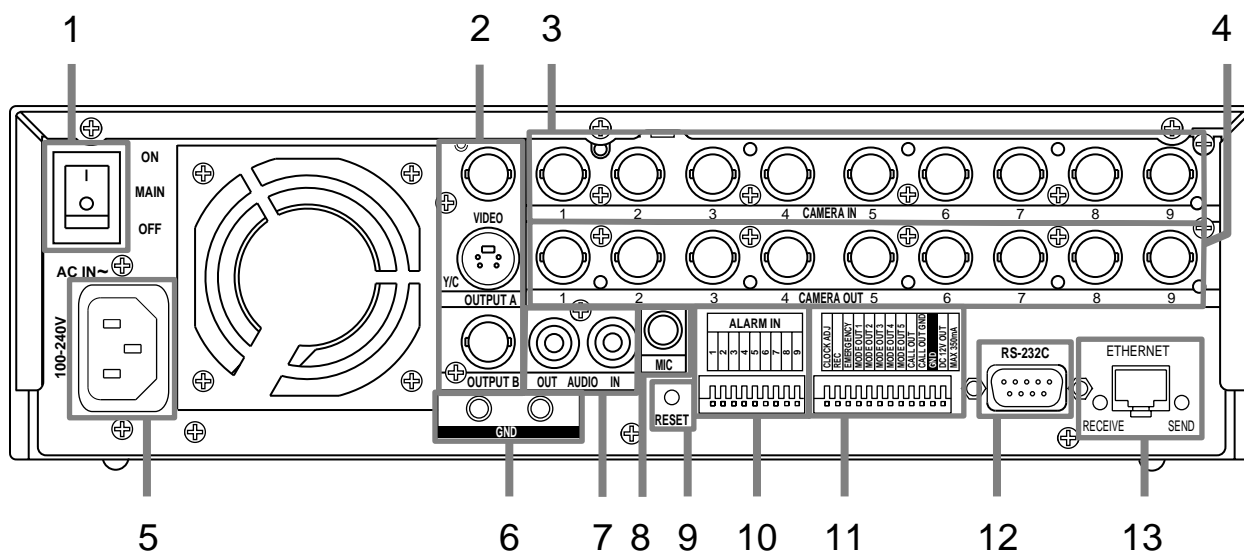

1. MAIN switch

This is the main power switch. When using this unit, set this switch to ON. Otherwise, the power cannot be turned on/off using the POWER button on the front of the unit.

2. VIDEO OUT connectors

OUTPUT A VIDEO connector

Output connector for video signal to monitor (BNC connector).

OUTPUT A S(Y/C) connector

This is output connector for video signals that separate brightness signals and color signals for higher picture quality. Simultaneous output along with OUTPUT A VIDEO is also possible.

OUTPUT B connector

Output connector for video signal to monitor only for live image (BNC connector) (see page 37). To display the image, set "OUTPUT B ON/OFF" on the <MPX DISPLAY SETTINGS> screen to "ON". The playback image cannot be put out to the OUTPUT B connector.

3. CAMERA IN connectors

Input connector for signal of camera (BNC connector).

4. CAMERA OUT connectors

Camera video output connectors for use of BNC connectors. If the MAIN switch is ON, the loop through output is possible for the camera image inputted into each CAMERA IN connector.

5. AC power socket

This socket connects to the power cord. Earth terminal is for safety. Use the 100 ~ 240V plug with earth for the power of this unit.

⚠ This unit must be earthed at all times. Never connect this unit to a power outlet which does not have an earth terminal.

⚠ Please use the AC power cord accessory.

6. GND terminals

It is the common GND terminal.

7. AUDIO connectors

AUDIO IN connector

Input connector for audio signal (RCA pin).

AUDIO OUT connector

Output connector for audio signal (RCA pin).

8. MIC jack

Input connector for microphone (600 ohm impedance). Use of MIC for audio recording has priority to use of the AUDIO IN connector.

9. RESET button

Pressing this button resets the unit and the power turns off. In this case, video data, menu settings and the current time are kept.

10. ALARM IN terminals

Input terminal for alarm signal.

11. I/O terminals

CLOCK ADJ terminal

Input terminal to set the present time. Time display is adjusted to the nearest hour (00 minutes 00 seconds) when this terminal receives the CLOCK ADJ signal.

INFORMATION

The on-screen clock can be reset to the nearest hour, by applying a signal to the CLOCK ADJ terminal. For example, if the current time is 11:29:59, it will be reset to 11:00:00, and if the current time is 11:30:00, it will be reset to 12:00:00.

■ Rear View (continued)

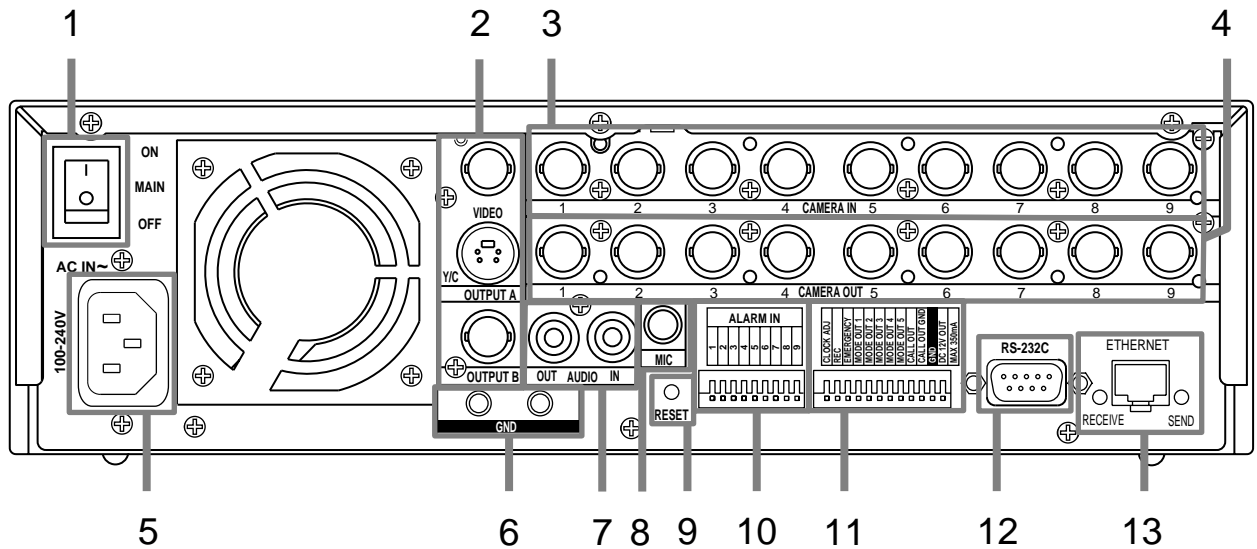

REC terminal

Input terminal to start recording. Not available during timer recording.

EMERGENCY terminal

Input terminal initiating immediate shift to EMERGENCY recording mode compulsorily.

MODE OUT 1 ~ MODE OUT 5 terminals

Output terminal to indicate the unit's current mode. Select the unit's condition by MODE OUT 1 ~ MODE OUT 5 setting in the <REAR TERMINAL SETTINGS> menu.

CALL OUT terminal / CALL OUT GND terminals

This is the ISOLATION output terminal. Information that can be transmitted externally consists of CALL OUT settings made on the <REAR TERMINAL SETTINGS> menu screen as well as fixed output settings.

DC 12V OUT terminal

Will only output when the MAIN switch is ON. The maximum electric current is 350mA.

12. RS-232C connector

This connector is used to connect to host device with RS-232C connector. This unit can be controlled by another device through this connector.

13. ETHERNET connector

Use a 10BASE-T cable to connect to the Ethernet terminal. Please use the cable adapted to 10BASE-T. DUPLEX MODE is HALF DUPLEX.

RECEIVE indicator

Illuminates when the unit is receiving a signal.

SEND indicator

Illuminates when the unit is transmitting a signal.

■ Connecting to CCTV camera, monitor, sensor

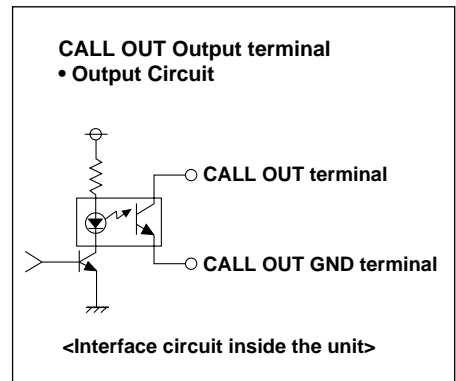
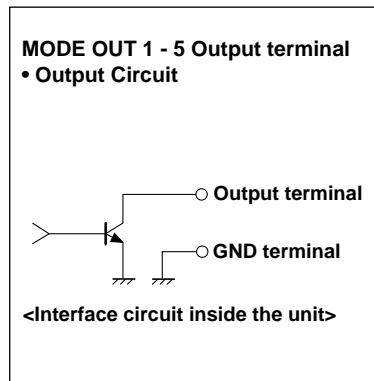
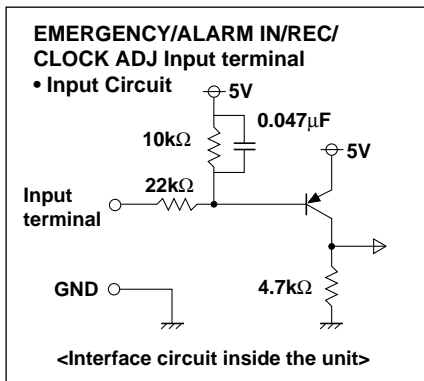
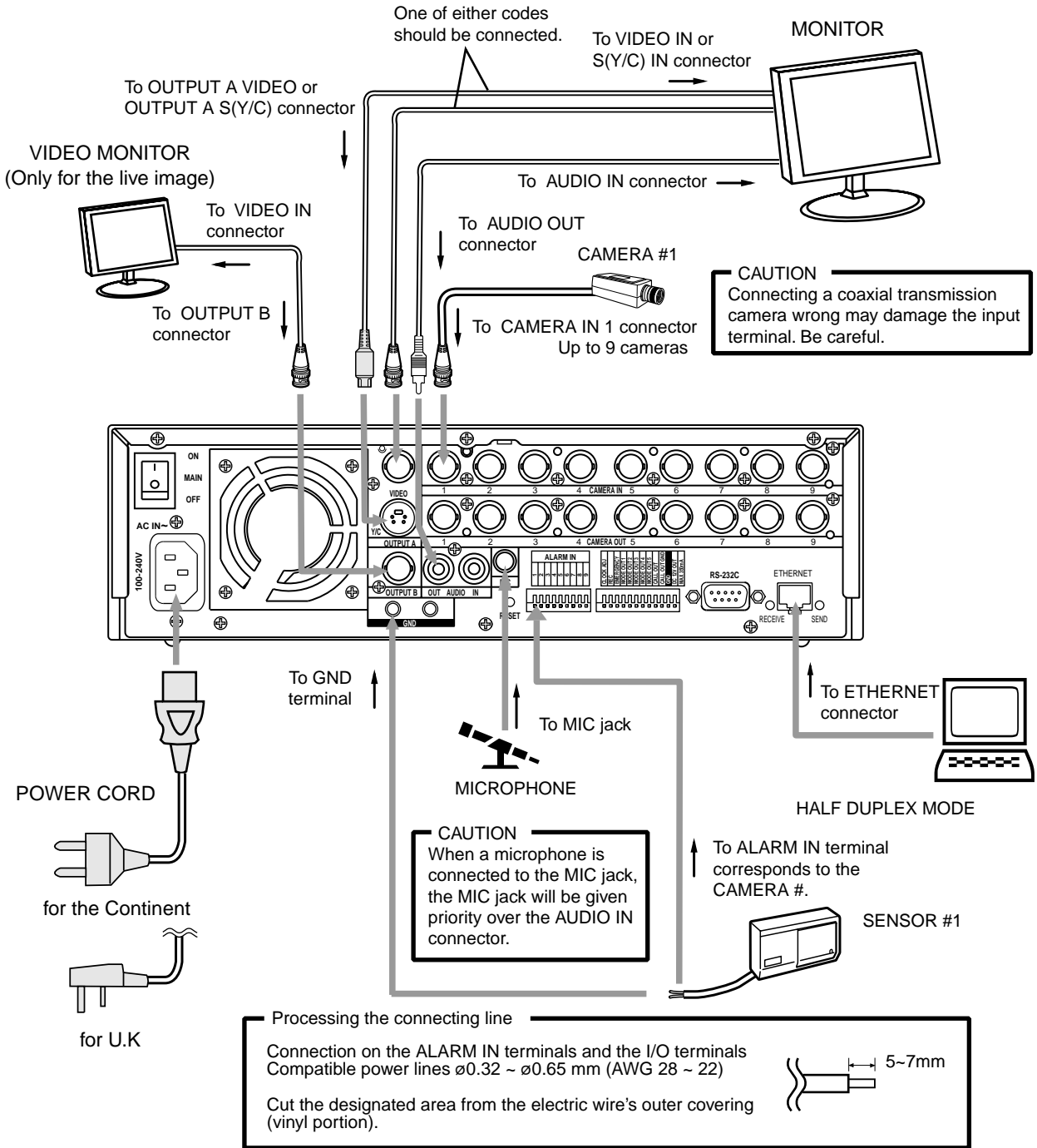

■ Alarm Recording Connection

Example : The diagram below shows an example of connection for alarm signals corresponding to camera number 1. (In the case of ALARM SETTING of default setting.)

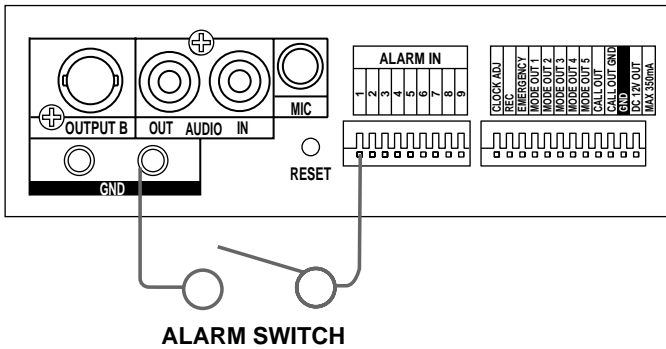

■ Connecting with analog video recorder

This unit is equipped with video output (RCA) and audio output (RCA) connectors on the front and OUTPUT A S(Y/C), OUTPUT A VIDEO (BNC) and AUDIO OUT (RCA) connectors on the rear. Video signals can be simultaneously outputted from the video output connector on the front and the OUTPUT A VIDEO/S(Y/C) connector on the rear. In the same manner, audio signals can be outputted in simultaneously from the audio output connector on the front and AUDIO OUT connector on the rear. By connecting an analog video recorder to these terminals, recorded contents can be copied.

⚠ Make sure to turn off this unit when connecting with peripheral recording devices.

■ AUTO SET UP

AUTO SET UP is displayed, in order to set up an indispensable function, when this unit is turned on for the first time.

⊖ Only when the unit is turned on for the first time, the AUTO SET UP screen is displayed automatically. It is not automatically displayed after next time.

1. After connect the cameras and the monitors, turn on the MAIN switch on the rear of the unit and wait until the ACCESS indicator is turned off, then press the POWER button on the front.

- The <LANGUAGE SELECTION> screen is displayed. The language of the menu can be selected in this screen.

<LANGUAGE SELECTION>	
>>LANGUAGE	ENGLISH
EXECUTE	
JOG	: SELECT
SHUTTLE>>	: EXECUTE

⊖ POWER button operation will not be accepted while the ACCESS indicator is flashing. Press the POWER button after the indicator turns off.

2. Turn the SHUTTLE ring clockwise.

- The background of the setting changes to red and flashes.
- Setting (default : "ENGLISH")
"ENGLISH", "FRANCAIS", "DEUTSCH", "ESPAÑOL", "РУССКИЙ", "ITALIANO"

3. Turn the JOG dial to display the desired setting and turn the SHUTTLE ring clockwise.

- The setting is confirmed and flashing stops.

⊖ Beware while setting the AUTO SET UP, the menu screen can not be exited. Furthermore the screen already set can not be displayed again.

4. Turn the JOG dial to move the cursor to "EXECUTE", and turn the SHUTTLE ring clockwise.

- The <TIME DATE ADJUST> screen appears.
- The date/time is set in this screen.

<TIME DATE ADJUST>	
>>DAYLIGHT SAVING	OFF
DAY	01
MONTH	01
YEAR	2004
TIME	00:00:00
APPLY	
EXECUTE	
JOG	: SELECT
SHUTTLE>>	: EXECUTE

5. Set the desired setting in this screen referring to "◆ DAYLIGHT SAVING/DAYLIGHT SETTING (☞ see page 20)", "◆ TIME DATE ADJUST (☞ see pages 20,21)".

⊖ By turning the JOG dial to the cursor to "APPLY" and turn the SHUTTLE ring clockwise, "00:00:00" of "TIME" will start after the moment of turning the SHUTTLE ring.

6. Turn the JOG dial to move the cursor to "EXECUTE", and turn the SHUTTLE ring clockwise.

- "PERFORM AUTO SET UP?" is displayed on the screen.

PERFORM AUTO SET UP?	
>>YES	
NO	
SHUTTLE>>	: EXECUTE

7-1. (When not execute AUTO SET UP...)

Select "NO" by turning the JOG dial and turn the SHUTTLE ring clockwise.

- "SETTING UP..." is displayed on the screen, and the unit starts-up.

7-2. (When execute AUTO SET UP...)

Select "YES" by turning the JOG dial and turn the SHUTTLE ring clockwise.

- The <CAMERA CHECK> screen appears.
- The cameras connected and the video condition can be confirmed in this screen.

<CAMERA CHECK>	
>>EXECUTE	
CHECK CAMERA CONNECTION AND IMAGE BEFORE EXECUTE	
SHUTTLE>>	: EXECUTE

8. Turn the SHUTTLE ring clockwise.

- The <AUTO RECORD SETTING> screen appears.
- The period of the record can be set.
- Setting of AUTO RECORD SETTING (default : "24H")
"24H", "48H", "72H", "96H", "120H", "144H", "1WEEK", "2WEEK", "3WEEK", "1MONTH", "2MONTH", "3MONTH", "4MONTH", "5MONTH", "6MONTH", "1YEAR"

<AUTO RECORD SETTING>	
>>RECORDING CYCLE	24H
EXECUTE	
JOG	: SELECT
SHUTTLE>>	: EXECUTE

9. Turn the SHUTTLE ring clockwise.

- The background of the setting changes to red and flashes.

10. Turn the JOG dial to display the desire setting and turn the SHUTTLE ring clockwise.

- The setting is confirmed and flashing stop.

11. Turn the JOG dial to move the cursor to "EXECUTE", and turn the SHUTTLE ring clockwise.

- The <RECORD SETTING> screen appears.
- The recording interval and recording picture quality of normal recording and alarm recording corresponding to each camera numbers can be set in this screen.

➡ The <RECORD SETTING> screen consists of 2 pages. The second page is displayed when turning the JOG dial to move the cursor to "NEXT PAGE", and turn the SHUTTLE ring clockwise.

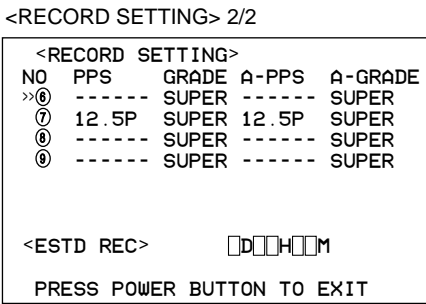
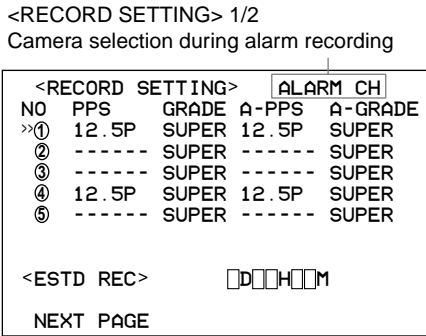

ⓘ According to the number of the cameras connected and the value of "RECORDING CYCLE", the most suitable setting of the "PPS", "A-PPS", "GRADE" and "A-GRADE" are set automatically.

12. When the setting is complete, press the POWER button.
• "SETTING UP..." is displayed on the screen, and the unit starts-up.

➡ To execute AUTO SET UP again, press and hold the camera number button 1 and press the POWER button, when the MAIN switch is set to ON and the POWER button is set to OFF. The <CAMERA CHECK> screen appears. However all menu of record setting will be reset.

■ INITIALIZATION

The <INITIALIZATION> setting is used to select the mode of peripheral recording devices connected to SCSI connector ID4•ID5, to make HDD SETTING, and to initialize the HDD.

◆ HDD SETTING

The HDD SETTING can be set to MIRRORING (simultaneous recording to the internal HDD as a pair), PARTITION (an independent partition that can be set within the total HDD memory specifically for ALARM RECORDING). (☞ see pages 74,75 "MIRRORING", "PARTITION")

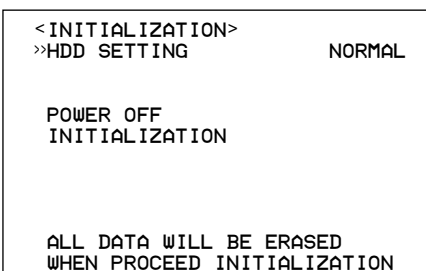

◆ INITIALIZATION

Please perform initialization, when a <INITIALIZATION> setup is changed.

1. Turn ON the MAIN switch on the rear of the unit, and wait until the ACCESS indicator goes off. Hold down the REC/STOP button, and press the POWER button on the front of the unit.

• The unit starts-up, and the <INITIALIZATION> screen is appears.

➡ POWER button operation will not be accepted while the ACCESS indicator is flashing. Press the POWER button after the indicator turns off.

2. Select "INITIALIZATION" by turning the JOG dial, and turn the SHUTTLE ring clockwise.

• The setting is made, and the display returns to normal after initialization.

ⓘ Settings are not confirmed unless you perform "INITIALIZATION".

ⓘ Performing "INITIALIZATION" initializes all data on the HDD. It deletes the complete ALARM LIST, and the next entry is registered from 00001.

➡ Select "POWER OFF" to abort initialization.

■ Multiplexer functions

Buttons on the front of the unit can be used to perform some of the multiplexer functions.

◆ Multiplexer buttons

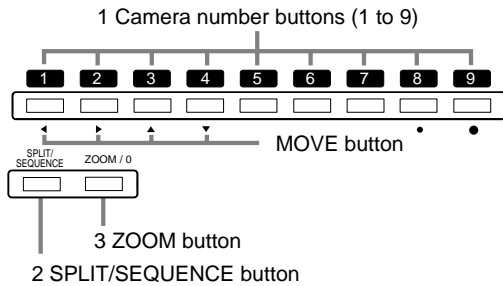

1. Camera number buttons (1 to 9)

Video images of cameras connected to CAMERA IN terminals 1 to 9 on the rear of the unit are displayed.

➡ By pressing a camera number button, video images can be displayed even if the camera is not set for recording.

2. SPLIT/SEQUENCE button

The screen switches in order of SPLIT9 SCREEN SETTING, 3 types of SPLIT4 SCREEN SETTING (a, b and c), SPLIT4 SEQUENTIAL and SINGLE SEQUENTIAL set in the <MPX DISPLAY SETTINGS> screen (SEQUENTIAL display is skipped during playback).

➡ Pressing the ZOOM button for more than 1 second on the front of this unit can switch the operation of camera number buttons and the SPLIT/SEQUENCE button to the screen of the monitor connected to the OUTPUT B connector. Pressing the ZOOM button for more than 1 second again can switch to the screen of the monitor connected to the OUTPUT A connector.

3. ZOOM button

When this button is pressed during single screen display, magnification 100% screen appears and the magnification centre point (X) is displayed at the centre. Pressing the button again will switch the magnification to 200% and then 400%. By pressing the MOVE buttons, the magnified screen can be moved vertically/horizontally with the centre point as the axis (see "ZOOM button operations", page 35).

When the ZOOM button is pressed, camera number buttons 1 to 4 become the MOVE buttons.

■ Menu settings

The operational conditions of this unit can be set in the menu screens according to use. Although the setting method will differ slightly depending on the menu screen, the basic setting method of using the JOG dial and SHUTTLE ring will remain the same. e.g. setting the display mode.

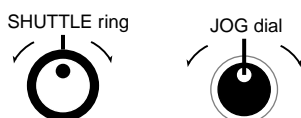

Example : Set DISPLAY MODE to "3" (default : "1").

1. Set the MAIN switch on the rear of the unit to ON. Press the POWER button on the front after the ACCESS indicator turns off.

- "SETTING UP..." appears on the screen and the unit is booted.

➡ POWER button operation will not be accepted while the ACCESS indicator is flashing. Press the POWER button after the indicator turns off.

2. After boot-up, press the SET UP button inside the door on the front of the unit.

- The <SETTINGS> screen appears.

```
<SETTINGS>
>>TIME DATE/DISPLAY SETTINGS
MPX DISPLAY SETTINGS
MOTION DETECTION SETTINGS
RECORD SETTINGS
TIMER PROGRAM SETTINGS
INITIAL SET UP/INFORMATION

QUICK SETTINGS

MEMO :
```

➡ When the SET UP button is pressed and the menu screen appears, the background darkens and the displayed characters become easier to see.

3. Check to see that the cursor (>>) is positioned at "TIME DATE/DISPLAY SETTINGS", and then turn the SHUTTLE ring clockwise.

- The <TIME DATE/DISPLAY SETTINGS> screen appears (see page 32).

```
<TIME DATE/DISPLAY SETTINGS>
>>TIME DATE ADJUST
DISPLAY MODE 1
CLOCK LOCATION SETTING
CAMERA DISPLAY NUMBER
CAMERA TITLE/MEMO SETTING
DUPLEX MODE DISPLAY BOTTOM

<MODE 1>

01-01-2004 00:00:00
```

4. Turn the JOG dial to move the cursor to "DISPLAY MODE" and turn the SHUTTLE ring clockwise.

- The background of the "DISPLAY MODE" setting turns red and flashes.

➡ When turning the JOG dial clockwise, the cursor (>>) moves down. When turning counterclockwise, the cursor (>>) moves up.

5. Turn the JOG dial to display "3".

- The display mode sample on the bottom of the screen changes to <MODE 3>.

6. Turn the SHUTTLE ring clockwise.

- The setting is confirmed and flashing stops.
- To continue with other settings, repeat steps 4 and 5.

➡ When turning the SHUTTLE ring counterclockwise while the setting is flashing, the setting will return to the previous setting.

➡ To exit the screen, turn the SHUTTLE ring counterclockwise.

```
<TIME DATE/DISPLAY SETTINGS>
TIME DATE ADJUST
>>DISPLAY MODE 3
CLOCK LOCATION SETTING
CAMERA DISPLAY NUMBER
CAMERA TITLE/MEMO SETTING
DUPLEX MODE DISPLAY BOTTOM

<MODE 3>

01-01-2004 THU
00:00:00 12.5P 99% A00001
```

```
<TIME DATE ADJUST>
>>DAYLIGHT SAVING OFF
DAY 01
MONTH 01
YEAR 2004
TIME 00:00:00
DAYLIGHT SETTING
DAY OF WEEK MONTH TIME
IN SUN LAST MAR 01:00
OUT SUN LAST OCT 02:00
JOG :SELECT
SHUTTLE>> :EXECUTE
```

◆ To return to the normal screen from a menu screen

The procedure to return to the normal screen after completing menu screen settings using the JOG dial/SHUTTLE ring is detailed below.

1. Check to see that the setting item is no longer flashing and the item has been changed to the desired setting.

- The setting has not been confirmed if the item is flashing. Refer to the previous setting procedure to confirm the setting.
- To continue with other settings or to check the setting item, turn the SHUTTLE ring counterclockwise once to return to the previous screen.

⊖ This operation is not accepted when the setting item is flashing.

2-1. (To return to the normal screen by moving up menu screens one at a time •••)

- Turn the SHUTTLE ring counterclockwise for the amount of menu screens opened. The previous menu screen is displayed every time the SHUTTLE ring is turned counterclockwise.

2-2. (To directly return to the normal screen •••)

- Press the SET UP button to clear the menu screen and return to the normal screen.

ⓘ The menu screen will not be cleared even when pressing the SET UP button when the setting item is flashing.

◆ DAYLIGHT SAVING/DAYLIGHT SETTING

The clock is put forward one hour by activating this setting. The default setting for this function is "OFF". On the DAYLIGHT SAVING in <TIME DATE ADJUST> menu, turn the JOG dial to flash "AUTO" (the daylight saving function is automatically activated). Turn the SHUTTLE ring clockwise to enter the selection.

In the "DAYLIGHT SETTING" setting, start/end time of the "DAYLIGHT SAVING" function can be checked and changed.

Example : Set the start time of the "DAYLIGHT SAVING" function "IN" to "MON", "1ST", "APR" and "02:00". (default : "SUN", "LAST", "MAR", "01:00").

1. Press the SET UP button to display the <SETTINGS> screen.

2. Check to see that the cursor (>>) is positioned at "TIME DATE/DISPLAY SETTINGS", and then turn the SHUTTLE ring clockwise.

- The <TIME DATE/DISPLAY SETTINGS> screen appears.

3. Check to see that the cursor is positioned at "TIME DATE ADJUST", and then turn the SHUTTLE ring clockwise.

- The <TIME DATE ADJUST> screen appears.

4. Turn the JOG dial to move the cursor (>>) to "IN" and turn the SHUTTLE ring clockwise twice.

- The "DAY" display reverses in color when the SHUTTLE ring is turned the first time. When the ring is turned for the second time, the display turns red and flashes.

5. Turn the JOG dial to display "MON" and turn the SHUTTLE ring clockwise.

- The setting is confirmed and flashing stops.

6. Turn the JOG dial clockwise to move the cursor (>>) to "WEEK".

7. Repeat steps 4, 5 and 6 to set "WEEK", "MONTH" and "TIME".

8. Turn the SHUTTLE ring clockwise.

- The setting is confirmed and flashing stops.

9. Turn the SHUTTLE ring counterclockwise or press the SET UP button.

◆ TIME DATE ADJUST

ⓘ Before starting recording, it is necessary to set accurately the current date and time.

Example : Set the date/time to 28/10/2004 6:30pm (18:30)(default : "01/01/2004 00:00:00").

1. Press the SET UP button to display the <SETTINGS> screen.

2. Check to see that the cursor (>>) is positioned at "TIME DATE/DISPLAY SETTINGS", and then turn the SHUTTLE ring clockwise.

- The <TIME DATE/DISPLAY SETTINGS> screen appears.

3. Check to see that the cursor is positioned at "TIME DATE ADJUST", and then turn the SHUTTLE ring clockwise.

- The <TIME DATE ADJUST> screen appears.

```
<TIME DATE ADJUST>
>>DAYLIGHT SAVING OFF
DAY 01
MONTH 01
YEAR 2004
TIME 00:00:00
```

4. Turn the JOG dial to move the cursor to "DAY" and turn the SHUTTLE ring clockwise.

- The background of "DAY" changes to red and flashes.

```
<TIME DATE ADJUST>
DAYLIGHT SAVING OFF
>>DAY 01
MONTH 01
YEAR 2004
TIME 00:00:00
```

5. Turn the JOG dial to display "28" and turn the SHUTTLE ring clockwise.

- The setting is confirmed and flashing stops.

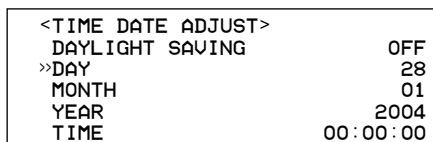

6. Turn the JOG dial clockwise to move the cursor (>>) to "MONTH".

➡ When turning the JOG dial clockwise, the cursor (>>) moves down. When turning counterclockwise, the cursor (>>) moves up.

7. Repeat steps 4 ~ 6 to set "MONTH" and "YEAR".

8. Turn the JOG dial to move the cursor (>>) to "TIME" and turn the SHUTTLE ring clockwise twice.

• The "TIME" display reverses in color when the SHUTTLE ring is turned the first time. When the ring is turned for the second time, the display turns red and flashes.

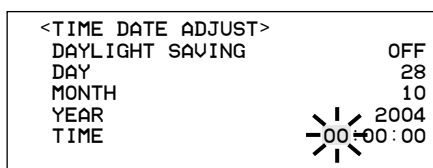

9. Turn the JOG dial to display "18" and turn the SHUTTLE ring clockwise.

• The setting is confirmed and flashing stops.

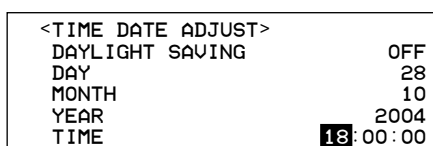

➡ The time is indicated using the 24-hour system.

10. Repeat steps 8 and 9 to set "MINUTE" and "SECOND".

11. Turn the SHUTTLE ring clockwise.

• The setting is confirmed and flashing stops.

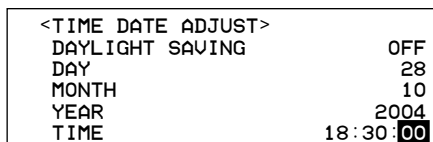

12. Turn the SHUTTLE ring counterclockwise.

◆ Present time display

When turning on the unit power, the time/date display shown to the right appears (in the case of DISPLAY MODE 3).

➡ For setting other display modes, see "DISPLAY MODE" page 32.

INFORMATION

This unit uses 4 digits to display the year. The allowed display range is 99 years between 1/1/2001 ~ 31/12/2099. The unit is also equipped with a function to automatically calculate leap years. The date returns to the year 2001 after 31/12/2099.

◆ Recorded capacity display function

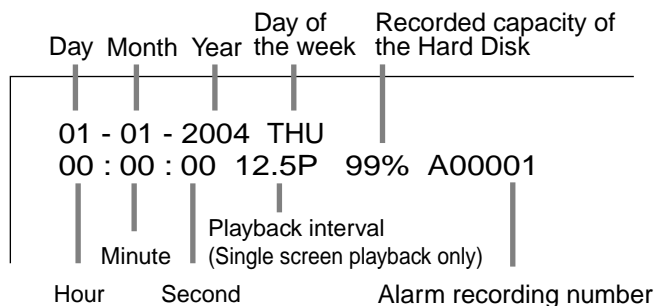

This unit displays the used space of the specified recording device (HDD) on the screen when "REMAIN HDD" of the <REAR TERMINAL SETTINGS> screen is set to "MAIN", "SUB". The "%" indicates the ratio detected as HDD against the total HDD capacity. The following settings are required to enable this function.

1) Select the device and set the remaining capacity using "REMAIN HDD" of the <REAR TERMINAL SETTINGS> screen (see page 50).

2) Select "3" for "DISPLAY MODE" in the <TIME DATE/DISPLAY SETTINGS> screen (see page 32).

➡ During recording, the used HDD space is displayed. When recording is stopped, the display is cleared (with the exception of when pausing recording). The HDD usage display appears again after a few moments when recording is started once more.

■ Basic manual recording

Normal recording using manual operation is explained here. Before starting recording, recording settings must be checked. After checking the settings of "HDD REPEAT REC MAIN", "HDD REPEAT REC SUB" in the <HDD SETTINGS> screen (see page 47), the REC mode settings are made.

⚠ Settings here are for normal recording only. For timer recording, settings must be made on the <TIMER PROGRAM SETTINGS> screen (see page 46).

Basic Operations (continued)

◆ Setting the recording interval and recording picture quality for normal recording

To perform normal recording, "PPS" and "GRADE" must be set for each camera.

Setting of "PPS" (default : "2.5P")
 "5P", "2.5P", "1.667P", "1.25P", "1P", "0.833P",
 "0.625P", "0.5P", "0.2P", "0.1P", "0.05P", "0.025P",
 "- _ _ _ _ -"

"- _ _ _ _ -" : Recording cannot be performed with camera set to this item.

① Available recording intervals will vary according to the number of cameras operating or ALARM RECORDING settings (see page 41). Interval displays will be according to the chart.

Setting of "GRADE" (default : "STD")
 "SUPER", "HIGH", "STD"(STANDARD), "BASIC",
 "LONG"

Example : Set "PPS" of camera number "①" to "0.5P" and "GRADE" to "HIGH" for normal recording.

1. Press the SET UP button to display the <SETTINGS> screen.
2. Turn the JOG dial to move the cursor to "RECORD SETTINGS" and turn the SHUTTLE ring clockwise.
 - The <RECORD SETTINGS> screen appears.

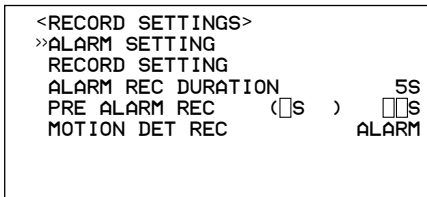

3. Turn the JOG dial to move the cursor to "RECORD SETTING" and then turn the SHUTTLE ring clockwise.
 - The <RECORD SETTING> screen appears.

<RECORD SETTING>
 Camera selection during alarm recording

<RECORD SETTING>				>>ALARM CH	
NO	PPS	GRADE	A-PPS	A-GRADE	
①	2.5P	STD	2.5P	STD	
②	2.5P	STD	2.5P	STD	
③	2.5P	STD	2.5P	STD	
④	2.5P	STD	2.5P	STD	
⑤	2.5P	STD	2.5P	STD	
⑥	2.5P	STD	2.5P	STD	
⑦	2.5P	STD	2.5P	STD	
⑧	2.5P	STD	2.5P	STD	
⑨	2.5P	STD	2.5P	STD	
<ESTD REC>			□□□□H□□□		

About <ESTD REC>

• The estimated recordable time is displayed as <ESTD REC> depending on the "PPS" and "GRADE" settings. (The time will not change when changing the alarm recording settings.)

4. Turn the JOG dial to select "①", and then turn the SHUTTLE ring clockwise.
 - The "PPS" setting reverses in color.

<RECORD SETTING>				ALARM CH	
NO	PPS	GRADE	A-PPS	A-GRADE	
①	2.5P	STD	2.5P	STD	
②	2.5P	STD	2.5P	STD	
③	2.5P	STD	2.5P	STD	
④	2.5P	STD	2.5P	STD	
⑤	2.5P	STD	2.5P	STD	
⑥	2.5P	STD	2.5P	STD	
⑦	2.5P	STD	2.5P	STD	
⑧	2.5P	STD	2.5P	STD	
⑨	2.5P	STD	2.5P	STD	
<ESTD REC>			□□□□H□□□		

5. Turn the SHUTTLE ring clockwise again.
 - The background of the "PPS" setting turns red and flashes.

<RECORD SETTING>				ALARM CH	
NO	PPS	GRADE	A-PPS	A-GRADE	
①	2.5P	STD	2.5P	STD	
②	2.5P	STD	2.5P	STD	
③	2.5P	STD	2.5P	STD	
④	2.5P	STD	2.5P	STD	
⑤	2.5P	STD	2.5P	STD	
⑥	2.5P	STD	2.5P	STD	
⑦	2.5P	STD	2.5P	STD	
⑧	2.5P	STD	2.5P	STD	
⑨	2.5P	STD	2.5P	STD	
<ESTD REC>			□□□□H□□□		

Relationship between the number of operational cameras and available "PPS" (pictures per second)

PPS	Number of operational cameras									
	# 1	# 2	# 3	# 4	# 5	# 6	# 7	# 8	# 9	
SHORT ↑ Recording interval ↓ LONG	25P	25P	12.5P	12.5P	8.33P	8.33P	6.25P	6.25P	5P	
	12.5P	12.5P	6.25P	6.25P	4.165P	4.165P	3.125P	3.125P	2.5P	
	8.333P	8.333P	4.167P	4.167P	2.777P	2.777P	2.083P	2.083P	1.667P	
	6.25P	6.25P	3.125P	3.125P	2.083P	2.083P	1.563P	1.563P	1.25P	
	5P	5P	2.5P	2.5P	1.666P	1.666P	1.25P	1.25P	1P	
	4.167P	4.167P	2.083P	2.083P	1.388P	1.388P	1.042P	1.042P	0.833P	
	3.125P	3.125P	1.563P	1.563P	1.041P	1.041P	0.781P	0.781P	0.625P	
	2.5P	2.5P	1.25P	1.25P	0.833P	0.833P	0.625P	0.625P	0.5P	
	1P	1P	0.5P	0.5P	0.333P	0.333P	0.25P	0.25P	0.2P	
	0.5P	0.5P	0.25P	0.25P	0.167P	0.167P	0.125P	0.125P	0.1P	
0.25P	0.25P	0.125P	0.125P	0.083P	0.083P	0.063P	0.063P	0.05P		
0.125P	0.125P	0.063P	0.063P	0.042P	0.042P	0.031P	0.031P	0.025P		

ⓘ The menu screen will not be cleared even when pressing the SET UP button when the setting item is flashing.

6. Turn the JOG dial to select "0.5P" and turn the SHUTTLE ring clockwise.

- Setting is confirmed and flashing stops.

<RECORD SETTING>			ALARM CH	
NO	PPS	GRADE	A-PPS	A-GRADE
①	0.5P	STD	2.5P	STD
②	2.5P	STD	2.5P	STD
③	2.5P	STD	2.5P	STD
④	2.5P	STD	2.5P	STD
⑤	2.5P	STD	2.5P	STD
⑥	2.5P	STD	2.5P	STD
⑦	2.5P	STD	2.5P	STD
⑧	2.5P	STD	2.5P	STD
⑨	2.5P	STD	2.5P	STD
<ESTD REC>			□D□□H□□M	

7. Turn the JOG dial clockwise to reverse display "GRADE" and turn the SHUTTLE ring clockwise.

- The background of the "GRADE" setting turns red and flashes.

<RECORD SETTING>			ALARM CH	
NO	PPS	GRADE	A-PPS	A-GRADE
①	0.5P	STD	2.5P	STD
②	2.5P	STD	2.5P	STD
③	2.5P	STD	2.5P	STD
④	2.5P	STD	2.5P	STD
⑤	2.5P	STD	2.5P	STD
⑥	2.5P	STD	2.5P	STD
⑦	2.5P	STD	2.5P	STD
⑧	2.5P	STD	2.5P	STD
⑨	2.5P	STD	2.5P	STD
<ESTD REC>			□D□□H□□M	

ⓘ When the setting item is flashing, the menu screen cannot be cleared even when pressing the SET UP button.

8. Turn the JOG dial to select "HIGH" and turn the SHUTTLE ring clockwise.

- The setting is confirmed and flashing stops.

<RECORD SETTING>			ALARM CH	
NO	PPS	GRADE	A-PPS	A-GRADE
①	0.5P	HIGH	2.5P	STD
②	2.5P	STD	2.5P	STD
③	2.5P	STD	2.5P	STD
④	2.5P	STD	2.5P	STD
⑤	2.5P	STD	2.5P	STD
⑥	2.5P	STD	2.5P	STD
⑦	2.5P	STD	2.5P	STD
⑧	2.5P	STD	2.5P	STD
⑨	2.5P	STD	2.5P	STD
<ESTD REC>			□D□□H□□M	

9. When the setting is complete, turn the SHUTTLE ring counterclockwise.

- The cursor appears to the camera number on the left.
- When continuing with other camera number settings, turn the JOG dial to move the cursor to the desired camera number and repeat steps 4 ~ 9 to perform settings.

<RECORD SETTING>			ALARM CH	
NO	PPS	GRADE	A-PPS	A-GRADE
>>①	0.5P	HIGH	2.5P	STD
②	2.5P	STD	2.5P	STD
③	2.5P	STD	2.5P	STD
④	2.5P	STD	2.5P	STD
⑤	2.5P	STD	2.5P	STD
⑥	2.5P	STD	2.5P	STD
⑦	2.5P	STD	2.5P	STD
⑧	2.5P	STD	2.5P	STD
⑨	2.5P	STD	2.5P	STD
<ESTD REC>			□D□□H□□M	

10. Turn the SHUTTLE ring counterclockwise three times or press the SET UP button to return to the normal screen.

11. Press the REC/STOP button.

- The REC/STOP button turns on and recording starts.

12. To stop recording, press the REC/STOP button for more than 1 second.

- Recording stops and the REC/STOP button turns off.



■ Basic playback

This unit allows recorded video to be played back using various methods. The basic playback described here is the most common method for playback.

ⓘ This unit will stop playback when a request for acquisition of live images is communicated during playback.

ⓘ This unit will not playback while a request for the acquisition of live images is being communicated.

1. Press the PLAY button (inside the front door) on the front of the unit.

- Recorded contents of the HDD are played back.
- After turning the power on, the oldest recorded video is played back first. Otherwise, playback resumes at the position of the previous playback.

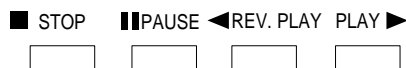

ⓘ When the "HDD REPEAT PLAY" setting in the "HDD SETTINGS" is set to "OFF", playback is stopped when reaching the end of the physical HDD or recorded section. When the "HDD REPEAT PLAY" setting is set to "ON", recorded video data is played back repeatedly (see "HDD REPEAT PLAY", page 47).

2-1. (To change HDD or Compact Flash Card playback device ...)

- Setting (default : "MAIN")
 "MAIN" : Select when playing back MAIN HDD contents.
 "SUB" : Select when playing back SUB HDD contents.
 "CFC" : Select when playing back CFC contents.

• When changing the playback device to Compact Flash Card, press the SEARCH button twice (see page 67) to display the <SEARCH SELECTION> screen and select "CFC" (Compact Flash Card) in "PLAYBACK DEVICE".

ⓘ "SUB" is appeared on the screen when "PARTITION" is selected on "HDD SETTING" of the <INITIALIZATION> screen.

2-2. Press the PLAY button.

- Plays from the playback device that has been selected.

3. To pause playback, press the PAUSE button.
 - To resume playback, press the PAUSE button again or press the PLAY button.
4. To stop playback, press the STOP button.
 - During HDD playback/pause, playback will start the next time from the paused position.
 - During CFC playback/pause, playback will start the next time from the oldest recorded video on the media.

Basic search

This unit displays a menu of most used search functions simply by pressing the SEARCH button.

❗ This unit will not move to search mode when a request for acquisition of live images is communicated while search mode is set. Also, this unit will not search when a request for the acquisition of live images has been communicated.

❗ This unit will not search while a request for the acquisition of live images is being communicated.

TIME DATE SEARCH

On this unit, various search functions are available for searching the start point of video clips. In this section, the most common search method referred to as time/date search is explained. With this method, searching is possible by date, hour, minute, second and specified camera number.

Example : Search a scene recorded on the MAIN HDD with time/date stamp of 03/03/2004 9:25:40pm (21:25:40) using camera number " ③ ".

1. Press the SEARCH button to display the <TIME DATE SEARCH> screen.

- The default setting of the search menu displayed when pressing the SEARCH button is "TIME DATE SEARCH".

```

<TIME DATE SEARCH>

>>01-01-2004  00:00:00

EXECUTE (FORWARD)

MAIN
START      02-02-2004  00:00:00
END        04-04-2004  12:30:15

PUSH SEARCH KEY FOR
SEARCH SELECTION
  
```

2. Check to see that the cursor is next to the search date and turn the SHUTTLE ring clockwise twice.

- The display reverses in color when the SHUTTLE ring is turned the first time. When the ring is turned for the second time, the display turns red and flashes.

3. Turn the JOG dial to display "03" for "DAY" and turn the SHUTTLE ring clockwise.

- Setting is confirmed and flashing stops.

4. Turn the JOG dial to reverse display "MONTH" and turn the SHUTTLE ring clockwise.

- The background of the setting item changes to red and flashes.

5. Turn the JOG dial to display "03" for "MONTH" and turn the SHUTTLE ring clockwise.

- Setting is confirmed and flashing stops.

6. Repeat steps 4 and 5 to set "YEAR", "HOUR", "MINUTE" and "SECOND".

```

<TIME DATE SEARCH>

>>03-03-2004  21:25:40

EXECUTE (FORWARD)

MAIN
START      02-02-2004  00:00:00
END        04-04-2004  12:30:15

PUSH SEARCH KEY FOR
SEARCH SELECTION
  
```

⏪ To exit the <TIME DATE SEARCH> screen without searching, turn the SHUTTLE ring counterclockwise or press the SEARCH button twice.

⏩ For details concerning <SEARCH SELECTION> for selecting search functions (see page 67).

7. Press the SEARCH button to display the <SEARCH SELECTION> screen.

8. Check to see that the cursor is positioned at "SELECTION CAMERA NUMBER", and then turn the SHUTTLE ring clockwise.

- The background of the setting item changes to red and flashes.

9. Turn the JOG dial to select " ③ " and turn the SHUTTLE ring clockwise.

- Setting is confirmed and flashing stops.
- Setting (default : "ALL")

"ALL", " ① ", " ② ", " ③ ", " ④ ", " ⑤ ", " ⑥ ", " ⑦ ", " ⑧ ", " ⑨ "

"ALL" : Search is conducted for all camera number " ① " ~ " ⑨ " and displays the results on SPLIT9 screen.

" ① " ~ " ⑨ " : This search mode scans for matches to search criteria in the selected camera and displays the results on 1 screen.

```

<SEARCH SELECTION>
SEARCH TYPE      TIME DATE
>>SELECTION CAMERA NUMBER  ③

PLAYBACK DEVICE      MAIN
MAIN

START      02-02-2004  00:00:00
END        04-04-2004  12:30:15
  
```

- 10-1. (To change HDD or Compact Flash Card playback device ...)

Turn the JOG dial to select "PLAYBACK DEVICE" and turn the SHUTTLE ring clockwise.

- The background of the setting item changes to red and flashes. Turn the JOG dial to display the desired playback device and confirm.

- Setting (default : "MAIN")

"MAIN" : Select when playing back MAIN HDD contents.

"SUB" : Select when playing back SUB HDD contents.

"CFC" : Select when playing back CFC contents.

ⓘ “SUB” is appeared on the screen when “PARTITION” is selected on “HDD SETTING” of the <INITIALIZATION> screen.

10-2. (To change the search type •••)

Turn the JOG dial to select “SEARCH TYPE” and turn the SHUTTLE ring clockwise.

- The background of the setting item changes to red and flashes. Turn the JOG dial to display the desired search menu and confirm.
- Setting (default : “TIME DATE”)
 “TIME DATE”, “INDEX”, “ALARM INDEX”, “ALARM SKIP”, “ALARM LIST”

11. When the setting is complete, turn the SHUTTLE ring counterclockwise.

- The display returns to the <TIME DATE SEARCH> screen and the cursor appears on the left of the search date.

12. Turn the JOG dial to select “EXECUTE(FORWARD)” and turn the SHUTTLE ring clockwise.

- When the TIME DATE SEARCH is executed, the video of the set date/time (or the video closest to the search) will appear in still frame.
- The search result will appear using SPLIT9 screen when “ALL” is selected in “SELECTION CAMERA NUMBER” of the <SEARCH SELECTION> screen. If a camera number has been selected individually, the still frame will be displayed in full screen.

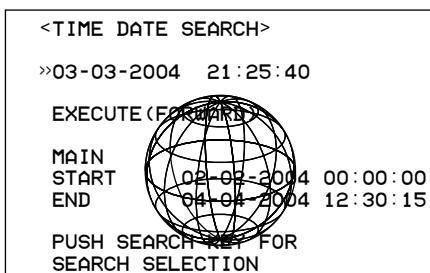

⊞ When there is no recording of the set time, the video of the closest time and date for the set camera number will be displayed in still frame.

⊞ Depending on the recording condition, TIME DATE SEARCH may not operate correctly.

ⓘ To display full screen view by selecting a camera number from the SPLIT9 screen of the search result when “ALL” is selected in the “SELECTION CAMERA NUMBER” setting, press the SEARCH button to clear the SEARCH menu and press the desired camera number button. The desired video is displayed in full screen.

ⓘ Press the camera number buttons during still image playback to call up search mode. The search mode status may continue for several hours if the number of a camera with a small number of recorded images has been specified. When not required, press the STOP button to cancel the search status.

13. To playback the searched image.

- Press either the PLAY button or the PAUSE button.

⊞ For playback, see “Various playback functions”, pages 65,66.

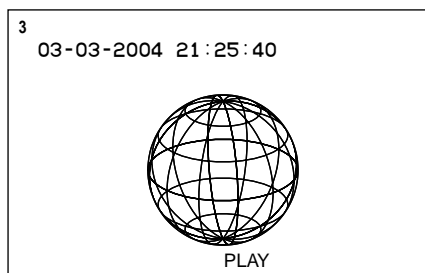

14. To stop playback/still frame playback, press the STOP button.

- The display returns to the normal screen.

15. Press the SEARCH button twice to clear the <SEARCH SELECTION> screen.

■ LANGUAGE SELECTION

With this unit, the menu screen display can be selected from 6 languages. As “ENGLISH” is selected for the initial setting, please perform setting according to the following procedure if you want to select a language other than “ENGLISH”.

Setting (default : “ENGLISH”)

- “ENGLISH”, “FRANCAIS”, “DEUTSCH”, “ESPAÑOL”, “РУССКИЙ”, “ITALIANO”

1. Press the SET UP button → <SETTINGS> → Select “LANGUAGE SELECTION” in the <INITIAL SET UP/ INFORMATION> screen and display the desired setting.

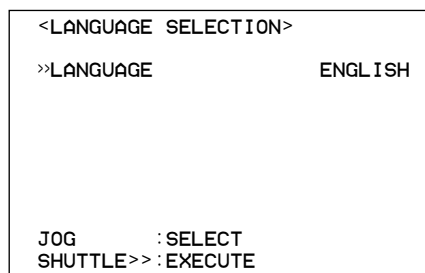

2. Turn the SHUTTLE ring counterclockwise or press the SET UP button.

Menu functions

■ MENU SETTING

You can set the basic settings for this unit in the MENU SETTING. Refer to pages shown below for details.

⌚ During playback, recording, pre-alarm recording stand-by mode you cannot change setting of some MENUS.

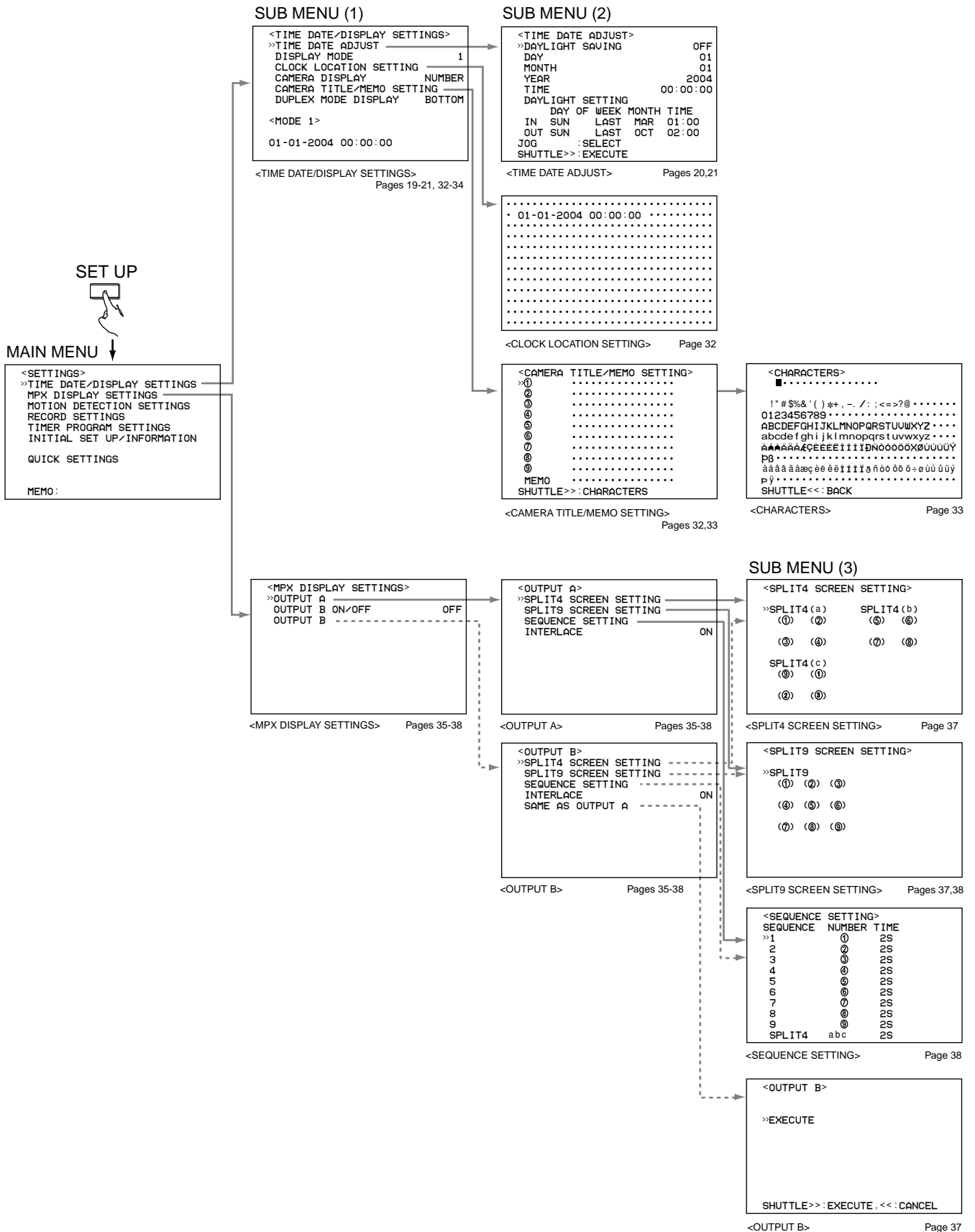

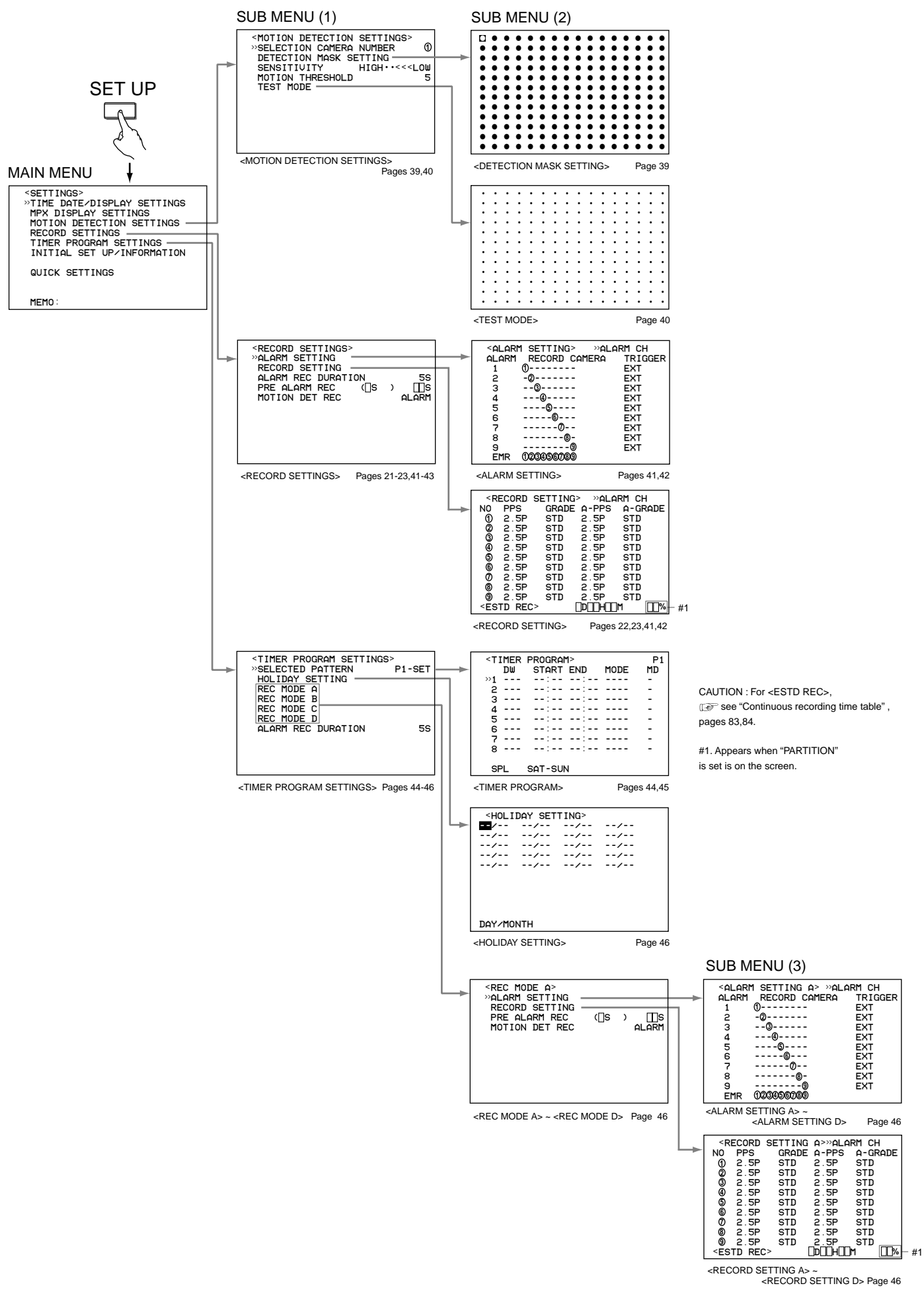

CAUTION : For <ESTD REC>, see "Continuous recording time table", pages 83,84.

#1. Appears when "PARTITION" is set is on the screen.

Menu functions (continued)

SET UP



MAIN MENU

<SETTINGS>
>>TIME DATE/DISPLAY SETTINGS
MPX DISPLAY SETTINGS
MOTION DETECTION SETTINGS
RECORD SETTINGS
TIMER PROGRAM SETTINGS
INITIAL SET UP/INFORMATION
QUICK SETTINGS
MEMO:

SUB MENU (1)

<INITIAL SET UP/INFORMATION>
>>HDD SETTINGS
AUDIO RECORDING OFF
REAR TERMINAL SETTINGS
COMMUNICATION PORT SETTINGS
INFORMATION/SERVICE
PASSWORD
LANGUAGE SELECTION

<INITIAL SET UP/INFORMATION>
Pages 47-58

SUB MENU (2)

<HDD SETTINGS>
>>HDD REPEAT REC MAIN ON
HDD REPEAT REC SUB OFF
HDD REPEAT PLAY OFF
IM-CHECK PLAY OFF
SEQUENTIAL PLAY OFF

<HDD SETTINGS> Pages 47,48

<REAR TERMINAL SETTINGS>
>>MODE OUT 1 OFF
MODE OUT 2 OFF
MODE OUT 3 OFF
MODE OUT 4 OFF
MODE OUT 5 OFF
KEY SOUND ON
BUZZER OFF
REMAIN HDD MAIN-10%
CALL OUT SETTINGS
EMERGENCY REC DURATION 10M

<REAR TERMINAL SETTINGS> Pages 49-51

<COMMUNICATION PORT SETTINGS>
>>RS-232C
ETHERNET

<COMMUNICATION PORT SETTINGS>
Pages 51-54

SUB MENU (3)

<CALL OUT SETTINGS>
>>HDD MAIN REMAIN OFF
HDD MAIN FULL OFF
HDD SUB REMAIN OFF
HDD SUB FULL OFF

<CALL OUT SETTINGS> Pages 50,51

<RS-232C>
MODE REMOTE A
>>SETTINGS

<RS-232C> Pages 51,52

<ETHERNET>
>>IP ADDRESS 192.168.000.100
SUB NET MASK 255.255.255.000
GATEWAY 000.000.000.000
E-MAIL ADDRESS
SERVICE PORT SETTING
ALARM NOTIFICATION SETTING
<MAC ADDRESS> 08-00-70-2E-3F-FF
PLEASE PRESS SET UP BUTTON TO APPLY NEW SETTING

<ETHERNET> Pages 52-54

SUB MENU (4)

<RS-232C SETTINGS>
>>TRANSMISSION MODE 9600
DATA BIT LENGTH 8BIT
PARITY BIT NONE
STOP BIT LENGTH 1BIT
DELIMITER CR

<RS-232C SETTINGS> Page 52

<E-MAIL ADDRESS>
SMTP SERVER
RECORDER ID
USER ADDRESS
1
2
3
4
5

<E-MAIL ADDRESS> Page 52

<SERVICE PORT SETTING>
>>WEB *00080
USER ACCESS 53705
SUPER USER 53706
LIVE USER1 53707
LIVE USER2 53708
LIVE USER3 53709
LIVE USER4 53710

<SERVICE PORT SETTING> Page 53

<ALARM NOTIFICATION SETTING>
NO IP ADDRESS TARGET 0W/N
>>1 000.000.000.000*55111 01111
2 000.000.000.000*55111 01112
3 000.000.000.000*55111 01113
4 000.000.000.000*55111 01114
5 000.000.000.000*55111 01115
WARNING OFF
ALARM SENS OFF
REC MODE OFF
RETRY TIME 10S

<ALARM NOTIFICATION SETTING>
Pages 53,54

SET UP



MAIN MENU

```

<SETTINGS>
>>TIME DATE/DISPLAY SETTINGS
MPX DISPLAY SETTINGS
MOTION DETECTION SETTINGS
RECORD SETTINGS
TIMER PROGRAM SETTINGS
INITIAL SET UP/INFORMATION
QUICK SETTINGS
MEMO:
    
```

SUB MENU (1)

```

<INITIAL SET UP/INFORMATION>
>>HDD SETTINGS
AUDIO RECORDING OFF
REAR TERMINAL SETTINGS
COMMUNICATION PORT SETTINGS
INFORMATION/SERVICE
PASSWORD
LANGUAGE SELECTION
    
```

<INITIAL SET UP/INFORMATION>
Pages 47-58

SUB MENU (2)

```

<INFORMATION/SERVICE> (1/2)
>>HDD INFORMATION
CFC INFORMATION
WARNING LOG LIST
RESET TO FACTORY SETTINGS
MAIN HDD DATA CLEAR
SUB HDD DATA CLEAR
CFC DATA CLEAR
    
```

<INFORMATION/SERVICE> 1/2
Pages 54-56

```

<INFORMATION/SERVICE> (2/2)
ELAPSED TIME: SYSTEM 3H
HDD SETTING PARTITION #1
PARTITION SIZE 10%
    
```

<INFORMATION/SERVICE> 2/2

SUB MENU (3)

```

<HDD INFORMATION>
INTERNAL HDD
MASTER: HDD (250GB)
SLAVE : NONE
MAIN START 01-01-2004 00:00:00
END 01-01-2004 00:00:05
SUB START 01-01-2004 00:00:00
END 01-01-2004 00:00:05
    
```

<HDD INFORMATION> Page 54

```

<CFC INFORMATION>
CFC
CAPACITY 128MB
START -----:--:--
END -----:--:--
    
```

<CFC INFORMATION> Page 54

```

<WARNING LOG LIST>
NO DATE TIME WARNING
>>0001 01-01-04 00:00:00 ALM ON
    
```

<WARNING LOG LIST> Pages 54,55

```

<RESET TO FACTORY SETTINGS>
>>EXECUTE
SHUTTLE>>:EXECUTE, <<:CANCEL
    
```

<RESET TO FACTORY SETTINGS> Page 55

```

<QUICK SETTINGS>
>>LOAD SETTING DATA FROM CFC
SAVE SETTING DATA TO CFC
    
```

<QUICK SETTINGS> Page 59

```

<SETTING DATA LOADING>
>>EXECUTE
SHUTTLE>>:EXECUTE, <<:BACK
    
```

<SETTING DATA LOADING> Page 59

```

<SETTING DATA SAVING>
>>EXECUTE
SHUTTLE>>:EXECUTE, <<:BACK
    
```

<SETTING DATA SAVING> Page 59

#1. Appears when "PARTITION" is set on the screen.

Menu functions (continued)

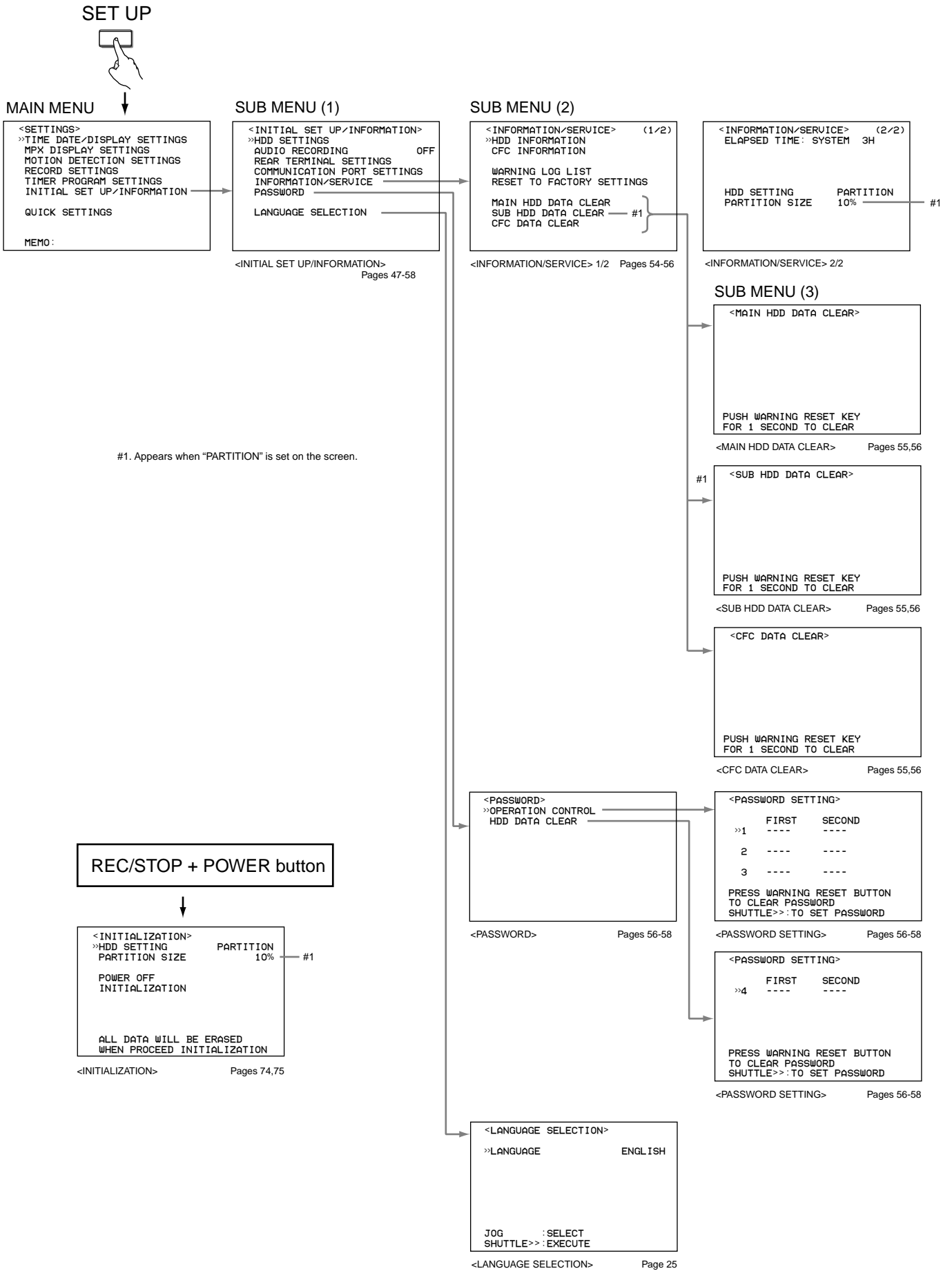

■ COPY MENU

MAIN MENU

```
<COPY>
>>DIRECTION          MAIN HDD>CFC
MODE                OVERWRITE
TRANSFER PERIOD    START·END
START              01-01-2004 00:00:00
END                01-01-2004 00:00:10

EXECUTE
```

<COPY>

Pages 72,73

```
<RESTORE>
>>DIRECTION          CFC>MAIN HDD
MODE                OVERWRITE
TRANSFER PERIOD    START·END
START              01-01-2004 00:00:00
END                01-01-2004 00:00:10

EXECUTE
```

<RESTORE>

Pages 72,73

■ SEARCH SELECTION MENU

SEARCH

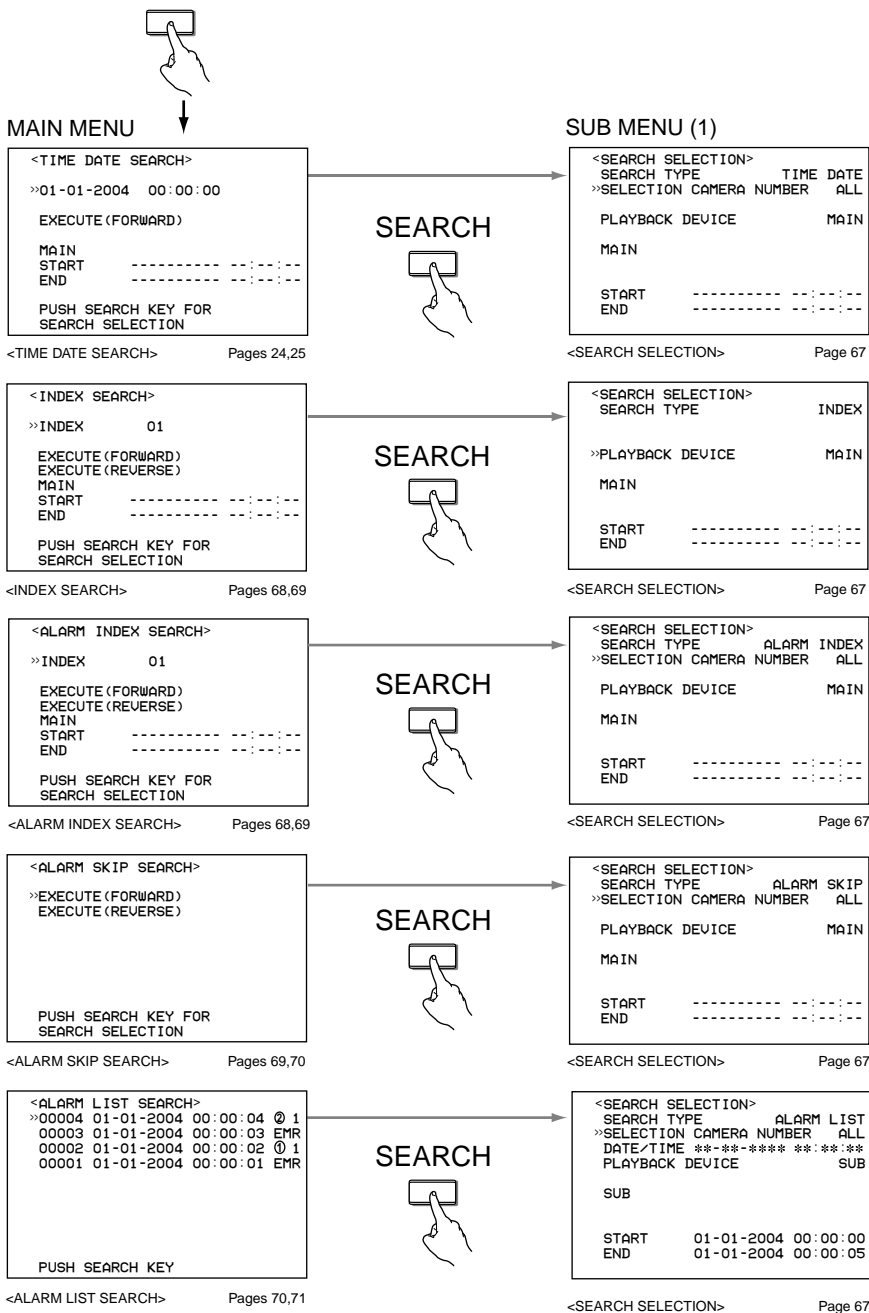

<TIME DATE/DISPLAY SETTINGS>

■ TIME DATE ADJUST

☞ See pages 20,21.

■ DISPLAY MODE

Display format of the date and current time can be set.

```
<TIME DATE/DISPLAY SETTINGS>
TIME DATE ADJUST
>>DISPLAY MODE          1
CLOCK LOCATION SETTING
CAMERA DISPLAY          NUMBER
CAMERA TITLE/MEMO SETTING
DUPLEX MODE DISPLAY     BOTTOM

<MODE 1>

01-01-2004 00:00:00
```

Setting (default : "1")

"1" : Displays the date/month/year, current time.

"2" : Displays the date/month/year, day of week, current time, playback interval (single screen playback only).

"3" : Displays the date/month/year, day of the week, time, playback interval (single screen playback only), HDD usage space (☞ see page 21) (during recording/playback only if REMAIN HDD is set to MAIN, SUB), and alarm recording number (during alarm recording/playback).

"4" : No indication.

(When alarm signal is input, displays the date/month/year, day of week, current time and alarm recording number (during alarm recording/playback)).

"5" : No indication.

(When warning signal is input, displays warning message.)

"6" : No indication.

```
<MODE 1>  01-01-2004 00:00:00

<MODE 2>  01-01-2004 THU
           00:00:00 12.5P

<MODE 3>  01-01-2004 THU
           00:00:00 12.5P 99% A00001
```

1. Press the SET UP button → <SETTINGS> → Select "DISPLAY MODE" in the <TIME DATE/DISPLAY SETTINGS> screen. Display the desired setting and confirm.

2. Turn the SHUTTLE ring counterclockwise or press the SET UP button.

■ CLOCK LOCATION SETTING

The display positions of the date, current time, camera number and title can be set.

1. Press the SET UP button → <SETTINGS> → Select "CLOCK LOCATION SETTING" in the <TIME DATE/DISPLAY SETTINGS> screen and turn the SHUTTLE ring clockwise.

• The <CLOCK LOCATION SETTING> screen appears.

```
.....
• 01-01-2004 00:00:00 .....
.....
```

2. Use the ◀, ▶, ▲ and ▼ buttons to move the time and date to the desired display position and turn the SHUTTLE ring clockwise.

• The setting is confirmed.

☞ The date, the present time, etc. on a screen can be moved to right and left and the upper and lower sides by pushing ◀, ▶, ▲ and ▼ button.

☞ The display can be moved continuously to the right by turning the JOG dial clockwise, to the left by turning it counterclockwise.

3. Turn the SHUTTLE ring counterclockwise or press the SET UP button.

■ CAMERA DISPLAY

Setting can be made to display the title and memo set in "CAMERA TITLE/MEMO SETTING", camera number only, etc.

```
<TIME DATE/DISPLAY SETTINGS>
TIME DATE ADJUST
DISPLAY MODE          1
CLOCK LOCATION SETTING
>>CAMERA DISPLAY     NUMBER
CAMERA TITLE/MEMO SETTING
DUPLEX MODE DISPLAY     BOTTOM

<MODE 1>

01-01-2004 00:00:00
```

Setting (default : "NUMBER")

"NUMBER" : Only the camera number is displayed.

"TITLE" : The title set in "CAMERA TITLE/MEMO SETTING" is displayed. The title can also be recorded along with the video.

"COMMENT" : The comment inputted by RS-232C connection is displayed.

"NONE" : No display.

1. Press the SET UP button → <SETTINGS> → Select "CAMERA DISPLAY" in the <TIME DATE/DISPLAY SETTINGS> screen. Display the desired setting and confirm.

2. Turn the SHUTTLE ring counterclockwise or press the SET UP button.

■ CAMERA TITLE/MEMO SETTING

Titles can be set individually to each connected camera. When selecting "TITLE" in "CAMERA DISPLAY", the title, such as the location of the camera, will appear on the screen for an easy-to-understand monitoring system.

☞ The maximum number of characters for the title is 16. The number of characters displayed on the screen all 16 for single screen, first 10 for SPLIT4, first 6 for SPLIT9.

Example : When setting titles of "ENTRANCE" and "COUNTER" to camera number "①" and "④", respectively, and setting memo of "BANK".

1. Press the SET UP button → <SETTINGS> → Select “CAMERA TITLE/MEMO SETTING” in the <TIME DATE/ DISPLAY SETTINGS> screen and turn the SHUTTLE ring clockwise.

- The <CAMERA TITLE/MEMO SETTING> screen appears.

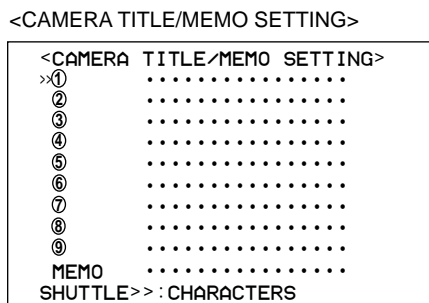

2. Turn the JOG dial to select camera number “ ① ” and turn the SHUTTLE ring clockwise.

- The <CHARACTERS> screen appears and the character on the very left of the string is displayed in reversed color.

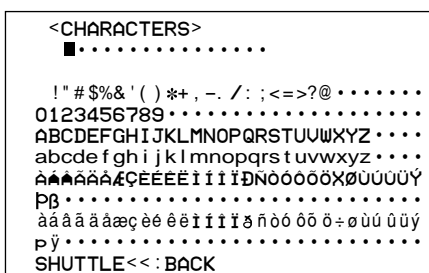

3. Turn the SHUTTLE ring clockwise.

- The very left character “ ” (space) on the bottom row of the available characters turns red and flashes.

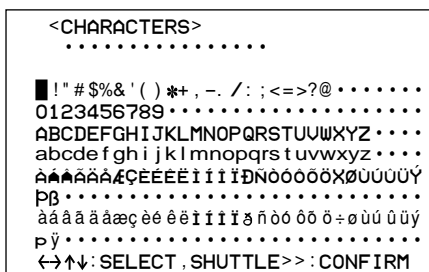

4. Use the ◀, ▶, ▲ and ▼ buttons and the JOG dial to select “E” and turn the SHUTTLE ring clockwise.

- “E” appears in reversed color on the very left of the string.

➡ The JOG dial can be turned to continuously move the cursor horizontally.

5. Turn the JOG dial clockwise to reverse display the character on the right.

6. Repeat steps 3 ~ 5 to input “ENTRANCE” in the string.

➡ To erase an inputted character, move the cursor to the very left character “ ” (space), turn the SHUTTLE ring clockwise and confirm.

➡ To change a character inputted in error :
1. While one of the characters in the string is displayed in reversed color, turn the JOG dial to reverse display the character to change.

2. Perform steps 3 and 4.

7. When completed with input, turn the SHUTTLE ring counterclockwise.

- The display returns to the <CAMERA TITLE/MEMO SETTING> screen.

8. Repeat steps 2 ~ 6 to input “COUNTER” in the camera number “ ④ ”.

Example

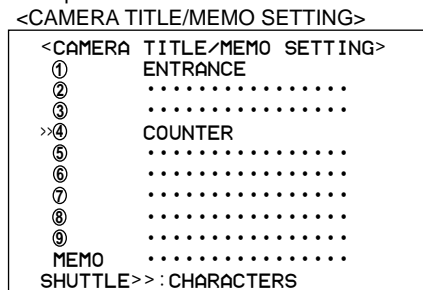

9. When completed with input, turn the SHUTTLE ring counterclockwise.

- The display returns to the <CAMERA TITLE/MEMO SETTING> screen.

10. Repeat steps 2 ~ 7 to input “BANK” in MEMO.

11. Turn the SHUTTLE ring counterclockwise or press the SET UP button.

Example <SPLIT9 SCREEN>

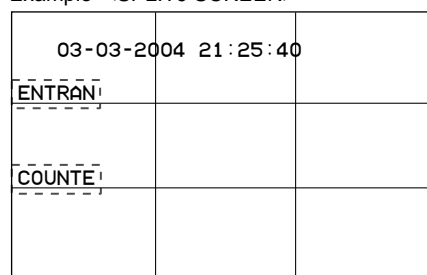

Example <MEMO SETTING>

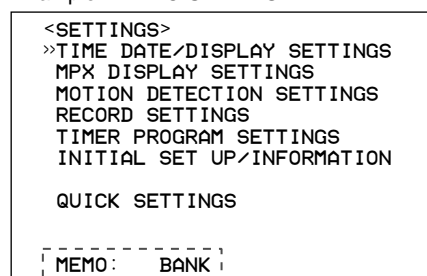

■ **DUPLEX MODE DISPLAY**

Operation conditions such as PLAYBACK, COPY, REC and ALARM REC (ALARM is displayed in red during emergency recording), etc., can be displayed on the upper or lower portions of the screen.

```
<TIME DATE/DISPLAY SETTINGS>
TIME DATE ADJUST
DISPLAY MODE                1
CLOCK LOCATION SETTING
CAMERA DISPLAY              NUMBER
CAMERA TITLE/MEMO SETTING
»DUPLEX MODE DISPLAY       BOTTOM

<MODE 1>

01-01-2004 00:00:00
```

Setting (default : "BOTTOM")

"BOTTOM" : The operation condition is displayed on the bottom of the screen.

"NONE" : The operation condition is not displayed.

"TOP" : The operation condition is displayed on the top of the screen.

1. Press the SET UP button → <SETTINGS> → Select "DUPLEX MODE DISPLAY" in the <TIME DATE/DISPLAY SETTINGS> screen. Display the desired setting and confirm.

2. Turn the SHUTTLE ring counterclockwise or press the SET UP button.

<MPX DISPLAY SETTINGS>

The multiplexer function of this unit allows the connected camera video to be displayed using SPLIT4 screen and SPLIT9 screens. It is also possible to set the order of the camera number displayed. Basic operations of the multiplexer can also be found on see page 19.

■ Multiplexer function related button operations/operation table

◆ Camera number button operations

When pressing a camera number button, the video of the camera connected to that camera number terminal is displayed using a single screen. Even during split/sequential screen display, video from any camera can be displayed using a single screen by pressing the respective camera number button.

◆ SPLIT/SEQUENCE button operations

By pressing the SPLIT/SEQUENCE button, the display modes shown below set in each split screen setting of the multiplexer setting can be displayed in order.

Available modes

“SPLIT9”, “SPLIT4(a)”, “SPLIT4(b)”, “SPLIT4(c)”, “SPLIT4 sequential”, “Single screen sequential”.

⌚ During playback, the underlined displayed modes and single screen can be selected.

⌚ The split screen setting can be set using “SPLIT4 SCREEN SETTING” and “SPLIT9 SCREEN SETTING” in the <OUTPUT A> screen and <OUTPUT B> screen respectively.

⌚ The update speed of camera video becomes slower as the quantity of camera increases. Also, when performing live communication by LAN via Ethernet, the update speed may decrease.

To return the screen to single screen display

Pressing a camera number button (1 ~ 9) cancels the split/sequential display and returns to the single screen display of the pressed camera number button. Pressing the SPLIT/SEQUENCE button again returns the screen to the split/sequential display previous to cancelling.

⚠ When a menu screen is displayed, the single screen display will not appear even when pressing a camera number button (1 ~ 9). In this case, clear the menu screen and then press a camera number button (1 ~ 9).

◆ ZOOM button operations

By pressing the ZOOM button in single screen display, the displayed video can be viewed at 100%, 200% or 400% magnification.

⚠ If the OUTPUT B indicator is turned off in the screen of OUTPUT A, the ZOOM button will function. The ZOOM button does not function when the OUTPUT B indicator illuminates by pressing the OUTPUT B button.

⚠ The magnification display function can only be set when in the single screen mode. The screen can be moved vertically and horizontally with the magnification centre point (X) as the axis by pressing the MOVE buttons.

1. Press the ZOOM button during single screen display.
 - “X1” appears on the top left the single screen display and the magnification centre point (X) appears at the centre of the screen.

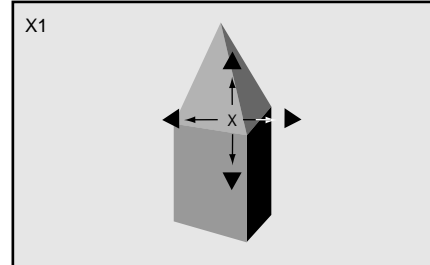

2. To shift the screen vertically or horizontally, press the ◀, ▶, ▲ and ▼ buttons.

⌚ The position of the magnification centre point is stored even when the display screen is switched or the power is turned off. This is convenient when the point to magnify is determined in advance.

3. Press the ZOOM button.

• Pressing the button each time switches the magnification in order of X2(200%), X4(400%), normal and X1(100%).

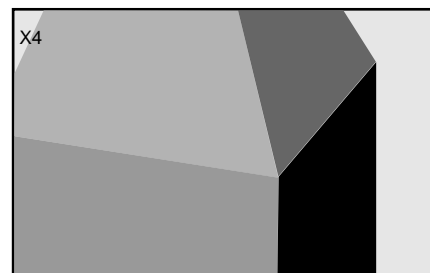
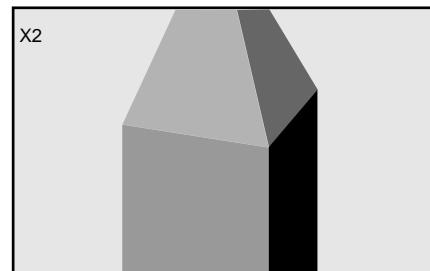

⌚ The magnification function can also be used during playback of recorded contents.

INFORMATION

A black screen may appear when pausing recorded video of multiple cameras in the single screen display mode and magnifying. In this case, display the magnified screen by turning the JOG dial and forwarding a frame.











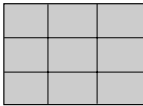

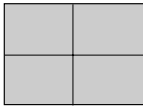

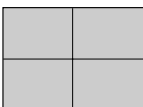
INFORMATION

The magnification display function of this unit uses digital magnification and screen details may appear pixelized when magnifying.

<MPX DISPLAY SETTINGS> (continued)

■ The function of the SPLIT/SEQUENCE button, ZOOM button, and camera number buttons

ⓘ The screen of cameras with no video input signal will appear blue. Furthermore, the screen of cameras set to "OFF" for COVERT CAMERA SETTING will appear black (see page 76).

Display	SPLIT/SEQUENCE button	ZOOM button	Illuminating/Off of Camera number buttons	Page	
SPLIT9 	OFF  SPLIT/SEQUENCE	ZOOM  OFF	The video of camera number selected in <OUTPUT A> (<OUTPUT B>) → <SPLIT9 SCREEN SETTING> screen is displayed using SPLIT9 display. During video display, the corresponding camera number button lights.	37,38	
SPLIT4 (a) SPLIT4 (b) SPLIT4 (c) 	OFF  SPLIT/SEQUENCE	ZOOM  OFF	The video of camera number selected in <OUTPUT A> (<OUTPUT B>) → <SPLIT4 SCREEN SETTING> screen is displayed using SPLIT4 display. During video display, the corresponding camera number button lights.	37	
SPLIT4 Sequential  SPLIT4 sequential screen can be switched.	Illuminating  SPLIT/SEQUENCE	ZOOM  OFF	The SPLIT4 screen video set in <OUTPUT A> (<OUTPUT B>) → <SEQUENCE SETTING> screen is displayed and updated in order by the set switching time. During video display, the corresponding camera number button lights.	38	
Single screen Sequential  Single screen sequential can be switched.	Illuminating  SPLIT/SEQUENCE	ZOOM  OFF	The single screen video set in <OUTPUT A> (<OUTPUT B>) → <SEQUENCE SETTING> screen is displayed and updated in order by the set switching time. During video display, the corresponding camera number button lights.	38	
Single screen	Not enlarged	OFF  SPLIT/SEQUENCE	ZOOM  OFF	Camera number button which has display is illuminating.	35
	Enlarged	OFF  SPLIT/SEQUENCE	ZOOM  Illuminating	Camera number buttons which has been activated as 100%, 200% or 400% will be illuminated. Not available the magnification function when the OUTPUT B indicator illuminates.	35
During Alarm recording and Motion detection recording *If the Alarm signal is input during SPLIT/ SEQUENCE mode.	/	/	Regardless of SPLIT9, SPLIT4 or Single screen, camera number buttons which are activated via the Alarm recording start flashing.	-	

■ MPX DISPLAY SETTINGS

With this unit, the multiplexer settings for the <OUTPUT A> screen for the monitor video connected to the OUTPUT A terminal and the analog output terminal and the multiplexer settings for the <OUTPUT B> screen for live-only monitor video connected to the OUTPUT B terminal can be set individually.

```
<MPX DISPLAY SETTINGS>
>>OUTPUT A
  OUTPUT B ON/OFF          OFF
  OUTPUT B
```

```
<OUTPUT A>
>>SPLIT4 SCREEN SETTING
  SPLIT9 SCREEN SETTING
  SEQUENCE SETTING
  INTERLACE                ON
```

```
<OUTPUT B>
>>SPLIT4 SCREEN SETTING
  SPLIT9 SCREEN SETTING
  SEQUENCE SETTING
  INTERLACE                ON
  SAME AS OUTPUT A
```

❗ Select "ON" in the "OUTPUT B ON/OFF" to display the live monitor video of OUTPUT B on the screen. When the setting is kept "OFF" in the "OUTPUT B ON/OFF", the live monitor video of OUTPUT B is not displayed.

⏪ When set the multiplexer setting of the <OUTPUT B> screen the same as the setting of the <OUTPUT A> screen, turn the JOG dial to move the cursor to "SAME AS OUTPUT A" on the <OUTPUT B> screen and turn the SHUTTLE ring clockwise.

⏪ When the ZOOM button is kept pressed for at least 1 sec, the operation of the camera No. button and the SPLIT/SEQUENCE button is switched to the operation for OUTPUT A (monitor video connected to the OUTPUT A terminal and the analog output terminal) and OUTPUT B (monitor video connected to the OUTPUT B terminal).

■ SPLIT4 SCREEN SETTING

For the SPLIT4 SCREEN SETTING, 3 types of SPLIT4 screen types (a, b and c) can be set.

1. Press the SET UP button → <SETTINGS> → Select "OUTPUT A" ("OUTPUT B") in the <MPX DISPLAY SETTINGS> screen and turn the SHUTTLE ring clockwise.

• The <OUTPUT A> (<OUTPUT B>) screen appears.

2. Turn the JOG dial to select "SPLIT4 SCREEN SETTING" and turn the SHUTTLE ring clockwise.

• The <SPLIT4 SCREEN SETTING> screen appears.

```
<SPLIT4 SCREEN SETTING>
>>SPLIT4 (a)      SPLIT4 (b)
  (①) (②)        (⑤) (⑥)

  (③) (④)        (⑦) (⑧)

  SPLIT4 (c)
  (⑨) (⑩)
```

3. Turn the JOG dial to select the split display to set (a, b or c) and turn the SHUTTLE ring clockwise.

• The (most upper left) camera number reverses in color.

4. Turn the JOG dial to move to the camera number with the reversed display and turn the SHUTTLE ring clockwise.

• The background of the camera number turns red and flashes.

5. Turn the JOG dial to display the camera number to set and turn the SHUTTLE ring clockwise.

• Flashing stops.

❗ The same camera number can be set multiple times on the split screen display. When multiple settings with the same camera number have been made, the playback image is displayed at the camera location with the lowest number.

6. Repeat steps 4 and 5 to set the desired camera number.

7. When completed with setting, turn the SHUTTLE ring counterclockwise.

• Setting is confirmed and the cursor appears.

8. To set other split screen displays, repeat steps 3 ~ 7.

9. When completed with all settings, turn the SHUTTLE ring counterclockwise or press the SET UP button.

❗ The <SPLIT4 SCREEN SETTING> screen cannot be exited when camera number is flashing.

■ SPLIT9 SCREEN SETTING

For the SPLIT9 SCREEN SETTING, SPLIT9 screen can be set.

1. Press the SET UP button → <SETTINGS> → Select "OUTPUT A" ("OUTPUT B") in the <MPX DISPLAY SETTINGS> screen and turn the SHUTTLE ring clockwise.

• The <OUTPUT A> (<OUTPUT B>) screen appears.

2. Turn the JOG dial to select "SPLIT9 SCREEN SETTING" and turn the SHUTTLE ring clockwise.

• The <SPLIT9 SCREEN SETTING> screen appears.

```
<SPLIT9 SCREEN SETTING>
>>SPLIT9
  (①) (②) (③)

  (④) (⑤) (⑥)

  (⑦) (⑧) (⑨)
```

3. Turn the SHUTTLE ring clockwise.

• The (most upper left) camera number reverses in color.

4. Turn the JOG dial to move to the camera number with the reversed display and turn the SHUTTLE ring clockwise.

• The background of the camera number turns red and flashes.

<MPX DISPLAY SETTINGS> (continued)

5. Turn the JOG dial to display the camera number to set and turn the SHUTTLE ring clockwise.

- Flashing stops.

① The same camera number can be set multiple times on the split screen display. When multiple settings with the same camera number have been made, the playback image is displayed at the camera location with the lowest number.

6. Repeat steps 4 and 5 to set the desired camera number.

7. When completed with setting, turn the SHUTTLE ring counterclockwise.

- Setting is confirmed and the cursor appears.

9. Turn the SHUTTLE ring counterclockwise or press the SET UP button.

① The <SPLIT9 SCREEN SETTING> screen cannot be exited when camera number is flashing.

■ SEQUENCE SETTING

The display order of connected camera video can be switched automatically or the switching time can be set. Furthermore, the 3 types of split screen displays set in "SPLIT4 SCREEN SETTING", "SPLIT9 SCREEN SETTING" can be switched automatically or the same camera can be displayed repeatedly.

1. Press the SET UP button → <SETTINGS> → Select "OUTPUT A" ("OUTPUT B") in the <MPX DISPLAY SETTINGS> screen and turn the SHUTTLE ring clockwise.

- The <OUTPUT A> (<OUTPUT B>) screen appears.

2. Turn the JOG dial to select → "SEQUENCE SETTING" and turn the SHUTTLE ring clockwise.

- The <SEQUENCE SETTING> screen appears.

<SEQUENCE SETTING>

<SEQUENCE SETTING>		
SEQUENCE	NUMBER	TIME
>>1	①	2S
2	②	2S
3	③	2S
4	④	2S
5	⑤	2S
6	⑥	2S
7	⑦	2S
8	⑧	2S
9	⑨	2S
SPLIT4	abc	2S

3. Select the desired display order (① ~ ⑨) and turn the SHUTTLE ring clockwise twice.

- The camera number display reverses in color when the SHUTTLE ring is turned the first time. When the ring is turned for the second time, the background turns red and flashes.

- Setting

" ① ", " ② ", " ③ ", " ④ ", " ⑤ ", " ⑥ ", " ⑦ ", " ⑧ ",
" ⑨ ", " - "

" - " : No display.

4. Display the desired camera number to display and turn the SHUTTLE ring clockwise.

- The setting is confirmed.

5. Turn the JOG dial clockwise to shift the reversed display to "TIME" and turn the SHUTTLE ring clockwise.

- The background of the "TIME" setting turns red and flashes.

6. Display the desired time and turn the SHUTTLE ring clockwise.

- The setting is confirmed and flashing stops.
- The time can be set at 1 second intervals (max. 30 seconds).

7. Turn the SHUTTLE ring counterclockwise.

- The cursor appears to sequence number on the left.

8. Repeat steps 3 ~ 7 to set other display orders of camera number and time.

9. (When setting switching for SPLIT4 sequential display ●●●) Select "SPLIT4" and turn the SHUTTLE ring clockwise twice.

- The setting reverses in color when the SHUTTLE ring is turned the first time. When the ring is turned for the second time, the background turns red and flashes.

10. Display the desired item to set and turn the SHUTTLE ring clockwise.

- The setting is confirmed.
- Setting of "SPLIT4" (default : SPLIT4 "abc")
"abc" : SPLIT4(a), (b) and (c) are displayed using sequence display.

"ab" : SPLIT4(a) and (b) are displayed using sequence display.

"a" : SPLIT4(a) is displayed using sequence display.

11. Turn the JOG dial clockwise to shift the reversed display to "TIME" and turn the SHUTTLE ring clockwise.

- The background of the "TIME" setting turns red and flashes.

12. Display the desired time and turn the SHUTTLE ring clockwise.

- The setting is confirmed and flashing stops.

13. Turn the SHUTTLE ring counterclockwise.

- The cursor appears to "SPLIT4" on the left.

14. When completed with all settings, turn the SHUTTLE ring counterclockwise or press the SET UP button.

■ INTERLACE

The picture quality when splitting the screen of camera video can be set.

<OUTPUT A>	
SPLIT4 SCREEN SETTING	
SPLIT9 SCREEN SETTING	
SEQUENCE SETTING	
>>INTERLACE	ON

Setting (default : "ON")

"ON" : Video is displayed in detail.

"OFF" : Screen flickering is reduced.

① Although screen flickering of video during SPLIT4 and SPLIT9 screen display can be reduced when setting "INTERLACE" to "OFF", the vertical resolution will drop.

1. Press the SET UP button → <SETTINGS> → Select "OUTPUT A" ("OUTPUT B") in the <MPX DISPLAY SETTINGS> screen and turn the SHUTTLE ring clockwise.

- The <OUTPUT A> (<OUTPUT B>) screen appears.

2. Turn the JOG dial to select "INTERLACE" and display the desired setting and confirm.

3. Turn the SHUTTLE ring counterclockwise or press the SET UP button.

<MOTION DETECTION SETTINGS>

In this menu, the conditions of the motion detection function for normal recording and alarm recording, which is started when detecting motion within the video of the connected camera, are set.

■ SELECTION CAMERA NUMBER

The camera for motion detection setting is selected. Since settings can be made for each camera, more detailed settings are possible.

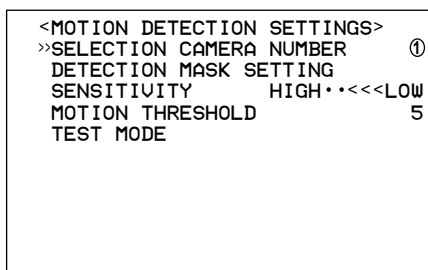

Setting (default : " ① ")

" ① ", " ② ", " ③ ", " ④ ", " ⑤ ", " ⑥ ", " ⑦ ", " ⑧ ", " ⑨ "

ⓘ When selecting the <MOTION DETECTION SETTINGS> screen during single screen display of any specified camera number, that camera will be displayed as the initial value of "SELECTION CAMERA NUMBER".

1. Press the SET UP button → <SETTINGS> → Select "SELECTION CAMERA NUMBER" in the <MOTION DETECTION SETTINGS> screen. Display the desired setting and confirm.

➡ Confirm the "SELECTION CAMERA NUMBER" setting to switch the background to the video of the selected camera number.

2. Turn the SHUTTLE ring counterclockwise or press the SET UP button.

ⓘ The motion detection function will not operate when the <MOTION DETECTION SETTINGS> screen is displayed.

■ DETECTION MASK SETTING

The area to activate motion detection is set here. Any of the 192 dotted detection areas displayed by splitting individually loaded video to equal 16 X 12 pixel sizes can be selected and set.

Definition of setting mark (default : all areas " ● " (active))

" ● " : Area activated with motion detection.

" • " : Area inactivated with motion detection.

➡ It is possible to set various areas per camera.

Example of screen setting

For the video loaded from the camera set in "SELECTION CAMERA NUMBER" :

• Display " ● " for the right half of the screen to activate motion detection.

• Display " • " for the left half of the screen to inactivate motion detection.

1. In "SELECTION CAMERA NUMBER", select the camera for setting the detection area.

2. Select "DETECTION MASK SETTING" and turn the SHUTTLE ring clockwise.

• The dotted screen with detection areas is displayed and the background of the most upper left dot turns red and flashes.

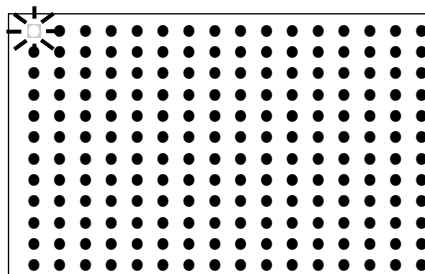

3. Use the ◀, ▶, ▲ and ▼ buttons to select the dot to activate/inactivate and press the camera number button ⑧.

• The " ● " (active) setting changes to " • " (inactive) setting.

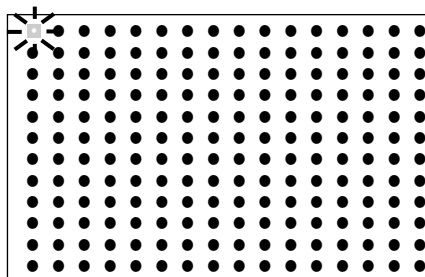

➡ When pressing the SPLIT/SEQUENCE button, all dots change to " ● " (active). When pressing the ZOOM button, all dots change to " • " (inactive).

➡ When pressing the camera number ⑧ button, dot change to " • " (inactive). When pressing the camera number ⑨ button, dot change to " ● " (active).

4. Repeat step 3 to activate/inactivate all desired dots.

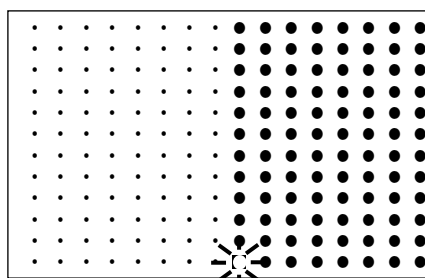

5. Turn the SHUTTLE ring counterclockwise.

• The setting is confirmed and the display returns to the <MOTION DETECTION SETTINGS> screen.

ⓘ During set detection mask setting, other settings are not accepted. To exit the menu screen during setting, turn the SHUTTLE ring counterclockwise.

<MOTION DETECTION SETTINGS> (continued)

■ SENSITIVITY

The sensitivity of detection for changes in the loaded video data is set. The sensitivity setting is divided into the 5 levels of brightness.

```

<MOTION DETECTION SETTINGS>
SELECTION CAMERA NUMBER ①
DETECTION MASK SETTING
>>SENSITIVITY HIGH••<<<LOW
MOTION THRESHOLD 5
TEST MODE
    
```

Setting (default : "HIGH •• <<< LOW")

"HIGH • • • • < LOW", "HIGH • • • • < < LOW",
 "HIGH • • • < < < LOW", "HIGH • • • < < < < LOW",
 "HIGH < < < < < LOW"

➡ Sensitivity increases as "<" increases from "HIGH • • • • < LOW" to "HIGH < < < < < LOW".

➡ To detect the slightest changes, set to "HIGH < < < < < LOW". However, detection may not operate properly due to flickering of fluorescent lighting, etc.

1. Select the camera to set the sensitivity in "SELECTION CAMERA NUMBER" (☞ see page 39).

2. Display the desired setting in "SENSITIVITY" and turn the SHUTTLE ring clockwise.
 • The setting is confirmed.

■ MOTION THRESHOLD

The minimum number of dots for starting the motion detection operation from the number of active dots within the detection area is set here. Motion detection operates when change that exceeds the number of minimum dot set is detected.

```

<MOTION DETECTION SETTINGS>
SELECTION CAMERA NUMBER ①
DETECTION MASK SETTING
SENSITIVITY HIGH••<<<LOW
>>MOTION THRESHOLD 5
TEST MODE
    
```

Setting (default : "5")

" 1 ", " 2 ", ••, " 5 ", •••, "191", "192"

① For MOTION THRESHOLD, set the number of active dots in the detection area as the upper limit. The motion detection function will not operate when setting a value that exceeds this number.

1. Select the camera to set the motion threshold in "SELECTION CAMERA NUMBER" (☞ see page 39).

2. Display the desired setting in "MOTION THRESHOLD" and turn the SHUTTLE ring clockwise.
 • The setting is confirmed.

■ TEST MODE

The set motion detection operation is tested here.

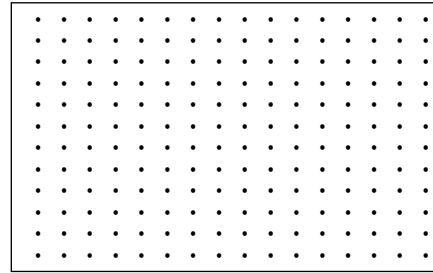

1. In "SELECTION CAMERA NUMBER" (☞ see page 39), select the camera to test operates.

2. Select "TEST MODE" and turn the SHUTTLE ring clockwise.
 • The operation test begins.

3. To end "TEST MODE", turn the SHUTTLE ring counter-clockwise.

- During test operation, active areas of motion detection are displayed using "•". The screen displays "●" when motion that meets the each condition of sensitivity and number of dots for recording start is detected. If the motion detection does not operate properly, set the conditions again.
- The red "●" display may be overdue to an actual motion.

Cautionary items concerning motion detection

• If changes are detected repeatedly, alarm recording is also started repeatedly. Thus functions such as setting change, etc., will not be accepted. In this case, press the ALARM INTERRUPT button to forcibly stop the motion detection function for a period of 5 minutes. During, this time, settings can be changed. This manual stop is automatically restored after 5 minutes and the history of the manual stop is left in the history of the WARNING LOG LIST. To cancel the alarm interrupt, press the ALARM INTERRUPT button again.

• Even if the motion detection setting is active ALARM IN terminal on the rear is constantly given priority over the others.

• The M-DET indicator lights when the motion detection function is in operation.

• When the SENSITIVITY is set too high, sometimes it can cause the incorrect detection. Please watch out for erroneous operation in case of connection to a system with signaling using the motion detection of this unit.

• To perform alarm recording with the motion detection function, set "TRIGGER" in the <ALARM SETTING> screen to MD, MD/EXT or MD&EXT, set the "MOTION DET REC" in the <RECORD SETTING> screen to "ALARM" and set the recording intervals of "A-PPS" of desired camera for alarm recording in the <RECORD SETTING> screen.

• Motion detection will not operate while making settings in the <MOTION DETECTION SETTINGS>.

<RECORD SETTINGS>

■ Settings concerning normal recording and alarm recording

This unit allows independent settings for normal recording and alarm recording. By this, more detailed settings are possible such as changing the recording intervals of the camera inputting the alarm signals while maintaining the normal recording settings as they are.

ⓘ Certain settings and mode changes are limited during Alarm recording. Pressing the ALARM INTERRUPT button halts additional alarm inputs, and lifts the limitations by stopping recording.

ⓘ During recording, the setting in the <RECORD SETTING> screen cannot be changed.

ⓘ When the cameras for recording are not input video signal, warning display of "NO SIGNAL" appears (for details, see "Warnings and CALL OUT output" pages 87,88).

■ Recording mode settings for normal recording and alarm recording

Setting of the camera number for alarm recording and emergency recording, the TRIGGER for alarm recording, the recording intervals and recording picture quality for normal recording and alarm recording and whether to perform pre-alarm recording for alarm recording can be set here (for normal recording, see "Basic manual recording" pages 21-23). Pre-alarm recording is a function to start recording before the ALARM IN terminal on the rear of the unit is grounded or motion is detected (for details concerning pre-alarm recording, see page 64).

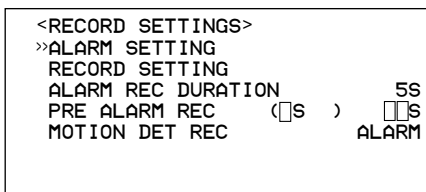

1. Press the SET UP button → <SETTINGS> → Select "ALARM SETTING" in the <RECORD SETTINGS> screen and turn the SHUTTLE ring clockwise.

• The <ALARM SETTING> screen appears.

<ALARM SETTING>
Camera selection during alarm recording

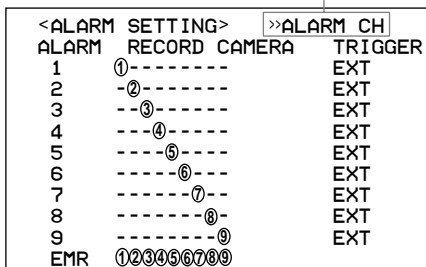

2. (When setting the camera selection during alarm recording ...)

Turn the JOG dial and move the cursor to camera selection item for alarm recording and turn the SHUTTLE ring clockwise.

• The background of setting turns red and flashes.

• Setting (default : "ALARM CH")

"ALARM CH" : Alarm recording is performed for only the cameras set for alarm recording and inputted with alarm signals. When there is input of alarm signals from multiple cameras, alarm recording is performed for all cameras containing alarm signals.

"ALARM PLUS" : Recording is performed in the frame speed set in "A-PPS" for the camera inputted with alarm signals during normal recording. All other cameras will be recording in the normal frame intervals.

"ALARM25" : Recording is performed so that normal recording and alarm recording each are up to max. 25 frames. With playback of a recording where an alarm recording has occurred during normal recording, there will be no recording interval display.

3. Display the desired item to set and turn the SHUTTLE ring clockwise.

• The setting is confirmed and flashing stops.

4. (When setting "RECORD CAMERA" (the alarm recording camera) and "TRIGGER" ...)

Turn the JOG dial to select the desired "ALARM" (alarm sensor input number) and turn the SHUTTLE ring clockwise.

• The first item from the left side in the "RECORD CAMERA" setting display reverses in color.

• The camera numbers are lined in order of the number from "①" to "⑨". Multiple camera numbers can be selected for one alarm camera channel number.

⊖ When turn the JOG dial counterclockwise, the camera number setting or the TRIGGER setting will reverses in color in order such as ①, EXT, ⑨, ⑧ ...

5. Turn the JOG dial to display the desired camera number reversed in color and turn the SHUTTLE ring clockwise.

• The background of setting turns red and flashes.

ⓘ While the setting is flashing, the setting screen cannot be exited even when pressing the SET UP button.

6. Turn the JOG dial to display the desired setting and turn the SHUTTLE ring clockwise.

• The setting is confirmed and flashing stops.

⊖ Two or more camera numbers can be chosen to one sensor input.

7. Turn the JOG dial clockwise to display "TRIGGER" setting reversed in color and turn the SHUTTLE ring clockwise.

• The background of setting turns red and flashes.

8. Turn the JOG dial to display the desired setting and turn the SHUTTLE ring clockwise.

• The setting is confirmed and flashing stops.

• Setting of "TRIGGER" (default : "EXT")

"EXT" : Alarm recording can only be started when the ALARM IN terminal is grounded.

"MD&EXT" : Alarm recording can be started when the ALARM IN terminal is grounded and the motion is detected simultaneously.

"MD/EXT" : When the ALARM IN terminal is grounded or motion is detected alarm recording is started.

"MD" : Alarm recording can only be started when the motion is detected.

<RECORD SETTINGS> (continued)

9. (When setting the emergency recording camera •••)
Turn the JOG dial and move the cursor to "EMR" and turn the SHUTTLE ring clockwise.

- The first item from the left side in the "ALARM RECORD CAMERA" setting display reverses in color.

10. Repeat steps 5, 6 for settings.

11. When the setting is complete, turn the SHUTTLE ring counterclockwise.

- The cursor moves to the camera number on the left.
- When continuing with other camera number settings, turn the JOG dial to move the cursor to the desired camera number and repeat steps 4 ~ 11 to perform the settings.

12. (When setting recording intervals and recording picture quality •••)

Press the SET UP button → <SETTINGS> → Select "RECORD SETTING" in the <RECORD SETTINGS> screen and turn the SHUTTLE ring clockwise.

- The <RECORD SETTING> screen appears.

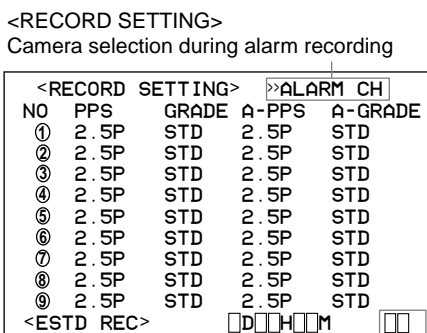

Appears when "PARTITION" is set.

CAUTION : For <ESTD REC>, see "Continuous recording time table", pages 83,84.

About <ESTD REC>

- The estimated recordable time is displayed as <ESTD REC> depending on the "PPS" and "GRADE" settings. (The time will not change when changing the alarm recording settings.)

☑ The storage area in MAIN HDD set in "PARTITION" is displayed with the percentage (%) and the recordable time of that storage area is displayed in "<ESTD REC>".

13. (When setting the recording intervals and recording picture quality for normal recording •••)

Turn the JOG dial to select the desired camera number and turn the SHUTTLE ring clockwise twice.

- The background of the "PPS" display changes to red and flashes.
- Setting of "PPS" (default : "2.5P")
"5P", "2.5P", "1.667P", "1.25P", "1P", "0.833P", "0.625P", "0.5P", "0.2P", "0.1P", "0.05P", "0.025P", "-----"

"-----" : Recording cannot be performed with camera set to this item.

☑ Pressing the WARNING RESET button while the cursor is on the left of the desired camera number changes that camera's "PPS" and "A-PPS" to "-----".

☑ For details concerning normal recording settings, see "Setting the recording interval and recording picture quality for normal recording" pages 22,23.

14. Display the desired item to set and turn the SHUTTLE ring clockwise.

- The setting is confirmed and flashing stops.

15. Turn the JOG dial clockwise to reverse display the "GRADE" setting and turn the SHUTTLE ring clockwise.

- The background of the "GRADE" display changes to red and flashes.
- Setting of "GRADE" (default : "STD")
"SUPER", "HIGH", "STD"(STANDARD), "BASIC", "LONG"

16. Display the desired item to set and turn the SHUTTLE ring clockwise.

- The setting is confirmed and flashing stops.

17. (When setting recording intervals and recording picture quality for alarm recording •••)

Repeat steps 13 ~ 16 and select desired settings for "A-PPS" and "A-GRADE" as well.

18. When the setting is complete, turn the SHUTTLE ring counterclockwise.

- The cursor moves to the camera number directly to the left.

19. When continuing with other camera number, turn the JOG dial to move the cursor to the desired camera number and repeat steps 13 ~ 18 for settings.

20. When completed with all settings, turn the SHUTTLE ring counterclockwise or press the SET UP button.

About alarm recording

- If alarm recording or emergency recording is entered during timer recording, recording is stopped at the stop time set for time recording.
- If "TRIGGER" for <ALARM SETTING> is set to "MD/EXT", the last alarm entered takes priority.
- If "TRIGGER" for <ALARM SETTING> is set to "MD/EXT" and <ALARM REC DURATION> is set to "MANUAL", alarm recording will stop 2 seconds after entering if MOTION DETECTION is entered afterwards even if the ALARM IN terminal is grounded.
- If there is a power outage during alarm recording or emergency recording, alarm recording and emergency recording are released after power is restored.

■ ALARM REC DURATION

The recording time during alarm recording can be set.

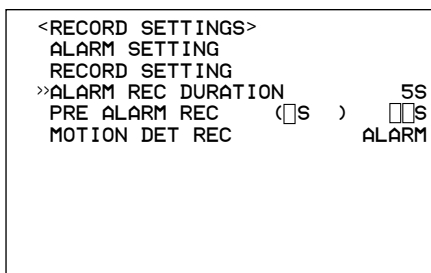

Setting (default : "5S")

"2S", "5S", "10S", "15S", "30S", "45S", "1M", "2M", "5M", "10M", "20M", "30M", "60M", "MANUAL"

"MANUAL" : Alarm recording is continued until the grounding of the ALARM IN terminals is cancelled.

1. Press the SET UP button → <SETTINGS> → Select "ALARM REC DURATION" in the <RECORD SETTINGS> screen. Display the desired setting and confirm.

2. Turn the SHUTTLE ring counterclockwise or press the SET UP button.

■ PRE ALARM REC

The pre-alarm recording can be set.

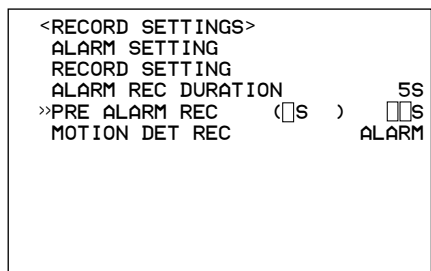

Setting (default : "0S")

"0S", "1S", "2S", "•••••", "58S", "59S", "60S", "90S", "120S", "150S", "180S"

⚠ When "0S" is selected, the pre-alarm recording is inoperable.

ⓘ The maximum pre-alarm recordable time is displayed in "()". Beware that when set the pre-alarm recording time longer than the maximum the settings will turn red. Set the time within the recording time limit, so that the display returns to white. Even if the time is set beyond the limit, Pre-Alarm recording time is not changed.

1. Press the SET UP button → <SETTINGS> → Select "PRE ALARM REC" in the <RECORD SETTINGS> screen, and display the desired setting.

2. Turn the SHUTTLE ring counterclockwise or press the SET UP button.

■ MOTION DET REC

Select whether alarm recording or normal recording is to be started when motion is detected.

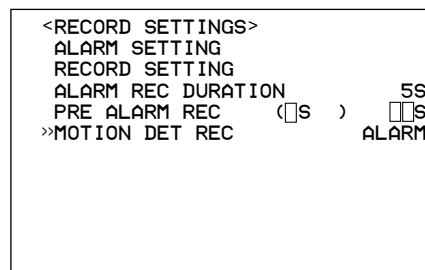

Setting (default : "ALARM")

"ALARM" : Alarm recording is started when the motion is detected.

"NORMAL" : Normal recording is started when the motion is detected.

ⓘ When "NORMAL" is selected by "MOTION DET REC" setting during alarm partition employment, data is recorded on HDD(MAIN). When playing back recorded data, please select "MAIN" in the "PLAYBACK DEVICE" setting.

1. Press the SET UP button → <SETTINGS> → Select "MOTION DET REC" in the <RECORD SETTINGS> screen, and display the desired setting.

2. Turn the SHUTTLE ring counterclockwise or press the SET UP button.

<TIMER PROGRAM SETTINGS>

■ TIMER PROGRAM SETTINGS

Up to 3 most used operation patterns can be set in advance. By individually setting the camera, recording intervals and recording picture quality for normal recording/ alarm recording to A ~ D, settings can be changed instantly by switching operations and is very convenient.

① Before recording, accurately set the date and current time (for setting the date and time, see pages 20,21).

■ TIMER PROGRAM

◆ Structure of the <TIMER PROGRAM> screen

1) 2) 3) 4) 5) 6) 7) 8)	<TIMER PROGRAM>							P1
	DW	START	END	MODE				MD
>> 1	---	---	---	---	---	---	---	-
2	---	---	---	---	---	---	---	-
3	---	---	---	---	---	---	---	-
4	---	---	---	---	---	---	---	-
5	---	---	---	---	---	---	---	-
6	---	---	---	---	---	---	---	-
7	---	---	---	---	---	---	---	-
8	---	---	---	---	---	---	---	-
	SPL	SAT-SUN						9)

1) PROGRAM NUMBER

Up to 8 programs can be set for a single operation.

2) DW

The day of week from "SUN" to "SAT" can be set. "DAY" : When recording at the same time daily.

"SPL" : When recording the period specified in "9) SPL (special day of the week setting)" below.

"HOL" : When setting holidays specified in the <HOLIDAY SETTING> screen.

3) REC START TIME

The time is indicated using the 24-hour system.

① If there is an overlap in the reservation time, the program with the larger program number is given priority for recording.

4) NEXT DAY

Next day mark appears when recording is to be carried over to the following day.

5) REC END TIME

6) MODE

"A" ~ "D" : When recording using the camera operation type and recording intervals set in "REC MODE A" ~ "REC MODE D" of the <TIMER PROGRAM SETTINGS> screen (for details concerning REC mode settings, see pages 22,23).

"SKIP" : When temporarily skipping timer recording (the recording will not be made for the specified time frame of that program number).

7) MD

The motion detection function can be set to ON/OFF.

8) Select timer setting number (P1 ~ P3) is displayed.

9) SPL (special day of the week setting)

The start day of the week and end day of the week are set. When selecting "SPL" in "DW", the period from the start day of the week and end day of the week set here are active.

Example : Using program 1 in <TIMER PROGRAM> P2, REC MODE A will record to Wednesday ~ Saturday from 12:30 to 13:00 and "MD" is set to "ON".

1. Press the SET UP button → <SETTINGS> → select "TIMER PROGRAM SETTINGS".

<TIMER PROGRAM SETTINGS>	
>>SELECTED PATTERN	P1-SET
HOLIDAY SETTING	
REC MODE A	
REC MODE B	
REC MODE C	
REC MODE D	
ALARM REC DURATION	5S

2. Check to see that the cursor is to the left of "SELECTED PATTERN" and turn the SHUTTLE ring clockwise twice.

• The "P1" display reverses in color when the SHUTTLE ring is turned the first time. When the ring is turned for the second time, the background turns red and flashes.

3. Turn the JOG dial to select "P2" and turn the SHUTTLE ring clockwise.

• The setting is confirmed and flashing stops.

4. Turn the JOG dial clockwise to reverse display "SET" and turn the SHUTTLE ring clockwise.

• The <TIMER PROGRAM> screen appears.

<TIMER PROGRAM>							P2
	DW	START	END	MODE			MD
>>1	---	---	---	---	---	---	-
2	---	---	---	---	---	---	-
3	---	---	---	---	---	---	-
4	---	---	---	---	---	---	-
5	---	---	---	---	---	---	-
6	---	---	---	---	---	---	-
7	---	---	---	---	---	---	-
8	---	---	---	---	---	---	-
	SPL	SAT-SUN					

5. Check to see that the cursor is to the left of program number "1" and turn the SHUTTLE ring clockwise twice.

• The "DW" display reverses in color when the SHUTTLE ring is turned for the first time. When the ring is turned for the second time, the background turns red and flashes.

6. Turn the JOG dial to display "SPL" in "DW" and turn the SHUTTLE ring clockwise.

• The setting is confirmed and flashing stops.

⦿ When selecting the wrong day of the week in error, turn the SHUTTLE ring clockwise, use the JOG dial to display the correct day of the week and turn the SHUTTLE ring clockwise again.

7. Turn the JOG dial clockwise to move the reversed display to the "hour" of the start time and turn the SHUTTLE ring clockwise.

• The background of the "hour" of the START changes to red and flashes.

8. Turn the JOG dial to display "12" in the "hour" and turn the SHUTTLE ring clockwise.

- The setting is confirmed and flashing stops.

9. Repeat steps 7 and 8 to set "30" in "minutes" of the start time and "13" in the "hour" and "00" in the "minutes" of the end time, and then confirm.

10. Turn the JOG dial clockwise to move the reversed display to the "MODE" and turn the SHUTTLE ring clockwise.

- The background of the "MODE" setting turns red and flashes.

11. Turn the JOG dial to display "A" in "MODE" and turn the SHUTTLE ring clockwise.

- The setting is confirmed and flashing stops.

12. Turn the JOG dial clockwise to move the reversed display to the "MD" and turn the SHUTTLE ring clockwise.

- The background of the "MD" setting turns red and flashes.

13. Turn the JOG dial to display "ON" in "MD" and turn the SHUTTLE ring clockwise.

- The setting is confirmed and flashing stops.

14. Turn the SHUTTLE ring counterclockwise.

- The cursor appears to the program number on the left.

15. When input timer reservations in other program number, repeat steps 5 ~ 14.

16. Turn the JOG dial to select "SPL" and turn the SHUTTLE ring clockwise twice.

- The start day display reverses in color when the SHUTTLE ring is turned for the first time. When the ring is turned for the second time, the background turns red and flashes.

17. Turn the JOG dial to display "WED" in start day and turn the SHUTTLE ring clockwise.

- The setting is confirmed and flashing stops.

18. Turn the JOG dial clockwise to move the reversed display to the end day and turn the SHUTTLE ring clockwise.

- The background of the end day setting turns red and flashes.

19. Turn the JOG dial to display "SAT" in end day and turn the SHUTTLE ring clockwise.

- The setting is confirmed and flashing stops.

20. Turn the SHUTTLE ring counterclockwise.

- The cursor appears to the "SPL" on the left.

<TIMER PROGRAM>						P2
DW	START	END	MODE	MD		
1	SPL	12:30	13:00	A	ON	
2	---	---	---	---	---	
3	---	---	---	---	---	
4	---	---	---	---	---	
5	---	---	---	---	---	
6	---	---	---	---	---	
7	---	---	---	---	---	
8	---	---	---	---	---	

>>SPL WED-SAT

21. Turn the SHUTTLE ring counterclockwise or press the SET UP button.

- Turn the SHUTTLE ring counterclockwise to return the cursor to the previous operation. Then, press the SET UP button to clear the <TIMER PROGRAM SETTINGS> screen and return to the normal screen.

ⓘ If there is an unset item with in the program (- - - display), the setting screen cannot be exited even when turning the SHUTTLE ring counterclockwise. In this case, set all unset items.

22. Press the TIMER button.

- The TIMER button lights.
- Timer recording starts if the current time is within the timer reservation time frame.
- The power turns off and recording will be in the stand-by mode if the current time is not within the timer reservation time frame.

ⓘ Timer recording/timer recording standby can be cancelled by pressing the TIMER button again for more than 1 second.

ⓘ Not available during alarm recording.

⚠ To delete program contents, or to exit the program without performing settings, press the WARNING RE-SET button during program setting.

INFORMATION

Recording will not be performed if there is an error in the setting. To prevent such errors for timer recording, this unit notifies errors using methods shown below. If there is an error in the setting, take the necessary procedures shown below.

Unit status	Description of error	Countermeasure	Page
TIMER button flashes. Series of short beeps (beep-beep-beep) will sound.	1) The date/time is not set. 2) Timer reservation setting has not been set to operate. 3) Program is currently being set.	1) Set the date/time. 2) Set the correct reservation. 3) Check the settings.	20,21 44,45 44,45
Timer recording is not performed even when the timer recording time is reached.	• "HDD REPEAT REC MAIN" is set to "OFF" or "HDD REPEAT REC SUB", is set to "OFF". There is no HDD space left of HDD(MAIN), HDD(SUB).	• Press the WARNING RESET button for canceling the warning. • Set to "ON" in the "HDD REPEAT REC MAIN" or "HDD REPEAT REC SUB" when "OFF" is selected.	87 47

<TIMER PROGRAM SETTINGS> (continued)

■ HOLIDAY SETTING

Holidays throughout the year can be set in advance.

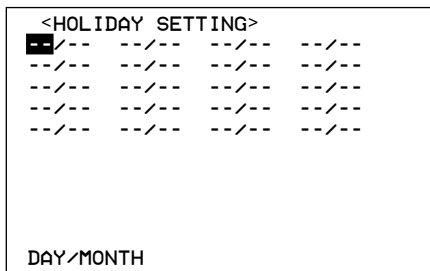

1. Press the **SET UP** button → <SETTINGS> → Select "HOLIDAY SETTING" in the <TIMER PROGRAM SETTINGS> screen, and display the desired holidays and confirm.

2. Turn the **SHUTTLE** ring counterclockwise or press the **SET UP** button.

ⓘ When overlap both holidays set in the <HOLIDAY SETTING> screen and the <TIMER PROGRAM> screen, the unit records giving the priority to the holiday set in the <TIMER PROGRAM> screen over the others.

■ Recording mode settings A ~ D for normal recording/alarm recording

The camera, recording intervals and recording picture quality for normal recording/alarm recording can be set to 4 patterns of recording mode settings A ~ D (for details concerning recording mode settings, see pages 22,23, 41-43).

1. Press the **SET UP** button → <SETTINGS> → Select "REC MODE A" in the <TIMER PROGRAM SETTINGS> screen and turn the **SHUTTLE** ring clockwise.

- The <REC MODE A> screen appears.

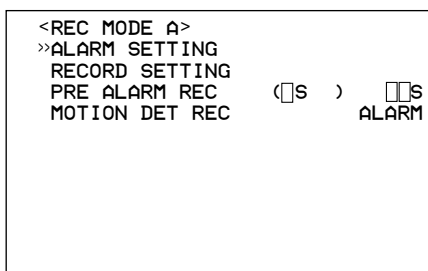

2. Turn the **JOG** dial to select either "ALARM SETTING", "RECORD SETTING" or "PRE ALARM REC" and confirm.

ⓘ For details on "ALARM SETTING", "RECORD SETTING" and "PRE ALARM REC" settings, see pages 41-43.

3. When continuing to REC MODE B ~ D, repeat step 2.

ⓘ The storage area in MAIN HDD set in "PARTITION" is displayed with the percentage(%) and the recordable time of that storage area is displayed in "<ESTD REC>" (For details on PARTITION, see page 75).

■ MOTION DET REC

Recording is done with the recording interval and the quality set by "A-PPS" and "A-GRADE", independent of whether "ALARM" or "NORMAL" has been selected (for details concerning setting MOTION DET REC, see page 43).

■ ALARM REC DURATION

The recording time for alarm recording can be set (for details concerning setting ALARM REC DURATION, see page 43).

◆ Overlapping Timer settings

When Timer settings overlap, the unit will give priority to the higher-numbered program.

Example 1

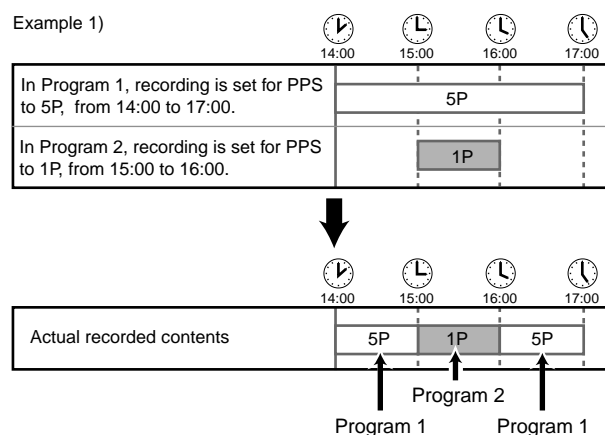

Example 2

- Program 1 is set for 14:00 to 17:00 with the PPS to 5P.
- Program 2 is set for 15:00 to 16:00 with the SKIP setting.

Again, the unit will give priority to Program 2 for the duration of the overlapping period. As shown in the illustration below, the unit will activate the Skip setting from 15:00 to 16:00.

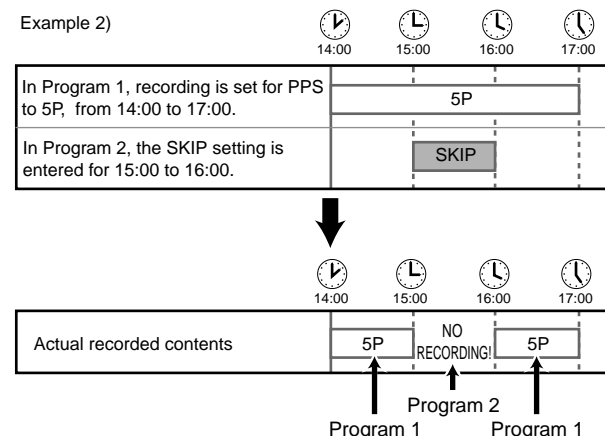

■ HDD SETTINGS

◆ HDD REPEAT REC MAIN/HDD REPEAT REC SUB

The operation when HDD (Hard Disk Drive) space becomes full during recording.

<HDD SETTINGS>	
>>HDD REPEAT REC MAIN	ON
HDD REPEAT REC SUB	OFF
HDD REPEAT PLAY	OFF
IM-CHECK PLAY	OFF
SEQUENTIAL PLAY	OFF

❗ "HDD REPEAT REC SUB" is appeared when "PARTITION" is selected on "HDD SETTING" of the <INITIALIZATION> screen.

Setting (default of HDD REPEAT REC MAIN : "ON", default of HDD REPEAT REC SUB : "OFF")

"ON" : Automatically returns to the beginning of the HDD and resumes recording (by overwriting old data).

"STANDBY" : When the HDD space becomes empty, recording is stopped and the unit switches to the standby mode. Recording is resumed when the REC terminal is grounded or the REC button is pressed. Recording is temporarily stopped if the alarm input is continuously grounded or during timer recording. Then, recording is resumed from the beginning of the HDD.

"OFF" : Recording is stopped and "REC/FULL" or "REC/SUB FULL" is displayed on the screen. To resume recording, press the WARNING RESET button to cancel the warning display and press the REC button.

❗ If either the WARNING "REC/FULL" or "REC/SUB FULL" appears when the ALARM PARTITION is set, recording on both will stop.

❗ "STANDBY" is displayed only in "HDD REPEAT REC MAIN".

1. Press the SET UP button → <SETTINGS> → <INITIAL SET UP/INFORMATION> → Select "HDD REPEAT REC MAIN" or "HDD REPEAT REC SUB" in the <HDD SETTINGS> screen. Display the desired setting and confirm.

2. Turn the SHUTTLE ring counterclockwise or press the SET UP button.

◆ HDD REPEAT PLAY

The contents recorded on the HDD (Hard Disk Drive) can be repeatedly played back.

<HDD SETTINGS>	
HDD REPEAT REC MAIN	ON
HDD REPEAT REC SUB	OFF
>>HDD REPEAT PLAY	OFF
IM-CHECK PLAY	OFF
SEQUENTIAL PLAY	OFF

Setting (default : "OFF")

"ON" : After the recorded data is played back to the end, playback is resumed by automatically returning to the beginning of the recorded data.

"OFF" : After the recorded data is played back to the end, playback is stopped.

1. Press the SET UP button → <SETTINGS> → <INITIAL SET UP/INFORMATION> → Select "HDD REPEAT PLAY" in the <HDD SETTINGS> screen. Display the desired setting and confirm.

2. Turn the SHUTTLE ring counterclockwise or press the SET UP button.

◆ IM-CHECK PLAY

This function is to check whether alterations have been made to the recorded video or the recording date/time. "IMAGE MODIFIED" warning is displayed when alteration is checked.

<HDD SETTINGS>	
HDD REPEAT REC MAIN	ON
HDD REPEAT REC SUB	OFF
HDD REPEAT PLAY	OFF
>>IM-CHECK PLAY	OFF
SEQUENTIAL PLAY	OFF

Setting (default : "OFF")

"ON" : Alteration check is performed during playback and displays a warning at the point containing alteration.

"OFF" : Alteration check is not performed.

❗ This function may cause problems during recording and playback. Normally, set this function to "OFF".

1. Press the SET UP button → <SETTINGS> → <INITIAL SET UP/INFORMATION> → Select "IM-CHECK PLAY" in the <HDD SETTINGS> screen. Display the desired setting and confirm.

2. Turn the SHUTTLE ring counterclockwise or press the SET UP button.

3. Select the device for alteration check and then start playback.

❗ Warning will also be displayed for parts where recorded data is damaged for some reason.

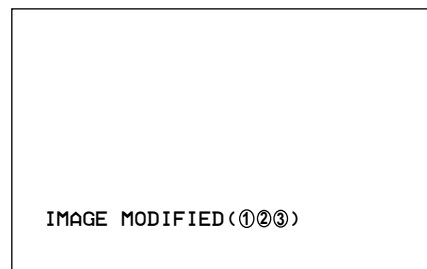

❗ When performing complex playback operations with the SHUTTLE ring during alteration check, the "IMAGE MODIFIED" warning may appear. Perform alteration check using playback or playback with changed playback intervals.

◆ **SEQUENTIAL PLAY**

It is possible to make archive of the video recorded with this unit to an analogue video recorder, etc., while playing back the video of each camera in order using the single screen display. During single screen sequential playback, the SPLIT/SEQUENCE button will light. In addition, the playback order/time of each camera will be the order of the recorded video.

<HDD SETTINGS>	
HDD REPEAT REC MAIN	ON
HDD REPEAT REC SUB	OFF
HDD REPEAT PLAY	OFF
IM-CHECK PLAY	OFF
>>SEQUENTIAL PLAY	OFF

Setting (default : "OFF")

"ON" : Plays back the video in the single screen sequential mode.

"OFF" : Does not play back the video in the single screen sequential mode.

⦿ Playback is performed during camera sequential play at an interval of 25P. To change the playback interval, press the PLAY button (or the REV. PLAY button)(see "Changing playback intervals, pages 65,66).

1. Press the SET UP button → <SETTINGS> → <INITIAL SET UP/INFORMATION> → Select "SEQUENTIAL PLAY" in the <HDD SETTINGS> screen. Display the desired setting and confirm.

2. Turn the SHUTTLE ring counterclockwise or press the SET UP button.

3. Press the PLAY button.

4. Press one of the camera number buttons with recorded video.
• Single screen sequential playback starts.

⦿ When performing camera sequential playback for video with long recording intervals, the video of the largest camera number selected for recording will be played back the longest.

⦿ Only the camera number (title) of the pressed camera number button is displayed. Other camera number (titles) will not be displayed. If display is not necessary, select "NONE" in the <CAMERA DISPLAY> (see page 32).

■ **AUDIO RECORDING**

This unit can simultaneously record audio along with the video. When recording audio, the continuous recording time becomes shorter than when recording only video.

<INITIAL SET UP/INFORMATION>	
HDD SETTINGS	
>>AUDIO RECORDING	OFF
REAR TERMINAL SETTINGS	
COMMUNICATION PORT SETTINGS	
INFORMATION/SERVICE	
PASSWORD	
LANGUAGE SELECTION	

Setting (default : "OFF")

"ON" : Records video and audio.

"ALARM" : During alarm recording or emergency recording, records video and audio.

"OFF" : Does not record audio.

1. Press the SET UP button → <SETTINGS> → Select "AUDIO RECORDING" in the <INITIAL SET UP/INFORMATION> screen. Display the desired setting and confirm.

2. Turn the SHUTTLE ring counterclockwise or press the SET UP button.

ⓘ When setting "AUDIO RECORDING" to "ON", a speaker display () appears to the right of recordable time display in the <RECORD SETTING> and <RECORD SETTING A> ~ <RECORD SETTING D> screens.

<RECORD SETTING>				
<RECORD SETTING>				>>ALARM CH
NO	PPS	GRADE	A-PPS	A-GRADE
①	2.5P	STD	2.5P	STD
②	2.5P	STD	2.5P	STD
③	2.5P	STD	2.5P	STD
④	2.5P	STD	2.5P	STD
⑤	2.5P	STD	2.5P	STD
⑥	2.5P	STD	2.5P	STD
⑦	2.5P	STD	2.5P	STD
⑧	2.5P	STD	2.5P	STD
⑨	2.5P	STD	2.5P	STD
<ESTD REC>)

ⓘ Even when setting "AUDIO RECORDING" to "ON", audio cannot be recorded for the following settings.

• Audio recording cannot be performed when "PPS" of "RECORD SETTING" are all set to smaller than "0.333P" when setting normal recording. In this case, (X) appears to the right of recordable time display.

• When the camera selection during alarm recording is as follows :
"ALARM CH" : "A-PPS" of all cameras set for alarm recording are set to smaller than "0.333P".

"ALARM PLUS", "ALARM25" : "PPS" and "A-PPS" of all cameras set for normal recording and alarm recording are set to smaller than "0.333P".

■ REAR TERMINAL SETTINGS

◆ MODE OUT 1 ~ MODE OUT 5

The unit status can be outputted from the MODE OUT terminals on the rear. There are 5 MODE OUT terminals and each terminal can be set to generate a certain type of output.

<REAR TERMINAL SETTINGS>	
>>MODE OUT 1	OFF
MODE OUT 2	OFF
MODE OUT 3	OFF
MODE OUT 4	OFF
MODE OUT 5	OFF
KEY SOUND	ON
BUZZER	OFF
REMAIN HDD	MAIN-10%
CALL OUT SETTINGS	
EMERGENCY REC DURATION	10M

Setting (default : "OFF")

"REC" : Outputs signals during recording.

"PLAY" : Outputs signals during playback.

"REMAIN" : Outputs signals when the remaining HDD device space reaches the value specified in "REMAIN HDD".

"POWER" : Outputs signals when the power of the unit turns on.

"MOTION1" ~ "MOTION4" : Outputs the camera numbers detected during motion detection recording using binary notation (MODE OUT 1 ~ MODE OUT 4 are linked). Furthermore, motion detection inputted the last is maintained for 2 seconds.

Relation between a camera number and a MODE OUT output

	MODE OUT terminals			
	1	2	3	4
①	O	X	X	X
②	X	O	X	X
③	O	O	X	X
④	X	X	O	X
⑤	O	X	O	X
⑥	X	O	O	X
⑦	O	O	O	X
⑧	X	X	X	O
⑨	O	X	X	O

O : Signal is outputted.
X : No signal is outputted.

"ALARM" : Outputs signals during alarm recording.

"LAN" : It is the MODE OUT terminal controllable from a communication function's.

"OFF" : No signal is outputted.

⚠ Capacity warning from MODE OUT is only outputted during recording.

1. Press the SET UP button → <SETTINGS> → <INITIAL SET UP/INFORMATION> → Select "REAR TERMINAL SETTINGS" screen.

2. From the 5 MODE OUT terminals, display the desired setting for the terminal (MODE OUT 1 ~ MODE OUT 5) to output signals and then confirm.

3. To set other terminals, repeat step 2.

4. Turn the SHUTTLE ring counterclockwise or press the SET UP button.

◆ KEY SOUND

It is possible for the unit to make button sounds when using the operation buttons on the front of the unit or when operating the JOG dial or SHUTTLE ring.

<REAR TERMINAL SETTINGS>	
MODE OUT 1	OFF
MODE OUT 2	OFF
MODE OUT 3	OFF
MODE OUT 4	OFF
MODE OUT 5	OFF
>>KEY SOUND	ON
BUZZER	OFF
REMAIN HDD	MAIN-10%
CALL OUT SETTINGS	
EMERGENCY REC DURATION	10M

1. Press the SET UP button → <SETTINGS> → <INITIAL SET UP/INFORMATION> → Select "KEY SOUND" in the <REAR TERMINAL SETTINGS> screen. Display the desired setting and confirm.

2. Turn the SHUTTLE ring counterclockwise or press the SET UP button.

◆ BUZZER

It is possible for a buzzer to sound when the remaining HDD device space reaches the value set in "REMAIN HDD" of the <REAR TERMINAL SETTINGS> screen. Other than the above, it is possible to set the buzzer to sound when starting alarm recording or emergency recording, or when a warning is displayed.

<REAR TERMINAL SETTINGS>	
MODE OUT 1	OFF
MODE OUT 2	OFF
MODE OUT 3	OFF
MODE OUT 4	OFF
MODE OUT 5	OFF
KEY SOUND	ON
>>BUZZER	OFF
REMAIN HDD	MAIN-10%
CALL OUT SETTINGS	
EMERGENCY REC DURATION	10M

To sound a buzzer only when reaching a specified value :

1) Select "REMAIN" for "BUZZER" in the <REAR TERMINAL SETTINGS> screen.

2) Set the remaining capacity in "REMAIN HDD" of the <REAR TERMINAL SETTINGS> screen.

To sound a buzzer when reaching the set remaining capacity or when a warning is displayed :

1) Select "WARNING" for "BUZZER" in the <REAR TERMINAL SETTINGS> screen.

2) Set the remaining HDD capacity (HDD MAIN REMAIN/HDD SUB REMAIN) in "CALL OUT SETTINGS" of the <REAR TERMINAL SETTINGS> screen.

<INITIAL SET UP/INFORMATION> (continued)

Setting (default : "OFF")

"REMAIN", "WARNING", "ALARM", "OFF"

SETTING BUZZER	REMAIN	WARNING	ALARM	OFF
When reaching the remaining capacity set in "REMAIN HDD"	ON	OFF	OFF	OFF
When a failure occurs and a warning is displayed	OFF	ON	OFF	OFF
When an alarm recording or emergency recording is started	OFF	OFF	ON	OFF

1. Press the SET UP button → <SETTINGS> → <INITIAL SET UP/INFORMATION> → Select "BUZZER" in the <REAR TERMINAL SETTINGS> screen. Display the desired setting and confirm.

2. Turn the SHUTTLE ring counterclockwise or press the SET UP button.

◆ REMAIN HDD

A warning indicating that the either remaining capacity of HDD has become low during recording is outputted. The device can be selected and the remaining capacity can be set here.

<REAR TERMINAL SETTINGS>	
MODE OUT 1	OFF
MODE OUT 2	OFF
MODE OUT 3	OFF
MODE OUT 4	OFF
MODE OUT 5	OFF
KEY SOUND	ON
BUZZER	OFF
>>REMAIN HDD	MAIN-10%
CALL OUT SETTINGS	
EMERGENCY REC DURATION	10M

ⓘ A warning is outputted using the following methods when the remaining capacity becomes low during recording.

- The HDD usage display flashes when "3" is set to "DISPLAY MODE" in the <TIME DATE/DISPLAY SETTINGS> screen.
- A buzzer will sound when "REMAIN" is set to "BUZZER" in the <REAR TERMINAL SETTINGS> screen.

Setting of DEVICE (default : "MAIN")

"MAIN" : Displays a warning of low MAIN HDD capacity.

"SUB" : Displays a warning of low SUB HDD capacity.

"OFF" : Does not display warning of low capacity.

ⓘ "SUB" is appeared when "PARTITION" is selected on "HDD SETTING" of the <INITIALIZATION> screen.

Setting of "REMAIN HDD" (default : "10%")

"2%", "4%", "6%", "8%", "10%", "15%", "20%", "30%", "40%", "50%"

1. Press the SET UP button → <SETTINGS> → <INITIAL SET UP/INFORMATION> → "Select "REMAIN HDD" in the <REAR TERMINAL SETTINGS> screen and turn the SHUTTLE ring clockwise twice.

- The setting display reverses in color when the SHUTTLE ring is turned the first time. When the ring is turned for the second time, the background turns red and flashes.

2. Turn the JOG dial to display the desired device and turn the SHUTTLE ring clockwise.

- The setting is confirmed and flashing stops.

3. Turn the JOG dial clockwise to move the reversed display to the REMAIN HDD value and turn the SHUTTLE ring clockwise.

- The background of the REMAIN HDD value turns red and flashes.

4. Turn the JOG dial to display the desired capacity and turn the SHUTTLE ring clockwise.

- The setting is confirmed and flashing stops.

5. Turn the SHUTTLE ring counterclockwise or press the SET UP button.

◆ CALL OUT SETTINGS

The CALL OUT setting is a setting to notify to the outside warning signals outputted by this device by outputting the signals from the CALL OUT terminal on the rear.

ⓘ CALL OUT SETTINGS use photo-coupler output to decrease the amount of malfunctions due to wiring.

☞ See page 15 "CALL OUT Output terminal" for apt connection procedures.

• HDD MAIN REMAIN/HDD SUB REMAIN

When the remaining memory in the HDD reaches the set value, the unit outputs a signal from the CALL OUT terminal, and the "REC/REM" warning displayed on the screen.

<CALL OUT SETTINGS>	
>>HDD MAIN REMAIN	OFF
HDD MAIN FULL	OFF
HDD SUB REMAIN	OFF
HDD SUB FULL	OFF

ⓘ "HDD SUB REMAIN" is appeared when "PARTITION" is selected on "HDD SETTING" of the <INITIALIZATION> screen.

Setting (default : "OFF")

"2%", "4%", "6%", "8%", "10%", "15%", "20%", "30%", "40%", "50%", "OFF"

1. Press the SET UP button → <SETTINGS> → <INITIAL SET UP/INFORMATION> → <REAR TERMINAL SETTINGS> → Select "HDD MAIN REMAIN" or "HDD SUB REMAIN" in the <CALL OUT SETTINGS> screen. Display the desired setting and confirm.

2. Turn the SHUTTLE ring counterclockwise or press the SET UP button.

ⓘ By pressing the WARNING RESET button, the HDD capacity warning from the CALL OUT terminal can be cancelled.

INFORMATION

For the relationship of the warning display and CALL OUT signal output, see pages 87,88. Although the warning will be displayed regardless if the output item for the CALL OUT signal is set to "Fixed", the condition to output CALL OUT signals can be added when the output is set to "Selectable". For example, the buzzer can be set to sound when reaching a value set in "HDD MAIN REMAIN" or "HDD SUB REMAIN" of the <CALL OUT SETTINGS> screen if "BUZZER" in the <REAR TERMINAL SETTINGS> screen is set to "WARNING".

• HDD MAIN FULL/HDD SUB FULL

When the HDD is full, the CALL OUT terminal outputs a CALL OUT signal.

<CALL OUT SETTINGS>	
HDD MAIN REMAIN	OFF
>>HDD MAIN FULL	OFF
HDD SUB REMAIN	OFF
HDD SUB FULL	OFF

! "HDD SUB FULL" is appeared when the "HDD SETTING" is selected on "PARTITION" of the <INITIALIZATION> screen.

Setting (default : "OFF")

"ON" : Signal is outputted when the recording capacity becomes full.

"OFF" : No signal is outputted when the recording capacity becomes full.

1. Press the SET UP button → <SETTINGS> → <INITIAL SET UP/INFORMATION> → <REAR TERMINAL SETTINGS> → Select "HDD MAIN FULL" or "HDD SUB FULL" in the <CALL OUT SETTINGS> screen. Display the desired setting and confirm.

2. Turn the SHUTTLE ring counterclockwise or press the SET UP button.

◆ EMERGENCY REC DURATION

The recording time for emergency recording can be set.

<REAR TERMINAL SETTINGS>	
MODE OUT 1	OFF
MODE OUT 2	OFF
MODE OUT 3	OFF
MODE OUT 4	OFF
MODE OUT 5	OFF
KEY SOUND	ON
BUZZER	OFF
REMAIN HDD	MAIN-10%
>>EMERGENCY REC DURATION 10M	

🔍 For details concerning setting EMERGENCY RECORDINGS, see page 64.

Setting (default : "10M")

"1M", "2M", "5M", "10M", "20M", "30M", "60M"

1. Press the SET UP button → <SETTINGS> → <INITIAL SET UP/INFORMATION> → Select "EMERGENCY REC DURATION" in the <REAR TERMINAL SETTINGS> screen. Display the desired setting and confirm.

2. Turn the SHUTTLE ring counterclockwise or press the SET UP button.

■ COMMUNICATION PORT SETTINGS

<INITIAL SET UP/INFORMATION>	
HDD SETTINGS	
AUDIO RECORDING	OFF
REAR TERMINAL SETTINGS	
>>COMMUNICATION PORT SETTINGS	
INFORMATION/SERVICE	
PASSWORD	
LANGUAGE SELECTION	

1. Press the SET UP button → <SETTINGS> → Select "COMMUNICATION PORT SETTINGS" in the <INITIAL SET UP/INFORMATION> screen and turn the SHUTTLE ring clockwise.

• The <COMMUNICATION PORT SETTINGS> screen appears.

<COMMUNICATION PORT SETTINGS>	
>>RS-232C	
ETHERNET	

◆ RS-232C

Settings for the communication device connected to this unit is set.

• MODE

This unit can be remote controlled from a PC connected to the RS-232C terminal. Comments can also be inputted from a PC for recording of comments along with the video.

<RS-232C>	
>>MODE	REMOTE A
SETTINGS	

Setting (default : "REMOTE A")

"REMOTE A" : This unit can be controlled from a PC and every status information is returned from the unit.

"REMOTE B" : This unit can be controlled from a PC and from the unit when the status for command is changed.

"REMOTE C" : This unit can be controlled from a PC with no status information.

"OFF" : This unit cannot be controlled from a PC.

1. Press the SET UP button → <SETTINGS> → <INITIAL SET UP/INFORMATION> → <COMMUNICATION PORT SETTINGS> → Select "MODE" in the <RS-232C> screen. Display the desired setting and confirm.

2. Turn the SHUTTLE ring counterclockwise or press the SET UP button.

<INITIAL SET UP/INFORMATION> (continued)

• SETTINGS

RS-232C settings can be made when setting "MODE" previous to "REMOTE A", "REMOTE B" or "REMOTE C".

① Perform settings so that the settings are the same with the connecting PC.

Setting of "TRANSMISSION MODE" (default : "9600")
"1200", "2400", "4800", "9600", "19200"

Setting of "DATA BIT LENGTH" (default : "8BIT")
"8BIT", "7BIT"

Setting of "PARITY BIT" (default : "NONE")
"NONE", "ODD", "EVEN"

Setting of "STOP BIT LENGTH" (default : "1BIT")
"1BIT", "2BIT"

Setting of "DELIMITER" (default : "CR")
"CR", "CR•LF"

1. Set "MODE" in the <RS-232C> screen to "REMOTE A", "REMOTE B" or "REMOTE C".

2. Select "SETTINGS" and turn the SHUTTLE ring clockwise.
• The <RS-232C SETTINGS> screen appears.

```

<RS-232C SETTINGS>
>>TRANSMISSION MODE      9600
  DATA BIT LENGTH       8BIT
  PARITY BIT             NONE
  STOP BIT LENGTH        1BIT
  DELIMITER              CR
    
```

3. Select the setting to change and turn the SHUTTLE ring clockwise.
• The background of the setting turns red and flashes.

4. Display the desired sub item and turn the SHUTTLE ring clockwise.
• The setting is confirmed and flashing stops.

5. To set other setting, repeat steps 3 and 4.

6. Turn the SHUTTLE ring counterclockwise or press the SET UP button.

◆ ETHERNET

The IP address used to specify the connected recorder, sub net mask setting, and MAC address can be referred to here.

① Do not change the setting without sufficient knowledge about the network setting.

① In regard to the network settings it is recommended to obtain advance confirmation by the network manager.

① Do not assign "000.000.000.000" IP address. And do not assign it as the broadcast address. If this address were to be assigned, we could not guarantee communications or any other functions of the recorder unit.

① The setting can not be changed during the record. Stop the record to change the setting.

1. Press the SET UP button → <SETTINGS> → <INITIAL SET UP/INFORMATION> → Select "ETHERNET" in the <COMMUNICATION PORT SETTINGS> screen and turn the SHUTTLE ring clockwise.

• The <ETHERNET> screen appears.

```

<ETHERNET>
>>IP ADDRESS      192.168.000.100
  SUB NET MASK    255.255.255.000
  GATEWAY         000.000.000.000
  E-MAIL ADDRESS
  SERVICE PORT SETTING
  ALARM NOTIFICATION SETTING

<MAC ADDRESS>
                08-00-70-2E-3F-FF
PLEASE PRESS SET UP BUTTON
TO APPLY NEW SETTING
    
```

2. Select the setting you wish to alter by turning the JOG dial and then turn the SHUTTLE ring clockwise.

• The leftmost number of the setting will reverse in color.

3. Turn the JOG dial to reverse display the number you wish to alter and turn the SHUTTLE ring clockwise.

• The background of the selected number turns red and flashes.

4. Turn the JOG dial to display the desired number and turn the SHUTTLE ring clockwise.

• The setting is confirmed and flashing stops.

5. Repeat steps 2 and 4 to change the other numbers.

6. When the setting is complete, turn the SHUTTLE ring counterclockwise.

• The cursor move to setting directly to the left.

7. (Finalizing updated menu settings •••)

When any setting of "IP ADDRESS", "SUB NET MASK", "GATEWAY" is changed, press the SET UP button.

• The power turns off automatically, then the unit will boot up.

① Press the SET UP button to return to the normal screen without changing the setting.

• E-MAIL ADDRESS

The contents of the setting of "SMTP SERVER", "RECORDER ID" and "USER ADDRESS" can be referred to here.

Ⓜ The specific software is required to input "SMTP SERVER", "RECORDER ID" and "USER ADDRESS". Please refer to the instruction manual of the software.

1. Press the SET UP button → <SETTINGS> → <INITIAL SET UP/INFORMATION> → <COMMUNICATION PORT SETTING> → select "E-MAIL ADDRESS" in the <ETHERNET> screen.

• The <E-MAIL ADDRESS> screen appears.

```

<E-MAIL ADDRESS>
SMTP SERVER

RECORDER ID

USER ADDRESS
1
2
3
4
5
    
```

Ⓜ "USER ADDRESS" is displayed only for 20 characters from the beginning.

• SERVICE PORT SETTING

The port number can be set here to connect personal computer.

ⓘ Do not change the setting without sufficient knowledge about the network setting.

ⓘ When perform other setting except "WEB", the specific software is required. Please refer to the instruction manual of the software.

1. Press the SET UP button → <SETTINGS> → <INITIAL SET UP/INFORMATION> → <COMMUNICATION PORT SETTING> → select "SERVICE PORT SETTING" in the <ETHERNET> screen.

• The <SERVICE PORT SETTING> screen appears.

<SERVICE PORT SETTING>	
>>WEB	•00080
USER ACCESS	53705
SUPER USER	53706
LIVE USER1	53707
LIVE USER2	53708
LIVE USER3	53709
LIVE USER4	53710

2. Turn the JOG dial to select the desired setting and turn the SHUTTLE ring clockwise.

• The first figure of the port number reverses in color.

3. Turn the JOG dial to display the desired figure reversed in color, and turn the SHUTTLE ring clockwise.

• The background of the selected figure turns red and flashes.

4. Turn the JOG dial to display the desired port number and turn the SHUTTLE ring clockwise.

• The setting is confirmed and flashing stops

5. Turn the SHUTTLE ring counterclockwise.

• The cursor appears to the setting on the left.

ⓘ When change the "WEB" setting, the "•" situated on the left of the port number turns its color from green to red.

6. To change other settings repeat steps 2 to 5.

7. (Finalizing update menu settings •••)

Return to the <ETHERNET> screen by turning the SHUTTLE ring counterclockwise and press the SET UP button.

• The power turns off automatically, then the unit will boot up.

ⓘ Press the SET UP button to return to the normal screen without changing the setting.

• ALARM NOTIFICATION SETTING

The setting is for the transmission of warning signals and other signals for status changes such as the short-circuit of the rear terminal or when initiated the recording.

ⓘ The specific software is required. Please refer to the instruction manual of the software.

ⓘ Issuing of reports to broadcast addresses is not supported.

1. Press the SET UP button → <SETTINGS> → <INITIAL SET UP/INFORMATION> → <COMMUNICATION PORT SETTING> → select "ALARM NOTIFICATION SETTING" in the <ETHERNET> screen.

• The <ALARM NOTIFICATION SETTING> screen appears.

<ALARM NOTIFICATION SETTING>	
NO IP ADDRESS	TARGET OWN
>>1 000.000.000.000	•55111 01111
2 000.000.000.000	•55111 01112
3 000.000.000.000	•55111 01113
4 000.000.000.000	•55111 01114
5 000.000.000.000	•55111 01115
WARNING	OFF
ALARM SENS	OFF
REC MODE	OFF
RETRY TIME	10S

2. (Cases of setting the IP ADDRESS number of connected PC, the port setting number, etc. •••)

Turn the JOG dial to select the desired setting number and turn the SHUTTLE ring clockwise.

• The leftmost figure of the port number reverses in color.

3. Turn the JOG dial to display the desired figure of numbers of IP ADDRESS, TARGET PORT and OWN PORT reversed in color and turn the SHUTTLE ring clockwise.

• The background of the desired figure turns red and flashes.

4. Turn the JOG dial to display the desired number and turn the SHUTTLE ring clockwise.

• The setting is confirmed and flashing stops

5. Turn the SHUTTLE ring counterclockwise.

• The cursor appears to the setting on the left.

ⓘ When TARGET PORT number is set to 00000 - 01023, the "•" situated on the left of the value turns red from green, and in case of 01024 - 49151 turns yellow.

6. To change other setting number repeat steps 2 to 5.

7. (Cases of the setting of the transmission contents to connected PC •••)

Turn the JOG dial to select the desired setting and turn the SHUTTLE ring clockwise.

• The background of the setting turns red and flashes.

Setting of "WARNING" (default : "OFF")

"ON" : Transmits warning signals to connected PC. E-mail is sent to address displayed on "USER ADDRESS" of the <E-MAIL ADDRESS> screen.

"OFF" : Does not transmit.

Setting of "ALARM SENS" (default : "OFF")

"ON" : Only for the short-circuit of rear terminal transmits the status information to connected PC. E-mail is sent to address displayed on "USER ADDRESS" of the <E-MAIL ADDRESS> screen.

"OFF" : Does not transmit.

Setting of "REC MODE" (default : "OFF")

"ON" : Transmits the recording status such as normal recording or alarm recording to connected PC. E-mail is sent to address displayed on "USER ADDRESS" of the <E-MAIL ADDRESS> screen.

OFF : Does not transmit.

Setting of "RETRY TIME" (default : "10S")

1S, 2S, ••••, 10S, •••••••• 59S, 60S

<INITIAL SET UP/INFORMATION> (continued)

8. Turn the JOG dial to display the desired setting and turn the SHUTTLE ring clockwise.

- The setting is confirmed and stops flashing.

9. (Finalizing update menu settings of the transmission contents •••)

Return to the <ETHERNET> screen by turning the SHUTTLE ring counterclockwise and turn the SHUTTLE ring counterclockwise or press the SET UP button.

10. (Finalizing update menu settings of number of IP ADDRESS, TRAGET PORT or OWN PORT •••)

Return to the <ETHERNET> screen by turning the SHUTTLE ring counterclockwise and press the SET UP button.

- The power turns off automatically, then the unit will boot up.

❗ Press the SET UP button to return to the normal screen without changing the setting.

■ INFORMATION/SERVICE

The <INFORMATION/SERVICE> screen is used to check log and device lists after power failure, and initialization the menu. The total operating time is displayed on the 2/2 screen.

<INFORMATION/SERVICE> 1/2

```
<INFORMATION/SERVICE> (1/2)
>>HDD INFORMATION
CFC INFORMATION
WARNING LOG LIST
RESET TO FACTORY SETTINGS

MAIN HDD DATA CLEAR
SUB HDD DATA CLEAR
CFC DATA CLEAR
```

<INFORMATION/SERVICE> 2/2

```
<INFORMATION/SERVICE> (2/2)
ELAPSED TIME: SYSTEM 3H

HDD SETTING      PARTITION
PARTITION SIZE   10%
```

❗ The <INFORMATION/SERVICE> screen consists of 2 pages. The second page is appeared by turning the JOG dial clockwise when the cursor points out the setting of the bottom of the screen.

❗ "SUB HDD DATA CLEAR" is appeared on page 1/2 of the <INFORMATION/SERVICE> screen when "PARTITION" is selected on "HDD SETTING" of the <INITIALIZATION> screen.

❗ "PARTITION SIZE" is appeared on page 2/2 of the <INFORMATION/SERVICE> screen when "PARTITION" is selected on "HDD SETTING" of the <INITIALIZATION> screen.

◆ HDD INFORMATION/CFC INFORMATION

INFORMATION is used to check the amount of available space in the HDD and Compact Flash Cards inserted into the unit.

1-1. (To check HDD RECORD data •••)

Press the SET UP button → <SETTINGS> → <INITIAL SET UP/INFORMATION> → Select "HDD INFORMATION" in the <INFORMATION/SERVICE> (1/2) screen, and turn the SHUTTLE ring clockwise.

- The <HDD INFORMATION> screen is displayed.

```
<HDD INFORMATION>
INTERNAL HDD
MASTER:   HDD (250GB)
SLAVE :    NONE

MAIN START ----- :--:--:--
END       ----- :--:--:--
SUB  START ----- :--:--:--
END       ----- :--:--:--
```

❗ Recording start and end times of "SUB" area is appeared when the "HDD SETTING" is selected on "PARTITION" of the <INITIALIZATION> screen.

1-2. (To check RECORD data of the Compact Flash Card inserted into the unit or whether MENU INFORMATION is recorded •••)

Press the SET UP button → <SETTINGS> → <INITIAL SET UP/INFORMATION> → Select "CFC INFORMATION" in the <INFORMATION/SERVICE> (1/2) screen, and turn the SHUTTLE ring clockwise.

- The <CFC INFORMATION> screen of the Compact Flash Card inserted into the unit is displayed.

```
<CFC INFORMATION>
CFC
CAPACITY 128MB

START ----- :--:--:--
END       ----- :--:--:--
```

⊖ MENU INFORMATION is appeared on the screen when there is recorded MENU INFORMATION.

2. Turn the SHUTTLE ring counterclockwise or press the SET UP button.

◆ WARNING LOG LIST

The WARNING LOG LIST enables to check the number of failure, date, time and type of failure, etc.

```
<INFORMATION/SERVICE> (1/2)
HDD INFORMATION
CFC INFORMATION

>>WARNING LOG LIST
RESET TO FACTORY SETTINGS

MAIN HDD DATA CLEAR
SUB HDD DATA CLEAR
CFC DATA CLEAR
```

1. Press the SET UP button → <SETTINGS> → <INITIAL SET UP/INFORMATION> → Select “WARNING LOG LIST” in the <INFORMATION/SERVICE> (1/2) screen. Turn the SHUTTLE ring clockwise.

- The <WARNING LOG LIST> screen appears.
- The WARNING LOG LIST can display up to 1000 items. When the number of items exceed this limit, the latest 1000 items are displayed.
- ▲ button/turn JOG dial counterclockwise : Selection moves to the next number.
- ▼ button/turn JOG dial clockwise : Selection moves to the previous number.
- ► button : Displays the page with date prior to the date of the currently opened page.
- ◀ button : Displays the page with date newer than the date of the currently opened page.

⊖ When a failure occurs while the <WARNING LOG LIST> is being displayed, exit the screen and display the screen again. A new item will be added to the list.

⊖ Failures displayed in the WARNING LOG LIST (see pages 87,88).

<WARNING LOG LIST>			
NO	DATE	TIME	WARNING
>>0001	02-02-04	10:00:00	ALM ON

<The “WARNING” are displayed in red.>

- “P-LOSS” : Power failure.
- “SYS RST” : Reset button was pressed and the unit was reset.

<The “WARNING” are displayed in green.>

- “ALM OFF” : The ALARM INTERRUPT button was pressed and the unit was put on interruption.
- “ALM ON” : The ALARM INTERRUPT button was pressed and the alarm interrupt was cancelled.
- “REC ON” : The record was started.
- “REC OFF” : The record was stopped.
- “PS-OFF” : PASSWORD LOCK was unlocked.
- “PS-1” : The PASSWORD level 1 was locked.
- “PS-2” : The PASSWORD level 2 was locked.
- “PS-3” : The PASSWORD level 3 was locked.
- “PS-4” : The PASSWORD level 4 was locked.
- “PS-E” : The SIMPLE LOCK was locked.

⊖ When recording is started, “REC ON” is registered in <WARNING LOG LIST>. However, “REC ON” will not be registered when recording is resumed after power is restored.

⊖ For power outages that occur while timer recording is standing by, “P-LOSS” that indicates a power outage is not displayed. In addition, power outages that overlap with timer recording start times and those where power is restored after the recording end time are also not recorded.

2. Turn the SHUTTLE ring counterclockwise or press the SET UP button.

◆ RESET TO FACTORY SETTINGS

Menu screen settings are reset.

1. Press the SET UP button → <SETTINGS> → <INITIAL SET UP/INFORMATION> → Select “RESET TO FACTORY SETTINGS” in the <INFORMATION/SERVICE> (1/2) screen. Turn the SHUTTLE ring clockwise.

- The <RESET TO FACTORY SETTINGS> screen appears.
- When not resetting menu screen settings, turn the SHUTTLE ring counterclockwise.

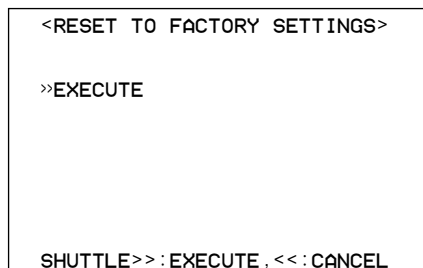

2. Turn the SHUTTLE ring clockwise.

- The menu screen settings are reset.

⊖ The <TIMER PROGRAM> setting is not initialized.

⊖ When menu initialization is performed when a setting change has been made for any one item of “IP ADDRESS”, “SUB NET MASK”, “GATEWAY”, “SERVICE PORT SETTING” on the <ETHERNET> screen or “IP ADDRESS”, “TARGET” or “OWN” of the <ALARM NOTIFICATION SETTING> settings, restart is performed after the power has been cut.

3. Turn the SHUTTLE ring counterclockwise or press the SET UP button.

◆ DATA CLEAR

For deleting data in MAIN HDD, SUB HDD or CFC (Compact Flash Card).

⊖ “SUB HDD DATA CLEAR” is appeared when the “HDD SETTING” is selected on “PARTITION” of the <INITIALIZATION> screen.

⊖ Performing “MAIN HDD DATA CLEAR” while in “MIRRORING” mode deletes all data.

1. Press the SET UP button → <SETTINGS> → <INITIAL SET UP/INFORMATION> → Select the desired item to clear in the <INFORMATION/SERVICE> (1/2) screen. Turn the SHUTTLE ring clockwise.

- “PUSH WARNING RESET KEY FOR 1 SECOND TO CLEAR” appears on the bottom of the screen.
- To cancel the deletion, turn the SHUTTLE ring counterclockwise.

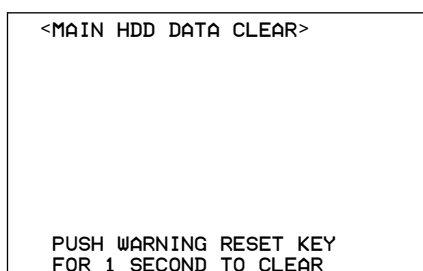

① When a password for level 4 has been registered and locked, and the settings for "MAIN HDD DATA CLEAR" and "SUB HDD DATA CLEAR" are made, the <UNLOCK PASSWORD> screen will be displayed and the lock must be unlocked.

2. Press the WARNING RESET button for 1 second.
 • "CLEARING ..." appears on the screen.

① Data cannot be erased when accessing to HDD as playing/recording/copying/restoring.

3. Turn the SHUTTLE ring counterclockwise or press the SET UP button.

■ PASSWORD

The unit is equipped with 2 lock functions : SIMPLE LOCK that does not require the PASSWORD when unlocking and PASSWORD LOCK that require the PASSWORD when unlocking.

• If the PASSWORD for unlocking has not been set : Lock function will be SIMPLE LOCK

• If the PASSWORD for unlocking has been set : Lock function will be PASSWORD LOCK.

⦿ When the MAIN switch on the rear of the unit is set to ON, SIMPLE LOCK/PASSWORD LOCK setting can be made even with the POWER button on the front set to OFF.

① When the MAIN switch on the rear of the unit is set to OFF or when a menu is being displayed, SIMPLE LOCK/PASSWORD LOCK will not function.

◆ SIMPLE LOCK

When SIMPLE LOCK is on, buttons other than the SPLIT/SEQUENCE button, ZOOM button, camera number buttons 1 ~ 9 and the MAIN switch become inoperable and the unit will be locked in the current state.

To apply simple lock ●●●

1. Press the LOCK button using a ballpoint pen, etc., when the MAIN switch is set to ON.
 • The lock turns on and the LOCK indicator lights.

To unlock simple lock ●●●

1. Press the LOCK button.
 • The lock is unlocked and the LOCK indicator turns off.

◆ PASSWORD LOCK

PASSWORD LOCK is divided into the two types of "OPERATION CONTROL" and "HDD DATA CLEAR". "OPERATION CONTROL" can be locked in three levels by operation functions. "HDD DATA CLEAR" makes it possible to lock the settings "MAIN HDD DATA CLEAR" and "SUB HDD DATA CLEAR".

<About PASSWORD LOCK for OPERATION CONTROL (level 1 to level 3)>

- 1) Input the PASSWORD of level 1 to level 3.
- 2) Set the PASSWORD LOCK.
 • The PASSWORD LOCK of level 1 will be active.

⦿ When The PASSWORD LOCK of level 1 is active, functions of all operations can be locked.

- 3) Unlock the PASSWORD LOCK of level 1.
 • The PASSWORD LOCK of level 2 will be active.

⦿ When The PASSWORD LOCK of level 2 is active, only the SPLIT/SEQUENCE button, ZOOM button and camera number buttons are operable.

- 4) Unlock the PASSWORD LOCK of level 2.
 • The PASSWORD LOCK of level 3 will be active.

⦿ When The PASSWORD LOCK of level 3 is active, it is operable except the SET UP button and ALARM INTERRUPT button.

- 5) Unlock the PASSWORD LOCK of level 3.
 • The PASSWORD LOCK of all levels will be unlocked.

⦿ Functions of all operations can be operable.

① For level 1 and level 2, press the LOCK button on the front of the unit to display the <UNLOCK PASSWORD> screen. Input the PASSWORD to unlock. For level 3, press the SET UP button to display the <UNLOCK PASSWORD> screen and input the PASSWORD. When don't cancel the password lock, it is in the state where the <UNLOCK PASSWORD> screen is displayed, and please press the LOCK button.

⦿ When the MAIN switch (main power) on the rear is set to ON, the PASSWORD can be registered, set and cancelled even with the POWER button on the front is set to OFF.

To register the PASSWORD ●●●

The PASSWORD is registered using a 4 digit number using numbers from 0 ~ 9.

1. Press the SET UP button → <SETTINGS> → Select "PASSWORD" in the <INITIAL SET UP/INFORMATION> screen.
 • The <PASSWORD> screen appears.

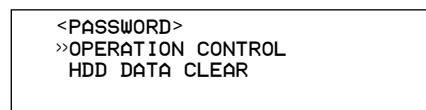

2-1. (To register the PASSWORD for OPERATION CONTROL for (level 1 to level 3) ●●●)

Confirm the cursor is positioned at left side of "OPERATION CONTROL", turn the SHUTTLE ring clockwise.

- The <PASSWORD SETTING> screen appears.

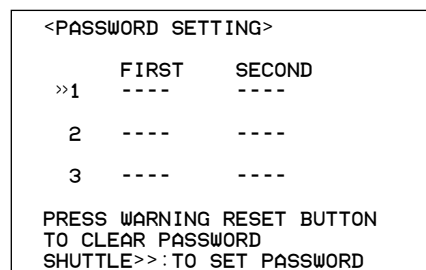

2-2. Confirm the cursor is moved to the left side of the level "1", turn the SHUTTLE ring clockwise.

- The first input position of "FIRST" will be displayed in reversed color and flashes.

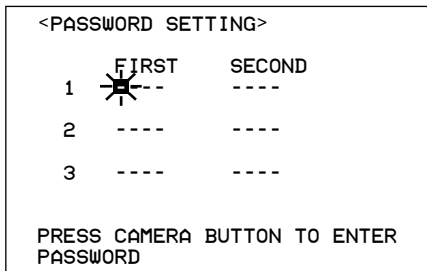

- ⦿ The PASSWORD may consist of the numbers from 1 to 9 which are assigned to the camera number buttons. 0 is assigned to the ZOOM button.

2-3. Input 4 digits of the PASSWORD by pressing the camera number buttons and the ZOOM button.

- The first input position of "SECOND" will be displayed in reversed color and flashes.

2-4. Input the PASSWORD entered in "FIRST" in "SECOND".

- The cursor moves to the left side of the setting of level 1.

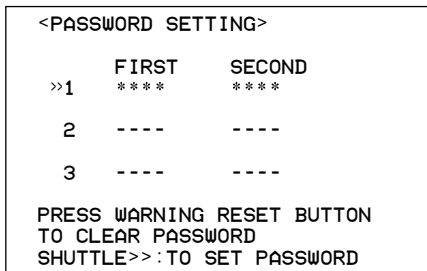

- ⚠ Input the same number in "FIRST" and "SECOND". The setting returns to step 2 if the different PASSWORD number is inputted.

2-5. Repeat steps 2-2 ~ 2-4 to set level 2 and level 3.

- ⚠ It is not necessary to input the PASSWORD all levels 1, level 2 and level 3. Input the PASSWORD in the desired level only.

2-6. Turn the SHUTTLE ring counterclockwise.

3-1. (To register the PASSWORD for HDD DATA CLEAR for (level 4) •••)

Turn the JOG dial to move the cursor to "HDD DATA CLEAR", turn the SHUTTLE ring clockwise.

- The <PASSWORD SETTING> screen appears.

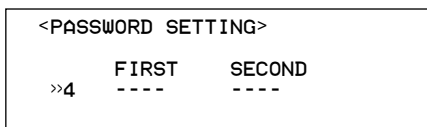

3-2. Repeat steps 2-2 ~ 2-4 to set level 4.

4. Turn the SHUTTLE ring counterclockwise, or press the SET UP button.

- ⚠ The password lock for HDD data deletion (level 4) becomes effective when leaving the setting screen.

To unlock the PASSWORD •••

1. (To unlock the PASSWORD for level 1 and level 2 •••) Press the LOCK button.

- The <UNLOCK PASSWORD> screen appears.

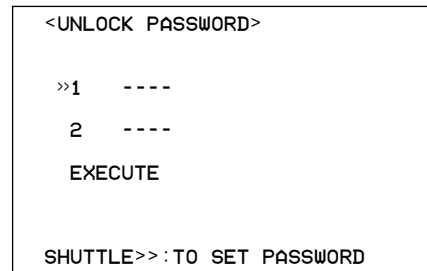

2. Confirm the cursor is moved to the left side of level "1" and turn the SHUTTLE ring clockwise.

- The first digit reverse in color.

3. Input 4 digits of the PASSWORD by pressing the camera number buttons or the ZOOM button.

- The cursor moves to the left side of the setting of level 1.

4. Turn the JOG dial to select the level "2" and turn the SHUTTLE ring clockwise.

- The first input position will be displayed reversed color.

5. Input the 4 digits of the PASSWORD by pressing the camera number buttons or the ZOOM button.

- The cursor moves to the left side of the setting "2".

- ⚠ When the PASSWORD LOCK of level 1 and level 2 are set, if unlock level 1 the PASSWORD LOCK of level 2 will be active.

- ⚠ When the PASSWORD LOCK of level 1 and level 2 are set, level 2 only can not be unlocked. Be sure to unlock level 1 too.

- ⚠ Input the PASSWORD correctly. If there is an error in input, repeat steps 4 and 5 to input again.

6. Turn the JOG dial to move the cursor to "EXECUTE" and turn the SHUTTLE ring clockwise.

- The PASSWORD LOCK is unlocked and turns off the LOCK indicator.
- The normal screen is returned.

7. (To unlock the PASSWORD for level 3 •••) Press the SET UP button.

- The <UNLOCK PASSWORD> screen appears.

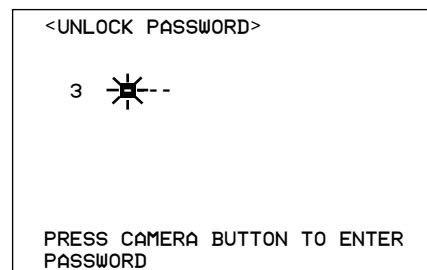

- ⦿ When the PASSWORD LOCK of level 1, level 2 and level 3 are set, the PASSWORD LOCK of level 2 will be active in case of unlocking level 1, and level 3 will be active in case of unlocking level 1 and level 2.

- ⚠ When the PASSWORD LOCK of level 1, level 2 and level 3 are set, level 3 only can not be unlocked. Be sure to unlock level 1 and level 2 too.

<INITIAL SET UP/INFORMATION> (continued)

8. Input the 4 digits of the PASSWORD number by pressing the camera number buttons or the ZOOM button.

- The PASSWORD LOCK is unlocked and turns off the LOCK indicator.
- The normal screen is returned.

❗ Press the LOCK button to return to the normal screen without input PASSWORD.

9. (To unlock the PASSWORD for level 4 ••••)
Set "MAIN HDD DATA CLEAR" or "SUB HDD DATA CLEAR" at the <INFORMATION/SERVICE> (1/2) screen.

- The <UNLOCK PASSWORD> screen appears.

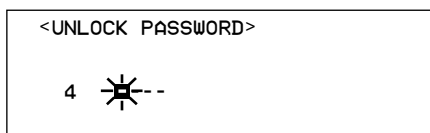

10. Input the 4 digits of the PASSWORD number by pressing the camera number buttons or the ZOOM button.

- The PASSWORD LOCK is unlocked and DATA CLEAR screen appears.

To lock the PASSWORD (only level1 to level 3) •••

1. Press the LOCK button using a ballpoint pen, etc., when the MAIN switch is set to ON.

- The PASSWORD LOCK is applied and the LOCK indicator lights.

To change the PASSWORD •••

1. Unlock the PASSWORD of level 1 to level 3 to display the <PASSWORD SETTING> screen.

2-1. (To change the PASSWORD for level 1 to level 3 ••••)
Display the <PASSWORD SETTING> (level 1 to level 3) screen. Turn the JOG dial to move the cursor to desired level to change the PASSWORD number and press the WARNING RESET button.

- The PASSWORD in "FIRST" and "SECOND" are cleared to appear "- - - -".

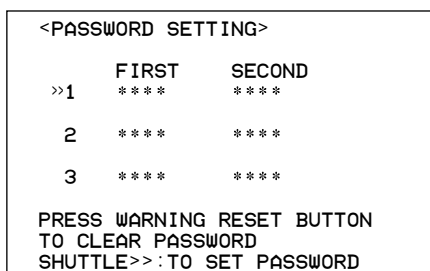

2-2. Input the new PASSWORD referring to "To register the PASSWORD •••".

3-1. (To change the PASSWORD for level 4 ••••)
Display the <PASSWORD> screen. Turn the JOG dial to move the cursor to cursor to "HDD DATA CLEAR", and turn SHUTTLE ring clockwise.

- The <CHANGE PASSWORD> screen appears.

3-2. Input the 4 digits of the PASSWORD number by pressing the camera number buttons or the ZOOM button.

- The PASSWORD LOCK is unlocked and <PASSWORD SETTING> screen appears.

3-3. Press the WARNING RESET button.

- The PASSWORD in "FIRST" and "SECOND" are cleared to appear "- - - -".

3-4. Input the new PASSWORD referring to "To register the PASSWORD •••".

Changing from PASSWORD LOCK mode to SIMPLE LOCK mode •••

1. Unlock the PASSWORD of level 1 to level 3 to display the <PASSWORD SETTING> screen.

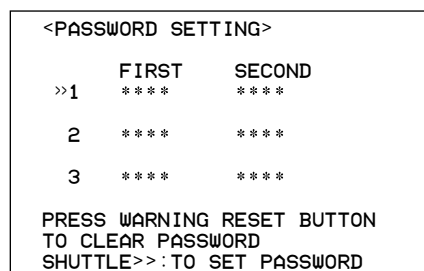

2. Confirm the cursor is at the left side of level 1 and press the WARNING RESET button.

- The PASSWORD in "FIRST" and "SECOND" are cleared to appear "- - - -".

3. Turn the JOG dial to move the cursor to level 3 after level 2 press the WARNING RESET button.

- The PASSWORD of all levels are changed to display "- - - -".

4. Turn the SHUTTLE ring counterclockwise or press the SET UP button.

■ LANGUAGE SELECTION

☞ See Page 25.

<QUICK SETTINGS>

■ QUICK SETTINGS

Menu settings stored on the Compact Flash Card can be read and altered with the unit. Menu settings in the unit can be copied to the Compact Flash Card.

ⓘ During execution of menu quick settings, other operations are not accepted.

◆ To update menu settings of this unit

ⓘ To read/alter menu settings stored on the Compact Flash Card using the unit, synchronize the HDD setting to that of the unit the menu settings were copied to. The HDD setting that needs to be synchronized is the "HDD SETTING", and "PARTITION SIZE".

ⓘ If the HDD settings are not synchronized, the menu settings are not updated.

1. Insert a Compact Flash Card recorded with menu settings into the COMPACT FLASH slot of this unit.

2. Select "QUICK SETTINGS" in the <SETTINGS> screen and turn the SHUTTLE ring clockwise.

• The <QUICK SETTINGS> screen appears.

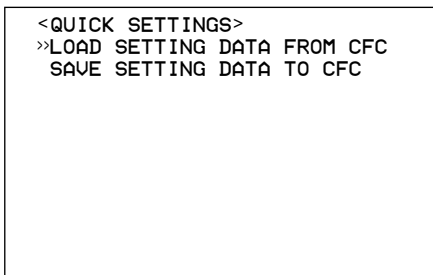

3. Select "LOAD SETTING DATA FROM CFC" and turn the SHUTTLE ring clockwise.

• The <SETTING DATA LOADING> screen appears.
• To cancel the update of menu settings, turn the SHUTTLE ring counterclockwise.

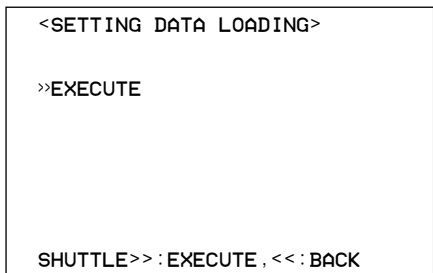

4. Turn the SHUTTLE ring clockwise.
• The menu settings of this unit is updated and <<COMPLETED>> appears on the screen.
• When no Compact Flash Card has been inserted <<MEDIA NONE>> will appear on the screen.

ⓘ Turn off POWER to finalize updated menu settings.

ⓘ When data with setting changes for any one item of "IP ADDRESS", "SUB NET MASK", "GATEWAY", "SERVICE PORT SETTING" on the <ETHERNET> screen or "IP ADDRESS", "TARGET" or "OWN" of the <ALARM NOTIFICATION SETTING> settings are read out or when settings are changed, restart is performed after the power has been cut.

ⓘ After menu read-out has been completed, the time is not reflected and the correct time should be set.

5. (Finalizing updated menu settings •••)
Turn the SHUTTLE ring counterclockwise three times, or return to normal screen by pressing the SET UP button.

6. Press the POWER button to turn the unit off, then press it once more to turn the unit back on.

• The setting is confirmed.

◆ To save menu settings of this unit to a Compact Flash Card

1. Insert a Compact Flash Card into the COMPACT FLASH slot of this unit.

2. Select "QUICK SETTINGS" in the <SETTINGS> screen and turn the SHUTTLE ring clockwise.

• The <QUICK SETTINGS> screen appears.

3. Select "SAVE SETTING DATA TO CFC" and turn the SHUTTLE ring clockwise.

• The <SETTING DATA SAVING> screen appears.
• When not saving the menu settings to the Compact Flash Card, turn the SHUTTLE ring counterclockwise.

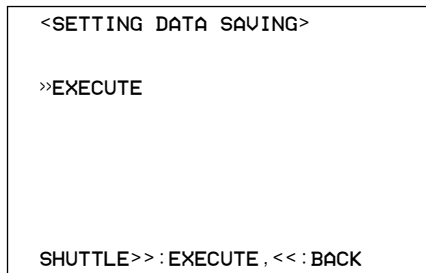

4. Turn the SHUTTLE ring clockwise.
• The menu settings are overwritten in the Compact Flash Card and <<COMPLETED>> appears on the screen.
• When no Compact Flash Card has been inserted <<MEDIA NONE>> will appear on the screen.

5. Turn the SHUTTLE ring counterclockwise or press the SET UP button.

ⓘ Menu read-out, setting change, and menu copying can be performed only when this unit is stopped (stop of playback/recording/communication).

ⓘ For LOAD/SAVE in the menu sometimes it takes a few seconds immediately after perform "EXECUTE".

Operation examples

■ Operation example 1

This example illustrates the procedure for switching between cameras according to time and day, when different numbers of cameras are allocated to RECORD SETTINGS A and B for normal recording in Timer record mode.

☞ For loading of camera video, ☞ see “Relation of recording operation to the number of cameras and recording interval settings”, page 89.

< Operation >

- REC MODE A (normal recording with all cameras) is set to Monday ~ Friday from 08:00 to 15:00 and REC MODE B (normal recording with camera number “ ① ”, “ ② ”, “ ③ ”, “ ⑦ ”, “ ⑧ ”, “ ⑨ ”) is set to 15:00 ~ 20:00.
- On weekends, REC MODE B (normal recording with camera number “ ① ”, “ ② ”, “ ③ ”, “ ⑦ ”, “ ⑧ ”, “ ⑨ ”) is set to 08:00 ~ 17:00.

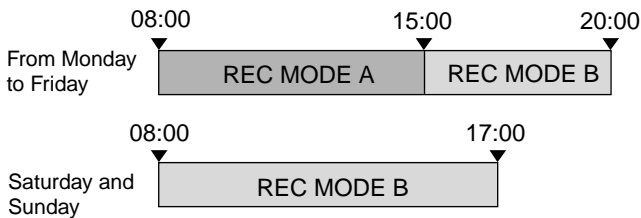

< Setting >

1) <CAMERA TITLE/MEMO SETTING> screen setting (☞ see pages 32,33).

- All cameras (“ ① ” ~ “ ⑨ ”).
- Input title.

```

<CAMERA TITLE/MEMO SETTING>
<CAMERA TITLE/MEMO SETTING>
① ENTRANCE1
② ENTRANCE2
③ VAULT
④ COUNTER1
⑤ COUNTER2
⑥ COUNTER3
⑦ EXIT1
⑧ EXIT2
>⑨ PARKING
MEMO .....
SHUTTLE>>: CHARACTERS
    
```

2) <INITIAL SET UP/INFORMATION> screen setting.

- AUDIO RECORDING : “OFF” (☞ see page 48)

```

<INITIAL SET UP/INFORMATION>
HDD SETTINGS
>>AUDIO RECORDING OFF
REAR TERMINAL SETTINGS
    
```

3) <HDD SETTINGS> screen setting (☞ see pages 47,48).

- HDD REPEAT REC MAIN : “ON”.

```

<HDD SETTINGS>
>>HDD REPEAT REC MAIN ON
HDD REPEAT REC SUB OFF
HDD REPEAT PLAY OFF
IM-CHECK PLAY OFF
    
```

4) <TIMER PROGRAM SETTINGS> screen setting (☞ see pages 44-46).

- SELECTED PATTERN : “P1”.

```

<TIMER PROGRAM SETTINGS>
>>SELECTED PATTERN P1-SET
HOLIDAY SETTING
REC MODE A
REC MODE B
REC MODE C
REC MODE D
ALARM REC DURATION 5S
    
```

5) <RECORD SETTING A> screen setting (☞ see page 46).

- All cameras (“ ① ” ~ “ ⑨ ”).
- PPS, GRADE : Set desired interval and picture quality for each camera.
- A-PPS : “-----”.

```

<RECORD SETTING A>
<RECORD SETTING A> ALARM CH
NO PPS GRADE A-PPS A-GRADE
① 2.5P STD ----- STD
② 2.5P STD ----- STD
③ 2.5P STD ----- STD
④ 2.5P STD ----- STD
⑤ 2.5P STD ----- STD
⑥ 2.5P STD ----- STD
⑦ 2.5P STD ----- STD
⑧ 2.5P STD ----- STD
>⑨ 2.5P STD ----- STD
<ESTD REC> ☐☐☐☐H☐☐☐M
    
```

6) <RECORD SETTING B> screen setting (☞ see page 46).

- Camera number “ ① ”, “ ② ”, “ ③ ”, “ ⑦ ”, “ ⑧ ” and “ ⑨ ” only.
- PPS, GRADE : Set desired interval and picture quality for each camera.
- A-PPS : “-----”.
- Other camera.
- PPS, A-PPS : “-----”.

```

<RECORD SETTING B>
<RECORD SETTING B> ALARM CH
NO PPS GRADE A-PPS A-GRADE
① 4.165P SUPER ----- STD
② 4.165P SUPER ----- STD
③ 4.165P SUPER ----- STD
④ ----- STD ----- STD
⑤ ----- STD ----- STD
⑥ ----- STD ----- STD
⑦ 4.165P SUPER ----- STD
⑧ 4.165P SUPER ----- STD
>⑨ 4.165P SUPER ----- STD
<ESTD REC> ☐☐☐☐H☐☐☐M
    
```

7) <TIMER PROGRAM> screen setting (☞ see pages 44,45).

- PROGRAM NO.1 : “SPL”, “08:00”, “15:00”, “A”, “OFF”.
- PROGRAM NO.2 : “SPL”, “15:00”, “20:00”, “B”, “OFF”.
- PROGRAM NO.3 : “SAT”, “08:00”, “17:00”, “B”, “OFF”.
- PROGRAM NO.4 : “SUN”, “08:00”, “17:00”, “B”, “OFF”.
- SPL : “MON - FRI”.

```

<TIMER PROGRAM>
DW START END MODE MD P1
1 SPL 08:00 15:00 A OFF
2 SPL 15:00 20:00 B OFF
3 SAT 08:00 17:00 B OFF
4 SUN 08:00 17:00 B OFF
5 --- :--- :--- :--- :---
6 --- :--- :--- :--- :---
7 --- :--- :--- :--- :---
8 --- :--- :--- :--- :---
>>SPL MON-FRI
    
```

When completed with all settings above and after clearing the menu screen, press the TIMER button. The unit will switch to the timer mode.

■ Operation example 2

This example uses the holiday setting.

< Operation >

• REC MODE A (normal recording with camera number “①” ~ “⑨”) is set to Monday ~ Friday from 08:00 to 15:00 and REC MODE B (normal recording with camera number “①”, “②”, “③”, “⑦”, “⑧” and “⑨”) is set to 15:00 ~ 20:00.

• On weekends, REC MODE B (normal recording with camera number “①”, “②”, “③”, “⑦”, “⑧” and “⑨”) is set to 08:00 ~ 17:00.

• 31/12, 1/1, 2/1 and 3/1 are set as holidays and REC MODE B is set to 08:00 ~ 17:00.

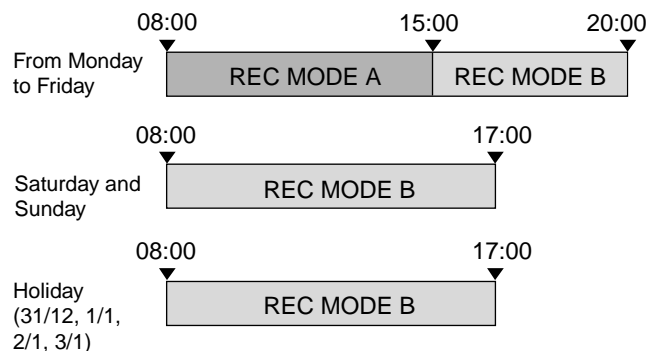

ⓘ When overlap both holidays set in the <HOLIDAY SETTING> screen and the <TIMER PROGRAM> screen, the unit records giving the priority to the holiday set in the <TIMER PROGRAM> screen over the others.

< Setting >

1) <CAMERA TITLE/MEMO SETTING> screen setting (see pages 32,33).

- Camera number “①” ~ “⑨”.
- Input title.

<CAMERA TITLE/MEMO SETTING>

<CAMERA TITLE/MEMO SETTING>	
①	ENTRANCE1
②	ENTRANCE2
③	VAULT
④	COUNTER1
⑤	COUNTER2
⑥	COUNTER3
⑦	EXIT1
⑧	EXIT2
>>⑨	PARKING
MEMO
SHUTTLE>>	CHARACTERS

2) <INITIAL SET UP/INFORMATION> screen setting.

- AUDIO RECORDING : “OFF” (see page 48).

<INITIAL SET UP/INFORMATION>	
HDD SETTINGS	
>>AUDIO RECORDING	OFF
REAR TERMINAL SETTINGS	

3) <HDD SETTINGS> screen setting (see pages 47,48).

- HDD REPEAT REC MAIN : “ON”.

<HDD SETTINGS>	
>>HDD REPEAT REC MAIN	ON
HDD REPEAT REC SUB	OFF
HDD REPEAT PLAY	OFF
IM-CHECK PLAY	OFF

4) <TIMER PROGRAM SETTINGS> screen setting (see pages 44-46).

- SELECTED PATTERN : “P2”.
- HOLIDAY SETTING : 31/12, 01/01, 02/01, 03/01.

<TIMER PROGRAM SETTINGS>	
SELECTED PATTERN	P2-SET
>>HOLIDAY SETTING	
REC MODE A	
REC MODE B	
REC MODE C	
REC MODE D	
ALARM REC DURATION	5S

<HOLIDAY SETTING>			
31/12	01/01	02/01	03/01
--/--	--/--	--/--	--/--
--/--	--/--	--/--	--/--
--/--	--/--	--/--	--/--
--/--	--/--	--/--	--/--
DAY/MONTH			

5) <RECORD SETTING A> screen setting (see page 46).

- Camera number “①” ~ “⑨”.
- PPS, GRADE : Set desired interval and picture quality for each camera.
- A-PPS : “-----”.

<RECORD SETTING A>

<RECORD SETTING A> ALARM CH				
NO	PPS	GRADE	A-PPS	A-GRADE
①	2.5P	STD	-----	STD
②	2.5P	STD	-----	STD
③	2.5P	STD	-----	STD
④	2.5P	STD	-----	STD
⑤	2.5P	STD	-----	STD
⑥	2.5P	STD	-----	STD
⑦	2.5P	STD	-----	STD
⑧	2.5P	STD	-----	STD
>>⑨	2.5P	STD	-----	STD
<ESTD REC>			□□□□	□□□□

6) <RECORD SETTING B> screen setting (see page 46).

- Camera number “①”, “②”, “③”, “⑦”, “⑧” and “⑨” only.
- PPS, GRADE : Set desired interval and picture quality for each camera.
- A-PPS : “-----”.
- Other camera.
- PPS, A-PPS : “-----”.

<RECORD SETTING B>

<RECORD SETTING B> ALARM CH				
NO	PPS	GRADE	A-PPS	A-GRADE
①	4.165P	SUPER	-----	STD
②	4.165P	SUPER	-----	STD
③	4.165P	SUPER	-----	STD
④	-----	STD	-----	STD
⑤	-----	STD	-----	STD
⑥	-----	STD	-----	STD
⑦	4.165P	SUPER	-----	STD
⑧	4.165P	SUPER	-----	STD
>>⑨	4.165P	SUPER	-----	STD
<ESTD REC>			□□□□	□□□□

Operation examples (continued)

7) <TIMER PROGRAM> screen setting (☞ see pages 44,45).

- PROGRAM NO.1 : "SPL", "08:00", "15:00", "A", "OFF".
- PROGRAM NO.2 : "SPL", "15:00", "20:00", "B", "OFF".
- PROGRAM NO.3 : "SAT", "08:00", "17:00", "B", "OFF".
- PROGRAM NO.4 : "SUN", "08:00", "17:00", "B", "OFF".
- PROGRAM NO.5 : "HOL", "08:00", "17:00", "B", "OFF".
- SPL : "MON - FRI".

<TIMER PROGRAM>					
DW	START	END	MODE	P2	MD
1	SPL	08:00	15:00	A	OFF
2	SPL	15:00	20:00	B	OFF
3	SAT	08:00	17:00	B	OFF
4	SUN	08:00	17:00	B	OFF
5	HOL	08:00	17:00	B	OFF
6	---	---	---	---	---
7	---	---	---	---	---
8	---	---	---	---	---

>>SPL MON-FRI

When completed with all settings above and after clearing the menu screen, press the **TIMER** button. The unit will switch to the timer mode.

■ Operation example 3

This example illustrates the procedure for using Pre-alarm recording, Alarm recording, Emergency recording with normal recording in Timer record mode.

< Operation >

• REC MODE C (pre-alarm recording, alarm recording and emergency recording with all cameras) is set to Monday ~ Friday from 08:00 to 15:00 and REC MODE D (pre-alarm recording, alarm recording and emergency recording with camera number "①", "②", "③", "⑦", "⑧" and "⑨") is set to 15:00 ~ 08:00 of the following day.

• On weekends, REC MODE D (pre-alarm recording, alarm recording and emergency recording with camera number "①", "②", "③", "⑦", "⑧" and "⑨") is set to 08:00 ~ 08:00 of the following day.

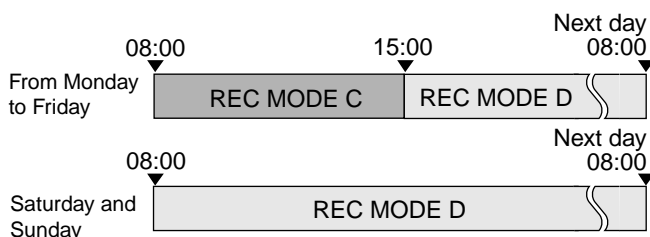

< Setting >

1) Set 1) ~ 3) of "Operation example " 1 " previous.

2) <REAR TERMINAL SETTINGS> screen setting (☞ see page 51).

- EMERGENCY REC DURATION : "20M".

<REAR TERMINAL SETTINGS>	
MODE OUT 1	OFF
MODE OUT 2	OFF
MODE OUT 3	OFF
MODE OUT 4	OFF
MODE OUT 5	OFF
KEY SOUND	ON
BUZZER	OFF
REMAIN HDD	MAIN-10%
CALL OUT SETTINGS	
>>EMERGENCY REC DURATION	20M

3) Set each item in the <MOTION DETECTION SETTINGS> screen for all cameras (☞ see pages 39,40).

<MOTION DETECTION SETTINGS>	
>>SELECTION CAMERA NO.	①
DETECTION MASK SETTING	
SENSITIVITY	HIGH •••<<LOW
MOTION THRESHOLD	5
TEST MODE	

4) <TIMER PROGRAM SETTINGS> screen setting (☞ see pages 44-46).

- SELECTED PATTERN : "P3".
- ALARM REC DURATION : "5M".

<TIMER PROGRAM SETTINGS>	
SELECTED PATTERN	P3-SET
HOLIDAY SETTING	
REC MODE A	
REC MODE B	
REC MODE C	
REC MODE D	
>>ALARM REC DURATION	5M

5) <REC MODE C> screen setting (☞ see page 46).

- MOTION DET REC : "ALARM"
- PRE ALARM REC : Set desired pre-alarm recording time.

<REC MODE C>	
ALARM SETTING	
RECORD SETTING	
PRE ALARM REC	(0S) 00S
>>MOTION DET REC	ALARM

6) <ALARM SETTING C> screen setting (☞ see page 46).

- All cameras (" ① " ~ " ⑨ ").
- TRIGGER : MD/EXT.
- EMR : All cameras (" ① " ~ " ⑨ ") is setting.

<ALARM SETTING C>

<ALARM SETTING C>			ALARM CH
ALARM	RECORD CAMERA	TRIGGER	
1	①-----	MD/EXT	
2	-②-----	MD/EXT	
3	--③-----	MD/EXT	
4	---④-----	MD/EXT	
5	----⑤-----	MD/EXT	
6	-----⑥---	MD/EXT	
7	-----⑦--	MD/EXT	
8	-----⑧-	MD/EXT	
>>9	-----⑨	MD/EXT	
EMR	①②③④⑤⑥⑦⑧⑨		

7) <RECORD SETTING C> screen setting (☞ see page 46).

- Camera selection during alarm recording : "ALARM CH".
- All cameras (" ① " ~ " ⑨ ").
- PPS, GRADE, A-PPS, A-GRADE : Set desired interval and picture quality for each camera.

☞ When "0S" is selected, the pre-alarm recording is inoperable.

<RECORD SETTING C>

<RECORD SETTING C> ALARM CH				
NO	PPS	GRADE	A-PPS	A-GRADE
①	2.5P	STD	2.5P	HIGH
②	2.5P	STD	2.5P	HIGH
③	2.5P	STD	2.5P	HIGH
④	2.5P	STD	2.5P	HIGH
⑤	2.5P	STD	2.5P	HIGH
⑥	2.5P	STD	2.5P	HIGH
⑦	2.5P	STD	2.5P	HIGH
⑧	2.5P	STD	2.5P	HIGH
>>⑨	2.5P	STD	2.5P	HIGH

<ESTD REC> DHM

<TIMER PROGRAM>						P3
DW	START	END	MODE	MD		
1	SPL	08:00	15:00	C		ON
2	SPL	15:00	08:00	D		ON
3	SAT	08:00	08:00	D		ON
4	SUN	08:00	08:00	D		ON
5	---	---	---	---	---	-
6	---	---	---	---	---	-
7	---	---	---	---	---	-
8	---	---	---	---	---	-

>>SPL MON-FRI

- 8) <REC MODE D> screen setting (see page 46).
- PRE ALARM REC : Set desired pre-alarm recording time.
 - MOTION DET REC : "ALARM"

<REC MODE D>	
ALARM SETTING	
RECORD SETTING	
PRE ALARM REC	(S) <input type="checkbox"/> S
>>MOTION DET REC	ALARM

When completed with all settings above and after clearing the menu screen, press the TIMER button. The unit will switch to the timer mode.

- 9) <ALARM SETTING D> screen setting (see page 46).

- Camera number " ① ", " ② ", " ③ ", " ⑦ ", " ⑧ " and " ⑨ " only.
- TRIGGER : MD/EXT.

<ALARM SETTING D>

<ALARM SETTING D> ALARM CH		
ALARM	RECORD CAMERA	TRIGGER
1	①-----	MD/EXT
2	-②-----	MD/EXT
3	--③-----	MD/EXT
4	---④-----	EXT
5	----⑤-----	EXT
6	-----⑥---	EXT
7	-----⑦--	MD/EXT
8	-----⑧-	MD/EXT
>>9	-----⑨	MD/EXT

EMR ①②③④⑤⑥⑦⑧⑨

- 10) <RECORD SETTING D> screen setting (see page 46).

- Camera number " ① ", " ② ", " ③ ", " ⑦ ", " ⑧ " and " ⑨ " only.
- PPS, GRADE, A-PPS, A-GRADE : Set desired interval and picture quality for each camera.
- Other camera.
- PPS, A-PPS : "- - - - -".

⊖ When "0S" is selected, the pre-alarm recording is inoperable.

<RECORD SETTING D>

<RECORD SETTING D> ALARM CH				
NO	PPS	GRADE	A-PPS	A-GRADE
①	2.083P	SUPER	4.165P	HIGH
②	2.083P	SUPER	4.165P	HIGH
③	2.083P	SUPER	4.165P	HIGH
④	-----	STD	-----	STD
⑤	-----	STD	-----	STD
⑥	-----	STD	-----	STD
⑦	2.083P	SUPER	4.165P	HIGH
⑧	2.083P	SUPER	4.165P	HIGH
>>⑨	2.083P	SUPER	4.165P	HIGH

<ESTD REC> DHM

- 11) <TIMER PROGRAM> screen setting (see pages 44,45).

- PROGRAM NO.1 : "SPL", "08:00", "15:00", "C", "ON".
- PROGRAM NO.2 : "SPL", "15:00", "08:00", "D", "ON".
- PROGRAM NO.3 : "SAT", "08:00", "08:00", "D", "ON".
- PROGRAM NO.4 : "SUN", "08:00", "08:00", "D", "ON".
- SPL : "MON - FRI".

Various recordings

■ PRE ALARM RECORDINGS

During alarm recording, recording can be started a few seconds before the ALARM IN terminal is grounded or motion is detected.

☞ For details concerning pre-alarm recording settings, ☞ see “Recording mode settings A ~ D for normal recording/alarm recording” page 46.

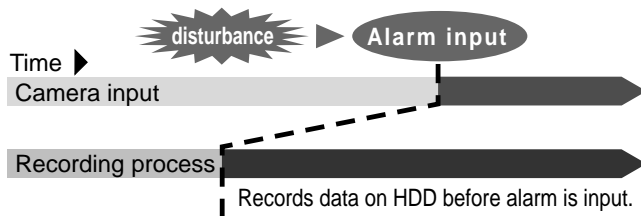

Pre-alarm recording :

- 1) A PRE ALARM indicator will be turned on if a “PRE ALARM REC” setup is set up in addition to “OS.”
- 2) Starts recording video before the ALARM IN terminal is ground or motion is detected.
- 3) Can only be executed when pre-alarm recording has been set in the <RECORD SETTINGS> screen or <REC MODE A> ~ <REC MODE D> screen. The recording channels after input of an alarm signals is executed only of camera set in the <RECORD SETTINGS> screen and <REC MODE A> ~ <REC MODE D> screen.

⚠ When a prealarm recording enters during normal recording, pre-alarm recording may be performed for a time different from the time entered for “PRE ALARM REC”.

⚠ When the alarm recording mode at the time of prealarm recording is “ALARM CH”, prealarm recording during normal recording is not possible for all camera numbers set for alarm recording.

■ EMERGENCY RECORDINGS

If the EMERGENCY terminal is grounded when the MAIN switch on the rear of the unit, and the POWER button on the front of the unit are both ON and during timer recording, EMERGENCY RECORDING will start automatically overriding all other settings.

⚠ Emergency recording cannot be made when the MAIN switch is OFF, the POWER button is OFF and during timer recording stand-by.

☞ For details concerning emergency recording settings, ☞ see page 51.

Emergency recording :

- 1) Emergency recording is performed using all cameras set to recording interval in “A-PPS” in the <RECORD SETTING> screen which cameras are selected in “EMR” in the <ALARM SETTING> screen. For the record “SUPER” in “A-GRADE” is selected and “A-PPS” is the minimum recording interval which is selectable in each camera.

☞ If a power outage occurs during emergency recording, emergency recording is released after power is restored.

☞ If emergency recording is entered during timer recording, recording is stopped at the timer recording end time.

2) Cameras used

- Recording is performed with all cameras with “A-PPS” on the <RECORD SETTING> screen set to other than “- - - - -” out of the camera numbers selected by “EMR” on the <ALARM SETTING> screen.
- During timer recording, recording is performed using all cameras other than those set to “- - - - -” in the recording mode of the set time frame.

3) During recording

- The EMERGENCY indicator flashes and then turns on when recording is completed.
- The camera number buttons that are used for alarm recording and the camera number display on the screen flash.
- The operation mode “ALARM” (in red) is displayed on the screen.

☞ To turn off the indicator, display the <ALARM LIST SEARCH> screen and press the WARNING RESET button for more than 5 seconds.

- 4) Recording is stored and displayed in the alarm list in red.

Various playback functions

Various playback functions that can be operated using the JOG dial and SHUTTLE ring keys are featured on this unit.

⚠ If this unit is prompted to receive a live image while playing back, this unit will end playback.

⚠ While this unit is being prompted to receive a live image while transmitting, this unit cannot play back.

■ Playing still frames

1. Press the PAUSE button during playback.

- The unit switches to still frame playback. Press the button again to resume playback.
- If a camera number (1 ~ 9) button is pressed during single screen still frame playback, the video of the camera number button pressed will be displayed by searching forward.

➡ Image playback displays only one picture. Press the camera button to perform search. When a camera number without a recorded image or few recorded images is specified, search may continue for hours. If it is unnecessary, press the SEARCH button to release search status.

■ Shuttle viewing/direct shuttle viewing

Turning the SHUTTLE ring during still frame playback, playback or reverse playback, the playback speed can be changed.

1. (During shuttle viewing •••)

Turn the SHUTTLE ring during still frame playback.

- The playback speed depends on the angle the SHUTTLE ring is turned.
- When letting go of the SHUTTLE ring, the ring will return to the center and the unit will return to still frame playback.

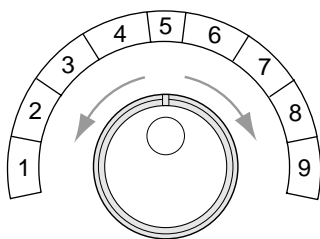

- 1 High-speed rewind (1GB units)
- 2 Reverse speed search (100MB units)
- 3 Reverse speed search (10MB units)
- 4 Reverse speed search (1MB units)
- 5 Still frame playback
- 6 Forward speed search (1MB units)
- 7 Forward speed search (10MB units)
- 8 Forward speed search (100MB units)
- 9 High-speed fast forward (1GB units)

2. (During direct shuttle viewing •••)

Turn the SHUTTLE ring during playback or reverse playback.

- The playback speed depends on the angle the SHUTTLE ring is turned.
- When letting go of the SHUTTLE ring, the ring will return to the center and the unit will return to still frame playback. (The unit will not return to playback or reverse playback.)

■ Shuttle hold

The playback speed can be maintained even when letting go of the SHUTTLE ring during shuttle viewing.

1. Press the PAUSE (SHUTTLE HOLD) button while holding the SHUTTLE ring in angle during shuttle playback.

2. Let go of the SHUTTLE ring.

- The playback speed is maintained.
- To cancel shuttle hold, press the PAUSE button. The unit will switch to still frame playback.

■ Frame-by-frame playback

1. Turn the JOG dial during still frame playback.

- Clockwise : Forward frame feeding.
- Counterclockwise : Reverse frame feeding.
- Clockwise and hold : Continuous forward frame feeding.
- Counterclockwise and hold : Continuous reverse frame feeding.
- When turning of JOG dial is stopped : Unit returns to still frame playback.

⚠ During frame feeding in the single screen mode, the frame feeding operation may not operate correctly when the JOG dial is turned too fast since frame feeding is performed while searching the video of the display camera number.

■ Reverse playback

1. Press the REV. PLAY (REVERSE PLAYBACK) button while playback is stopped.

- Playback will be made in the reverse direction. Playback will stop when press the STOP button.

➡ When reverse playback is performed first after turning the power on, the last recorded video will be played back in reverse first.

■ High-speed fast-forward/high-speed rewind

1. Turn the SHUTTLE ring for more than 1 second while playback is stopped.

- Clockwise for more than 1 second : Will activate High-speed fast-forward playback (1GB units).
- Counterclockwise for more than 1 second : Will activate High-speed rewind playback (1GB units).
- Press the STOP button: Playback is stopped.

➡ During high-speed fast-forward/rewind, the current position is displayed on the bottom or top of the screen. S (start) and E (end) indicate the beginning and end of the HDD space and "I" indicates the current position.

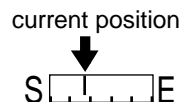

■ Changing playback intervals

Although, playback and reverse playback use the same interval as that for recording, it is possible to change the playback interval. This function is useful for slow-motion playback of fast-moving footage, or quick playback of extensive footage without skipping frames.

1-1. (To play back recording with fast motion slowly •••)

Press the REV. PLAY (REVERSE PLAYBACK) button during playback or reverse playback.

- Playback or reverse playback will be made at 0.125P intervals per camera.

Various playback functions (continued)

1-2. Press the **PLAY** button.

- The playback interval is changed to a faster setting (0.25P, 0.5P, and so on) each time the button is pressed.

2-1. (To play back video recorded using extended recording intervals fast •••)

Press the **PLAY** button during playback or reverse playback.

- Playback or reverse playback will be made at 50P intervals per camera.

2-2. Press the **REV. PLAY (REVERSE PLAYBACK)** button.

- The playback interval is changed to a slower setting (25P, 12.5P, and so on) each time the button is pressed.

❗ Audio cannot be played back when changing the playback interval.

❗ Once the playback interval is changed, audio will not be played back even when returning the playback interval to the original value. To playback audio, pause playback and then play the video again.

❗ Once the playback interval is changed, the green display of the playback interval will remain unchanged even when returning the playback interval to the original value. To check the original playback interval of the recording, pause playback and then play the video again.

❗ Altering the playback interval settings and then performing a quick playback of data with long recording time may cause discrepancies between actual recording time and the recording time displayed on the screen.

🔄 When changing to the single display mode with "2" or "3" set in "DISPLAY MODE" in the <TIME DATE /DISPLAY SETTINGS> screen, the playback interval is displayed on the screen in green for easy confirmation if the value is changed.

■ Simultaneous playback during recording

The recorded data can be played back simultaneously during the unit is recording.

❗ The video being played back may pause temporarily or the sound may be interrupted.

❗ Noise may be noticeable on the video during shuttle playback.

🔄 Split screen display can be selected individually for recording/playback.

The various search functions of this unit can be used to skip to the beginning of the desired video.

ⓘ If this unit is prompted to receive live images while search is set, this unit will not move to perform search. In addition, if prompted to receive live images while searching, this unit will forcibly stop search.

ⓘ This unit cannot search while being prompted to receive live images.

⊖ Image playback displays only one picture. Press the camera button to perform search. When a camera number without a recorded image or few recorded images is specified, search may continue for hours. If it is unnecessary, press the SEARCH button to release search status.

■ SEARCH SELECTION

The search screen appears when the SEARCH button on this unit is pressed. When pressing the SEARCH button again, the <SEARCH SELECTION> screen appears to select the playback device, search type and the camera number to search.

◆ SEARCH TYPE

When pressing the SEARCH button, which search screen to display from the 5 search functions is set.

<SEARCH SELECTION>			
>>SEARCH TYPE	TIME	DATE	
SELECTION CAMERA NUMBER	ALL		
PLAYBACK DEVICE			
MAIN			
START			
END	02-02-2004	00:00:00	
	04-04-2004	12:30:15	

Setting (default : "TIME DATE")
 "TIME DATE", "INDEX", "ALARM INDEX",
 "ALARM SKIP", "ALARM LIST"

1. Press the SEARCH button twice.
 - The search screen appears when the button is pressed the first time. The <SEARCH SELECTION> screen appears when the button is pressed again.
2. Display the desired setting in "SEARCH TYPE" and confirm.
3. Turn the SHUTTLE ring counterclockwise.
 - The search screen set in step 2 appears.
4. Turn the SHUTTLE ring counterclockwise or press the SEARCH button.

◆ SELECTION CAMERA NUMBER

The camera number to search is selected. "SELECTION CAMERA NUMBER" setting will not appear if "SEARCH TYPE" is set to "INDEX SEARCH".

<SEARCH SELECTION>			
SEARCH TYPE	TIME	DATE	
>>SELECTION CAMERA NUMBER	ALL		
PLAYBACK DEVICE			
MAIN			
START			
END	02-02-2004	00:00:00	
	04-04-2004	12:30:15	

Setting (default : "ALL")

"ALL", "①", "②", "③", "④", "⑤", "⑥", "⑦",
 "⑧", "⑨"

"ALL" : Searches all camera numbers ("①" ~ "⑨") and displays all images on a 9 split-screen.

"①" ~ "⑨" : Searches selected camera numbers, and displays on 1 screen the image that best matches specified criteria.

1. Press the SEARCH button twice to display the <SEARCH SELECTION> screen.
2. Display the desired setting in "SELECTION CAMERA NUMBER" and confirm.
3. Turn the SHUTTLE ring counterclockwise.
 - The display returns to the search screen.
4. Turn the SHUTTLE ring counterclockwise or press the SEARCH button.

◆ DATE/TIME

Displayed only when the previous "SEARCH TYPE" is set to "ALARM LIST". Used when narrowing down the number of lists to display on the screen during alarm list search (see pages 70,71).

◆ PLAYBACK DEVICE

Select the HDD to play back.

<SEARCH SELECTION>			
SEARCH TYPE	TIME	DATE	
SELECTION CAMERA NUMBER	ALL		
>>PLAYBACK DEVICE			
MAIN			
START			
END	02-02-2004	00:00:00	
	04-04-2004	12:30:15	

Setting (default : "MAIN")
 "MAIN", "SUB", "CFC"

ⓘ "SUB" is appeared on the screen when "PARTITION" is selected on "HDD SETTING" of the <INITIALIZATION> screen.

1. Press the SEARCH button twice to display the <SEARCH SELECTION> screen.
2. Display the desired setting in "PLAYBACK DEVICE" and confirm.
3. Turn the SHUTTLE ring counterclockwise.
 - The display returns to the search screen.
4. Turn the SHUTTLE ring counterclockwise or press the SEARCH button.

⊖ START/END display

The date/time of the recording start/end points of the device set in "PLAYBACK DEVICE" is displayed. Use this as reference when searching.

■ TIME DATE SEARCH

☞ See pages 24,25.

INDEX SEARCH/ALARM INDEX SEARCH

With this unit, index signals are automatically written to the HDD at the start of each recording. It is possible to search these signals and playback starting at such index points.

There are 2 types of index searches :

- <INDEX SEARCH> : Searches index signals written when starts recording.
- <ALARM INDEX SEARCH> : Searches index signals written when starts alarm recording and emergency recording.

Up to 99 indexes can be searched in either forward/reverse direction.

How indexes are counted for <INDEX SEARCH>, <ALARM INDEX SEARCH>

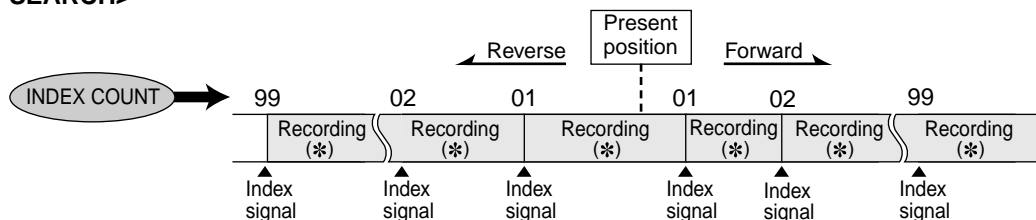

(*) : Normal recording for INDEX SEARCH. Alarm recording or emergency recording for ALARM INDEX SEARCH.

1. Press the SEARCH button.

- The search screen selected in the "SEARCH TYPE" (see page 67) appears.

☛ "SELECTION CAMERA NUMBER" setting will not appear if "INDEX SEARCH" is set.

2. (When the desired search screen is not displayed on the screen •••)

Change the previous "SEARCH TYPE" setting and display the "INDEX SEARCH" screen or "ALARM INDEX SEARCH" screen.

- When searching index signals of normal recording, display the "INDEX SEARCH" screen.
- When searching index signals of alarm recording or emergency recording, display the "ALARM INDEX SEARCH" screen.
- After performing INDEX SEARCH/ALARM INDEX SEARCH :
 - SPLIT9 screen is always displayed for INDEX SEARCH.
 - For ALARM INDEX SEARCH, SPLIT9 screen is displayed when setting the "SELECTION CAMERA NUMBER" (see page 67) to "ALL". Single screen with still frame playback is displayed when selecting individual camera number.

ⓘ When execute "ALARM INDEX SEARCH" while the "PARTITION" is set, set to "SUB" in "PLAYBACK DEVICE".

☛ The camera number written by the start index signal of the pre-alarm recording may differ from the camera number displayed in the alarm list.

3. Display the desired setting in "INDEX" and confirm.

4. Select "EXECUTE(FORWARD)" or "EXECUTE(REVERSE)" and confirm.

- "EXECUTE (FORWARD)" : Search is performed in the forward direction.
- "EXECUTE (REVERSE)" : Search is performed in the reverse direction.
- To cancel the search, press the SEARCH button twice.
- Search will not be performed if there are no index signals. To return to the normal screen, press the SEARCH button twice.

ⓘ Search may take time, depending on the recording status of the index signal. Press the STOP button while searching to end search.

☛ If the intervals of the index are long, search may continue for hours.

5. Playback the search result.

- Press the PLAY (REV. PLAY) or PAUSE button.

```
<INDEX SEARCH>
>>INDEX      01

EXECUTE (FORWARD)
EXECUTE (REVERSE)
MAIN
START      02-02-2004 00:00:00
END        04-04-2004 12:30:15

PUSH SEARCH KEY FOR
SEARCH SELECTIOIN
```

```
<ALARM INDEX SEARCH>
>>INDEX      01

EXECUTE (FORWARD)
EXECUTE (REVERSE)
MAIN
START      02-02-2004 00:00:00
END        04-04-2004 12:30:15

PUSH SEARCH KEY FOR
SEARCH SELECTION
```

6. To stop playback or still-frame playback, press the STOP button.

ⓘ To change the desired camera number to the single screen display during still-frame playback in SPLIT9 display, press the SEARCH button to clear the search setting screen and press the desired camera number button.

ⓘ Search may not perform properly at times depending on the recorded condition of the index signals.

7. To clear the search screen, press the SEARCH button twice.

■ ALARM SKIP SEARCH

This function searches up to where the Alarm recording signal is located, and can playback at 4 second intervals.

<ALARM SKIP SEARCH> In the case of forward direction

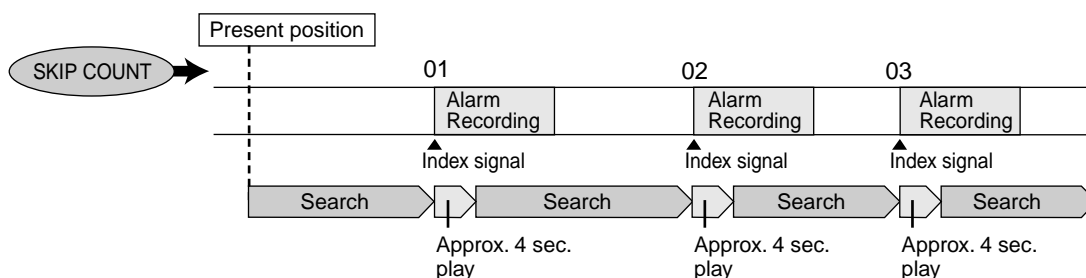

1. Press the SEARCH button.

• The search screen selected in the “SEARCH TYPE” (☞ see page 67) appears.

2. (When the desired search screen is not displayed on the screen •••)

Change the previous “SEARCH TYPE” setting and display the “ALARM SKIP SEARCH” screen.

3. Select “EXECUTE(FORWARD)” or “EXECUTE(REVERSE)” and confirm.

- “EXECUTE(FORWARD)” : Search is performed in the forward direction.
- “EXECUTE(REVERSE)” : Search is performed in the reverse direction.
- To cancel the search, press the SEARCH button twice.
- Playback of search result from skip search will be in SPLIT9 display regardless of whether the “SELECTION CAMERA NUMBER” (☞ see page 67) is set to “ALL” or individual camera number is selected.
- To return to the normal screen, press the SEARCH button twice.

ⓘ When execute “ALARM SKIP SEARCH” while the “PARTITION” is set, set to “SUB” in “PLAYBACK DEVICE”.

⊞ Search may take time, depending on the recording status of the index signal. Press the STOP button while searching to end search.

⊞ Press the desired camera number button when performing skip search in SPLIT9 display, the video of the camera number button is changed to single screen display.

4. Press the PAUSE button when the desired video is displayed and press the PLAY button.

5. To stop ALARM SKIP SEARCH, press the STOP button.

6. To clear the search screen, press the SEARCH button twice.

ⓘ When performing skip search in the reverse direction with index signals of less than 4 seconds, that portion may play back repeatedly. In this case, press the STOP button to stop the search and perform skip search in the reverse direction again after the particular portion has been passed using reverse playback, etc.

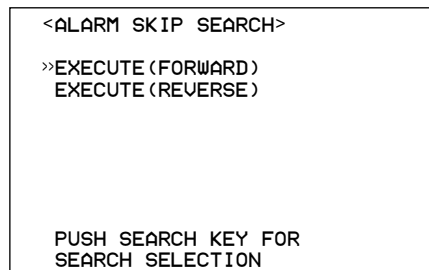

❗ Search may not perform properly at times depending on the recorded condition of the index signals.

❗ Search may take time, depending on the recording status of the index signal. Press the STOP button while searching to end search.

6. To clear the search screen, press the SEARCH button twice.

■ ALARM LIST SEARCH

This unit stores the start time of alarm recording and emergency recording in the alarm list when such recording begins. It is also possible to index search the desired time (or the closest time) from the list of alarm recording (emergency recording) start times stored in the alarm list.

❗ To clear the alarm list, erase the data in the <MAIN HDD DATA CLEAR> (<SUB HDD DATA CLEAR>) screen. Beware that executing it erases all the data of HDD contained the video data. Alarm recording then will be stored again from 00001.

➡ Up to 10,000 alarm recording (emergency recording) start times can be stored and displayed.

➡ In the alarm list, items with the ALARM IN terminal on the rear grounded are indicated in white, items that were detected with motion are indicated in green and items with the EMERGENCY terminal grounded are indicated in red.

1. Press the SEARCH button.

• The search screen selected in the "SEARCH TYPE" (see page 67) appears.

```

<SEARCH SELECTION>
>>SEARCH TYPE          ALARM LIST
SELECTION CAMERA NUMBER ALL
DATE/TIME ***-**-**** **: **: **
PLAYBACK DEVICE          SUB

SUB

START      02-02-2004 00:00:00
END        04-04-2004 12:30:15
    
```

➡ The Alarm list may take time to display completely when there are many list items or the HDD has been expanded.

2. (When the desired search screen is not displayed on the screen ●●●)

Change the previous "SEARCH TYPE" setting and display the "ALARM LIST SEARCH" screen.

❗ To display the emergency recording start time in the alarm list, set "SELECTION CAMERA NUMBER" in the <SEARCH SELECTION> screen to "ALL". "EMR" indicating emergency recording will appear in the place of the camera number in the alarm list.

Camera of alarm input
Recorded camera

```

<ALARM LIST SEARCH>
>>00004 01-01-2004 00:00:04 ② 1
00003 01-01-2004 00:00:03 EMR
00002 01-01-2004 00:00:02 ① 1
00001 01-01-2004 00:00:01 EMR

PUSH SEARCH KEY
    
```

❗ "Camera of alarm input" displays the camera number which is input alarm signals, and "record camera" displays the camera number which started recording.

❗ When the correspondent cameras for alarm signals are not set for the recording, the record is stored using the camera of the youngest number.

❗ When execute "ALARM LIST SEARCH" while the "PARTITION" is set, set to "SUB" in "PLAYBACK DEVICE".

➡ If motion is detected and the ALARM IN terminal on the back is grounded at the same time, all of those start times may not be registered to the alarm list. In such cases, the smallest numbered camera is registered to the camera list.

4. Select the desired alarm list number and turn the SHUTTLE ring clockwise to confirm.

- ▲ button/turn JOG dial counterclockwise : Selection moves to the next number.
- ▼ button/turn JOG dial clockwise : Selection moves to the previous number.
- ► button : Displays the page with date prior to the date of the currently opened page.
- ◀ button : Displays the page with date newer than the date of the currently opened page.
- To cancel search, press the SEARCH button twice.
- After performing alarm search, the screen will be in the single screen display with still-frame playback regardless of whether setting "ALL" in the "SELECTION CAMERA NUMBER" (see page 67) or selecting an individual camera number.

❗ The camera number written by the start index signal of the pre-alarm recording may differ from the camera number displayed in the alarm list.

❗ When setting "HDD REPEAT REC MAIN" to "OFF" or "STANDBY", "HDD REPEAT REC SUB" to "OFF" and there is an alarm recording (emergency recording) at the end of the HDD, that recording may not be stored in the alarm list and that number may become missing and not displayed.

➡ When an alarm recording (emergency recording) is performed during using display of the <ALARM LIST SEARCH> screen, exit the <ALARM LIST SEARCH> screen and display the screen again. The new item will be added to the list.

⏪ When using “DATE/TIME” in the <SEARCH SELECTION> screen, the number of list items displayed on the screen can be narrowed down.

1. Press the **SEARCH** button to display the <SEARCH SELECTION> screen.

2. Set the desired date and time of the result in “DATE/TIME” and confirm.

3. Turn the **SHUTTLE** ring counterclockwise once to display narrowed-down list.

4. *Playback the search result.*

• Press either the **PLAY (REV. PLAY)** or **PAUSE** button.

5. *To stop playback or still-frame playback, press the **STOP** button.*

6. *To clear the search screen, press the **SEARCH** button twice.*

■ START/END SEARCH

It is possible to search the recording starting/ending point of the device (media) selected by “PLAYBACK DEVICE” in <TIMER DATE SEARCH>, <INDEX SEARCH> and <ALARM INDEX SEARCH> for playback.

1. *Press the **SEARCH** button.*

• The search screen selected in previous “SEARCH TYPE” appears.

2-1. *(To play back the oldest recording ●●●)*

Select “START” and turn the **SHUTTLE** ring clockwise.

2-2. *(To play back the last recording ●●●)*

Select “END” and turn the **SHUTTLE** ring clockwise.

3. *Playback the search result.*

• Press the **PLAY (REV. PLAY)** or **PAUSE** button.

4. *To stop playback or still-frame playback, press the **STOP** button.*

⚠ To change the **SPLIT9** screen during still-frame playback to single screen display of the desired camera number, press the **SEARCH** button to clear the search mode screen and press the desired camera number button.

5. *To clear the search screen, press the **SEARCH** button twice.*

Making Copy/Restore

■ Making Copy/Restore

Data in MAIN HDD or SUB HDD can be copied to Compact Flash Card. Data in Compact Flash Cards can be restored to MAIN HDD.

Setting

“MAIN HDD → CFC” : The data recorded on MAIN HDD is copied to Compact Flash Card.

“SUB HDD → CFC” : The data recorded on SUB HDD is copied to Compact Flash Card.

“CFC → MAIN HDD” : The data recorded on Compact Flash Card is restored to MAIN HDD.

❗ “SUB HDD → CFC” is appeared when “PARTITION” is selected on “HDD SETTING” of the <INITIALIZATION> screen.

❗ Before use, read the cautionary notes described in the manual included with Compact Flash Card.

1-1. (To copy to a Compact Flash Card •••)
Insert the Compact Flash Card into the COMPACT FLASH slot of this unit.

1-2. Press the COPY button.
• The <COPY> screen appears.

1-3. Display “MAIN HDD → CFC” (“SUB HDD → CFC”) on “DIRECTION” and confirm.

```
<COPY>
>>DIRECTION      MAIN HDD→CFC
MODE              OVERWRITE
TRANSFER PERIOD  START•END
START            01-01-2004 00:00:00
END              01-01-2004 00:00:10

EXECUTE
```

2-1. (To restore data from or Compact Flash Card •••)
Press the COPY button.
• The COPY screen is displayed.

2-2. Display the desired setting “CFC → MAIN HDD” on “DIRECTION” and confirm.

```
<RESTORE>
>>DIRECTION      CFC→MAIN HDD
MODE              OVERWRITE
TRANSFER PERIOD  START•END
START            01-01-2004 00:00:00
END              01-01-2004 00:00:10

EXECUTE
```

➡ The menu changes to <RESTORE> when “CFC → MAIN HDD” is selected.

➡ The warning display at the time of RESTORE execution displays “RESTORE/XXX” when the <RESTORE> screen is displayed and “REST/XXX” when the normal screen is displayed.

3. Display the desired setting in “MODE” and confirm.

Setting (default : “OVERWRITE”)
“OVERWRITE” : Overwrites current data.

“NO OVERWRITE” : Writes following last entry.

❗ When “DIRECTION”, and “OVERWRITE” on “MODE”, all data on the Compact Flash Card regardless of menu division is overwritten.

4. Display the desired setting in “TRANSFER PERIOD” and confirm.

Setting (default : “START•END”)
“START•END” : Sets the recording start/end date/time.

“START” : Sets the recording start date/time.

“LATEST DATA” : Starts copying from the end point according to the available memory in the COPY device.

5. Set the desired copy (restore) start date and time to “START” and confirm.

6. (When setting “START•END” in step 4 •••)
Set the desired copy (restore) end date and time to “END” and confirm.

7. Select “EXECUTE” and turn the SHUTTLE ring clockwise.
• The copy (restore) operation is executed.
• If the copy (restore) operation does not start, turn the SHUTTLE ring counterclockwise or press the COPY button.

❗ The “COPY/NO MEDIA” or “REST/NO MEDIA” warning is displayed when executing COPY or RESTORE without a Compact Flash Card inserted in the slot.

❗ If the copy range exceeds the available capacity of the Compact Flash Card, “COPY/SIZE/DATA ERROR” warning will appear on the screen when copying (see pages 87,88). In this case, set again using narrower copy range or insert a Card larger capacity.

❗ If a data with no date is included in the copy range, “COPY/SIZE/DATA ERROR” warning will appear on the screen.

❗ When there is no data to restore in the Compact Flash Card “REST/SIZE/DATA ERROR” warning will appear on the screen when restoring.

❗ A “REST/MEDIA ERROR” error is displayed when executing RESTORE from a non-FSM2 Compact Flash Card.

❗ For usable Compact Flash Card, check with your dealer of purchase.

❗ When copy is performed during record, an image may not be recorded at the time of a copy start and an end. Be careful.

➡ For the recordable time when copying to a Compact Flash Card, (👉 see page 84.

➡ This image data is administrated in 1MB unit. Therefore, the copied area may be larger than the set area because copying is performed in 1MB units that include the specify area.

■ Copying from unit to videotape

Data can be copied even when the unit is recording. For recording operations, see the instruction manual accompanying the analog video cassette recorder.

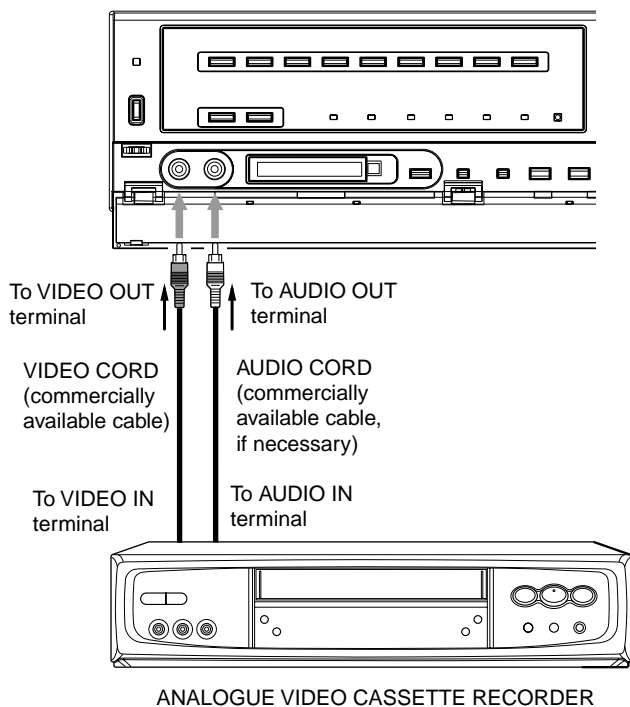

1. [Analogue video cassette recorder] Prepare the unit for recording.

- First, set the input source to the external input connecting this unit.

2. [This unit] Press the SPLIT/SEQUENCE button to select the screen type to play back (👉 see page 36).

- Single screen, SPLIT4 (a, b and c) screen and SPLIT9 screen can be selected.

➡ It is also possible to copy the video of each camera in order using single screen sequential playback (👉 see "SEQUENTIAL PLAY", page 48).

3. [This unit] Use the search function to move to the beginning of the video to copy (👉 see "START/END SEARCH", page 71).

4. [Analogue video cassette recorder] Start recording.

5. [This unit] Press the PLAY button to start playback.

6. To stop copying, press the STOP button of this unit. After stopping playback, stop the recording on the analogue video cassette recorder.

⚠ Only video recorded of camera number displayed on the screen can be copied to videotape.

Other convenient functions

■ Power failure compensation circuit

The unit is equipped with an internalized power failure compensation circuit. When the unit has been charged for 48 hours (full), the date, time, timer record settings, and menu settings are kept up to 1 month without power. The accuracy of the time will decline if the power plug is not connected to the wall outlet for an extensive period. In this case, it is recommended to check the current time setting.

■ Power failure reset recording

If there is a power failure during recording or when turning OFF the MAIN switch, the recording will resume after the power is restored. If there is a power failure during timer recording, the recording will resume after the power is restored when within the set time period of the timer. For alarm recording, recording will stop even within the set recording time.

☞ If there is a power outage while recording, video and audio of up to 6MB from immediately before the power outage will not be recorded.

☞ If there is a power outage while alarm recording or emergency recording, alarm recording and emergency recording will be released after power is restored.

☞ When recording is started, "REC ON" is registered in <WARNING LOG LIST>. However, "REC ON" will not be registered when recording is resumed after power is restored.

☞ The playback video at the start position where recording is resumed after a power failure may be disturbed and the search function may not operate properly.

■ Log function for when power failure occurs while the unit is in operation or the MAIN switch on the rear of the unit is turned OFF

In the event of power failure or the MAIN switch on the rear of the unit is turned OFF, up to 1000 items (including the time of failure and warning log displays as well as other warning items) are saved in the <WARNING LOG LIST> (see pages 54,55), and are displayed in red on the screen.

☞ For power outages that occur while timer recording is standing by, "P-LOSS" that indicates a power outage is not displayed. In addition, power outages that overlap with timer recording start times and those where power is restored after the recording end time are also not recorded.

■ RESET button

When pressing the RESET button on the rear of the unit with a ballpoint pen, etc., the unit is reset and the power turns off.

☞ The menu settings, the current time and video data are kept even when resetting the unit.

■ HDD SETTING

On the unit, "MIRRORING" and "PARTITION" can be selected for the HDD recording mode (see page 18).

Setting (default : "NORMAL")

"NORMAL", "MIRRORING", "PARTITION"

◆ MIRRORING

By saving the data in duplicate on two HDD's with the same capacity, the risk of data loss due to an HDD crash is greatly reduced.

☞ When using a MIRRORING function, two sets of HDD are required. It does not function in one HDD. Please consult with the retailer, when you add HDD.

1. Turn ON the MAIN switch on the rear of the unit, and wait until the ACCESS indicator goes off. Hold down the REC/STOP button, and press the POWER button on the front of the unit.

• The <INITIALIZATION> screen is displayed.

```
<INITIALIZATION>
>>HDD SETTING      NORMAL

POWER OFF
INITIALIZATION

ALL DATA WILL BE ERASED
WHEN PROCEED INITIALIZATION
```

☞ POWER button operation will not be accepted while the ACCESS indicator is flashing. Press the POWER button after the indicator turns off.

2. Select "HDD SETTING" by turning the JOG dial, display the "MIRRORING" setting, and turn the SHUTTLE ring clockwise.

```
<INITIALIZATION>
>>HDD SETTING      MIRRORING

POWER OFF
INITIALIZATION

ALL DATA WILL BE ERASED
WHEN PROCEED INITIALIZATION
```

3. Select "INITIALIZATION" by turning the JOG dial, and turn the SHUTTLE ring clockwise.

• The setting is made, and initialization commences.

⚠ Settings are not confirmed unless you perform "INITIALIZATION".

⚠ Initialization deletes all data in the HDD.

Points to be aware of regarding MIRROR mode

- Performing RESTORE restores identical data to both HDD master and HDD slave.
- Performing "MAIN HDD DATA CLEAR" in "MIRRORING" mode deletes all data in both HDD.
- In the event of a HDD master/HDD slave malfunction, HDD master/HDD slave items are registered separately on the <WARNING LOG LIST>.
- In the event that either HDD master or HDD slave malfunction, the "MIRROR" warning is displayed, and the operable HDD continues the recording. Press the WARNING RESET button on the front of the unit to reset the "MIRROR" warning.
- The "MIRROR" warning is displayed every time the unit is started-up until the faulty HDD is replaced.
- Automatic data archive commences at start-up after replacement with an operational HDD.
- If any HDD of each HDD master and HDD slave malfunction simultaneously, the data can not be repaired.
- Ask at place of purchase about data restoration when repairing/replacing a faulty HDD.

◆ PARTITION/PARTITION SIZE

PARTITION mode only uses the internal HDD. PARTITION mode designates the area inside the HDD that is specified as each HDD's sub-device capacity for Alarm recording. This independent partition inside the HDD allows to keep the data of alarm recording.

ⓘ The normal recording area is referred to as "MAIN", and the alarm recording area (PARTITION area) is referred to as "SUB".

1. Turn ON the MAIN switch on the rear of the unit, and wait until the ACCESS indicator goes off. Hold down the REC/STOP button, and press the POWER button on the front of the unit.

- The <INITIALIZATION> screen is displayed.

ⓘ POWER button operation will not be accepted while the ACCESS indicator is flashing. Press the POWER button after the indicator turns off.

2. Select "HDD SETTING" by turning the JOG dial, display "PARTITION", and turn the SHUTTLE ring clockwise.

- The "PARTITION SIZE" setting appears on the <INITIALIZATION> screen.

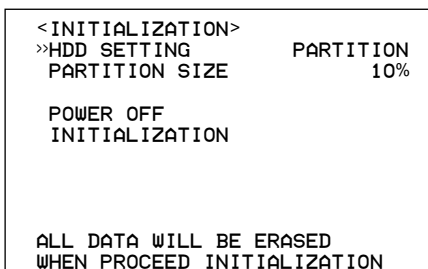

3. Display the desired device capacity, and turn the SHUTTLE ring clockwise.

- The setting is made.
- Setting of "PARTITION SIZE" (default : 10%)
10%, 20%, 30%, 40%, 50%, 60%, 70%, 80%, 90%

ⓘ The storage area in MAIN HDD set in "PARTITION" is displayed with the percentage(%) and the recordable time of that storage area is displayed in "<ESTD REC>".

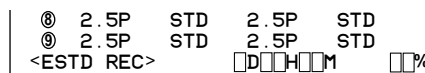

4. Select "INITIALIZATION" by turning the JOG dial, and turn the SHUTTLE ring clockwise.

- The setting is made, and initialization commences.

ⓘ Settings are not confirmed unless you perform "INITIALIZATION".

ⓘ Initialization deletes all data in the HDD.

Points to be aware of regarding PARTITION mode

- Either "MAIN" or "SUB" can be selected for copy.
- Playback, search, information display, REMAIN HDD, CALL OUT, and data delete functions are performed independently for "MAIN" and "SUB".
- When "HDD REPEAT REC SUB" is set to "OFF", and all memory in SUB HDD is used, the recording stops. Afterwards, the indicator will blink when an alarm enters, but no recording will be performed.
- When at the time of "ALARM CH" use an alarm signal enters to a camera number not set for normal recording, pre-alarm recording may not be performed in some cases.

■ COVERT CAMERA SETTING

The video of the specified camera number can be set to not be displayed regardless of the presence of video signals.

Setting (default : "ON")
"ON", "OFF"

☛ While COVERT CAMERA SETTING operation mode when the video is interrupted to playback such as camera trouble, warning indicator will not appear on the screen. If "WARNING" is set in BUZZER setting the BUZZER sounds and the unit registers this error in the WARNING LOG LIST, CALL OUT signal is emitted.

☛ When setting "COVERT CAMERA SETTING" to "OFF" for a camera set for recording operation, recording will be performed without displaying the video on the screen.

⚠ When setting "COVERT CAMERA SETTING" to "OFF", the playback video will not be displayed and the set camera number screen will turn black. Furthermore, the operation mode display and alarm display setting will not function.

1. Press the SET UP button and <SETTINGS> appears. With the <MPX DISPLAY SETTINGS> screen displayed, press the WARNING RESET button for more than 5 seconds.

- The <COVERT CAMERA SETTING> screen appears.

<COVERT CAMERA SETTING>

<COVERT CAMERA SETTING>	
NUMBER	DISPLAY
>>①	ON
②	ON
③	ON
④	ON
⑤	ON
⑥	ON
⑦	ON
⑧	ON
⑨	ON
ALARM DISPLAY	OFF

2. Turn the JOG dial to select the camera number to set and turn the SHUTTLE ring clockwise.

- The background of the setting turns red and flashes.

3. Turn the JOG dial to select "OFF" and turn the SHUTTLE ring clockwise.

- The setting is confirmed and flashing stops.
- The set camera number screen will turn black.

4. When continuing with setting for other camera number, repeat steps 2 and 3.

5. When completed with all settings, turn the SHUTTLE ring counterclockwise or press the SET UP button.

- The channel display of the camera number screen set with "OFF" for "COVERT CAMERA SETTING" will become black.

1	2	3
	5	6
7		9

◆ ALARM DISPLAY

Setting for displaying the single screen with alarm signal inputted when there is alarm signal. If another alarm signal is inputted during alarm recording, the camera video with the latest alarm signal will appear on the single screen display. After alarm recording is completed, the screen returns to the previous display.

Setting (default : "OFF")
"OFF", "ON"

1. Press the SET UP button and <SETTINGS> appears. With the <MPX DISPLAY SETTINGS> screen displayed, press the WARNING RESET button for more than 5 seconds.

- The <COVERT CAMERA SETTING> screen appears.

2. Select "ALARM DISPLAY" by turning the JOG dial, and turn the SHUTTLE ring clockwise.

- The background of the setting turns red and flashes.

3. Turn the JOG dial to select "ON" and turn the SHUTTLE ring clockwise.

- The setting is confirmed and flashing stops.

4. Turn the SHUTTLE ring counterclockwise or press the SET UP button.

■ Communications by Web Browser

The Web browser on the personal computer can capture the pictures that have been recorded and live pictures from the camera that is connected to this equipment.

ⓘ Microsoft and Windows are registered trademarks of the Microsoft Corporation in the US and other regions.
(The official name of Windows is Microsoft Windows Operating System.)
All other company and product names appearing herein are the property of their respective owners.
“®” is not shown in this text.

- Windows 98SE is an abbreviation of Microsoft Windows 98 Second Edition.
- Windows 2000 is an abbreviation of Microsoft Windows 2000 Professional.
- Windows Me is an abbreviation of Microsoft Windows Millennium Edition.
- Windows XP is an abbreviation of Microsoft Windows XP Home Edition/Professional.

◆ The personal computer product requirements

- OS : Microsoft Windows 98SE, Windows 2000, Windows ME or Windows XP.
- CPU : IBM PC/AT compatible with an Intel Pentium series processor of at least 500MHz.
- RAM : 256MB or more.
- Hard disk drive : System drive with unused space of at least 200MB.
- Web Browser Soft : Microsoft Internet Explorer 5.01SP2 or later.
- Display device : XGA (1024 pixels x 768 pixels) or higher.

ⓘ The product requirement described above cannot guarantee operations in all environments.
ⓘ Lack of compatibility between Web functions and the PC peripheral driver may, in rare instances, result in abnormal operation. If this happens, upgrade to the newest version of Internet Explorer and try again.

◆ Connections

- When making a direct connection between this equipment and a personal computer (here in after PC), use a cross cable, and when making a connection through a HUB, use a straight cable.
- The duplex mode is half duplex.
- Refer to the PC instruction manual for instructions on how to set the Web settings on the PC.

◆ AUTHENTICATION

Start up the Microsoft Internet Explorer and log in.

1. Start up the Microsoft Internet Explorer and enter the IP address.
 - The “[Authentication]” screen will appear.



- 2-1. (When logging in •••)
First, enter the “userID” and then enter the “password”. When shipped from the factory, the userID for the full-rights user is “root”, and the password is “admin000”, the userID for the live user is “guest” and the password is “guest”.

ⓘ More than one user can log in simultaneously using the same userID and password.
ⓘ However, there are restrictions due to authorization. The maximum number of users that can be connected at the same time is 10.

- 2-2. Select “log in” and then left-click or press ENTER.
 - The “Welcome” screen will appear.



Communications by Web Browser (continued)

3-1. (If you make an error in entering the userID or password •••)

- The “[Rejection]” screen will appear.

3-2. Select “[Back to Authentication]” and either left-click or press ENTER.

- The “[Authentication]” screen will appear.

3-3. Follow the steps in step 2-1 and enter the correct “userID” and “password”.

4-1. (If you do not log in •••)

Select “If you don’t want to log in, click here to exit.” and left-click.

4-2. The message “SessionID removed in recorder & browser. Please shut this Web Browser down to clear of your browser’s cache.” will display. Close the Web Browser.

5-1. (To change password •••)

The password can be changed in the “[Authentication]” screen only by the user who has the authorization to change a password. Follow the instructions in the menu and enter the present “userID” and “password”.

5-2. Enter the new password in “new password:” and again in “retype new password:”.

- ❗ The number of characters that can be used in registering a password is 16. Both alphabet letters and numbers can be used with a distinction made between upper and lower case. You cannot use spaces.

5-3. To change into a new password, select “change” and left-click or press ENTER. To stop the change, select “clear”, and left-click or press ENTER.

◆ Welcome

This is the screen for selecting, from “Menu”, “live monitor” with which live pictures will be retrieved and displayed, “playback” with which pictures that have already been recorded will be retrieved and displayed, “user maintenance”, with which the settings for user authorization will be configured, “log out” for ending a job, or “change log in user” for making a change in the logged-in user.

- ❗ Depending on what the user’s authorization is, there are certain menus that cannot be selected.

- ❗ During playback or during a search, this device will stop playback or search mode when a request for the acquisition of live images is transmitted.

- ❗ The transfer rate during transmission depends on the standard environment and load status of the recorder. To ensure stable transmission, use an image transfer rate that best matches the current usage conditions.

- ❗ The user’s sessionID (connection data) will be lost in 5 minutes from the final operation that includes image retrievals. If no operations are made within that 5 minutes, no other operations can be made after that so close the browser and then log in again.

- ❗ Live and recorded images can be acquired when the recorder POWER button is lit.

1. Select the desired “Menu” and left-click.



• Live monitor

Retrieves live images and displays the images on the PC screen.

1. Select “live monitor” and left-click.

- The “live monitor” screen will display.

- ❗ When image acquisition is tried for the first time with the Web browser of a personal computer, a message as shown below will be displayed. Please click “Yes”.



- ❗ When a live picture is acquired from the recorder and the <OUTPUT B ON/OFF> setting is “ON”, the updating speed for the Live monitor screen decreases. It is recommended to set the <OUTPUT B ON/OFF> setting to “OFF”.



⚠ Setting “Transfer Rate” too far on “Hi” may present obstacles to PC operation as determined by the performance of the PC you are using. Please set it to the appropriate rate to the image retrieval speed of your machine.

⚠ Depending on the network capacity and the load conditions, the transfer rate may not rise.

⚠ Only a user who has the authorization for “Change Password” can store screen layouts in the “Recorder” side using “Save Layout”. If the user who has authorization for “Change Password” stores screen layouts in both “Local PC” and “Recorder”, the information for “Local PC” is given priority. When storing layouts in “Local PC”, only one layout can be stored for one PC, even if users are different. To delete layouts that are stored in “Local PC”, delete the “Cookies” in the browser.

• **Playback**

Retrieves, plays back and search for images that have been recorded by the recorder.

1. Select “playback” and left-click.
 - The “playback” screen appears.

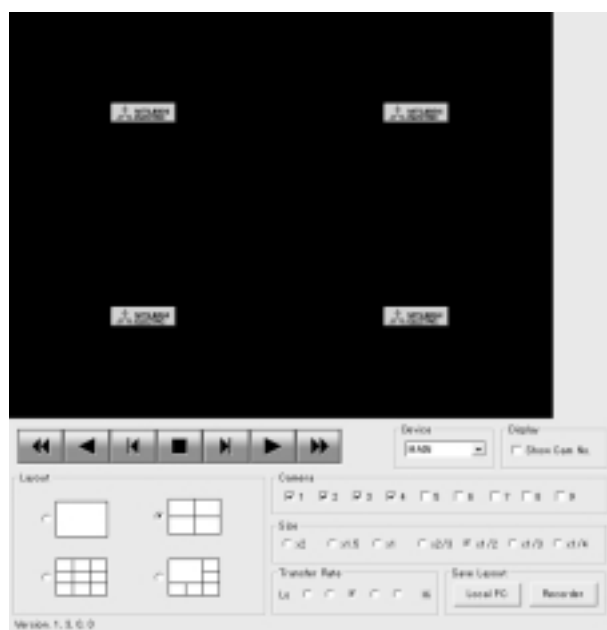

2. Press the PLAY button to start playback.

<Explanation of functions>

- STOP : Stops the retrieval of an image.
- GO : Starts (or restarts) the retrieval of an image.
- Display : For selecting either the display or non-display of a camera number.
- Layout : For selecting from the 4 types of display patterns. (default : split4 screen)
- Camera : Selects the camera number that you want to display and check.
- Size : Selects one of 7 patterns for the screensize: x2, x1.5, x1, x2/3, x1/2, x1/3, x1/4.
- Transfer Rate : Selects one of 5 stages from “Lo” to “Hi” for image retrieval speed. (default : middle)
- Save Layout : The layout of the screen display is registered to “Local PC” and “Recorder”.
- Back to [Welcome] : Returns to the “Welcome” menu.
- [Log out] : For logging out.

⚠ The sequence in which camera numbers have been selected is displayed from the top left.

⚠ The screen size regulated by “Size” is applied to the display field at the farthest upper left point in the screen layout.

<Function description>

- ▶ : Press to start playback.
- ▶▶ : Press to start speed search in the forward direction at speeds of x2, x4, x8 and x16.
- ▶| : Press to frame-by-frame playback in the forward direction.
- ◀ : Press to start reverse playback.

Communications by Web Browser (continued)

- ⏪ : Press to start speed searches in the reverse direction at speeds of x2, x4, x8 and x16.
 - ⏩ : Press to frame-by-frame playback in the reverse direction.
 - : During playback or searching, press to stop playback for still frame.
- Device : Selects the HDD for playback and search.
(default : MAIN)

• The following searches can be selected in single-screen display.

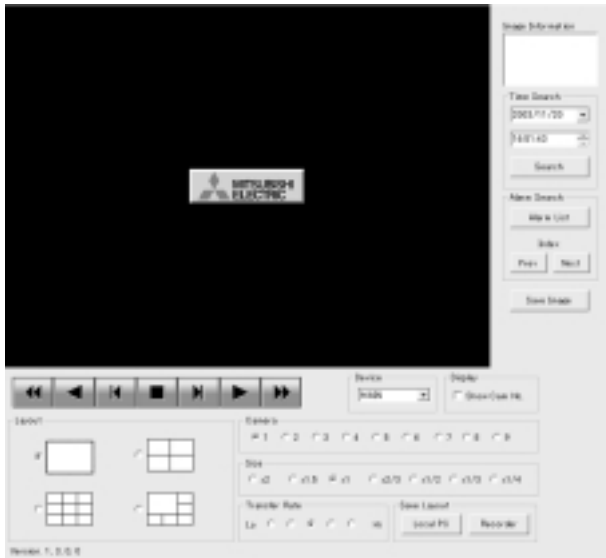

The date and time and the camera number for the image acquired are displayed in "Image Information". Clicking "Save Image" stores the picture that is freeze-frame displayed in the PC in bit map format.

ⓘ For the recorded image data search function, select single screen display at the "playback" screen to use each search mode while playback is stopped.

• Time Search

Select the date and time and click "Search".

• Alarm Search

Click "Alarm List" and the "Alarm List Search - MAIN" screen will appear in the sub-screen. Select the "Alarm No." desired, and then click "Search".

Alarm No.	Date	Camera No.	Sensor No.	Alarm Type
00024	12/03/2003 16:25:34	8	8	EXT
00023	12/03/2003 16:25:34	8	8	EXT
00022	12/03/2003 16:25:14	7	7	EMG
00021	12/03/2003 16:24:42	6	6	EXT
00020	11/03/2003 13:31:23	6	6	EXT
00019	11/03/2003 13:31:05	8	8	EXT
00018	11/03/2003 13:28:10	6	6	EXT
00017	03/03/2003 21:48:46	8	8	EXT
00016	03/03/2003 20:58:26	8	8	EXT
00015	03/03/2003 20:11:01	8	8	EXT
00014	03/03/2003 20:07:05	8	8	EXT
00013	03/03/2003 20:05:59	8	8	EXT
00012	03/03/2003 20:05:02	8	8	EXT
00011	03/03/2003 19:57:46	6	6	EXT
00010	03/03/2003 19:57:45	6	6	EXT
00009	03/03/2003 19:57:45	7	7	EXT
00008	03/03/2003 19:57:44	9	9	EXT
00007	03/03/2003 19:57:43	7	7	EXT
00006	03/03/2003 19:57:43	7	7	EXT
00005	03/03/2003 19:57:42	1	1	EXT
00004	03/03/2003 19:57:42	1	1	EXT
00003	03/03/2003 19:57:41	3	3	EXT
00002	03/03/2003 19:57:41	8	8	EXT
00001	03/03/2003 19:57:40	7	7	EXT

Click "Refresh" to re-acquire the "Alarm List", and click "Close" to hide the "Alarm List Search - MAIN" menu.

• Index Search

Click "Prev" for an index search in the reverse direction and click "Next" for an index search in the forward direction.

• User maintenance

This is the screen for changing the settings for registered user authorization and for deleting a registration. It can also be used for registering new users.

1. Select "user maintenance" and left-click.

- The "[Registration]" screen will appear.

[Registration]

Review & Change user-attribute

userID	password	LockMonitor	PlayMode	AllCamera	ChangePassword	Registration	Change	Remove User
root		<input checked="" type="checkbox"/>	<input type="checkbox"/>	<input type="checkbox"/>	<input type="checkbox"/>	<input checked="" type="checkbox"/>	change	
guest		<input checked="" type="checkbox"/>	<input type="checkbox"/>	<input type="checkbox"/>	<input type="checkbox"/>	<input type="checkbox"/>	change	remove

Register new user

userID	password	LockMonitor	PlayMode	AllCamera	ChangePassword	Registration
<input type="text"/>	<input type="text"/>	<input checked="" type="checkbox"/>	<input type="checkbox"/>	<input type="checkbox"/>	<input type="checkbox"/>	<input type="checkbox"/>

[close] [register]

[Back to [Welcome]] [Logout]

2-1. (To change registered user settings •••)

Select the userID for changing the settings in the "Review & Change user-attribute" settings.

- Select the items that you want to change.

<User authorization>

- Live Monitor : Allows acquisition of live images. It is a mandatory rank to be registered.
- Play Mode : Allows acquisition of recorded images. This authorization is only to a one user.
- All Camera : Allows the acquisition of images from a covert camera. (You also can acquire images from cameras that have the "COVERT CAMERA SETTING" set to "OFF".)
- Change Password : Allows the changing of user's password. Moreover, a screen layout can be saved to the recorder.
- Registration : Allows the viewing and editing of user registration information.

ⓘ Certain items cannot be selected depending on what the user authorization is.

ⓘ "Registration" authorization can be used by only one user. From the time that a user logs in until that user logs out and gives up authorization, any other user that logs in is regarded as a user who does not have "Registration" authority.

ⓘ "Play Mode" authorization can only be used by one user. From the time that a user logs in until that user logs out and gives up authorization, any other user that logs in is regarded as a user who does not have "Play Mode" authority.

2-2. (To change settings •••)
Select "change" and left-click. The "[Change Confirmation]" screen will appear.

2-3. If you want to make the change, left-click "change". If you want to cancel a change, left-click "cancel".

2-4. (When you have selected "change" •••)
The "[User's Attribute Changed]" screen will appear, so then left-click "Back to [Registration]".

- The return will be made to the "[Registration]" screen.

2-5. (When you have selected "cancel" •••)
• The return will be made to the "[Registration]" screen.

3-1. (When you have deleted a registered user •••)
Left-click on "remove" in the userID that you want to delete in "Review & Change user-attribute".

- The "[Remove confirmation]" screen will appear.

3-2. If you want to delete it, left-click "remove". If you don't want to delete it, left-click "cancel".

3-3. (If you have selected "remove" •••)
The "[User Removed]" screen will appear, so left-click "Back to [Registration]".

- The return will be made to the "[Registration]" screen.

3-4. (If you have selected "cancel" •••)
• The return will be made to the "[Registration]" screen.

4-1. (To register a new user •••)
Enter the new userID and new password in "Register new user".

4-2. Refer to step 2-1, select the "access auth." desired and check it.

ⓘ A userID with the same name cannot be registered. The maximum number of characters that can be used in registering a password is 16. Both alphabet letters and numbers can be used with a distinction made between upper and lower case. You cannot use spaces.

4-3. If you want to make a new registration, left-click "register". If you want to cancel a new registration, left-click "cancel".

4-4. (If you have selected "Register" •••)
It will be added to "Review & Change user-attribute".

4-5. (Selecting "cancel" •••)
Clears the specified contents.

• Log out

In this screen, assign "Log out" settings to end the job.

1. Select "log out" and left-click.
 - The "[log out]" screen will appear.



2. Close the Web Browser.

ⓘ If the browser is closed without correctly operating the log out, the user's sessionID will be saved for 5 minutes. If the Log in is made with the same userID within that 5 minutes, operation limits may take effect.

• Change log in user

This screen is for changing the logged in user.

1. Select "change log in user" and left-click.
 - The "[Authentication]" menu appears.

[Authentication]

logged in as: root

[Back to \[Welcome\] as Current User](#)

[If You don't want to log in, click here to exit \[log out\]](#)

Log in(or log in as a different user) : *** New ID and password are case sensitive ***

userID:

password:

Change Your Password : *** New ID and password are case sensitive ***

userID:

password:

new password:

retype new password:

2-1. (To change the logged in user •••)

In the “Log in (or log in as a different user):” settings, execute step 2-1 and 2-2 in “♦ AUTHENTICATION” and change the logged in user.

- The logged in user is changed and the “Welcome” screen appears.

2-2. (If the log in is made without changing the user •••)

Select “Back to [Welcome] as Current User” and left-click.

- The logged in user will remain as is and the “Welcome” screen will appear.

2-3. (To log out •••)

Select “If you don't want to log in, click here to exit.” and left-click.

Recording time table

■ Continuous recording time table

◆ HDD continuous recording time (for 250GB drive)

Displays the estimated recordable time (when recording on a 250GB HDD).

ⓘ The following table shows estimated recordable time when operating with 2 cameras and the recording interval is set at a constant PPS rate given at the top of the column.

• Without Audio recording

GRADE \ PPS	25P	12.5P	8.333P	6.25P	5P	4.167P	3.125P	2.5P	1P	0.5P	0.25P	0.125P	NUMBER OF RECORDING FIELD
SUPER	1d4h	2d9h	3d13h	4d18h	5d22h	7d3h	9d12h	11d21h	29d18h	59d12h	119d1h	238d3h	5,140,000
HIGH	1d13h	3d3h	4d17h	6d7h	7d21h	9d10h	12d14h	15d18h	39d9h	78d18h	157d12h	315d1h	6,800,000
STD	2d16h	5d8h	8d	10d16h	13d8h	16d1h	21d9h	26d17h	66d20h	133d17h	267d10h	534d21h	11,550,000
BASIC	3d17h	7d10h	11d3h	14d20h	18d13h	22d6h	29d16h	37d2h	92d17h	185d11h	370d22h	741d20h	16,020,000
LONG	8d3h	16d7h	24d11h	32d15h	40d19h	48d23h	65d6h	81d14h	204d	408d	816d1h	1632d2h	35,250,000

• With Audio recording <Audio recording using 12.8KHz PCM sampling is possible.>

GRADE \ PPS	25P	12.5P	8.333P	6.25P	5P	4.167P	3.125P	2.5P	1P	0.5P	0.25P	0.125P
SUPER	1d4h	2d9h	3d13h	4d13h	5d16h	6d19h	9d2h	11d8h	25d15h	45d19h	119d1h	238d3h
HIGH	1d13h	3d3h	4d17h	6d1h	7d14h	9d2h	12d3h	14d15h	33d21h	56d18h	157d12h	315d1h
STD	2d14h	5d5h	7d16h	10d6h	12d13h	15d1h	19d15h	23d23h	51d17h	81d12h	267d10h	534d21h
BASIC	3d15h	7d4h	10d15h	13d22h	17d4h	20d6h	26d3h	31d14h	65d6h	100d6h	370d22h	741d20h
LONG	7d	14d1h	21d	28d	34d11h	40d1h	50d8h	59d14h	105d2h	141d12h	816d1h	1632d2h

d : day, h : hour

ⓘ Continuous recordable time and the estimated time displayed on the menu screen is the continuous recordable time when operating this unit and is not the product warranty period. Furthermore, it is not the period that guarantees the operation of used parts.

ⓘ Audio recording cannot be performed when “PPS” of “RECORD SETTING” are all set to smaller than “0.333P” for normal recording.

• In this case, (X) appears to the right of recordable time display.

ⓘ Audio recording cannot be performed when the camera selection for alarm recording is as follows:

“ALARM CH” : “A-PPS” of all cameras set for alarm recording are set to smaller than “0.333P”.

“ALARM PLUS”, “ALARM25” : “PPS” and “A-PPS” of all cameras set for normal recording and alarm recording are set to smaller than “0.333P”.

ⓘ □ : Since audio recording cannot be made during recording interval of 0.25P and 0.125P, even when the recording with audio recording is set to ON, the recordable time is the same for when setting audio recording to OFF.

Recording time table (continued)

◆ Compact Flash Card continuous recording time (for 64MB)

Displays the estimated recordable time (when recording on a 64MB Compact Flash Card).

• Without Audio recording

GRADE \ PPS	25P	12.5P	8.333P	6.25P	5P	4.167P	3.125P	2.5P	1P	0.5P	0.25P	0.125P	NUMBER OF RECORDING FIELD
SUPER	20s	40s	1m10s	1m30s	2m	2m20s	3m10s	4m	10m	20m	40m	1h20m	1,200
HIGH	30s	1m	1m30s	2m	2m40s	3m10s	4m10s	5m20s	13m	26m	53m	1h40m	1,600
STD	50s	1m40s	2m40s	3m30s	4m30s	5m20s	7m10s	9m	22m	45m	1h30m	3h	2,700
BASIC	1m10s	2m30s	3m40s	5m	6m10s	7m30s	10m	12m	31m	1h	2h	4h10m	3,700
LONG	2m40s	5m30s	8m10s	11m	13m	16m	22m	27m	1h	2h10m	4h30m	9h10m	8,300

• With Audio recording <Audio recording using 12.8KHz PCM sampling is possible.>

GRADE \ PPS	25P	12.5P	8.333P	6.25P	5P	4.167P	3.125P	2.5P	1P	0.5P	0.25P	0.125P
SUPER	20s	40s	1m10s	1m30s	1m50s	2m10s	3m	3m50s	8m40s	15m	40m	1h20m
HIGH	30s	1m	1m30s	2m	2m30s	3m	4m	4m50s	11m	19m	53m	1h40m
STD	50s	1m40s	2m30s	3m20s	4m10s	5m	6m40s	8m	17m	27m	1h30m	3h
BASIC	1m10s	2m20s	3m30s	4m40s	5m50s	6m50s	8m50s	10m	22m	34m	2h	4h10m
LONG	2m20s	4m40s	7m	9m30s	11m	13m	17m	20m	35m	48m	4h30m	9h10m

① □ : Since audio recording cannot be made during recording interval of 0.25P and 0.125P, even when the recording with audio recording is set to ON, the recordable time is the same for when setting audio recording to OFF.

① Recalculate the values on the recording times chart according to the capacity of the CFC you are using. For example, for a 128MB CFC, multiply all the values by two.

① For usable Compact Flash Card, check with your dealer of purchase.

Troubleshooting

If problems with the unit persist even after you've followed the suggestions below, please disconnect the power cord and contact the retailer from whom you purchased the unit.

	Description of problem	Please consult the following	Page
INSTALLATION	The unit will not turn on.	<ul style="list-style-type: none"> • Is the power cord properly plugged in? • Is the LOCK indicator light on? • Is the TIMER button light on? • Is the MAIN switch on the rear set to "OFF" ? 	- 11,56-58 10 13
	Power is on, but the unit will not operate.	<ul style="list-style-type: none"> • Is the LOCK indicator light on? • Is the POWER button blinking? (The unit cannot be operated when the POWER button is flashing.) <ul style="list-style-type: none"> • It is possible that the safety features are in operation. Restart the unit by pressing the RESET button located on the back of the unit using a ballpoint pen or similar object.	11,56-58 10 13,74
	Images are not appearing on the monitor.	<ul style="list-style-type: none"> • Are the monitor and camera(s) connected correctly? • Is the unit receiving an input signal from the selected camera? Check this by setting the unit to SPLIT9. <ul style="list-style-type: none"> • Is "OUTPUT B ON/OFF" set to "ON"? Video from OUTPUT B will not be displayed when "OFF".	15 36 37
	The quality of the monitor picture is poor.	<ul style="list-style-type: none"> • Is the connecting cord connected correctly? • Is the camera's focus adjusted correctly? 	- -
RECORDING	The unit will not start recording.	<ul style="list-style-type: none"> • Is the "HDD REPEAT REC MAIN" set to "OFF" or "STANDBY" and "HDD REPEAT REC SUB" set to "OFF"? • The unit begins recording only after the specified recording time. Was the unit stopped during the specified recording time?	47 22,23
	The unit will not stop recording.	<ul style="list-style-type: none"> • Is the LOCK indicator light on? • During normal recording, alarm recording and emergency recording, press the REC/STOP button for more than 1 second. • Is timer recording in progress? To stop timer recording, press the TIMER button again for more than 1 second.	11,56-58 10,23 10
	The unit will not perform Repeat Recording.	<ul style="list-style-type: none"> • Is the "HDD REPEAT REC MAIN" and "HDD REPEAT REC SUB" set to "ON"? 	47
	The unit will not perform Timer Recording.	<ul style="list-style-type: none"> • Are the date and current time set accurately? • Are the Recording Start-/End-times and the recording interval set correctly? • Is the "HDD REPEAT REC MAIN" set to "OFF" or "STANDBY" and "HDD REPEAT REC SUB" set to "OFF"? • Is the "A-PPS" in the <RECORD SETTING> set as "- - - - -"? • Is the SUB HDD recordable capacity full? 	20,21 44-46 47 41,42 47
	The unit will not perform Alarm Recording.	<ul style="list-style-type: none"> • Is the unit in timer recording stand-by mode? (Is the TIMER button light on?) <ul style="list-style-type: none"> • Are the peripheral switches, etc., connected correctly? 	10 15

Troubleshooting (continued)

	Description of problem	Please consult the following	Page
PLAYBACK	The unit will not perform playback.	<ul style="list-style-type: none"> • Is the LOCK indicator light on? • Has the image data been erased? • Is the correct playback device selected? • Is there a prompt to receive live images? Playback cannot be performed while receiving images.	11,56-58 54 67 23,65,78
	The Compact Flash Card will not perform playback.	<ul style="list-style-type: none"> • Is the media correctly inserted? • Is the correct playback device selected? • Is the data of FSM2 format recorded? 	11 67 -
OTHERS	The unit will not perform the motion detection function.	<ul style="list-style-type: none"> • Is "TRIGGER" of the camera number that the motion detection function is confirmed in the <ALARM SETTING> screen set as "EXT" ? • Is the "A-PPS" of the camera number that the motion detection function is confirmed in the <RECORD SETING> screen set as "- - - - -". • Is the value in "MOTION THRESHOLD" of the <MOTION DETECTION SETTINGS> screen larger than the value set in "DETECTION MASK SETTING" ? 	41 42 40
	The unit will not respond to PC control.	<ul style="list-style-type: none"> • Is the <RS-232C> set correctly ? • Are the unit and computer connected correctly ? • Is there a defect in the connecting cable ? • Is the proper connecting cable being used ? 	52 - - -
	There is a camera number with a blue screen during split screen display.	<ul style="list-style-type: none"> • The screens of camera number with no video signal input will be blue even when setting for operation. 	36
	Button operation is not working.	<ul style="list-style-type: none"> • Is the POWER button flashing? (The unit cannot be operated when the POWER button is flashing?) • Is the LOCK indicator light on? 	10 11,56-58
	Cameras cannot be switched with the camera number buttons.	<ul style="list-style-type: none"> • Is the Menu screen being displayed? Camera number buttons cannot be used when the Menu screen is displayed. • Is the OUTPUT setup correct? While the OUTPUT B indicator is turned off, operation of OUTPUT A will function. While the OUTPUT B indicator illuminates, operation of OUTPUT B will function. 	- 10
	Unable to search.	<ul style="list-style-type: none"> • Is there a prompt to receive live images? Search cannot be performed while receiving images.	24,67,78

Warnings and CALL OUT output

■ Warnings and their appropriate countermeasures

#1 Options in the CALL OUT options column:

- Selectable : CALL OUT output can be selected/de-selected on the menu.
- Fixed : a CALL OUT signal is emitted without prior selection of this function using the menu.
- None : no CALL OUT signal is emitted, but a warning indicator will appear on screen.

⊖ CALL OUT signal output can be stopped by pressing the WARNING RESET button.

Warning Display	Status	Countermeasure	Canceling the warning	Code	CALL OUT output #1	page
REC/FULL	• MAIN HDD recordable capacity is full.	• When the warning is cancelled, the unit will start over-writing the oldest data remaining in the hard disk drive. • Copy data as necessary.	Press the WARNING RESET button.	WNG1100	Selectable	47
REC/SUB FULL	• SUB HDD recordable capacity is full.			WNG1101		72,73
COPY/FULL REST/FULL	• Media recordable capacity is full.	• Replace with new media. • Replace media if necessary.	Press the WARNING RESET button.	WNG3100 WNG4100	None	- -
REC/REM	• The remaining HDD capacity has reached the value set in HDD REMAIN.	• Copy data as necessary.	Press the WARNING RESET button.	WNG1200 (MAIN) WNG1201 (SUB)	Selectable	72,73
COPY/SIZE/ DATA ERROR REST/SIZE/ DATA ERROR	• The data that is being copied exceeds the capacity of Compact Flash Card, or there is no original data. It restored from the Compact Flash of a different format.	• Set the copy/restore range again. • Replace with new media.	Press the WARNING RESET button.	WNG3701 WNG4701	None	72,73 -
COPY/ MEDIA ERROR REST/ MEDIA ERROR	• Error has occurred in the media as Compact Flash.	• Check media in recording device. (Insert the media if there is none.)	Press the WARNING RESET button.	WNG3702 WNG4702	None	11,72
COPY/NO MEDIA REST/NO MEDIA	• No inserted media as Compact Flash.	• Insert the media.	Press the WARNING RESET button.	WNG3703 WNG4703	None	11,72
NO SIGNAL (The warning will indicate the number of the non-functioning camera.)	• Video signal was lost for more than 5 seconds during recording.	• Check whether the unit and camera are properly connected, and that electricity is on. • Check whether the visual signal is being properly outputted. • Check to see if there is a camera set for operation with no video signal input.	Stop recording. Output video signals. Press the WARNING RESET button.	WNG54□□#3	Fixed	15 36 22,23, 41-43

Warnings and CALL OUT output (continued)

Warning Display	Status	Countermeasure	Canceling the warning	Code	CALL OUT output #1	page
IMAGE MODIFIED	• Video data that has been altered was played back.	—	Press the WARNING RESET button.	WNG5500	Fixed when setting is "ON"	47
SYSTEM ERROR #4 REC/ SYSTEM ERROR #4 PLAY/ SYSTEM ERROR #4 COPY/ SYSTEM ERROR #4 REST/ SYSTEM ERROR #4	• System error has occurred.	• Reboot. • Check the HDD/media.	Press the WARNING RESET button.	WNG5100 WNG14□□#2 WNG24□□#2 WNG34□□#2 WNG44□□#2	Fixed	- -
REC/RW #4 COPY/RW REST/RW	• Error has occurred during writing (or reading) of data to HDD/media.	• Check the HDD/media.	Press the WARNING RESET button.	WNG13□□#2 WNG33□□#2 WNG43□□#2	None	-
MIRROR	• One HDD could not be detected during mirroring.	• Reboot.	Press the WARNING RESET button.	WNG6100	Fixed	-
<DEVICE ERROR>	• Unable to recognize HDD.	• Reboot.	Turn off the power.	WNG6200	Fixed	-
TEMP	• Issued when in a high temperature environment within the tolerance level.	• Turn off the power and change the installation condition.	Press the WARNING RESET button. Lower the temperature.	WNG5200	Fixed	-
FAN	• The fan stopped.	• Turn off the power and stop usage. • Repair is requested.	Press the WARNING RESET button. Rotate the fan.	WNG5300	Fixed	- -
COPY/OVER(RED)	• HDD recording has overtaken copy recording. Copy recording has stopped.	• Stop HDD recording to continue copy recording.	Press the WARNING RESET button.	WNG3500	None	72,73
COPY/OVER (WHITE)	• HDD recording is about to overtake copy recording.	• Stop HDD recording to continue copy recording. • Stop copy recording to continue HDD recording.	Press the WARNING RESET button.	WNG3600	None	72,73 -
(NONE)	• Reboots by watchdog operation.	—	—	WNG5101	—	-

#2 : (The following numbers are in□□)

0 0 : MASTER 01 : SLAVE

2 0 : CFC

#3 : (The following numbers are in□□)

0 1 : CH 1 0 2 : CH 2 0 3 : CH 3

0 4 : CH 4 0 5 : CH 5 0 6 : CH 6

0 7 : CH 7 0 8 : CH 8 0 9 : CH 9

#4 : A warning display disappears automatically after 1 minute.

■ Glossary

• I/O terminals

Terms used for referring to both input and output.

• RS-232C

Connection standard used for handling data between devices such as a PC, modem, etc. A standard when connecting a PC and modem. The upper limit for the communication speed of this standard is 115.2kbps and the maximum transfer distance is 15m. Since this standard only defines the roles and physical characteristics of the connector pins, there are various types of connectors such as 25-pin, D-sub, etc.

• Copy

Term used when copying part of data to an external storage media. The term "copy" in this manual refers strictly to the process of taking out only the data before and after failures from continuous video to the Compact Flash Card or video for analytical purposes.

• Compact Flash Card (CFC)

One of the standards for a compact memory card. The Compact Flash Card has such merits as strong durability and ease of handling.

• Partition

A partition is one of the many divided areas on the Hard Disk.

• Hard disk drive (HDD)

Storage device using the same magnetic recording process as tapes and is used in PCs. An aluminium disk coated with magnetic materials is used on the surface as the storage medium and since there is no contact during recording/playback, there is no head wear. Data search is also quick since recording is performed in numbered sections called sectors.

• Media

Term was originally referred to media that transmits information. Media mostly refers to hard disks, DVD RAM, MO disks, magnetic tapes, and are commonly referred to as storage media. Media types are largely categorized by the recording method, such as optical disks, magnetic optical disks, magnetic disks, etc.

• Capacity

Term to indicate the amount of data that can be stored in a storage device such as memory, disk, etc., and unit is indicated in B (bytes).

• Restore

Term referred to when copying data that has been backed-up in a Compact Flash Card, etc., to the built-in hard disk of the unit.

• Mirroring

One way of protecting data on magnetic disks. This function writes data alternately to 2 Hard disk drives with the same capacity. However, there is the demerit of using 2 drives in place of 1, resulting in half the available space.

■ Relation of recording operation to the number of cameras and recording interval settings

The recording pattern of this unit is as illustrated in the diagram below. Video data input from all the connected cameras is recorded sequentially. (Max. 50P recording interval during normal recording.)

