



10.1 Inch Full Ruggedized Tablet
FCC ID:O86T1500

Quick Start Guide



Thank you for your choosing the new Tablet.

This guide serves to enable users to get to know and familiar with our product as soon as possible. Here we have made a brief introduction to the key layout and definitions in figures and words.

Attention:

- This user guide is based on Windows 10 home edition
- This user guide is an introduction for full function tablet. Your device may not have all functions.
- This user guider applies to the following models: EM-I12/EM-I82/EM-I81
- The illustrations in this manual may differ from the actual product.

Contents

I . Use of the previous note	4
II . Key Layout and Definitions	5
VI. Introduction to Desktop.....	6
1. Windows 10 start image	6
2. Image slide applications	7
3. Introduction to app Interface	7
4. Charm menu column	9
5. Multitasking operating interface	11
IV. Basic Operations.....	11
1.Sleep, restart and power off	11

I . Use of the previous note

1. With the wrong type of battery replacement will be explosive danger, be sure to use the original battery.
2. The company shall not take any responsibility for the loss or removal of the information in the tablet, which is caused by the operation, maintenance or other accidents of the non-normal operation of the software and hardware.
3. Please backup your important information at any time.
4. Please do not disassemble the tablet; otherwise it will lose the right to guarantee.

II . Key Layout and Definitions

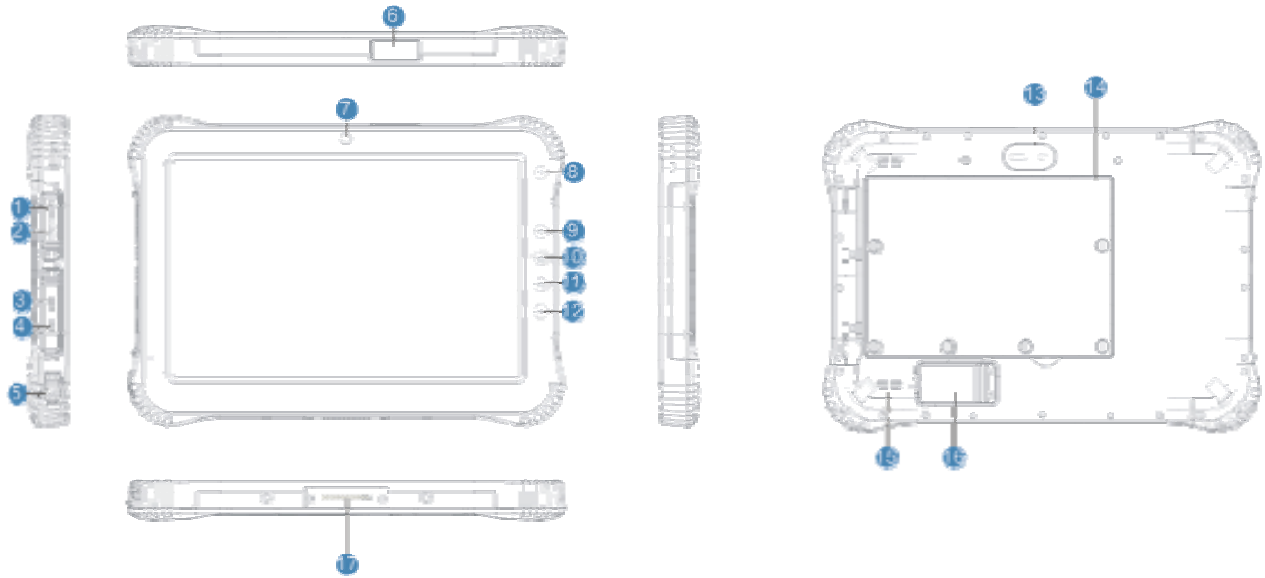

① **Earphone Jack:** the jack support outputs the audio signal to a loudspeaker or Headset

② **HDMI interface:** High-Definition Multimedia, Interface, high definition multimedia interface

③ **USB port:** Micro USB

④ **USB port:** Full Size USB

⑤ **Charging interface:** charging the tablet via DC adapter

⑥ **One-dimensional code scanner/ two-dimensional code scanner:** to support one / two-dimensional code scanning

⑦ **Front camera:** camera, video

⑧ **Power button:** to start or close touch screen panel. You can also let the computer to sleep or wake up from hibernation mode

⑨ **Scanning:** scanning button

⑩ **Home button :** get back to the Main by press this button

⑪ ⑫ **voice sound -/ voice sound+:**reduce / increase the volume

⑬ **Rear camera:** camera, video

⑭ **Removeable battery :** you can remove the battery by undoing screw ,before this please shutdown the tablet

⑮ **Speaker:** built-in speaker, so you can hear the sound without additional link equipment

⑯ **Fingerprint:** support fingerprint indentification

⑰ **The docking interface:** to support docking station

VI. Introduction to Desktop

1. Windows 10 start image

Windows 10 start image: On the start screen, you can see many programs fixed in the image. These application programs are displayed in the form of “magnet”. As long as you click them, you can easily visit them.

You need to log on your Microsoft account before the application program completely runs.

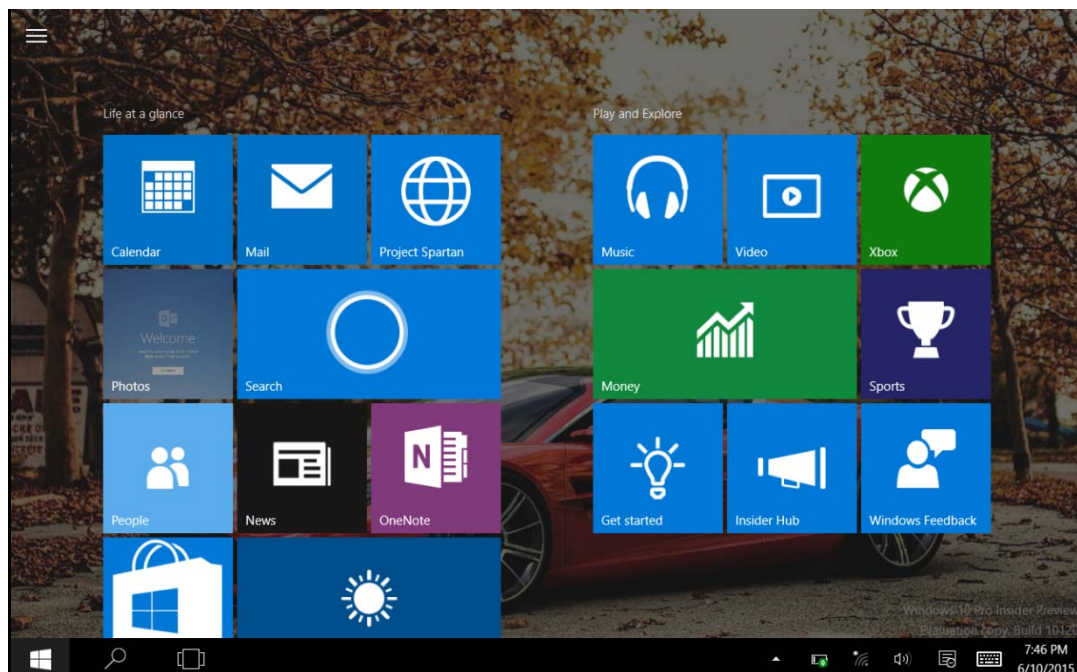

2. Image slide applications

Slide to right



Slide to the right from the left side of the screen to scan the application program in running.

Slide to left



Slide to the left from the right side of the screen to setting Charm menu column.

Slide downward



In start screen, slide from the top of the screen to view application programs

Slide with finger



In start screen, slide finger up and down to move the image.

3. Introduction to app Interface

Besides the application programs already fixed on the start screen, you can also start other application programs in all application programs, such as other software application programs attached to the Tablet .

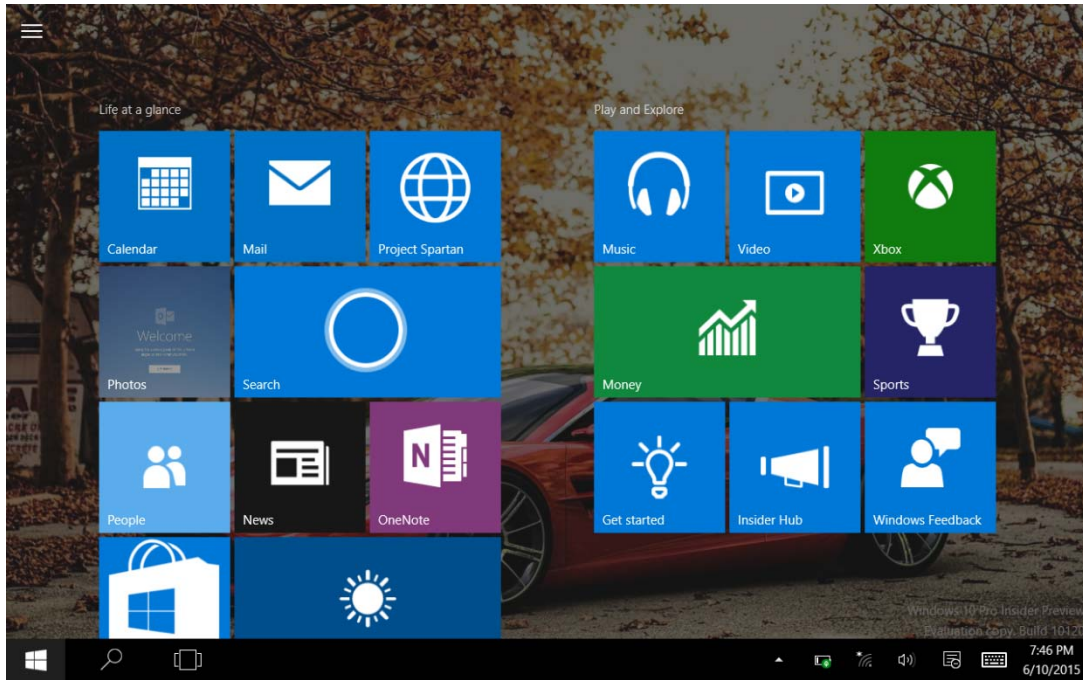

If you want to fix more application programs on the start interface, see the operation in the figure below, (1) Click the properties icon (2) press and hold the application program magnet for about one second and then let go (3) Click the Pin to start

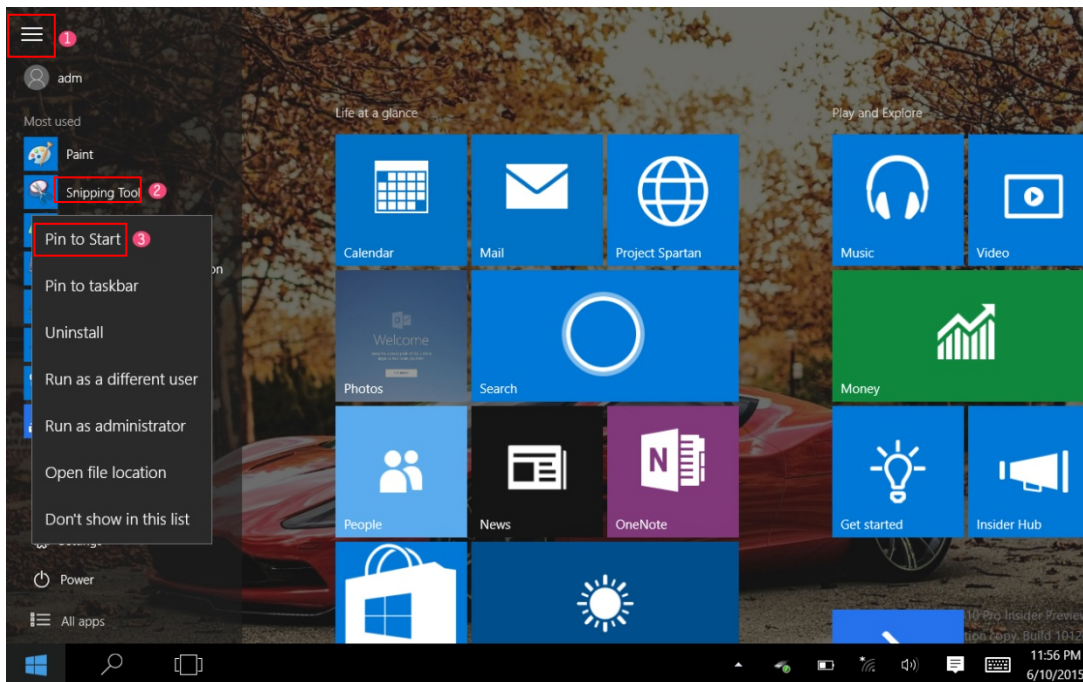

Conversely, if you want to cancel or delete a certain application in the start screen, (1) lightly touch, press and hold the application program magnet for about one second and then let it go and run, and select

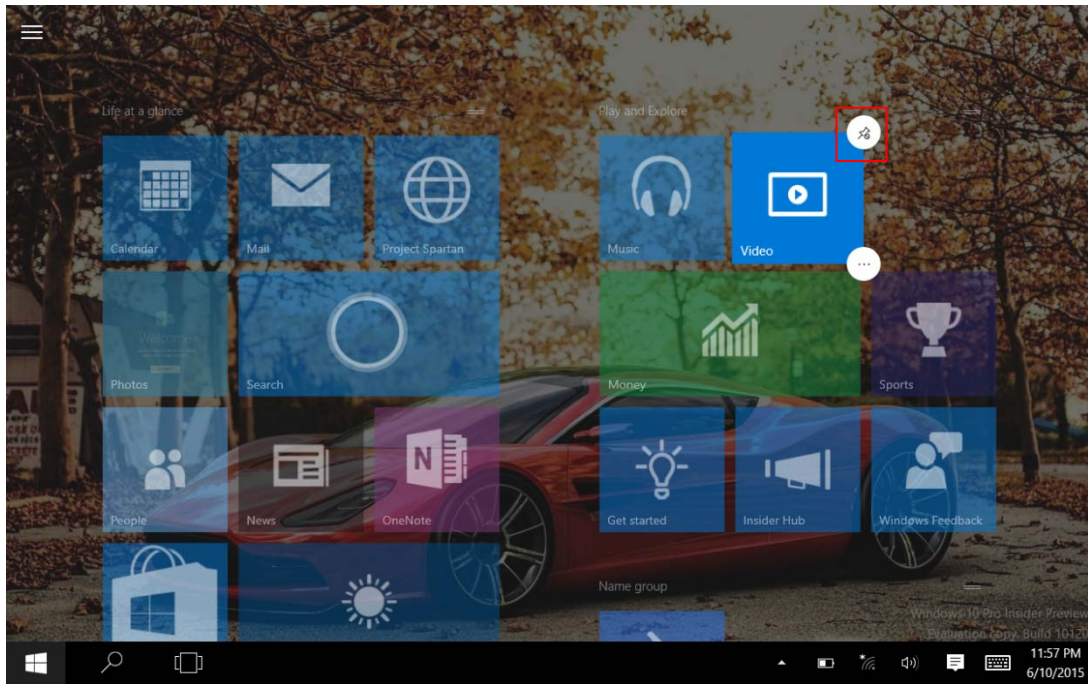

4. Charm menu column

Slide it to the left from the right side of the screen to start Charm menu column, including: Start, Device, Setup, Share, and Search Program.

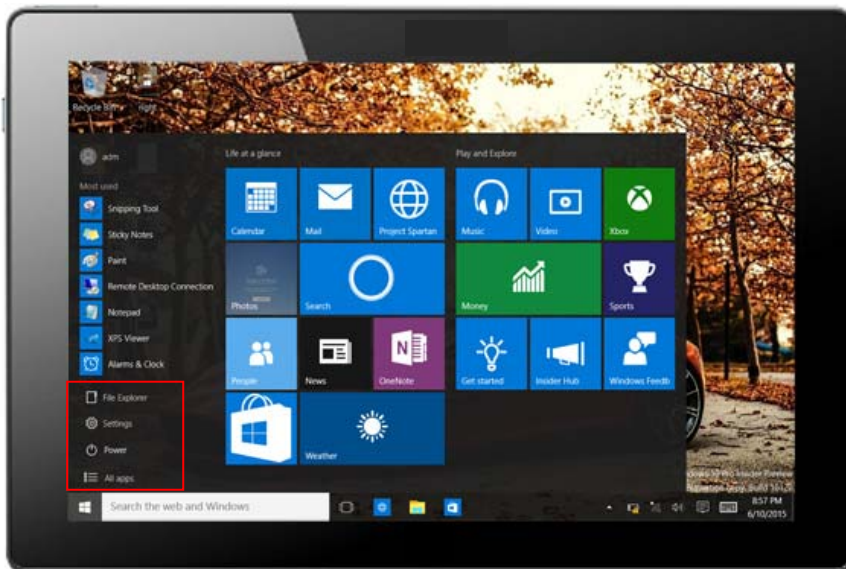

Slide it to the left from the right side of the screen to start Charm menu column, Usually: File Explorer,Settings,Power, and All apps

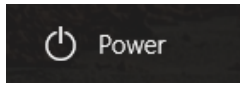

Can Sleep/Shut down/Restart the Tablet PC

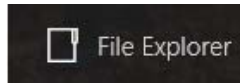

Can let you search the files and application programs in the Tablet PC.



Can let you set up the Table PC.

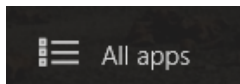

Can scan more apps

Search menu



Device Menu

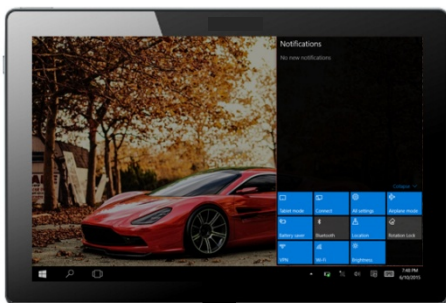

Set up Menu

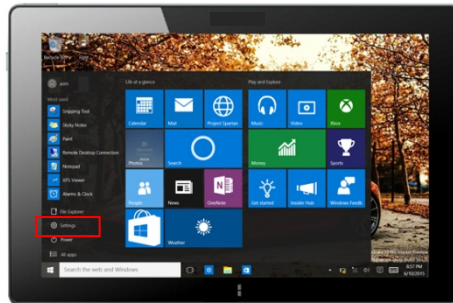

5. Multitasking operating interface

slide it right from the left side of the screen, Let go when Can see the running applications. We can enter the application, also can be deleted.

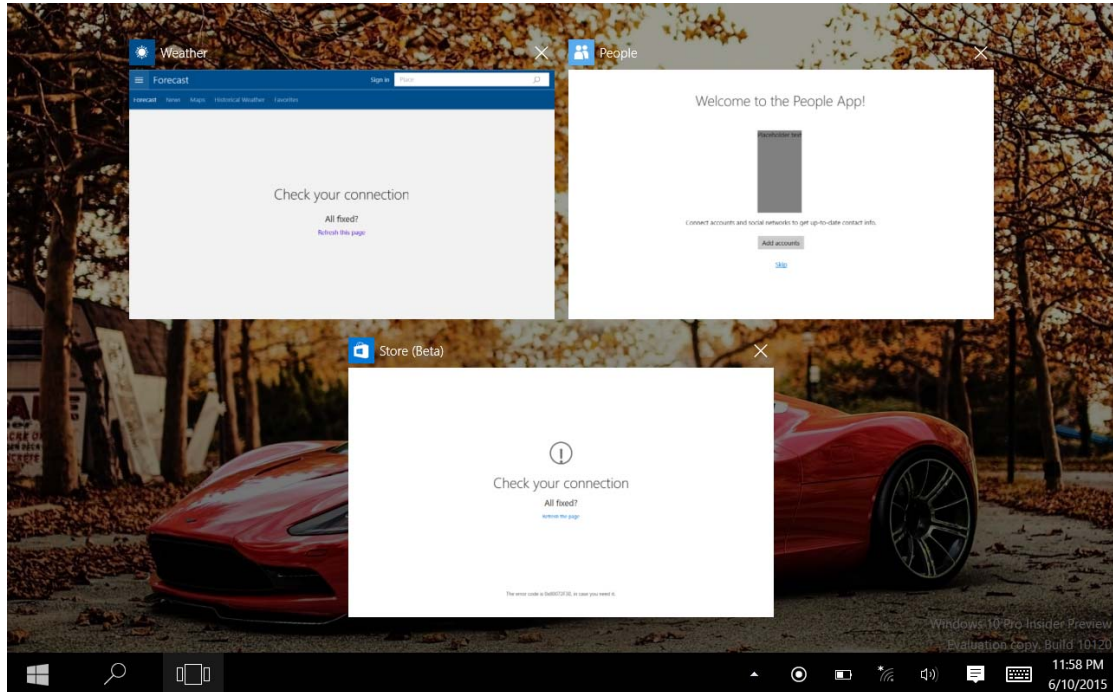

IV. Basic Operations

1. Sleep, restart and power off

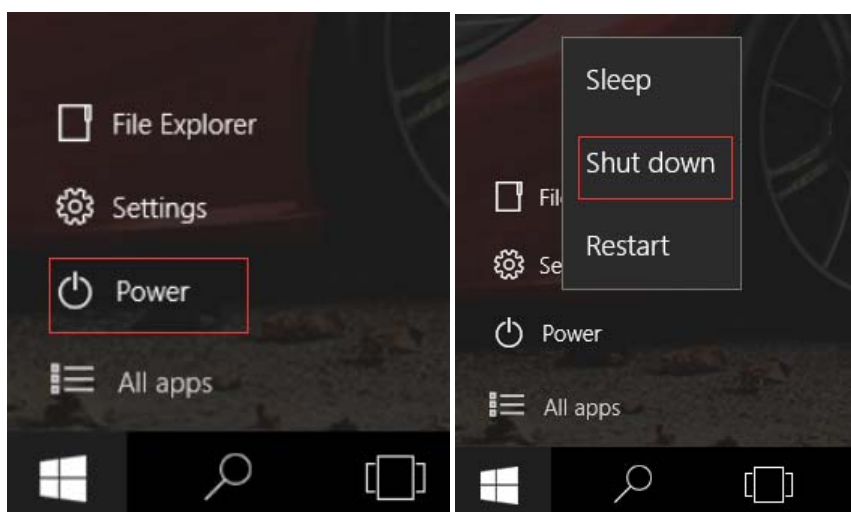

FCC Warning:

This device complies with Part 15 of the FCC Rules. Operation is subject to the following two conditions: (1) this device may not cause harmful interference, and (2) this device must accept any interference received, including interference that may cause undesired operation.

changes or modifications not expressly approved by the party responsible for compliance could void the user's authority to operate the equipment.

NOTE: This equipment has been tested and found to comply with the limits for a Class B digital device, pursuant to Part 15 of the FCC Rules. These limits are designed to provide reasonable protection against harmful interference in a residential installation. This equipment generates, uses and can radiate radio frequency energy and, if not installed and used in accordance with the instructions, may cause harmful interference to radio communications. However, there is no guarantee that interference will not occur in a particular installation. If this equipment does cause harmful interference to radio or television reception, which can be determined by turning the equipment off and on, the user is encouraged to try to correct the interference by one or more of the following measures:

- Reorient or relocate the receiving antenna.
- Increase the separation between the equipment and receiver.
- Connect the equipment into an outlet on a circuit different from that to which the receiver is connected.
- Consult the dealer or an experienced radio/TV technician for help.

Body-worn Operation

This device was tested for typical body-worn operations. To comply with RF exposure requirements, a minimum separation distance of **0mm** must be maintained between the user's body and the handset, including the antenna. Third-party belt-clips, holsters, and similar accessories used by this device should not contain any metallic components. Body-worn accessories that do not meet these requirements may not comply with RF exposure requirements and should be avoided. Use only the supplied or an approved antenna.