



CDM-Qx

Multi-Channel Satellite Modem with DoubleTalk™ Carrier-in-Carrier® Installation and Operation Manual

Note: This manual incorporates data for the CDM-Qx and CDM-QxL.

IMPORTANT NOTE: The information contained in this document supersedes all previously published information regarding this product. Product specifications are subject to change without prior notice.



Errata A

Comtech EF Data Documentation Update

Subject: Revised Acquisition Range for Demodulator

Date: January 23, 2007

Document: CDM-Qx, Multi-Channel Satellite Modem, Installation and Operation Manual, Revision 5, dated January 20, 2007

Part Number: MN/CDMQx.EA5

Collating Instructions: Attach this page to page A-3

Comments:

The following changes affects the acquisition rate specified in Section A.2.

Change Specifics:

Acquisition range	± 1 to ± 32 kHz, Symbol rate > 64 ksps (70/140 MHz) ± 1 to \pm (Symbol rate/2) kHz , Symbol Rate ≤ 64 ksps (70/140 MHz) ± 1 to ± 200 kHz, Symbol rate > 625 ksps (L-Band) ± 1 to ± 32 kHz, 64 ksps < Symbol Rate ≤ 625 ksps (L-Band) ± 1 to \pm (Symbol rate/2)kHz, Symbol Rate ≤ 64 ksps (L-Band) Programmable in 1 kHz increments.
--------------------------	--





Errata B

Comtech EF Data Documentation Update

Subject: Delete COMBINED TRANSMIT POWER Menu

Date: January 23, 2007

Document: CDM-Qx, Multi-Channel Satellite Modem, Installation and Operation Manual, Revision 5, dated January 20, 2007

Part Number: MN/CDMQx.EB5

Collating Instructions: Attach this page to page 5-22

Comments:

Delete Combined Transmit Power menu.





Errata C

Comtech EF Data Documentation Update

Subject: Revise Sub-Menu for Vit+RS and TCM+RS

Date: January 23, 2007

Document: CDM-Qx, Multi-Channel Satellite Modem, Installation and Operation Manual, Revision 5, dated January 20, 2007

Part Number: MN/CDMQx.EC5

Collating Instructions: Attach this page to page 5-25

Comments:

Revised Sub-Menu for Vit+RS and TCM+RS to delete Viterbi and TPC.

If Vit+RS orTCM+RS is selected, the following sub-menu will be displayed:

```
Rx Rs (n/k) :      (◀ ▶, ENT)
IESS-310 network  (219/201)
```





Errata D

Comtech EF Data Documentation Update

Subject: Add Sub-Menu for Vit+RS and TCM+RS

Date: January 23, 2007

Document: CDM-Qx, Multi-Channel Satellite Modem, Installation and Operation Manual, Revision 5, dated January 20, 2007

Part Number: MN/CDMQx.ED5

Collating Instructions: Attach this page to page 5-16

Comments:

Added requirements for IESS-310 mode to Tx menu.

If Vit+RS orTCM+RS is selected, the following sub-menu will be displayed:

```
Tx Rs (n/k) :      (◀ ▶, ENT)
IESS-310 network (219/201)
```





CDM-Qx

Multi-Channel Satellite Modem with DoubleTalk™ Carrier-in-Carrier Installation and Operation Manual

Note: This manual incorporates data for the CDM-Qx and CDM-QxL.

Comtech EF Data is an ISO 9001
Registered Company



Part Number MN/CDMQx.IOM
Revision 5
January 20,2007

CUSTOMER SUPPORT

Contact the Comtech EF Data Customer Support Department for:

- ▶ Product support or training
- ▶ Information on upgrading or returning a product
- ▶ Reporting comments or suggestions concerning manuals

Contact Customer Support using any of the following methods:

Mail: Comtech EF Data
Customer Support Department
2114 West 7th Street
Tempe, Arizona 85281 USA

Email: service@comtechefdata.com

Internet: www.comtechefdata.com

Phone: 480.333.2200 (Main Comtech EF Data Number)

480.333.4357 (Customer Support Desk)

Fax: 480.333.2161

To return a Comtech EF Data product (in-warranty and out-of-warranty) for repair or replacement:

1. Request a Return Material Authorization (RMA) number from the Comtech EF Data Customer Support Department.
2. Be prepared to supply the Customer Support representative with the model number, serial number, and a description of the problem.
3. To ensure that the product is not damaged during shipping, pack the product in its original shipping carton/packaging.
4. Ship the product back to Comtech EF Data. (Shipping charges should be prepaid.)

Table of Contents

CHAPTER 1. INTRODUCTION.....	1-1
1.1 Introduction.....	1-1
1.2 Features.....	1-2
1.2.1 DoubleTalk™ Carrier-in-Carrier®	1-3
1.2.2 Software – Flash Upgrading.....	1-3
1.2.3 Verification	1-3
1.2.4 Data Interfaces	1-4
1.2.5 Turbo Product Coding.....	1-4
1.2.6 Remote Control.....	1-4
1.3 Major Assemblies.....	1-4
1.4 FAST Options and Hardware Options	1-5
1.4.1 FAST Accessible Options	1-6
1.4.2 FAST System Theory.....	1-6
1.4.3 Implementation	1-6
1.4.4 Hardware Options	1-6
1.4.5 Supporting Hardware and Software (Future Feature).....	1-7
1.5 L-Band	1-7
1.6 Compatibility.....	1-7
CHAPTER 2. INSTALLATION.....	2-1
2.1 Unpacking.....	2-1
2.2 Mounting.....	2-2
2.3 Configuration	2-4
2.4 Select Internal IF Loop.....	2-4
2.5 Connect External Cables.....	2-4

CHAPTER 3. FUNCTIONAL DESCRIPTION	3-1
CHAPTER 4. EXTERNAL CONNECTIONS	4-1
4.1 Introduction.....	4-1
4.2 Front Panel	4-2
4.3 Rear Panel	4-3
4.4 Chassis Connections	4-5
4.4.1 USB Port	4-5
4.4.2 M&C 10/100BaseT Connector.....	4-5
4.4.3 485/232 Connector	4-5
4.4.4 Alarms Connector	4-6
4.4.5 Balanced G.703 Connector Tx/Rx Connector.....	4-7
4.4.6 Unbalanced G.703 Tx/Rx Connectors	4-7
4.4.7 RS-530 Data Interface Connector	4-8
4.4.8 RX and TX IF Connectors	4-9
4.4.9 Ref Connector	4-9
4.5 AC Power Connector.....	4-9
4.6 DC Power Connector.....	4-9
4.7 Ground Connector	4-10
CHAPTER 5. FRONT PANEL OPERATION	5-1
5.1 Introduction	5-1
5.2 Left-Hand Display Area.....	5-4
5.2.1 Modems	5-4
5.2.2 Redundancy	5-5
5.2.3 Spectrum Analyzer	5-5
5.3 Right-Hand Display Area	5-6
5.4 Accessing the Display Area.....	5-6
5.5 Opening Screen.....	5-8

5.6	TOP LEVEL SELECTION	5-8
5.6.1	CONFIG	5-9
5.6.2	MONITOR	5-49
5.6.3	TEST:	5-56
5.6.4	INFO (Information)	5-61
5.6.5	SAVE/LOAD	5-65
5.6.6	UTILITY	5-68
 CHAPTER 6. FORWARD ERROR CORRECTION OPTIONS		6-1
6.1	Introduction.....	6-1
6.2	Viterbi	6-2
6.3	Reed-Solomon Outer Codec.....	6-3
6.4	Trellis Coding.....	6-5
6.5	Turbo Product Codec (Hardware Option).....	6-6
6.5.1	Introduction	6-6
6.5.2	The Evolution of TPC in Comtech Products.....	6-6
6.5.3	End-to-End Processing Delay	6-7
6.5.4	Comparison of all TPC Modes.....	6-8
 CHAPTER 7. EDMAC CHANNEL.....		7-1
7.1	Theory Of Operation	7-1
7.2	M&C Connection	7-2
7.3	Setup Summary	7-3
 CHAPTER 8. AUTOMATIC UPLINK POWER CONTROL		8-1
8.1	Introduction.....	8-1
8.2	Setting AUPC Parameters.....	8-2
8.2.1	Target Eb/No	8-2
8.2.2	Max Range	8-2
8.2.3	Alarm.....	8-3
8.2.4	Demod Unlock	8-3
8.3	Compensation Rate.....	8-3
8.4	Monitoring.....	8-4

CHAPTER 9. DOUBLETALK™ CARRIER-IN-CARRIER® OPERATION	9-1
CHAPTER 10. REDUNDANCY	10-1
CHAPTER 11. ETHERNET MANAGEMENT	11-1
11.1 Introduction.....	11-1
11.2 Ethernet Management Interface Protocols	11-1
11.3 Web Server (HTTP) Interface	11-2
11.4 SNMP Interface.....	11-8
11.4.1 Management Information Base (MIB) Files.....	11-8
11.4.2 SNMP Community Strings	11-9
11.4.3 SNMP Traps.....	11-9
11.5 Telnet Interface.....	11-10
APPENDIX A. SUMMARY OF SPECIFICATIONS	A-1
APPENDIX B. FLASH UPGRADING	B-1
APPENDIX C. REMOTE CONTROL.....	C-1
APPENDIX D. CARRIER-IN-CARRIER® PERFORMANCE CHARACTERIZATION	D-1

About this Manual

This manual provides installation and operation information for the Comtech EF Data CDM-Qx Multi-Channel Modem with DoubleTalk™ Carrier-in-Carrier®. This is a technical document intended for earth station engineers, technicians, and operators responsible for the operation and maintenance of the CDM-Qx.

CONVENTIONS AND REFERENCES

METRIC CONVERSION

Metric conversion information is located on the inside back cover of this manual. This information is provided to assist the operator in cross-referencing English to Metric conversions.

CAUTIONS AND WARNINGS



CAUTION indicates a hazardous situation that, if not avoided, may result in minor or moderate injury. CAUTION may also be used to indicate other unsafe practices or risks of property damage.



WARNING indicates a potentially hazardous situation that, if not avoided, could result in death or serious injury.



Indicates information critical for proper equipment function.

REPORTING COMMENTS OR SUGGESTIONS CONCERNING THIS MANUAL

Comments and suggestions regarding the content and design of this manual will be appreciated. To submit comments, please contact the Comtech EF Data Technical Publications Department: techpub@comtechefdata.com

ELECTRICAL SAFETY

The CDM-Qx Multi-Channel Modem with DoubleTalk™ Carrier-in-Carrier® has been shown to comply with the following safety standard:

- EN 60950: Safety of Information Technology Equipment, including electrical business machines

The equipment is rated for operation over the range 100 to 240 VAC. It has a maximum power consumption of 60 watts, and draws a maximum of 600 mA.



The user should observe the following instructions:

FUSES

The CDM-Qx is fitted with two fuses - one each for line and neutral connections. These are contained within the body of the IEC power inlet connector, behind a small plastic flap.

- For 115 and 230 VAC operation, use T1.25A, 20mm fuses.

FOR CONTINUED OPERATOR SAFETY, ALWAYS REPLACE THE FUSES WITH THE CORRECT TYPE AND RATING.

ENVIRONMENTAL

The CDM-Qx must not be operated in an environment where the unit is exposed to extremes of temperature outside the ambient range 0 to 50°C (32° to 122°F), precipitation, condensation, or humid atmospheres above 95% RH, altitudes (un-pressurized) greater than 2000 meters, excessive dust or vibration, flammable gases, corrosive or explosive atmospheres.

Operation in vehicles or other transportable installations that are equipped to provide a stable environment is permitted. If such vehicles do not provide a stable environment, safety of the equipment to EN60950 may not be guaranteed.

INSTALLATION

The installation and connection to the line supply must be made in compliance to local or national wiring codes and regulations.





The CDM-Qx is designed for connection to a power system that has separate ground, line and neutral conductors. The equipment is not designed for connection to power system that has no direct connection to ground.

The CDM-Qx is shipped with a line inlet cable suitable for use in the country of operation. If it is necessary to replace this cable, ensure the replacement has an equivalent specification. Examples of acceptable ratings for the cable include HAR, BASEC and HOXXX-X. Examples of acceptable connector ratings include VDE, NF-USE, UL, CSA, OVE, CEPEC, NEMKO, DEMKO, BS1636A, BSI, SETI, IMQ, KEMA-KEUR and SEV.

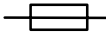

The modulator and demodulator cards shall not be plugged-in when the modem is powered on. Damage to the cards can be the result.

International Symbols:

Symbol	Definition		Symbol	Definition
	Alternating Current			Protective Earth
	Fuse			Chassis Ground

TELECOMMUNICATIONS TERMINAL EQUIPMENT DIRECTIVE

In accordance with the Telecommunications Terminal Equipment Directive 91/263/EEC, this equipment should not be directly connected to the Public Telecommunications Network.

CE MARK

Comtech EF Data declares that the CDM-Qx meets the necessary requirements for the CE Mark.

TRADEMARKS

Carrier-in Carrier is a registered trademark of Comtech EF Data Corporation.
DoubleTalk is a trademark of Applied Signal Technology, Inc.

WARRANTY POLICY

This Comtech EF Data product is warranted against defects in material and workmanship for a period of two years from the date of shipment. During the warranty period, Comtech EF Data will, at its option, repair or replace products that prove to be defective.

For equipment under warranty, the customer is responsible for freight to Comtech EF Data and all related custom, taxes, tariffs, insurance, etc. Comtech EF Data is responsible for the freight charges only for return of the equipment from the factory to the customer.

Comtech EF Data will return the equipment by the same method (i.e., Air, Express, Surface) as the equipment was sent to Comtech EF Data.

LIMITATIONS OF WARRANTY

The foregoing warranty shall not apply to defects resulting from improper installation or maintenance, abuse, unauthorized modification, or operation outside of environmental specifications for the product, or, for damages that occur due to improper repackaging of equipment for return to Comtech EF Data.

No other warranty is expressed or implied. Comtech EF Data specifically disclaims the implied warranties of merchantability and fitness for particular purpose.

EXCLUSIVE REMEDIES

The remedies provided herein are the buyer's sole and exclusive remedies. Comtech EF Data shall not be liable for any direct, indirect, special, incidental, or consequential damages, whether based on contract, tort, or any other legal theory.

DISCLAIMER

Comtech EF Data has reviewed this manual thoroughly in order that it will be an easy-to-use guide to your equipment. All statements, technical information, and recommendations in this manual and in any guides or related documents are believed reliable, but the accuracy and completeness thereof are not guaranteed or warranted, and they are not intended to be, nor should they be understood to be, representations or warranties concerning the products described. Further, Comtech EF Data reserves the right to make changes in the specifications of the products described in this manual at any time without notice and without obligation to notify any person of such changes.

If you have any questions regarding the equipment or the information in this manual, contact the Comtech EF Data Customer Support Department.

Chapter 1. INTRODUCTION

1.1 Introduction

The CDM-Qx, Multi-Channel Satellite Modem with DoubleTalk™ Carrier-in-Carrier® is a 70/140 MHz (or CDM-QxL with 950MHz-1950MHz L Band operation) modular multi-channel modem with redundancy contained in a single rack unit (1RU) chassis. The Modem offers flexibility, redundancy, integration, and performance with four slots configurable as modulators or demodulators.

The CDM-Qx/QxL supports DoubleTalk Carrier-in-Carrier® option, allowing transmit (Tx) and receive (Rx) carriers in a full-duplex link to use the same transponder segment.



Figure 1-1. CDM-Qx/QxL

1.2 Features

The Modem includes such features as the following:

- DoubleTalk™ Carrier-in-Carrier® allowing Tx and Rx carriers of a full-duplex link to use the same transponder segment
- CDM-Qx: 50 to 90 and 100 to 180 MHz frequency range
- CDM-QxL: 950 MHz-1950 MHz L-band
- 32 kbps to 20 Mbps
- BPSK, QPSK, 8-PSK, 16-QAM operation
- Flexible Configuration:
 - 1 modem or 2 modems configured as 1:1
 - Up to 4 demodulators
- Optional Built In Redundancy:
 - 1:1 modem
 - Up to 1:3 modulator
 - Up to 1:3 demodulator
- EIA-422/-530, V.35, G.703 (E1/T1) and HSSI Interfaces
- 1 to 4 Ports of G.703 (E1 with D&I) Quad E1 Interface Card
- 10/100 BaseT Ethernet, RS-232 or RS-485 for M&C remote control
- Forward Error Correction (FEC) choices included:
 - Viterbi
 - Viterbi with Reed-Solomon
 - Trellis and Reed-Solomon
 - Optional, 2nd Generation Turbo Product Coding (TPC) (IESS-315 compliant)
- Fully Accessible System Topology (FAST)
- Asymmetric Loop Timing
- Common frequency reference for all modules
- Optional High Stability Reference
- Optional Redundant Power Supply
- Individual or summed Modulator output power control
- Interoperable with: CDM-550T, -570L, -600, -600L, SDM-300A, -300L3, and -8000 modems (in compatible modes)
- Drop and Insert, closed network version
- FSK, for communicating to Comtech EF Data transceivers
- EDMAC, Automatic Uplink Power Control

1.2.1 DoubleTalk™ Carrier-in-Carrier®

Designed for bandwidth compression, Carrier-in-Carrier is based on Applied Signal Technology's DoubleTalk which uses "Adaptive Cancellation," a patented (United States Patent # 6,859,641) technology that allows full duplex satellite links to transmit concurrently in the same segment of transponder bandwidth. Available as an option to the modem, this added dimension can result in a significant improvement in satellite transponder utilization.

1.2.2 Software – Flash Upgrading

The internal software is both powerful and flexible, permitting storage and retrieval of up to 10 different modem configurations. The modem uses 'flash memory' technology internally, and new firmware can be uploaded to the unit from an external PC. This simplifies software upgrading, and updates can now be sent via the Internet, e-mail, or on disk. The upgrade can be performed without opening the unit by simply connecting the modem to the USB port or Ethernet port of a computer.

1.2.3 Verification

The Modem includes many test modes and loopbacks for rapid verification of the correct functioning of the unit. Of particular interest is the IF loopback, which permits the user to perform a quick diagnostic test without having to disturb external cabling. During loopback, all of the receive configuration parameters on the selected Demodulator are temporarily changed to match those of the selected Modulator, and an internal RF switch connects the modulator output to the demodulator input. When normal operation is again selected, all of the previous values are restored.

1.2.4 Data Interfaces

The Modem can be ordered with a number of interfaces. Each data interface can operate on a Modulator or Demodulator. This allows the user to exchange interface cards for different applications. The interfaces offered include:

- EIA/TIA-530
 - (EIA-422) DCE (at rates up to 12 Mbps)
 - V.35 DCE (at rates up to 12 Mbps)
- G.703 Balanced T1 & E1 (DB-15) with D&I
- G.703 Unbalanced T1 & E1 (BNC)
- EIA/TIA-612/613 HSSI (50-pin SCSI connector, to 20 Mbps)
- 1 to 4 Ports of G.703 (E1 with D&I) Quad E1 Interface Card, (DB-9F)

1.2.5 Turbo Product Coding

The Modem offers optional 2nd generation Turbo Product Codec (TPC). TPC simultaneously offers increased coding gain, lower decoding delay, and significant bandwidth savings. The TPC provides:

- BPSK 5/16 and 21/44
- QPSK 21/44, 3/4, 7/8 and 17/18
- 8-PSK 3/4, 7/8, and 17/18
- 16-QAM 3/4 and 7/8

1.2.6 Remote Control

The operator may configure and monitor the modem from the front panel, or through the remote M&C port. M&C is via RS-232, RS-485 (2/4 wire) or 10/100 BaseT Ethernet.

1.3 Major Assemblies

Assembly	Description
PL/10570-1	1 PPM Reference IF Backplane 70/140 MHz IF
PL/10570-2	0.1 PPM Reference IF Backplane 70/140 MHz IF
PL/10070-1	0.1 PPM Reference IF Backplane L-Band IF
PL/10069	Digital Backplane
PL/10073	Monitor and Control Card
PL/11128	70/140 MHz IF Modulator
PL/10635	70/140 MHz IF Demodulator with Carrier in Carrier
PL/10071	L-Band IF Modulator
PL/10072	L-Band IF Demodulator with Carrier in Carrier®
AS/11014	Turbo Codec – Simplex
PL/10678	EIA-530 Duplex Data interface
PL/10697	G.703 Balanced Duplex Data Interface
PL/10698	G.703 Unbalanced Duplex Data Interface
PL/12608-1	Quad E1 G.703 Data Interface Module
PL/10898-1	EIA-612/613 HSSI Interface
PL/10416-1	AC Chassis, 70/140 IF
PL/10416-2	DC Chassis, 70/140 IF
PL/12798-1	AC Chassis, L-Band
PL/12798-2	DC Chassis, L-Band

1.4 FAST Options and Hardware Options

The Modem is extremely flexible and powerful, and incorporates a large number of optional features. Some customers may not require all of these features, and therefore, in order to permit a lower initial cost, the Modem may be purchased with only the desired modules and features enabled. If, at a later date, a customer wishes to upgrade the functionality of a modulator or demodulator, Comtech EF Data provides a system known as FAST (Fully Accessible System Topology) which permits the purchase and installation of options through the use of special authorization codes, entered through the front panel, or remotely.

The base configuration of the modulators and demodulators are equipped with Viterbi and R-S codecs. It offers modulation types, and data rates up to 5 Mbps. It is, however, limited to Closed Network operation.

The following table shows what other options are available:

Modulator & Demodulator Options	Description and Comments	Option Installation Method
Low Rate Variable	Data rate 32 kbps to 5 Mbps	Base Unit
Mid-Rate Variable	Data rate 32 kbps to 10.0 Mbps	FAST
Full Rate Variable	Data rate 32 kbps to 20.0 Mbps	FAST
8-PSK	Modulation Type	FAST
16-QAM	Modulation Type	FAST
DoubleTalk Carrier-in-Carrier	128 ksps – 512 kbps	FAST
DoubleTalk Carrier-in-Carrier	128 ksps – 1 Mbps	FAST
DoubleTalk Carrier-in-Carrier	128 ksps – 2.5 Mbps	FAST
DoubleTalk Carrier-in-Carrier	128 ksps – 5 Mbps	FAST
DoubleTalk Carrier-in-Carrier	128 ksps – 1.0 Mbps	FAST
DoubleTalk Carrier-in-Carrier	128 ksps – 20 Mbps	FAST
Redundancy Capability	1:1 or 1:2 or 1:3 Redundancy	FAST
Turbo Codec – high rate	20 Mbps Turbo Codec	Hardware
High Stability Reference	Internal 10 MHz reference – 0.1×10^{-6}	Hardware*
Low Stability Reference	Internal 10 MHz reference – 1×10^{-6}	Hardware*
75Ω TX/RX Impedance	75Ω impedance with BNC female connectors	Hardware*
50Ω TX/RX Impedance	50Ω impedance with N female connectors (L-Band)	Hardware*

*Factory installed only.

1.4.1 FAST Accessible Options

Comtech EF Data's FAST system allows immediate implementation of different options through the user interface keypad. All FAST options are available through the basic platform unit.

1.4.2 FAST System Theory

FAST is an enhancement feature available in Comtech EF Data products, enabling on-location upgrade of the operating feature set - in the rack - without removing a modem from the setup. When service requirements change, the operator can upgrade the topology of the modem to meet those requirements within minutes after confirmation by Comtech EF Data. This accelerated upgrade can be accomplished only because of FAST's extensive use of programmable devices incorporating Comtech EF Data-proprietary signal processing techniques. These techniques allow the use of a unique access code to enable configuration of the available hardware. The access code can be purchased at any time from Comtech EF Data. Once obtained, the access code is loaded into the unit through the front panel keyboard or the rear remote port.

With the exclusive FAST technology, operators have maximum flexibility for enabling functions as they are required. FAST allows an operator to order a modem precisely tailored for the initial application.

1.4.3 Implementation

FAST is factory-implemented in the modem at the time of order. Hardware options for basic modems can be ordered and installed either at the factory or in the field. The operator can select options that can be activated easily in the field, depending on the current hardware configuration of the product. The Activation Procedure is described in Appendix C.

1.4.4 Hardware Options

There are four hardware options available.

There is the Comtech EF Data Turbo Product Codec (TPC), representing a very significant development in the area of FEC. It consists of a plug-in daughter card (SIMM module) that is field upgradeable. The TPC option provides data rate capability up to 20 Mbps, and code rates of:

- Rate 5/16 (BPSK)
- Rate 21/44 (BPSK, QPSK)
- Rate 3/4 (QPSK, 8-PSK, and 16-QAM)
- Rate 7/8 (QPSK, 8-PSK, and 16-QAM)
- Rate 17/18 (QPSK, 8-PSK)

Turbo Product Coding provides one of the best Forward Error Correction technologies currently available, and is now offered with a sufficient range of code rates and modulation types to optimize link performance under any conditions.

The second hardware option is the Internal Reference Stability. The high stability option includes a 1×10^{-7} 10 MHz reference oscillator on the IF Backplane board, while the low stability option has a 1×10^{-6} 10 MHz reference on the IF Backplane board. This option must be configured in the factory at the time of order.

The third hardware option is the IF Impedance and Connectors. The IF may be configured with either BNC female connectors at 75Ω impedance, BNC female connectors at 50Ω impedance, or TNC female connectors at 50Ω impedance. This option also must be configured in the factory at the time of order.

The fourth hardware option is the Quad E1 Data Interface Module. This gives the user 1 to 4 ports of E1, (each are D&I capable). These ports must use a synchronous E1 reference. This option also must be configured in the factory at the time of order.

1.4.5 Supporting Hardware and Software

The Modem incorporates an FSK serial link that can be activated on the RX-IF port for purpose of communicating with an FSK capable Transceiver. In this manner, a user may monitor, configure, and control the transceiver using the front panel display and keypad of the modem or the modem's remote control interface. The EDMAC channel can be used to convey M&C interface to a transceiver at the distant end of a satellite link if it is connected to a modem.

1.5 L-Band

Fully configured, the modem will meet or exceed all of the applicable requirements in IESS-315 and is available with a full range of industry standard digital interfaces. The modem expands the capabilities into L-Band frequencies. Utilizing advanced technology and proprietary digital signal processing techniques, the design eliminates analog circuitry to perform modem signal processing, resulting in higher reliability and reduced packaging size.

1.6 Compatibility

The Modem is backwards compatible with a number of Comtech EF Data CDM modems, SDM modems, and SLM modems.

Chapter 2. INSTALLATION

2.1 Unpacking

Inspect shipping containers for damage. If shipping containers are damaged, keep them until the contents of the shipment have been carefully inspected and checked for normal operation.

The modem and manual are packaged in pre-formed, reusable, cardboard cartons containing foam spacing for maximum shipping protection.



Do not use any cutting tool that will extend more than 1 inch into the container. This can cause damage to the modem.

Unpack the modem as follows:

1. Cut the tape at the top of the carton indicated by OPEN THIS END.
2. Remove the cardboard/foam space covering the modem.
3. Remove the modem, manual, and power cord from the carton.
4. Save the packing material for storage or reshipment purposes.
5. Inspect the equipment for any possible damage incurred during shipment.
6. Check the equipment against the packing list to ensure the shipment is correct.
7. Refer to the following sections for further installation instructions.

2.2 Mounting

If the modem is to be mounted in a rack, ensure that there is adequate clearance for ventilation, particularly at the sides. In rack systems where there is high heat dissipation, forced air-cooling must be provided by top or bottom mounted fans or blowers. Under no circumstance should the highest internal rack temperature be allowed to exceed 50°C (122°F).

2.2.1 Optional Rear-Mounting Installation Bracket

Install optional installation brackets (Figure 2-1) using mounting kit KT/6228-2:

Mounting Kit KT/6228-2 (Optional)		
Quantity	Part Number	Description
2	HW/10-32SHLDR	Screw, #10 Shoulder
4	HW/10-32FLT	Washer, #10 Flat
2	HW/10-32SPLIT	Washer, #10 Split
2	HW/10-32HEXNUT	Nut, #10 Hex
2	FP/6138-1	Bracket, Rear Support
4	HW/10-32x1/2RK	Bolt, #10 Rack Bracket

The tools required for this installation are a **medium Phillips™ screwdriver** and a **5/32-inch SAE Allen™ Wrench**.

The CDM-QD is assembled into the equipment rack as shown in Figure 2-1:

Step	Procedure
1	Secure the #10 shoulder screws to the unit chassis through the rear right and left side mounting slots, using the #10 flat washers, #10 split washers, and #10 hex nuts as shown.
2	Install the rear support brackets onto the equipment rack threaded rear mounting rails, using the #10 bracket bolts.
3	Mount the unit into the equipment rack, ensuring that the shoulders of the #10 shoulder screws properly engage into the rear support bracket slots.

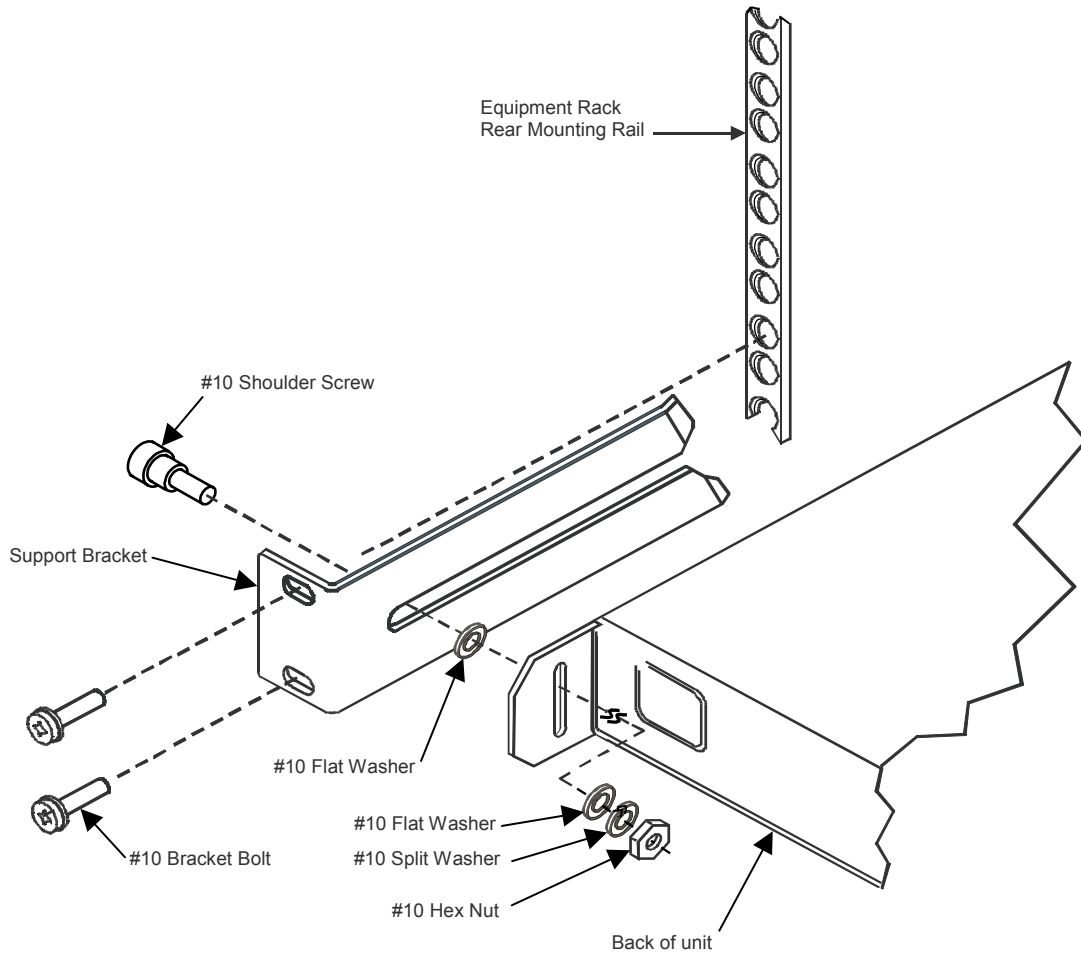

Figure 2-1. Installation of the Optional Mounting Brackets

2.3 Configuration

There are no internal jumpers to configure. All configuration is carried out entirely in software. The unit should first be configured locally, using the front panel keypad and display. The unit will ship with a default Viterbi 128 kbps, QPSK, Rate 3/4 configuration. Refer to the ‘**FRONT PANEL OPERATION**’ chapter for details on how to fully configure the unit for the desired operating parameters.

Note: The auto-sensing AC power supply does not require any adjustments. Simply plug in the supplied line cord, and turn on the switch on the rear panel.

2.4 Select Internal IF Loop

Correct operation of the unit may be verified rapidly, without the need for externally connected equipment, providing there are at least one modulator and one demodulator. From the top-level menu, select **CONFIG**, then **GROUP**, then **MODEM**. This will require a modulator to be above a demodulator in the chassis. Then go back to the top-level menu; select **TEST**, then **IF LOOP** (refer to the ‘**FRONT PANEL OPERATION**’ chapter). The demod should synchronize, and the green **RECEIVE TRAFFIC LED** should illuminate. If the unit does not pass this test, call the factory for assistance.

2.5 Connect External Cables

Having verified correct operation in IF loop, enter the desired configuration, and proceed to connect all external cables. If difficulties occur, please call the factory for assistance.

Observe the following:

- If modulators and demodulators are to be used without grouping them as a modem, a data interface cable is required to plug into each unit. If a modulator and demodulator are grouped as a modem, the modulator must be located above the demodulator and a single data interface cable is used simply by connecting it to the demodulator.
- If a modulator, demodulator, or grouped (modem) is defined as a back up unit, a data interface cable is not required to the unit or units.

Note: Each modulator has an output power level in the range -5 to -25 dBm (-5 to -45 dBm for L-Band). Even though there is a single IF output connector and a single IF input connector, all four slots are hooked up by way of internal power splitters and summers. If two modulators are turned on, the total power out will be 3 dB higher (assuming both modulators are set to the same power level). If four modulators are turned on, the total power out will be 6 dB higher (assuming all modulators are set to the same power level).

Chapter 3. FUNCTIONAL DESCRIPTION

The modem has two fundamentally different types of interface: IF and Data.

- The Data interface can be a bi-directional path, which connects with the customer's equipment (assumed to be the DTE) and the modem (assumed to be the DCE).
- The IF interface provides a bi-directional link with the satellite via the uplink and downlink equipment.

Transmit data is received by the terrestrial interface where line receivers convert the clock and data signals to CMOS levels for further processing. A small FIFO follows the terrestrial interface to facilitate the various clocking and framing options. If framing is enabled, the transmit clock and data output from the FIFO pass through the framer, where the overhead EDMAC data is added to the main data. Otherwise, the clock and data are passed directly to the Forward Error Correction encoder. In the FEC encoder, the data is scrambled, differentially encoded, and then convolutionally encoded. Following the encoder, the data is fed to the transmit digital filters, which perform spectral shaping on the data signals. The resultant I and Q signals are then fed to the BPSK/QPSK/8-PSK/16-QAM modulator. The carrier is generated by a frequency synthesizer, and the I and Q signals directly modulate this carrier to produce an IF output signal.

The RX IF signal is translated and filtered at an intermediate frequency (IF) using the coarse step synthesizer. This is mixed with a second synthesizer, resulting in the signal being IF sampled with a high-speed analog to digital converter (A to D). The sampled IF is then digitally split into an in-phase (I) and a quadrature (Q) component. An AGC circuit keeps the desired signal level constant over a broad range of input levels. The I and Q signals are then decimated to reduce the computation rate into the poly phase matched filter. Carrier and clock recovery is performed on the baseband I and Q signals after the matched filter. The resultant demodulated signal is fed, in soft decision form, to the selected FEC decoder (which can be Viterbi, TCM, Reed-Solomon, or Turbo if installed). After decoding, the recovered clock and data pass to the de-framer (if EDMAC framing is enabled) where the overhead information is removed. Following this, the data passes to the Plesiochronous/Doppler buffer, which has a programmable size, or alternatively bypasses the buffer. From here, the receive clock and data signals are routed to the terrestrial interface, and are passed to the externally connected DTE equipment.

Physically a modem chassis is comprised of three main card assemblies:

1. The first of these is the IF Backplane card, which includes the frequency reference; power splitters, power summers, the FSK link and the IF Loop back functions.
2. The second card is the Digital Back plane card. This routes all the control signals, the data path switching, the carrier-in-carrier signals and power for all modules.
3. The third is the M&C, which controls all functions in the unit.

Within the chassis are four slots, which allow any combination of modulators or demodulators to be installed. If configured as a single modem, two plug-in cards comprising a modulator and demodulator are required.

A Modulator card contains the transmit interface circuits, the framer, the encoder or encoders and the signal processing functions of modulation.

A Demodulator card performs all of the signal processing functions of carrier search, cancellation, demodulation, Forward Error Correction, the de-framer, plesiochronous/Doppler buffer and the receive interface circuits.

Terrestrial data interface cards can be on the modulator cards or demodulator cards. When a modulator and demodulator are grouped together, the data interface card can be used for full-duplex data interface. When 1 up to 4 ports of E1 (with D&I) are needed the Quad E1 Data Interface Module can be installed in slots 3 and 4.

Figure 3-1 shows a functional block diagram of the modem with either modulators and demodulators in all 4 slots and the figure also shows a modulator in slot 1 and a demodulator in slot 2 along with a Quad E1 Data Interface Module in slot 3 and 4.

Functional Block Diagram

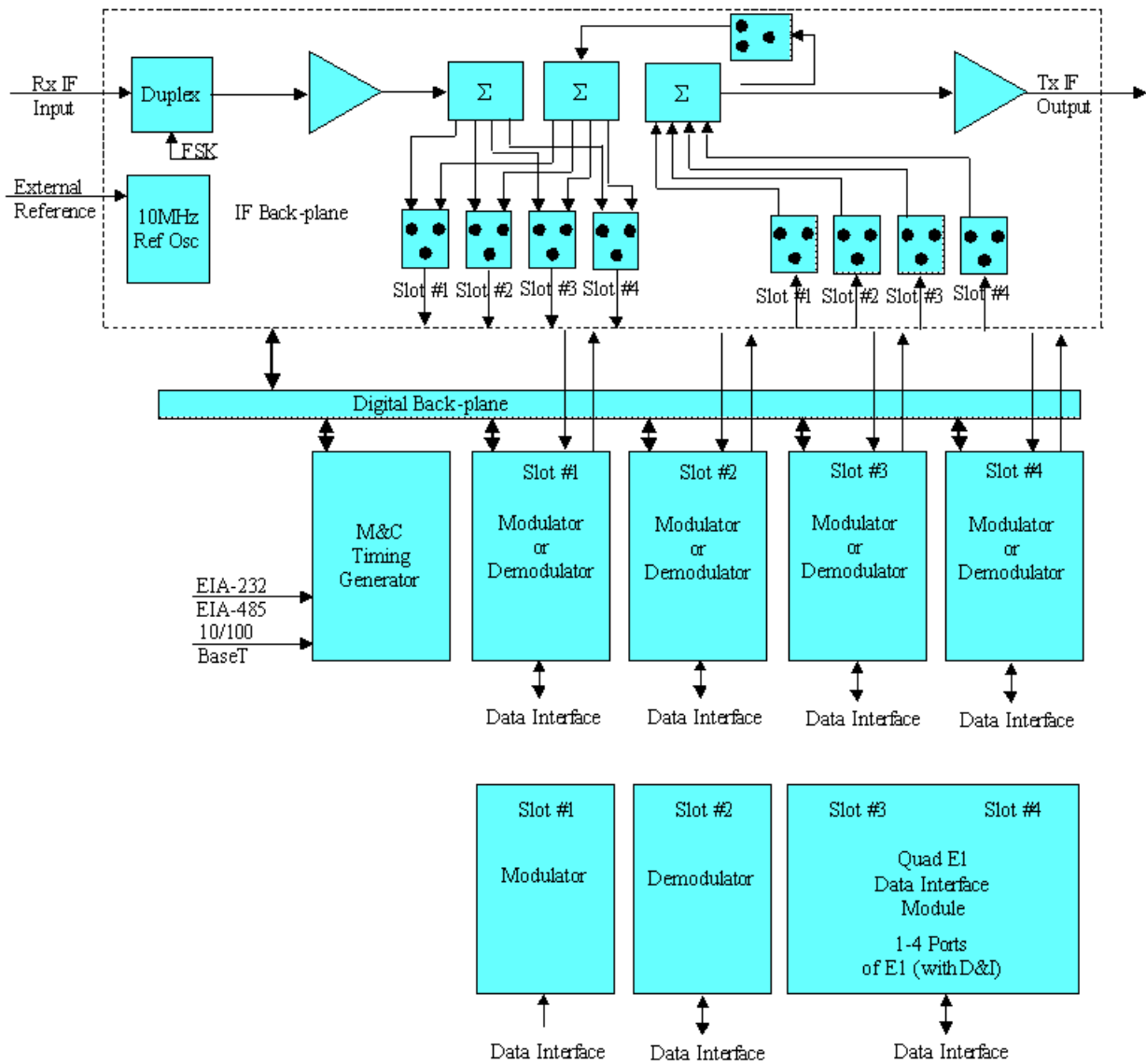

Figure 3-1. Modem Block Diagram

Chapter 4. EXTERNAL CONNECTIONS

4.1 Introduction

The modem is constructed as a 1RU high rack-mounting chassis, which can be freestanding, if desired. Rack handles at the front facilitate removal from and placement into a rack. Figure 4-1 shows the front panel of the modem.



Figure 4-1. Front Panel

4.2 Front Panel

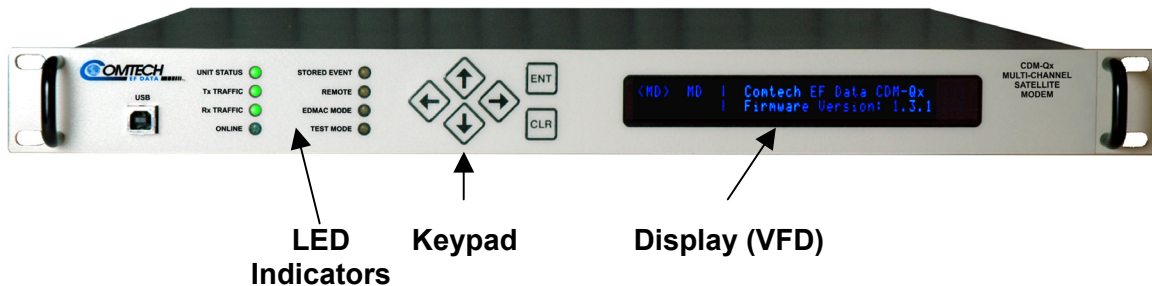

The Modem front panel features a **Vacuum Fluorescent Display (VFD)**, a keypad, and eight LED indicators. The user enters data via the keypad, and messages are displayed on the VFD. The LEDs indicate, in a summary fashion, the status of the selected module.

The VFD is an active display showing 2 lines, each of 40 characters. It produces a blue light, the brightness of which can be controlled by the user. It has greatly superior viewing characteristics compared to a **Liquid Crystal Display (LCD)**, and does not suffer problems with viewing angle, contrast or temperature.

The keypad has six individual keyswitches, mounted directly behind a fully sealed membrane overlay. They have a positive ‘click’ action, which provides the user with tactile feedback. These six switches are identified as [↑], [↓], [→], [←] arrows, **ENT** and **CLR**. The functions of these keys are described in the ‘**FRONT PANEL OPERATION**’ section.

There are eight LEDs on the front panel. The behavior of these LEDs is described in the ‘**FRONT PANEL OPERATION**’ section.



A USB Slave connector is provided on the front panel. This feature allows the user to reflash firmware.

4.3 Rear Panel

The rear panel can be customized to meet the customer's requirements. Figure 4-2 shows three configurations that are available. Table 4-1 lists these connectors and Figure 4-2 shows the locations.

Figure 4-2. Rear Panel

○ Prime Power & Control	⊗ Slot 1	⊗ Slot 3	○ IF I/O
	⊗ Slot 2	⊗ Slot 4	○



**Configuration #1 Modem 1 with G.703 T1/E1 Balanced (DB-15)
Modem 2 with EIA-422 (DB-25)**



**Configuration #2 Modem 1 with G.703 T1/E1 Unbalanced (BNC)
Modem 2 with EIA-422 (DB-25)**



**Configuration #3 Modem 1 with G.703 T1/E1 Balanced (DB-15) and
Quad E1 Interface Module, 1-4 Ports of E1, with D&I (2) DB-9F)**

Notes:

1. One interface per Modem (i.e. Modulator and Demodulator card combination) or one interface per Modulator card and Demodulator card are required if used independently.
2. When grouping a modulator and demodulator together to use as a modem, the modulator must be located above the demodulator.
3. For redundant operation the backup unit does not need an interface.
4. For redundant operation the backup unit needs to be located in the lower right hand slot (#4) for single module redundancy. For modem redundancy the backup units must be located in the right hand slots (#3 & #4).
5. In the example Configuration #1 above, because all modules have interfaces, the following configurations are possible.
 - a. Two independent modulators - one with a G.703 balanced and the other with an EIA-530 interface, with two independent demodulators one with a G.703 balanced and the other with an EIA-530 interface.
 - b. Two independent modems - one with a G.703 balanced and the other with an EIA-530 interface (located on the demodulators).
 - c. A 1:1 redundant modem, with the online unit configured with a G.703 interface. The off line modules will provide the backup even with a different interface.
6. In the example Configuration #3 above, the Quad E1 Interface Module is used in slot 3 and 4. The modulator in slot 1 is grouped with the demodulator in slot 2. This unique combinations allows the user to select the Quad E1 interface or the data interface located in the modulator or demodulator.

Table 4-1. Modem Rear Panel Connectors

Name	Ref. Desig.	Connector Type	Function
Configuration #1 - Modem1 with G.703 T1/E1 Balanced (DB-15) Modem2 with EIA-422 (DB-25)			
M&C 10/100BaseT		RJ-45	Remote Interface
485/232		9-Pin D Male	Remote Interface
Slot #1 Mod:			
Alarms		15-Pin Male	Form-C Alarms
G.703		15-Pin Female	Balanced G.703 Data Input
Slot #2 Demod:			
Alarms		15-Pin Male	Form-C Alarms
G.703		15-Pin Female	Balanced G.703 Data Output, or Input/Output
Slot #3 Mod:			
Alarms		15-Pin Male	Form-C Alarms
EIA-530		25-Pin Female	Data Input
Slot #4 Demod:			
Alarms		15-Pin Male	Form-C Alarms
EIA-530		25-Pin Female	Data Output, or Input/Output
70/140 Tx /Rx:			
Tx		BNC	RF Output 75 or 50Ω
Rx		BNC	RF Input 75 or 50Ω
Ref		BNC	External Reference for Modem Synthesizers
AC Plug		IEC	Modem Power
Ground		#10-32 Stud	Grounding
Configuration #2 - Modem 1 with G.703 EIA-422(DB-25) Modem2 with G.703 T1/E1 Unbalanced (BNC)			
M&C 10/100BaseT		RJ-45	Remote Interface
485/232		9-Pin D Male	Remote Interface
Slot #1 Mod:			
Alarms		15-Pin Male	Form-C Alarms
G.703		BNC	Unbalanced G.703 Data Output (incorrect slot for IO)
Slot #2 Demod:			
Alarms		15-Pin Male	Form-C Alarms
G.703		BNC	Unbalanced G.703 Data input
Slot #3 Mod:			
Alarms		15-Pin Male	Form-C Alarms
EIA-530		25-Pin Female	Data Input
Slot #4 Demod:			
Alarms		15-Pin Male	Form-C Alarms
EIA-530		25-Pin Female	Data Output, or Input/Output
70/140 Tx /Rx:			
Tx		BNC	RF Output 75 or 50Ω
Rx		BNC	RF Input 75 or 50Ω
Ref		BNC	External Reference for Modem Synthesizers
AC Plug		IEC	Modem Power
Ground		#10-32 Stud	Grounding

Name	Ref. Desig.	Connector Type	Function
Configuration #3 - Modem 1 with G.703 T1/E1 Balanced (DB-15) and Quad E1 Interface (1-4 Ports E1, w/ D&I)			
M&C 10/100BaseT		RJ-45	Remote Interface
485/232		9-Pin D Male	Remote Interface
Slot #1 Mod:			
Alarms		15-Pin Male	Form-C Alarms
G.703		BNC	Unbalanced G.703 Data Output (incorrect slot for IO)
Slot #2 Demod:			
Alarms		15-Pin Male	Form-C Alarms
G.703		BNC	Unbalanced G.703 Data input
Slot #3 and #4 Quad E1:			
Ports 1-2 of E1		DB-9 Female	Balance E1 (with D&I)
Ports 3-4 of E1		DB-9 Female	Balance E1 (with D&I)
Ext Ref E1 Clock		DB-9 Female	Balance E1 clock input and output
70/140 Tx /Rx:			
Tx		BNC	RF Output 75 or 50Ω
Rx		BNC	RF Input 75 or 50Ω
Ref		BNC	External Reference for Modem Synthesizers
AC Plug		IEC	Modem Power
Ground		#10-32 Stud	Grounding

Note: The European EMC Directive (EN55022, EN50082-1) requires using properly shielded cables for DATA I/O.

4.4 Chassis Connections

4.4.1 USB Port

This port is used to reflash firmware.



For continued operator safety, always replace the fuses with the correct type and rating.

4.4.2 M&C 10/100BaseT Connector

The M&C 10/100BaseT connector is an 8-pin RJ-45 10/100BaseT Ethernet port providing access to the modem's management functions.

4.4.3 485/232 Connector

The 485/232 connectors are a 9-pin 'D' type male (DB9-M). Access is provided to remote control ports of the modem, using both RS-232 and RS-485.

Table 4-2. Remote Control Interface Connector Pin Assignments

Pin #	Description	Direction
1	Ground	
2	RS-232 TX Data	Out
3	RS-232 RX Data	In
4	Reserved - do not connect to this pin	
5	Ground	
6	RS-485 RX Data B *	In
7	RS-485 RX Data A *	In
8	RS-485 TX Data B	Out
9	RS-485 TX Data A	Out

***Use for 2-wire RS-485 operation**

4.4.4 Alarms Connector

All modules contain an alarm connector. The Alarms connector is a 15-pin 'D' type male (DB15 M). This provides the user with access to the Form-C relay contacts, which indicate the fault status of the unit. These are typically connected to an external fault monitoring system, often found in satellite earth stations.

For a Modulator, TX fault and Unit Fault are supported. The transmit I and Q modulator samples are available on this connector. Connecting these signals to an oscilloscope in X,Y mode will provide the modulator signal constellation diagram, which is a useful diagnostic aid. A pin also is provided which can mute the transmit carrier. This requires that the pin be shorted to ground, or a TTL 'low'.

For a Demodulator, RX fault and Unit Fault are supported. If a Modulator and Demodulator are vertically grouped together as a modem, TX fault and the External carrier off pin will also be supported. The receive I and Q demodulator samples are provided on this connector. Connecting these signals to an oscilloscope in X,Y mode will provide the receive signal constellation diagram, which is a useful diagnostic aid. As an aid to antenna pointing, or for driving step-track equipment, an analog AGC signal is provided on Pin 2 of this connector.

Table 4-3. Alarm Interface Connector Pin Assignments

Pin #	Signal Function	Name
8	RX Traffic (De-energized, Faulted)	RX-NC
15	RX Traffic (Energized, No Fault)	RX-NO
7	RX Traffic	RX-COM
14	TX Traffic (De-energized, Faulted)	TX-NC
6	TX Traffic (Energized, No Fault)	TX-NO
13	TX Traffic	TX-COM
5	Unit Fault (De-energized, Faulted)	UNIT-NC
12	Unit Fault (Energized, No Fault)	UNIT-NO
4	Unit Fault	UNIT-COM
11	I Channel (Constellation monitor)	TX or RX-I
3	Q Channel (Constellation monitor)	TX or RX-Q
10	No Connection	N/C
2	AGC Voltage (Rx signal level, 0 to 2.5 volts, demodulator only)	AGC
9	EXT Carrier OFF (modulator or modulator and demodulator grouped together)	EXT-OFF
1	Ground	GND

4.4.5 Balanced G.703 Connector Tx/Rx Connector

The Balanced G.703 connection is a 15-pin female connector located on the rear mounting plate of the modulator or demodulator. If a Modulator and Demodulator are vertically grouped together as a modem, the data interface connector on the Demodulator switches to duplex. This feature allows a single data interface connection to be used for a modem instead of needing a “Y” cable. Otherwise, each module is a simplex data interface. Refer to Table 4-4 for pin assignments.

Table 4-4. Balanced G.703 Interface Connector Pin Assignments

Pin #	Signal Function	Name	Direction
1	Drop Data Input (-)	DDI-	In
9	Drop Data Input (+)	DDI+	In
2	Ground	GND	
10	Not Used		
3	Insert Data Output (-)	IDO-	Out
11	Insert Data Output (+)	IDO+	Out
4	Ground	GND	
12	Drop Data Output (-)	DDO-	Out (D&I Only)
5	Drop Data Output (+)	DDO+	Out (D&I Only)
13	Insert Data Input (-)	IDI-	In (D&I Only)
6	Insert Data Input (+)	IDI+	In (D&I Only)
14	Not Used		
7	Not Used		
15	Not Used		
8	Not Used		

4.4.6 Unbalanced G.703 Tx/Rx Connectors

Two female BNC 75Ω connectors are available for unbalanced operation at the G.703 data rates of T1 (1.544 Mbps) and E1 (2.048 Mbps). If a Modulator and Demodulator are vertically grouped together as a modem, the Tx data input interface connector on the Demodulator becomes active, allowing duplex operation. Otherwise, the Tx data input connector is used on the modulator and the Rx data output connector is used on the demodulator.

4.4.7 RS-530 Data Interface Connector

The Data connector is a 25-pin ‘D’ type female (DB-25F). This connector conforms to the RS-530 pinout, which allows for connection of different electrical standards, including EIA-422, V.35, and EIA-232.



All data interfaces are duplex! They will only operate as duplex if a Modulator and Demodulator are vertically grouped together as a modem. In that case the data interface connector on the Demodulator switches to duplex. This feature allows a single data interface connection to be used for a modem instead of needing a “Y” cable. Otherwise, the data interface for each module will only operate as simplex. It is the responsibility of the user to provide the appropriate cables to connect to this RS-530 connector.

Table 4-5. RS-530 Data Interface Connector Pin Assignments

Pin #	Generic Signal Description	Direction	RS-422 RS- 530 LVDS	V.35	RS-232	Circuit #
2	TX Data A	DTE to Modem	SD A	SD A	BA	103
14	TX Data B	DTE to Modem	SD B	SD B	-	103
24	TX Clock A	DTE to Modem	TT A	SCTE A	DA	113
11	TX Clock B	DTE to Modem	TT B	SCTE B	-	113
15	INT TX Clock A	Modem to DTE	ST A	SCT A	DB	114
12	INT TX Clock B	Modem to DTE	ST B	SCT B	-	114
3	RX Data A	Modem to DTE	RD A	RD A	BB	104
16	RX Data B	Modem to DTE	RD B	RD B	-	104
17	RX Clock A	Modem to DTE	RT A	SCR A	DD	115
9	RX Clock B	Modem to DTE	RT B	SCR B	-	115
8	Receiver Ready A	Modem to DTE	RR A	RLSD *	CF	109
10	Receiver Ready B	Modem to DTE	RR B	-	-	109
23	External Carrier Off (RS-232 ‘1’ or TTL ‘low’)	DTE to Modem	-	-	-	-
7	Signal Ground	-	SG	SG	AB	102
1	Shield	-	Shield	FG	AN	101

Notes:

1. Receiver Ready is an RS-232 -level control signal on a V.35 interface
2. DO NOT connect signals to pins which are not shown - these pins are reserved for use by the redundancy system
3. ‘B’ signal lines are not used for RS-232 applications
4. For X.21 operation, use the EIA-422 pins, but ignore RX Clock if the Modem is DTE, and ignore TX clocks if the Modem is DCE.

4.4.8 Quad E1 Data Interface Connectors

The (2) Data connectors on the Quad E1 interface card are 9-pin 'D' type female (DB-9F). Refer to Table 4-xx for pin assignments. J1 and J2 are shown below. Also available is an adapter y-cable to adapt the DB9 to (2) RJ45 jacks, (part number PL/xxxTBD), see Table xx and figure xx.

Table 4-xx6. Quad E1 Data Interface J1 Connector Pin Assignments

Pin #	Signal Function	Name	Direction
5	DDI (+)	Port1_Tx+	In
9	DDI (-)	Port1_Tx-	In
4	IDO (+)	Port1_Rx+	Out
8	IDO (-)	Port1_Rx-	Out
3	Ground	Gnd	-
7	DDI (+)	Port2_Tx+	In
2	DDI (-)	Port2_Tx-	In
6	IDO (+)	Port2_Rx+	Out
1	IDO (-)	Port2_Rx-	Out

Table 4-xx7. Quad E1 Data Interface J2 Connector Pin Assignments

Pin #	Signal Function	Name	Direction
5	DDI (+)	Port3_Tx+	In
9	DDI (-)	Port3_Tx-	In
4	IDO (+)	Port3_Rx+	Out
8	IDO (-)	Port3_Rx-	Out
3	Ground	Gnd	-
7	DDI (+)	Port4_Tx+	In
2	DDI (-)	Port4_Tx-	In
6	IDO (+)	Port4_Rx+	Out
1	IDO (-)	Port4_Rx-	Out

Table 4-xx8. Ext Ref Clock Interface J3 Connector Pin Assignments

Pin #	Signal Function	Name	Direction
5	E1 Ref Clock In (+)	Ref_Clk_In (+)	In
9	E1 Ref Clock In (-)	Ref_Clk_In (-)	In
4	Not used	--	--
8	Not used	--	--
3	Ground	Gnd	-
7	Not used	--	--
2	Not used	--	--
6	E1 Ref Clock Out (+)	Ref_Clk_Out (+)	Out
1	E1 Ref Clock Out (-)	Ref_Clk_Out (-)	Out

4.4.9 RX and TX IF Connectors

The IF connectors will depend on the configuration ordered. The following reflects configurations available. BNC 75Ω is standard for 70/140MHz IF, N-Type 50Ω for L-Band, and BNC Ref Connector. This 50Ω BNC female connector provides an external reference input for the Tx and Rx IF synthesizers, and for the internal transmit clock. The load impedance is 60.4Ω, so the VSWR is less than 1.25:1 at either 50Ω or 75Ω. Input level is 0 dBm minimum to +20 dBm maximum at either 1, 2, 5, 10, or 20 MHz. When external reference is enabled, the internal 10 MHz reference oscillator is phase locked to the external reference input by a 10Hz bandwidth PLL. If no activity is present at the external reference input, the modem will revert to the internal 10 MHz reference.

4.5 AC Power Connector

A standard, detachable, non-locking, 3-prong power cord (IEC plug) supplies the Alternating Current (AC) power to the modem. Observe the following:

AC Power Specifications	
Input Power	290W maximum, 57W typical without BUC power supply.
Input Voltage	100 - 240 volts AC, +6%/-10% - autosensing (total absolute max. range is 90 to 254 VAC)
Connector Type	IEC
Fuse Protection	3.15A Slow-blow Line and neutral fusing 20 mm type fuses

4.6 DC Power Connector

A standard, 3-screw terminal block supplies the Direct Current (DC) power to the modem. Observe the following:

AC Power Specifications	
Input Power	290W maximum, 57W typical without BUC power supply.
Input Voltage	36 to 72 VDC; 6.25 amps
Connector Type	Terminal Block
Fuse Protection	3.15A Slow-blow 20 mm type fuses

4.7 Ground Connector

A #10-32 stud on the rear panel of the modem is used for connecting a common chassis ground among equipment.

Note: The AC power connector provides the safety ground.

This page is intentionally left blank.

Chapter 5. FRONT PANEL OPERATION

5.1 Introduction



Figure 5-1. Front Panel Display

The user can fully control and monitor the operation of the Modem from the front panel (Figure 5-1), using the keypad and display. Nested menus are used, which display all available options, and prompt the user to carry out a required action.

The display has two lines of 40 characters each. The display is divided into two areas.

- The left hand area briefly describes the contents of the four plug-in slots and indicates which slot is currently being addressed. To navigate between sides is as simple as selecting a slot if the cursor is on the left side and being in the root menu on the left side and arrowing to the left.
- The right hand side accesses the addressed plug-in device. To group a modulator and demodulator together requires the modulator to be located above the demodulator, one of the two modules needs to be selected in the left side of the screen, return to the right side of the screen go to Config, Group, Modem, and select Group.

On most menu screens, the user will observe a flashing solid block cursor, which blinks at a once-per-second rate. This indicates the currently selected item, digit, or field. Where this solid block cursor would obscure the item being edited (for example, a numeric field) the cursor will automatically change to an underline cursor.

If the user were to display the same screen for weeks at a time, the display could become ‘burnt’ with this image. To prevent this, the unit has a ‘screen saver’ feature that will activate after 1 hour. The top line of the display will show the Circuit ID (which can be entered by the user) and the bottom line will show the circuit Eb/No value (if there is a demod and it is locked) followed by ‘Press any key....’. The message moves from right to left across the screen, then wraps around. If there are multiple circuits, their messages and Eb/No’s will be displayed sequentially. Pressing any key will restore the previous screen. The behavior of the front panel LEDs is described below in Table 5-1.

Table 5-1. Front Panel LED Indicators

LED	Color	Condition
Unit Status	Red	A Unit Fault exists (Example: PSU fault)
	Green	No Unit Faults
		Note: Unit fault does not include Tx or Rx fault.
Transmit Traffic	Green	No Tx Traffic Faults
	Off	A Tx Traffic fault exists or the Tx Carrier is in OFF state
		Note: This LED corresponds to the selected slot, example <TX>.
Receive Traffic	Green	No Rx Traffic Faults (demod and Viterbi decoder are locked, everything is OK)
	Off	An Rx Traffic fault exists (the demod may still be OK – check the fault status of the unit from the Monitor menu).
		Note: This LED corresponds to the selected slot, example <RX>.
Online	Green	The Unit is On Line, and carrying traffic
	Off	The Unit is Off Line (standby) - forced by externally connected 1:1 or 1:N redundancy system
		Note: This LED corresponds to the selected slot, example <RX>.
Stored Event	Orange	There is a Stored Event in the log, which can be viewed from the front panel, or retrieved via the remote control interface
	Off	There are no Stored Events
Remote	Orange	The Unit is in Remote Mode - local monitoring is possible, but no local control
	Off	The Unit is in Local Mode - remote monitoring is possible, but no remote control
	Flashing	ODU FSK control has been enabled, and there is a communications fault.
EDMAC Mode	Orange	Framing on, EDMAC on, and unit defined as Slave - local monitoring is possible, but no local control
	Off	Either the unit is in Transparent mode (no framing), or the framing has been selected, but in AUPC-only mode, or EDMAC Master configuration.
Test Mode	Orange	A Test Mode is selected (example: IF Loopback), or BERT Generator is turned on, or BERT Monitor is turned on, or Spectrum Analyzer is turned on.
	Off	There is no Test Mode currently selected, BERT Generator is off, BERT Monitor is off, and spectrum Analyzer is off.



In general, the Alarm relay state will reflect the state of the Front Panel LEDs. For instance, if the Unit Status LED is red, the Unit Alarm relay will be active, etc. The one exception is the Transmit Traffic relay. This will only be activated if a Transmit Traffic Fault exists – it does not reflect the state of the TX carrier.

The keypad is shown in Figure 5-2:

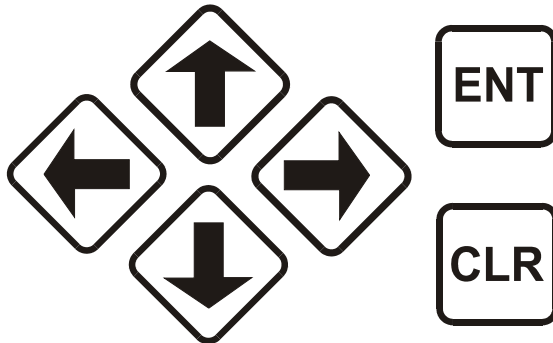

Diamond Keypad (Presently used on all Units)

Button Keypad (New Configuration for Units)

Figure 5-2. Keypad

The function of these keys is as follows:

ENT (Enter)	This key is used to select a displayed function or to execute a modem configuration change.
CLR (Clear)	This key is used to back out of a selection or to cancel a configuration change, which has not been executed using ENT . Pressing CLR generally returns the display to the previous selection.
← → (Left, Right)	These arrows are used to move to the next selection or to move the cursor position. Most of the menus (space permitting) include arrow key hints to guide the user.
↑ ↓ (Up, Down)	These arrows are used primarily to change configuration data (numbers), at the current cursor position. Occasionally they may be used to scroll through a number of choices at the current cursor position. Most of the menus (space permitting) include arrow key hints to guide the user.



The keypad has an auto-repeat feature. If a key is held down for more than 1 second, the key action will repeat, automatically, at the rate of 15 keystrokes per second. This is particularly useful when editing numeric fields, with many digits, such as frequency or data rate.

5.2 Left-Hand Display Area

The left side of the display (or slot screen) efficiently indicates what is in the four plug-in slots and which slot is currently being addressed.

Four ungrouped plug-ins are displayed as in this example:

```
TX    TX    | (right hand display area)
<RX>  RX    | (right hand display area)
```

This display indicates modulators in the top slots, and demodulators in the bottom. The locations of the four indicators line up with the location of the four slots when viewed from the back of the chassis. The left hand TX on the display corresponds with the top left slot in the chassis when viewed from the back. An empty slot is left blank.

The left RX on the example display is highlighted. This is the selected slot. All monitor functions (including the front panel LEDs) reflect the status of this slot. All parameters selected from the menu tree while this slot is selected apply either to this slot or to common functions. The menus for common functions appear redundantly in all four slots. To change slots, move the cursor to the desired slot, and press enter.

The designator for a plug-in device with an unmasked failure has an F suffix:

```
TX    TXF   | (right hand display area)
<RX>  RX    | (right hand display area)
```

In this example, the upper right transmitter has a fault. (View the fault using Monitor, Alarms, etc).

5.2.1 Modems

A modulator in a top slot can be grouped with a demodulator in the slot directly below it to form a modem:

```
TX  <MD> | (right hand display area)
RX                | (right hand display area)
```

The example indicates a configuration in the right hand slots (when viewed from the back of the chassis) grouped together to form a modem. Selecting the slots is the same as a basic configuration except that the blank area below the MD are not be selectable. When the modem is selected, the menus will display modulator and demodulator functions, and the software will select the appropriate plug-in for the command.

Two modems can share a modem:

```
MD <MD> | (right hand display area)
          | (right hand display area)
```

The selected modem is the modulator demodulator pair on the right side of the chassis (when viewed from the back). When modem is in CnC™ mode, the brackets (<>) will turn into bold characters.

5.2.2 Redundancy

Modules, (modulators and demodulators) can be upgraded to operate as redundant units. If enabled the module can back up a like kind module located anywhere in the chassis. If a modulator and demodulator have redundancy enabled and they are grouped as a modem, the pair can back up a modem. Note: The interface selected for the modules does not have to match the interface type used on the prime modules.

Three redundancy modes are possible with a modem. Back-up devices are notated with a B suffix while the designated prime modules (non-modem grouped) are noted with P suffix. In a non-modem configuration, the back-up device must be installed in slot #4. If a backup device has failed, the B suffix and the F suffix will alternately display.

1:1 redundant modems look similar to the two-modem example. The modems have independent monitor functions, but configuring the prime modem will configure the back up modem.

```
MD <MDB> | (right hand display area)
          | (right hand display area)
```

In this example, the backup modem is selected.

1:2 and 1:3 modulators or demodulators look similar to the basic display. A backup modulator or demodulator will back up all compatible modulators or demodulators in the chassis designated as primes.

The Online LED together with the selection bracket (<>) is used to indicate which device is online.

5.2.3 Spectrum Analyzer

The built-in spectrum analyzer mode is available, accessible via remote control, front panel or web browser. When it is active, the selected demod will not respond to specific Rx front panel settings, nor will it carry traffic. It is marked with an S suffix. It has its own front panel menu controls under “Test” menu.

```
TX TX | (right hand display area)
<RX> RXS | (right hand display area)
```

In this example, the bottom right receiver (as seen from the back of the chassis) is being used as a spectrum analyzer. Only one Rx is allowed to enable spectrum analyzer in a chassis. To view the spectrum, the user needs a Windows application from Comtech or a web browser.

5.3 Right-Hand Display Area

Figure 5-3 shows the menu structure similar to the CDM-570L. The menus are shown fully populated, but if the addressed plug-in device is a modulator or a demodulator, much of the menu tree will be locked out. Functions that are not tied to a plug-in slot (like the external reference) are displayed no matter which slot is addressed.

The detailed screens and menus are as follows.

5.4 Accessing the Display Area

Since the front panel display screen is split into two, the left-hand display area (also called as the *slot screen*) can be accessed by using ◀ arrow key if the menu-level is **MAIN**, **CONFIG**, **MONITOR**, or **INFO** (and there is more than one module to select between).

To go back to the right-hand display area (also called the *menu screen*), just press **CLR** or **ENT**. By pressing **ENT**, the user has selected the plug-in card.

Para	Title	Remarks
5.5	Opening Screen	
5.6	Main Menu	Select: Config; Monitor; Test; Info; Save/Load; Util; ODU
5.6.1	Conf:	Select: Remote; Tx; Rx; Group; Frame; Interface; Ref; Mask; ODU
5.6.1.1	Config → Remote	Select: Local; Serial; Ethernet
5.6.1.2	Config → Tx	Select: FEC; Mod; Code; Data; Freq; On/Off; Pwr; Scram; Clk; Inv; Tx α
5.6.1.3	Config → Rx	Select: FEC; Demod; Code; Data; Freq; Acq; Descram; Buf; Inv; Misc; CNC
5.6.1.4	Config → Group	Select: Modem; Redundancy
5.6.1.5	Config → Frame	Select: Unframed; EDMAC; EDMAC-2; D&I++
5.6.1.6	Config → Interface	Select: RS422; V.35; RS232; HSSI; ASI; G.703; QDI; None
5.6.1.7	Config → Ref	Select: Internal; 10MHz
5.6.1.8	Config → Mask	Select: Transmit; Receive; Reference; BUC; LNB
5.6.1.9	Config → ODU	Select: BUC; LNB
5.6.2	Monitor	Select: Alarms; Rx-Params; Event-Log; Stats; AUPC; CNC; ODU
5.6.2.1	Monitor → Alarms	Select: Transmit; Receive; Unit; ODU
5.6.2.2	Monitor → Rx-Params	Select: Eb/No, BER, Δ F, BUF, RSL
5.6.2.3	Monitor → Event-Log	Select: View; Clear-All
5.6.2.4	Monitor → Stats	Select: View; Clear-All; Config
5.6.2.5	Monitor → AUPC	Framing is required for AUPC Monitor
5.6.2.6	Monitor → CnC	Carrier in Carrier® (CnC) is not locked.
5.6.2.7	Monitor → ODU	Select: ODU; LNB
5.6.3	Test	Select: Mode; BIST; Spec-Analyzer
5.6.4	Info	Select: Rem; Tx; Rx; Buffer; Frame; Interface; Mask; Ref; ID
5.6.5	Save/Load	Select: Save; Load
5.6.6	Utility	Select: RxBuffer; Clock; Ref; ID; Display; Firmware; FAST
5.6.7	Utility → FAST	Select: Base; Slot1; Slot2; Slot3; Slot4

Figure 5-3. Principle Menu Tree

5.5 Opening Screen

```
Comtech EF Data CDM-Qx
Firmware Version: 1.1.1
```

This screen is displayed whenever power is first applied to the unit (70/140 MHz version). The word “CDM-Qx” will be replaced with “CDM-QxL” for L-Band units. Pressing any key will take the user to the top-level selection screen:

5.6 TOP LEVEL SELECTION

```
MAIN MENU:  Config  Monitor
            Test  Info  Save/Load Util ODU
```

The user is presented with the following choices:

Config	(Configuration) This menu branch permits the user to fully configure the unit.
Monitor	This menu branch permits the user to monitor the alarm status of the unit, to view the log of stored events, and to display the Receive Parameters screen.
Test	This menu branch permits the user to invoke one of several test modes (loopbacks, for example).
Info	(Information) This menu branch permits the user to view information on the unit, without having to go into configuration screens.
Save/Load	This menu branch permits the user to save and to retrieve up to 10 different modem configurations.
Util	(Utility) This menu branch permits the user to perform miscellaneous functions, such as setting the Real-time clock, adjusting the display brightness, etc. For L-Band unit, the menu “Util” will be replaced with “Utility”.
ODU (70/140 MHz only)	This menu permits the user to monitor and control Comtech CSAT and KST transceivers.

5.6.1 CONFIG

The sub-branches available are:

CONFIG: Remote Tx Rx Group Frame Interface Ref Mask ODU

Remote	<p>(Remote Control) This menu sub-branch permits the user to define whether the unit is being controlled locally, or remotely.</p> <p>NOTE: The unit may be monitored over the remote control bus at any time. When in Local mode, however, configuration parameters may only be changed through the front panel. Conversely, when in Remote mode, the unit may be monitored from the front panel, but configuration parameters may only be changed via the remote control bus.</p>
Tx	<p>(Transmit) This menu sub-branch permits the user to define, on a parameter-by-parameter basis, the transmit configuration of the unit.</p>
Rx	<p>(Receive) This menu sub-branch permits the user to define, on a parameter-by-parameter basis, the receive configuration of the unit.</p>
Group	<p>This menu sub-branch permits the user to group a vertically aligned modulator and demodulator into a modem, or to group any compatible plugins for redundancy.</p>
Frame	<p>This menu sub-branch permits the user to define if the unit should operate in a transparent mode (no framing) or in a framed mode. In the framed mode (EDMAC), an overhead of 5% is added to the rate transmitted over the satellite so that M&C information may be passed to the distant end.</p>
Interface	<p>(Interface) This menu sub-branch permits the user to define which electrical interface type is active at the data connectors.</p>
Ref	<p>(Reference) This menu sub-branch permits the user to define whether the unit should use its own internal 10MHz reference, or phase lock to an externally applied reference, and if so, at what frequency. If the internal reference is selected, it can optionally drive the connector.</p>
Mask	<p>This menu sub-branch permits the user to mask certain traffic alarms, which may cause problems to the user. As an example, certain multiplexers use 'all ones' as an idle pattern. However, by convention, the 'all ones' condition is taken to be the Alarm Indication Signal (AIS). The CDM-Qx monitors for the AIS condition, and if desired, this alarm may be masked.</p>
ODU (L-Band unit only)	<p>(Outdoor Unit) This menu sub-branch permits the user to configure externally connected Low-noise Block Down Converter (LNB) and/or Block Up Converter (BUC) for L-Band units.</p>

5.6.1.1 (Config→Remote) – REMOTE CONTROL

Select **Local**, **Serial**, or **Ethernet** using the (◀ ▶) arrow keys, then press **ENT**.

```
Remote Control Entry: Local
Serial Ethernet (◀ ▶, ENT)
```

If **Local** is selected then remote control will be disabled. Remote monitoring is still possible.

(Config→Remote→Serial)

If **Serial** is selected:

```
Remote Serial Config:
Interface Baudrate (◀ ▶, ENT)
```

(Config→Remote→Serial→Interface)

If **Interface** is selected:

```
M&C Serial Interface: RS232
RS485-2W RS485-4W (◀ ▶, ENT)
```

Select **RS232**, **RS485-2W** (2-wire), or **RS485-4W** (4-wire), using the (◀ ▶) arrow keys, then press **ENT**.

At this point the user will be further prompted to enter the bus address.

If **RS232** is selected, the following menu is displayed:

```
In RS-232 Mode, Serial Bus
Base Address is fixed @ 0000
```

(Config→Remote→Serial→Interface→RS485) - RS-485 Bus Address

However, if either RS-485 mode is selected, the user will be further prompted:

```
Edit RS-485 Serial Bus Base
Address: 0245      (◀ ▶, ▲▼, ENT)
```

Edit the RS-485 bus address of this unit. This is accomplished by selecting the digit to be edited, using the ◀ ▶ arrow keys. The value of the digit is then changed using the ▼ ▲ arrow keys. The user should then press **ENT**. The valid range of addresses is from 1 to 9999.

(Config→Remote→Serial→Baudrate)

If the user selects Baud Rate, the user is presented with the following menu:

```
M&C Serial Bus Baud Rate:
19200 Baud      (▲ ▼, ENT)
```

Edit the baud rate of the remote control bus, connected locally to the M&C computer. The value is changed using the ▲ ▼ arrow keys. The user should then press **ENT**. Values of 2400, 4800, 9600, 19200, 38400, and 57600 baud are possible.

Note that the asynchronous character format is **FIXED** at 8 data bits, 1 stop bit, no parity (8-N-1).

(Config→Remote→Ethernet)

If **Ethernet** is selected:

```
Ethernet Config:      (◀ ▶, ENT)
Gateway Address MAC SNMP
```

(Config→Remote→Ethernet→Gateway)

If **Gateway** is selected, the submenu will display:

```
M&C Ethernet IP Gateway:
192.128.001.001  (< ▶▲ ▼, ENT)
```

Edit the IP Gateway Address for the Ethernet M&C port for this unit. This is accomplished by selecting the digit to be edited, using the ◀ ▶ arrow keys. The value of the digit is then changed using the ▲ ▼ arrow keys. The user should then press **ENT**.

(Config→Remote→Ethernet→Address)

If **Address** is selected, the submenu will display:

```
M&C Ether IP Address/Range:
192.168.001.001/24 (< ▶▲ ▼, ENT)
```

Edit the IP Address and Range for the Ethernet M&C port for this unit. This is accomplished by selecting the digit to be edited, using the ◀ ▶ arrow keys. The value of the digit is then changed using the ▲ ▼ arrow keys. The user should then press **ENT**.

(Config→Remote→Ethernet→MAC)

If **MAC** is selected, the user will only be allowed to view it as displayed for example:

```
M&C Port MAC Address:
00-06-B0-00-00-D5
```

This is a read-only window, which displays the factory program MAC address for the Ethernet management interface.

(Config→Remote→Ethernet→SNMP)

If **SNMP** is selected, the following sub-menu is displayed:

```
SNMP: Communities Traps
      (< ▶, ENT)
```

(Config→Remote→Ethernet→SNMP→Communities)

If **Communities** is selected:

```
SNMP Communities:  
Read Write      (◀ ▶, ENT)
```

If **Read** is selected, the following sub-menu is displayed:

```
Read Community: (◀ ▶ ▲ ▼, ENT)  
public
```

If **Write** is selected, the following sub-menu is displayed:

```
Write Community: (◀ ▶ ▲ ▼, ENT)  
private
```

Edit the SNMP Read or Write Community string using the ◀ ▶ and ▲ ▼ arrow keys. Only the first 20 characters on the bottom line are available. The cursor selects the position on the bottom line (◀ ▶) and the character is then edited (▲ ▼). All printable ASCII characters are available with the exception of backslash (ASCII code 92) and ~ (ASCII code 126). When the user has composed the string, press **ENT**. All trailing spaces are removed from the Community string upon entering.

(Config→Remote→Ethernet→SNMP→Traps)

If **Traps** is selected, the following sub-menu is displayed:

```
Traps: Community Version  
IP Addr#1 IP Addr#2 (◀ ▶, ENT)
```

If **Community** is selected, the following sub-menu is displayed.

```
Trap Community:  (< > ▲ ▼, ENT)
comtech
```

Edit the Trap Community string using the < > and ▲ ▼ arrow keys. Only the first 20 characters on the bottom line are available. The cursor selects the position on the bottom line (< >) and the character is then edited (▲ ▼). All printable ASCII characters are available with the exception of backslash (ASCII code 92) and ~ (ASCII code 126). When the user has composed the string, press **ENT**. All trailing spaces are removed from the Community string upon entering.

If **Version** is selected, the following sub-menu is displayed.

```
Trap Version:    (< >, ENT)
SNMPv1 SNMPv2
```

Select **SNMPv1** or **SNMPv2**, using the < > arrow keys, then press **ENT**.

If **IP Addr#1** is selected, the following sub-menu is displayed:

```
Trap IP Addr#1: (< > ▲ ▼ ENT)
000.000.000.000
```

If **IP Addr#2** is selected, the following sub-menu is displayed:

```
Trap IP Addr#2: (< > ▲ ▼ ENT)
000.000.000.000
```

These two IP Addresses are Trap Destination's IP Addresses. Edit the IP Address by using the < > and ▲ ▼ arrow keys. If both Trap IP Address are 000.000.000.000, it means Trap is disabled.

5.6.1.2 (Config→Tx) - TRANSMIT

**Tx: FEC Mod Code Data Freq
On/Off Pwr Scram Clk Inv Txα**

Select **FEC, Mod, Code, Data, Freq, On/Off, Pwr, Scram, Clk, Inv, or Txα** using the ◀ ▶ arrow keys, then press **ENT**. The user will then be taken to a further sub-menu. Each of these choices is described briefly in the table below:

FEC	(Forward Error Correction) This sub-menu permits the user to select the method of FEC used for transmission (Viterbi, TPC, etc). FEC type takes the highest configuration priority.
Mod	(Modulation) This sub-menu permits the user to select the modulation type used for transmission (BPSK, QPSK, 8-PSK, etc.). The available choice of modulation will depend on the FEC type chosen.
Code	(FEC Code Rate) This sub-menu permits the user to select the FEC Code Rate used for transmission (Rate 1/2, Rate 3/4, etc). The available choice of Code Rate will depend on both the FEC type and Modulation type selected.
Data	(Data Rate) This sub-menu permits the user to select the transmit data rate, in steps of 1 bps. The choice of data rate will depend on the FEC type, Modulation type, and Code Rate selected.
Freq	(Frequency) This sub-menu permits the user to select the transmit frequency, from 950 MHz to 1950 MHz, in steps of 100Hz for L-Band units, or from 50 MHz to 90 MHz and from 100 MHz to 180 MHz for 70/140MHz units.
On/Off	This sub-menu permits the user to control the output state of the transmit carrier.
Pwr	(Output Power level) This sub-menu permits the user to control the output level of transmit carrier, either manually, or using the AUPC (Automatic Uplink Power Control) feature.
Scram	(Scrambler) This sub-menu permits the user to select whether or not data scrambling is used.
Clk	(Clock Source) This sub-menu permits the user to select the clock source for transmission. This can be from the internal source, from an external source, or from the distant-end of the satellite link (loop timed).
Inv	(Inversion) This sub-menu permits the user to invert the sense of the transmitted spectrum, or to invert the sense of the transmitted baseband data or data clock
Txα	(α-Factor) This permits the user to select the modulator's roll-off factor either 20% or 35%.



The FEC type takes the highest configuration priority, and the selection here depends on what, if any, optional plug-in Codecs are installed. The choice of FEC type then determines what modulation types, code rates, and data rates are available. The order of hierarchy is therefore:

FEC type ▶ Modulation type ▶ Code Rate ▶ Data Rate
(Highest) (Lowest)

If the user changes a parameter within this hierarchy, the other parameters may become invalid. In this case, the software will change those other parameters, in order that the configuration remains valid at all times.

Example: Suppose the user has selected Viterbi + Reed Solomon, QPSK, Rate 1/2. Now, the user changes the modulation type from QPSK to 16-QAM. In this case, Rate 1/2 is no longer a valid code rate, and so it will be automatically changed to the nearest valid code rate (Rate 3/4). Each of the configuration sub-branches will now be described in detail.

(Config→Tx→FEC) – TX FEC TYPE

Tx FEC: Vit Vit+RS TCM+RS
TPC (◀ ▶, ENT)



All possible choices are presented at all times. If an option is not installed (either Hardware, or FAST) or not valid, the ◀ ▶ arrow keys will force the cursor to skip past the unavailable choice.

FEC Type	RULES	COMMENT
Vit (Viterbi)	Always valid	
Vit+R-S (Viterbi +Concatenated Reed-Solomon)	Always valid	
TCM+R-S (Trellis Coded Modulation + Concatenated Reed-Solomon)	If 8-PSK FAST is enabled	Fixed at 8-PSK and Rate 2/3
TPC (Turbo)	If the TPC codec is installed	

(Config→Tx→Mod) – MODULATION SCHEME

Modulation: BPSK QPSK 8-PSK
16-QAM (◀ ▶, ENT)



All possible choices are presented at all times. If an option is not installed (either Hardware, or FAST) or valid, the ◀ ▶ arrow keys will force the cursor to skip past the unavailable choice.

CASE	RULES
BPSK	Valid for all FEC types except TCM+R-S
QPSK	Valid for all FEC types except TCM+R-S
8-PSK	Valid for TCM+R-S, TPC (Turbo) requires 8-PSK FAST option
16-QAM	Valid for Viterbi + R-S, TPC (Turbo) requires 16-QAM FAST option

(Config→Tx→Code) – TX CODE RATE

Tx Code Rate: 5/16 21/44 1/2
2/3 3/4 7/8 17/18 (◀ ▶)



All possible choices are presented at all times. If an option is not installed (either Hardware, or FAST) or valid, the ◀ ▶ arrow keys will force the cursor to skip past the unavailable choice.

CASE	RULES
5/16	Valid for BPSK and Turbo
21/44	Valid for BPSK, QPSK and Turbo
1/2	Valid for BPSK, QPSK, Viterbi, Viterbi+R-S
2/3	Valid for TCM+R-S only (8-PSK)
3/4	Valid for QPSK, 8-PSK, and 16-QAM
7/8	Valid for QPSK, 8-PSK, and 16-QAM
17/18	Valid for QPSK, 8-PSK, and Turbo

(Config→Tx→Data) – TX DATA RATE

Tx Data Rate: 05000.000kbps
Sym: 02500.000ksps

In Quad Drop&Insert (QDI) mode, these data rates are **read-only!** The data rate will be the sum of the tributary rates for all ports. This also will show the calculated symbol rate and Nx64kbps (where N=001 to 124).



The overall range of data rates is from 32 to 20000 kbps. The overall range of symbol rates is up to 10000 ksps. The minimum data rate is set to 32 kbps only for BPSK and QPSK, and the maximum data rates are dependent on modulation type and FEC encoder rate. If the user changes the modulation or FEC, and the currently selected data rate can no longer be supported, the data rate will be adjusted automatically, up or down, keeping the symbol rate constant. The bottom line of the display shows the symbol rate, based on FEC type, modulation, FEC Code Rate, and Data Rate. The valid ranges of data rate are shown in the following table.

FEC Type	Modulation	Code Rate	Data Rate Range	EDMAC limited?
Viterbi	BPSK	Rate 1/2	32 kbps to 5 Mbps	Yes – see note below
Viterbi	QPSK	Rate 1/2	32 kbps to 10 Mbps	Yes – see note below
Viterbi	QPSK	Rate 3/4	32 kbps to 15 Mbps	Yes – see note below
Viterbi	QPSK	Rate 7/8	32 kbps to 17.5 Mbps	Yes – see note below
Viterbi + R-S	BPSK	Rate 1/2	32 kbps to 4.5 Mbps	Yes – see note below
Viterbi + R-S	QPSK	Rate 1/2	32 kbps to 9.1 Mbps	Yes – see note below
Viterbi + R-S	QPSK	Rate 3/4	32 kbps to 13.7 Mbps	Yes – see note below
Viterbi + R-S	QPSK	Rate 7/8	32 kbps to 16 Mbps	Yes – see note below
Viterbi + R-S	16-QAM	Rate 3/4	349.1 kbps to 20 Mbps	Yes – see note below
Viterbi + R-S	16-QAM	Rate 7/8	407.3 kbps to 20 Mbps	Yes – see note below
TCM + R-S	8-PSK	Rate 2/3	232.7 kbps to 18.3 Mbps	Yes – see note below
TPC	BPSK	Rate 5/16	32 kbps to 3.1 Mbps	Yes – see note below
TPC	BPSK	Rate 21/44	32 kbps to 4.7 Mbps	Yes – see note below
TPC	QPSK	Rate 21/44	32 kbps to 9.5 Mbps	Yes – see note below
TPC	QPSK	Rate 3/4	32 kbps to 15 Mbps	Yes – see note below
TPC	QPSK	Rate 7/8	32 kbps to 17.5 Mbps	Yes – see note below
TPC	QPSK	Rate 17/18	32 kbps to 18.888 Mbps	Yes – see note below
TPC	8-PSK	Rate 3/4	288 kbps to 20 Mbps	No
TPC	8-PSK	Rate 7/8	336 kbps to 20 Mbps	No
TPC	8-PSK	Rate 17/18	362.7 kbps to 20 Mbps	No
TPC	16-QAM	Rate 3/4	384 kbps to 20 Mbps	No
TPC	16-QAM	Rate 7/8	448 kbps to 20 Mbps	No

Important Note: Where noted in the table above, if EDMAC framing is employed, the upper data rate will be reduced by 5% for data rates up to 2.048 Mbps, and by 1.6% for data rates above 2.048 Mbps, where EDMAC2 framing is used, or for Rate 21/44 BPSK/QPSK Turbo, or Rate 5/16 BPSK Turbo.

Tx IF Freq: 1156.3456 MHz
(◀ ▶, ▲ ▼, ENT)

(Config→Tx→Freq) – TX IF FREQUENCY

Edit the Transmit IF Frequency. This is accomplished by selecting the digit to be edited, using the ◀▶ arrow keys. The value of the digit is then changed using the ▲▼ arrow keys. The user should then press ENT. The range of frequencies depends upon the plug-in module. The above example shows the L-Band version of modem.

If (using the **ODU, BUC** menus) the user has selected a BUC LO frequency (other than zero) and defined whether the mix is high side or low side, the display will be modified as shown below, to include the calculated Transmit RF frequency of the modem/BUC combination:

```
Tx IF Freq: 1156.3456 MHz
RF=14156.3456  (< ▶▲ ▼ ENT)
```

As the Tx IF frequency is edited the RF frequency will automatically be updated

(Config→Tx→On/Off) – TRANSMIT ON/OFF CONTROL

```
Tx Output State:  On  Off
RxTxInhibit Common (< ▶, ENT)
```

Select either **On**, **Off**, **RxTxInhibit**, or **Common** using the ◀▶ arrow keys, then press **ENTER**.

When **Rx-Tx Inhibit** (RTI) is selected, it will prevent the TX carrier from being transmitted, until the demodulator is locked.

To avoid the Tx Carrier from being turned off when the demodulator loses lock for a very short period of time, the demodulator must be unlocked continuously for a period of 10 seconds before the transmit carrier is inhibited. This time interval is fixed and the user cannot change it.



Having this feature enabled does not affect the internal IF Loopback feature. But, please be aware that if an external IF Loopback is attempted (connecting an external cable from the Tx IF output to the Rx IF input), then this will not work! (The Tx carrier cannot turn on until the demod is locked, and the demod cannot lock, because the TX output is off. The net result is that the demod will not lock, and the Tx carrier will not turn on. USE THE RTI FEATURE WITH EXTREME CARE!

When **Common** is selected, this sub-menu will appear:

```
Tx Common Output State:
Off On  (< ▶ ENT)
```

This will turn On or Off all the transmit path – master control for all modulators.

(Config→Tx→Pwr) – TRANSMIT POWER LEVEL MODE

Select the output power level mode, either **Manual** or **AUPC**, then press **ENT**.

```
Output Power Level Mode:  
Manual AUPC (< >, ENT)
```

If the user selects **Manual**, the following menu is displayed:

(Config→Tx→Pwr→Manual) – MANUAL MODE

```
Tx Output Power Level:  
-03.9 dBm      (< >, ▲ ▼, ENT)
```

Edit the output power level using the < > and ▲▼ arrow keys, then press **ENT**.

If the user selects **AUPC**, and ‘Framed’ mode is not selected, the following menu is displayed:

```
Warning! AUPC needs  
Framed Mode (ENT or CLR)
```

Pressing either **ENT** or **CLR** returns the user to the previous menu with **Manual** selected.

If the user selects **AUPC**, and ‘Framed’ mode is selected, the following menu is displayed:

(Config→Tx→Pwr→AUPC) – AUPC MODE

```
Target-Eb/No  Max-Range Alarm  
DemodUnlock (< >, ENT)
```

Select either **Target EbNo**, **Max-Range**, **Alarm** or **Demod-Unlock** using the < > arrow keys. The user should then press **ENT**.

(Config→Tx→Pwr→AUPC) – TARGET Eb/No

```
Remote Demod - Target Eb/No  
Min Eb/No: 9.9dB (◀ ▶, ▲ ▼, ENT)
```

Edit the target Eb/No of the remote demod, using the ◀ ▶ and ▲ ▼ arrow keys. Default value is 3.0 dB, and upper limit is 9.9 dB. The user should then press ENT.

(Config→Tx→Pwr→AUPC) – MAX RANGE

```
Maximum-permitted Power  
increase: 01dB (▲ ▼, ENT)
```

Edit the maximum permitted increase in power level (when in AUPC mode), using the ▲ ▼ arrow keys. Default value is 1dB, and upper limit is 9 dB. Then press ENT.

(Config→Tx→Pwr→AUPC) – ALARM

```
Action when max Tx Power  
reached: None TxAlarm (◀ ▶,
```

Select the action that will occur if the AUPC causes the maximum output power level to be reached, either None or TxAlarm. Then press ENT.

(Config→Tx→Pwr→AUPC) – DEMOD-UNLOCK

```
Action when Remote Demod  
unlocks: Nom-Pwr Max-Pwr
```

Select the action that will occur if the remote demod is unlocked. The choices are: **Nom-Pwr** (Nominal Power), where the output level will revert to the nominal power level set under **Manual**, or **Max-Pwr**, (Maximum Power), where the output level will change to the maximum permitted. The user should then press ENT.

(Config→Tx→Pwr→Combined) – COMBINED TRANSMIT POWER

```
Tx Combined Output Power:
-3.9 dBm      (◀ ▶, ▲ ▼, ENT)
```

The combined power adjusts the level after all modulators in the chassis have been combined. It has a range of -5 dBm to +5 dBm. This level is fixed, and is not adjusted by AUPC.

(Config→Tx→Scram) – SCRAMBLER

```
Scrambling: Default-On
IESS-315-On Off (◀ ▶, ENT)
```

The options are:

Default-On	the appropriate scrambler type is automatically selected
IESS-315-On	this only applies when Turbo is installed and has been selected as the FEC type
Off	No scrambling

As before, the options are displayed all of the time, but the ◀ ▶ arrow keys will force the cursor to skip past an unavailable choice.



The default scrambler types are:

Viterbi, no framing:

Viterbi, EDMAC frame:

Viterbi + R-S or TCM/R-S:

TPC:

ITU V.35 (Intelsat variant)

Comtech proprietary, frame synchronized

Per IESS-308, frame synchronized

Comtech proprietary, frame synchronized

(Config→Tx→Clk) – TX CLOCKING MODE

```
Tx Clocking Mode: Int Ext
Loop-Timed ExtLoop (◀ ▶, ENT)
```

Select **Int** (Internal), **Ext** (External) or **Loop-Timed**, using the ◀ ▶ arrow keys, then press **ENT**.

Internal	indicates that the CDM-QX will supply a clock to the DTE, which is derived from its internal high-stability source.
External	indicates that the CDM-QX expects to receive a clock from the DTE, to which the unit can phase-lock its internal circuits. (If G.703 is selected as the Interface type, the software will force the clock mode to External .)
Loop-Timed	indicates that the transmit timing source should be the receive clock, from the direction of the satellite. This is a useful mode, in that no external connection needs to be made in this mode. If the demodulator loses lock, or if there is no receive signal present, the internal clock is substituted. Note also that this mode will work even with asymmetric Rx and Tx data rates.
ExtLoop	Indicates that the CDM-Qx expects to receive a clock from the DTE, which is derived from the received clock from the direction of the satellite. This is useful in CnC mode with G.703 interface wherein the remote station is relying on a centralized clock from the hub station.

(Config→Tx→Inv) – TX INVERSION FUNCTIONS

Tx Inversion functions:
Spectrum Data Clock (< >, ENT)

Select **Spectrum** or **Data Clock**, using the < > arrow keys, then press **ENT**.

If **Spectrum** is selected, the following sub-menu will be displayed:

Tx Spectral Inversion:
Normal Inverted (< >, ENT)

Select **Normal** or **Inverted**, using the < > arrow keys, then press **ENT**.

If **Data Clock** is selected, the following sub-menu will be displayed:

Tx Data Sense:
Normal Inverted (< >, ENT)

Select **Normal** or **Inverted**, using the < > arrow keys, then press **ENT**.

If **Clock** is selected, the following sub-menu will be displayed:

Tx Clock Inversion:
Normal Inverted (< >, ENT)

(Config→Tx→Tx α) – TX Roll-Off (α) factor

```
Tx Roll-off: 20%  35%
                (◀ ▶, ENT)
```

Select **20%** or **35%**, using the ◀ ▶ arrow keys, then press **ENT**. The default is **35%**.

5.6.1.3 (Config→Rx) - RECEIVE

The sub-branches available are:

```
Rx:FEC Demod Code Data Frq
  Acq Descram Buf Inv Misc CnC
```

Select **FEC**, **Dem**, **Code**, **Data**, **Frq**, **Acq**, **Descram**, **Buf**, **Inv**, **Misc**, or **CnC**® using the ◀▶ arrow keys, then press **ENT**. The user will then be taken to a further sub-menu. Each of these choices is described briefly in the table below:

FEC	(Forward Error Correction) This sub-menu permits the user to select the method of FEC used for reception (Viterbi, TPC, etc.). FEC type takes the highest configuration priority.
Demod	(Demodulation) This sub-menu permits the user to select the modulation type used for reception (BPSK, QPSK, 8-PSK, etc.). The available choice of demodulation will depend on the FEC type chosen.
Code	(FEC Code Rate) This sub-menu permits the user to select the FEC Code Rate used for reception (Rate 1/2, Rate 3/4, etc.). The available choice of Code Rate will depend on both the FEC type and Demodulation selected.
Data	(Data Rate) This sub-menu permits the user to select the receive data rate, in steps of 1 bps. The choice of data rate will depend on the FEC type, Demodulation, and Code Rate selected.
Acq	(Acquisition) This sub-menu permits the user to determine the amount of frequency uncertainty the demodulator will search over in order to find and lock to an incoming carrier.
On/Off	This sub-menu permits the user to control the output state of the transmit carrier.
Descram	(Descrambler) This sub-menu permits the user to select whether or not data descrambling is used.
Buf	(Buffer) This sub-menu permits the user to select whether or not the Plesiochronous/Doppler buffer is used, and if so, the size of that buffer.
Inv	(Inversion) This sub-menu permits the user to invert the sense of the received spectrum, or to invert the sense of the received baseband data.
Misc	(Miscellaneous) This sub-menu will allow the user to select Eb/No Alarm Threshold (EbNo) and Rx roll-off (alpha) factor Rx α .
C-in-C	(Carrier-in-Carrier®) This sub-menu allows the user to set-up the carrier-in-carrier parameters.

(Config→Rx→Demod) – DEMODULATION SCHEME

Demodulation: BPSK QPSK 8-PSK
16-QAM (◀ ▶ ENT)



All possible choices are presented at all times. If an option is not installed (either Hardware, or FAST) or valid, the ◀ ▶ arrow keys will force the cursor to skip past the unavailable choice.

CASE	RULES
BPSK	Valid for all FEC types except TCM+R-S
QPSK	Valid for all FEC types except TCM+R-S
8-PSK	Valid for TCM+R-S, TPC (Turbo) requires 8-PSK FAST option
16-QAM	Valid for Viterbi + R-S, TPC (Turbo) requires 16-QAM FAST option

(Config→Rx→Code) – RX CODE RATE

Rx Code Rate: 5/16 21/44 1/2
2/3 3/4 7/8 17/18 (◀ ▶)



All possible choices are presented at all times. If an option is not installed (either Hardware, or FAST) or valid, the ◀ ▶ arrow keys will force the cursor to skip past the unavailable choice.

CASE	RULES
5/16	Valid for BPSK and Turbo
21/44	Valid for BPSK, QPSK and Turbo
1/2	Valid for BPSK, QPSK, Viterbi, Viterbi+R-S
2/3	Valid for TCM+R-S only (8-PSK)
3/4	Valid for QPSK, 8-PSK, and 16-QAM
7/8	Valid for QPSK, 8-PSK, and 16-QAM
17/18	Valid for QPSK, 8-PSK, and Turbo

(Config→Rx→Data) – RX DATA RATE

Rx Data Rate: 05000.000kbps
Sym: 02500.000ksps

In QDI mode, these data rates are **read-only!** The data rate will be the sum of the tributary rates for all ports. This will also show the calculated symbol rate and Nx64kbps (where N=001 to 124).



The overall range of data rates is from 32 to 20000 kbps. The overall range of symbol rates is up to 10000 ksps. The minimum and maximum data rates are dependent on modulation type and FEC encoder rate. If the user changes the modulation or FEC, and the currently selected data rate can no longer be supported, the data rate will be adjusted automatically, up or down, keeping the symbol rate constant. The bottom line of the display shows the symbol rate, based on FEC type, modulation, FEC Code Rate, and Data Rate.

FEC Type	Modulation	Code Rate	Data Rate Range	EDMAC limited?
Viterbi	BPSK	Rate 1/2	32 kbps to 5 Mbps	Yes – see note below
Viterbi	QPSK	Rate 1/2	32 kbps to 10 Mbps	Yes – see note below
Viterbi	QPSK	Rate 3/4	32 kbps to 15 Mbps	Yes – see note below
Viterbi	QPSK	Rate 7/8	32 kbps to 17.5 Mbps	Yes – see note below
Viterbi + R-S	BPSK	Rate 1/2	32 kbps to 4.5 Mbps	Yes – see note below
Viterbi + R-S	QPSK	Rate 1/2	32 kbps to 9.1 Mbps	Yes – see note below
Viterbi + R-S	QPSK	Rate 3/4	32 kbps to 13.7 Mbps	Yes – see note below
Viterbi + R-S	QPSK	Rate 7/8	32 kbps to 16 Mbps	Yes – see note below
Viterbi + R-S	16-QAM	Rate 3/4	349.1 kbps to 20 Mbps	Yes – see note below
Viterbi + R-S	16-QAM	Rate 7/8	407.3 kbps to 20 Mbps	Yes – see note below
TCM + R-S	8-PSK	Rate 2/3	232.7 kbps to 18.3 Mbps	Yes – see note below
TPC	BPSK	Rate 5/16	32 kbps to 3.1 Mbps	Yes – see note below
TPC	BPSK	Rate 21/44	32 kbps to 4.7 Mbps	Yes – see note below
TPC	QPSK	Rate 21/44	32 kbps to 9.5 Mbps	Yes – see note below
TPC	QPSK	Rate 3/4	32 kbps to 15 Mbps	Yes – see note below
TPC	QPSK	Rate 7/8	32 kbps to 17.5 Mbps	Yes – see note below
TPC	QPSK	Rate 17/18	32 kbps to 18.888 Mbps	Yes – see note below
TPC	8-PSK	Rate 3/4	288 kbps to 20 Mbps	No
TPC	8-PSK	Rate 7/8	336 kbps to 20 Mbps	No
TPC	8-PSK	Rate 17/18	362.7 kbps to 20 Mbps	No
TPC	16-QAM	Rate 3/4	384 kbps to 20 Mbps	No
TPC	16-QAM	Rate 7/8	448 kbps to 20 Mbps	No

Important Note: Where noted in the table above, if EDMAC framing is employed, the upper data rate will be reduced by 5% for data rates up to 2.048 Mbps, and by 1.6% for data rates above 2.048 Mbps, where EDMAC2 framing is used, or for Rate 21/44 BPSK/QPSK Turbo, or Rate 5/16 BPSK Turbo.

(Config→Rx→Freq) – RX FREQUENCY

```
Rx IF Freq: 1156.3456 MHz
          (< ▶, ▲ ▼, ENT)
```

Edit the receive frequency. This is accomplished by selecting the digit to be edited, using the ◀▶ arrow keys. The value of the digit is then changed using the ▲▼ arrow keys. The user should then press ENT. The range of frequencies depends upon the plug-in module. The above examples shows the L-Band version of CDM-Qx.

If (using the ODU, LNB menus) the user has selected an LNB LO frequency (other than zero) and defined whether the mix is high side or low side, the display will be modified as shown below, to include the calculated Receive RF frequency of the modem/BUC combination:

```
Rx IF Freq:1156.3456 MHz
RF=12156.3456 (< ▶ ▲ ▼ ENT)
```

As the Rx IF frequency is edited the RF frequency will automatically be updated

(Config→Rx→Acq) – DEMOD ACQUISITION RANGE

```
Demod Acquisition Range:
+/- 32 kHz          (▲ ▼ ENT)
```

Edit the acquisition search range of the demodulator (the value entered here determines the amount of frequency uncertainty the demodulator will search over in order to find and lock to an incoming carrier). Editing the value is accomplished by selecting the digit to be edited, using the ◀▶ arrow keys. The value of the digit is then changed using the ▲▼ arrow keys. The user should then press ENT.

The range varies from ± 1 kHz to ± 32 kHz for 70/140 IF, ± 1 kHz to $\pm(\text{symbol rate}/2)$ up to ± 200 kHz for L-Band. For symbol rates < 64 ksps, it will be $\pm(\text{symbol rate}/2)$

The value entered here determines the amount of frequency uncertainty the demodulator will search over in order to find and lock to an incoming carrier.

(Config→Rx→Descram) - DESCRAMBLER

```
Descrambling: Default-On  
IESS-315-On Off      (◀ ▶ ENT)
```

Options are:

Default-On	the appropriate descrambler type is automatically selected.
IESS-315-On	this only applies when Turbo is installed and has been selected as the FEC type.
Off	no descrambling.

As before, the options are displayed all of the time, but the ◀ ▶ arrow keys will force the cursor to skip past an unavailable choice.



The default descrambler types are:

Viterbi, no framing:

Viterbi, EDMAC frame:

Viterbi + RS or TCM/RS:

TPC:

ITU V.35 (Intelsat variant)

Comtech proprietary, frame synchronized

Per IESS-308, frame synchronized

Comtech proprietary, frame synchronized

(Config→Rx→Buf) – RX BUFFER CLOCK SOURCE

```
Rx Buffer: Internal Rx-Sat  
Tx-Terrestrial Ins (◀ ▶, ENT)
```

User will select which Rx buffer clock source. Note that **Tx-Terrestrial** will only be selected if the cards are grouped as modem. Also, note that **External** will only be selected if QDI interface type is selected. Selecting either one will allow the user to select the buffer size as shown below:

```
Rx Buffer Size:  
Disabled      (▲ ▼, ENT)
```

Edit the size, in bits, of the Plesiochronous/Doppler Buffer. The value is changed using the ▲ ▼ arrow keys. The user should then press ENT. Values of **Disabled, ± 512, 1024, 2048, 4096, 8192, and 16384 bits** are possible.

When **Disabled** is selected, the Plesiochronous/Doppler buffer is disabled. The receive clock will then be derived from the satellite signal, and will therefore be subject to clock offsets relative to the local transmit clock, This is due in part to the originating clock

being slightly different from the local clock (a so-called *plesiochronous* offset), and to the motion of the satellite (a *Doppler* offset). The input to the buffer will be the signal from the satellite, with any clock offsets and jitter. The output from the buffer will be derived from the local TRANSMIT clock. In this way, the receive data will be perfectly synchronous with this local clock. The modem operates with independent receive and transmit data rates. Even in this configuration, where RX data rate \diamond TX data rate, the output clock for the buffer will be phase locked to the transmit clock.

While it is only possible to select the size in bits, the corresponding total buffer size is displayed in ms (which will vary in inverse proportion to the data rate).

(Config→Rx→Inv) – RX INVERSION FUNCTIONS

```
Rx Inversion functions:  
Spectrum Data Clock  (< ▶, ENT)
```

Select **Spectrum**, **Data**, or **Clock** using the < ▶ arrow keys, then press **ENT**.
If **Spectrum** is selected, the following sub-menu will be displayed:

Select **Normal** or **Inverted**, using the < ▶ arrow keys, then press **ENT**.

If **Data** is selected, the following sub-menu will be displayed:

```
Rx Data Sense:  
Normal Inverted      (< ▶, ENT)
```

Select **Normal** or **Inverted**, using the < ▶ arrow keys, then press **ENT**.

If **Clock** is selected, the following sub-menu will be displayed:

```
Rx Clock Inversion:  
Normal Inverted      (< ▶, ENT)
```

Select **Normal** or **Inverted**, using the < ▶ arrow keys, then press **ENT**.

(Config→Rx→Misc) – Rx Miscellaneous

```
Rx Misc: EbNo Rxα  
          (< ▶, ENT)
```

Select **EbNo** or **Rxα** using the < ▶ arrow keys, then press **ENT**.

(Config→Rx→Misc→EbNo) - Eb/No ALARM

```
Eb/No Alarm Point:
02.0 dB          (< >, ▲ ▼, ENT)
```

Edit the Eb/No alarm point. This is accomplished by selecting the digit to be edited, using the < > arrow keys. The value of the digit is then changed using the ▲ ▼ arrow keys. The user should then press ENT.

The range of values is from 2.0 to 16.0 dB. The user may select a value here, and if the Eb/No falls below this value, a receive traffic fault will be generated.

(Config→Rx→Misc→Rxα) – RX Roll-Off (α) factor

```
Rx Roll-off: 20% 35%
              (< >, ENT)
```

Select 20% or 35%, using the < > arrow keys, then press ENT. The default is 35%.

(Config→Rx→CnC) – CARRIER-IN-CARRIER®

```
Carrier-in-Carrier (CnC):
Mode FrqOffs SrchDelay ReAcq
```

Select **Mode**, **FrqOffs**, **SrchDelay**, or **ReAcq** using the ◀▶ arrow keys, then press ENT. The user will then be taken to a further sub-menu. Each of these choices is described briefly in the table below:

Mode	(Mode of Operation) This sub-menu permits the user to select the mode of operation for the CnC™.
FrqOffs	(Frequency Offset) This sub-menu permits the user to adjust the frequency offset for the CnC™.
SrchDelay	(Search Delay) This sub-menu permits the user to configure the search delay parameters for the CnC™.
ReAcq	(ReAcquisition Time) This permits the user to set the re-acquisition time in seconds when the desired carrier is lost.

(Config→Rx→CnC→Mode) – CnC® MODE OF OPERATION

```
CnC Mode: Off On
          (< >, ENT)
```

Select **Off**, or **On** using the ◀▶ arrow keys, then press **ENT**. The user will then be taken to a further sub-menu. If CnC **On** is selected, there will be some messages at the front panel as shown below:

```
LOADING CnC SAT SEARCH...
...PLEASE WAIT!
```

```
CnC SEARCH IS PROCESSING...
...PLEASE WAIT!
```

If CnC is successful, it will display as follows:

```
CnC SEARCH SUCCESSFUL!
Delay=239ms   Offset=+001.0k
```

If CnC is not successful, it will display this:

```
CnC SEARCH IS UNRESOLVED!
PLEASE CHECK TX POWER LEVEL
```

(Config→Rx→CnC→FrqOffs) – CnC FREQUENCY OFFSET

```
CnC Frequency Offset:
+/-015          (▲ ▼ ENT)
```

Edit the CnC Frequency Offset. The value of the digit is changed using the ▲▼ arrow keys. The user should then press **ENT**.

(Config→Rx→CnC→SrchDelay) – CnC SEARCH DELAY

```
CnC Min/Max Delay (ms):  
Min=000 Max=290 (◀ ▶, ▲ ▼, ENT)
```

Edit the Min/Max Search Delay in milliseconds by selecting the digit to be edited, using the ◀▶ arrow keys. The value of the digit is then changed using the ▲▼ arrow keys. The user should then press ENT.

(Config→Rx→CnC→ReAcq) – CnC RE-ACQUISITION TIME

```
CnC Re-Acquisition Time:  
120 seconds (◀ ▶, ▲ ▼, ENT)
```

Edit the re-acquisition time using the ◀▶▲▼ arrow keys. The user should then press ENT.

5.6.1.4 (Config→Group) – GROUPING MOD/DEMODO CARDS

If **Group** is selected:

```
Grouping:  
Modem   Redundancy   (◀ ▶, ENT)
```

Enter **Modem** to group a vertically aligned modulator and demodulator into a modem. The Device Selection screen should indicate either one of the devices that is to be grouped.

Enter **Redundancy** to designate the backup for a redundant group. The Device Selection screen should indicate the device to become the backup.

(Config→Group→Modem)

```
Modem Group:  
Separate Grouped   (◀ ▶, ENT)
```

If there is a vertically aligned modulator demodulator pair with the modulator in the top position, then the Modem selection is allowed. The selection applies to the pair of which one is currently selected in the device select area.

Once grouped, the modulator demodulator pair can be configured as a single device.

(Config→Group→Redundancy)

```
Redundancy: Config Mode
                (◀ ▶, ENT)
```

Selecting “**Config**” allows the user to set redundancy either 1:1, 1:2, 1:3, or none. Redundancy is a FAST option and needs to be purchased to turn on this feature. Selecting

“**Mode**” allows the unit to do auto or manual switching between prime and back-up device.

(Config→Group→Redundancy→Config)

```
Config Redundancy:
None 1:1 1:2 1:3      (◀ ▶, ENT)
```

If **None** is selected, it turns off redundancy.

(Config→Group→Redundancy→Config →1:1)

Selecting the **1:1** entry configures 1:1 redundant modem. Modulators are required in the top two slots, and demodulators in the bottom two. Without the proper hardware and FAST option enabled, the ◀▶ arrow keys will force the cursor to skip past the unavailable choice. The backup modem is installed in slot #3 and slot #4. The user can also do 1:1 Tx or 1:1 Rx. For ungrouped scenario, the backup card is always installed in slot #4.

(Config→Group→Redundancy→Config →1:2)

For 1:2 case, the backup is always installed in slot #4. This is only applicable for ungrouped scenario (no modem), that means, 1:2 Tx or 1:2 Rx.

(Config→Group→Redundancy→Config →1:3)

For 1:3 case, the backup is always installed in slot #4. This is only applicable for ungrouped scenario (no modem), that means, 1:3 Tx or 1:3 Rx.

(Config→Group→Redundancy→Mode)

```
Redundancy Mode:
Manual Auto      (< >, ENT)
```

Default is “Manual”. If “Auto” is selected, that means the back-up will automatically take over once the designated prime is faulted, and vice-versa. If “Manual” is selected, when the prime is faulted, the back up will not take over. Also, the user will have the option to do force switching.

(Config→Group→Redundancy→Mode→Manual)

```
Redundancy Manual Mode:
Forced-Backup = Slot#1 (▲▼, ENT)
```

If redundancy is configured (e.g. 1:1), force-backup menu will appear which will allow the user to do force switching between back up and designated primary device.

5.6.1.5 (Config→Frame) – FRAMING MODE

```
Framing Mode:  Unframed EDMAC
EDMAC-2  D&I++      (< >, ENT)
```

Framing requires a modulator/demodulator pair grouped into a modem (see **Config→Group**).

Select **Unframed**, **EDMAC**, **EDMAC-2**, or **D&I++** using the < > arrow keys, then press **ENT**.

The sub-branches available are:

(Config→Frame→Unframed) - UNFRAMED

No framing is selected. No overhead is added, and the unit will be compatible with other manufacturer’s equipment, when operating in a ‘standard’ configuration.

(Config→Frame→EDMAC, or Config→Frame→EDMAC-2) - EDMAC or EDMAC-2

Comtech EF Data proprietary framing is included. The framing permits the bi-directional passing of M&C and AUPC data between local and distant-end units. **EDMAC** is backwards compatible with the CDM-500, CDM-550, CDM-550T, CDM-600 and CDM-600L. **EDMAC-2** is a reduced overhead version of EDMAC, and is not backwards compatible with the modems listed above.

If **either** of these modes is selected, the following sub-menu will be displayed:

```
Framing mix:  AUPC-Only  
AUPC+EDMAC      (< >,
```

Select either **AUPC-Only** (default) or **AUPC+EDMAC**, using the ◀ ▶ arrow keys, then press **ENT**.

Note that if framing is enabled (either **EDMAC** or **EDMAC-2**), then **AUPC** is automatically enabled, but the specific EDMAC feature (passing M&C data from a local to a distant-end unit) needs to be enabled here.

If **AUPC-Only** is selected then none of the EDMAC features are available, even though framing will still be enabled.

If **AUPC+EDMAC** is selected, the user is further prompted to select whether the unit is an EDMAC master, or an EDMAC slave:

(Config→Frame→EDMAC→AUPC+EDMAC, or Config→Frame→EDMAC-2→AUPC+EDMAC) - AUPC+EDMAC MODE

```
EDMAC Mode:  
Master  Slave      (< >, ENT)
```

Select either **MASTER** or **SLAVE**, using the ◀ ▶ arrow keys, then press **ENT**.

An EDMAC **MASTER** is a unit which is local to the M&C computer, and which passes messages, via the overhead, to a distant-end modem.

An EDMAC **SLAVE** is a unit that is not local to the M&C computer, which is at the distant-end of a satellite link. If **MASTER** is selected then the following sub-menu is displayed:

```
Distant-end Base Address
0240      (◀ ▶, ▲ ▼, ENT)
```

Edit the address of the distant-end modem that this unit will pass messages to. This is accomplished by selecting the digit to be edited, using the ◀ ▶ arrow keys. The value of the digit is then changed using the ▲ ▼ arrow keys. The user should then press ENT.

There is a restriction on values that can be entered here - they may only be in increments of 10. This is automatically taken care of - the user may not edit the last digit of the address. This has been implemented so that a single MASTER may pass messages for up to 10 devices at the distant end. The valid range of addresses is from 10 to 9990.

But if SLAVE is selected, then the following sub-menu is displayed:

```
Address of this Slave
Unit: 0241      (◀ ▶, ▲ ▼, ENT)
```

Edit the address of this SLAVE unit. This is accomplished by selecting the digit to be edited, using the ◀ ▶ arrow keys. The value of the digit is then changed using the ▲ ▼ arrow keys. The user should then press ENT. The valid range of addresses is from 1 to 9999, although 'base 10' values will be automatically skipped.



Remember that this is a unit that is intended to be located at the distant-end of a link, and will therefore be under the control of a MASTER at the other end. This is the equivalent of putting the unit into Remote Control mode - no local control is possible.

(Config→Frame→D&I++) – D&I++

If D&I++ is selected, the following sub-menu will be displayed:

```
Drop & Insert: EDMAC
Drp-CH/TS  Ins-CH/TS (◀ ▶, ENT)
```

If Drp-CH/TS is selected, the Tx Data Rate will be displayed.

If the Ins-CH/TS is selected the Rx data rate will be displayed.

5.6.1.6 (Config→Interface) – DATA INTERFACE

Data interface for each card (modulator or demodulator) is auto detected. If grouped as a modem, the operating data interface will be the one installed in the demod card (interface on the modulator is not required). If a QDI interface is installed and a modem is grouped, then either it or the interface installed on the Demod can be selected. The card can support one of the following:

- RS-422 (RS-530)
- V.35
- RS-232
- G.703 (for single T1 or E1)
- HSSI
- QDI (Quad Drop & Insert)

The blinking cursor will point to the supported data interface for the card being installed, then press **ENT**

```
Interface: RS422 V.35 RS232
HSSI ASI G.703 QDI NONE
```

If grouped as a modem and RS422, V.35 or RS232 are selected, the following sub menu will be displayed:

```
RTS/CTS operation: (▲ ▼, ENT)
Loop,RTS Controls Tx Out
```

The option is changed using the ▲▼ arrow keys. The user should then press **ENT**. The following options are possible:

RTS/CTS Loop, No Action	RTS and CTS are looped, so that CTS echoes the state of RTS, but RTS does not control the ON/OFF state of the carrier.
Loop, RTS Controls Tx Out	RTS and CTS are looped, so that CTS echoes the state of RTS, and RTS controls the ON/OFF state of the carrier (in other words, the modem will not bring up its TX carrier until RTS is asserted).
Ignore RTS, Assert CTS	RTS is ignored, and CTS is asserted unconditionally.

If **HSSI** is selected, the following sub menu will be displayed:

```
HSSI Mode Select:  (▲ ▼, ENT)
TA to CA Loop
```

The option is changed using the ▲▼ arrow keys. The user should then press **ENT**. The following options are possible:

TA to CA Loop	TA and CA are looped, but TA does not control the ON/OFF state of the carrier.
RR controls CA, TA controls Tx Out	TA controls the ON/OFF state of the carrier (in other words, the modem will not bring up its TX carrier until TA is asserted).

If **G.703** is selected, the following sub menu will be displayed:

```
G.703 Type:  T1 E1-Balanced
E1-Unbalanced  (◀ ▶,
```

If G.703 balanced interface, the user can select either **T1** or **E1-Balanced**. If G.703 unbalanced interface, the user can select either **T1** or **E1-Unbalanced**. Use the ◀ ▶ arrow keys to select, then press **ENT**.

If **T1** is selected, the following sub-menu will be displayed:

```
T1 Configuration:
Length Line-Code  (◀ ▶, ENT)
```

Select **Length** or **Line Code** using the ◀ ▶ arrow keys, then press **ENT**.

If **Line -Code** is selected, the following sub-menu will be displayed:

```
G.703 T1 Line Code:
HDB3  AMI  (◀ ▶, ENT)
```

Select **HDB3** or **AMI** using the ◀ ▶ arrow keys, then press **ENT**.

If **Length** is selected, the following sub-menu will be displayed:

```
T1 Line Length:
000-133 feet      (▲ ▼,
```

Edit the line length using the ▲▼ arrow keys, then press **ENT**. Values will toggle between the following values:

0-133, 133-266, 266-399, 399-533, and 533-655 feet.

If either **E1-Balanced** or **E1-Unbalanced** is selected, the following sub-menu will be displayed:

Select **HDB3** or **AMI** using the ◀ ▶ arrow keys, then press **ENT**.

```
G.703 E1 Line Code:
HDB3   AMI      (◀ ▶, ENT)
```

If **QDI** is selected, the following sub-menu will be displayed:

```
QDI Tributary Ports:
1  2  3  4      (◀ ▶, ENT)
```

In this sub menu, the user can select one of the four (4) ports to be configured. Choosing either one of them will display the next sub-menu as follows:

```
Port#X: Drop Insert LineCode
        Alarm      (◀ ▶, ENT)
```

Where X is the tributary port number. If **Drop** is selected, the next sub-menu will be

```
Port#X Tx Trib Rate:(▲▼, ENT)
01536.000kbps      (24x64kbps)
```

This sub-menu shows the Nx64kbps data rate where N=24 in this example. Use ▲▼ arrow keys to set the data rate. After pressing ENT, a sub-menu will appear as shown:

```
Px D-CH: 1  2  3  4  5  6 ▶
        TS: 11 02 06 04 05 03
```

Where x is the tributary port number. A ▶ display means that there are more channels beyond channel 6 as in this example. Use right arrow key ▶ to view more. sure that **ENT** key is pressed once it's done.

If **Insert** is selected, the sub-menu will display:



```
Port#X Rx Trib Rate: (▲▼, ENT)
01536.000kbps      (24x64kbps)
```

This is similar to the drop-side. Upon setting the data rate, a sub-menu will appear as shown:

```
Px I-CH: 1 2 3 4 5 6 ►
      TS: 11 02 06 04 05 03
```

This is similar to the drop-side except that this is done at the Rx side. Please make sure that **ENT** key is pressed once it's done.

If **LineCode** is selected, the next sub-menu will be displayed:

```
Port#X Line Code:
HDB3  AMI          (◀ ▶, ENT)
```

Select **HDB3** or **AMI** using the ◀ ▶ arrow keys, then press **ENT**.

If **Alarm** is selected, the sub-menu will display

```
Port#X Bipolar Violation:
Active Masked      (◀ ▶, ENT)
```

Default is **Masked**.

5.6.1.7 (Config→Ref) - REFERENCE OSCILLATOR

The modem can accept an externally supplied frequency reference, using the BNC connector on the rear panel. However, rather than bypassing the internal reference, and substituting the external signal, the internal reference is used in a low-bandwidth (~ 2Hz) phase-locked loop (PLL), so the modem actually phase locks to the reference external signal. There are two distinct advantages to this scheme:

- a. It permits hitless switching between the operation of internal and external reference. There are no sudden discontinuities of frequency and phase in the transmitted carrier.
- b. Due to the very low bandwidth of the PLL, it permits the external reference to have an inferior phase noise characteristic than the internal reference of the modem. The narrow loop essentially ‘cleans up’ the external signal. This is particularly important if the modem is being used to supply a 10MHz reference to a BUC or LNB.

Edit the configuration and value of the frequency reference. The value is changed using the ▲▼ arrow keys. The user should then press ENT. Values of **Internal 10 MHz**, **External 01 MHz**, **External 02 MHz**, **External 05 MHz**, **External 10 MHz**, **External 20 MHz**, **Out Int. 10 MHz**, and **Auto** are possible.

The user should then press ENT. Two examples are shown below:

```
Frequency Reference:  
Internal 10 MHz      (▲ ▼, ENT)
```

```
Frequency Reference:  
External 05 MHz     (▲ ▼, ENT)
```

5.6.1.8 (Config→Mask) - MASK

Select **Transmit**, **Receive** or **Reference**, using the ◀ ▶ arrow keys, then press ENT.

```
Alarm Mask: Transmit Receive  
Reference BUC LNB (◀ ▶, ENT)
```

If **Transmit** is selected the following sub-menu will be displayed:

```
Tx Alarm Mask: Tx-FIFO
G.703-BPV Tx-AIS  (< > ENT)
```

Select **Tx-FIFO**, **G.703-BPV**, or **Tx-AIS**, using the < > arrow keys, then press **ENT**. For **each** of the choices a sub-menu similar to the one shown below will be shown:

```
Tx-FIFO Alarm:
Active Masked    (< > ENT)
```

Select **Active** or **Masked**, using the < > arrow keys, then press **ENT**.

If the user selects **Active**, then a Transmit Traffic fault will be generated whenever the transmitter sees that the transmit FIFO has slipped.

Similarly, the user can mask a G.703 BPV or Transmit AIS alarm.

If the user selects **Masked**, no alarm will be generated.

If **Receive** is selected the following sub-menu will be displayed:

```
Rx Alarm Mask: AGC Eb/No
Rx-AIS Buffer    (< > ENT)
```

Select **AGC**, **Eb/No**, **Rx-AIS** or **Buffer**, using the < > arrow keys, then press **ENT**. For **each** of the choices a sub-menu similar to the one shown below will be shown:

```
AGC Alarm:
Active Masked  (< > ENT)
```

Select **Active** or **Masked**, using the < > arrow keys, then press **ENT**.

If the user selects **Active**, then a Receive Traffic fault will be generated whenever the demodulator sees that the composite input level being applied will cause compression in the IF stages, and hence degrade the performance of the demodulator.

Similarly, the user can mask an Eb/No, Receive AIS or Buffer alarm.

If the user selects **Masked**, no alarm will be generated.

If **Reference** is selected the following sub-menu will be displayed:

```
Reference Alarm:
Active Masked      (< ▶ ENT)
```

Select **Active** or **Masked**, using the < ▶ arrow keys, then press **ENT**.

If the user selects **Active**, then a unit fault will be generated whenever the unit sees:

1. External Reference is selected
2. There is no signal activity at the external reference port

If the user selects **Masked**, no alarm will be generated.

If **BUC** is selected the following sub-menu will be displayed:

```
BUC Alarm:
Active Masked      (< ▶ ENT)
```

Select **Active** or **Masked**, using the < ▶ arrow keys, then press **ENT**.

If **LNB** is selected the following sub-menu will be displayed:

```
LNB Alarm:
Active Masked      (< ▶ ENT)
```

Select **Active** or **Masked**, using the < ▶ arrow keys, then press **ENT**.

5.6.1.9 (Config→ODU) – OUTDOOR UNIT (for L-Band Unit Only)

```
ODU (Outdoor Unit) :
BUC  LNB           (◀ ▶ ENT)
```

The **ODU** (Outdoor Unit) menu permits the user to choose between controlling and monitoring either a **BUC** (Block Upconverter) or an **LNB** (Low-noise Block downconverter). Select **BUC** or **LNB**, using the ◀ ▶ arrow keys, then press **ENT**.

(Config→ODU→BUC) – BLOCK UPCONVERTER (BUC)

If **BUC** is selected, the following sub-menu is displayed:

```
BUC:M&C-FSK DC-Pwr 10MHz
Alarm Delay LO Mix (◀ ▶ ENT)
```

Select **M&C-FSK**, **DC-Pwr**, **10MHz**, **Alarm**, **Delay**, **LO**, or **Mix**, using the ◀ ▶ arrow keys, then press **ENT**.

M&C-FSK	If an FSK-capable BUC is employed, this menu provides access to a further set of menus that define the FSK setup, and use it for control and monitor.
DC-Pwr	(DC POWER) If a BUC supply is installed this menu permits the user to turn DC power ON or OFF.
10MHz	This menu permits the user to turn the 10MHz frequency reference for the BUC ON or OFF.
Alarm	This menu permits the user to define the upper and lower limits for a current 'window'. If the measured BUC current falls outside this window, an alarm is generated.
Delay	This menu permits the user to define the carrier-on delay following a power-up sequence.
LO	This menu permits the user to define the LO frequency used in the BUC. This is then used in the display of RF frequency in the Config→Tx→Freq menu.
Mix	This menu permits the user to define the sense of the frequency translation – either high-side mix or low-side mix.

(Config→ODU→BUC→M&C-FSK) - M&C FSK

If **M&C-FSK** is selected, the following sub-menu is displayed:

```
BUC M&C-FSK: Comms Address
Tx-On/Off      (< ▶, ENT)
```

Select **Comms**, **Address**, **Tx-On/Off**, or **Pwr-Level**, using the ◀ ▶ arrow keys, then press **ENT**.

Comms	If an FSK-capable BUC is employed, this menu turns the FSK between the modem and BUC either ON or OFF.
Address	(Address) This menu permits the user to enter the logical address of the BUC, from 1 to 15.
TX-On/Off	This menu permits the user to turn the RF Output of the BUC ON or OFF.

(Config→ODU→BUC→M&C-FSK→Address) – FSK COMMS

If **Comms** is selected, the following sub-menu is displayed:

```
BUC M&C FSK Comms :
On  Off             (< ▶, ENT)
```

Select **On** or **Off**, using the ◀ ▶ arrow keys, then press **ENT**.

(Config→ODU→BUC→M&C-FSK→Address) – FSK ADDRESS

If **Addr** is selected, the following sub-menu is displayed:

```
BUC FSK Address: 01
                  (▲▼, ENT)
```

Edit the value of the address using the ▲ ▼ arrow keys, then press **ENT**. The valid range is from 01 to 15.

(Config→ODU→BUC→M&C-FSK→Tx-On/Off) - FSK TX-ON/OFF

If **Tx-On/Off** is selected, the following sub-menu is displayed:

```
BUC RF Output:
On  Off          (◀ ▶, ENT)
```

Select **On** or **Off**, using the ◀ ▶ arrow keys, then press **ENT**.

(Config→ODU→BUC→DC-Pwr) - BUC DC POWER

If **DC-Pwr** is selected, the following sub-menu is displayed:

```
BUC DC Power:
On  Off          (◀ ▶, ENT)
```

Select **On** or **Off**, using the ◀ ▶ arrow keys, then press **ENT**.

(Config→ODU→BUC→10MHz) – BUC 10MHz

If **10MHz** is selected, the following sub-menu is displayed:

```
BUC 10MHz Reference:
On  Off          (◀ ▶, ENT)
```

Select **On** or **Off**, using the ◀ ▶ arrow keys, then press **ENT**.

(Config→ODU→BUC→Alarm) - BUC ALARM

If **Alarm** is selected, the following sub-menu is displayed:

```
Set BUC Current Alarm:
Upper Lower      (◀ ▶, ENT)
```

Select **Upper** or **Lower**, using the ◀ ▶ arrow keys, then press **ENT**.

If **Upper** is selected, the following sub-menu is displayed:

```
BUC Current Alarm Upper  
Limit:1200mA      (< ▶,▲▼, ENT)
```

Edit the BUC Current Alarm Upper limit. This is accomplished by selecting the digit to be edited, using the ◀▶ arrow keys. The value of the digit is then changed using the ▲▼ arrow keys. The user should then press **ENT**. The range of current is from 500 to 4000 mA.

If **Lower** is selected, the following sub-menu is displayed:

```
BUC Current Alarm Lower  
Limit:1200mA      (< ▶,▲▼, ENT)
```

Edit the BUC Current Alarm Lower limit. This is accomplished by selecting the digit to be edited, using the ◀▶ arrow keys. The value of the digit is then changed using the ▲▼ arrow keys. The user should then press **ENT**. The range of current is from 100 to 3000 mA.

(Config→ODU→BUC→Delay) - BUC DELAY

If **Delay** is selected, the following sub-menu is displayed:

```
BUC Power-On Delay:  
001 seconds      (< ▶▲ ▼ ENT)
```

Edit the value of the power-on delay. This is accomplished by selecting the digit to be edited, using the ◀▶ arrow keys. The value of the digit is then changed using the ▲▼ arrow keys. The user should then press **ENT**. The valid range is from 0 to 999 seconds.

(Config→ODU→BUC→LO) - BUC LO

If **LO** is selected, the following sub-menu is displayed:

```
BUC LO Frequency:
12000 MHz          (◀ ▶ ▲ ▼ ENT)
```

Edit the value of the BUC LO frequency. This is accomplished by selecting the digit to be edited, using the ◀▶ arrow keys. The value of the digit is then changed using the ▲▼ arrow keys. The user should then press **ENT**. The valid range is from 0 to 35000 MHz.

Note that this value is used for displaying the RF frequency of the modem/BUC combination. If a value of 00000 is entered here (the default) then no RF frequency will be displayed on the **Config→Tx→Freq** menu.

(Config→ODU→BUC→Mix) – BUC MIX

If **Mix** is selected, the following sub-menu is displayed:

```
BUC Frequency Mix:
High-Side Low-Side  (◀ ▶ ENT)
```

Select **High-Side** or **Low-Side**, using the ◀ ▶ arrow keys, then press **ENT**.

(Config→ODU→LNB) LNB

If **LNB** is selected, the following sub-menu is displayed:

```
LNB: DC-Voltage 10MHz Alarm
LO Mix          (◀ ▶, ENT)
```

Select **Voltage**, **Power-On/Off**, **10MHz**, **Alarm**, **LO** or **Mix**, using the ◀ ▶ arrow keys, then press **ENT**.

Voltage	Selects 13 or 18 Volts as the LNB power supply output voltage.
10MHz	This menu permits the user to turn the 10MHz frequency reference for the BUC ON or OFF.
Alarm	This menu permits the user to define the upper and lower limits for a current 'window'. If the measured LNB current falls outside this window, an alarm is generated.
LO	This menu permits the user to define the LO frequency used in the LNB. This is then used in the display of RF frequency in the Config→Rx→Freq menu.
Mix	This menu permits the user to define the sense of the frequency translation – either high-side mix or low-side mix.

(Config→ODU→LNB→Voltage) - LNB VOLTAGE

If **Voltage** is selected, the following sub-menu is displayed:

```
LNB DC Supply Voltage:
Power Off          (▲▼, ENT)
```

Edit the value of the LNB supply voltage, using the ▲▼ arrow keys. The user should then press **ENT**. The choices are 13 or 18 Volts.

(Config→ODU→LNB→Power-On/Off) – LNB POWER-ON/OFF

If **Power-On/Off** is selected, the following sub-menu is displayed:

```
LNB Power :  
On  Off          (< ▶ ENT)
```

Select **On** or **Off**, using the < ▶ arrow keys, then press **ENT**.

(Config→ODU→LNB→10MHz) - LNB 10MHz

If **10MHz** is selected, the following sub-menu is displayed:

```
LNB 10MHz Reference :  
On  Off          (< ▶ ENT)
```

Select **On** or **Off**, using the < ▶ arrow keys, then press **ENT**.

(Config→ODU→LNB→Alarm) - LNB ALARM

If **Alarm** is selected, the following sub-menu is displayed:

```
Set LNB Current Alarm :  
Upper  Lower    (< ▶ ENT)
```

Select **Upper** or **Lower**, using the < ▶ arrow keys, then press **ENT**.

If **Upper** is selected, the following sub-menu is displayed:

```
LNB Current Alarm Upper  
Limit: 200mA    (< ▶ ▲ ▼ ENT)
```

Edit the LNB Current Alarm Upper limit. This is accomplished by selecting the digit to be edited, using the <▶ arrow keys. The value of the digit is then changed using the ▲▼ arrow keys. The user should then press **ENT**. The range of current is from 50 to 600 mA.

If **Lower** is selected, the following sub-menu is displayed:

```
LNB Current Alarm Lower
Limit: 050mA      (< ▶ ▲ ▼ ENT)
```

Edit the LNB Current Alarm Lower limit. This is accomplished by selecting the digit to be edited, using the ◀▶ arrow keys. The value of the digit is then changed using the ▲▼ arrow keys. The user should then press **ENT**. The range of current is from 10 to 400 mA.

(Config→ODU→LNB→LO) LO

If **LO** is selected, the following sub-menu is displayed:

```
LNB LO Frequency:
12000 MHz      (< ▶ ▲ ▼ ENT)
```

Edit the value of the LNB LO frequency. This is accomplished by selecting the digit to be edited, using the ◀▶ arrow keys. The value of the digit is then changed using the ▲▼ arrow keys. The user should then press **ENT**. The valid range is from 0 to 35000 MHz.

Note that this value is used for displaying the RF frequency of the modem/BUC combination. If a value of 00000 is entered here (the default) then no RF frequency will be displayed on the **Config→Rx→Freq** menu.

(Config→ODU→LNB→Mix) MIX

If **Mix** is selected, the following sub-menu is displayed:

```
LNB Frequency Mix:
High-Side Low-Side  (< ▶ ENT)
```

Select **High-Side** or **Low-Side**, using the ◀ ▶ arrow keys, then press **ENT**.

5.6.2 MONITOR

```
MONITOR: Alarms  Rx-Params  
Event-Log Stats AUPC CnC ODU
```

Select **Alarms**, **Rx-Params**, **Event-Log**, **Stats**, **AUPC**, **CnC** or **ODU** using the ◀ ▶ arrow keys, then press **ENT**. The **ODU** menu will only appear for 70/140MHz units.

If the user selects **Alarms**, the following sub-menu is displayed:

5.6.2.1 (Monitor→Alarms) ALARMS



The modem uses a system of Fault Prioritization. In each category of fault, only the highest priority fault is displayed. For instance, if the demodulator is unlocked, it is irrelevant if there are other receive faults present. If the demodulator then locks, but there is a fault of a lower priority present, this will then be displayed. This also holds true for the faults reported via the remote control. This system cuts down drastically on unwanted and irrelevant fault reporting. A comprehensive list of faults is shown at the end of this section.

```
Live Alarms: Transmit  
Receive Unit ODU (◀ ▶, ENT)
```

Select **Transmit**, **Receive**, or **Unit** using the ◀ ▶ arrow keys, then press **ENT**. Depending on the choice, one of the following menus will be shown:

(Monitor→Alarms→Unit) – UNIT ALARMS

```
Unit Fault: -12 Volt PSU  
is under voltage (ENT)
```

The screen will indicate if there are any Unit Faults. If not, it will display **'None'**. Pressing **ENT** takes the user back to the previous menu.

(Monitor→Alarms→Receive) – RECEIVE ALARMS

```
Rx Traffic: AGC Alarm -  
Reduce Input level      (ENT)
```

The screen will indicate if there are any Receive Traffic Faults. If not, it will display 'None'. Pressing ENT takes the user back to the previous menu.

(Monitor→Alarms→Transmit) - TRANSMIT ALARMS

```
Tx Traffic: No Tx Clock  
From Terrestrial      (ENT)
```

The screen will indicate if there are any Transmit Traffic Faults. If not, it will display 'None'. Pressing ENT takes the user back to the previous menu.

(Monitor→Alarms→ODU) – OUTDOOR UNIT ALARMS

The screen will indicate if there are any ODU Alarms. If not, it will display 'None'. Pressing ENT takes the user back to the previous menu.

5.6.2.2 (Monitor→Rx-Params) – RECEIVE-PARAMETERS

If the user selects **Rx-Params**, the following sub-menu is displayed:

```
EbNo=05.7dB  BER=3.4E-9
ΔF=+11.7k  Buf=50%  RSL=-24dBm
```

If the demodulator is locked, this screen shows the following:

Eb/No	This shows the value of Eb/No calculated by the demodulator. The value referred to here is the energy per information bit (Ebi), divided by the noise spectral density (No).
BER	This is an estimate of the corrected BER.
ΔF	The frequency offset of the received carrier, in kHz, with a displayed resolution of 100 Hz.
Buf	(Buffer fill state) This shows the fill state (in percent), of the receive Buffer. After a reset, it will read 50. A value <50 indicates that the buffer is emptying, and >50 indicates that it is filling.
RSL	(Receive Signal Level) A value in dBm, indicating the input power of the desired carrier, as seen by the demodulator. If the signal level is below the AGC range of the demod, this will display RSL <-99

If the demodulator is not locked, this screen shows the message “**Demod: Not Locked**”, but continuing to display receive signal level the Pressing **ENT** or **CLR** will take the user back to the previous menu.

```
Demodulator: Not Locked
ΔF=+11.7k  RSL=-24dBm
```

5.6.2.3 (Monitor→Event-Log) – EVENT-LOG or STORED EVENTS

If the user selects **Event-Log**, the following sub-menu is displayed:

```
Stored Events:
View  Clear-All      (◀ ▶, ENT)
```

Select **View** or **Clear-All**, using the ◀ ▶ arrow keys, then press **ENT**.

If the user selects **View**, the following screen is displayed:

```
Log 023: 30/11/02 10:37:32
Fault - Demod Lock (3) (▲▼, ENT)
```

In this example, the demodulator installed in slot #3 is faulted on Nov. 30, 2002 at 10:37:32 with log number 23.

(Monitor→Event-Log→View) – VIEW STORED EVENTS

The user may scroll backwards or forwards through the entries in the event log, using the ▲▼ arrow keys. Pressing ENT or CLR will take the user back to the previous menu. The event log can store up to 255 events. When a fault condition occurs, it is time-stamped and put into the log. Similarly, when the fault condition clears, this is also recorded, as shown below:

```
Log 024: 30/11/97 10:37:35
Clear - Demod Lock (3) (▲▼, ENT)
```

If the user selects **Clear-All**, the event log is cleared, and the user is taken directly back to the previous menu. However, if there are faults present on the unit at this time, they will be re-time-stamped, and new log entries will be generated.



IMPORTANT: *Note that in accordance with international convention, the date is shown in DAY-MONTH-YEAR format.*

5.6.2.4 (Monitor→Stats) – LINK STATISTICS (for grouped as modem only)

If the user selects **Stats**, the following sub-menu is displayed:

```
Link Statistics:  View
Clear-All  Config    (◀ ▶, ENT)
```

Select **View**, **Clear-All**, or **Config**, using the ◀ ▶ arrow keys, then press **ENT**.

(Monitor→Stats→View) – VIEW LINK STATISTICS

If the user selects **VIEW**, the following screen is displayed:

```
Sta198: 02/11/02 10:37:32
16.0, 16.0, 9.0, 9.0 (▲▼, ENT)
```

The user may scroll backwards or forwards through the entries in the statistics log, using the ▲▼ arrow keys. Pressing **ENT** or **CLR** will take the user back to the previous menu. The event log can store up to 250 events.

The top line of the display indicates the log entry number, and the time and date of the entry. Note that in accordance with international convention, the date is shown in DAY-MONTH-YEAR format.

The bottom line of the display shows the statistics data that has been measured and recorded.

The meaning and format of the numbers is as follows:

Minimum Eb/No, Average Eb/No, Maximum TPLI, Average TPLI

(where TPLI means Transmit Power Level increase, if AUPC is enabled).

The user defines a measurement interval (see **Monitor→Stats→Config**) and during this interval, Eb/No and TPLI are observed, at a one second rate. At the end of this period, the average Eb/No is calculated and recorded, and the minimum value seen in the interval. Similarly, the average TPLI is calculated, along with the highest value seen in the interval.

Notes: If the demod has lost lock during the measurement interval, the minimum Eb/No will show 'Loss' rather than indicate a value. However, the average value (while the demod was locked) will still be calculated and shown. If, on the other hand, the demodulator has been unlocked for the entire measurement interval, the average Eb/No will also show 'Loss'. (The display will show 'Loss, Loss'.)

If the measured values are greater than, or equal to 16.0 dB, the display will show 16.0 dB. If AUPC is not enabled, the values of maximum and average TPLI will both show 'Off'.

Examples:

08.0, 13.5, 2.5, 1.8 means:

Minimum Eb/No observed in the measurement interval = 8.0 dB

Average Eb/No observed in the measurement interval = 13.5 dB

Maximum TPLI observed in the measurement interval = 2.5 dB

Average TPLI observed in the measurement interval = 1.8 dB

Loss, 04.5, Off, Off means:

There was a loss of demod lock during the measurement interval

Average Eb/No observed in the measurement interval = 4.5 dB

Maximum TPLI observed in the measurement interval = AUPC disabled

Average TPLI observed in the measurement interval = AUPC disabled

If the user selects **Config**, the following sub-menu is displayed:

(Monitor→Stats→Clear-All) – CLEAR ALL STATS

If the user selects **Clear-All**, the statistics log is cleared, and the user is taken directly back to the previous menu.

```
Clear all Stored Stats?  
No  Yes          (▲▼, ENT)
```

If the user selects **Config**, the following sub-menu is displayed:

(Monitor→Stats→Config) – CONFIGURE STATS

```
Stats Logging Interval:  
Disabled          (▲▼, ENT)
```

The user is prompted to enter the logging interval (the period of time over which the statistics will be measured), using the ▲▼ arrow keys, then press **ENT**. The user can choose **Disabled, 10, 20, 30, 40, 50, 60, 70, 80, or 90 minutes**.

```
Stats Logging Interval:  
30 minutes       (▲ ▼ ENT)
```

5.6.2.5 (Monitor→AUPC) – MONITOR AUPC(for grouped as modem only)

If **AUPC** is selected, and the modem is not in Framed mode, the following sub-menu is displayed:

```
Framing is required for  
AUPC Monitor (ENT or CLR)
```

If **AUPC** is selected, and the modem is in Framed mode, the following sub-menu is displayed:

```
AUPC:Remote EbNo = 14.0dB  
TX Power Increase = 2.2dB
```

The top line displays the value of Eb/No of the demodulator at the distant end of the satellite link. The Eb/No will display **Unlock** if the remote demod is unlocked. The bottom line shows how much the AUPC system has increased the output power. If AUPC is not enabled, the value of **Tx Power Increase** will show as 0.0 dB.

5.6.2.6 (Monitor→CnC) – MONITOR CARRIER-IN-CARRIER (CnC™) (for grouped as modem only)

If **CnC** is selected, and the CnC is not locked, it will display as follows:

```
Carrier-in-Carrier (CnC)  
is not locked
```

If CnC is locked, it will display as follows:

```
CnC:Dly=000,239µs Δf=+001.0k  
Eb/No=12.0dB Ratio=+01dB
```

Some definitions:

Dly = delay of interferer in microseconds.

Δf = frequency offset of interferer in kHz.

Eb/No = Eb/No estimate in dB

Ratio = interferer-to-desired carrier level ratio in dB

5.6.2.7 (Monitor→ODU) – MONITOR ODU (for L-Band Unit only)

If **ODU** is selected, the following sub-menu is displayed:

```
Outdoor Unit Monitor:
ODU LNB                (< >, ENT)
```

If **BUC** is selected, the following menu is displayed:

```
BUC: DC=47.8V, 3.2A  T=38°C
SW=1.1  PLL=F1t  Pwr=02.1W
```

The menu displays the following parameters:

DC Pwr	(DC Power) If a BUC supply is installed, displays measured BUC supply voltage and load current, measured at the Tx-IF connector.
T	(Temperature) If BUC FSK is enabled, displays BUC ambient temperature in °C.
SW	If BUC FSK is enabled, displays the M&C software version of the BUC.
PLL	If BUC FSK is enabled, displays the fault status of the BUC PLL synthesizers.
Pwr	(Output) If BUC FSK is enabled, displays the output power as measured by the BUC power monitor.

Press **ENT** or **CLR** to return to the next-highest menu.

Select **LNB** or **BUC**, using the ◀ ▶ arrow keys, then press **ENT**.

If **LNB** is selected, the following menu is displayed:

```
LNB Voltage: 13.1 volts
LNB Current: 235 mA      (ENT)
```

The menu displays the LNB Voltage and Current. Press **ENT** or **CLR** to return to the next-highest menu.

5.6.3 TEST:

Selecting Test will display this sub-menu:

```
TEST: Mode BIST (◀ ▶, ENT)
      Spec-Analyzer
```

Select **Mode**, **BIST**, or **Spec-Analyzer** using the ◀ ▶ arrow keys, then press **ENT**. Note that BIST stands for built-in system test. Selecting Mode will display this sub-menu:

```
Mode: Norm IF↵ Dig↵ I/O↵ RF↵
      Tx-CW Tx1-0 (◀ ▶, ENT)
```

All the modes are available if grouped as modem. However, in ungrouped case, for example Tx, **Norm**, **Tx-CW**, and **Tx1-0** are the only selection. For Rx only, it is always in **Norm**.

Select **Norm**, **IF Loop**, **Dig Loop**, **I/O Loop**, **RF Loop**, **Tx-CW**, or **Tx-1,0**, using the ◀ ▶ arrow keys, then press **ENT**.

This sub-menu permits the user to select the following test modes:

Norm	(Normal) This clears any test modes or loopbacks, and places the unit back into an operational state.
IF Loop	(IF Loopback) This test mode invokes an internal IF loop. This is a particularly useful feature, as it permits the user to perform a quick diagnostic test without having to disturb external cabling. Furthermore, all of the receive configuration parameters are temporarily changed to match those of the transmit side. When Normal is again selected, all of the previous values are restored. During an IF Loop, the Tx carrier continues to be transmitted. See Figure 5-4.
Dig Loop	(Digital Loopback) This test mode invokes a digital Loopback, which loops data at the output of the framer/scrambler on the transmit side, back into the deframer/descrambler on the receive side. If concatenated Reed-Solomon FEC is being used, this is also included in the digital loop. See Figure 5-4.
I/O Loop	(Inward/Outward Loopback) This test mode invokes two distinct loopbacks. The first of these is the inward loop, which takes data being received from the satellite direction, and passes it directly to the modulator. Simultaneously, the outward loop is invoked, whereby data being fed to the transmit data interface is routed directly back out of the receive data interface. See Figure 5-4.
RF Loop	(RF Loopback) This test mode is almost identical to the IF loop mode. All of the receive configuration parameters are temporarily changed to match those of the transmit side, however, no internal connection is made. This is useful for performing a satellite Loopback. When NORMAL is again selected, all of the previous values are restored.
TX-CW	(Transmit CW) This is a test mode, which forces the modulator to transmit a pure carrier (unmodulated). Used for measuring phase noise.
TX-1,0	(Transmit an alternating 1,0,1,0 pattern) This is a test mode that forces the modulator to transmit a carrier modulated with an alternating 1,0,1,0 pattern, at the currently selected symbol rate. This causes two discrete spectral lines to appear, spaced at +/- half the symbol rate, about the carrier frequency. This mode is used to check the carrier suppression of the Modulator. If OQPSK is selected as the modulation type, the test will produce a spectral pattern suitable for the measurement of SSB rejection – useful in determining the phase and amplitude accuracy of the modulator.

If **BIST** is selected, the display will show:

```
BIST: BERT-Config  BERT-Mon  
BERT-Control      (◀ ▶, ENT)
```

The Built-In System Test (BIST) specifically refers to the built-in BERT (BER Tester). If **BERT-Config** is selected:

```
BERT Config: Tx=ON  Rx=ON  
Tx-Pat=2047 Rx-Pat=2047
```

If the selected slot is Tx, the Rx parameters are not selectable, and vice-versa. Note the BERT generator resides at the Tx side while the BERT monitor resides at the Rx side. This menu allows to turn ON/OFF either the BERT generator or monitor and selects the BERT pattern as the user may desire. The BERT pattern supported are **Space, Mark, 1:1, 1:3, 63, 511, 2047, 2047R (or 2047 alternate), MIL-188, 2¹⁵-1, 2²⁰-1, and 2²³-1.**

If **BERT-Mon** is selected:

```
BERT Monitor: Errs=0000253  
BER=8.5E-07
```

If BERT monitor is turned ON, results are being displayed in bit errors and average BER. If it displays **BER=SyncLoss** that means there was a loss of pattern synchronization. If it displays **BER=No Sync**, that means pattern synchronization is not achieved. When the BERT monitor is sync, the BER displays a value (e.g. BER=8.5E-07).

If **BERT-Control** is selected:

```
BERT Control: 10E-3Err=OFF  
Restart=NO  SyncThres=>256
```

The **10E-3Err** control resides at the Tx. This generates an average BER=1.0E-03 once monitored at the Rx side. The **Restart** control is to reset the BERT monitor (Rx side) for a fresh start of BER measurement. The **SyncThres** control is the synchronization loss threshold as defined:

- a. **>256** = 256 bit errors counted in less than 1000 bits of data
- b. **low** = 100 bit errors in less than 1000 bits of data
- c. **med** = 250 bit errors in less than 1000 bits of data
- d. **high** = 20,000 bit errors in less than 100,000 bits of data

If **Spec-Analyzer** is selected:

```
Spectrum Analyzer:
Mode Config      (< >, ENT)
```

Selecting **Mode** will display:

```
Spectrum Analyzer Mode:
Off On          (< >, ENT)
```

This menu allows the user to turn ON or OFF the engine of the spectrum analyzer. If spectrum analyzer mode is ON, the user can use Comtech's application software (Windows) to view the spectrum, or use the Web browser.

Selecting **Config** will display:

```
Config Spectrum Analyzer:
CenterFreq Span  (< >, ENT)
```

If **CenterFreq** is selected:

```
Spectrum Analyzer: (< >, ▲▼, ENT)
Center Freq = 0070.0000 MHz
```

The Center Freq is similar to Rx Frequency in a regular demodulation function with a resolution of 100 Hz.

If **Span** is selected:

```
Spectrum Analyzer: (▲▼, ENT)
Span = 12.5 MHz
```

The user can only select the following predefined span values:

97.65625 kHz	781.25 kHz	6.25 MHz
195.3125 kHz	1.5625 MHz	12.5 MHz
390.625 kHz	3.125 MHz	

Default is 12.5 MHz.

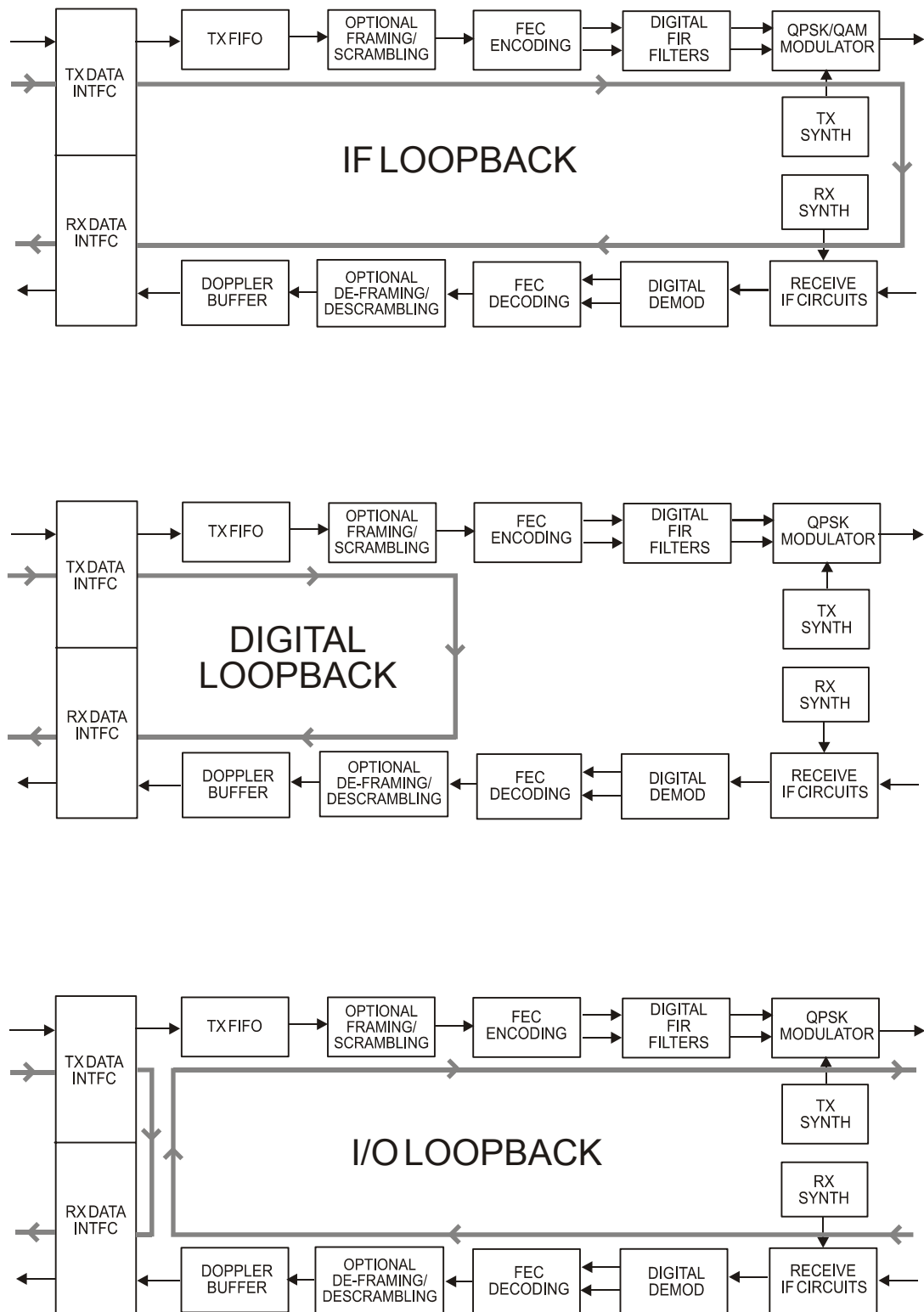

Figure 5-4. Loopback

5.6.4 INFO (Information)

Select **Rem**, **Tx**, **Rx**, **Buf**, **Frame**, **Interface**, **Mask**, **Ref**, or **ID** using the ◀ ▶ arrow keys, then press **ENTER**.

```
INFO: Rem Tx Rx Buffer Frame  
Interface Mask Ref ID
```

These screens display information on the current configuration of the unit. Depending on the choice selected, one of the following screens will be displayed: using the ◀ ▶ arrow keys, then press **ENT**.

5.6.4.1 (Info→Rem) - REMOTE CONTROL INFORMATION

This screen shows if the unit is in **Local** or **Remote** mode, and gives details of the electrical interface type selected, the unit's address, and the baud rate selected, etc. Pressing **ENT** or **CLR** takes the user back to the previous menu.

Examples:

```
Remote M&C: Monitor Only  
(Local Control only)
```

```
Remote M&C: RS485-4Wire  
Address: 0001 19200 Baud
```

```
Remote M&C: 100BaseTx  
IP Addr: 255.255.255.255
```

5.6.4.2 (Info→Tx) - TX INFORMATION

The information displayed here is as follows:

```
Tx: 1140.000 05000.000 TUR  
8P 17/18 S EXT -20.0 ON N ▲▼
```

Top line:

Transmit Frequency and Data Rate (NOTE: Due to space limitations, the resolution of displayed frequency is limited to 1 kHz, and data rate to 10Hz,)

FEC Encoder type (VIT = Viterbi, VRS=Viterbi + Reed-Solomon, TCM = Trellis Coded + Reed-Solomon, TUR = Turbo)

Bottom line:

Modulation Type (Q = QPSK, B = BPSK, 8P = 8-PSK, 16=16-QAM).

Code Rate (2144 = 21/44, then 5/16, 1/2, 2/3, 3/4, 7/8, 17/18)

Scrambler state (S = Scrambler on, N = Scrambler off, I=IESS-315)

Clocking Mode (INT = internal, EXT = external, LOP = loop, ELP=external loop)

Output Power level

Transmit Output State (ON = on, OF = off, EO= external off)

TSI State (I = Transmit Spectral Inversion on, N = off)

Using ▲▼ arrow keys will display the following information:

```
Tx: C N N 35  
▲▼
```

Top line:

Reed-Solomon code rates (C=Comtech(220,200), E=EF Data(225,205), I=IESS-310(219,201).

Tx Clock Inversion (N=Normal, I=Inverted).

Tx Data Inversion (N=Normal, I=Inverted).

Tx Roll-Off (α) factor (20=20% roll-off, 35=35% roll-off)

5.6.4.3 (Info→Rx) – RX INFORMATION

The information displayed here is as follows:

```
Rx: 1140.000 05000.000 TUR
8P 17/18 D RX BUF +/-32k N ▲▼
```

Top line:

Receive Frequency and Data Rate (NOTE: Due to space limitations, the resolution of displayed frequency is limited to 1 kHz, and data rate to 10Hz,)

FEC Decoder type (VIT = Viterbi, SEQ = Sequential, VRS=Viterbi + Reed-Solomon, SRS=Sequential + Reed Solomon, TCM = Trellis Coded + Reed-Solomon, TUR = Turbo)

Bottom line:

Demodulation type (Q = QPSK, B = BPSK, 8P = 8-PSK, 16=16-QAM).

Code Rate (2144 = 21/44, then 5/16, 1/2, 2/3, 3/4, 7/8, 17/18)

Descrambler state (D = Descrambler on, N = Descrambler off)

Buffer Source (IN = internal, RX = Rx satellite, TT = Tx terrestrial)

Buffer Clocking Mode (SAT = buffer disabled, BUF = buffer enabled)

Demod Sweep Acquisition range

RSI state (I = Receive Spectral Inversion on, N = off)

Using ▲▼ arrow keys will display the following information:

```
Rx: C N N 35
```

```
▲▼
```

Top line:

Reed-Solomon code rates (C=Comtech(220,200), E=EF Data(225,205), I=IESS-310(219,201).

Rx Clock Inversion (N=Normal, I=Inverted).

Rx Data Inversion (N=Normal, I=Inverted).

Rx Roll-Off (α) factor (20=20% roll-off, 35=35% roll-off)

5.6.4.4 (Info→Buffer) - BUFFER INFORMATION

```
Buffer: Enabled (Tx=Rx)
          (ENT)
```

This displays if the buffer is enabled or disabled, shows the exact clocking mode (TX=RX, or TX<> RX), and the buffer size. Pressing **ENT** takes the user back to the previous menu.

5.6.4.5 (Info→Frame) – FRAMING AND EDMAC INFORMATION

Examples:

```
Framing: AUPC-Only, D&I++
          (ENT or CLR)
```

```
Framing: AUPC-Only, EDMAC2
          (ENT or CLR)
```

```
Framing: AUPC+EDMAC2
Master, 0240 (ENT or CLR)
```

```
Framing: AUPC+EDMAC
Slave, 0241 (ENT or CLR)
```

This screen shows **EDMAC** mode, and shows if the unit is an EDMAC MASTER or SLAVE, with the appropriate address. Pressing **ENT** or **CLR** takes the user back to the previous menu.

5.6.4.6 (Info→Interface) – INTERFACE INFORMATION

This screen shows details of the electrical interface type of the main data port. If **RS422**, **V.35** or **RS232** is selected, the menu will also indicate the operation of RTS/CTS. Pressing **ENT** or **CLR** takes the user back to the previous menu.

Example:

```
Interface: RS422 (ENT)
RTS/CTS Loop, No Action
```

5.6.4.7 (Info→Mask) – ALARM MASK INFORMATION

This shows, in the same format as the CONFIG, MASK sub menu, which alarms are currently masked. If an alarm is not masked, a blank is displayed in the relevant screen position.

```
Mask:  FIFO  BPV  TAIS  RAIS
AGC  EbNo  BUF  Ref
```

5.6.4.8 (Info→Ref) - FREQUENCY REFERENCE

```
Frequency Reference:
Internal 10 MHz      (ENT)
```

This shows the source of the frequency reference for the CDM-QX.

5.6.4.9 (Info→ID) – CIRCUIT IDENTIFICATION

```
Circuit ID:          (ENT)
28 CHARACTER TST MESSAGE
```

This displays the user-defined Circuit ID string, which is entered via the UTIL, ID screen. To return to the previous menu, press **ENT**. Backup devices do not have an ID.

5.6.5 SAVE/LOAD

```
SAVE/LOAD Configuration:
Save  Load          (◀ ▶ ENT)
```

Select **Save** or **Load** using the ◀ ▶ arrow keys, then press **ENT**.

These sub-menus permit the user to store or load up to 10 different modem configurations in the non-volatile memory of the modem.

5.6.5.1 (Save/Load→Save) – SAVE CONFIGURATION

Selecting **Save** will display the following screen, if the selected location is empty:

```
Save Config to Location: 9
Empty                    (▲ ▼ ENT)
```

However, if the location already contains data, the following screen will be displayed:

```
Save Config to Location: 9
11:10:29 23/12/03      (▲ ▼ ENT)
```

The user is shown the time and date stamp of the previously stored configuration, for identification purposes.

Select the location to store the current configuration to, using the ▲▼ arrow keys, then press **ENT**. Locations 1 through 10 are available.

If the selected location does not contain a previously stored configuration, the following screen is displayed:

```
Your Configuration has been
Saved to Location 9      (ENT)
```

Pressing **ENT** or **CLR** will take the user back to the previous menu.

If, however, the selected location contains a previously stored configuration, the following screen is displayed:

```
Location 9 Contains Data!
Overwrite? NO YES      (◀ ▶ ENT)
```

Select **NO** or **YES** using the ◀ ▶ arrow keys, then press **ENT**.

Selecting **YES** will overwrite the existing configuration at the selected location.

5.6.5.2 (Save/Load→Load) – LOAD CONFIGURATION

Having selected **Load**, if there is a configuration stored at the selected location the following screen will be displayed:

```
Load Config from Location: 9
11:10:29 23/12/03      (▲ ▼ ENT)
```

Note the data and time stamp identifying the stored configuration.

But if the selected location contains no data, the following screen will be displayed:

```
Load Config from Location 9
Empty                    (▲ ▼ ENT)
```

Select the location to load a configuration from, using the ▲▼arrow keys, then press **ENT**. Locations 1 through 10 are available.

If the selected location contains valid data, the following screen will be displayed:

```
New Config has been Loaded
from Location 9      (ENT)
```

Pressing **ENT** or **CLR** will take the user back to the previous menu.

If, however, the selected location does not contain valid data, the following screen will be displayed:

```
Warning! Location 9
Contains No Data!   (ENT)
```

Pressing **ENT** or **CLR** will take the user back to the previous menu.

5.6.6 UTILITY

```
UTILITY: RxBuffer Clock Ref  
ID Display Firmware FAST
```

Select **RxBuffer**, **Clock**, **Ref**, **ID**, **Display**, **Firmware** or **FAST** using the ◀ ▶ arrow keys then press **ENT**.

According to the selection, the following sub-menus are displayed:

5.6.6.1 (Utility→RxBuffer) - BUFFER RECENTER

```
Press ENT to Re-Center  
the Receive Buffer
```

Pressing **ENT** will cause a forced re-centering of the Plesiochronous/Doppler buffer.

5.6.6.2 (Utility→Clock) - REAL-TIME CLOCK

```
Real-Time Clock: (◀ ▶, ▲ ▼, ENT)  
Time=12:00:00 Date:24/04/03
```



Edit the time and date settings of the real-time clock. This is accomplished by selecting the digit to be edited, using the ◀▶ arrow keys. The value of the digit is then changed using the ▲▼ arrow keys. Note that in accordance with international convention, the date is shown in **DAY-MONTH-YEAR** format. The user should then press **ENT**.

5.6.6.3 (Utility→Ref) - REFERENCE ADJUST

```
Internal Freq Ref: Adjust  
Warm-up delay (▲▼, ENT)
```

Fine adjustment of the Internal 10 MHz reference oscillator is possible through this menu. Use the ▲▼ arrow keys to edit the value, then press ENT. The range of values is from -2048 to +2047.

Note: The numbers displayed here do not correspond to an exact frequency increment. A user should perform this fine adjustment while using an external frequency counter, connected to either:

- a. the internal 10 MHz reference, or
- b. the Tx Output, set for CW, and an exact center frequency of 1000 MHz, for example.

5.6.6.4 (Utility→ID) – CIRCUIT IDENTIFICATION

```
Edit Circuit ID: (◀ ▶, ▲ ▼, ENT)  
28 CHARACTER TST MESSAGE
```

Edit the Circuit ID string, using the ◀▶ and ▲▼ arrow keys. Only the bottom line is available (28 characters). The cursor selects the position on the bottom line (◀ ▶) and the character is then edited (▲▼). The following characters are available:

Space () * + - , . / 0-9 and A-Z.

When the user has composed the string, press ENT. Backup devices in redundant groups do not have an ID. If plug-in devices are to be grouped, the grouping should precede assigning IDs so the group can be named instead of the individual devices.

5.6.6.5 (Utility→Display) - DISPLAY BRIGHTNESS

```
Edit Display Brightness:
100%                      (▲▼, ENT)
```

Edit the display brightness, using the ▲▼ arrow keys. The user should then press **ENT**.

5.6.6.6 (Utility→Firmware) - FIRMWARE

This series of sub-menus permits the user to view information about the CDM-Qx internal firmware. The modem can store two complete firmware images, and the user can select which image will be loaded the next time the unit re-boots.



THESE MENUS ARE FOR DIAGNOSTIC PURPOSES. ONLY CHANGE AN IMAGE IF INSTRUCTED TO DO SO BY COMTECH EF DATA CUSTOMER SERVICE TECHNICIANS.

```
Firmware Images: Update-CPLD
Information Select (< ▶ ENT)
```

Select either **Information** or **Select**, using the ◀▶ arrow keys. The user should then press **ENT**.

If the user selects **Information**, the following sub-menu is displayed:

```
F/W Information: Bootrom
Image#1 Image#2 CPLD
```

The user may select, using the ◀▶ arrow keys and **ENT** key, to view information about the Bootrom, the 2 images, or the CPLD on the modulator or demodulator card.

Each image can be viewed as follows:

```
Image#x: Bulk Firmware (▲ ▼ ENT)
FWxxxxxx 01/01/04 1.1.1
```

By using the ▲▼ arrow keys, the user can view each component of the firmware image.

If the user selects **Select**, the following sub-menu is displayed:

```
Current Active Image: #1
Next Reboot Image: #1 #2
```

The top line shows the current active image. On the bottom line the user may select, using the ◀ ▶ arrow keys and ENT key, the image that will be active the next time the unit is re-booted.

If **Update-CPLD** is selected, the following sub-menus are displayed:

```
RULE: Only one card must be
installed in the chassis!
```

Programming the CPLD requires only one card to be installed in the chassis. If this rule has been exercised, this next menu will appear.

```
Update CPLD to v1.x.x?
No Yes                (◀ ▶ ENT)
```

Where v1.x.x is version number. Before selecting **Yes**, please check the current version of the CPLD programmed on the Tx or Rx card (Utility→Firmware→Information→CPLD). Select **Yes** if you want to update it to the latest version and the following sub-menu is displayed:

```
Programming CPLD . . .
. . . PLEASE WAIT!
```

Every time CPLD programming is done (whether successful or not), always CYCLE power if another card is to be programmed.

5.6.7 (Utility→FAST) - FAST Code Options

FAST is the way to enable new options in the modem. Obtain the FAST code for the new option from Comtech EF Data.

```
FAST - Select the module:  
Base Slot1 Slot2 Slot3 Slot4
```

The **Base** refers to the base unit where you can view the redundancy option as well as the CnC option. The **Slot#** refers to the cards where it is installed. If **Base** is selected, the sub-menu will appear as follows:

```
FAST: Config View  
Board S/N: 123456789 (Base)
```

If **Slot#** is selected, this submenu will appear (for example Slot1):

```
FAST - Slot#1: Mod Turbo  
              (< ▶ ENT)
```

Selecting **Mod** (in this case) will display the next sub-menu:

```
FAST: Config View  
Board S/N: 123456789 (Mod#1)
```

If **Turbo** is selected, it will show this (for example in Slot1):

```
FAST: Config View  
Board S/N: 123456789 (TPC#1)
```

If **Config** is selected in any case (base or slot#), it will display the following:

```
FAST Configuration  
Edit Code Demo Mode
```

User can either select **Edit Code** or **Demo Mode**. If Edit Code is selected, the following menu is displayed:

```
Edit 20 digit FAST Code:  
00000000000000000000 ENT
```

Enter the code carefully. Use the ◀▶ arrow keys to move the cursor to each character. Use the ▲▼ arrow keys to edit the character, then press **ENT**. The modem will respond with “Configured Successfully” if the new FAST option has been accepted as shown below.

```
Configured Successfully  
(ENT or CLR)
```

If, on the other hand, the FAST code is rejected, the following menu will be displayed:

```
FAST Code Rejected!  
(ENT or CLR)
```

If **Demo Mode** is selected, the display will be as follows:

```
FAST Demo Mode: Off On  
604669 seconds remain
```

The Demo Mode allows the user to use all FAST options with limited time. The demo will last only 7 days. If demo is on, CnC is only allowed up to 2.5 Mbps.

If the user selects **View**, then the following menu is displayed, for example:

```
View Options: 01 (▲ ▼ ENT)  
1:1 Redun - Not Installed
```

Use the ▲▼ arrow keys to scroll through each Option Number in turn. As the cursor highlights each option, the description of the option will be displayed on the bottom line, along with the information “Installed or Not Installed”.

Chapter 6. FORWARD ERROR CORRECTION OPTIONS

6.1 Introduction

As standard, the Modem is equipped with three Forward Error Correction encoders/decoders – Viterbi, concatenated Reed-Solomon and Trellis (which is available with the 8-PSK FAST option). The constraint lengths and encoding polynomials are not only Open Network compatible (IESS-315), but are also Closed Network compatible with the vast majority of existing modems from other manufacturers. Comtech EF Data has performed compatibility testing to ensure inter-operability.

Turbo Coding represents a very significant development in the area of FEC, and optionally, the modem may be fitted with a Turbo Product Codec. They are plug-in daughter cards (SIMM modules) that are field upgradeable. The codec provides data rate capability up to 20 Mbps, and code rates of:

- Rate 5/16 (BPSK)
- Rate 21/44 (BPSK, QPSK)
- Rate 3/4, and 7/8 (QPSK, 8-PSK, and 16-QAM)
- Rate 17/18 (QPSK and 8-PSK)

Turbo Product Coding provides one of the best Forward Error Correction technologies currently available, and is now offered with a sufficient range of code rates and modulation types that link performance can be optimized under any conditions.

6.2 Viterbi

The combination of convolutional coding and Viterbi decoding has become an almost universal standard for satellite communications. The Modem complies with the Intelsat standards for Viterbi decoding with a constraint length of seven. This is a *de facto* standard, even in a closed network environment, which means almost guaranteed interoperability with other manufacturer's equipment. It provides very useful levels of coding gain, and its short decoding delay and error-burst characteristics make it particularly suitable for low data rate coded voice applications. It has a short constraint length, fixed at 7, for all code rates. (The constraint length is defined as the number of output symbols from the encoder that are affected by a single input bit.) By choosing various coding rates (Rate 1/2, 3/4, or 7/8) the user can trade off coding gain for bandwidth compression. Rate 1/2 coding gives the best improvement in error rate, but doubles the transmitted data rate, and hence doubles the occupied bandwidth of the signal. Rate 7/8 coding, at the other extreme, provides the most modest improvement in performance, but only expands the transmitted bandwidth by 14 %. A major advantage of the Viterbi decoding method is that the performance is independent of data rate, and does not display a pronounced threshold effect (i.e., does not fail rapidly below a certain value of Eb/No). Note that in BPSK mode, the Modem only permits a coding rate of 1/2. Because the method of convolutional coding used with Viterbi, the encoder does not preserve the original data intact, and is called *non-systematic*.

Table 6-1. Viterbi Decoding Summary

FOR	AGAINST
Good BER performance - very useful coding gain.	Higher coding gain possible with other methods
Almost universally used, with <i>de facto</i> standards for constraint length and coding polynomials	
Shortest decoding delay (~200 bits) of any FEC scheme - good for coded voice, VOIP, etc	
Short constraint length produce small error bursts - good for coded voice.	
No pronounced threshold effect - fails gracefully.	
Coding gain independent of data rate.	

6.3 Reed-Solomon Outer Codec



It cannot be emphasized strongly enough that the purpose of the concatenated Reed-Solomon is to dramatically improve the BER performance of a link under given noise conditions. It should NOT be considered as a method to reduce the link EIRP requirement to produce a given BER. Factors such as rain-fade margin, particularly at Ku-band, are extremely important, and reducing link EIRP can seriously degrade the availability of such a link.

The concatenation of an outer Reed-Solomon Codec with Viterbi decoder first became popular when Intelsat introduced it in the early 1990's. It permits significant improvements in error performance without significant bandwidth expansion. The coding overhead added by the R-S outer Codec is typically around 10%, which translates to a 0.4 dB power penalty for a given link. Reed-Solomon codes are block codes (as opposed to Viterbi, which is convolutional), and in order to be processed correctly the data must be framed and de-framed. Additionally, Reed-Solomon codes are limited in how well they can correct errors that occur in bursts. This, unfortunately, is the nature of the uncorrected errors from Viterbi decoders, which produce clusters of errors that are multiples of half the constraint length. For this reason, the data must be interleaved following R-S encoding, and is then de-interleaved prior to decoding. This ensures that a single burst of errors leaving the Viterbi decoder is spread out over a number of interleaving frames, so errors entering the R-S decoder do not exceed its capacity to correct those errors.

In the case of the Modem, different R-S code rates are used, according to the mode of operation:

6.3.1 Closed Network Modes

A 220,200 code is used in transparent closed network modes, and a 200, 180 code is used in framed (EDMAC) modes. (220, 200 means that data is put into blocks of 220 bytes, of which 200 bytes are data, and 20 bytes are FEC overhead.) These two codes were chosen because they fit well into Comtech EF Data's clock generation scheme, and they have almost identical coding gain. When Viterbi decoding is used as the primary FEC, an interleaver depth of 4 is used. The increase in coding gain is at the expense of delay. The interleaving/de-interleaving delay and the delay through the decoder itself can be as high as 25 kbps. At very low data rates, this equates to several seconds, making it highly unsuitable for voice applications. Additionally, the de-interleaver frame synchronization method can add significantly to the time taken for the demodulator to declare acquisition.

A characteristic of concatenated R-S coding is the very pronounced threshold effect. For any given modem design, there will be a threshold value of E_b/N_0 below which the demodulator cannot stay synchronized. This may be due to the carrier-recovery circuits, or the synchronization threshold of the primary FEC device, or both. In the Modem, and Rate 1/2 operation, this threshold is around 4 dB E_b/N_0 . Below this value, operation is not possible, but above this value, the error performance of the concatenated R-S system produces exceptionally low error rates for a very small increase in E_b/N_0 .



Care should be taken not to operate the demodulator near its sync threshold. Small fluctuations in E_b/N_0 may cause total loss of the link, with the subsequent need for the demodulator to re-acquire the signal.

Table 6-2. Concatenated R-S Coding Summary

FOR	AGAINST
Exceptionally good BER performance - several orders of magnitude improvement in link BER under given link conditions.	Very pronounced threshold effect - does not fail gracefully in poor E_b/N_0 conditions. Additional coding overhead actually degrades sync threshold, and reduces link fade margin.
Very small additional bandwidth expansion	Significant processing delay (~25 kbits) - not good for voice, or IP applications
	Adds to demod acquisition time.

6.4 Trellis Coding

In the other FEC methods described here, the processes of coding and modulation are independent - the FEC codec has no knowledge of, or interaction with the modulator. However, there are schemes in which the coding and modulation are combined together, where the encoder places FEC symbols in a precise manner into the signal constellation. This can yield an overall improvement in performance, and is used in higher-order modulation schemes, such as 8-PSK, 16-PSK, 16-QAM, etc. When convolution coding is used, the overall *coded modulation* approach is referred to as Trellis Coded Modulation (TCM). Ungerboeck was an early pioneer, and developed optimum mapping and decoding schemes. However, the decoding scheme was seen as complex, and expensive, and Qualcomm Inc. developed a variation on the theme, which uses a Viterbi decoder at the core, surrounded by adjunct processing. The scheme is able to achieve performance very close to the optimum Ungerboeck method, but with far less complexity, and is called *pragmatic Trellis Coded Modulation*.

Now, Intelsat recognized that, as more and more high power transponders are put in to service, the transponders are no longer *power limited*, but *bandwidth limited*. In order to maximize transponder capacity, they looked at 8-PSK as a method of reducing the occupied bandwidth of a carrier, and adopted Qualcomm's pragmatic TCM, at Rate 2/3.

A Rate 2/3 8-PSK/TCM carrier occupies only 50% of the bandwidth of a Rate 1/2 QPSK carrier. However, the overall coding gain of the scheme is not adequate by itself, and so Intelsat's IESS-310 specification requires that the scheme be concatenated with an outer R-S codec. When combined, there is a threshold value of E_b/N_0 of around 6 dB, and above approximately 7 dB, the bit error rate is better than 1×10^{-8} .

The detractions of the concatenated R-S approach apply here also, along with more stringent requirements for phase noise and group delay distortion – the natural consequences of the higher-order modulation.

The modem fully implements the FEC, but not the framing of the IESS-310 specification at data rates up to 18 Mbps. In accordance with the specification, the R-S outer code can be disabled. Performance curves for both cases are shown in the following Figures.

Table 6-3. 8-PSK/TCM Coding Summary

FOR	AGAINST
Exceptionally bandwidth efficient compared to QPSK	Needs concatenated R-S outer codec to give acceptable coding gain performance
	Demod acquisition threshold much higher than for QPSK
	8-PSK is more sensitive to phase noise and group delay distortion than QPSK

6.5 Turbo Product Codec (Hardware Option)

6.5.1 Introduction



Turbo coding is an FEC technique developed within the last few years, which delivers significant performance improvements compared to more traditional techniques. Two general classes of Turbo Codes have been developed, Turbo Convolutional Codes (TCC), and Turbo Product Codes (TPC, a block coding technique). Comtech EF Data has chosen to implement an FEC codec based on TPC. A Turbo Product Code is a 2 or 3 dimensional array of block codes. Encoding is relatively straightforward, but decoding is a very complex process requiring multiple iterations of processing for maximum performance to be achieved.

Unlike the popular method of concatenating a Reed-Solomon codec with a primary FEC codec, Turbo Product Coding is an entirely stand-alone method. It does not require the complex interleaving/de-interleaving of the R-S approach, and consequently, decoding delays are significantly reduced. Furthermore, the traditional concatenated R-S schemes exhibit a very pronounced threshold effect – a small reduction in Eb/No can result in total loss of demod and decoder synchronization. TPC does not suffer from this problem – the demod and decoder remain synchronized down to the point where the output error rate becomes unusable. This is considered to be a particularly advantageous characteristic in a fading environment. Typically, in QPSK, 8-PSK and 16-QAM TPC modes the demod and decoder can remain synchronized **2 – 3 dB below** the Viterbi/Reed-Solomon or TCM cases.

Comtech now provides the best Forward Error Correction technology currently available, offering a very broad range of TPC code rates, combined with the entire range of modulation types, from BPSK to 16-QAM.

6.5.2 The Evolution of TPC in Comtech Products

When Comtech EF Data first introduced the Turbo Coding option in 1999, only Rate 3/4 QPSK was offered. Further work permitted the addition of Offset QPSK operation. Two further code rates - Rate 21/44 BPSK (very close to Rate 1/2) and Rate 5/16 BPSK (very close to Rate 1/3) were then made available.

(These two rates were developed to address transmission from very small antennas, where ITU flux density limits may be an issue. The combination of code rate and BPSK modulation provides wide spreading, and hence reduces flux density.)

In 2002, the new second generation TPC option was released. This has added data rate capability up to 20 Mbps, in addition to Rate 7/8 and Rate 17/18 capability. The Rate 7/8 TPC is extremely powerful, offering performance very close to the original Rate 3/4 TPC, but using 15% less bandwidth. Note also that the Rate 17/18 TPC adds just 5% FEC overhead, but yields almost identical coding gain to Rate 1/2 Viterbi at a BER of 1×10^{-7} . Below is a listing of all the available TPC modes and rates in the CDM-Qx.

Table 6-4. Available TPC Modes

Code Rate/Modulation	Data Rate Range
Rate 21/44 BPSK	32 kbps to 4.772 Mbps
Rate 5/16 BPSK	32 kbps to 3.125 Mbps
Rate 21/44 QPSK	32 kbps to 10 Mbps
Rate 3/4 QPSK	32 kbps to 15 Mbps
Rate 3/4 8-PSK	288 kbps to 20 Mbps
Rate 3/4 16-QAM	384 kbps to 20 Mbps
Rate 7/8 QPSK	32 kbps to 17.5 Mbps
Rate 7/8 8-PSK	336 kbps to 20 Mbps
Rate 7/8 16-QAM	448 kbps to 20 Mbps
Rate 17/18 QPSK	32 kbps to 18.88 Mbps
Rate 17/18 8-PSK	362.7 kbps to 20 Mbps

6.5.3 End-to-End Processing Delay

In many cases, FEC methods that provide increased coding gain do so at the expense of increased processing delay. However, with TPC, this increase in delay is very modest. The table below shows, for the Modem, the processing delays for the major FEC types, including the three TPC modes:

Table 6-5. Turbo Product Coding processing delay comparison

FEC Mode (64 kbps data rate)	End-to-end delay, ms
Viterbi, Rate 1/2	12
Viterbi Rate 1/2 + Reed-Solomon	266
Turbo Product Coding, Rate 3/4	47
Turbo Product Coding, Rate 21/44, BPSK	64
Turbo Product Coding, Rate 5/16, BPSK	48
Turbo Product Coding, Rate 7/8	245 *
Turbo Product Coding, Rate 17/18	69

Note that in all cases, the delay is inversely proportional to data rate, so for 128 kbps, the delay values would be half of those shown above. It can be seen that the concatenated Reed-Solomon cases increase the delay significantly (due mainly to interleaving/de-interleaving), while the TPC cases yield delays, which are much less.

* A larger block is used for the Rate 7/8 code, which increases decoding delay.

6.5.4 Comparison of all TPC Modes

Mode	Eb/No at BER = 10 ⁻⁶ Guaranteed (Typical in parentheses)	Eb/No at BER = 10 ⁻⁸ Guaranteed (Typical in parentheses)	Spectral Efficiency	Symbol Rate	Occupied * Bandwidth for 1 Mbps Carrier
<i>QPSK Rate 1/2 Viterbi *</i>	6.0 dB (5.5 dB)	7.3 dB (6.8 dB)	1.00 bits/Hz	1.0 x bit rate	1190 kHz
BPSK Rate 21/44 Turbo	2.9 dB (2.6 dB)	3.3 dB (3.0 dB)	0.48 bits/Hz	2.1 x bit rate	2493 kHz
BPSK Rate 5/16 Turbo	2.4 dB (2.1 dB)	2.8 dB (2.5 dB)	0.31 bits/Hz	3.2 x bit rate	3808 kHz
QPSK Rate 1/2 Turbo	2.9 dB (2.6 dB)	3.2 dB (2.8 dB)	0.96 bits/Hz	1.05 x bit rate	1246 kHz
QPSK Rate 3/4 Turbo	3.8 dB (3.3 dB)	4.4 dB (4.0 dB)	1.50 bits/Hz	0.67 x bit rate	793 kHz
QPSK Rate 7/8 Turbo	4.3 dB (4.0 dB)	4.5 dB (4.2 dB)	1.75 bits/Hz	0.57 x bit rate	678 kHz
QPSK Rate 17/18 Turbo	6.4 dB (6.0 dB)	6.9 dB (6.5 dB)	1.90 bits/Hz	0.53 x bit rate	626 kHz
<i>8-PSK Rate 2/3 TCM ** and R-S (IESS-310)</i>	6.5 dB (5.6 dB)	6.9 dB (6.0 dB)	1.82 bits/Hz	0.56 x bit rate	666 kHz
8-PSK Rate 3/4 Turbo	6.2 dB (5.7 dB)	6.8 dB (6.3 dB)	2.25 bits/Hz	0.44 x bit rate	529 kHz
8-PSK Rate 7/8 Turbo	7.0 dB (6.6dB)	7.2 dB (6.8 dB)	2.62 bits/Hz	0.38 x bit rate	453 kHz
8-PSK Rate 17/18 Turbo	9.3 dB (8.9 dB)	10.3dB (9.9 dB)	2.85 bits/Hz	0.35 x bit rate	377 kHz
16-QAM Rate 3/4 Turbo	7.4 dB (7.0 dB)	8.2 dB (7.7 dB)	3.00 bits/Hz	0.33 x bit rate	396 kHz
16-QAM Rate 7/8 Turbo	8.1 dB (7.7 dB)	8.3 dB (7.9 dB)	3.50 bits/Hz	0.28 x bit rate	340 kHz
<i>16-QAM Rate 3/4 ** Viterbi/Reed-Solomon</i>	8.1 dB (7.5 dB)	8.6 dB (8.0 dB)	2.73 bits/Hz	0.37 x bit rate	435 kHz
<i>16-QAM Rate 7/8 ** Viterbi/Reed-Solomon</i>	9.5 dB (9.0 dB)	10.1 dB (9.5 dB)	3.18 bits/Hz	0.31 x bit rate	374 kHz

* The occupied bandwidth is defined at the width of the transmitted spectrum taken at the -10 dB points on the plot of power spectral density. This equates to 1.19 x symbol rate for the modem transmit filtering.

** Included for comparative purposes

It can be seen that the 8-PSK Rate 3/4 Turbo performance closely approaches that of the Rate 2/3 TCM/Reed-Solomon case – the BER performance is within approximately 0.4 dB. However, it should be noted that the Rate 3/4 Turbo mode is **20% more bandwidth efficient** than the TCM case. The additional advantages of Turbo (lower delay, performance during fades etc) should also be considered.

Table 6-6. Turbo Product Coding Summary

FOR	AGAINST
Exceptionally good BER performance - significant improvement compared with every other FEC method in use today	Nothing!
No pronounced threshold effect - fails gracefully	
Exceptional bandwidth efficiency	
Coding gain independent of data rate (in this implementation)	
Low decoding delay	
Easy field upgrade in Modem	

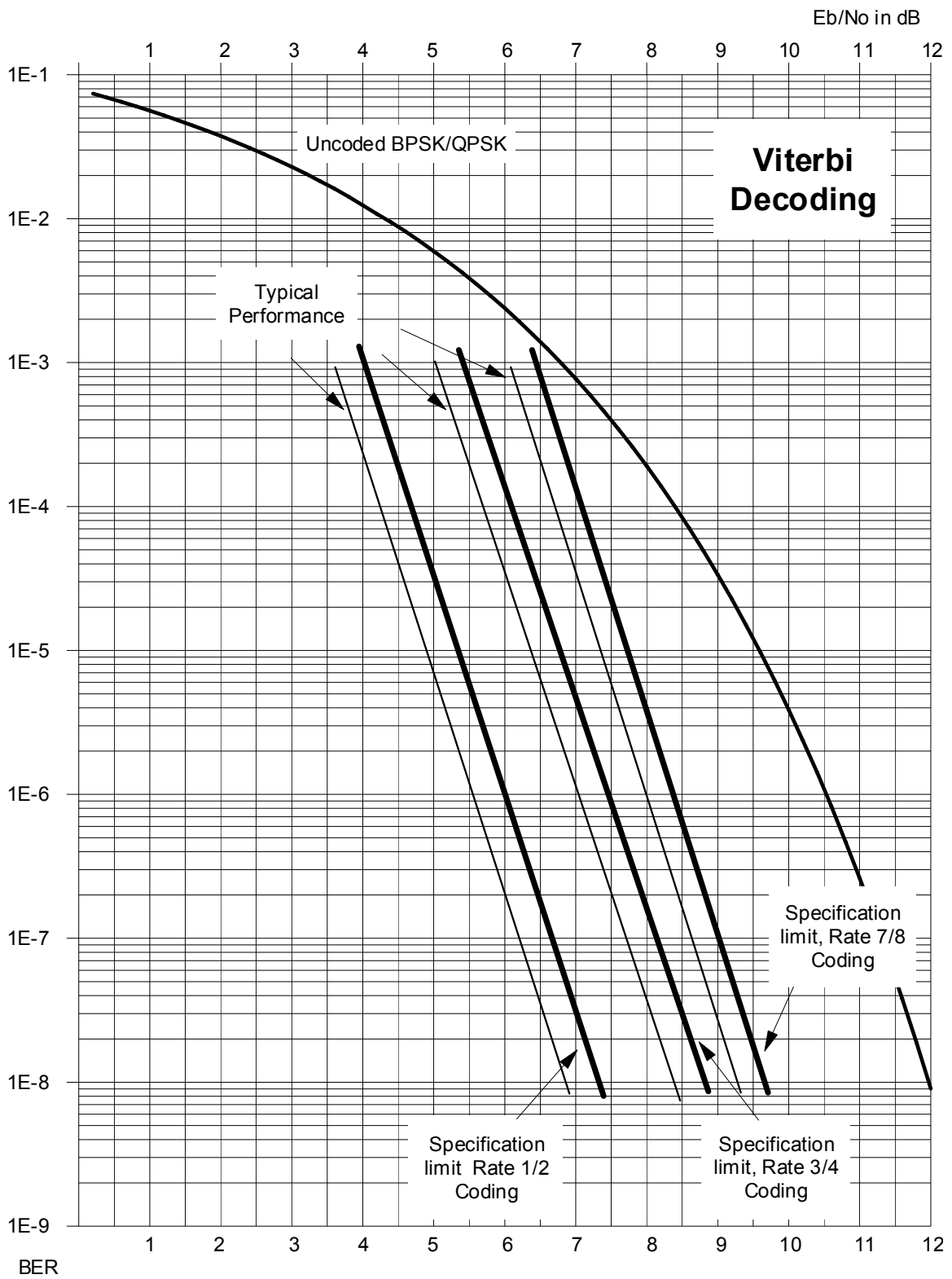

Figure 6-1. Viterbi Decoding

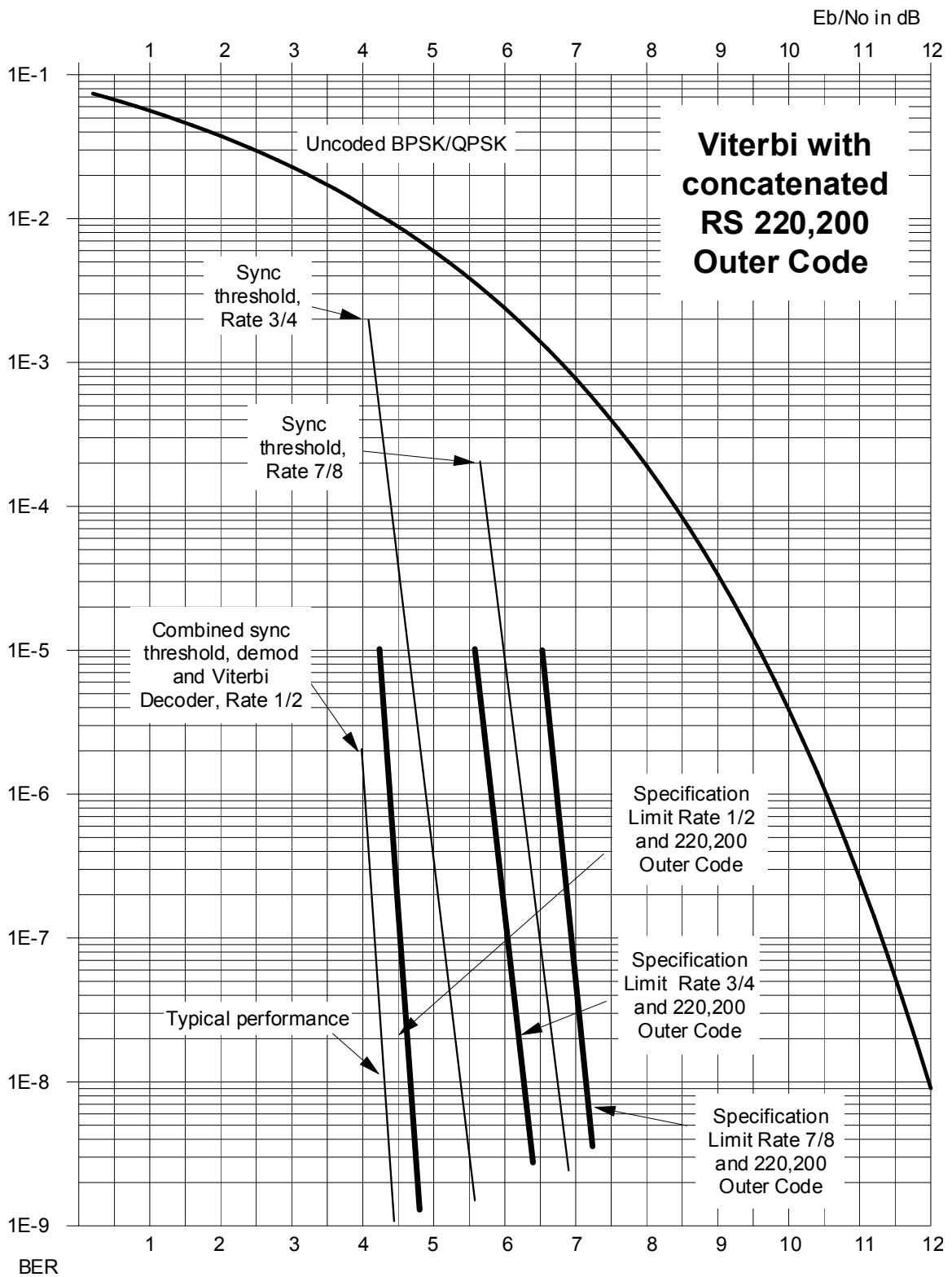

Figure 6-2. Viterbi with concatenated R-S Outer Code

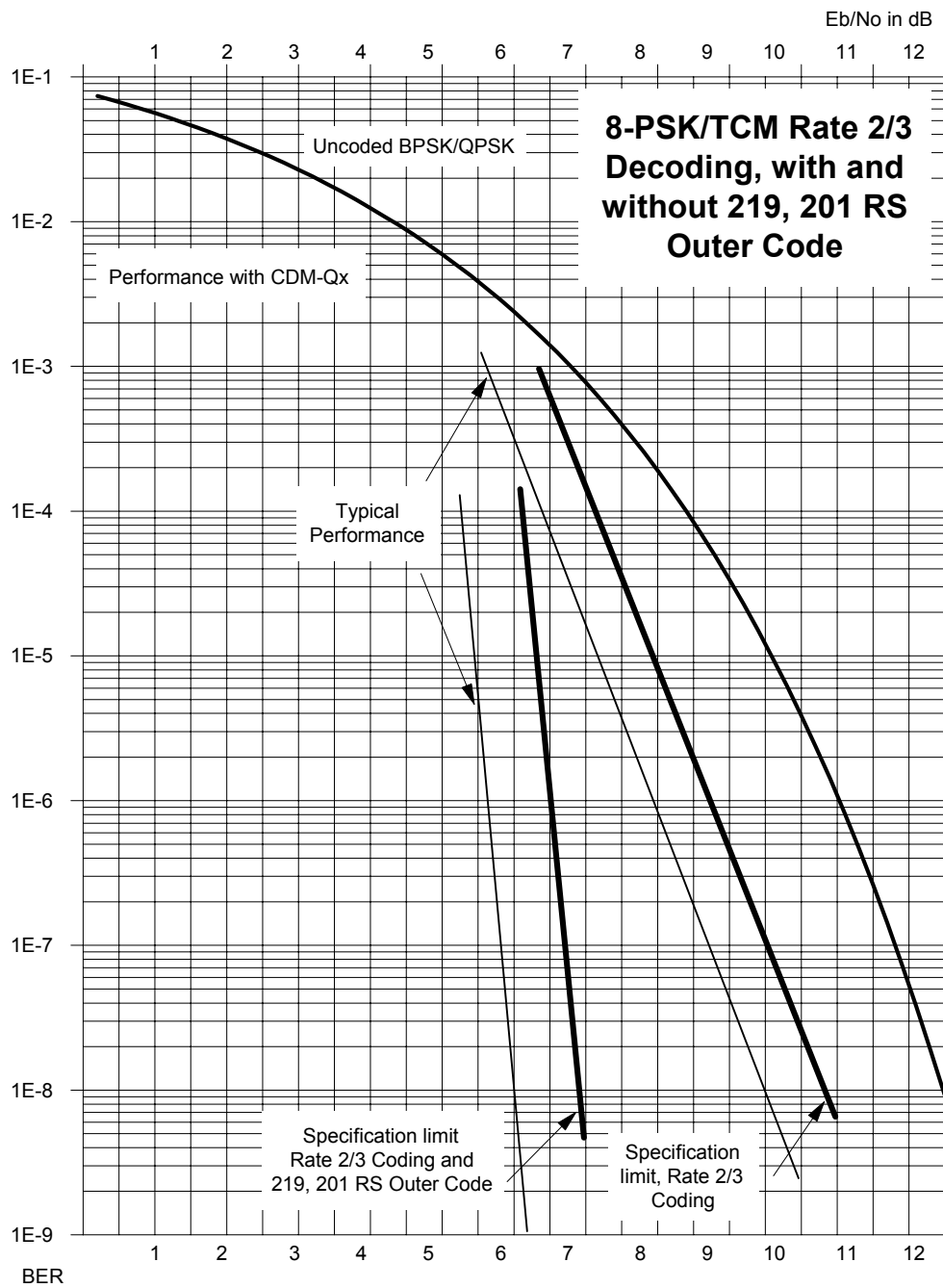
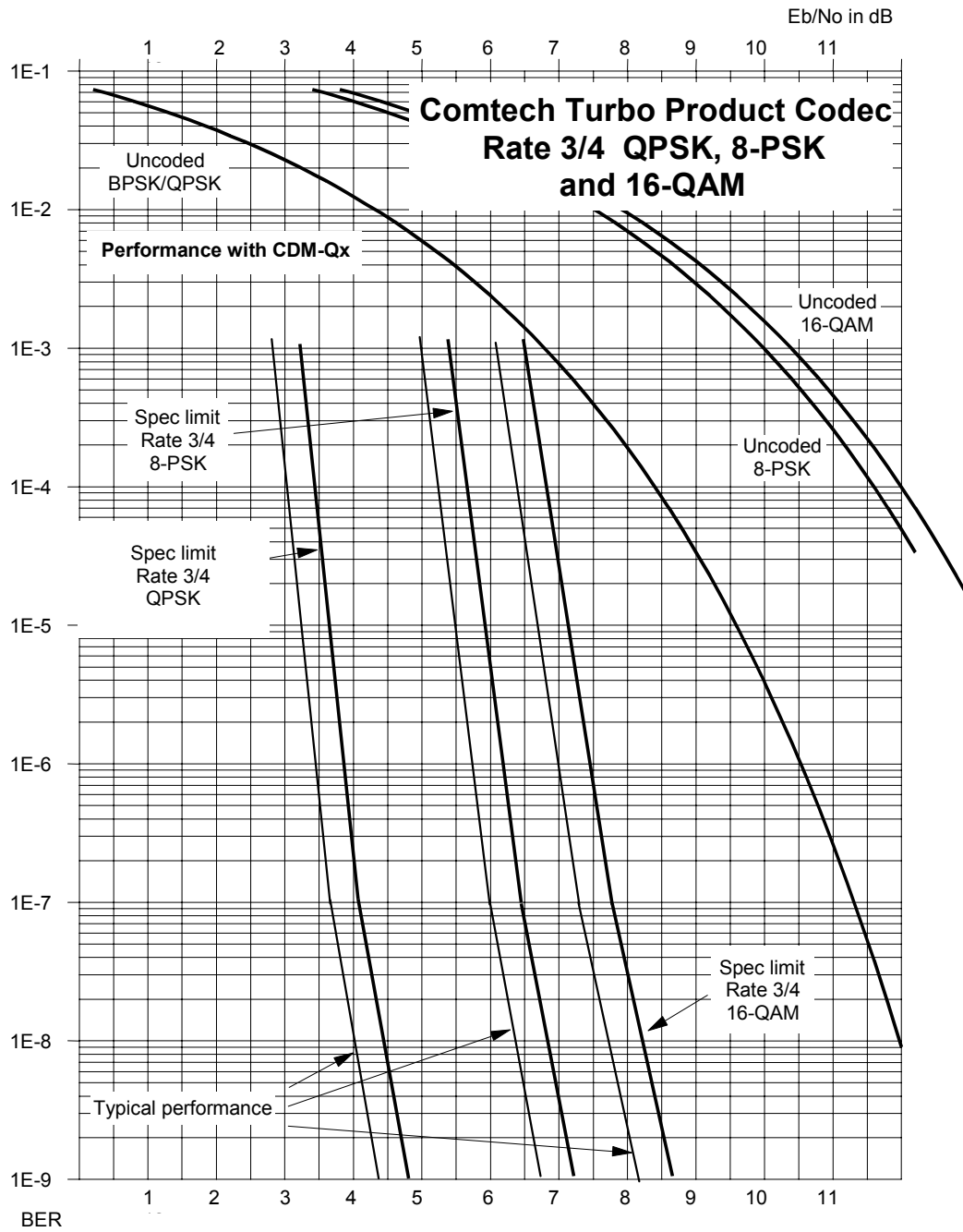
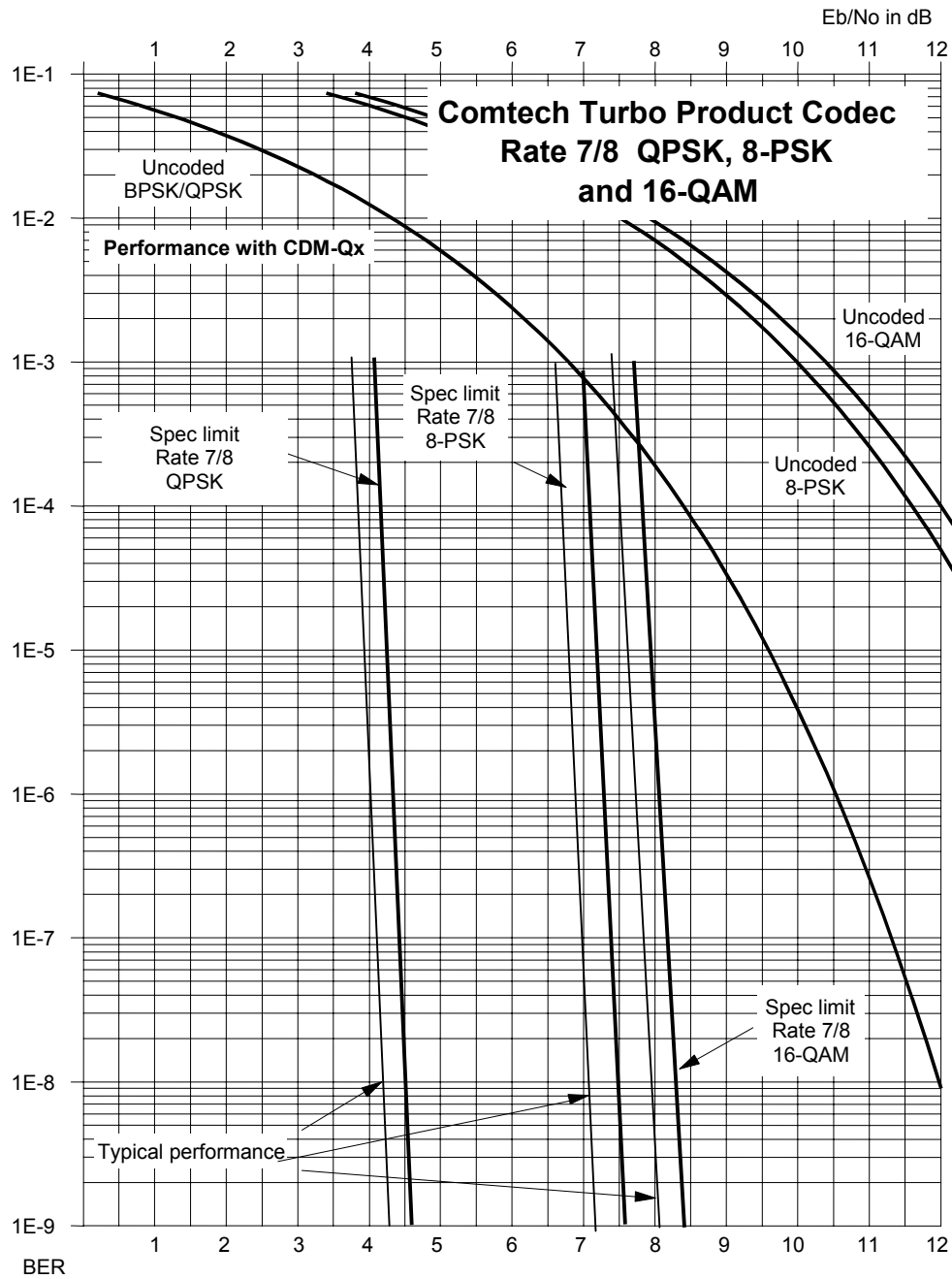

Figure 6-3. 8-PSK/TCM Rate 2/3 with and without concatenated R-S Outer Code



**Figure 6-4. Comtech EF Data Turbo Product Codec
Rate 3/4 QPSK, 8-PSK and 16-QAM**



**Figure 6-5. Comtech EF Data Turbo Product Codec
Rate 7/8 QPSK, 8-PSK and 16-QAM**

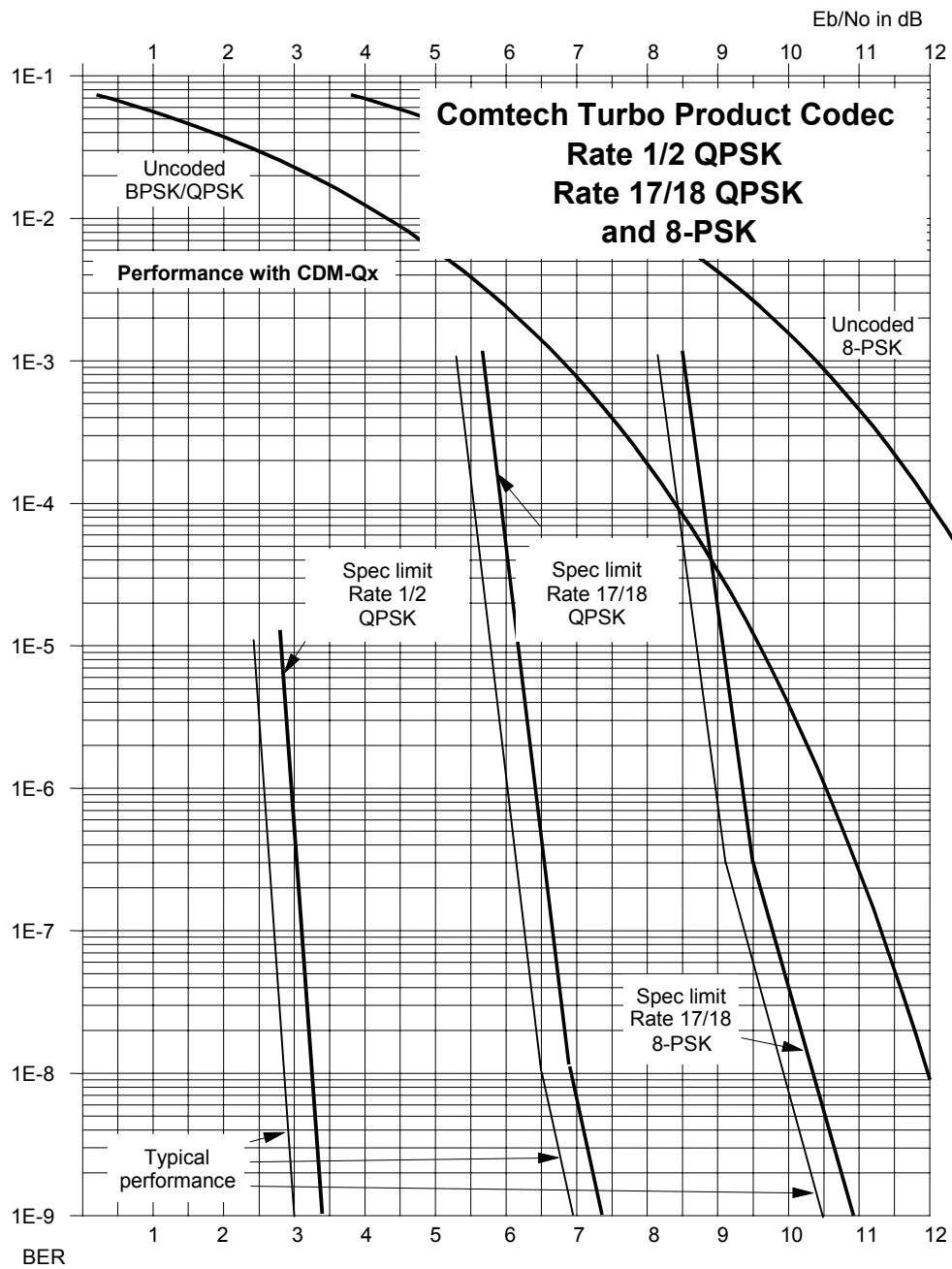

Figure 6-6. Rate 1/2 QPSK, Rate 17/18 QPSK and Rate 17/18 8-PSK

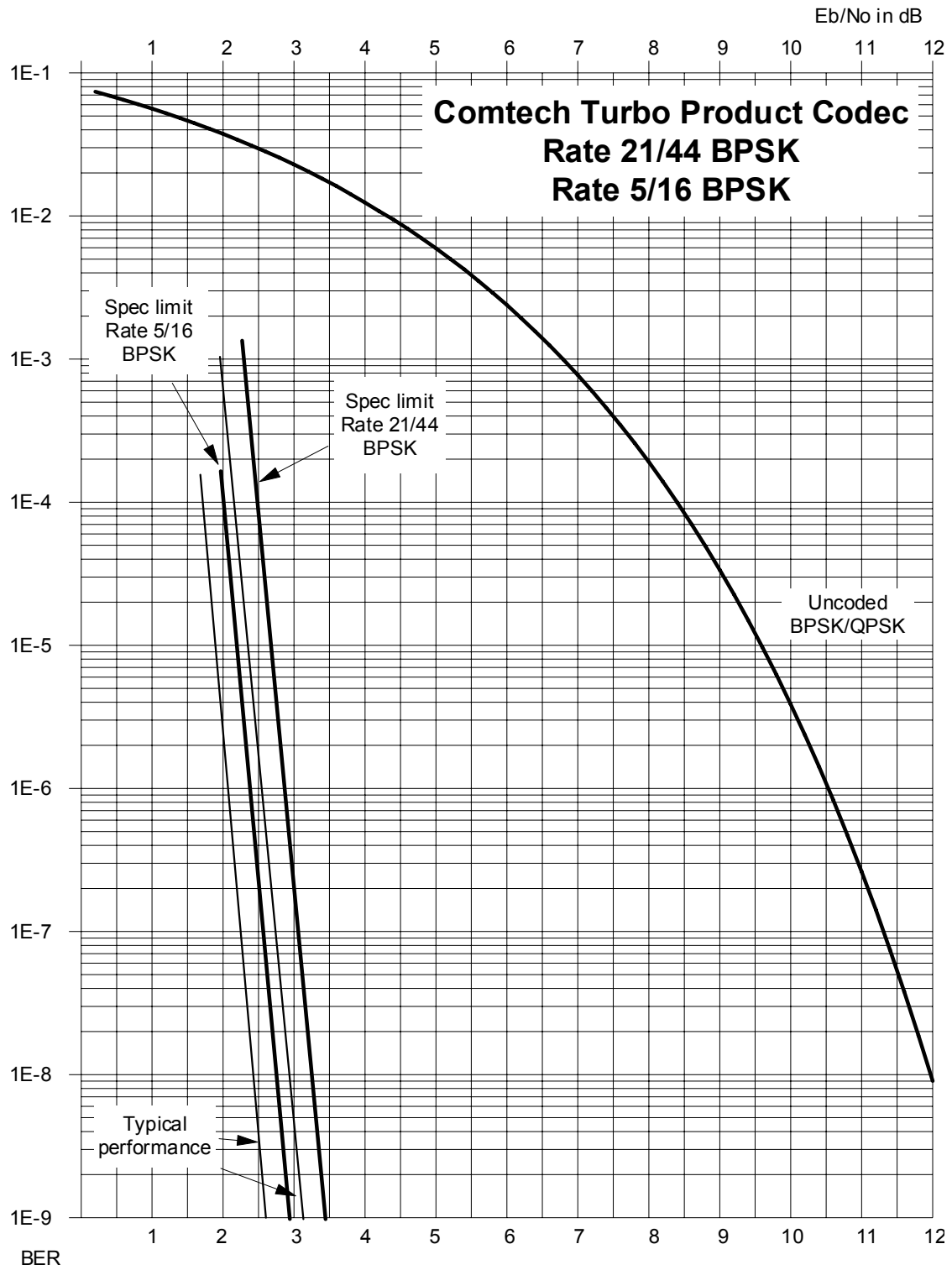

Figure 6-7. Rate 21/44 BPSK and Rate 5/16 BPSK Turbo

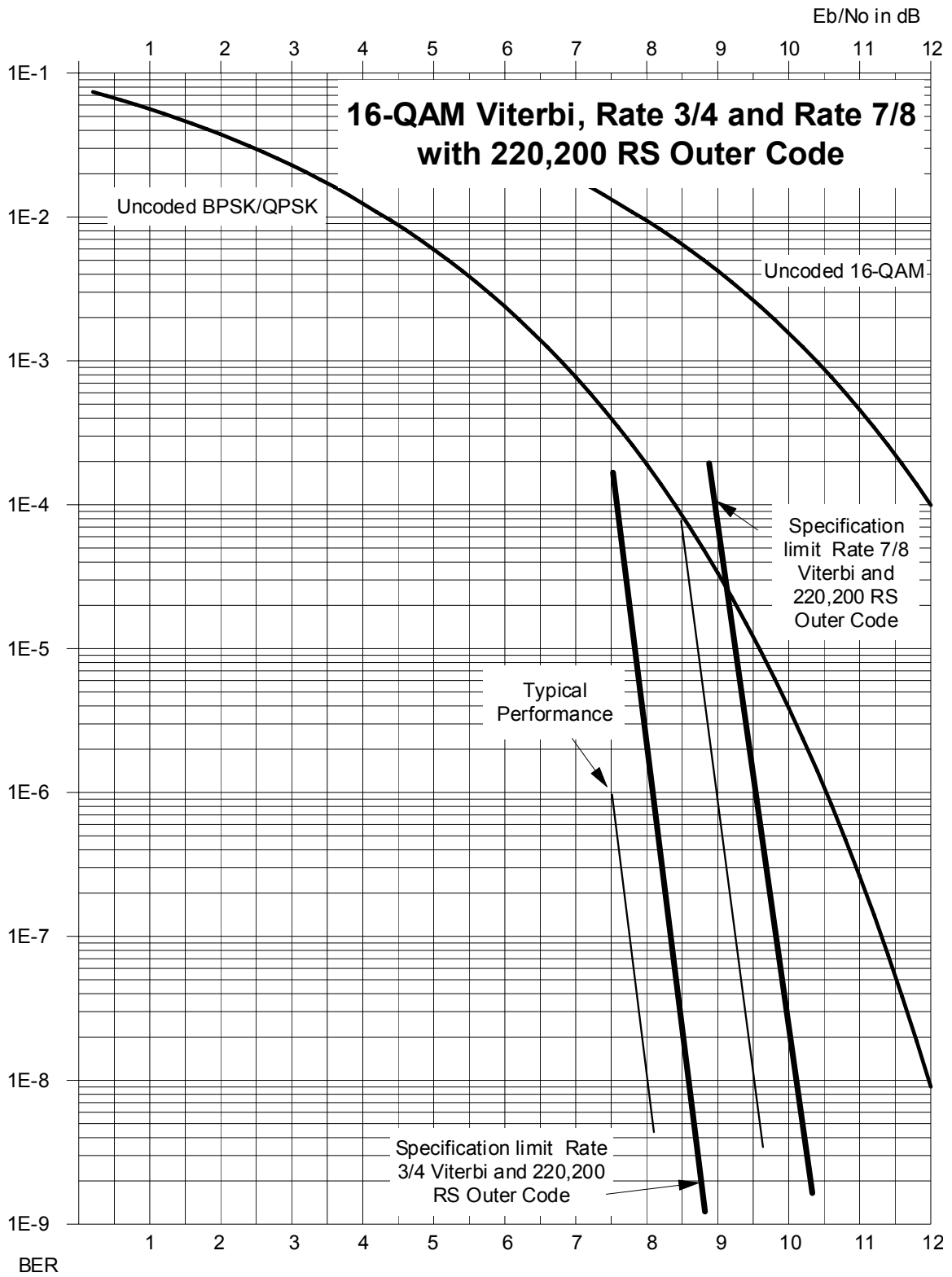

Figure 6-8. 16-QAM Viterbi, Rate 3/4 and Rate 7/8 with 220,200 R-S Outer Code

Chapter 7. EDMAC CHANNEL

7.1 Theory Of Operation

As explained earlier, EDMAC is an acronym for **E**mbded **D**istant-end **M**onitor **A**nd **C**ontrol. This is a feature, which permits the user to access the M&C features of modems that are at the distant-end of a satellite link.

This is accomplished by adding extra information to the user's data, but in a manner, which is completely transparent to the user.

On the transmit side:

The data is split into frames - each frame containing 1008 bits (except Rate 21/44 BPSK Turbo, or when the data rates exceed 2048 kbps, where the frame length is 2928 bits, and Rate 5/16 BPSK Turbo where the frame length is 3072 bits). 48 bits in each frame are overhead, and the rest of these bits are the user's data. This increases the rate of transmission by 5% (approximately 1.5% for the Turbo BPSK cases, and for all data rates greater than 2.048 Mbps). For example, if the user's data rate is 64 kbps, the actual transmission rate will now be at 67.2 kbps.

At the start of each frame a 12-bit synchronization word is added. This allows the demodulator to find and lock to the start of frame. At regular intervals throughout the frame, additional data bytes and flag bits are added (a further 36 bits in total). It is these additional bytes, which convey the M&C data.

When framing is used, the normal V.35 scrambler is no longer used. This V.35 approach is called 'self synchronizing', because in the receiver, no external information is required in order for the de-scrambling process to recover the original data. The disadvantage of this method is that it multiplies errors. On average, if one bit error is present at the input of the descrambler, 3 output errors are generated. However, there is an alternative when the data is in a framed format. In this case, a different class of scrambler may be used - one which uses the start of frame information to start the scrambling process at an exact known state. In the receiver, having synchronized to the frame, the de-scrambler can begin its processing at exactly the right time. This method does not multiply errors, and therefore has a clear advantage over V.35 scrambling. This is fortunate, as there is a penalty to be paid for adding the framing. By adding the extra 5% to the transmitted data rate, the effective E_b/N_0 seen by the user will degrade by a factor of $10 \log(1.05)$, or 0.21 dB (0.07 dB in the case of the two BPSK Turbo rates). The use of an externally synchronized scrambler and descrambler almost exactly compensates for this degradation. The net effect is that the user will see effectively identical BER performance whether framing is used or not.

On the receive side:

When the demodulator locks to the incoming carrier, it must go through the additional step of searching for, and locking to the synchronization word. This uniquely identifies the start of frame, and permits the extraction of the overhead bytes and flag bits at the correct position within the frame. In addition, the start of frame permits the de-scrambler to correctly recover the data. The user's data is extracted, and sent through additional processing, in the normal manner. The extracted overhead bytes are examined to determine if they contain valid M&C bytes.

7.2 M&C Connection

Data to be transmitted to the distant-end is sent to a local unit via the remote control port. A message for the distant-end is indistinguishable from a 'local' message - it has the same structure and content, only the address will identify it as being for a distant-end unit.

Before the M&C data can be successfully transmitted and received, pairs of units must be split into EDMAC Masters and EDMAC Slaves. Masters are local to the M&C Computer, and Slaves are distant-end.

Now, a unit that has been designated an EDMAC master not only responds to its own unique bus address, but it will also be configured to listen for the address, which corresponds to its EDMAC Slave. When a complete message packet has been received by the EDMAC Master, it will begin to transmit this packet over the satellite channel, using the overhead bytes, which become available.

Note: The ‘normal’ protocol for the message packet is not used over the satellite path, as it is subject to errors. For this reason, a much more robust protocol is used which incorporates extensive error checking.

At the distant-end, the EDMAC slave, configured for the correct address, receives these bytes, and when a complete packet has been received, it will take the action requested, and then send the appropriate response to the EDMAC Master, using the return overhead path on the satellite link. The EDMAC Master assembles the complete packet, and transmits the response back to the M&C Computer.

Apart from the round-trip satellite delay, the M&C Computer does not see any difference between local and distant-end units - it sends out a packet, addressed to a particular unit, and gets back a response. It can be seen that the EDMAC Master simply acts as forwarding service, in a manner, which is completely transparent.

7.3 Setup Summary

To access a distant-end unit:

- Designate a Master/Slave pair - Master at the local-end, Slave at the distant-end.
- On the local-end unit, enable framing, and EDMAC, defines the unit as MASTER, then enter the bus address. This is constrained to be ‘base 10’ meaning that only addresses such as 10, 20, 30, 40 etc, are allowed.
- Choose a unique bus address for the distant-end. This should normally be set to the ‘base 10’ address + 1. For example, if the MASTER unit is set to 30, choose 31 for the distant-end unit.
- On the distant-end unit, enable framing, and EDMAC, defines the unit as SLAVE, then enter the bus address. The orange EDMAC Mode LED should be illuminated.
- Set the local-end unit to RS485 remote control, and set the bus address of this local unit. The orange Remote Mode LED should be illuminated.
- Once the satellite link has been established, connect the M&C Computer, and begin communications, with both the local and distant end units.

NOTE: EDMAC modes are fully compatible with AUPC modes.

This page is intentionally left blank.

Chapter 8. AUTOMATIC UPLINK POWER CONTROL

8.1 Introduction

Automatic Uplink Power Control (AUPC) is a feature whereby a local modem is permitted to adjust its own output power level in order to attempt to maintain the Eb/No at the remote modem.



*The user **SHALL** obtain permission from the Satellite Operator to use this feature.*

Improper use of this feature could result in a transmitting terminal seriously exceeding its allocated flux density on the Operator's satellite. This could produce interference to other carriers, and could cause transponder saturation problems

To accomplish this, the framed (EDMAC) mode of operation must be used. The remote modem constantly sends back information about the demodulator Eb/No using reserved bytes in the overhead structure. The local modem then compares this value of Eb/No with a pre-defined target value. If the Remote Eb/No is below the target, the local modem will increase its output power, and hence, a closed-loop feedback system is created over the satellite link. A particularly attractive benefit of this feature is that whenever framed operation is selected, the remote demodulator's Eb/No can be viewed from the front panel display of the local modem. Note also that AUPC can be used simultaneously with EDMAC.

There are several important parameters associated with this mode of operation, and the user needs to understand how the AUPC feature works, and the implications of setting these parameters.

8.2 Setting AUPC Parameters

1. The user, under the menu (**CONFIG, MODE**) first ensures that EDMAC is selected. EDMAC may be selected as IDLE, or the unit may be defined as an EDMAC Master or Slave. The important consideration is that EDMAC framing should be enabled.
2. The user should verify that the remote modem also has EDMAC framing enabled.
3. The user, under the menu (**CONFIG, TX, POWER**) sets the nominal output power of the modem. This is done by selecting the MANUAL mode, then editing the TX output power level displayed.
4. The user will then select AUPC as the operating mode. At this point the user will be prompted to define four key parameters:

8.2.1 Target Eb/No

This is value of Eb/No that the user desires to keep constant at the remote modem.

If the Eb/No exceeds this value, the AUPC control will reduce the TX output power, but will never drop below the nominal value set.

If the Eb/No falls below this value, the AUPC control will increase the TX output power, but will never exceed the value determined by the parameter MAX RANGE.

- The minimum value the user can enter is 0.0 dB
- The maximum value the user can enter is 9.9 dB
- The default value is 3.0 dB
- The resolution is 0.1 dB

8.2.2 Max Range

This defines how much the modem is permitted to increase the output level, under AUPC control.

- The minimum value the user can enter is 0 dB
- The maximum value the user can enter is 9 dB
- The default value is 1 dB
- The resolution is 1 dB

8.2.3 Alarm

This parameter defines how the user wants the modem to act if, under AUPC control, the maximum power limit is reached.

The two choices are:

- NONE (no action)
- TX ALARM (generate a Tx alarm)

The default setting is NONE.

8.2.4 Demod Unlock

This defines the action the modem will take if the remote demodulator loses lock.

The two choices are:

- NOMINAL (reduce the Tx Output Power to the nominal value)
- MAXIMUM (increase the Tx Output Power to the maximum value permitted by the parameter MAX RANGE)

The default setting is NOMINAL.

(Note that if the local demod loses lock, the modem will automatically move its output power to the nominal value.)

8.3 Compensation Rate

As with any closed-loop control system, the loop parameters must be chosen to ensure stability at all times. Several features have been incorporated to ensure that the AUPC system does overshoot, or oscillate.

First, the rate at which corrections to the output power can be made is fixed at once every 4 seconds. This takes into account the round trip delay over the satellite link, the time taken for a power change to be reflected in the remote demodulator's value of Eb/No, and other processing delays in the modems.

Second, if the comparison of actual and target Eb/No yields a result that requires a change in output power, the first correction made will be 80% of the calculated step. This avoids the possibility of overshoot. Subsequent corrections are made until the difference is less than 0.5 dB. At this point, the output power is only changed in increments of 0.1 dB, to avoid 'hunting' around the correct set point.

8.4 Monitoring

The remote demodulator's value of E_b/N_0 can be monitored at all times, either from the front panel (**MONITOR, AUPC**) or via the remote control interface. The resolution of the reading is 0.2 dB. For all values greater than or equal to 16 dB, the value 16.0 dB will be displayed. As long as framing is enabled, the value will still be available, even though AUPC may be disabled.

Also displayed is the current value of Tx power increase. If EDMAC framing is enabled, but AUPC is disabled, this will indicate 0.0 dB. This value is also available via the remote control interface.



Comtech EF Data strongly cautions against the use of large values of permitted power level increase under AUPC control. Users should consider using the absolute minimum range necessary to improve rain-fade margin

Chapter 9. DoubleTalk™ Carrier-in-Carrier® OPERATION

The Modem optionally incorporates a proprietary technology licensed from Applied Signal Technology, Inc. called DoubleTalk™, hereafter referred to as DoubleTalk Carrier-In-Carrier (CnC) when implemented in Comtech EF Data modems. CnC essentially allows two carriers to share the same channel.

Traditional full-duplex links utilize frequency division multiplexing to allow communications in two directions. This requires allocating two frequency bands, one for each direction (A and B). CnC allows the two carriers to reside on the same center frequency allowing the duplex link to consume half the bandwidth as that of FDMA.

All of the following requirements must be met before carrier in carrier will function correctly.

1. Both of the earth stations must be able to see each other's carriers.
2. The modulator and demodulator must be "grouped" together for CnC to operate.
3. The relative power level between the two carriers must be $< \pm 10$ dB of each other. For optimal performance the carriers should be $< \pm 7$ dB of each other.
4. The symbol rate ratio of the two carriers should be $< 3:1$ (either way).

It is recommended that the user start with the traditional FDMA configuration as shown in Figure 10-1. This allows the user to establish the links, make sure the modems and RF equipment are all functioning correctly and that a reasonable Eb/No has been set in each direction for the modulation and code rate selected.

Then the modem generating the "B" carrier in this example should be relocated in frequency to be "on top" of carrier "A". At this point the demodulator-receiving carrier "A" will lose lock. The carrier in carrier function must now be enabled in the Rx configuration menus. Once CnC is turned on the demodulator will perform a search for a

copy of the outbound modulators signal in time and frequency within the composite signal received by the demodulator.

When the search algorithm has found the carrier, the modem front panel will report search successful! It will also display an accurate value for the delay of the signal. The demodulator will then reconfigure itself to match the delay value, cancel out the interfering carrier (user's outbound) then lock to and demodulate the desired carrier.

The modem is like all Comtech EF Data modems in that it has a full compliment of receive monitored parameters. But for CnC operation a new parameter has been added. To access this feature, change the menu from config Rx to monitor Rx, CnC and the following parameters will be displayed. The normal BER, Eb/No and the new is the ratio between the interferer and the desired carriers. The value display is the difference in dB of the interferer over the desired carrier. This value is signed as the interferer (which the user side of the link has control over) can be greater or less than the desired you are trying to receive. This is an invaluable piece of information as with two carriers on top of each other it is otherwise impossible to accurately tell if one side or the other should experience a fade. The CnC monitor menu will also report the frequency offset between the two carriers.

Once this side of the link is configured and running properly, the other side of the link must be configured so that the Rx frequency is the same as the Tx and CnC is turned on. At this point both sides of the link should be locked and passing traffic normally.

Once the links have been configured such that the Eb/No values with good weather conditions are such that there is an appropriate fade margin, record the ratio value so that between the Eb/No value of the desired and the ratio value the user can determine if the link has degraded.

If the outbound carrier should go down the demodulator may drop sync but will relock to the desired carrier. When the outbound carrier returns the demod may be able to relock rapidly if the outage was brief or it may have to perform another search first. If the desired carrier should go down the demodulator will continue to cancel the outbound but will be unlocked with respect to the desired carrier. When the carrier returns the demod will relock.

While there are several parameters that can be configured when using CnC, it is recommend to leave them set to the factory default settings. These include changing the minimum delay value (in milli seconds) for the search function. The typical satellite delay will range from about 230 to 270 ms. If the minimum value is increase to say 200 ms the acquisition time will not be significantly improved and if the unit should be tested at the IF level in the future it would not lock as the delay would be in the micro seconds. The maximum delay can be decreased from 290 ms, but again the acquisition time will not be significantly improved. The other parameter is the reacquisition delay value. This determines how long the demodulator will wait to perform another search for the outbound carrier.

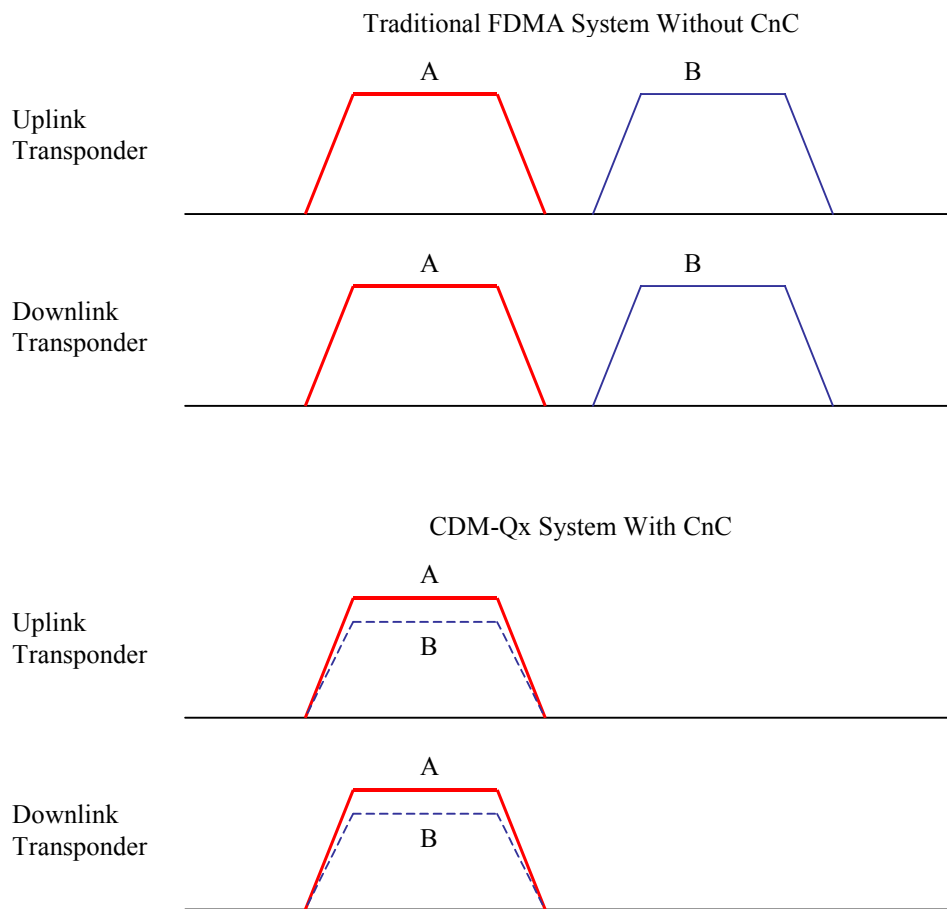

Figure 10-1. Transponder Utilization with and without CnC®

Chapter 10. REDUNDANCY

Redundancy is built into the modem and can be enabled using the FAST optioning. Redundancy can be selected so as to perform back up in the following scenarios:

- 1:1, (one modulator for one modulator), (one demodulator for one demodulator), (one modem for one modem)
- 1:2, (one modulator for two modulators), (one demodulator for two demodulators)
- 1:3, (one modulator for three modulators), (one demodulator for three demodulators)

Location of the modules in the chassis is critical for correct operation of the redundancy functions. When single modules are being backed up the back up unit must be located in the lower right-hand slot as viewed from the rear. When modules grouped as modems are being configured as redundant the back up modem has to be located in the right hand column of slots, with the modulator on top.

If a 1:1 modulator and a 1:1 demodulator configuration is desired, group the boards as modems and set up as described above.

Redundancy switching is implemented after the data interface. This means that the unit or units designated as the back ups do not require a data interface that matches the online units or an interface at all to operate as a back up.

Note: CEFD recommends that at least one extra interface be purchased, so that if an interface should fail in the field the interface can be replaced. This is easily accomplished by removing the modulator or demodulator, removing four screws, replacing the interface and reinstalling the four screws.

Notes:

Chapter 11. ETHERNET MANAGEMENT

11.1 Introduction

The base modem is equipped with an RJ-45, 10/100BaseT Ethernet management interface used for monitor and control purposes. This chapter of the manual will provide a high-level overview of the functionality provided by this interface.

11.2 Ethernet Management Interface Protocols

The modem 10/100BaseT Ethernet Management Interface supports three (3) different management protocols:

- Web Server interface for complete product management
- SNMP with public and private MIB
- Telnet interface for remote product M&C



Please make sure the unit is in Ethernet Remote Mode (Config,Remote,Ethernet) in order to access the Web server, SNMP, or Telnet. It's not recommended to do write access using Web, SNMP, and Telnet at the same time.

11.3 Web Server (HTTP) Interface

The embedded Web Server application provides the user with an easy to use interface to configure and monitor all aspects of the Base Modem. These web pages have been designed for optimal performance when using Microsoft's Internet Explorer 5.5 or higher. By typing `http://xxx.xxx.xxx.xxx` (where `xxx.xxx.xxx.xxx` =Base Modem IP address) on your browser, the Login prompt will appear.

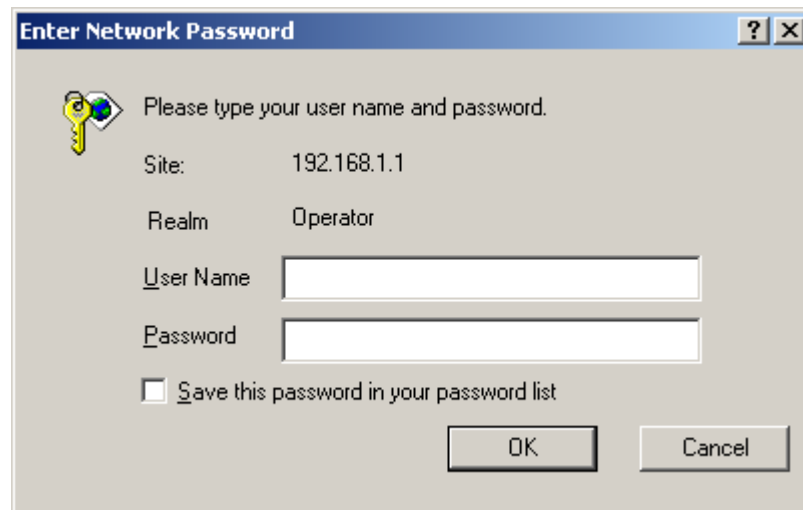

HTTP Login Access Levels are defined as follows:

User Interface	User Login Access Level		
	Admin User	Read/Write User	Read Only User
Web	FULL ACCESS TO ALL WEB PAGES	NO ACCESS TO ADMIN PAGES	NO ACCESS TO ADMIN PAGES
		FULL ACCESS FOR ALL OTHER WEB PAGES	VIEW ONLY ACCESS FOR ALL OTHER WEB PAGES

Default Name/Passwords are:

- Admin comtech/comtech
- Read/Write opcenter/1234
- Read Only monitor/1234

11.3.1 Web Server Menu Tree

Table 12-1. Web Server Menu Tree

Level 1	Level 2
Home	Home
	Contact
	Support
Admin	Access
	Remote
Config Mdm	Quick View
	Unit Status
Maint	Unit Info



Please make sure that the web browser does not use the old cached web page once you visited the same page.

To see the installed cards in the chassis, click **Quick View** under **Config Mdm**. It should be noted that the user needs to wait for the whole page to display, that is, the left-hand side of the page should display at least the word **Base**. An example is shown below:

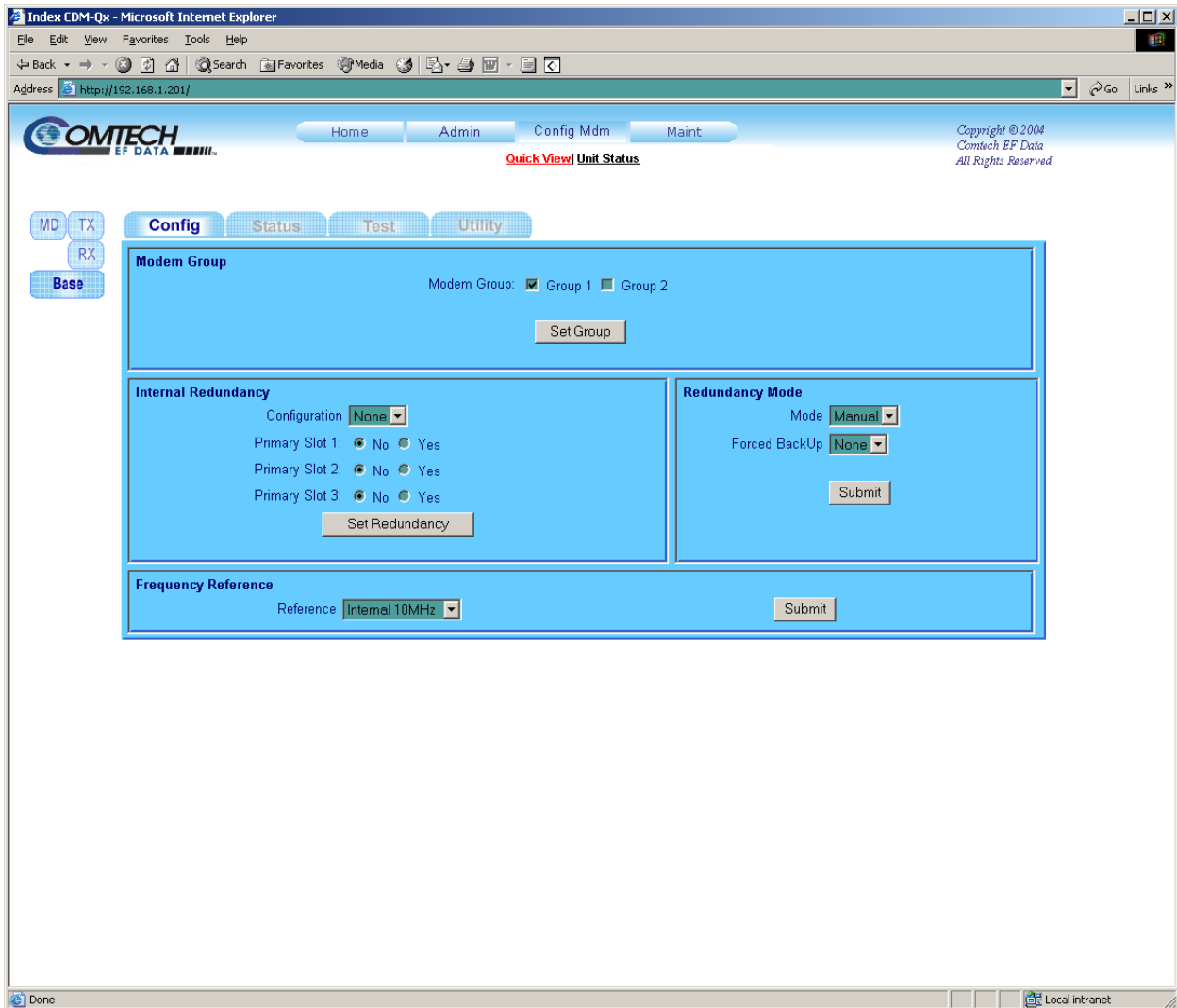

As shown on the left-hand side of the web page, the CDM-Qx has two Tx cards and two Rx cards (one Tx and one Rx grouped as modem, and the others are individual Tx and Rx). In this page, the **Base** is highlighted, that means the current page that is being displayed belongs to the **Base**. At the center of this page, the sub-menu **Config**, **Status**, **Test**, **Utility**, allows the user to navigate the **Base** configuration, status, test, and utilities. For this example, **Config** is highlighted which means **Base** configuration. The word **Base** is being used to designate the common and grouped functions of the installed cards (Tx or Rx).

To see the configuration of the cards which are grouped as modem, just mouse click **MD** icon (single click only). Clicking any of these icons will be highlighted. As will be shown in the next example is the configuration of the cards grouped as modem.

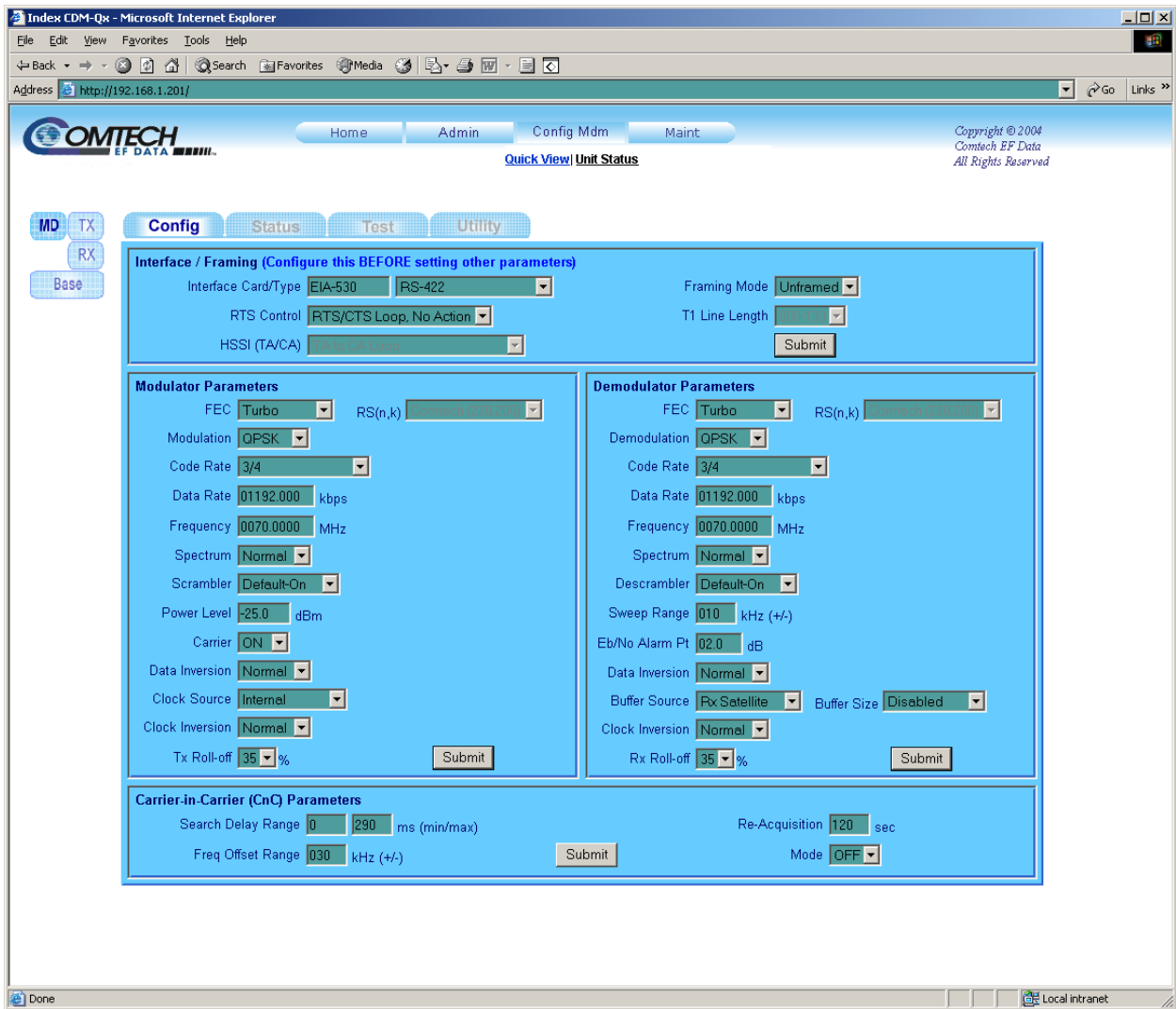

As you can see the **MD** icon is highlighted as well as the **Config**. In this case, both the modulator and demodulator parameters are accessible.

If **TX** icon is selected, only the modulator parameters will be displayed and accessible. If **RX** icon is selected, only the demodulator parameters will be displayed and accessible.

Using the web browser, the user can view the constellation of the demodulated signal as shown below:

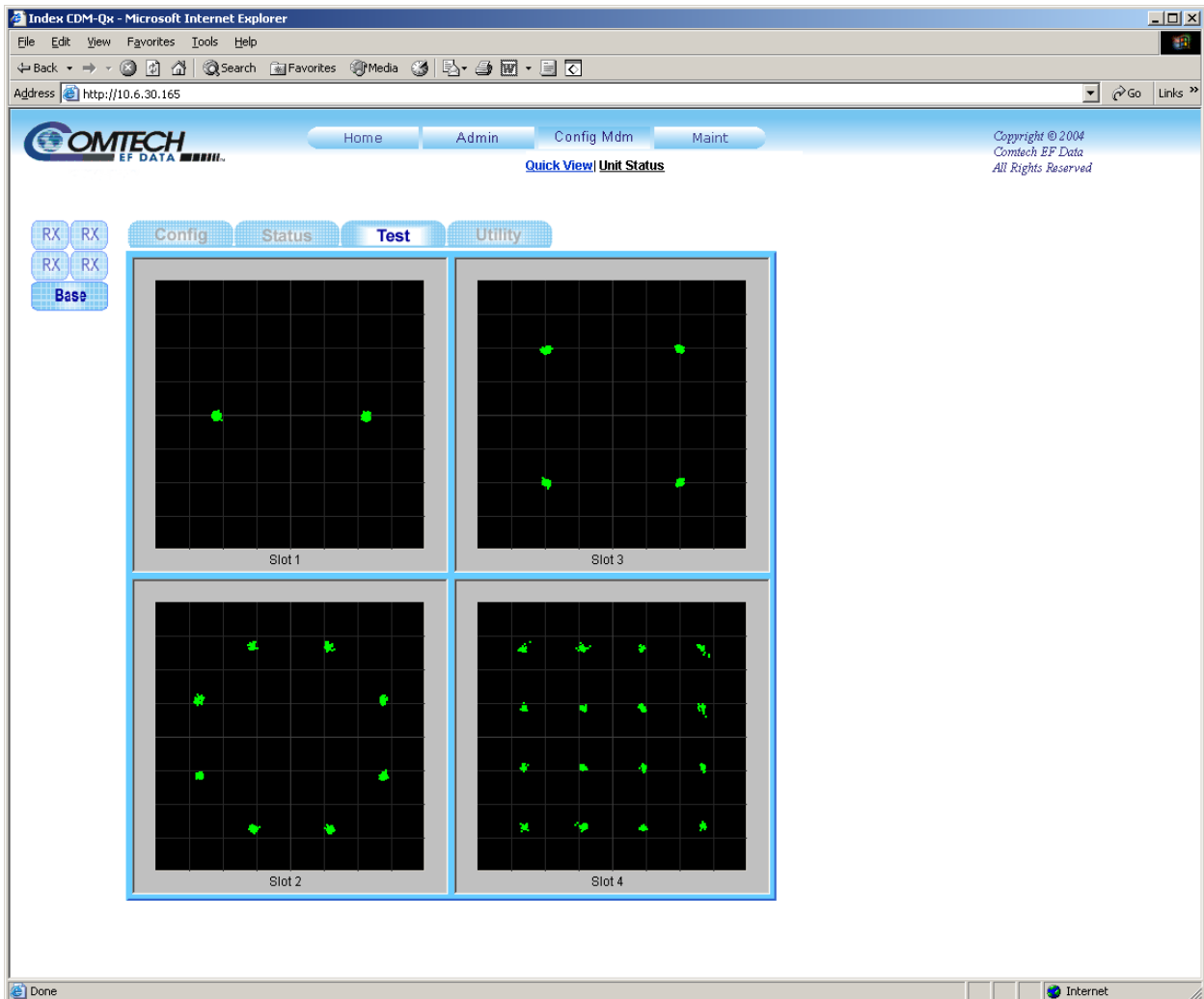

In this example, the CDM-Qx has four (4) Rx cards installed. Clicking the **Base** and then **Test**, will allow the user to view all the constellations of all the demodulators at once. The user can also view one constellation at a time by just selecting one **RX** only.

Since the introduction of the spectrum analyzer feature in the CDM-Qx, the user can view the spectrum of the signal as shown below:



When the spectrum analyzer feature is turned ON, the demodulator handling this will not be allowed to receive traffic and built-in BERT monitor is ignored. It should be noted the web page only captures the spectrum.

11.4 SNMP Interface

The *Simple Network Management Protocol* (SNMP) is an application-layer protocol designed to facilitate the exchange of management information between network devices. The CDM-Qx SNMP agent supports both SNMPv1 and v2c.



For proper SNMP operation, the CDM-Qx MIB files must be used with the associated version of the CDM-Qx base modem M&C. Please refer to the CDM-Qx SW Release Notes for information on the required FW/SW compatibility.

11.4.1 Management Information Base (MIB) Files

MIB files are used for SNMP remote management and consist of Object Identifiers (OIDs). Each OID is a node that provides remote management of a particular function. A MIB file is a tree of nodes that is unique to a particular device.

There are three MIB files associated with the CDM-Qx:

MIB File/Name	Description
fw10874-2-.mib ComtechEFData MIB file	ComtechEFData MIB file gives the root tree for ALL Comtech EF Data products and consists of only the following OID: Name: comtechEFData Type: MODULE-IDENTITY OID: 1.3.6.1.4.1.6247 Full path: iso(1).org(3).dod(6).internet(1).private(4).enterprises(1).comtechEFData(6247) Module: ComtechEFData
fw11247-1- .mib CDM-Qx MIB file	MIB file consists of all of the OIDs for management of the modem functions
fw11247-2- .mib CDM-Qx Traps MIB file	Trap MIB file is provided for SNMPv1 traps common for base modems.

These MIB files should be compiled in a MIB Browser or SNMP Network Monitoring System server.

Note: The SNMP agent supports both “SNMPv1” and “v2c”. The “Traps” file only needs to be compiled if “SNMPv1” traps are to be used.

11.4.2 SNMP Community Strings

The modem uses community strings as a password scheme that provides authentication before gaining access to the modem agent's MIBs.

In “**SNMP v1/v2c**”, the community string is sent unencrypted in the SNMP packets. Caution must be taken by the network administrator to ensure that SNMP packets travel only over a secure and private network if security is a concern. A packet sniffer can easily obtain the community string by viewing the SNMP traffic on the network. The community string is entered into the MIB Browser or Network Node Management software and is used to authenticate users and determine access privileges to the SNMP agent.

The user defines three Community Strings for SNMP access:

- Read Community default = public
- Write Community default = private
- Trap Community default = comtech

11.4.3 SNMP Traps

The modem has the ability to send out SNMP traps when certain events occur in the modem. The modem sends out traps when an alarm or a fault occurs in the modem. These include unit faults, TX faults, RX faults, and ODU faults. A trap is sent both when a fault occurs and is cleared.

The modem supports both **SNMPv1** traps and **SNMPv2** notifications. The user using the `cdmQxSNMPTrapVersion` OID can configure which style of traps the modem sends.

The following are the MIB2 v1traps/v2 notifications that the modem supports:

MIB2 SNMPv1 trap: Authentication Failure 5

MIB2 SNMPv2 notifications: Authentication Failure 1.3.6.1.6.3.1.1.5.5

The following tables are the Alarms and Faults v1 traps / v2 notifications that the modem supports.

Alarms and Faults **SNMPv1** traps:\

CdmQxTxTrafficAlarmV2	6247272
CdmQxUnitAlarmV2	6247271
CdmQxRxTrafficAlarmV2	6247273

Alarms and Faults **SNMPv2** notifications:

CdmQxUnitAlarmV2	1.3.6.1.4.1.6247.27.2.0.1
CdmQxTxTrafficAlarmV2	1.3.6.1.4.1.6247.27.2.0.2
CdmQxRxTrafficAlarmV2	1.3.6.1.4.1.6247.27.2.0.3

11.5 Telnet Interface

The modem provides a Telnet interface for two primary functions:

- Equipment M&C via the standard equipment Remote Control protocol.
- Equipment M&C via Comtech Monitor and Control System (CMCS) application.

The Telnet interface requires user login at the **Administrator** level and **Read/Write** level.

The screen capture below shows the login process.

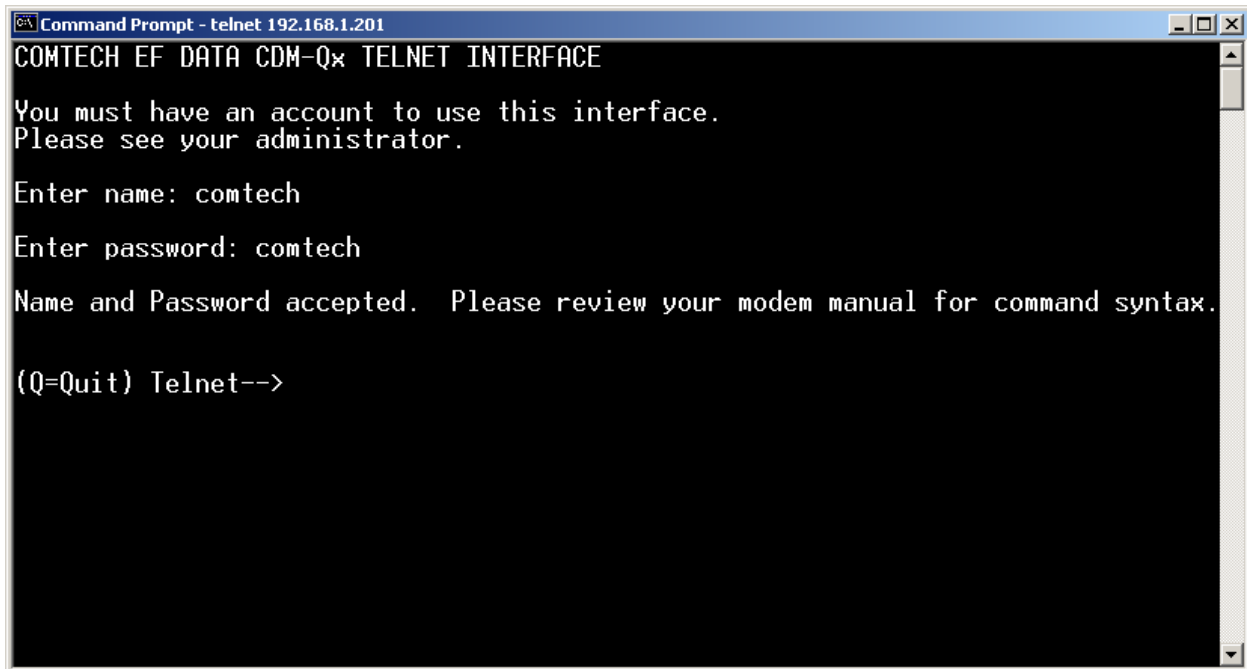

```
Command Prompt - telnet 192.168.1.201
COMTECH EF DATA CDM-Qx TELNET INTERFACE
You must have an account to use this interface.
Please see your administrator.
Enter name: comtech
Enter password: comtech
Name and Password accepted. Please review your modem manual for command syntax.
(Q=Quit) Telnet-->
```

Once logged into the Telnet interface as the Administrator, the user can access the standard remote control interface defined in Appendix C as shown in the example below:

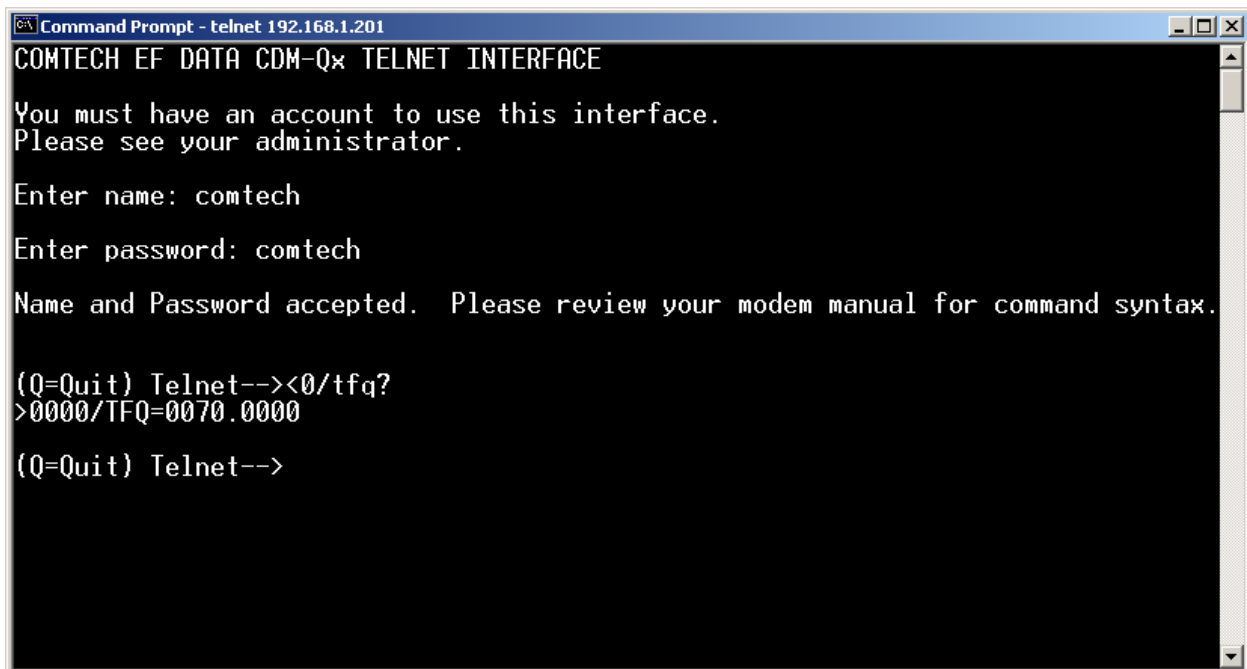

```
Command Prompt - telnet 192.168.1.201
COMTECH EF DATA CDM-Qx TELNET INTERFACE
You must have an account to use this interface.
Please see your administrator.
Enter name: comtech
Enter password: comtech
Name and Password accepted. Please review your modem manual for command syntax.
(Q=Quit) Telnet--><0/TFQ?
>0000/TFQ=0070.0000
(Q=Quit) Telnet-->
```

There is a disadvantage when using Windows DOS as Telnet Client. Since Windows DOS cannot translate a '\r' to a '\r\n' for the messages coming from Telnet Server, the multi-line command response (for example, FRW? Response) will be displayed as one line, with the latter lines overwrite the previous lines.

In order to view the full response messages, we recommend using HyperTerminal configured as Telnet Client. To do so, configure the HyperTerminal as following:

1. Connect using TCP/IP instead of COM1 or COM2;
2. ASCII setup: check both "Send line ends with line feeds" and "Append line feeds to incoming line ends" options.

See the following screen captures for examples.

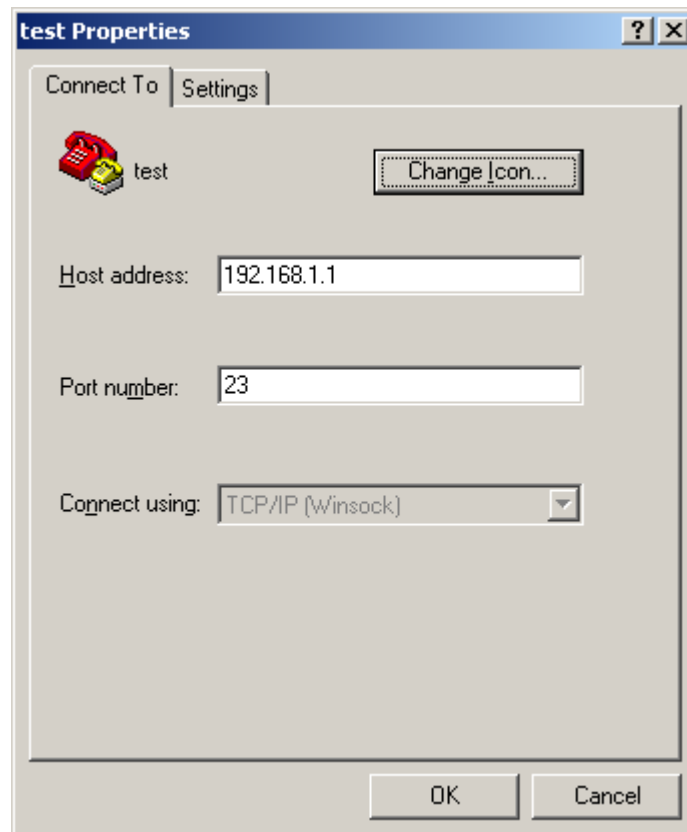

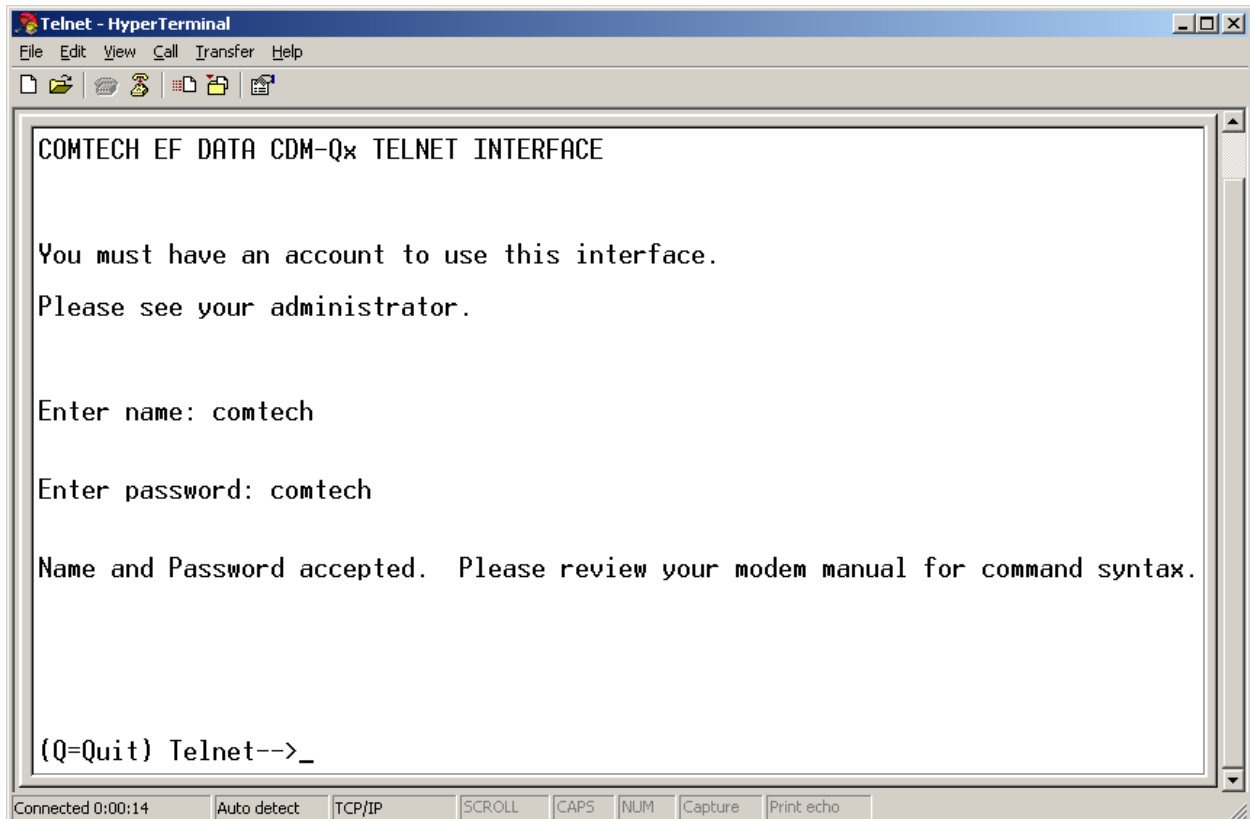
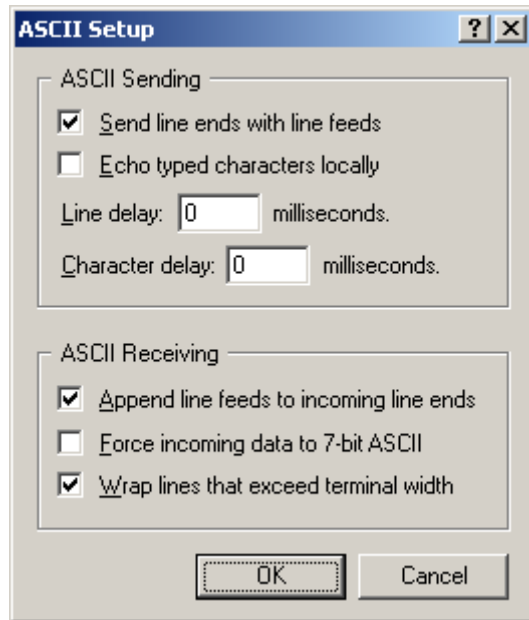

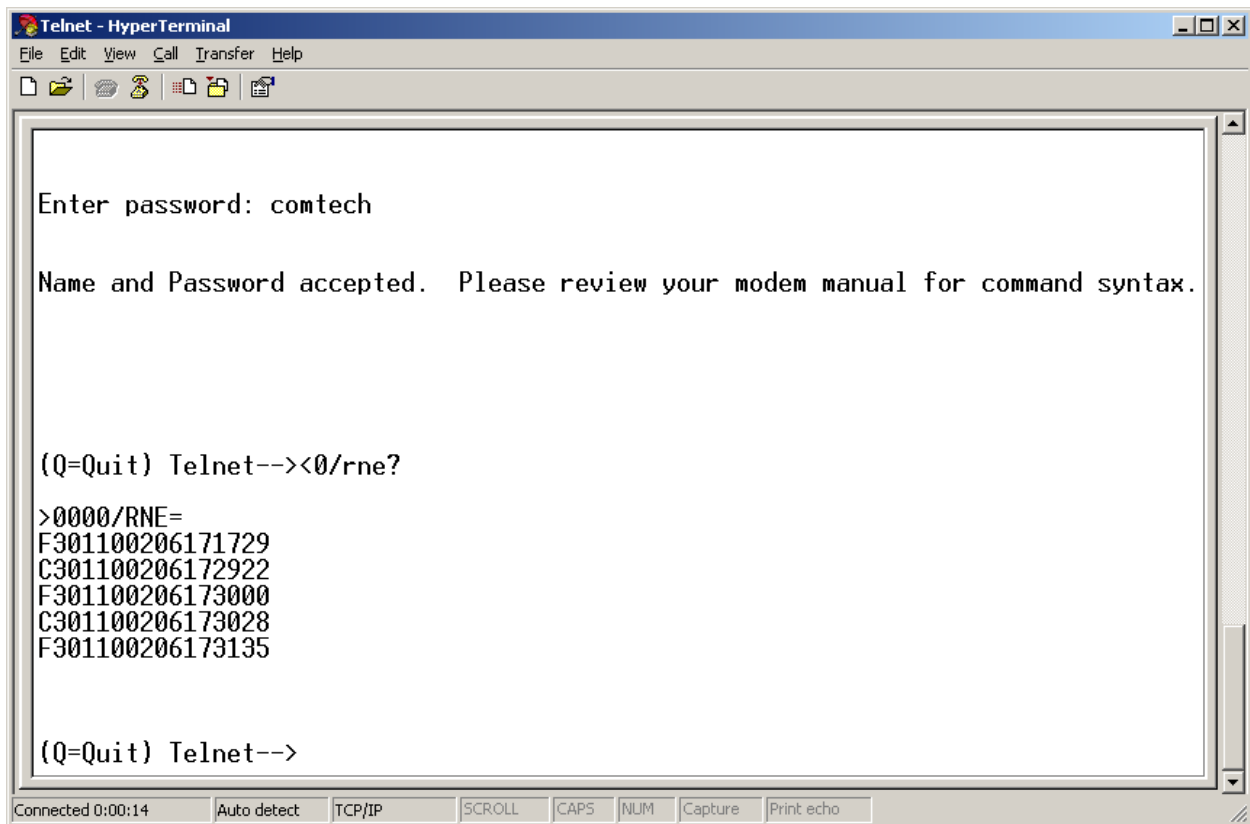

Appendix A. SUMMARY OF SPECIFICATIONS

A.1 Modulator

Note: Features not in the initial product release are identified in parentheses.

Modulation	See Table A-5
Symbol rate range	Up to 10 Msps (lower end is modulation and FEC rate dependant) Refer to Figure A-1 .
Data rate range	See Table A-5
Operating modes	Transparent, closed network, DoubleTalk™ Carrier-in-Carrier®
FEC	See Table A-5
Transmit filtering	Per INTELSAT IESS-308 (0.35) or 0.20 (for use with closer adjacent channel spacing)
Scrambling	V.35 or synchronous
Output frequency	50 to 90, 100 - 180 MHz, 100 Hz resolution (70/140 MHz IF) 950 to 1950 MHz, 100 Hz resolution (L-Band) Stability ± 1 ppm, 0 to 50°C (32 ° to 122 °F) (standard low-stability internal reference) Stability ± 0.1 ppm, 0 to 50°C (32 ° to 122 °F) (Optional high-stability internal reference) Stability ± 0.1 ppm, 0 to 50°C (32 ° to 122 °F) (standard reference for L-Band)
External Reference	1, 2, 5, 10, or 20 MHz @ 0 dBm to +20 dBm. Internal reference phase locks to external reference.
Harmonics and spurious	Greater than -55 dBc/4 kHz (typically <-60 dBc/4kHz) – measured from 25 to 400 MHz (70/140MHz IF) Greater than -55 dBc/4 kHz (typically <-60 dBc/4kHz) – measured from 500 to 2500 MHz (L-Band) Spurious measured relative to an unmodulated (CW) carrier
Transmit On/Off Ratio	55 dB minimum
Output phase noise	< 0.48 ⁰ rms double sided, 100 Hz to 1MHz (minimum of 10 dB better overall than the INTELSAT IESS-308/309 requirement)
Output power	-5 to -25 dBm, 0.1 dB steps (70/140MHz IF) -5 to -45 dBm, 0.1 dB steps (L-Band). Refer to Automatic Uplink Power Control section.
Power accuracy	± 1.0 dB over frequency, temperature, and number of modulators installed in the chassis

Output Connector	Type BNC Female (70/140MHz IF) Type N Female (L-Band)
Output Return Loss	≥ 19 dB (70/140MHz IF) ≥ 10 dB (L-Band)
Clocking Options	Internal, ± 1 ppm or 0.1 ppm (SCT) External, locking over a ± 100 ppm range (TT) Loop timing (Rx satellite clock) - supports asymmetric operation - Rx and Tx data rates do not need to be identical External Clock at transmit data rate.
External TX Carrier Off	By TTL 'low' signal or external contact closure - hardware function automatically over-rides processor

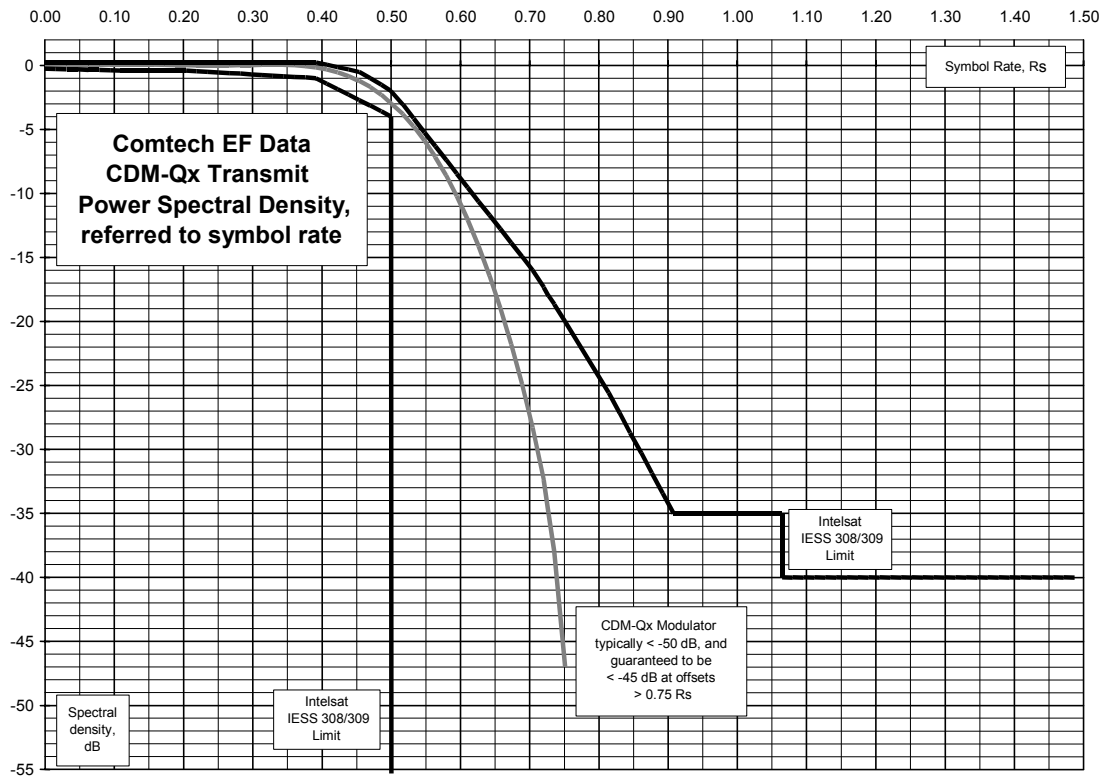

Figure A-1. Power Spectral Density Chart

A.2 Demodulator

FEC, Data rate range, operating modes, descrambling, input impedance/return loss etc, as per Modulator

Input power range (70/140MHz IF)	-15 to -45 dBm, ≤ 2.048 Msps (desired carrier) -15 to -40 dBm, > 2.048 and ≤ 4.096 Msps (desired carrier) -15 to -35 dBm > 4.096 Msps (desired carrier) +35 dBc maximum composite, up to -5 dBm			
Input power range (L-Band)	-130 + 10log(Symbol Rate in Hz) minimum signal level 50dB AGC range			
Acquisition range	± 1 to ± 32 kHz, programmable in 1kHz increments (below 64 ksps, \pm symbol rate/2) (70/140) ± 1 to \pm (symbol rate/2) kHz up to ± 200 kHz (L-Band)			
Acquisition time	Highly dependent on data rate, FEC rate, and demodulator acquisition range. Note that Reed-Solomon increases acquisition time, due to the additional time taken for the RS decoder to declare synchronization.			
Clock tracking range	± 100 ppm min			
VITERBI BER performance (met in the presence of two adjacent carriers, each 7 dB higher than the desired carrier)	For: BER= 10^{-5} BER= 10^{-6} BER= 10^{-7}	Rate 1/2 (B, Q) Guaranteed Eb/No: (typical value in parentheses) 5.4 dB (4.9 dB) 6.0 dB (5.5 dB) 6.7 dB (6.2 dB)	Rate 3/4 (Q) Guaranteed Eb/No: (typical value in parentheses) 6.8 dB (6.3 dB) 7.4 dB (6.9 dB) 8.2 dB (7.7 dB)	Rate 7/8 (Q) Guaranteed Eb/No: (typical value in parentheses) 7.7 dB (7.2 dB) 8.4 dB (7.9 dB) 9.0 dB (8.6 dB)
VITERBI and RS 220,200 or 200,180 Outer Code BER (with two adjacent carriers, each 7 dB higher than the desired carrier)	For: BER= 10^{-5} BER= 10^{-6} BER= 10^{-7}	Rate 1/2 (B, Q) Guaranteed Eb/No: (typical value in parentheses) 4.3 dB (4.0 dB) 4.4 dB (4.1 dB) 4.5 dB (4.2 dB)	Rate 3/4 (Q) Guaranteed Eb/No: (typical value in parentheses) 5.6 dB (4.7 dB) 5.8 dB (4.8 dB) 6.0 dB (5.2 dB)	Rate 7/8 (Q) Guaranteed Eb/No: (typical value in parentheses) 6.5 dB (6.0 dB) 6.7 dB (6.2 dB) 6.9 dB (6.5 dB)
8-PSK/TCM CODEC BER (With two adjacent carriers, each 7 dB higher than the desired carrier)	For: BER= 10^{-5} BER= 10^{-7} BER= 10^{-8}	Rate 2/3 8-PSK/TCM Guaranteed Eb/No: (typical value in parentheses) 7.9 dB (7.2 dB) 9.5 dB (8.7 dB) 10.4 dB (9.5dB)	Rate 2/3 8-PSK/TCM w/concatenated RS Guaranteed Eb/No: (typical value in parentheses) 6.3 dB (5.4 dB) 6.7 dB (5.8 dB) 6.9 dB (6.0 dB)	
TURBO PRODUCT CODEC Rate 1/2 QPSK Rate 21/44 BPSK Rate 5/16 BPSK BER	For: BER= 10^{-6}	Rate 1/2 (Q) Guaranteed Eb/No: (typical value in parentheses) 2.9 dB (2.6 dB)	Rate 21/44 (B) Guaranteed Eb/No: (typical value in parentheses) 2.8 dB (2.5dB)	Rate 5/16 (B) Guaranteed Eb/No: (typical value in parentheses) 2.4 dB (2.1dB)

(With two adjacent carriers, each 7 dB higher than the desired carrier)	BER=10 ⁻⁷	3.1 dB (2.7 dB)	3.1 dB (2.8 dB)	2.6 dB (2.3dB)
	BER=10 ⁻⁸	3.3 dB (2.8 dB)	3.3 dB (2.90dB)	2.7 dB (2.4dB)
TURBO PRODUCT CODEC Rate 3/4 QPSK Rate 3/4 8-PSK Rate 3/4 16-QAM BER (With two adjacent carriers, each 7 dB higher than the desired carrier)	For:	Rate 3/4 (Q) Guaranteed Eb/No: (typical value in parentheses)	Rate 3/4 (8-PSK) Guaranteed Eb/No: (typical value in parentheses)	Rate 3/4 (16-QAM) Guaranteed Eb/No: (typical value in parentheses)
	BER=10 ⁻⁶	3.8dB (3.4dB)	6.2 dB (5.8 dB)	7.4dB (7.0 dB)
	BER=10 ⁻⁷	4.1dB (3.7dB)	6.4 dB (6.0 dB)	7.8 dB (7.3 dB)
	BER=10 ⁻⁸	4.4dB (4.0dB)	6.8 dB (6.3 dB)	8.2 dB (7.7 dB)
TURBO PRODUCT CODEC Rate 7/8 QPSK Rate 7/8 8-PSK Rate 7/8 16-QAM BER (With two adjacent carriers, each 7 dB higher than the desired carrier)	For:	Rate 7/8 (Q) Guaranteed Eb/No: (typical value in parentheses)	Rate 7/8 (8-PSK) Guaranteed Eb/No: (typical value in parentheses)	Rate 7/8 (16-QAM) Guaranteed Eb/No: (typical value in parentheses)
	BER=10 ⁻⁶	4.3 dB (4.0 dB)	7.3 dB (6.6 dB)	8.1 dB (7.7 dB)
	BER=10 ⁻⁷	4.4 dB (4.1 dB)	7.4 dB (6.7 dB)	8.2 dB (7.8 dB)
	BER=10 ⁻⁸	4.5 dB (4.2 dB)	7.5 dB (6.8 dB)	8.3 dB (7.9 dB)
TURBO PRODUCT CODEC Rate 17/18 QPSK Rate 17/18 8-PSK BER (With two adjacent carriers, each 7 dB higher than the desired carrier)	For:	Rate 17/18 (Q) Guaranteed Eb/No: (typical value in parentheses)	Rate 17/18 (8-PSK) Guaranteed Eb/No: (typical value in parentheses)	
	BER=10 ⁻⁶	6.4 dB (6.0 dB)	9.3 dB (8.9 dB)	
	BER=10 ⁻⁷	6.7 dB (6.3 dB)	9.8 dB (9.4 dB)	
	BER=10 ⁻⁸	6.9 dB (6.5 dB)	10.3 dB (9.9 dB)	
HIGHER-ORDER MODULATION AND CODING (With two adjacent carriers, each 7 dB higher than the desired carrier)	For:	16-QAM Rate 3/4 Viterbi/RS Guaranteed Eb/No: (typical value in parentheses)	16-QAM Rate 7/8 Viterbi/RS Guaranteed Eb/No: (typical value in parentheses)	
	BER=10 ⁻⁶	8.1 dB (7.5 dB)	9.5 dB (9.0 dB)	
	BER=10 ⁻⁸	8.6 dB (8.0 dB)	10.1 dB (9.5 dB)	
Plesiochronous/ Doppler Buffer	Selectable size of 1024, 2048, 4096, 8192, 16384 and 32768 bits Size selection is displayed in bytes and milliseconds Supports asymmetric operation - when buffer is clocked from Tx clock, Rx and Tx rates do not need to be identical			
Monitor Functions	Eb/No estimate, 2 to 16 dB (± 0.10 dB accuracy) Corrected Bit Error Rate, 1E-3 to 1E-10 Frequency offset, ± 32 kHz range, 100 Hz resolution (70/140 MHz IF) Frequency offset, ± 200 kHz range, 100 Hz resolution (L-Band) Buffer fill state, in percent Receive signal level accuracy = ± 3.0 dB)			

A.3 Data Interfaces

Note: Features not in the initial product release are identified in parentheses.

EIA-530	Synchronous RS-232	
EIA-530 (3 selectable modes)	EIA-422/EIA-530 DCE (Rates up to 12 Mbps) Also supports X.21 V.35 DCE (Rates up to 12 Mbps) Synchronous RS-232 (Rates up to 300 kbps)	25-pin D-sub (female)
G.703 (Balanced)	1.544 Mbps T1 (Balanced 100 Ω) 2.048 Mbps E1 (balanced 120 Ω)	15-pin D-sub (female)
G.703 (Unbalanced)	1.544 Mbps T1 (unbalanced 75 Ω) 2.048 Mbps E1 (unbalanced 75 Ω)	BNC (female)
Multi-Port G.703 (Bal) 1 to 4 Ports E1 w/ D&I	2.048 Mbps E1 (balanced 120 Ω) Note: All 4 ports must be synchronous	(2) 9-pin, D-sub (female) (2 ports per DB-9)
EIA-612 / 613 (HSSI)	EIA-612/EIA-613 (Rates up to 20 Mbps)	50-pin, mini-D SCSI-II HSSI (female)
Modem Alarms (Present on all modules)	Relay outputs (Tx, Rx & unit faults) Demodulator I & Q test outputs (constellation) Demodulator Rx Signal Level output (0 to 2.5 volts) External carrier off input	15-pin D-sub (male)
Serial Remote Control	EIA-232 or EIA-485 modem control and monitoring	9-pin D-sub (male)
10/100BaseT	IP based monitoring & control	RJ-45

A.4 Automatic Uplink Power Control (Future)

Operating Mode	Requires Closed Network Framed mode for transport of Eb/No information from remote modem (EDMAC can be enabled or disabled)
Target Eb/No range	0 to 9.9 dB at remote demod (default is 4.0 dB)
Max AUPC range	0 to 9 dB (default is 3 dB)
Monitor functions	Remote demod Eb/No Tx power level increase (front panel or via remote control interface)

A.5 Data Rate Ranges

FEC Type	Modulation	Code Rate	Data Rate Range
Viterbi	BPSK	Rate 1/2	32 kbps to 5 Mbps
Viterbi	QPSK	Rate 1/2	32 kbps to 10 Mbps
Viterbi	QPSK	Rate 3/4	32 kbps to 15 Mbps
Viterbi	QPSK	Rate 7/8	32 kbps to 17.5 Mbps
Viterbi + R-S	BPSK	Rate 1/2	32 kbps to 4.5 Mbps
Viterbi + R-S	QPSK	Rate 1/2	32 kbps to 9.1 Mbps
Viterbi + R-S	QPSK	Rate 3/4	32 kbps to 13.7 Mbps
Viterbi + R-S	QPSK	Rate 7/8	32 kbps to 16 Mbps
Viterbi + R-S	16-QAM	Rate 3/4	349.1 kbps to 20 Mbps
Viterbi + R-S	16-QAM	Rate 7/8	407.3 kbps to 20 Mbps
TCM + RS	8-PSK	Rate 2/3	232.7 kbps to 18.3 Mbps
TPC	BPSK	Rate 5/16	32 kbps to 3.1 Mbps
TPC	BPSK	Rate 21/44	32 kbps to 4.7 Mbps
TPC	QPSK	Rate 21/44	32 kbps to 9.5 Mbps
TPC	QPSK	Rate 3/4	32 kbps to 15 Mbps
TPC	QPSK	Rate 7/8	32 kbps to 17.5 Mbps
TPC	QPSK	Rate 17/18	32 kbps to 18.888 Mbps
TPC	8-PSK	Rate 3/4	288 kbps to 20 Mbps
TPC	8-PSK	Rate 7/8	336 kbps to 20 Mbps
TPC	8-PSK	Rate 17/18	362 kbps to 20 Mbps
TPC	16-QAM	Rate 3/4	384 kbps to 20 Mbps
TPC	16-QAM	Rate 7/8	448 kbps to 20 Mbps

A.6 Framing Summary (Future)

	Transparent	EDMAC (Future)
Overhead added	None	5% to 2 Mbps 1.5% (see Note 2)
Available data rates and format	All rates and formats	All rates and formats
Overhead components	None	Remote control link between modems' processor
Additional Reed-Solomon Overhead	220/200 225/205 219/201 for IESS-310 mode	200/180
Scrambling (see Note 1)	Basic ITU V.35 (Intelsat)	Proprietary scrambler

Notes:

1. When Reed-Solomon is Off.
2. 1.5 % for Rates 5/16, 21/44 BPSK Turbo, Rate 21/44 QPSK Turbo, and all rates > 2 Mbps

A.7 Miscellaneous

Front panel	Tactile keypad, 6 keys (Up/Down, Left/Right, Enter/Clear) Vacuum Fluorescent Display (blue) - 2 lines of 40 characters
Loopbacks	Internal IF loopback, RF loopback, digital loopback, and inward/outward loopback
Fault relays	Hardware fault, RX and TX Traffic Alarms
M&C Interface	EIA-232 and EIA-485 (addressable multidrop, 2-wire or 4-wire), 10/100 BaseT Ethernet
M&C Software	SATMAC software for control of local and distant units
AC Consumption	(Depends on configuration) 60 watts (maximum)
AC Operating Voltage	100 to 240 VAC, +6%/-10% - autosensing (total absolute max. range is 90 to 254 VAC)
DC Operating Voltage	36 to 72 VDC, 6.25 amps
Temperature: Operating Storage	0 to 50°C (32 to 122°F) -25 to 85°C (-13 to 185°F)
Dimensions	1.75H x 19W x 19D inches (4.4H x 48W x 48D cm)
Weight	< 20 lbs (7.0 kg) approx (depends on configuration)
CE Mark	EMC Safety
FCC	Part 15

Appendix B. FLASH UPGRADING

The modem eliminates the need for updating firmware by physically replacing EPROMs. Instead, the modem uses 'flash memory' technology internally, and new firmware can be uploaded to the unit from an external PC, as follows:

```
Go to: www.comtechefdata.com
Click on: downloads
Click on: flash upgrades
```

This makes software upgrading very simple, and updates can now be sent via the Internet, E-mail, or on disk. The upgrade can be performed without opening the unit, by simply connecting the modem to the USB or Ethernet port of a computer.

B.1 Ethernet FTP upload procedure:

1. Identify the reflashable product, firmware number, and version for download.

The current base modem M&C version can be viewed at the top-level menu of the front panel display (press "CLR" button several times to view). Also, you can find the firmware information within the <Util > <Firmware > <Info> <Image#1, Image#2 > menu tree.

Using serial remote control, you can query the firmware revision levels with the <0/SWR? Command. (Abbreviated)

Or

<0/FRW? Command (Detailed)

2. Create a temporary directory (folder) on your PC.

Windows: Select File > New > Folder > and rename the New Folder to "temp" or another convenient and unused name. Assuming "temp" works, you should now have a "c:\temp" folder created.

Note: The c: is the drive letter used in this example. Any valid writable drive letter can be used.

Alternate Method: CMD Prompt: At the command prompt (c:\>) type "MD temp" without quotes (MD stands for make directory). This is the same as creating a new folder from Windows. You should now have a "c:\temp" subdirectory created where c: is the drive letter used in the example.

3. Download the correct firmware file to this temporary folder. (**Procedure is Under Construction.**)

Access the download server with the flash firmware data files link,
<http://206.223.8.10/linksite/flashupgrades/CDMQx/>

About Firmware Numbers, File Versions, and Formats:

The flashable files on the download server are organized by product first, then by firmware number, (make sure you know the correct firmware number; see step 1) version, if applicable, and release date. The base modem bulk firmware for the CDM-Qx will be F11245*_*_* (where the asterisks show revision, version and date).

The current version firmware release is provided. If applicable, one version prior to the current release is also available. Be sure to identify and download the desired version.

The downloadable files are stored in two formats: *.exe (self extracting) and *.zip (compressed).

Some firewalls will not allow the downloading of *.exe files. In this case, download the *.zip file instead.

For additional help with "zipped" file types, refer to "pkzip for windows", "winzip", or "zip central" help files. Pkzip for DOS is not supported due to file naming conventions.

4. Unzip the files in the temporary folder on your PC.

At least 3 files should be extracted:

- a. FW11245x.bin, where "x" is the revision (bulk image file)
- b. QxReleaseNotes_x.pdf, where "x" is the version (release notes)
- c. README_X.TXT, where "X" is the version (installation notes)

5. Connect the client PC to the CDM-Qx modem 10/100 Ethernet M&C via a hub or a switch, or directly to a PC with a crossover cable.



Base modem firmware can be loaded via the Ethernet M&C port.

Verify the communication and connection by issuing a "ping" command to the modem. You can find the IP address of the modem either remotely using the <0/IPA? command or from the front panel with the <Config> <Remote> <Remote> <Ethernet> menus.

To PING and FTP from DOS, press the "Start" button on the Windows toolbar, and select the "Run..." option.

- From Win95 or Win98, type "command".
- From WinNT, Win2K or WinXP, type "cmd".
- You can also use the "DOS Prompt" or "Command Prompt" icons in the Start Menu.
- Now change to the temporary directory you created earlier with "cd c:\temp".
- A quick "dir" will show the downloaded files.

6. Initiate an FTP session with the modem. The example is with a DOS window.

- From the PC, type "ftp xxx.xxx.xxx.xxx" where "xxx.xxx.xxx.xxx" is the IP address of the CDM-QXx .
- Enter your admin user name and password to complete login.
- Verify your FTP transfer is binary by typing "bin".
- Type "prompt" then type "hash" to facilitate the file transfers.

7. Transfer the files.

Type "put c:\temp\FW11245*.bin bulk:" to begin the file transfers. The destination "bulk:" must be all lower-case. It will take approximately 1 minute to transfer the file.

8. Verify the file transfer.

- The PC should report that the file transfer has occurred, and the display on the modem will stop reporting:

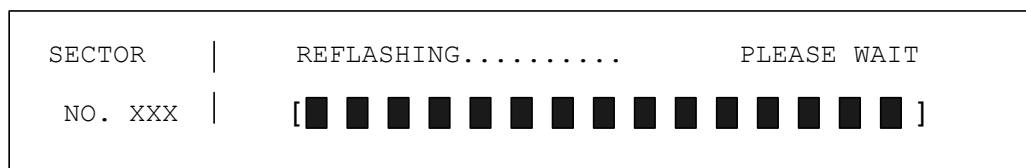

- Terminate the FTP session by typing "bye" and closing the DOS window.
- Verify that the new file loaded using the procedure in step 1.

9. Change the desired image to boot using the <Util> <Firmware> <Select> <left or right arrow to change to the other image>, then reboot the modem.

10. Verify the new software versions are booting by observing the following messages on the modem display:

Comtech CDM-Qx Modem
Firmware Version: 1.1.1

Appendix C. REMOTE CONTROL

This section describes the protocol and message command set for remote monitor and control of the CDM-QX Satellite Modem. The protocol is based on the CDM-570L, but is modified to add the new features and to separately address the four plug-in slots.

The electrical interface is either an RS-485 multi-drop bus (for the control of many devices) or an RS-232 connection (for the control of a single device), and data is transmitted in asynchronous serial form, using ASCII characters. Control and status information is transmitted in packets, of variable length, in accordance with the structure and protocol defined in later sections.

C.1 RS-485

For applications where multiple devices are to be monitored and controlled, a full-duplex (or 4-wire) RS-485 is preferred. Half-duplex (2-wire) RS-485 is possible, but is *not preferred*.

In full-duplex RS-485 communication there are two separate, isolated, independent, differential-mode twisted pairs, each handling serial data in different directions. It is assumed that there is a 'controller' device (a PC or dumb terminal), which transmits data, in a broadcast mode, via one of the pairs. Many 'target' devices are connected to this pair, which all simultaneously receive data from the controller. The controller is the only device with a line-driver connected to this pair - the target devices only have line-receivers connected.

In the other direction, on the other pair, each target has a tri-stateable line driver connected, and the controller has a line-receiver connected. All the line drivers are held in high-impedance mode until one (and only one) target transmits back to the controller.

Each target has a unique address, and each time the controller transmits, in a framed 'packet' of data, the address of the intended recipient target is included. All of the targets receive the packet, but only one (the intended) will reply. The target enables its output line driver, and transmits its return data packet back to the controller, in the other direction, on the physically separate pair.

RS-485 (full duplex) summary:

Two differential pairs - one pair for controller to target, one pair for target to controller.

- a. Controller-to-target pair has one line driver (controller), and all targets have line-receivers.
- b. Target-to-controller pair has one line receiver (controller), and all targets have tri-state drivers.

C.2 RS-232

This is a much simpler configuration in which the controller device is connected directly to the target via a two-wire-plus-ground connection. Controller-to-target data is carried, via RS-232 electrical levels, on one conductor, and target-to-controller data is carried in the other direction on the other conductor.

C.3 Basic Protocol

Whether in RS-232 or RS-485 mode, all data is transmitted as asynchronous serial characters, suitable for transmission and reception by a UART. In this case, the asynchronous character format is fixed at 8N1. The baud rate may vary between 1200 and 38,400 baud.

All data is transmitted in framed packets. The controller is assumed to be a PC, which is in charge of the process of monitor and control. The controller is the only device, which is permitted to initiate, at will, the transmission of data. Targets are only permitted to transmit when they have been specifically instructed to do so by the controller.

All bytes within a packet are printable ASCII characters, less than ASCII code 127. In this context, the Carriage Return and Line Feed characters are considered printable.

All messages from controller to target require a response (with one exception). This will be either to return data, which has been requested by the controller, or to acknowledge reception of an instruction to change the configuration of the target. The exception to this is when the controller broadcasts a message (such as Set time/date) using Address 0, when the target is set to RS-485 mode.

C.4 Packet Structure

Controller-to-target:

Start of Packet	Target Address	Address De-limiter	Instruction Code	Code Qualifier	Optional Arguments	End of Packet
< ASCII code 60 (1 character)	(4 characters)	/ ASCII code 47 (1 character)	(3 characters)	= or ? ASCII code 61 or 63 (1 character)	(n characters)	Carriage Return ASCII code 13 (1 character)

Example: <0135/TRQ=70.2345 {CR}

Target-to-controller:

Start of Packet	Target Address	Address De-limiter	Instruction Code	Code Qualifier	Optional Arguments	End of Packet
> ASCII code 62 (1 character)	(4 characters)	/ ASCII code 47 (1 character)	(3 characters)	=,?,!,*,# or - ASCII code 61, 63,33,42,35, 126 (1 character)	(From 0 to n characters)	Carriage Return, Line Feed ASCII code 13,10 (2 characters)

Example: >0654/RSW=32 {CR} {LF}

Each of the components of the packet is now explained.

C.4.1 Start Of Packet

Controller-to-Target: This is the character '<' (ASCII code 60)

Target-to-Controller: This is the character '>' (ASCII code 62)

Because this is used to provide a reliable indication of the start of packet, these two characters may not appear anywhere else within the body of the message.

The controller sends a packet with the address of a target – the destination of the packet. When the target responds, the address used is the same address to indicate to the controller the source of the packet. The controller does not have its own address.

C.4.2 Address

Up to 9999 devices can be uniquely addressed. The RS-485 base address is set by the front panel; the RS-232 base address is always zero. Each plug-in slot (as viewed from the back of the chassis) has its own address.

Slot	Address
Upper Left	Base
Lower Left	Base + 1
Upper Right	Base + 2
Lower Right	Base + 3

Common functions can be accessed through any of the four addresses. If several devices share a RS-485 bus, it must be noted that the Qx will require four addresses, and should be spaced apart accordingly. Empty slots in the Qx chassis still occupy an address.



A single CDM-Qx occupies four addresses. For modulator and demodulator grouped as modem, the address will be the same as the modulator.

C.4.3 Instruction Code

This is a three-character alphabetic sequence that identifies the subject of the message. Wherever possible, the instruction codes have been chosen to have some significance.

For example: TFQ for transmit frequency
RMD for receive modulation

This aids in the readability of the message, should it be displayed in its raw ASCII form. Only upper case alphabetic characters may be used (A – Z, ASCII codes 65 – 90).

C.4.4 Instruction Code Qualifier

This is a single character that further qualifies the preceding instruction code.

Code Qualifiers obey the following rules:

1. From Controller-to-Target, the only permitted values are:
= (ASCII code 61)
? (ASCII code 63)

They have these meanings:

The '=' code (controller-to-target) is used as the assignment operator and is used to indicate that the parameter defined by the preceding byte should be set to the value of the argument(s) which follow it.

For example, in a message from controller to target, TFQ=0950.0000 would mean 'set the transmit frequency to 950 MHz.'

The '?' code (controller to target) is used as the query operator and is used to indicate that the target should return the current value of the parameter defined by the preceding byte.

For example, a message from the controller to target, TFQ? Would mean 'return the current value of the transmit frequency.'

2. From Target to Controller, the only permitted values are:

= (ASCII code 61)
? (ASCII code 63)
! (ASCII code 33)
* (ASCII code 42)
(ASCII code 35)
~ (ASCII code 126)
\$ (ASCII code 36)
^ (ASCII code 94)
@ (ASCII code 64)

They have these meaning:

The '=' code (Target to Controller) is used in two ways:

First, if the controller has sent a query code to a target (for example TFQ?, meaning ‘what’s the Transmit frequency?’), the target would respond with TFQ=xxxx.xxxx, where xxxx.xxxx represents the frequency in question.

Second, if the controller sends an instruction to set a parameter to a particular value, then, providing the value sent in the argument is valid, the target will acknowledge the message by replying with TFQ= (with no message arguments).

The ? code (Target to Controller) is only used as follows:

If the controller sends an instruction to set a parameter to a particular value, then, if the value sent in the argument is not valid, the target will acknowledge the message by replying (for example) with TFQ? (with no message arguments). This indicates that there was an error in the message sent by the controller.

*The * code (Target to Controller) is only used as follows:*

If the controller sends an instruction to set a parameter to a particular value, then, if the value sent in the argument is valid, BUT the modem will not permit that particular parameter to be changed at that time, the target will acknowledge the message by replying (for example) with TFQ* (with no message arguments).

The ! code (Target to Controller) is only used as follows:

If the controller sends an instruction code which the target does not recognize, the target will acknowledge the message by echoing the invalid instruction, followed by the ! character with. Example: XYZ!

The # code (Target to Controller) is only used as follows:

If the controller sends a correctly formatted command, BUT the modem is not in remote mode, it will not allow reconfiguration, and will respond with TFQ#.

The ~ code (Target to Controller) is only used as follows:

If a message was sent via a local modem to a distant end device or ODU, the message was transmitted transparently through the local modem. In the event of the distant-end device not responding, the local modem would generate a response e.g. 0001/RET~, indicating that it had finished waiting for a response and was now ready for further communications.

The \$ code (target-to-controller) is only used as follows:

The target acknowledges the message indicating that there is no card installed in that slot.

The @ code (target-to-controller) is only used as follows:

The target acknowledges the message indicating that a Tx command was sent to an Rx card or vice-versa. For example: TFQ was sent to a demod.

The ^ code (target-to-controller) is only used as follows:

The target acknowledges the message indicating that the unit is in Ethernet mode. While in Ethernet mode, the unit cannot be serially queried for modem parameters. This mode will allow the user to access the Web server, SNMP, or Telnet.

C.4.5 Message Arguments

Arguments are not required for all messages. Arguments are ASCII codes for the characters 0 to 9 (ASCII 48 to 57), period (ASCII 46) and comma (ASCII 44), plus miscellaneous printable characters.

C.4.6 End Of Packet

Controller-to-Target: This is the 'Carriage Return' character (ASCII code 13)
Target-to-Controller: This is the two-character sequence 'Carriage Return', 'Line Feed'. (ASCII code 13, and code 10.) Both indicate the valid termination of a packet.

C.5 Remote Commands

The following remote commands are arranged in the following order:

- Transmit (TX) Commands
- Receive (RX) Commands
- Common Commands for TX or RX or Modem
- Query Commands
- Bulk Commands
- BUC Commands

Priority System = ITF(Highest Priority), FRM, RFT, RMD, RCR, and RDR (Lowest Priority), as indicated by **shading**. Any changes to a higher priority can override any of the parameters of lower priority.

Note: The following codes are used in the 'Response to Command' column:

=	Message ok
?	Received ok, but invalid arguments found
*	Message ok, but not permitted in current mode
#	Message ok, but unit is not in Remote mode
~	Time out of an EDMAC pass-through message
\$	Message ok, but no card is installed in the slot.
@	Message ok, but sending Tx command to an Rx card or vice-versa.
^	Message ok, but unit is in Ethernet mode.

C.5.1 TX Remote Commands

Parameter Type	Command (Instruction Code and Qualifier)	Arguments for Command or Response to Query	Description of Arguments	Response to Command (Target to Controller)	Query (Instruction Code and Qualifier)	Response to query (Target to Controller)
TX Frequency	TFQ=	9 bytes	Command or Query TX Frequency, 950 to 1950 MHz (L-Band units) 50 to 90 and 100 to 180 MHz (70/140 MHz units) Resolution=100 Hz Example: TFQ=0950.9872	TFQ= TFQ? TFQ* TFQ# TFQ\$ TFQ^ TFQ@	TFQ?	TFQ=xxxx.xxxx (see description arguments)
TX FEC Type	TFT=	1 byte, value of 0 though 7	Command or Query TX FEC coding type, where: 0=Reserved 1=Viterbi 2=Viterbi + Reed-Solomon 3=Reserved 4=Reserved 5=TCM+Reed-Solomon (Forces TCR=3 2/3) 6=Turbo 7=Reserved	TFT= TFT? TFT* TFT# TFT\$ TFT^ TFT@	TFT?	TFT=x (see description arguments)
TX Modulation Type	TMD=	1 byte, value of 0 though 5	Command or Query TX Modulation Type, where: 0=BPSK 1=QPSK 2=Reserved 3=8-PSK 4=16-QAM (Turbo or Viterbi + RS only) 5=Reserved Depending on FEC type, not all of these selections will be valid. Example: TMD=1 (QPSK)	TMD= TMD? TMD* TMD# TMD\$ TMD^ TMD@	TMD?	TMD=x (see description of arguments)

Parameter Type	Command (Instruction Code and Qualifier)	Arguments for Command or Response to Query	Description of Arguments	Response to Command (Target to Controller)	Query (Instruction Code and Qualifier)	Response to query (Target to Controller)
TX FEC Code Rate	TCR=	1 byte, value of 0 through 7	<p>Command or Query TX Code Rate, where: 0=Rate 5/16 (Turbo only) 1=Rate 21/44 (Turbo only) 2=Rate 1/2 3=Rate 2/3 (8-PSK, TCM+RS only) 4=Rate 3/4 5=Rate 7/8 6=Rate 17/18 (Turbo only) 7=Reserved</p> <p>Depending on FEC and Modulation Type, not all of these selections will be valid.</p> <p>Example: TCR=4 (Rate 3/4)</p>	TCR= TCR? TCR* TCR# TCR\$ TCR^ TCR@	TCR?	TCR=x (see description of arguments)
TX Reed-Solomon (n, k) values	TRS=	1 byte	<p>Command or Query. TX Reed-Solomon (n, k) values, where: 0=Unframed closed network (220,200) 1=EFD closed network (225,205) 2=IESS-310 compatible operation (219,201) 3=EDMAC mode, closed (200,180) – EDMAC only</p> <p>Notes: 1. Selection is valid only when TFT=2 or TFT=5. 2. For D&I++, selection 0,1, and 2 are supported.</p>	TRS= TRS? TRS* TRS# TRS\$ TRS^ TRS@	TRS?	TRS=x (see description of arguments)
TX Data Rate	TDR=	9 bytes	<p>Command or Query TX Data rate, in kbps, between 32 kbps and 20 Mbps depending upon code rate and modulation scheme. Resolution=1 bps. (See Chapter 5 for the valid rates)</p> <p><u>Query ONLY if Interface Type is Quad Drop & Insert (ITF=D).</u></p> <p>Example: TDR=02047.999 (2047.999 kbps)</p>	TDR= TDR? TDR* TDR# TDR\$ TDR^ TDR@	TDR?	TDR=xxxx.xxx (see description of arguments)

Parameter Type	Command (Instruction Code and Qualifier)	Arguments for Command or Response to Query	Description of Arguments	Response to Command (Target to Controller)	Query (Instruction Code and Qualifier)	Response to query (Target to Controller)
TX Spectrum Invert	TSI=	1 byte, value of 0, 1	Command or Query TX Spectrum Invert Selection, where: 0=Normal 1=TX Spectrum Invert Example: TSI=0 (Normal)	TSI= TSI? TSI* TSI# TSI\$ TSI^ TSI@	TSI?	TSI=x (see description of arguments)
TX Scrambler	TSC=	1 byte, value of 0, 1, 2	Command or Query Tx Scrambler state: where: 0=Off 1=ON (Default scrambler type) 2=ON IESS-315 (Turbo Only) Example: TSC=1 (Scrambler one)	TSC= TSC? TSC* TSC# TSC\$ TSC^ TSC@	TSC?	TSC=x (see description of arguments)
TX Carrier State	TXO=	1 byte, value 0 though 4	Command or Query TX Carrier State, where: 0=OFF due to front panel or remote control command 1=ON 2=RTI (Receive/Transmit inhibit) 3=OFF due to EXT H/W TX Carrier Off command (not a valid argument when used as a command) 4=OFF due to BUC warm up delay (not a valid argument in a command format) Example: TXO=1 (TX Carrier ON)	TXO= TXO? TXO* TXO# TXO\$ TXO^ TXO@	TXO?	TXO=x (see description of arguments)
TX Power Level	TPL=	4 bytes	Command or Query TX Output power level between -5 and -25 dBm (minus sign assumed) Example: TPL=13.4 (Command not valid in AUPC mode) Note: When output power level is enabled: Power level configuration is not allowed. Response will be TPL*. The response to the query TPL? Will be the adjusted levelled value.	TPL= TPL? TPL* TPL# TPL\$ TPL^ TPL@	TPL?	TPL=xx.x (see description of arguments)

Parameter Type	Command (Instruction Code and Qualifier)	Arguments for Command or Response to Query	Description of Arguments	Response to Command (Target to Controller)	Query (Instruction Code and Qualifier)	Response to query (Target to Controller)
TX Clock Source	TCK=	1 byte, value 0 1, 2	Command or Query TX Clock Source, where: 0=Internal 1=TX Terrestrial 2=Loop-Timed 3=Ext loop (G.703 interface only) Example: TCK=0 (Internal)	TCK= TCK? TCK* TCK# TCK\$ TCK^ TCK@	TCK?	TCK=x (see description of arguments)
TX Data Invert	TDI=	1 byte, value 0,1	Command or Query Invert Transmit Data 0=Normal 1=Inverted Example: TDI=1(Inverted TX Data)	TDI= TDI? TDI* TDI# TDI\$ TDI^ TDI@	TDI?	TDI=x (see description of arguments)
Tx Data Clock Invert	TCI=	1 byte, value 0,1	Command or Query Invert Transmit Data Clock 0=Normal 1=Inverted	TCI= TCI? TCI* TCI# TCI\$ TCI^ TCI@	TCI?	TCI=x (see description of arguments)
Tx Common Carrier State	TXC=	1 byte	Command or Query Tx carrier state common to all Tx 0=Off 1=On	TXC= TXC? TXC* TXC# TXC\$ TXC^ TXC@	TXC?	TXC=x (see description of arguments)
TX roll-off (alpha) factor	TXA=	1 byte	Command or Query Tx roll-off (alpha) factor 0=20% 1=35% (default)	TXA= TXA? TXA* TXA# TXA\$ TXA^ TXA@	TXA	TXA=x (see description of arguments)

C.5.2 RX Remote Commands

Parameter Type	Command (Instruction Code and qualifier)	Arguments for Command or Response to Query	Description of Arguments	Response to Command (Target to Controller)	Query (Instruction Code and Qualifier)	Response to query (Target to Controller)
RX Frequency	RFQ=	9 bytes	Command or Query Tx Frequency, 950 to 1950 MHz (L-Band units) 50 to 90/100 and 180 MHz (70/140 MHz units) Resolution = 100 Hz Example: RFQ=0950.9872	RFQ= RFQ? RFQ* RFQ# RFQ\$ RFQ^ RFQ@	RFQ?	RFQ=xxxx.xxxx (see description of arguments)
RX FEC Type	RFT=	1 byte, value of 0 through 6	Command or Query RX FEC Type, where: 0=Reserved 1=Viterbi 2=Viterbi + Reed-Solomon 3=Reserved 4=Reserved 5=TCM + Reed-Solomon 6=Turbo Example: RFT=1 (Viterbi only)	RFT= RFT? RFT* RFT# RFT\$ RFT^ RFT@	RFT?	RFT=x (see description of arguments)

Parameter Type	Command (Instruction Code and qualifier)	Arguments for Command or Response to Query	Description of Arguments	Response to Command (Target to Controller)	Query (Instruction Code and Qualifier)	Response to query (Target to Controller)
RX Demod Type	RMD=	1 byte, value of 0 through 5	<p>Command or Query RX Demodulator, where: 0=BPSK 1=QPSK 2=Reserved 3=8-PSK 4=16-QAM (Turbo or Viterbi + Reed-Solomon) 5=Reserved</p> <p>Depending on FEC type, not all of these selections will be valid. All other codes are invalid.</p> <p>Example: RMD=1 (QPSK)</p>	RMD= RMD? RMD* RMD# RMD\$ RMD^ RMD@	RMD?	RMD=x (see description of arguments)
RX FEC Code Rate	RCR=	1 byte, value of 0 through 7	<p>Command or Query 0=Rate 5/16 (Turbo Only) 1=Rate 21/44 (Turbo Only) 2=Rate 1/2 3=Rate 2/3 (8-Psk TCM or 8-QAM only) 4=Rate 3/4 5=Rate 7/8 6= Rate 17/18 (Turbo Only) 7= Reserved</p> <p>Depending on FEC and demodulation type, not all of these selections will be valid.</p> <p>Example: RCR=4 (Rate 3/4)</p>	RCR= RCR? RCR* RCR# RCR\$ RCR^ RCR@	RCR?	RCR=x (see description of arguments)
RX Reed-Solomon (n, k) values	RRS=	1 byte, value of 0 through 3	<p>Command or Query. RX Reed-Solomon (n, k) values, where: 0=Unframed closed network (220,200) 1=EFD closed network (225,205) 2=IESS-310 compatible operation (219,201) 3=EDMAC mode, closed (200,180) – EDMAC only</p> <p>Notes: 1. Selection is valid only when RFT=2 or RFT=5. 2. For D&I++, selection 0,1, and 2 are supported.</p>	RRS= RRS? RRS* RRS# RRS\$ RRS^ RRS@	RRS?	RRS=x (see description of arguments)

Parameter Type	Command (Instruction Code and qualifier)	Arguments for Command or Response to Query	Description of Arguments	Response to Command (Target to Controller)	Query (Instruction Code and Qualifier)	Response to query (Target to Controller)
RX Data Rate	RDR=	9 bytes	<p>Command or Query RX Data Rate, in kbps, between 32 kbps and 20 Mbps Resolution = 1 bps. (See Chapter 5 for valid rates)</p> <p><u>Query ONLY if Interface Type is Quad Drop & Insert (ITF=D).</u></p> <p>Example: RDR=02047.999</p>	<p>RDR= RDR? RDR* RDR# RDR\$ RDR^ RDR@</p>	RDR?	RDR=xxxxx.xxxx (see description of arguments)
RX Spectrum Invert	RSI=	1 byte, value of 0, 1	<p>Command or Query RX Spectrum Invert, where: 0=Normal 1=RX Spectrum Invert</p> <p>Example: RSI=0 (Normal)</p>	<p>RSI= RSI? RSI* RSI# RSI\$ RSI^ RSI@</p>	RSI?	RSI=x (see description of arguments)
RX Descrambler	RDS=	1 byte, value of 0 1, 2	<p>Command or Query RX Descrambler state, where: 0=Off 1=On (default descrambler type) 2=On (IESS-315 Turbo only)</p>	<p>RDS= RDS? RDS* RDS# RDS\$ RDS^ RDS@</p>	RDS?	RDS=x (see description of arguments)
RX Data Invert	RDI=	1 byte, value of 0, 1	<p>Command or Query Invert Receive Data, where: 0=Normal 1=Inverted</p> <p>Example: RDI=1 (Inverted RX Data)</p>	<p>RDI= RDI? RDI* RDI# RDI\$ RDI^ RDI@</p>	RDI?	RDI=x (see description of arguments)
RX Data Clock Invert	RCI=	1 byte, value of 0, 1	<p>Command or Query Invert Receive Data Clock, where: 0=Normal 1=Inverted</p>	<p>RCI= RCI? RCI* RCI# RCI\$ RCI^ RCI@</p>	RCI?	RCI=x (see description of arguments)

Parameter Type	Command (Instruction Code and qualifier)	Arguments for Command or Response to Query	Description of Arguments	Response to Command (Target to Controller)	Query (Instruction Code and Qualifier)	Response to query (Target to Controller)
RX Demod Acquisition Sweep Width	RSW=	3 bytes	Command or Query RX acquisition sweep range of demodulator, in kHz, ranging from 1 to 32 kHz . Example: RSW=009 (9 kHz)	RSW= RSW? RSW* RSW# RSW\$ RSW^ RSW@	RSW?	RSW=xxx (see description of arguments)
RX Buffer Size	RBS=	1 byte, value of 0 through 6	Command or Query RX Buffer size, where: 0=Buffer disabled 1=± 512 bits 2=± 1024 bits 3=± 2048 bits 4=± 4096 bits 5=± 8192 bits 6=± 16384 bits Example: RBS=0	RBS= RBS? RBS* RBS# RBS\$ RBS^ RBS@	RBS?	RBS=x (see description of arguments)
RX Buffer Clock Source	BCS	1 byte, value of 0 through 4 2	Command or Query RX buffer clock source, where: 0=Internal 1=Rx Satellite 2=Tx Terrestrial (grouped as modem only) 3=Insert (D&I++ mode only) <u>4=External (QDI Interface only)</u> Note: Rx Satellite is also available in D&I++ mode. <u>Rx Satellite and Tx Terrestrial are also available for QDI interface type.</u>	BCS= BCS? BCS* BCS# BCS\$ BCS^ BCS@	BCS?	BCS=x (see description of arguments)
RX roll-off (alpha) factor	RXA=	1 byte	Command or Query Rx roll-off (alpha) factor 0=20% 1=35% (default)	RXA= RXA? RXA* RXA# RXA\$ RXA^ RXA@	RXA	RXA=x (see description of arguments)

Parameter Type	Command (Instruction Code and qualifier)	Arguments for Command or Response to Query	Description of Arguments	Response to Command (Target to Controller)	Query (Instruction Code and Qualifier)	Response to query (Target to Controller)
Eb/No Alarm Point	EBA=	4 bytes	Command or Query Eb/No alarm point in dB, with a range between 0.1 and 16 dB. Resolution = 0.1 dB Example: EBA=12.3	EBA= EBA? EBA* EBA# EBA\$ EBA^ EBA@	EBA?	EBA=xx.x (see description of arguments)

C.5.3 Common Remote Commands for Tx or Rx or Modem

Parameter Type	Command (Instruction Code and qualifier)	Arguments for Command or Response to Query	Description of Arguments	Response to Command (Target to Controller)	Query (Instruction Code and Qualifier)	Response to query (Target to Controller)
----------------	--	--	--------------------------	--	--	--

Parameter Type	Command (Instruction Code and qualifier)	Arguments for Command or Response to Query	Description of Arguments	Response to Command (Target to Controller)	Query (Instruction Code and Qualifier)	Response to query (Target to Controller)
Card Interface Type	ITF=	1 byte	<p>Command or Query. Terrestrial interface type, where:</p> <p>0=RS422/EIA530 DCE (Command or Query) 1=V.35 DCE (Command or Query) 2=RS232 (SYNC) (Command or Query) 3=G.703 TI Bal AMI (Command or Query) 4=G.703 T1 Bal B8ZS (Command or Query) 5=G.703 E1 Unbal AMI (Command or Query) 6=G.703 E1 Unbal HDB3 (Command or Query) 7=G.703 E1 Bal AMI (Command or Query) 8=G.703 E1 Bal HDB3 (Command or Query) 9=HSSI (Query only) A=ASI (Query only) B=G.703 TI Unbal AMI (Command or Query) C=G.703 T1 Unbal B8ZS (Command or Query) <u>D=Quad Drop & Insert</u> F=None (Query only)</p> <p>All other codes are invalid. Example: ITF=1 (V.35)</p>	ITF= ITF? ITF* ITF# ITF\$ ITF^	ITF?	ITF = x (see description of arguments)
Framing Mode (Modem only)	FRM=	1 byte, value of 0, 1, 2	<p>Command or Query Unit operating mode, where:</p> <p>0=Unframed 1=EDMAC Framing 2=EDMAC-2 Framing 3=D&I++ Framing</p> <p>Example: FRM=0 (unframed)</p>	FRM= FRM? FRM* FRM# FRM^	FRM?	FRM=x (see description arguments)
EDMAC Framing Mode (Modem only)	EFM=	1 byte, value of 0, 1, 2	<p>Command or Query EDMAC mode, where:</p> <p>0=EDMAC Off (Framing is on, AUPC active) 1=EDMAC Master 2=EDMAC Slave (Query Only) Example: EFM=1 (EDMAC Enabled as Master)</p>	EFM= EFM? EFM* EFM# EFM^	EFM?	EFM=x (see description of arguments)

Parameter Type	Command (Instruction Code and qualifier)	Arguments for Command or Response to Query	Description of Arguments	Response to Command (Target to Controller)	Query (Instruction Code and Qualifier)	Response to query (Target to Controller)
EDMAC Slave Address Range (Modem only)	ESA=	4 bytes	<p>Command or Query</p> <p>EDMAC Slave Address Range – sets the range of addresses of distant-end units (modems or transceivers), which this unit, as the Master, will forward, messages for. Only values which are integer multiples of 10 are permitted (0010, 0020, 0030, 0040, etc)</p> <p>Example: ESA=0090</p> <p>This command is only valid for an EDMAC Master. When used as a Query, it may be sent to an EDMAC Slave, which will respond with the appropriate address.</p>	<p>ESA=</p> <p>ESA?</p> <p>ESA*</p> <p>ESA?</p> <p>ESA^</p>	ESA?	ESA=xxxx (see description of arguments)
External Reference Frequency	ERF=	1 byte, value of 0 through 6	<p>Command or Query</p> <p>External Reference Frequency, where:</p> <p>0=Internal, external reference connector not used</p> <p>1=External 1 MHz</p> <p>2=External 2 MHz</p> <p>3=External 5 MHz</p> <p>4=External 10 MHz</p> <p>5=External 20 MHz</p> <p>6=Internal with 10 MHz driven to reference connector</p> <p>7=External auto detect(1,2,5,10,or 20 MHz)</p> <p>Example: ERF=0 (External reference not used, uses Internal)</p>	<p>ERF=</p> <p>ERF?</p> <p>ERF*</p> <p>ERF#</p> <p>ERF^</p>	ERF?	ERF=x (see description of arguments)
Internal Reference Oscillator Adjust	IRA=	5 bytes, numeric	<p>Command or Query</p> <p>Fine adjustment to the internal reference oscillator tuning voltage, thereby, fine tuning the required internal reference frequency.</p> <p>Syntax: IRA=sxxxx</p> <p>Where: s = sign (- or +)</p> <p>Range: -2048 to +2047.</p> <p>Example: IRA=+0192</p>	<p>IRA=</p> <p>IRA?</p> <p>IRA*</p> <p>IRA#</p> <p>IRA^</p>	IRA?	IRA=x (see description of arguments)

Parameter Type	Command (Instruction Code and qualifier)	Arguments for Command or Response to Query	Description of Arguments	Response to Command (Target to Controller)	Query (Instruction Code and Qualifier)	Response to query (Target to Controller)
Test Mode (Modem or Tx only)	TST=	1 byte, value of 0 through 6	Command or Query CDM-QX Test Mode, where: 0=Normal Mode (No Test) 1=IF Loopback 2=Digital Loopback 3=I/O Loopback 4=RF Loopback 5=TX CW 6=TX Alternating 1,0 Pattern Example: TST=1 (IF Loopback)	TST= TST? TST* TST# TST\$ TST^ TST@	TST?	TST=x (see description of arguments)
Alarm Mask	MSK=	12 bytes	Command or Query Alarm mask condition, in form abcdefghijkl, where: a=TX FIFO (0=Unmasked, 1=Masked, X=no Tx) b=G.703 BPV (0=unmasked, 1=Masked, X=no Tx) c=Tx-AIS (0=Unmasked, 1=Masked, X=no Tx) d=RX AGC Alarm (0=Unmasked, 1=Masked, X=no Rx) e=Eb/No Alarm (0=Unmasked, 1=Masked, X=no Rx) f=RX-AIS (X=no Rx) g=Buffer Slip (X=no Rx) h=EXT REF Alarm i=BUC Alarm (L-Band unit only) j=LNB Alarm (L-Band unit only) k=Spare l=Spare Example: MSK=010110010100	MSK= MSK? MSK* MSK# MSK^	MSK?	MSK=abcdefghijkl (see description or arguments)
Local/Remote Status	LRS=	1 byte, value of 0, 1	Command or Query Local/Remote status, where: 0=Local 1=Serial Remote 3=Ethernet Remote Example: LRS=1 (Serial Remote)	LRS= LRS? LRS* LRS#	LRS?	LRS=x (see description of arguments)

Parameter Type	Command (Instruction Code and qualifier)	Arguments for Command or Response to Query	Description of Arguments	Response to Command (Target to Controller)	Query (Instruction Code and Qualifier)	Response to query (Target to Controller)
AUPC Enabled (Modem only)	AUP=	1 byte, value of 0, 1	Command or Query AUPC mode enable/Disable, where: 0=Disabled 1=Enabled Example: AUP=1 (Enabled) Note: EDMAC framing must be selected for the AUPC feature to work.	AUP= AUP> AUP* AUP# AUP^	AUP?	AUP=x (see description of arguments)
AUPC Parameters (Modem only)	APP=	6 bytes	Command or Query Defines AUPC operating parameters. Has the form abc.cd, where: a=Defines action on max power condition (0=do nothing, 1=generate TX Alarm) b=Defines action on remote demod unlock. (0=go to nominal power, 1=go to max power) c= target Eb/No value, for remote demod, from 0.0 to 9.9 dB d=Max increase in Tx Power permitted, from 0 to 9 dB Example: APP=015.67 (sets no alarm, max power, 5.6 dB target and 7 dB power increase)	APP= APP? APP* APP# APP^	APP?	APP=abc.cd (see description of arguments)
Group	GRP	1 byte	Command or Query Group a modulator/demodulator pair into a modem A grouped mod and demod will respond to either address 0=Both sides ungrouped 1=Left side (as viewed from back of chassis) grouped 2=Right side grouped 3=Both sides grouped Example: GRP=3 (both sides of chassis are grouped into modems)	GRP= GRP? GRP* GRP# GRP\$ GRP^	GRP?	GRP=x

Parameter Type	Command (Instruction Code and qualifier)	Arguments for Command or Response to Query	Description of Arguments	Response to Command (Target to Controller)	Query (Instruction Code and Qualifier)	Response to query (Target to Controller)
T1 Line Build-Out	LBO=	1 byte, value of 0 though 4	Command or Query. Valid only for T1 interface, where: 0=0 to 133 feet 1=133 to 266 feet 2=266 to 399 feet 3=399 to 533 feet 4=533 to 655 feet Example: LBO=2	LBO= LBO? LBO* LBO# LBO\$ LBO^ LBO@	LBO?	LBO=x (see description arguments)
IP Address	IPA=	18 bytes numerical	Command or Query Used to set the IP Address and network prefix for the 10/100 BadaTX Ethernet management port, in the format: xxx.xxx.xxx.xxx.yy where: yy is the network prefix (0 to 31) Example: 010.006.030.001.24	IPA= IPA? IPA* IPA#	IPA?	IPA=xxx.xxx.xxx.x xx.yy (see description of arguments)
Request to Send	RTS=	1 byte, value of 0, 1, 2	Command or Query Defines how RTS/CTS will operate at the main data interface 0=RTS/CTS Loop, No Action RTS and CTS are looped, so that CTS echoes the state of RTS, but RTS does not control the ON/OFF state of carrier. 1=Loop, RTS Controls TX O/P RTS and CTS are looped, so that CTS echoes the state of RTS and RTS controls the ON/OFF state of carrier (in order words, the modem will not bring up its TX carrier until RTS is asserted. 2=Ignore RTS, Assert CTS Example: RTS=0 (RTS/CTS Loop, No Action)	RTS= RTS? RTS* RTS# RTS^	RTS?	RTS=x (see description of arguments)

Parameter Type	Command (Instruction Code and qualifier)	Arguments for Command or Response to Query	Description of Arguments	Response to Command (Target to Controller)	Query (Instruction Code and Qualifier)	Response to query (Target to Controller)
HSSI handshake control (valid only for HSSI interface)	HHC=	1 byte, value of 0,1	Command or Query. Defines how TA/CA control the HSSI interface. 0 = TA to CA loop (default) 1 = RR control CA, TA control Tx output. Example: HHC=0 (TA to CA loop)	HHC= HHC? HHC* HHC# HHC^	HHC?	HHC=x (see description of arguments)
Circuit ID String	CID=	28 bytes	Command or Query Sets or queries the user-defined Circuit ID string which is a fixed length of 28 characters. Valid characters include: Space() * + - , . / 0 9, and A through Z	CID= CID? CID* CID# CID^	CID?	CID=- xxxxxxxxxxxxxxxxxxxx xxxxxxxxxxxxxxxxxxxx (see description of arguments)

Parameter Type	Command (Instruction Code and qualifier)	Arguments for Command or Response to Query	Description of arguments	Response to Command (Target to Controller)	Query (Instruction Code and Qualifier)	Response to query (Target to Controller)
Configuration Save	CST=	1 byte	Command only Causes the CDM-QX to store the current unit configuration (common functions and all four slots) in Configuration Memory location defined by the 1-byte argument (0 to 9) Example: CST=4 (store the current configuration in location 4)	CST= CST? CST* CST# CST^	N/A	N/A
Configuration Load	CLD=	1 byte	Command only Causes the CDM-QX to retrieve a previously stored unit configuration (common functions and all four slots) in Configuration Memory location defined by the 1-byte argument (0 to 9) Example: CLD=4 (retrieve unit configuration from location 4)	CLD= CLD? CLD* CLD# CLD^	N/A	N/A
ReCenter Buffer	RCB=	None	Command only Forces the software to recenter the receive Plesiochronous/Doppler buffer. Note: This command takes no argument. Example: RCB=	RCB= RCB? RCB* RCB# RCB\$ RCB^ RCB@	N/A	N/A
RTC Date	DAY=	6 bytes	Command or Query A date in the form ddmmyy, where: dd=day of the month (01 to 31) mm=month (01 to 12) yy=year (00 to 99) Example: DAY=240457 (April 24, 2057)	DAY= DAY? DAY* DAY# DAY^	DAY?	DAY=ddmmyy (see description of arguments)

Parameter Type	Command (Instruction Code and qualifier)	Arguments for Command or Response to Query	Description of arguments	Response to Command (Target to Controller)	Query (Instruction Code and Qualifier)	Response to query (Target to Controller)
RTC Time	TIM=	6 bytes	Command or Query A time in the form hhmmss, indicating the time from midnight, where: hh=hours (00 to 23) mm=minutes (00 to 59) ss=seconds (00 to 59) Example: TIM=231259 (23 hours, 12 minutes 59 seconds)	TIM= TIM? TIM* TIM# TIM^	TIM?	TIM= hhmmss (see description and arguments)
Clear All Stored Events	CAE=	None	Command only Forces the software to clear the software events log. Example: CAE= Note: This command takes no arguments.	CAE= CAE? CAE* CAE# CAE^	N/A	N/A
Initialize Events Pointer	IEP=	None	Command only Resets internal pointer to allow RNE? Queries to start at the beginning of the stored events log.	IEP= IEP# IEP^	N/A	N/A
Statistics Sample Interval	SSI=	1 byte, numerical	Command or Query Used to set the sample interval for the Statistics Logging Function SSI=x, where x = 0 to 9 in 10-minute steps Note: Setting this parameter to 0 disables the statistics logging function. Example: SSI=3 means 30 minutes	SSI= SSI? SSI* SSI# SSI^	SSI?	
Clear All Stored Statistics	CAS=	None	Command only Forces the software to clear the software statistics log. Example: CAS= Note: This command takes no arguments.	CAS= CAS? CAS* CAS# CAS^	N/A	N/A
Initialize Statistics Pointer	ISP=	None	Command only Resets internal pointer to allow RNS? Queries to start at the beginning of the statistics log.	ISP= ISP# ISP^	N/A	N/A

Parameter Type	Command (Instruction Code and qualifier)	Arguments for Command or Response to Query	Description of arguments	Response to Command (Target to Controller)	Query (Instruction Code and Qualifier)	Response to query (Target to Controller)
Internal Redundancy Mode	IRM=	5 bytes	<p>Command or Query Redundancy mode Syntax: IRM=x,abc Where x: 0=No Redundancy 1=1:1 modem (back-up cards at slot#3 and slot#4), or 1:1 Tx (back-up Tx on slot#4), or 1:1 Rx (back-up Rx on slot#4) 2=1:2 Tx, or 1:2 Rx (back-up card on slot#4) 3=1:3 Tx, or 1:3 Rx (back-up card on slot#4) 4=Reserved</p> <p>where abc: 000=no redundancy or 1:1 modem or 1:3 Tx or 1:3 Rx. If a=1, slot#1 is selected as primary, otherwise it's not. If b=1, slot#2 is selected as primary, otherwise it's not. If c=1, slot#3 is selected as primary, otherwise it's not. Note: The settings on a,b, and c fields are only required if Qx is in 1:1 Tx or 1:1 Rx or 1:2 Tx or 1:2 Rx .</p> <p>Example: IRM =1,000 (1:1 modem) IRM =1,010 (1:1 Tx or 1:1 Rx with primary at slot#2.</p>	IRM = IRM? IRM* IRM# IRM\$ IRM^	IRM?	IRM = x,abc (see description of arguments)
Redundancy Auto or Manual Switching	RAM=	1 byte	<p>Command or Query. 0 = manual switching (default) 1 = automatic switching</p>	RAM = RAM? RAM * RAM # RAM^	RAM?	RAM=x (see description of arguments)

Parameter Type	Command (Instruction Code and qualifier)	Arguments for Command or Response to Query	Description of arguments	Response to Command (Target to Controller)	Query (Instruction Code and Qualifier)	Response to query (Target to Controller)
Forced Back-up in redundancy	FBU=	1 byte	Command or Query Valid only if redundancy is enabled (see IRM command). If FBU is activated, this will force the back-up card(s) to take over the selected primary. Syntax: FBU=x Where x = 0, back to primary being backed-up or none 1 = slot#1 is the primary card to be backed-up. 2 = slot#2 is the primary card to be backed-up. 3 = slot#3 is the primary card to be backed-up. Note: For 1:1 Modem, use FBU=1	FBU= FBU? FBU* FBU# FBU\$ FBU^	FBU?	FBU=x (see description of arguments)
Online status for Internal Redundancy	N/A	4 bytes	Query Only. ONL=abcd Where: a=1, slot#1 is online, 0 otherwise b=1, slot#2 is online, 0 otherwise c=1, slot#3 is online, 0 otherwise d=1, slot#4 is online, 0 otherwise In 1:1 modem, abcd=1100, modem #1 is online abcd=0011, modem #2 is online	N/A	ONL?	ONL=abcd (see description of arguments)
Carrier-in-Carrier (CnC) Mode	CNM=	1 byte, value of 0,1,2	Command or Query CnC Mode of Operation 0=Off 1=On	CNM= CNM? CNM* CNM# CNM\$ CNM^ CNM@	CNM?	CNM=x (see description of arguments)
Carrier-in-Carrier (CnC) Frequency Offset	CCF=	9 bytes	Command or Query CnC Sweep frequency range from 0 to 32 kHz Syntax: CCF=xxx Example: CCF=030	CCF= CCF? CCF * CCF # CCF \$ CCF ^ CCF@	CCF?	CCF =xxx,yyy (see description of arguments)

Parameter Type	Command (Instruction Code and qualifier)	Arguments for Command or Response to Query	Description of arguments	Response to Command (Target to Controller)	Query (Instruction Code and Qualifier)	Response to query (Target to Controller)
Carrier-in-Carrier (CnC) Min/Max Search Delay	CSD=	7 bytes	Command or Query CnC min/max delay value in milliseconds. Maximum allowable value is 330ms. Syntax: CSD=xxx,yyy Where: xxx=min, yyy-max Example: 010,325	CSD= CSD? CSD* CSD# CSD\$ CSD^ CSD@	CSD?	CSD=xxx,yyy (see description of arguments)
CnC Re-Acquisition Time	CRA=	3 bytes	Command or Query CnC re-Acquisition time in seconds. This is the time wherein CnC will start searching for the delay and frequency offset if long duration of unlock occurs. Example: CRA=120 (default & max=120 seconds) (min=15 for symbol rate < 256 ksps) (min=10 for symbol rate >= 256 ksps)	CRA= CRA? CRA* CRA# CRA\$ CRA^ CRA@	CRA?	CRA=xxx (see description of arguments)

C.5.4 Query Commands

Parameter Type	Command (Instruction Code and qualifier)	Arguments for Command or Response to Query	Description of Arguments	Response to Command (Target to Controller)	Query (Instruction Code and Qualifier)	Response to query (Target to Controller)
Equipment ID	N/A	14 bytes	<p>Query only Unit returns information on a per card basis concerning the equipment identification and the option field in the form: abbbcdefghijk</p> <p>a=Turbo H/W option: 0=None, 1=Turbo, 2=TPC/LDPC bbb=defines the model number (Qx0 in this case) c=RS Codec H/W Option: 0=None 1=Installed d=Card Data Rate S/W Option: 0=None , 3=up to 5 Mbps, 4=up to 10 Mbps, 5=up to 20 Mbps e=Higher-order modulation: 0=None, 1=8-PSK/8-QAM, 2=16-QAM, 3=8-PSK, 8-QAM, 16-QAM f=Spare – for future use g=Spare – for future use h=Turbo data rate S/W option: 0=None, 1=up to 512Kbps, 2=up to 2048Kbps, 3=up to 5Mbps, 4=up to 10Mbps, 5=up to 20Mbps i=Card type: 0=None, 1=Modulator, 2=Demodulator j=Modem group: 0=ungrouped, 1=grouped as modem#1, 2=grouped as modem#2 k=Spare – for future use l=Spare – for future use</p> <p>Example 1: EID=1Qx0033xx31xxx means Turbo installed, CDM-QX 70/140 band, No RS Codec, up to 5 Mbps, 8-PSK/8-QAM and 16-QAM, Turbo data rate up to 5Mbps, card is modulator.</p> <p>Example 2: EID=xQx0xxxxxx0xxx, means there's no mod or demod card installed. This tells the user that this remote address belongs to a CDM-Qx.</p>	N/A	EID?	<p>EID=abbbcdefghijkl (see description of arguments)</p> <p>Notes: Qx0 is the 70/140 card (mod or demod) Qx1 is the L-Band card (mod or demod)</p>

Parameter Type	Command (Instruction Code and qualifier)	Arguments for Command or Response to Query	Description of Arguments	Response to Command (Target to Controller)	Query (Instruction Code and Qualifier)	Response to query (Target to Controller)
Unit ID	N/A	7 bytes	<p>Query only Unit returns information concerning the base unit identification and the option field in the form: abcdefg</p> <p>a=Redundancy option: 0=None, 1=1:1 mode, 2=1:2 mode, 3=1:3 mode. Note: if a=3, capable of supporting also 1:2 and 1:1. If a=2, capable of supporting 1:1 as well.</p> <p>b=CnC First Instance rate option: 0=None, 1=128 Kbps to 512Kbps, 2=128Kbps to 1Mbps, 3=128Kbps to 2.5Mbps, 4=128Kbps to 5Mbps, 5=128Kbps to 10Mbps, 6=128Kbps to 20Mbps.</p> <p>c=CnC Second Instance rate option: 0=None, 1=128 Kbps to 512Kbps, 2=128Kbps to 1Mbps, 3=128Kbps to 2.5Mbps, 4=128Kbps to 5Mbps, 5=128Kbps to 10Mbps, 6=128Kbps to 20Mbps.</p> <p>d=Unit Type 0=70/140MHz unit 1=L-Band unit with one 24V power supply 2=L-Band unit with one 48V power supply 3=L-Band unit with two 24V power supplies 4=L-Band unit with two 48V power supplies</p> <p>e=D&l++ option 0=None 1=One modem only 2=Two modems</p> <p>f=spare g=spare</p>	N/A	UID?	UID=abcdefg (see description of arguments)

Parameter Type	Command (Instruction Code and qualifier)	Arguments for Command or Response to Query	Description of Arguments	Response to Command (Target to Controller)	Query (Instruction Code and Qualifier)	Response to query (Target to Controller)
Faults and Status	N/A	12 bytes	<p>Query only Unit returns the current highest-priority fault and status codes for the Unit (hardware), TX Traffic, RX Traffic, and ODU in the form abcdef, where:</p> <p>a=Unit Faults: 0=No Faults 1=Power Supply Fault, +5 volts 2=Power Supply Fault, +12 volts 3=Power Supply Fault, -5 volts 4=Power Supply Fault, +23 volts 5=Power Supply Fault, -12 volts 9=Ref PLL Lock F=EEPROM Checksum error 6,7,8,A,B,C,D,E are reserved for future expansion bb=fault codes for slot#1 can be Tx or Rx Traffic status cc=fault codes for slot#2 can be Tx or Rx Traffic status dd=fault codes for slot#3 can be Tx or Rx Traffic status ee=fault codes for slot#4 can be Tx or Rx Traffic status</p> <p>TX Traffic status: 00=TX Traffic OK 01=No Clock from Terrestrial Interface 03=TX FIFO Slip 06=TX Synthesizer Lock 07=AUPC Upper Limit Reached 09=AIS Detected on Incoming Data 0B=Bipolar violation on G.703 Interface 0F=TX EEPROM Checksum Error 12=Power supply fault, +5 volts 13=Power supply fault, -5 volts 14=Power supply fault, +12 volts 15=Power supply fault, -12 volts 16=Power supply fault, +23 volts the rests are reserved for future expansion</p> <p>RX Traffic status: 0=RX Traffic OK 1=Demodulator Unlocked 3=AGC Alarm – signal out of range 5=RS Frame SYNC alarm 7=EDMAC Frame SYNC alarm 8=RX 1st LO Synthesizer Lock 9=RX 2nd LO Synthesizer Lock A=Buffer Under B=Buffer Overflow D=Eb/No alarm E=AIS detected on incoming data F=RX EEPROM checksum error 10=Demod FPGA not programmed 11=Turbo FPGA not programmed 12=Power supply fault, +5 volts 13=Power supply fault, -5 volts 14=Power supply fault, +12 volts 15=Power supply fault, -12 volts 16=Power supply fault, +23 volts 17=QDI Deframer Unlocked the rests are reserved for future expansion</p> <p>f=ODU status: (for L-Band unit only) 0=No ODU Faults 1=BUC PLL 3=BUC Current 5=BUC Voltage 7=LNB Current, 9=LNB Voltage, B=BUC Temperature, D=BUC Checksum</p>	N/A	FLT?	<p>FLT=abccddeefgh (see description of arguments)</p> <p>g=Change in fault status since last poll.</p> <p>h=Change in unit configuration since last poll</p> <p>(see description of arguments)</p>

Parameter Type	Command (Instruction Code and qualifier)	Arguments for Command or Response to Query	Description of Arguments	Response to Command (Target to Controller)	Query (Instruction Code and Qualifier)	Response to query (Target to Controller)												
Unit Type	N/A	11 bytes	<p>Query only. Syntax: Who=aw,bx,cy,dz Type of plug-in: Where:</p> <table border="0"> <tr> <td><u>a,b,c,d</u></td> <td><u>w,x,y,z</u></td> </tr> <tr> <td>0=unoccupied</td> <td>0=unoccupied</td> </tr> <tr> <td>1=transmit</td> <td>1=70/140 MHz</td> </tr> <tr> <td>2=receive</td> <td>2=L-Band</td> </tr> <tr> <td></td> <td>3=Reserved</td> </tr> <tr> <td></td> <td>4=Reserved</td> </tr> </table> <p>aw=slot#1, bx=slot#2, cy=slot#3, dz=slot#4 Example: WHO=00, 11, 21, 00, (slot#1=empty, slot#2=Tx, slot#3=Rx, slot#4=empty. Both Tx and Rx are 70/140 MHz cards)</p>	<u>a,b,c,d</u>	<u>w,x,y,z</u>	0=unoccupied	0=unoccupied	1=transmit	1=70/140 MHz	2=receive	2=L-Band		3=Reserved		4=Reserved	N/A	WHO?	WHO=aw,bx,cy,dz (see description of arguments)
<u>a,b,c,d</u>	<u>w,x,y,z</u>																	
0=unoccupied	0=unoccupied																	
1=transmit	1=70/140 MHz																	
2=receive	2=L-Band																	
	3=Reserved																	
	4=Reserved																	
Remote Eb/No (Modem only)	N/A	4 bytes	<p>Query only Returns the value of Eb/No of the remote demod Responds 99.9=remote demod unlock Responds xx.x if EDMAC is disabled. xx.x=02.0 to 16.0</p> <p>Example: REB=12.4 Note: for values > 16.0 dB, the reply will be 16.0</p>	N/A	REB?	REB=xx.x (see description of arguments)												
TX Power Level Increase (Modem only)	N/A	3 bytes	<p>Query only. Returns the increase in TX power level, in dB (from the nominal setting) due to the action of AUPC. Range is 0.0 to 9.9 dB. Responds x.x if AUPC is disabled.</p> <p>Example: PLI=2.3</p>	N/A	PLI?	PLI=x.x (see description of arguments)												

Parameter Type	Command (Instruction Code and qualifier)	Arguments for Command or Response to Query	Description of Arguments	Response to Command (Target to Controller)	Query (Instruction Code and Qualifier)	Response to query (Target to Controller)
Number of Unread Stored Events	N/A	3 bytes	<p>Query only Unit returns the number of stored Events, which remain Unread, in the form of xxx.</p> <p>Note: This means unread over the remote control.</p> <p>Example: NUE=126</p>	N/A	NUE?	NUE=xxx (see description of arguments)
Retrieve next 5 unread stored Events	N/A	80 bytes	<p>Query only Unit returns the oldest 5 Stored Events, which have not yet been read over the remote control. Reply format: {CR}Sub-body{CR}Sub-body{CR}Sub-body{CR}Sub-body{CR}Sub-body{CR}, where Sub-body = ABCCddmmyyhhmmss, A being the fault/clear indicator F=Fault C=Clear I=Info B being the fault type where: 1=Unit 2=RX Traffic on slot#1 3=RX Traffic on slot#2 4=RX Traffic on slot#3 5=RX Traffic on slot#4 6=TX Traffic on slot#1 7=TX Traffic on slot#2 8=TX Traffic on slot#3 9=TX Traffic on slot#4 A=ODU B=Power ON/OFF, or log cleared CC is Fault Code numbers, as in FLT? Or Infor Code, which is: 0=Power Off 1=Power On 2=Log Cleared 3=Global Config Change 4=Redundancy Config Change If there are less than 5 events to be retrieved, the remaining positions are padded with zeros. If there are no new events, the response is RNE*.</p>	N/A	RNE?	<p>RNE={CR}ABCCddmmyyhhmmss{CR}ABCCddmmyyhhmmss{CR}ABC Cddmmyyhhmmss {CR}ABCCddmmyyhhmmss{CR}ABCCddmmyyhhmmss</p> <p>(see description of arguments)</p>

Parameter Type	Command (Instruction Code and qualifier)	Arguments for Command or Response to Query	Description of Arguments	Response to Command (Target to Controller)	Query (Instruction Code and Qualifier)	Response to query (Target to Controller)
Number of Unread stored Statistics (Modem Only)	N/A	3 bytes	Query only Unit returns the number of stored Statistics, which remain Unread, in the form xxx.	N/A	NUS?	NUS=xxx (see description of arguments)
Retrieved next 5 unread Stored Statistics (Modem Only)	N/A	130 bytes	Query only Unit returns the oldest 5 Stored Statistics, which have not yet been read over the remote control. Reply format: {CR}Sub-body{CR}Sub-body{CR}Sub-body{CR}Sub-body{CR}Sub-body, where Sub-body= AA.ABB.BC.CD.Dddmmyyhhmss, AA.A Minimum Eb/No during sample period BB.B=Average Eb/No during sample period C.C=Max. TX Power Level Increase during sample period D.D=Average TX Power Level during sample period ddmmyyhhmss=date/time stamp If there are no new events, the unit replies with RNS* If there are less than 5 statistics to be retrieved, the remaining positions are padded with zeros.	N/A	RNS?	RNS={CR} AA.ABB.BC.CD.Dddm myyhhmss{CR} AA.ABB.BC.CD.Dddm myyhhmss{CR} AA.ABB.BC.CD.Dddm myyhhmss{CR} AA.ABB.BC.CD.Dddm myyhhmss{CR} AA.ABB.BC.CD.Dddm myyhhmss (see description of arguments)
RX Eb/No	N/A	3 bytes	Query only Unit returns the value of Eb/No, between 0 and 16 dB, Resolution 0.1 dB. Returns 99.9 if demod is unlocked. Example: EBN=12.3 (Eb/No=12.3 dB) For values greater than 16.0 dB, the reply will be: EBN=+016	N/A	EBN?	EBN=xxxx (see description of arguments)

Parameter Type	Command (Instruction Code and qualifier)	Arguments for Command or Response to Query	Description of Arguments	Response to Command (Target to Controller)	Query (Instruction Code and Qualifier)	Response to query (Target to Controller)
RX Signal Level	N/A	4 bytes	<p>Query Only Unit returns the value of the RX signal Level, in dBm, between -20 and -99 dBm, in the form: ccxx, where: Cc=code GT=Greater Than LT=Less Than = is equal to xx=value (the '-' sign is implied)</p> <p>Example: RSL=LT99 (RX signal level is less than -99 dBm) RSL===41 (RX signal level is equal to -41 dBm)</p>	N/A	RSL?	RSL=ccxx (see description of arguments)
RX BER	N/A	5 bytes	<p>Query only Unit returns the value of the estimated corrected BER in the form a.b x 10^c. First 3 bytes are the value. Last 2 bytes are the exponent. Returns 99999 if the demodulator is unlocked.</p> <p>Example: BER=4.8E3 (BER = 4.8 x 10⁻³)</p>	N/A	BER?	BER=a.bEc (see description of arguments)
CnC Ratio Monitor	N/A	4 bytes	<p>Query only When CnC is enabled and it's locked, it monitors the ratio between the interferer and the desired power in dB.</p> <p>Example 1: CRM==+02 (interferer > desired) Example 2: CRM=LT10 (less than -11 dB) Example 3: CRM=GT10(greater than +11 dB) Example 4: CRM=99.9 (not locked or CnC not enabled)</p>	N/A	CRM?	CRM=xxxx (see description of arguments)
CnC Delay Monitor	N/A	7 bytes	<p>Query only When CnC is enabled and it's locked, it monitors the delay of the interferer in microseconds.</p> <p>Example 1: CDM=229,500 (229.5 ms) Example 2: CDM=999,999 (not locked or CnC not enabled)</p>	N/A	CDM?	CDM=xxx.xxx (see description of arguments)

Parameter Type	Command (Instruction Code and qualifier)	Arguments for Command or Response to Query	Description of Arguments	Response to Command (Target to Controller)	Query (Instruction Code and Qualifier)	Response to query (Target to Controller)
CnC Freq Offset Monitor	N/A	6 bytes	Query only When CnC is enabled, an estimated frequency offset between desired and interferer will be calculated. Unit is in kilohertz (kHz). Example 1: CFM=+001.0 (1 kHz) Example 2: CFM=9999.9 (not locked or CnC not enabled)	N/A	CFM?	CFM=xxxx.x (see description of arguments)
Software Revision	N/A	34-37 bytes	Query only Units returns the value of the internal software revision installed in the unit, in the form: Boot:x.y.z Bulk1:x.y.z Bulk2:x.y.z or Boot:x.y.zz Bulk1:x.y.zz Bulk2:x.y.zz	N/A	SWR?	SWR=Boot:x.y.zz Bulk1:x.y.zz Bulk2:x.y.zz (see description of arguments)
Software Information	N/A	variable	Query only. Complete unit software information: Example: FRW= Boot: FW/11246-1-,1.1.1,11/11/04 Bulk1: FW/11245-,1.1.1,11/11/04 FW/11247-1-,1.1.1,11/11/04 FW/11248-1-,1.1.1,11/17/04 FW/11249-1-,1.1.1,09/27/04 FW/11250-1-,1.1.1,11/08/04 FW/11251-1-,1.1.1,11/16/04 FW/11252-1-,1.1.1,06/25/04 FW/11253-1-,1.1.1,10/21/04 FW/11254-1-,1.1.1,11/18/03 Bulk2: FW/11245A,1.1.1,11/11/04 FW/11247-1A,1.1.1,11/11/04 FW/11248-1B,1.1.1,11/17/04 FW/11249-1B,1.1.1,09/27/04 FW/11250-1-,1.1.1,11/08/04 FW/11251-1-,1.1.1,11/16/04 FW/11252-1-,1.1.1,06/25/04 FW/11253-1-,1.1.1,10/21/04 FW/11254-1-,1.1.1,11/18/03	N/A	FRW?	FRW=x...x (see description of arguments)

Parameter Type	Command (Instruction Code and qualifier)	Arguments for Command or Response to Query	Description of Arguments	Response to Command (Target to Controller)	Query (Instruction Code and Qualifier)	Response to query (Target to Controller)
Software Image	IMG=	1 byte, value of 1 or 2	Command or Query. Current active software image, where: 1=Bulk Image #1 currently active 2=Bulk Image #2 currently active	IMG= IMG? IMG* IMG# IMG^	IMG?	IMG=x (see description of arguments)
Serial Number of Modulator or Demodulator	N/A	9 bytes	Query only Used to query the modulator or demodulator card 9-digit serial number. It returns its S/N in the form xxxxxxxxx	N/A	SNO?	SNO=xxxxxxxx (see description of arguments)
Serial Number of Base Unit	N/A	9 bytes	Query only. Used to query the 9-digit serial number of the Qx base unit in the form: xxxxxxxxx	N/A	SNM?	SNM=xxxxxxxx (see description of arguments)
Serial Number of turbo card	N/A	9 bytes	Query only. Used to query the 9-digit serial number of the Turbo Codec card.	N/A	SNT?	SNT=xxxxxxxx (see description of arguments)
RX Frequency Offset	N/A	6 bytes	Query Only Unit returns the value of the measured frequency offset of the carrier being demodulated, in the form sxxx.x, where: xxx.x=value (range from 0 to 200 kHz, 100 Hz resolution) Returns +999.9 if the demodulator is unlocked Example: RFO=+002.3 (2.3 kHz)	N/A	RFO?	RFO=sxxx.x (see description of arguments)
Buffer Fill State	N/A	2 bytes	Query only Unit returns the value of the buffer fill state, between 1 to 99% Returns 00 if demodulator is unlocked Example: BFS=33 (33%)	N/A	BFS?	BFS=xx (see description of arguments)
Temperature of Modulator	N/A	3 bytes	Query only It returns the value of the internal card temperature, in the form of sxx (degrees C) s=sign (+ or – character) xx=value Example: TMP=+26	N/A	TMP?	TMP=sxx (see description of arguments)

Parameter Type	Command (Instruction Code and qualifier)	Arguments for Command or Response to Query	Description of Arguments	Response to Command (Target to Controller)	Query (Instruction Code and Qualifier)	Response to query (Target to Controller)
Temperature of the Base Unit	N/A	3 bytes	Query only Unit returns the value of the internal base unit temperature, in the form of sxx (degrees C) s=sign (+ or – character) xx=value Example: ITP=+26	N/A	ITP?	ITP=sxx (see description of arguments)

C.5.5 Bulk Commands

Parameter Type	Command (Instruction Code and qualifier)	Arguments for Command or Response to Query	Description of arguments	Response to Command (Target to Controller)	Query (Instruction Code and Qualifier)	Response to query (Target to Controller)
Global Configuration	MGC=	138 bytes, with numerical entries, fixed values and delimiters	<p>Command or Query Global Configuration of CDM-QX on a card slot basis if not grouped as a modem or on a modem basis if grouped. If the card is a Tx and ungrouped as modem, the Rx field will be filled with 'x', and vice-versa. The format is: abcdddd.ddddfghhhhh.hhhjjkk.klmnoppp.ppprstuvvvvvvAAAA.AAAABCDDEEEEE.EEEFGHIIJ.JKLMNOPPPPPPP QRSSTUUUUUUUUUVVWXYZZZ.ZZZaabbabbbb where:</p> <p>a=Unit Interface Type same as ITF b=T1 Line Build-out same as LBO c=Unit framing mode same as FRM dddd.dddd=Tx Frequency same as TFQ e=Tx FEC Type same as TFT f=Tx Modulation Type same as TMD g=Tx FEC Rate same as TCR hhhhh.hhh=Tx Data Rate same as TDR i=Tx Spectrum Inversion same as TSI j=Tx Scrambler State same as TSC kk.k=Tx Power Level same as TPL l=Tx Clock Source same as TCK m=Tx Data Invert same as TDI n=Tx Carrier State same as TXO o=AUPC Enable same as AUP ppp.pp=AUPC Parameter Setup same as APP q=Warm-up Delay same as WUD r=Tx Common Output state same as TXC s=Tx Reed-Solomon (n, k) value same as TRS t=Tx roll-off (alpha) factor same as TXA u=Tx Data Clock Invert same as TCI vvvvv=Expansion Bytes AAAA.AAAA=RX Frequency same as RFQ B=RX FEC Type same as RFT C=RX Modulation Type same as RMD D=RX FEC Rate same as RCR EEEE.EEE=RX Data Rate same as RDR F=RX Spectrum Inversion same as RSI G=RX Descrambler State same as RDS H=RX Data Invert same as RDI I=RX Sweep Width same as RSW JJ.J=Eb/No Alarm Point same as EBA K=RX Buffer Clock Source same as BCS L=RX Reed-Solomon (n, k) values same as RRS M= RX Buffer Size same as RBS N=RX Data Clock Invert same as RCI O=Rx roll-off (alpha) factor same as RXA PPPPPPP=Expansion Bytes Q=External Reference Bytes same as ERF R=EDMAC Framing Mode same as EFM SSSS=EDMAC Slave Address same as ESA T=Unit Test Mode (Read only) same as TST UUUUUUUUUU=Unit Alarm Mask same as MSK V=RTS/CTS Control same as RTS W=Statistics Sampling Interval same as SSI X=CnC Mode same as CNM YYY=CnC Frequency Offset same as CCF ZZZ.ZZZ=CnC Min/Max Search Delay same as CSD aaa=CnC Re-Acquisition time same as CRA bbbbbbb=Expansion Bytes Fill unused expansion bytes with 'x'</p>	MGC= MGC? MGC* MGC# MGC\$ MGC^	MGC? MGC?n	MGC=abcdddd.ddddfghhhhh.hhhjjkk.klmnop pp.ppprstuvvvvvvAAAA.AAAABCDDEEEEE.E EEFGHIIJ.JKLMNOPPPPPPPQRSSTUU UUUUUUUUUVVWXYZZZ.ZZZaabbabbbb bb Where n=0 to 9 Returns the MGC portion of 1 of 10 stored configurations (see description of arguments)

Parameter Type	Command (Instruction Code and qualifier)	Arguments for Command or Response to Query	Description of arguments	Response to Command (Target to Controller)	Query (Instruction Code and Qualifier)	Response to query (Target to Controller)
OGC Outdoor Unit Global Configuration (L-Band Unit only)	OGC=	50 bytes	<p>Command or Query ODU Global Configuration in the form: aabcdexxxxhhhhiiiijjjjkxxxxxxlmnnnooooooppqqxxxx, where:</p> <p>aa=BUC Address b=BUC FSK comms enable c=BUC Power Control d=BUC 10 MHz Freq Ref Enable e=BUC TX Output Enable xxxx=expansion bytes hhhh=BUC Low Alarm Limit iiii=BUC High Alarm Limit jjjjk=BUC LO frequency, mix sign xxxxx=expansion bytes l=LNB Power Control m=LNB 10 MHz Freq Ref Enable nnn=LNB Low Alarm Limit ooo=LNB High Alarm Limit ppppq=LNB LO Freq, mix sign xxxxx=expansion bytes</p> <p>Any unavailable parameters will be filled with xxx.</p>	OGC= OGC? OGC* OGC# OGC^	OGC?	OGC= abcde xxxhhhhiiiijjjjkxxxxxx lmnnnooooooppqqxxx xxx (see description of arguments)

C.5.6 BUC Commands

Parameter Type	Command (Instruction Code and qualifier)	Arguments for Command or Response to Query	Description of arguments	Response to Command (Target to Controller)	Query (Instruction Code and Qualifier)	Response to query (Target to Controller)
BUC Address (L-Band Unit only)	BAD=	2 bytes, value of 01 to 15	Command or Query Indicates the Block Up Converter (BUC) Address, in the form: xx, where xx is between 01 and 15 Example: BAD=03 Note: This command is only valid when the FSK and BUC power are enabled.	BAD= BAD? BAD* BAD# BAD^	BAD?	BAD=xx (see description of arguments)
BUC Comms Enable (L-Band Unit only)	BCE=	1 byte, value of 0,1	Command or Query Enables or disables communications, via the FSK link, with an externally connected BUC, where: 0=Disabled 1=Enabled Example: BCE=0 (Disabled)	BCE= BCE? BCE* BCE# BCE^	BCE?	BCE=x (see description of arguments)
BUC Power Control (L-Band Unit only)	BPC=	1 byte, value of 0,1	Command or Query 0=Disable BUC DC Power 1=Enable BUC DC Power	BPC= BPC? BPC* BPC# BPC^	BPC?	BPC=x (see description of arguments)
BUC 10 MHz Reference (L-Band Unit only)	BFR=	1 byte, value of 0,1	Command or Query Enables or disables the 10 MHz frequency reference to the BUC. 0=Disabled 1=Enabled	BFR= BFR? BFR* BFR# BFR^	BFR?	BFR=x (see description of arguments)

Parameter Type	Command (Instruction Code and qualifier)	Arguments for Command or Response to Query	Description of arguments	Response to Command (Target to Controller)	Query (Instruction Code and Qualifier)	Response to query (Target to Controller)
BUC Output Enable (L-Band Unit only)	BOE=	1 byte, value of 0,1	Command or Query Indicates BUC Output enable 0=Off (Output Disabled) 1=On(Output Enabled) Example: BOE=1 (BUC Output is Enabled) Note: This command is only valid when the BUC FSK comms and BUC power are enabled.	BOE= BOE? BOE* BOE# BOE^	BOE?	BOE=x (see description of arguments)
BUC High Current Limit (L-Band Unit only)	BCH=	4 bytes	Command or Query BUC High Current Limit, a value between 500 and 3200 mA Example: BCH=3100	BCH= BCH? BCH* BCH# BCH^	BCH?	BCH=xxxx (see description of arguments)
BUC Low Current Limit (L-Band Unit only)	BCL=	4 bytes	Command or Query BUC Low Current Limit, a value between 100 and 3000 mA Example: BCL=0600	BCL= BCL? BCL* BCL# BCL^	BCL?	BCL=xxxx (see description of arguments)
BUC LO Frequency (L-Band Unit only)	BLO=	6 bytes	Command or Query BUC transmit LO frequency information in the form: xxxxs, where : xxxxx is the LO frequency in the range of 3000 to 65000 MHz All 0's (000000) disables the feature S is the sign for the mix (+ or – character) Terminal Frequency= BUC LO TFQ Example: BLO=12000+ (BUC LO is 12 GHz, low-side mix)	BLO= BLO? BLO* BLO# BLO^	BLO?	BLO=xxxxxs (see description of arguments)
BUC Output Power Level (L-Band Unit only)	N/A	4 bytes	Query only BUC output power level in the form xxx, where xxx is the value in watts. Example: BOL=08.3 (BUC reports output is 8.3 watts) Returns 00.0 when FSK and BUC power are not enabled.	N/A	BOL?	BOL=xx.x (see description of arguments)

Parameter Type	Command (Instruction Code and qualifier)	Arguments for Command or Response to Query	Description of arguments	Response to Command (Target to Controller)	Query (Instruction Code and Qualifier)	Response to query (Target to Controller)
BUC Temperature (L-Band Unit only)	N/A	4 bytes	Query only Indicates BUC temperature, in the form: sxxx Where: s=sign (+ or – character) xx=value If not available, response is –99 Example: BUT=-13 (BUC temperatures is -13°C) Note: This query is only valid when the FSK and BUC power are turned On.	N/A	BUT?	BUT=sxx (see description of arguments)
BUC PLL Alarm (L-Band Unit only)	N/A	1 byte, value of 0,1	Query only BUC PLL lock state, where: 0=Unlocked 1=Locked Example: BPA=1 (BUC PLL is locked) Note: This query is only valid when the FSK and BUC power are turned On	N/A	BPA?	BPA=x (see description of arguments)
BUC Software Version (L-Band Unit only)	N/A	3 bytes	Query only Indicates the BUC software version, in the form: x.x Example: BSV=1.1 (Software version 1.1) Note: This query is only valid when the FSK and BUC power are turned On	N/A	BSV?	BSV=x.x (see description of arguments)
BUC Current (L-Band Unit only)	N/A	4 bytes	Query only Indicates the value of the BUC Current, in the form: xxxx, where: xxxx is between 0 and 9999, units MA. If not available, response is 0000 Example: BDC=3100	N/A	BDC?	BDC=xxxx (see description of arguments)

Parameter Type	Command (Instruction Code and qualifier)	Arguments for Command or Response to Query	Description of arguments	Response to Command (Target to Controller)	Query (Instruction Code and Qualifier)	Response to query (Target to Controller)
BUC Voltage (L-Band Unit only)	N/A	4 bytes	Query only Indicates the value of the BUC voltage, in the form: xx.x Where: xx.x is between 0 and 64.0 If not available, response is 00.0 Example: BDV=43.6 (BUC DC voltage is 43.6 volts)	N/A	BDV?	BDV=xx.x (see description of arguments)
Terminal Tx Frequency (L-Band Unit only)	N/A	10 bytes	Query only. Terminal Tx Frequency, where frequency = BUC LO \pm TFQ Resolution = 100 Hz Returns 00000.0000 if BUC LO is zero Example: TTF=14250.9872	N/A	TTF?	TTF=xxxxx.xxxx (see description of arguments)

C.5.7 LNB Commands

Parameter Type	Command (Instruction Code and qualifier)	Arguments for Command or Response to Query	Description of arguments	Response to Command (Target to Controller)	Query (Instruction Code and Qualifier)	Response to query (Target to Controller)
LNB Power Control (L-Band Unit only)	LPC=	1 byte, value of 0,1,2	Command or Query LNB Power Control, where: 0=Off 1=On, 13V LNB Voltage 2=On, 18V LNB Voltage Example: LPC=1 (LNB Power is On, 13V)	LPC= LPC? LPC* LPC# LPC^	LPC?	LPC=x (see description of arguments)
LNB Frequency Reference Enable (L-Band Unit only)	LFR=	1 byte, value of 0, 1	Command or Query 0=Disable LNB Reference 1=Enable LNB Reference	LFR= LFR? LFR* LFR# LFR^	LFR?	LFR=x (see description of arguments)

Parameter Type	Command (Instruction Code and qualifier)	Arguments for Command or Response to Query	Description of arguments	Response to Command (Target to Controller)	Query (Instruction Code and Qualifier)	Response to query (Target to Controller)
LNB Low Current Limit (L-Band Unit only)	LCL=	3 bytes	Command or Query LNB lower alarm limit for current, in the form xxx, where xxx is the current value between 10 and 400 mA.	LCL= LCL? LCL* LCL# LCL^	LCL?	LCL=xxx (see description of arguments)
LNB High Current Limit (L-Band Unit only)	LCH=	3 bytes	Command or Query LNB higher alarm limit for current, in the form of xxx, where xxx is the current value between 50 and 600 mA.	LCH= LCH? LCH* LCH# LCH^	LCH?	LCH=xxx (see description of arguments)
LNB LO Frequency (L-Band Unit only)	LLO=	6 bytes	Command or Query LNB Receive LO frequency information in the form: xxxxxx, where: xxxxxx is the LO frequency, in the range of 3000 to 65000 MHz. All 0's (000000) disables this feature. s is the sign for the mix (+ or - character) Terminal Frequency = LNB LO RFQ Example: LLO=06000- (LO is 6 GHz, high-side mix)	LLO= LLO? LLO* LLO# LLO^	LLO?	LLO=xxxxxs (see description of arguments)
LNB Current (L-Band Unit only)	N/A	3 bytes	Query only. Indicates the value of the LNB Current, in the form: xxx, where xxx is between 0 and 999, units mA. If not available, response is 000. Example: LDC=210 (LNB DC current is 210 mA)	N/A	LDC?	LDC=xxx (see description of arguments)
LNB Voltage (L-Band Unit only)	N/A	4 bytes	Query only. Indicates the value of the LNB Voltage, in the form: xx.x, where xx.x is between 0 and 20.0 If not available, response is 00.0 Example: LDV=18.1 (LNB DC voltage is 18.1 volts)	N/A	LDV?	LDV=xx.x (see description of arguments)
Terminal Rx Frequency (L-Band Unit only)	N/A	10 bytes	Query only. Terminal Rx Frequency, where frequency = LNB LO ± RFQ Resolution = 100Hz Returns 00000.0000 if LNB LO is zero Example: TRF=11650.2249	N/A	TRF?	TRF=xxxxx.xxxx (see description of arguments)

C.5.8 Built-in BERT commands (BER Tester)

Parameter Type	Command (Instruction Code and Qualifier)	Arguments for Command or Response to Query	Description of arguments	Response to Command (Target to Controller)	Query (Instruction Code and Qualifier)	Response to query (Target to Controller)
Built-in BERT state (applies to card-by-card basis)	BST=	1 byte, value of 0 and 1	Command or Query State of built-in tester (BST), where: 0=Off 1=On	BST= BST? BST* BST# BST\$ BST^	BST?	BST=x (see description of arguments)
BERT Config Pattern state (applies to card-by-card basis)	BCP=	1 byte	Command or Query Syntax: BCP=x, where x=BERT pattern BERT Pattern: 0 = space 1 = mark 2 = 1:1 3 = 1:3 4 = 63 5 = 511 6 = 2047 (default) 7 = 2047R (or 2047 Alternate) 8 = Mil 188 9 = 2 ¹⁵ -1 A = 2 ²⁰ -1 B = 2 ²³ -1	BCP= BCP? BCP* BCP# BCP\$ BCP^	BCP?	BCP=x (see description of arguments)
BERT Restart Monitor (applies to Rx card)	BRM=	1 byte, value of 1 only	Command only. Restarts or resets the BERT monitor. Example: BRM=1	BRM= BRM? BRM# BRM\$ BRM^ BRM@	N/A	N/A
BERT 10E-3 Error Insert (applies to Tx card)	BKE=	1 byte, value of 0, 1	Command or Query. Inserts 10E-3 BER. 0 = Off 1 = On Example: BKE=1	BKE= BKE? BKE# BKE\$ BKE^ BKE@	BKE?	BKE=x (see description of arguments)

Parameter Type	Command (Instruction Code and Qualifier)	Arguments for Command or Response to Query	Description of arguments	Response to Command (Target to Controller)	Query (Instruction Code and Qualifier)	Response to query (Target to Controller)
BERT Config Sync Loss Threshold (applies to Rx card)	BCT=	1 byte, value of 0 to 3	Command or Query. BERT config sync loss threshold. 0 = 256 bit errors counted in less than 1000 bits of data 1 = low (100 bit errors in less than 1000 bits of data) 2 = med (250 bit errors in less than 1000 bits of data) 3 = high (20,000 bit errors in less than 100,000 bits of data)	BCT= BCT? BCT# BCT\$ BCT^ BCT@	BCT?	BCT=x (see description of arguments)
BERT Result in bit errors (applies to Rx card)	N/A	7 bytes, numeric	Query only. BERT monitor results in bit errors. If bit errors exceed 9999999, then BRE=9999999.	N/A	BRE?	BRE=xxxxxxx (see description of arguments)
BERT Result in average BER	N/A	5 bytes	Query only Returns the value of the average BER in the form a.b x 10 ^{-c} . First 3 bytes are the value. Last 2 bytes are the exponent. Returns 99999 if there's no sync in BERT monitor. Returns 99.99 if sync loss has occurred. Example: BER=4.8E3 (BER = 4.8 x 10 ⁻³)	N/A	BRR?	BRR=a.bEc (see description of arguments)

C.5.9 Spectrum Analyzer Commands

Parameter Type	Command (Instruction Code and qualifier)	Arguments for Command or Response to Query	Description of arguments	Response to Command (Target to Controller)	Query (Instruction Code and Qualifier)	Response to query (Target to Controller)
Spectrum Analyzer Mode (applies to Rx card)	SPM=	1 byte	Command or Query 0=Off 1=On	SPM= SPM? SPM* SPM# SPM\$ SPM^ SPM@	SPM?	SPM=x (see description of arguments)
Spectrum Analyzer Center Frequency (applies to Rx card)	SPF=	9 bytes	Command or Query Tx Frequency, 950 to 1950 MHz (L-Band units) 50 to 90/100 and 180 MHz (70/140 MHz units) Resolution = 100 Hz Example: SPF=0050.9872	SPF= SPF? SPF* SPF# SPF\$ SPF^ SPF@	SPF?	SPF=xxxx.xxx (see description of arguments)
Spectrum Analyzer Span (applies to Rx card)	SPS=	1 byte	Command or Query. 0 = 97.65625 kHz 1 = 195.3125 kHz 2 = 390.625 kHz 3 = 781.25 kHz 4 = 1.5625 MHz 5 = 3.125 MHz 6 = 6.25 MHz 7 = 12.5 MHz	SPS= SPS? SPS* SPS# SPS\$ SPS^ SPS@	SPS?	SPS=x (see description of arguments)

Parameter Type	Command (Instruction Code and qualifier)	Arguments for Command or Response to Query	Description of arguments	Response to Command (Target to Controller)	Query (Instruction Code and Qualifier)	Response to query (Target to Controller)
Drop Timeslot (applies to cards grouped as modem)	DTS=	3 bytes for command, 31 bytes for query	Command or query. <i>(Note different format between command and query.)</i> Command format: DTS=xy Where xx = Channel 01 through 31 y = timeslot: 0-9, A=10, B=11, C=12, D=13,...V=31	DTS= DTS? DTS* DTS# DTS\$ DTS^	DTS?	DTS=yyyyyyyyyyyyy yyyyyyyyyyyyyyyyy Indicating all 31 Drop timeslots values associated with the 31 Tx Satellite channels.
Insert Timeslot (applies to cards grouped as modem)	ITS=	3 bytes for command, 31 bytes for query	Command or query. <i>(Note different format between command and query.)</i> Command format: ITS=xy Where xx = Channel 01 through 31 y = timeslot: 0-9, A=10, B=11, C=12, D=13,...V=31	ITS= ITS? ITS* ITS# ITS\$ ITS^	ITS?	ITS=yyyyyyyyyyyyy yyyyyyyyyyyyyyyyy Indicating all 31 Insert timeslots values associated with the 31 Rx Satellite channels.

Notes:

Appendix D. Carrier-in-Carrier[®] PERFORMANCE CHARACTERIZATION

D.1 Carrier-in-Carrier[®] Description

DoubleTalk[™] Carrier-in-Carrier[®] (CnC) is an adaptive cancellation technology that significantly reduces bandwidth occupancy by allowing two carriers to simultaneously occupy the same spectral location, a practice that is disastrous for normal carriers. By comparison, standard carriers must occupy non-overlapping spectral segments with no more than one carrier in the same space.

In a number of ways, CnC carriers behave similar to conventional carriers in satellite links. They are both exposed to adjacent carriers, cross-polarization and rain fade, and exhibit impairments when any of these become too great. In addition, CnC operates in an environment where:

- Carriers intentionally occupy the same spectral slot
- Performance depends upon desired and co-located interfering carrier.

Several areas relating to CnC performance are discussed, including:

- Adjacent carrier performance
- Eb/No Degradation as a function of the CnC ratio
- Symbol rate ratio
- Carrier offset
- The effects of rain fade and asymmetric antennas.

Nominally, these effects are treated independently so it is possible to add them together to estimate the total degradation. Initially, degradation due to carrier spacing is examined to characterize the adjacent carrier performance. Next, the CnC ratio is evaluated to estimate its impact. The symbol rate ratio of CnC carriers and the allowable carrier offset are discussed followed by some CnC examples.

The rules for CnC operation are summarized below:

- Both earth stations share the same footprint so each sees both carriers
- CnC carriers are operated in pairs
- One outbound with multiple return carriers is not allowed
- Asymmetric data rates are allowed up to a symbol rate ratio of 3
- Minimum symbol rate for CnC is 128 ksp/s
- The CnC ratio is normally less than 10 dB
- CnC operates with modems not modulators only or demodulators only.

D.2 Degradation Due To Carrier Spacing

In satellite links, one of the impairments to estimate is the impact of carrier spacing on performance and allocate the degradation to the link budget. Data was taken using the CDM-Qx Modem, operating with Turbo coding, to measure E_b/N_0 degradation with decreasing carrier spacing to characterize performance in the presence of two equally spaced like modulated adjacent carriers. This is done without CnC.

For testing, the modem is initially set up with noise to operate at a nominal or reference E_b/N_0 corresponding to a BER $\approx 10^{-8}$ and with no adjacent carrier present. A like-modulated adjacent carrier is then added and the E_b/N_0 degradation recorded. The test is conducted with a single adjacent carrier as shown in Case A of **Figure D-1**, but this is equivalent to two equally spaced adjacent carriers on either side of the desired carrier, each 3 dB less than a single adjacent carrier as shown in Case B.

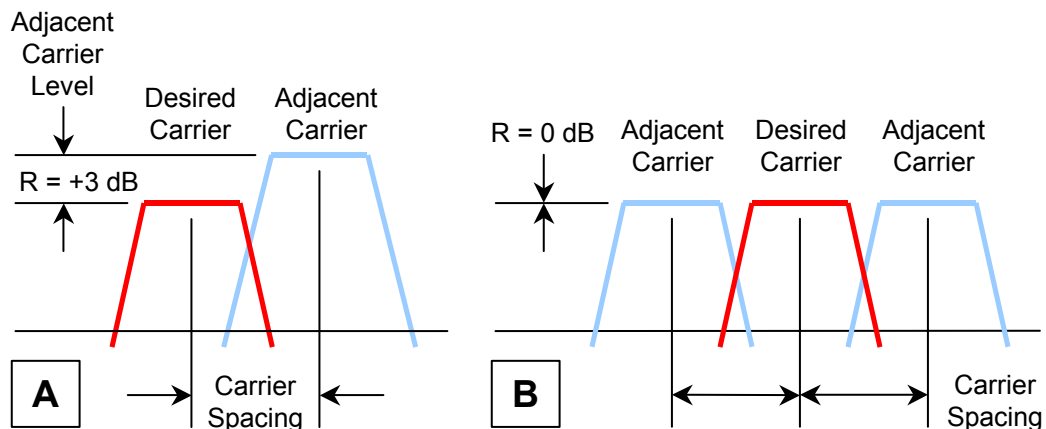

Figure D-1. Adjacent Carrier: A (As Tested) and B (As Plotted)

The results are plotted for two equally spaced adjacent carriers each at -3 dB, 0 dB, +3 dB, and +6 dB relative to the desired carrier to produce a family of operating curves. **Figure D-2**, through **Figure D-4** plot the results for the QPSK, 8-PSK and 16-QAM cases.

The following table contains the CDM-Qx configurations tested:

Modulation	Forward Error Correction	Reference Eb/No At BER $\approx 10^{-8}$	Symbol Rate	Data Rate	Rolloff (α)
QPSK	3/4 Turbo	3.9 dB	1000 ksps	1500 kbps	20 and 35%
8-PSK	3/4 Turbo	6.3 dB	1000 ksps	2250 kbps	20 and 35%
16-QAM	3/4 Turbo	7.7 dB	1000 ksps	3000 kbps	20 and 35%

The results are plotted for Eb/No degradation versus relative carrier spacing where:

- Eb/No degradation is the difference between the reference Eb/No and the Eb/No read from the modem in the presence of the interfering adjacent carrier.
- Relative Carrier Spacing is the distance between the centers of the desired and adjacent carriers divided by the symbol rate.

There are two sets of adjacent carrier plots representing operation with 20% and 35% rolloff (α). When α is 20%, the spectrum is narrower than it is for 35%. The effect of this is noticed in the adjacent carrier plots. The 20% plots are displaced slightly to the left of those for 35%. This makes it possible to space carriers slightly closer when the rolloff is 20%. The table below generalizes degradation (≤ 0.5 dB) for all modulation and coding combinations when there are two adjacent carriers:

	Carrier Spacing For 20% Rolloff	Carrier Spacing For 35% Rolloff
Degradation ≤ 0.5 dB	$\geq 1.1 \times$ Symbol Rate	$\geq 1.2 \times$ Symbol Rate

Some caution is required because carriers with 20% rolloff are more sensitive to impairments and non-linearity in the link.

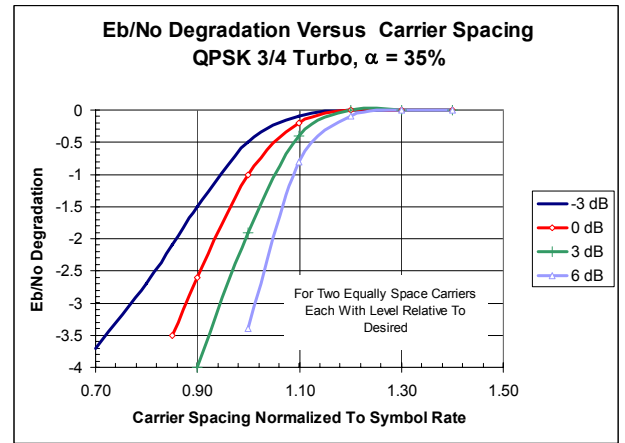
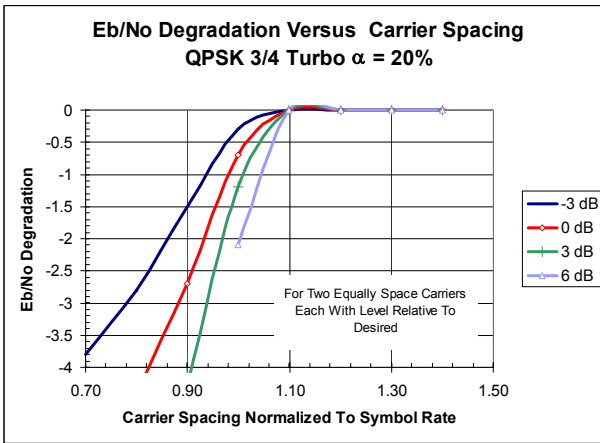

Figure D-2. QPSK 3/4 Turbo degradation versus relative carrier spacing (for two adjacent carriers)

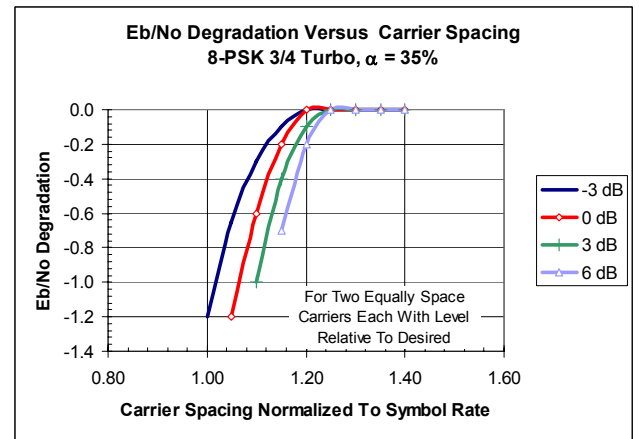
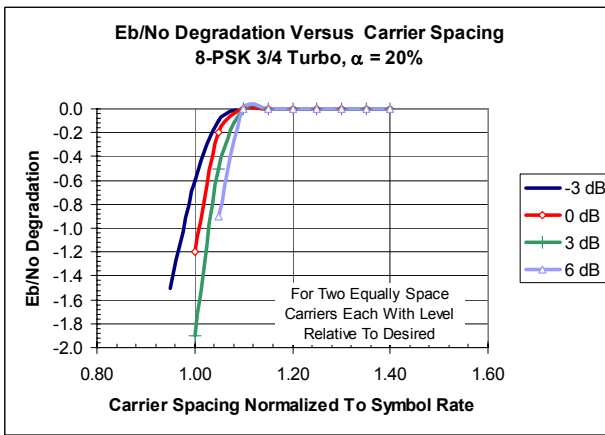

Figure D-3. 8-PSK 3/4 Turbo degradation versus relative carrier spacing (for two adjacent carriers)

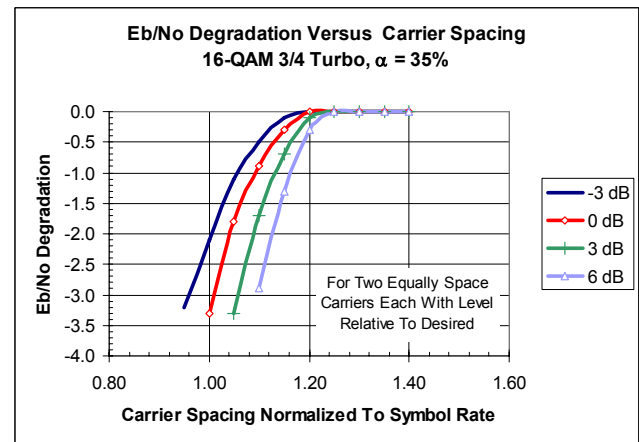
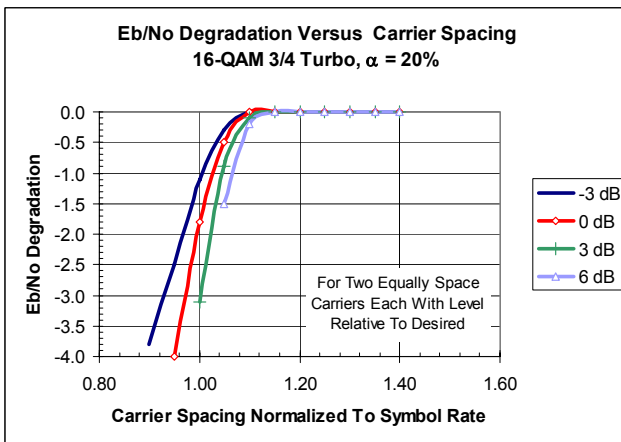

Figure D-4. 16-QAM 3/4 Turbo degradation versus relative carrier spacing (for two adjacent carriers)

Other QPSK turbo code rates have similar performance and the QPSK plots above are used to estimate their performance. The degradation plots above are also used for other turbo 8-PSK and 16-QAM code rates. A good practice for carrier spacing is to operate the links with sufficient spacing so there is no degradation.

D.3 Selecting The Adjacent Carrier Curve

The information presented earlier characterizes the case for one or two adjacent carriers relative to the desired carrier. The desired and adjacent carriers may also be CnC carriers occupying the adjacent slots. These cases are summarized by several variants shown in **Figure D-5**. Understanding the relationship between these assists in selection of the correct adjacent carrier degradation curve.

Case A in **Figure D-5** illustrates the way the adjacent carrier testing is conducted. It shows a single adjacent carrier 3 dB higher than the desired carrier, equivalent to two like-modulated adjacent carriers on either side of the desired carrier, each at the same level as the desired (0 dB higher). Case B shows two adjacent carriers each 3 dB higher than the desired.

Case C illustrates a CnC with a pair of co-located desired carriers (CnC ratio is 0) and a single adjacent slot with pair of CnC carriers whose total composite power is 3 dB higher than the desired pair. The total adjacent power to one of the CnC carriers is 6 dB, or the equivalent of two single adjacent carriers (one on each side of the desired) each 3 dB higher than “one” of the desired CnC carriers. It does not matter whether the adjacent carrier is a pair of CnC carriers or a standard carrier. It is based on the power.

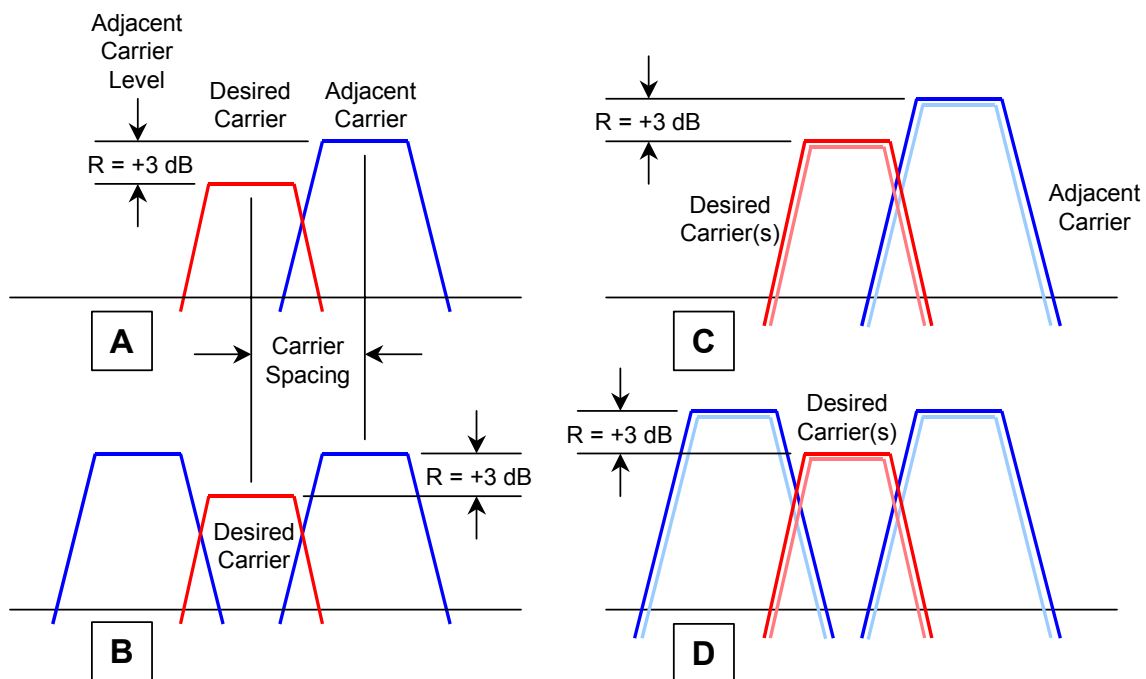

Figure D-5. Adjacent Carrier Cases

Case D shows two desired CnC carriers accompanied by a CnC carrier on each side. Again, it does not matter whether the adjacent carriers are CnC or conventional carriers, just the total power. This situation is equivalent to adjacent carriers each 6 dB greater than the one desired CnC carrier. The following table summarizes which adjacent carrier plot to select for this particular example, and which ones to use with a ratio, R, between the composite adjacent and composite desired carriers.

Case (Figure D-5)	Desired Carrier	Adjacent Carrier (See Note)	Curve To Use In Figure D-2, Error! Reference source not found., or D-4	Curve To Use For Any Ratio R (dB)
A	1 Carrier	1 Adjacent Carrier	0 dB	R - 3 dB
B	1 Carrier	2 Adjacent Carriers	+3 dB	R + 0 dB
C	1 CnC Carrier	1 Adjacent Carrier	+3 dB	R + 0 dB
D	1 CnC Carrier	2 Adjacent Carriers	+6 dB	R + 3 dB

Note: The adjacent carrier is the composite power for either a conventional carrier or CnC. carrier.

D.4 Carrier-in-Carrier Ratio (CnC Ratio)

The CnC Ratio represents the difference in power between the co-located interfering carrier and the desired carrier in dB.

$$\text{CnC Ratio} = \text{Interferer Power} - \text{Desired Carrier}$$

During CnC operation, the interfering carrier is removed by the CDM-Qx using a stored version of the transmitted carrier to adaptively cancel it from the composite received signal. The desired carrier remaining after the cancellation process is delivered to the demodulator and decoder to recover the data.

When the CnC ratio increases, the level of the interferer rises relative to the desired carrier and degradation grows. As the CnC ratio decreases, the desired carrier dominates and degradation becomes negligible. **Figure D-6** represents two cases of the CnC Ratio when the interfering and desired carriers are equal, and when the interferer is 6 dB stronger than the desired carrier. This representation is artificial because a real spectral plot displays only the composite power of the combined carriers and is unable to distinguish two carriers, but it is instructive to describe the underlying principle.

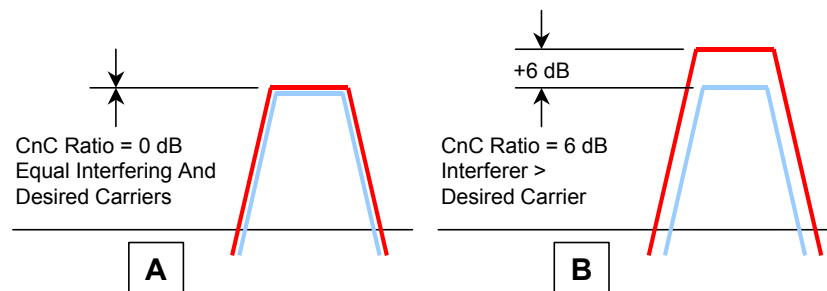

Figure D-6. CnC Ratio

The following CDM-Qx configurations were tested for Eb/No degradation as a function of CnC ratio:

Modulation	Forward Error Correction	Reference Eb/No At BER $\approx 10^{-6}$	C/N
QPSK	21/44 Turbo	2.6 dB	2.4 dB
QPSK	3/4 Turbo	3.7 dB	5.5 dB
QPSK	7/8 Turbo	4.3 dB	6.7 dB
QPSK	17/18 Turbo	6.5 dB	9.3 dB
8-PSK	2/3 TCM	5.3 dB	7.9 dB
8-PSK	3/4 Turbo	6.1 dB	9.6 dB
8-PSK	7/8 Turbo	7.1 dB	11.3 dB
8-PSK	17/18 Turbo	9.0 dB	13.5 dB
16-QAM	3/4 Turbo	7.2 dB	12.0 dB
16-QAM	7/8 Turbo	8.1 dB	13.5 dB

The Eb/No degradation is the difference between the reference Eb/No with no interfering carrier present and the Eb/No reported by the modem at a given CnC ratio.

Figure D- plots the impact of CnC ratio on QPSK and 8-PSK constellations, and **Figure D-8** shows 16-QAM. In general, the higher the operating C/N of a carrier, the more sensitive it is to degradation. QPSK is the least sensitive to CnC ratio followed by 8-PSK and 16-QAM.

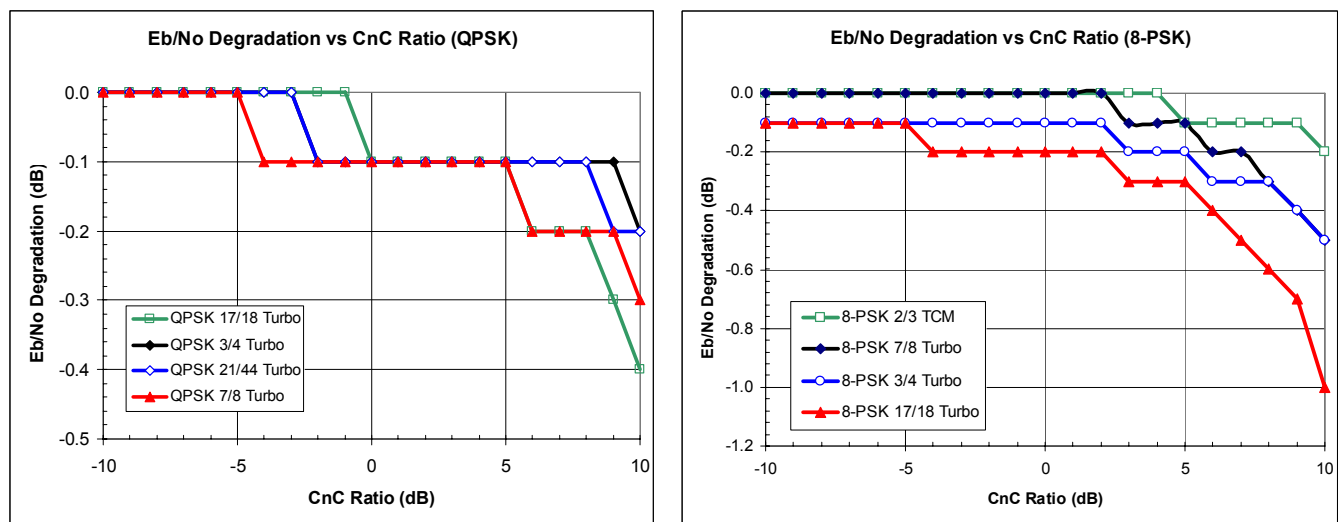

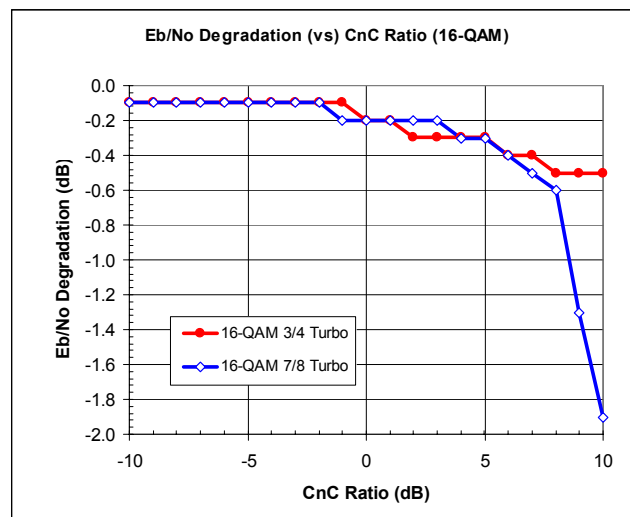

Figure D-8. CnC Ratio For 16-QAM

D.5 Symbol Rate Ratio

CnC operation is restricted to a maximum symbol rate ratio ≤ 3 . This is the ratio of the larger carrier to the smaller one. Within these limits, the performance characterized applies. The limitation on the symbol range still allows a wide range of data rates.

It is necessary to take into account the symbol rate ratio to properly estimate the CnC ratio, although the modem does this automatically. For estimating the link parameters, the CnC ratio is adjusted by $10 \log(\text{Symbol Rate Ratio})$. If the symbol rate ratio is 2.0 then the narrower carrier has a 3 dB CnC ratio when the CnC carriers have the same spectral density.

D.6 CnC Carrier Offset

CnC carriers are normally placed directly on top of each other with the same center frequency for both carriers. Normal operation is obtained when the center frequency of the two carriers is within ± 32 kHz. This is the same as the normal acquisition range of the modem for standard and CnC carriers.

D.7 1st CnC Example: Adjacent Carriers, CnC Ratio and Rain Fade

As an example, a pair CnC carriers is flanked by two adjacent CnC pairs with a carrier spacing of $1.3 \times \text{Symbol Rate}$ and the power level is the same for all carriers as shown in **Figure D-9**. In this scenario, the modulation is 8-PSK 3/4 Turbo with identical data rates.

Referring back to Error! Reference source not found., the degradation due to adjacent carrier spacing is negligible when spacing is 1.3 x Symbol Rate and 0 db is allocated for adjacent carrier degradation.

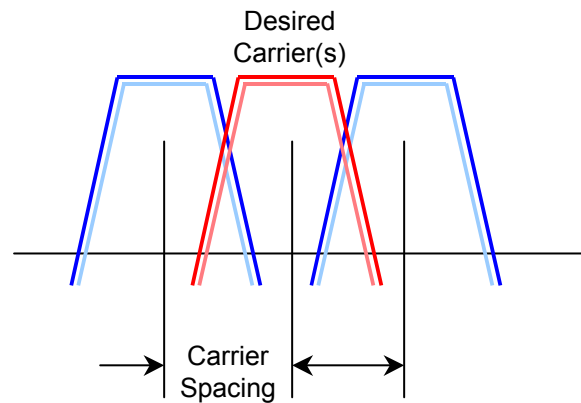

Figure D-9. CnC Example

Initially the CnC ratio is 0 dB, and the desired and interfering carriers are operating at the same power level. At one end of the link (Site A), a downlink fade of 4 dB is expected and an uplink fade of 6 dB. The other end of the link (Site B) is allocated 2 dB for downlink and 3 dB for the uplink:

	DL Fade	UL Fade
Site A	4 dB	6 dB
Site B	2 dB	3 dB

When a rain fade occurs at one site, the effect is felt at both sites as outlined in **Figure D-10**, which diagrams the worst case fade at Site A. The interfering carrier at Site A is attenuated twice, once due to the uplink and the second time due to the downlink on the return path. The carrier transmitted from Site B sees only the downlink fade when it is received at Site A. The resulting power level changes at each site due to the rain fade and the resulting CnC ratio and Eb/No degradation is summarized in the following table:

Site A			Site B		
Parameter	dB	Comment	Parameter	dB	Comment
Relative Level of Carrier A @ Site A	-10	Due to fade at A	Relative Level of Carrier B @ Site B	0	Due to fade at A
Relative Level of Carrier B @ Site A	-4	Due to fade at A	Relative Level of Carrier A @ Site B	-6	Due to fade at A
CnC Ratio At Site A	-6		CnC Ratio At Site B	+6	
Degradation At Site A	-0.1	Per Figure D-8-PSK	Degradation At Site B	-0.3	Per Figure D-8-PSK

Notice from the table, the CnC change is proportional to the uplink fade. The CnC ratio decreases by the amount of the uplink fade at the near end while the CnC ratio increases by the amount of uplink fade at the distant end. Also, the CnC ratio at opposite ends of the link has the same magnitude but opposite sine.

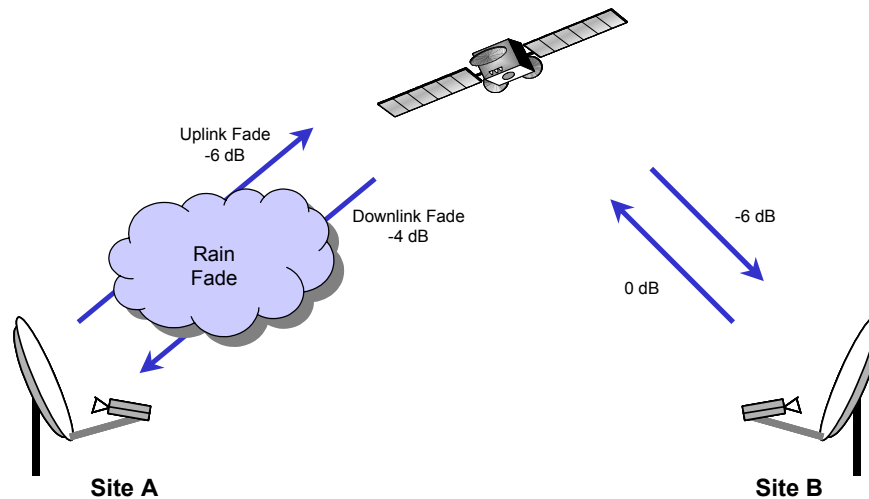

Figure D-10. Link With Fading At Site A

As shown, the interfering carrier at Site A is attenuated twice passing through both the uplink and returning on the downlink back to Site A. Since the carrier transmitted and then received at Site A is the interfering carrier this extra attenuation is much less of an issue because it makes the CnC ratio more negative (less degradation). In a practical link the interfering carrier might drop into the noise leaving the demodulator to recover the desired carrier nearly absent the undesired interferer.

At Site B, the desired carrier from Site A is received and attenuated thereby increasing the CnC ratio (more degradation). In links similar to these, the unfaded end of the link has the highest CnC ratio.

In links without rain fade, the CnC ratio is constant and only the asymmetry of link due to satellite footprint, different antenna sizes, different symbol rates, or modulation and code rates alter the ratio.

D.8 2nd CnC Example: CnC Ratio With Asymmetric Links

Networks with asymmetric antennas are common with a larger antenna at one site (hub) and smaller ones at the other sites (remotes) and often have asymmetric data rates. In a number of links even a significant rain fade is not a big factor in CnC performance. Some links, particularly C-Band or X-Band, have insignificant rain fades and the key to performance is setting both ends of the link to handle the asymmetry.

In asymmetric links, taking advantage of the available modulation and coding schemes is another tool for building efficient CnC links. In these links the ideal CnC ratio is 0 dB, but keeping the CnC ratio less than 7 dB, under all conditions, establishes links with margin. A link with a negative CnC ratio is also acceptable because the interfering signal is below the desired signal.

An asymmetric C-Band link is shown in **Figure D-11**. It has equal symbol rate carriers but the antenna at Site A is 4.5 meters antenna and Site B is 2.4 meters.

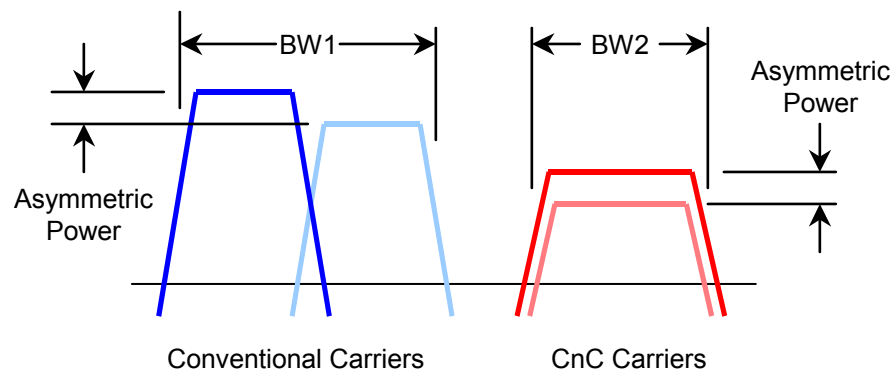

Figure D-11. Asymmetric Link with the Same Data Rate but Different Antennas

Conventional side-by-side carriers are transmitted by the link on the left, and CnC carriers are deployed on the right. The conventional carriers are 8-PSK 2/3 TCM, and the CnC carriers are QPSK 3/4 Turbo. Notice that the bandwidth to support the two conventional carriers (BW1) is larger than the bandwidth for CnC (BW2), even though the conventional link uses 8-PSK 2/3 while CnC is QPSK 3/4. The benefit of CnC becomes apparent when it is realized that the bandwidth reduction possible with CnC is also accompanied by a reduction in power compared to the conventional link.

The link parameters and results are summarized in the table:

Parameters	Site A	Site B
Satellite EIRP (dBW)	37	37
Satellite BOo (dB)	6	6
Satellite BOi (dB)	10	10
Satellite SFD (dbW/m ²)	-78	-78
Satellite G/T (dB/K)	0	0
E/S Antenna (meters)	4.5	2.4
Data Rate (kbps)	192	192
Carrier Spacing Factor	1.3	1.3
Conventional Link	8PSK 2/3 TCM	8PSK 2/3 TCM
Occupied BW1 for 2 Carriers (kHz)	274.6	274.6
% of Transponder Power	0.55	0.16
CnC Link	QPSK 3/4 Turbo	QPSK 3/4 Turbo
Occupied BW2 for 2 Carriers (kHz)	166.4	166.4
% of Transponder Power	0.37	0.11
CnC Ratio (dB)	+5.3	-5.3
Expected Eb/No Degradation (dB)	-0.1	0.0

The link asymmetry has increased the CnC ratio at Site A to +5.3 dB. Yet this results in a degradation of only 0.1 dB. This is a C-Band link so no additional change in signal level is expected due to rain fade. The CnC ratio at Site B is -5.3 dB so no degradation is expected.

What is done if the CnC ratio is 10 dB or more? In a C-Band link it is possible to tolerate the additional impairment, but then the modem is operating with less margin. One possibility to reduce the CnC ratio is to increase the amount of power transmitted from the remote site with the smaller antenna. This is feasible in some instances where there are higher power satellite transponders. If the installation is a new one, a larger, though more expensive, antenna is possible at the remote site. This simultaneously decreases the CnC ratio at the hub while increasing it at the remote site.

Another alternative is to reduce the modulation order and/or error correction code rate on the receive side of the remote site. This decreases the power transmitted by the hub and reduces its CnC ratio. The hub's CnC ratio will decrease further if it is possible to increase the modulation order or code rate at the hub. In the above example changing from QPSK 3/4 to QPSK 1/2 helps reduce the power but requires additional 1.5 times more bandwidth. The 1.2 dB Eb/No difference between rate 3/4 and 1/2 reduces the CnC ratio at the hub.

D.9 3rd CnC Example: Asymmetric Link With Rain Fade

A reasonable question to ask about the previous example is the impact rain fade has on the link. This example combines parts of the previous two examples using the same symbol rates and asymmetric antennas and adds in fade at Site A, with the larger antenna and examines the CnC ratio at both sites. The impact on both sites is also estimated due to a fade at Site B. Just as in the earlier example, the larger fade (6 dB up and 4 dB down) occurs at Site A (hub), and the smaller fade (3 dB up and 2 dB down) is allocated to Site B (remote).

Treating the fades in this way is convenient as a first order approximation, but other factors influence performance such as noise increase and G/T degradation at the receive site.

From the previous examples there are some characteristics worth summarizing:

At the same symbol rate with the same modulation and code rate:

- The CnC ratio is highest at the site with the larger antenna (Site A)
- The CnC ratio for the site with the smaller antenna (Site B) is the same magnitude but opposite sign: $CnC(\text{site B}) = -CnC(\text{Site A})$.

For rain fade:

- The CnC ratio changes by the same amount as the uplink fade
- Uplink fades at the near end decrease the CnC ratio
- Uplink fades at the far end increase the CnC ratio.

The tables below summarize the Eb/No degradation at Site A when a fade is introduced first at Site A and then at Site B. Next, the degradation at Site B is evaluated when a fade appears at Site B and then at Site A. For this asymmetric case, the estimated CnC degradation is 0.1 dB despite the significant fade.

Eb/No Degradation For Asymmetric 4.5-Meter Antenna At A and 2.4 Meter Antenna At B

Eb/No Degradation At Site A		
Parameter	Due To Fade At A (dB)	Due To Fade At B (dB)
CnC Ratio @ Site A	+5.3	+5.3
Uplink Fade @ Site A	6	-
Uplink Fade @ Site B	-	3
Faded CnC @ Site A	-0.7	+8.3
Eb/No Degradation (dB) @ Site A Per Figure D- QPSK	0.0	-0.1

Eb/No Degradation At Site B		
Parameter	Due To Fade At B (dB)	Due To Fade At A (dB)
CnC Ratio @ Site B	-5.3	-5.3
Uplink Fade @ Site B	3	-
Uplink Fade @ Site A	-	6
Faded CnC @ Site B	-8.3	+0.7
Eb/No Degradation (dB) @ Site B Per Figure D- QPSK	0.0	-0.1

D.10 Conclusion

There are several conclusions for operation with CnC:

- Operate adjacent carriers with sufficient spacing so there is no degradation.
- Adjust the modulation and code rate to alter the CnC ratio
- Change the modulation and code rate to scale the symbol rate
- Maximum CnC ratio is 7 dB with plenty of margin
- Maximum CnC ratio is 10 dB with some degradation
- Eb/No degradation is relatively tolerant to fades
- QPSK is least sensitive to adjacent carrier and CnC ratio followed by 8-PSK then 16-QAM.

Metric Conversions

Units of Length

Unit	Centimeter	Inch	Foot	Yard	Mile	Meter	Kilometer	Millimeter
1 centimeter	—	0.3937	0.03281	0.01094	6.214×10^{-6}	0.01	—	—
1 inch	2.540	—	0.08333	0.2778	1.578×10^{-5}	0.254	—	25.4
1 foot	30.480	12.0	—	0.3333	1.893×10^{-4}	0.3048	—	—
1 yard	91.44	36.0	3.0	—	5.679×10^{-4}	0.9144	—	—
1 meter	100.0	39.37	3.281	1.094	6.214×10^{-4}	—	—	—
1 mile	1.609×10^5	6.336×10^4	5.280×10^3	1.760×10^3	—	1.609×10^3	1.609	—
1 mm	—	0.03937	—	—	—	—	—	—
1 kilometer	—	—	—	—	0.621	—	—	—

Temperature Conversions

Unit	° Fahrenheit	° Centigrade
32° Fahrenheit	—	0 (water freezes)
212° Fahrenheit	—	100 (water boils)
-459.6° Fahrenheit	—	273.1 (absolute 0)

Formulas
$C = (F - 32) * 0.555$
$F = (C * 1.8) + 32$

Units of Weight

Unit	Gram	Ounce Avoirdupois	Ounce Troy	Pound Avoir.	Pound Troy	Kilogram
1 gram	—	0.03527	0.03215	0.002205	0.002679	0.001
1 oz. avoir.	28.35	—	0.9115	0.0625	0.07595	0.02835
1 oz. troy	31.10	1.097	—	0.06857	0.08333	0.03110
1 lb. avoir.	453.6	16.0	14.58	—	1.215	0.4536
1 lb. Troy	373.2	13.17	12.0	0.8229	—	0.3732
1 kilogram	1.0×10^3	35.27	32.15	2.205	2.679	—



2114 WEST 7TH STREET TEMPE ARIZONA 85281 USA
480 • 333 • 2200 PHONE
480 • 333 • 2161 FAX