

# User Manual

## Expedio

### D-ENG LINK

---



Doc. 602-13729-01

October 21, 2002

---

**Expedio Manual Dwg # 602-13729-01; Revision Levels:**

<b>Section</b>	<b>Drawing No:</b>	<b>REV</b>	<b>Revised / Released</b>	<b>Reason</b>
Expedio-20	602-13729-01	A	SN /10/21/02	NEW
Expedio-20	602-13729-01	B	SN /12/03/02	Add FCC Requirements see 3.2.4
		C		Modified Front Panel description
Antenna/ Feed System		D	LL /2/5/03	Revised typo from 61.1 Bmi to 61.1 dBmi

# Table of Contents

<b>1</b>	<b>SYSTEM DESCRIPTION.....</b>	<b>1-1</b>
1.1	INTRODUCTION.....	1-1
1.2	SYSTEM FEATURES.....	1-2
1.2.1	Transmit Chain.....	1-2
1.2.2	Receive Chain.....	1-2
1.2.3	Video Encoder.....	1-3
1.3	TYPICAL CONFIGURATIONS.....	1-4
1.3.1	Transport Rate.....	1-4
1.3.2	Standalone Operation.....	1-5
1.4	REGULATORY NOTICES.....	1-5
1.5	SYSTEM DESCRIPTION.....	1-5
1.5.1	Introduction.....	1-5
1.5.2	COFDM Modulator / IF Upconverter.....	1-7
1.5.3	RF Double Upconverter.....	1-9
1.5.4	Power Amplifier (PA).....	1-9
1.5.5	RF First Downconverter.....	1-10
1.5.6	COFDM Demodulator & UHF Downconverter.....	1-11
<b>2</b>	<b>STATUS MONITOR PROGRAM.....</b>	<b>2-1</b>
2.1	DESCRIPTION.....	2-1
2.2	SOFTWARE INSTALLATION.....	2-1
2.3	USING THE STATUS MONITOR PROGRAM.....	2-2
2.3.1	Start/Stop Status Check.....	2-2
2.3.2	Expedio Unit Data.....	2-3
2.3.3	Error Statistics.....	2-4
2.4	COMMUNICATIONS SETTINGS.....	2-5
2.5	MPEG/COFDM CONFIGURATIONS.....	2-5
2.5.1	Switching Configurations.....	2-5
2.5.2	Default MPEG/COFDM Configuration Settings.....	2-6
<b>3</b>	<b>INSTALLATION.....</b>	<b>3-1</b>
3.1	UNPACKING.....	3-1
3.2	NOTICES.....	3-1
3.2.1	CAUTION.....	3-1
3.2.2	WARNING.....	3-1
3.2.3	PRE-INSTALLATION NOTES.....	3-2
3.2.4	Information to Users.....	3-2
3.3	RACK MOUNT.....	3-2
3.4	REAR PANEL CONNECTIONS & INDICATORS.....	3-2
3.5	POWER REQUIREMENTS.....	3-5
3.5.1	Power Supply Card Slot Details.....	3-5
3.5.2	AC Line Voltage.....	3-5
3.5.3	DC Input Option.....	3-6
3.5.4	Fusing.....	3-6
3.6	DATA INTERFACE.....	3-6
3.7	SITE INSTALLATION.....	3-6
3.8	ANTENNA/FEED SYSTEM.....	3-7
3.8.1	Antenna Installation.....	3-7
<b>4</b>	<b>FRONT PANEL OPERATION.....</b>	<b>4-1</b>
4.1	INTRODUCTION.....	4-1

---

4.2 FRONT PANEL OPERATION .....	4-1
4.2.1 LCD Display .....	4-1
4.2.2 Cursor and Screen Control Buttons .....	4-2
4.2.3 LED Status Indicators .....	4-3
4.2.4 Screen Menu Tree Structure.....	4-3
4.3 MAIN MENU .....	4-4
4.3.1 Radio Launch .....	4-4

# 1 System Description

## 1.1 Introduction

The digital system comprises of a Transmitter and a Receiver, whose output RF frequency is in the Band 1.9GHz to 2.9GHz. The RF band is approximately 300MHz.

Transmitter is comprised of a MPEG2 Video Encoder which will take composite Video and digitize this and compressed, the output transport stream [DVB-TS] is then converted to DVB-ASI, which is then Modulated with COFDM (or any other digital modulators). The COFDM modulator is compliant to DVB-T non-hierarchical modes. This modulated signal is then converted to the appropriate with an IF of 480MHz thus providing the means to tune over a band at the RF signal.

Receiver will down convert from the RF signal to an IF of 480MHz. This IF is then demodulated providing a DVB-TS. This data stream is then MPEG2 Video Decoded and provided as analogue Video output, together with the Audio channels.

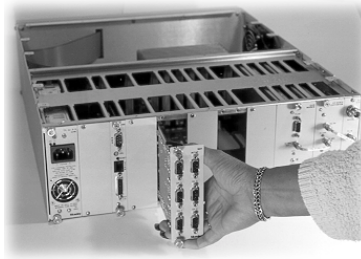

**Figure 1: Expedio Modular Open Architecture**

## 1.2 System Features

### 1.2.1 Transmit Chain

The Block diagram below shows the various functional units that make up the transmitter.

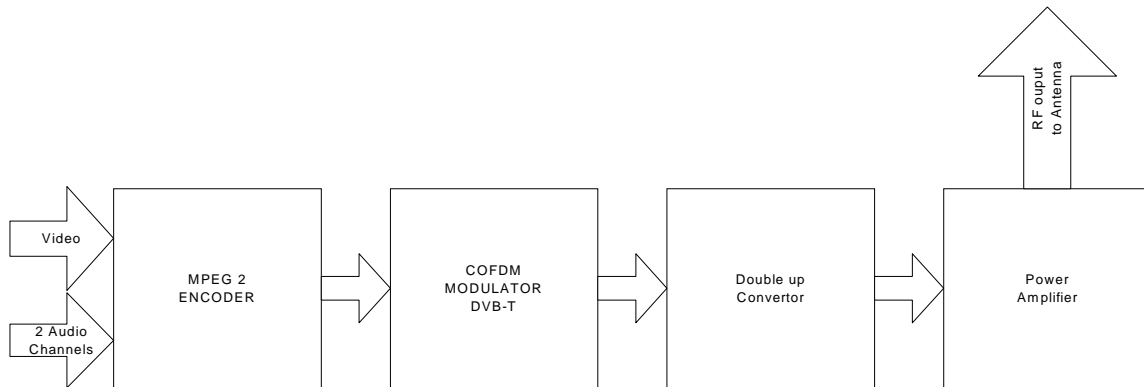

Figure 2: Transmit Chain

### 1.2.2 Receive Chain

The Block diagram below shows the various functional units that make up the Receiver.

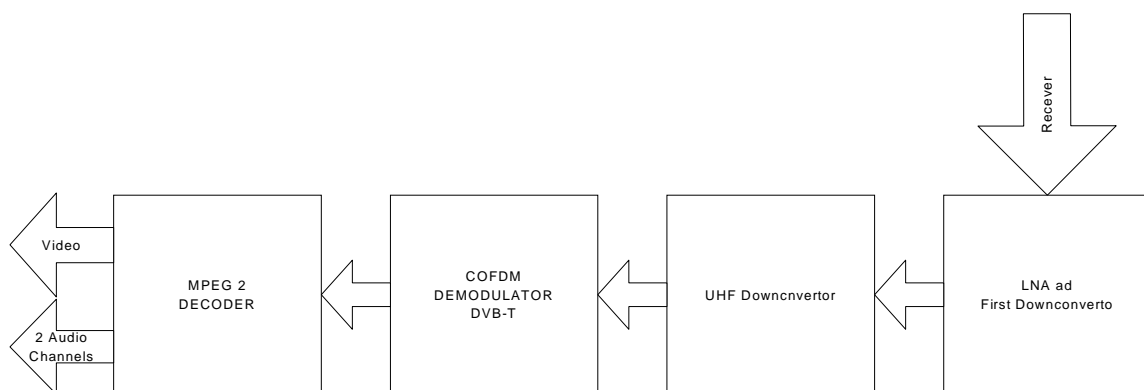

Figure 3: Receive Chain

### 1.2.3 Video Encoder

Video input is Composite video at 75ohms BNC, with a monitor port available.

There are 2 Audio channels whose input are through the XLR connections.

The data is encoded using advanced MPEG-2 encoding technology. The compressed data is formatted and transmitted using the DVB-ASI standard. The unit compresses the incoming video using an adaptive field/frame MPEG-2 Main Profile @ Main Level algorithm, achieving variable bit rate of 512 Kbps-12 Mbps.

c) The Data Output that is DVB-SPI shall be converted to DVB-ASI with the data to be 188 byte only, the COFDM modulator will insert the Reed Solomon Encoding frames.

<b>Standard Compliance</b>	
Video Encoding	ISO/IEC 13818-2 (MPEG-2), 4:2:0 MP@ML, and MP@LL
System Multiplexing	ISO/IEC 13818-1 (MPEG-2).
<b>Generated Stream Types</b>	
Video ES	Video Elementary Stream.
Audio ES	Packetized Audio Elementary Stream.
Video PES	Packetized Video Elementary Stream.
Program	Program Stream.
Transport	Transport Stream.
<b>Video Encoder</b>	
Video Input Format	<b>Analog:</b> Composite NTSC (30 fps), Composite PAL(25 fps)
Video Input Bit Resolution	9 bits.
Preprocessor	Programmable 2D (7x6) filter. Temporal and Spatial noise reduction.
Bit Rates	CBR and VBR, 512 Kbps to 12 Mbps.
Bit Rate Resolution	1000 Hz
Variable Frame Rate	Programmable frame rate decimation (1 fps through 30/25 fps) support for low bit rate applications.
Programmable Picture Resolution	<b>Horizontal:</b> 720, 640, 544, 480, 360, 320, 160 <b>Vertical:</b> 112, 240, 480 (NTSC) 144, 288, 576 (PAL)
Motion Estimation	Horizontal: +/-100 H, Vertical: +/-34V. Same search area in P and B pictures, in both forward and backward searches. Half PEL accuracy.
Aspect Ratio	Square, 4:3, 16:9
Picture type	I, P, B frame processing.
GOP Structure	I(M=0), IP(M=1), IPB(M=2), IPBB(M=3)

<b>Audio Input</b>	
Audio Input Format	Two mono or single analog stereo inputs - Balanced
<b>Output Interfaces</b>	
Digital Interface	DVB-ASI

## 1.3 Typical Configurations

### 1.3.1 Transport Rate

Table 1-1 provides basic data channel capabilities for the Expedio. See (Installation Section) for more detailed information.

**Table 1-1. Expedio Data Channel Configurations**

A

8 MHz DVB-T COFDM Payload Data Rate

Modulation Type	Code Rate	Bit Rate (Mbit/s @ each Guard Interval)			
		1/32	1/16	1/8	1/4
A	1/2	6.032086	5.854671	5.529412	4.976471
QPSK	2/3	8.042781	7.806228	7.372549	6.635294
2	3/4	9.048128	8.782007	8.294118	7.464706
Bits/Sym	5/6	10.053476	9.757785	9.215686	8.294118
A	7/8	10.556150	10.245675	9.676471	8.708824

A	1/2	12.064171	11.709343	11.058824	9.952941
16-QAM	2/3	16.085561	15.612457	14.745098	13.270588
4	3/4	18.096257	17.564014	16.588235	14.929412
Bits/Sym	5/6	20.106952	19.515571	18.431373	16.588235
A	7/8	21.112299	20.491349	19.352941	17.417647



### **1.3.2 Standalone Operation**

The Expedio may be used as a standalone simplex radio with a internal in the MPEG2 Encoder / Decoder system or utilize external MPEG2 units and feed DVB-ASI with 188byte format on the Input and have DVB-ASI out coming out on the Receiver.

## **1.4 Regulatory Notices**

### **FCC Part 15 Notice**

This equipment has been tested and found to comply with the limits for a Class A digital device, pursuant to part 15 of the FCC Rules. These limits are designed to provide reasonable protection against harmful interference when the equipment is operated in a commercial environment. This equipment generates, uses, and can radiate radio frequency energy and, if not installed and used in accordance with the instruction manual, may cause harmful interference to radio communications. Operation of this equipment in a residential area is likely to cause harmful interference, in which case the user will be required to correct the interference at his expense. Any external data or audio connection to this equipment must use shielded cables.

### **EC Declaration of Conformity**

## **1.5 System Description**

### **1.5.1 Introduction**

The product is a simplex digital radio. The following sections describe the TX system, RX system, followed by sub-system components. Please reference the accompanying block diagrams for clarification.

We will follow the typical end-to-end progression of a radio system starting with the TX baseband inputs, to the COFDM modulator, followed by the upconversion process and the power amplifier. We then proceed to the RX preamplifier input, the down conversion process, followed by the COFDM demodulator and baseband outputs.

# Expedio Transmitter

Starlink/NXE1  
Chassis

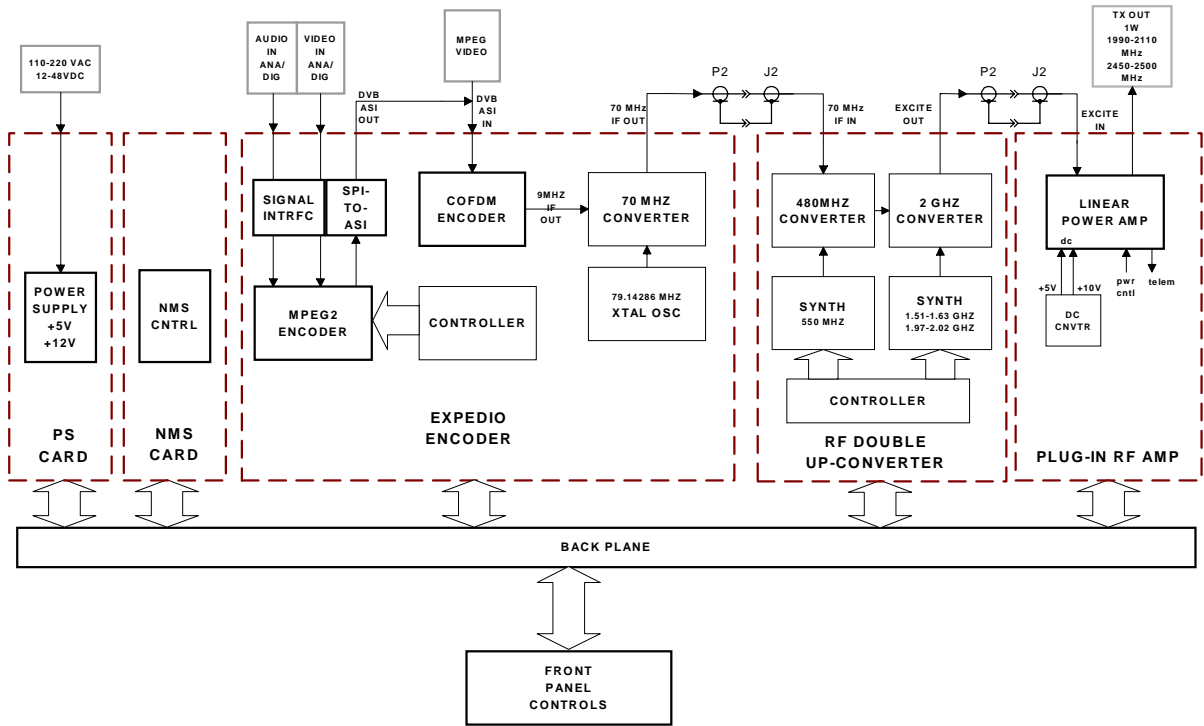

**Figure 4: Expedio Transmit System Block Diagram**

All modules (excluding the Front Panel and Power Amplifier) are interconnected via the backplane that traverses the entire width of the unit. The backplane contains the various communication buses as well as the PA (Power Amplifier) control and redundant transfer circuitry. See Figure 5 below for locations of the Backplane and the Power Amplifier. The power supply levels and status are monitored on the backplane and the NMS/CPU card processes the data.

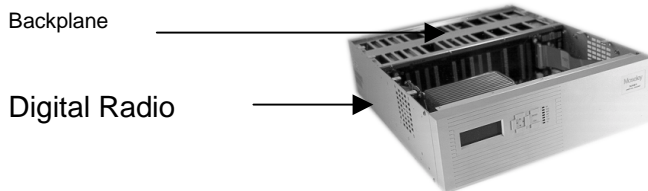
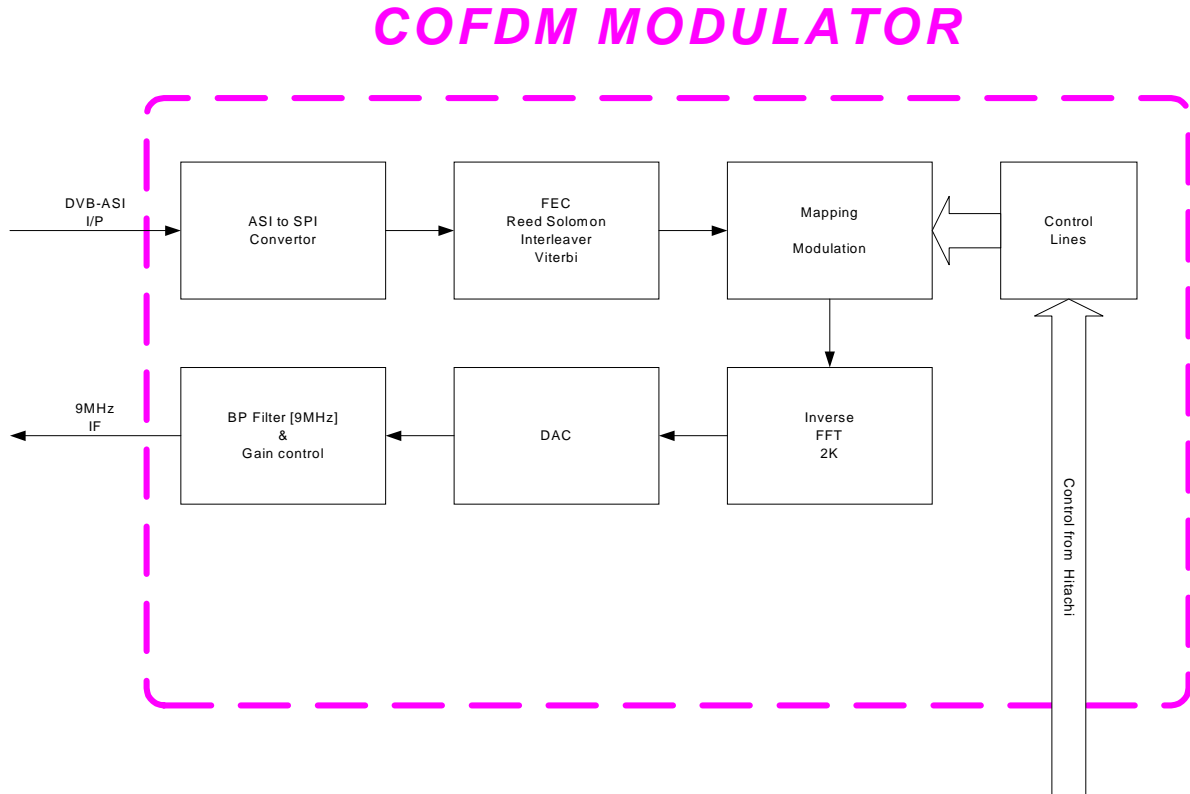

**Figure 5: Location of the EXPEDIO Backplane and Power Amplifier**

The NMS/CPU card incorporates microprocessor and FPGA logic to configure and monitor the overall operation of the system via front panel controls, LCD screen menus, status LEDs and the bar graph display. Module settings are loaded into the installed cards and power-up default settings are stored in non-volatile memory. LCD screen menu software is uploaded into memory,

providing field upgrade capability. A Windows-based PC interface is available for connection at the rear panel DATA port.

## 1.5.2 COFDM Modulator / IF Upconverter

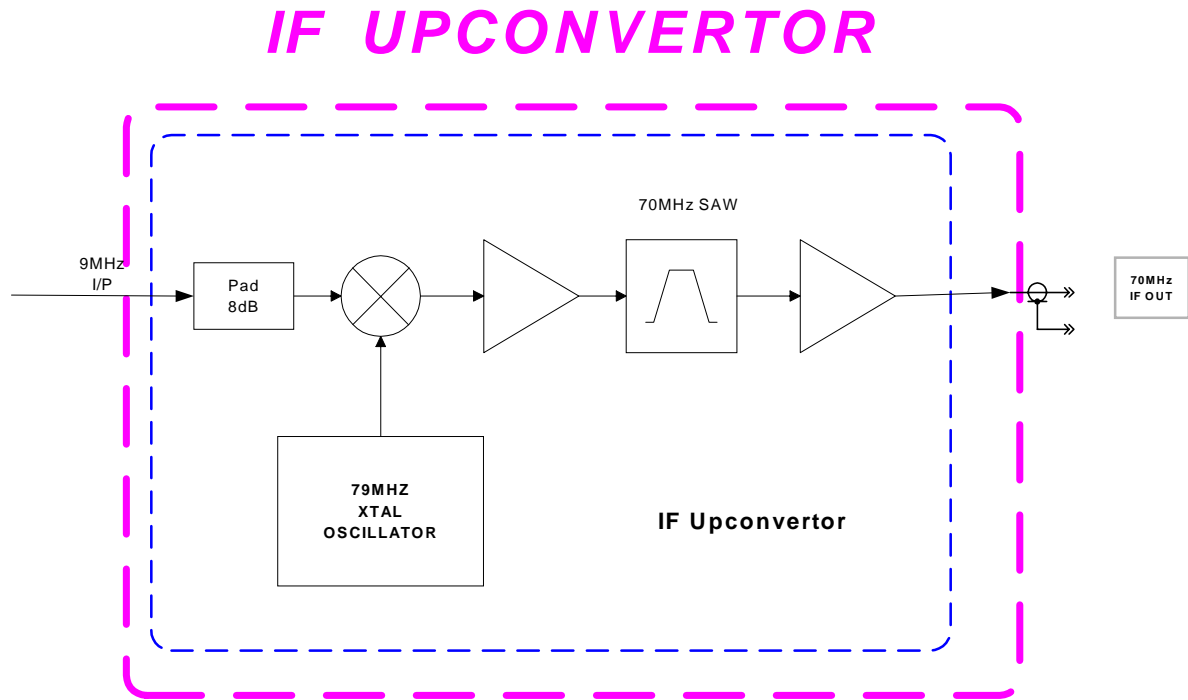

**Figure 6: COFDM Block Diagram**

The COFDM (Coded Orthogonal Frequency Division Multiplex) Modulator is the transmit portion of the card. The unit also houses the IF Upconverter.

The COFDM Modulator accepts the aggregate data stream via the DVB-ASI Port on the rear panel (see Figure 6 above).

The modulated signal is provided via low IF of 9MHz which is converted -----

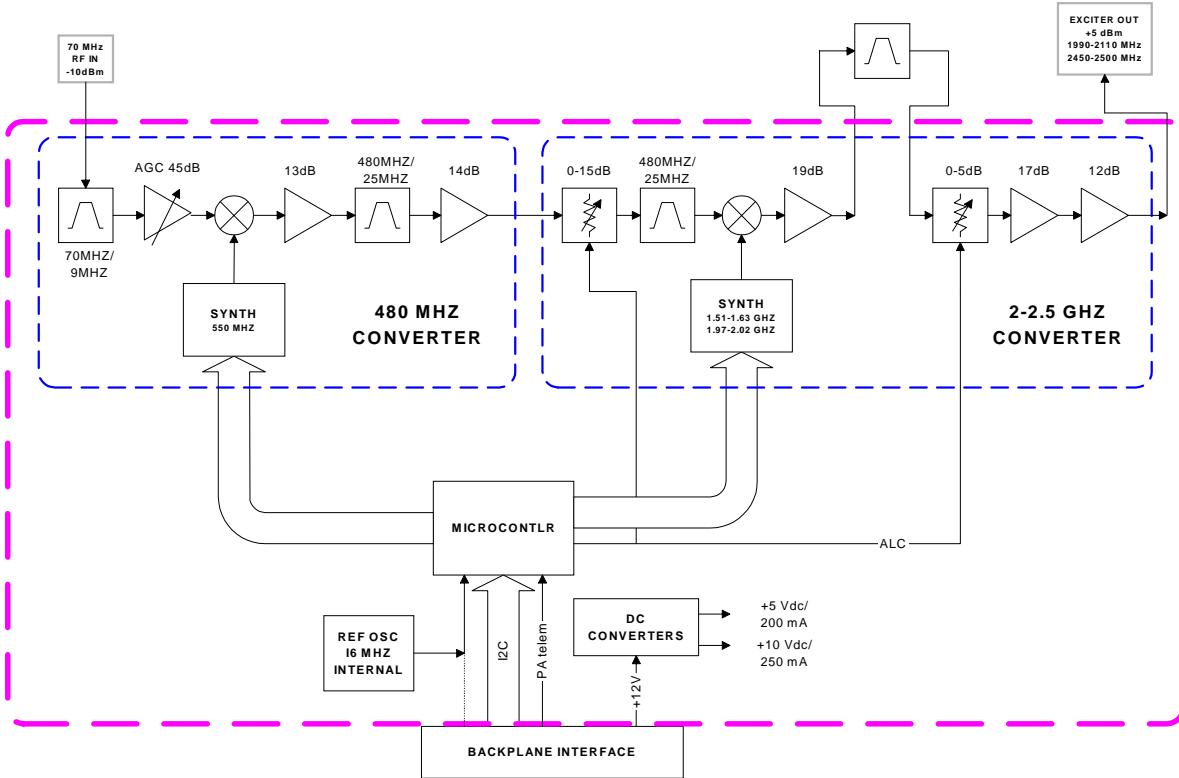

**Figure 7: IF Upconverter Block Diagram**

The resultant carrier is translated up to 70 MHz by the IF Upconverter. This is accomplished by a standard mixing of the carrier with a phase-locked LO. A 70 MHz SAW filter provides an exceptional, spectrally clean output signal.

### 1.5.3 RF Double Upconverter

## Expedio Double Up-Converter



**Figure 8: RF Upconverter Block Diagram**

The IF output carrier of the IF Upconverter daughter card is fed to the transmit portion of the RF Module via an external (rear panel) semi-rigid SMA cable. This module performs the necessary upconversion to the RF carrier. There is an on-board CPU for independent control of the critical RF parameters of the system.

Since this is a linear RF processing chain, an automatic leveling control loop (ALC) is implemented here to maintain maximum available power output (and therefore maximum system gain). The ALC monitors the PA forward power (FWD) output sample, and controls the up converter gain per an algorithm programmed in the CPU. The ALC also controls the power-up RF conditions of the transmitter output.

### 1.5.4 Power Amplifier (PA)

The Power Amplifier (PA) is a separate module that is mounted to a heat sink and is fan-cooled for reliable operation. The PA is a design for maximum linearity in an amplitude modulation-based system.

1.5.5 RF First Downconverter

# Single Down-Converter

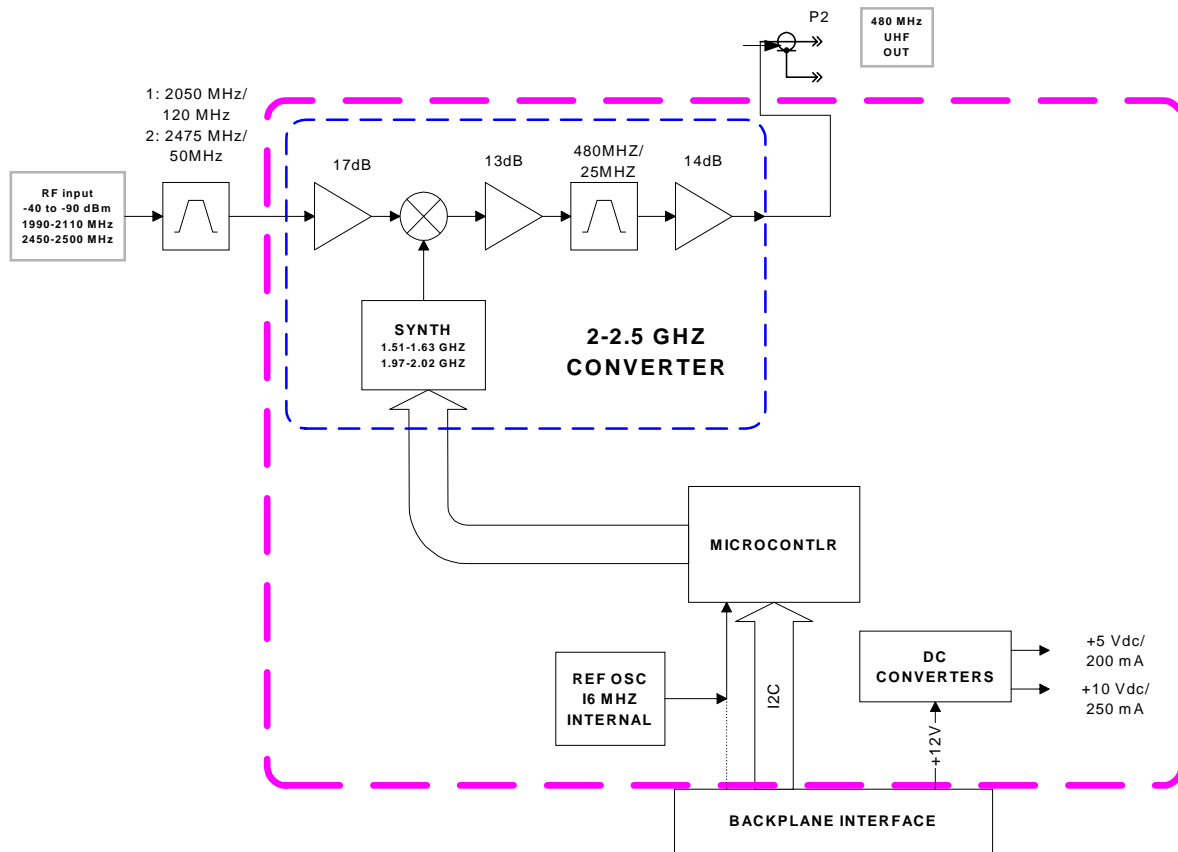
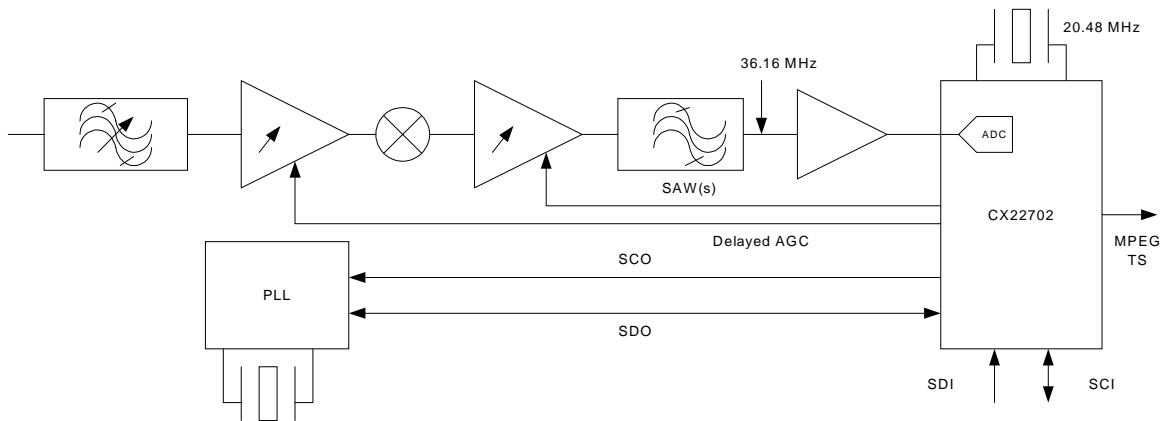

Figure 9: RF Downconverter Block Diagram

The receiver handles the traditional RF to UHF conversion from the carrier to 480 MHz. Considerations are given to image rejection, intermodulation performance, dynamic range, agility, and survivability. A separate AGC loop was assigned to the RF front end to prevent intermodulation and saturation problems associated with reception of high level undesirable interfering RF signals resulting from RF bandwidth that is much wider than the IF bandwidth.

### 1.5.6 COFDM Demodulator & UHF Downconverter



**Figure 10: UHF Downconverter Block Diagram**

This Module receives a UHF COFDM signal and demodulates them using the DVB-T specifications, and outputs an MPEG2 Transport stream (TTL compatible) for use to decode the Video stream out of that.

This page is intentionally blank.



# 2 Status Monitor Program

## 2.1 Description

The Expedio Status Monitor Program is an application that allows you to monitor the status of the Expedio unit from any Windows-based PC.

## 2.2 Software Installation

1. **Power OFF** the Expedio unit and the PC.
2. Connect the serial cable (RS-232) from the PC to the Expedio unit.
3. Turn the Expedio power **ON**, and then turn the PC power **ON**.
4. Run the Expedio Self-Extracting Executable from the Expedio CD.

To launch Expedio, double click the Expedio icon on your PC desktop. The first time you run the Expedio Status Monitor Program, the Communications Settings window appears.

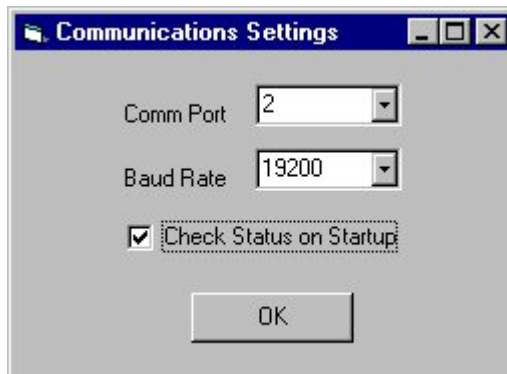

To begin communicating with the Expedio unit, the Communications Settings must be properly configured.

- In the **Comm Port** field, select the Comm Port to which the Serial Cable to the Expedio unit is connected.
- In the **Baud Rate** field, select the Baud Rate as configured on the Expedio unit. For more information about configuring the baud rate, see the section of this manual regarding hardware setup.
- **Optional: Check Status on Startup** automatically causes the Status Monitor Program to begin monitoring the Expedio unit each time the program is launched.

Click **OK** to accept these communication settings.

## 2.3 Using the Status Monitor Program

### 2.3.1 Start/Stop Status Check

Status Checking can be started in either of two methods:

- **Automatically:** Select **Check Status on Startup** in the Communication Settings. With this selection, every time program is launched, it first reads the current settings from the Expedio unit, then starts status checking.
- Manually, by

Upon launching the Status Monitor Program, the main screen appears, as pictured below. (Note that in the example below, the Status Monitor is not currently communicating with the Expedio unit, thus there are no or zero values in some of the fields.)

The screenshot shows the 'Expedio - Untitled' application window. At the top, there is a menu bar with 'File' and 'Setup'. Below the menu bar are four buttons: 'Read from Board', 'Switch Config', 'Start Status Check', and 'Stop Status Check'. The 'Start Status Check' button is highlighted. Below the buttons, there is a 'Configuration Number' field with the value '1' and the text 'Expedio v.1.5.0' on the right. The main area is titled 'Status' and contains several fields: 'Decoder' and 'PVR' (both with checkboxes), 'CPU Ver.', 'FPGA Ver.', 'Error Statistics:' (a sub-section header), 'Time' (00:00:10), 'TPS' (checkbox), 'Total TPS' (0), 'RS Errors' (0), 'BER' (0.00E+00), 'Signal Strength' (0), and 'MER' (0). At the bottom of the main area is a 'Reset Totals' button.

**To begin monitoring the status of the Expedio unit, click Start Status Check.** A progress bar appears, indicating that the PC is attempting to connect to the Expedio unit. The amount of

time required to make a connection and retrieve data depends upon factors such as the speed of the connection and the quantity of data.

Once the connection is made, **Expedio continues to send data until you click Stop Status Check.**

The Status area of the screen displays information that received from the Expedio unit. During monitoring, the Error Statistics continue to update anytime a change occurs on the Expedio unit itself.

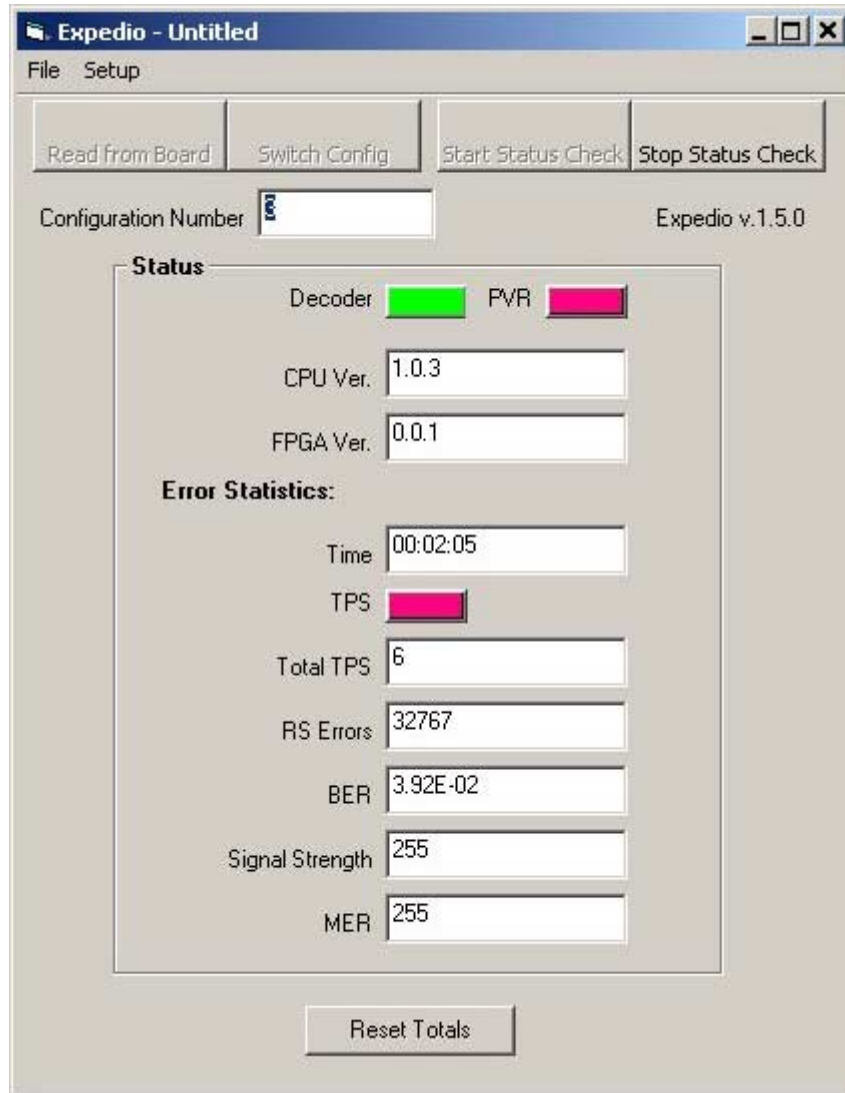

The communication link between the PC and the Expedio unit processes only one command at a time; therefore, other features that involve communicating with the Expedio unit cannot be performed while Status Checking is started.

### 2.3.2 Expedio Unit Data

The upper portion of the Status area displays information about the unit. Except for PVR, this information is static, that is, it will not change while you are monitoring the unit.

<b>Decoder</b>	Indicates the operating mode of the unit: GREEN = decoder RED = encoder NO COLOR (background) = Unknown
<b>PVR</b>	Indicates the PVR status: GREEN = Valid RED = Invalid NO COLOR (background) = Unknown, only occurs before status is obtained or during reset.
<b>CPU Version</b>	The version of firmware.
<b>FPGA Version</b>	The version number of the unit's operating system.

Updates to the CPU Version or the FPGA Version can only be performed under the guidance of Moseley Technical Support.

**Read from Board** returns status information (excluding PVR) without starting Status Check.

### 2.3.3 Error Statistics

The lower portion of the Status area displays Error Statistics. This is live data that the system updates as changes occur on the unit. The represented values include:

- **Time** Gives the elapsed time since Status Checking started.
- **TPS** GREEN = Valid  
RED = Invalid  
NO COLOR (background) = Unknown
- **Total TPS** Number of invalid TPS checks since Status Checking started.
- **RS Errors**
- **BER**
- **Signal Strength**
- **MER**

The **Reset Totals** button returns a field values to zero. The system then updates the fields with the current values.

## 2.4 Communications Settings

To begin communicating with the Expedio unit, the Communications Settings must be properly configured.

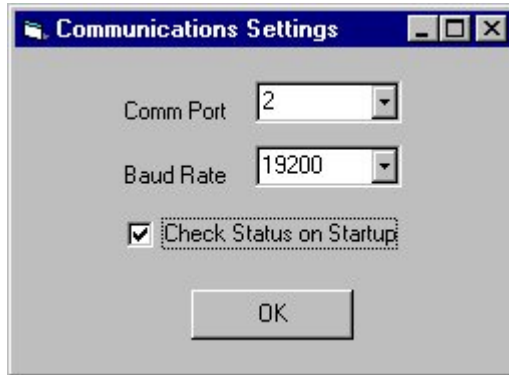

- In the **Comm Port** field, select the Comm Port to which the Serial Cable to the Expedio unit is connected.
- In the **Baud Rate** field, select the Baud Rate as configured on the Expedio unit. For more information about configuring the baud rate, see the section of this manual regarding hardware setup.
- **Optional: Check Status on Startup** automatically causes the Status Monitor Program to begin monitoring the Expedio unit each time the program is launched.

Click **OK** to accept these communication settings.

---

**Note:** The Communications Settings cannot be changed while Status Checking is started. To change Communications Setting, ensure that Status Checking is stopped.

---

## 2.5 MPEG/COFDM Configurations

The behavior of the Expedio unit depends on its MPEG Configuration. The appropriate configuration depends upon the system itself, so Expedio comes equipped with three preinstalled configurations to choose from. Any of these can serve as the *default configuration*, which is the configuration that the Expedio will run whenever it is started or reset.

With administrative privileges, it is possible to modify the three preinstalled configurations. This can only be done with the assistance of Moseley Technical Support personnel.

### 2.5.1 Switching Configurations

1. In the Configuration Number field, enter the number of the desired configuration. For a complete description of the factory installed configurations, see Default MPEG Configuration Settings.
2. Click **Switch Config**.
3. A confirmation screen appears. If you are sure you want to change configurations, click **OK**.

The progress bar appears, indicating that the change is in process.

## 2.5.2 Default MPEG/COFDM Configuration Settings

The following table describes the factory-installed configurations.

	Configuration Number		
MPEG Settings	1	2	3
Video Rate (Mbits)			
Video Resolution			
Audio Rate			
Compression			
Aspect Ratio			
Audio Format			
GOP			
GOP N			
Copy			
Video PID			
Audio PID			
COFDM Settings	1	2	3
Modulation			
Code Rate			
Guard Interval			

# 3 Installation

## 3.1 Unpacking

The following is a list of all included items.

Description	Quantity
Digital Radio (3RU chassis)	1
Rack Ears (with hardware)	2
Power Cord (IEC 3 conductor for AC, 2-wire for DC)	2
Manual (or Soft copy on a CD)	1
Test Data Sheet (customer documentation)	1

Be sure to retain the original boxes and packing material in case of return shipping. Inspect all items for damage and/or loose parts. Contact the shipping company immediately if anything appears damaged. If any of the listed parts are missing, call the distributor or the factory immediately to resolve the problem.

## 3.2 Notices

### 3.2.1 CAUTION

---

*DO NOT OPERATE UNITS WITHOUT AN ANTENNA, ATTENUATOR, OR LOAD CONNECTED TO THE ANTENNA PORT. DAMAGE MAY OCCUR TO THE TRANSMITTER DUE TO EXCESSIVE REFLECTED RF ENERGY.*

*ALWAYS ATTENUATE THE SIGNAL INTO THE RECEIVER ANTENNA PORT TO LESS THAN 3000 MICROVOLTS. THIS WILL PREVENT OVERLOAD AND POSSIBLE DAMAGE TO THE RECEIVER MODULE*

---

### 3.2.2 WARNING

---

**HIGH VOLTAGE IS PRESENT INSIDE THE POWER SUPPLY MODULE WHEN THE UNIT IS PLUGGED IN. REMOVAL OF THE POWER SUPPLY CAGE WILL EXPOSE THIS POTENTIAL TO SERVICE PERSONNEL. TO PREVENT ELECTRICAL SHOCK, UNPLUG THE POWER CABLE BEFORE SERVICING. QUALIFIED PERSONNEL SHOULD SERVICE UNIT ONLY.**

---

### 3.2.3 PRE-INSTALLATION NOTES

Always pre-test the system on the bench in its intended configuration prior to installation at a remote site. Avoid cable interconnection length in excess of 1 meter in strong RF environments. We highly recommend installation of lightning protectors to prevent line surges from damaging expensive components.

### 3.2.4 Information to Users

Changes or Modifications expressly not approved by Moseley Associates as this would render the compliance of the equipment to be invalid. This would also render the user to operate the equipment.

## 3.3 Rack Mount

The product is normally rack-mounted in a standard 19" cabinet. Leave space clear above (or below) the unit for proper air ventilation of the card cage. The rack ears are typically mounted as shown in Figure 11. Other mounting methods are possible by changing the orientation of the rack ears.

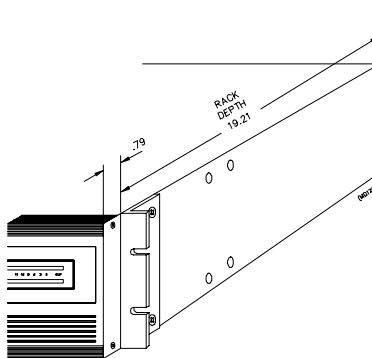

Figure 11: Expedito Typical Rack Mount Bracket Installation

## 3.4 Rear Panel Connections & Indicators

Please refer to the Figure 12 and 13 for a pictorial of a typical product rear panel (internal duplexer). Following is a descriptive text of the connections and LED indicators.



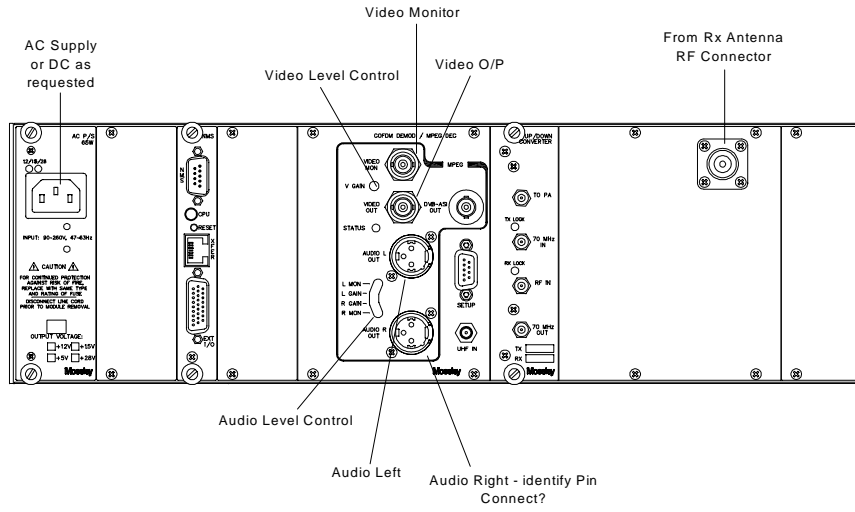

Figure 12: Expedio-20 Rear Panel Receiver Connections

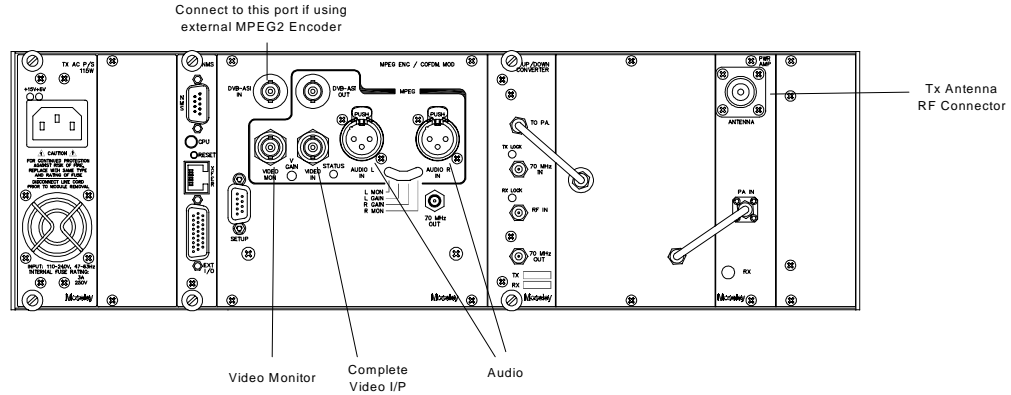

Figure 13: Expedio-20 Rear Panel Transmitter Connections

**Power Supply:**

<b>Inputs:</b>	AC:	Universal Input, 100-240V, 50/60 Hz; IEC 3 conductor
	DC:	24v/48v (Isolated Input); 2 pin socket (custom)
<b>Status LED:</b>	+12V:	Green LED indicates +12 volt supply OK
	+5V:	Green LED indicates +5 volt supply OK

**NMS Card**

<b>I/O Port:</b>	RS232 PC access; 9 pin D-sub (female)
<b>Reset Switch:</b>	Activates hard system reset
<b>Status LED:</b>	Green LED Indicates CPU OK

**Converter Module**

<b>RF Connectors:</b>	TO PA:	SMA (female), Upconverter output to be applied to linear Power Amplifier module (internal to radio).
	70 MHz IN:	SMA (female), Modulated IF input from QAM Modulator.
	RF IN:	SMA (female), Receiver input.
	70 MHz OUT:	SMA (female); Downconverter output to Modulator input
<b>Status LED:</b>	RX LOCK:	GREEN indicates RX AFC LOCK Flashing RED indicates LOSS OF RX LOCK
	RX LOCK:	GREEN indicates RX AFC LOCK and strong RX signal YELLOW indicates RX AFC LOCK and nominal RX signal RED (continuous) indicates RX AFC LOCK and weak RX signal RED (flashing) indicates LOSS OF RX LOCK

**RF I/O Panel**

<b>RF Connectors:</b>	ANTENNA:	Type N (female), RF cabling from internal PA module.
	PA IN:	SMA (female), RF cabling to internal PA module.
	RX OUT:	SMA (female), RF cabling from internal duplexer.

**SEMI-RIGID CABLE**

Ensure that the cables are secure and tightly attached.

Check for any damage (kinks or breaks in the copper sheath).

## 3.5 Power Requirements

### 3.5.1 Power Supply Card Slot Details

The leftmost slot in the Expedio card cage (as viewed from the rear of the unit) is designated as the "PRIMARY A" power supply. The main bus voltages (+5 and +/-12) are summed in the backplane and provide the supply the plug-in modules.

---

**NOTE:** The front panel LCD screen displays the system supply voltages and the nomenclature follows the physical location of the power supply modules.

---

### 3.5.2 AC Line Voltage

The Expedio uses a high reliability, universal input switching power supply capable of operation within an input range of:

100 - 240 VAC; 50/60 Hz

The power supply module is removable from the unit and a perforated cage protects service personnel from high voltage. The power supply is fan cooled due to high power consumption by the PA.

**CAUTION**

---

High voltage is present when the unit is plugged in. To prevent electrical shock, unplug the power cable before servicing. Qualified personnel should service power supply module only.

---

### 3.5.3 DC Input Option

An optional DC input power supply is available for the EXPEDIO; using high reliability, DC-DC converter(s) capable of operation within the following input ranges (dependent upon nominal input rating):

Nominal DC Input	Operating Input Range
24 Volt:	20 – 28 VDC
48 Volt:	32 – 64 VDC

The DC input is isolated from chassis ground and can be operated in a positive or negative ground configuration. The power supply module is removable from the unit and no high voltages are accessible.

### 3.5.4 Fusing

For AC modules, the main input fuse is located on the switching power supply mounted to the carrier PC board and the protective cage may be removed for access to the fuse.

For DC modules, all fusing is located on the carrier PC board.

Always replace any fuse with same type and rating. Other fuses are present on the board, and are designed for output fail-safe protection of the system. All output fuse values are printed on the backside of the PC board to aid in replacement.

---

NOTE: If a fuse does blow in operation, investigate the possible cause of the failure prior to replacing the fuse, as there is adequate built-in protection margin.

---

## 3.6 Data Interface

DVB ASI is the data interfaces into the transmitter modulator.

## 3.7 Site Installation

The installation of the EXPEDIO involves several considerations. A proper installation is usually preceded by a pre-installation site survey of the facilities. The purpose of this survey is to familiarize the customer with the basic requirements needed for the installation to go smoothly. The following are some considerations to be addressed.

Before taking the product to the installation site verify that the interface connections are compatible with the equipment to be connected. Also, locate the information provided by the path analysis that should have been performed before ordering the equipment. At the installation site, particular care should be taken in locating the product in an area where it is protected from the weather and as close to the antenna as possible. Locate the power source and verify that it is suitable for proper installation.

**Only qualified technical personnel should perform the installations.**

## 3.8 Antenna/Feed System

### 3.8.1 Antenna Installation

**For compliance with FCC RF Exposure requirements the following has to be adhered to:**

1. All antenna installation and servicing is to be performed by qualified technical personnel only. When servicing the antenna, or working at distances closer than those noted below, ensure the transmitter has been disabled.
2. Typically, the antenna connected to the transmitter is a directional (high gain) antenna, fixed-mounted on the side or top of a building, or on a tower. Depending upon the application and the gain of the antenna, the total composite power could exceed 20 to 61 watts EIRP. The antenna location should be such that only qualified technical personnel can access it, and that under normal operating conditions the antenna separation from the user is required to be located at the distance of 3.5 meters or more.
3. 15.21 Information to user. – The user's manual or instruction manual for an intentional or unintentional radiator shall caution the user that changes or modifications not expressly approved by the party responsible for compliance could void the user's authority to operate the equipment.

EIRP at the antenna is calculated as follows: -

Transmit power – Cable loss + Antenna Gain = EIRP

E.g.

$$+31.1\text{dBm} - 6\text{dB (for 100m LDF5-50A)} + 36\text{dBi} = 61.1\text{dBm}$$

This page is intentionally blank.

# 4 Front Panel Operation

## 4.1 Introduction

This section describes the front panel operation of the EXPEDIO digital radio/modem. This includes:

- LCD display (including all screen menus)
- Cursor and screen control buttons
- LED status indicators

## 4.2 Front Panel Operation

A picture of the EXPEDIO front panel is depicted in Figure 14 below.

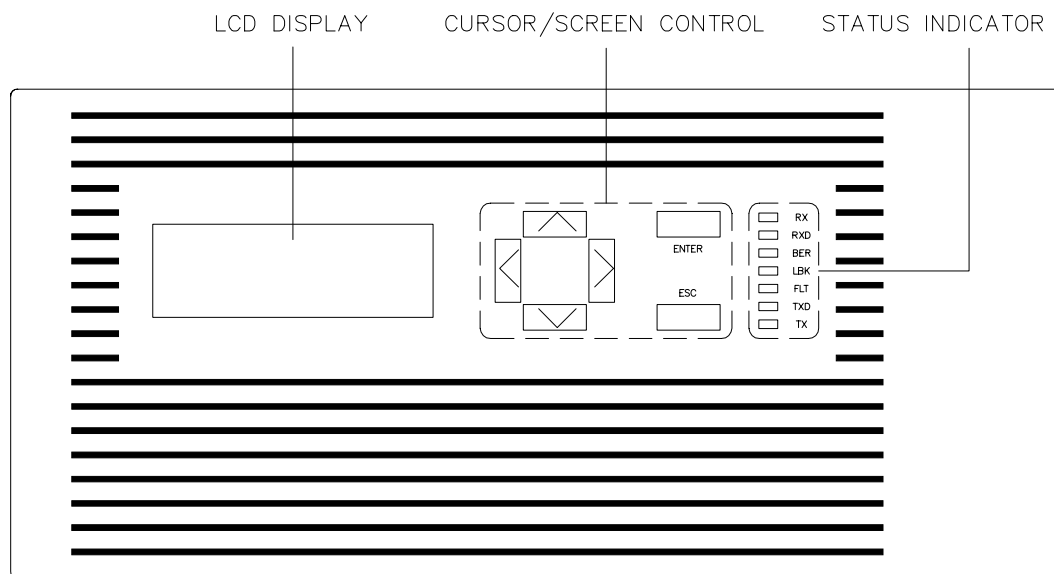

(MD1152-A)

**Figure 14: EXPEDIO Front Panel**

### 4.2.1 LCD Display

The Liquid Crystal Display (LCD) on the EXPEDIO front panel is the primary user interface and provides status, control, configuration, and calibration functionality. The menu navigation and various screens are explained in detail later in this section.

Backlight:





An automatic backlight is built-in to the LCD for better clarity under low-light conditions. This backlight is enabled on power-up and will automatically turn off if there is no button activity by the user. The backlight will automatically turn on as soon as any button is pressed.

Contrast Adjustment:

Internal adjustment on board (in back of front panel button PCB).

**4.2.2 Cursor and Screen Control Buttons**

The buttons on the EXPEDIO front panel are used for LCD screen interface and control functions:

	<ENTER>	Used to accept an entry (such as a value, a condition, or a menu choice).
	<ESC>	Used to “back up” a level in the menu structure without saving any current changes.
	<UP>,<DOWN>	Used in most cases to move between the menu items. If there is another menu in the sequence when the bottom of a menu is reached, the display will automatically scroll to that menu.
	<LEFT>,<RIGHT>	Used to select between conditions (such as ON/OFF, ENABLED/DISABLED, LOW/HIGH, etc.) as well as to increase or decrease numerical values.



### 4.2.3 LED Status Indicators

**Table 3-1. LED Status Indicator Functions**

LED	Name	Function
<b>RX</b>	Receiver	Green indicates that the receiver is enabled, the synthesizer is phase-locked, and a signal is being received.
<b>RXD</b>	Receive Data	Green indicates that valid data is being received.
<b>BER</b>	Bit Error Rate	Flashes red for each data error detected.
<b>FLT</b>	Fault	General fault light (red). Consult the STATUS menus for out of tolerance conditions.
<b>LBK</b>	Loopback	Red indicates analog or digital loopback is enabled.
<b>TXD</b>	Transmit Data	Green indicates the modem clock is phase-locked and data is being sent.
<b>TX</b>	Transmitter	Green indicates the transmitter is radiating, and the RF output (forward power) is above the factory-set threshold.

### 4.2.4 Screen Menu Structure

Figures 3-2a, b and c, located on pages 3-7, 3-8, 3-9 and 3-10, show the tree structure of the screen menu system. The figures group the screens into functional sets. There may be minor differences in the purchased unit, due to software enhancements and revisions. The current software revision may be noted in the **SYSTEM** sub-menu (under **INFO**).

In general, <**ENTER**> will take you to the next screen from a menu choice, <**UP**> or <**DOWN**> will scroll through screens within a menu choice, and <**ESC**> will take you back up one menu level. Certain configuration screens have exceptions to this rule, and are noted later in this section.

---

## **CAUTION**

**DO NOT change any settings in the CONFIGURE or CALIBRATE screens. The security lock-out features of the software may not be fully implemented, and changing a setting will most likely render the system non-operational!**

---

## 4.3 Main Menu

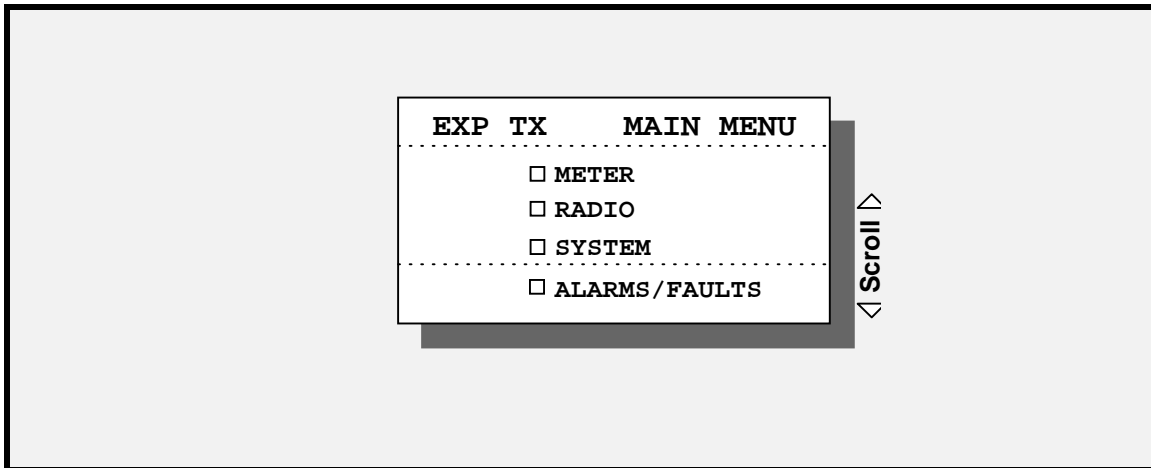

The main menu appears on system boot-up and is the starting point for all screen navigation. Unlike most other screens in the software, the main menu scrolls up or down, one line item at a time.

### 4.3.1 Radio Launch

To access the **Radio Launch** controls, from the Main Menu click RADIO. The Radio Launch screen allows the user to quickly get to a particular screen within a functional grouping in the unit. The logic is slightly different than other screens.

Figure 15 below provides a "Radio Launch Screen Navigation Guide" to assist the user in locating the desired Radio screen.

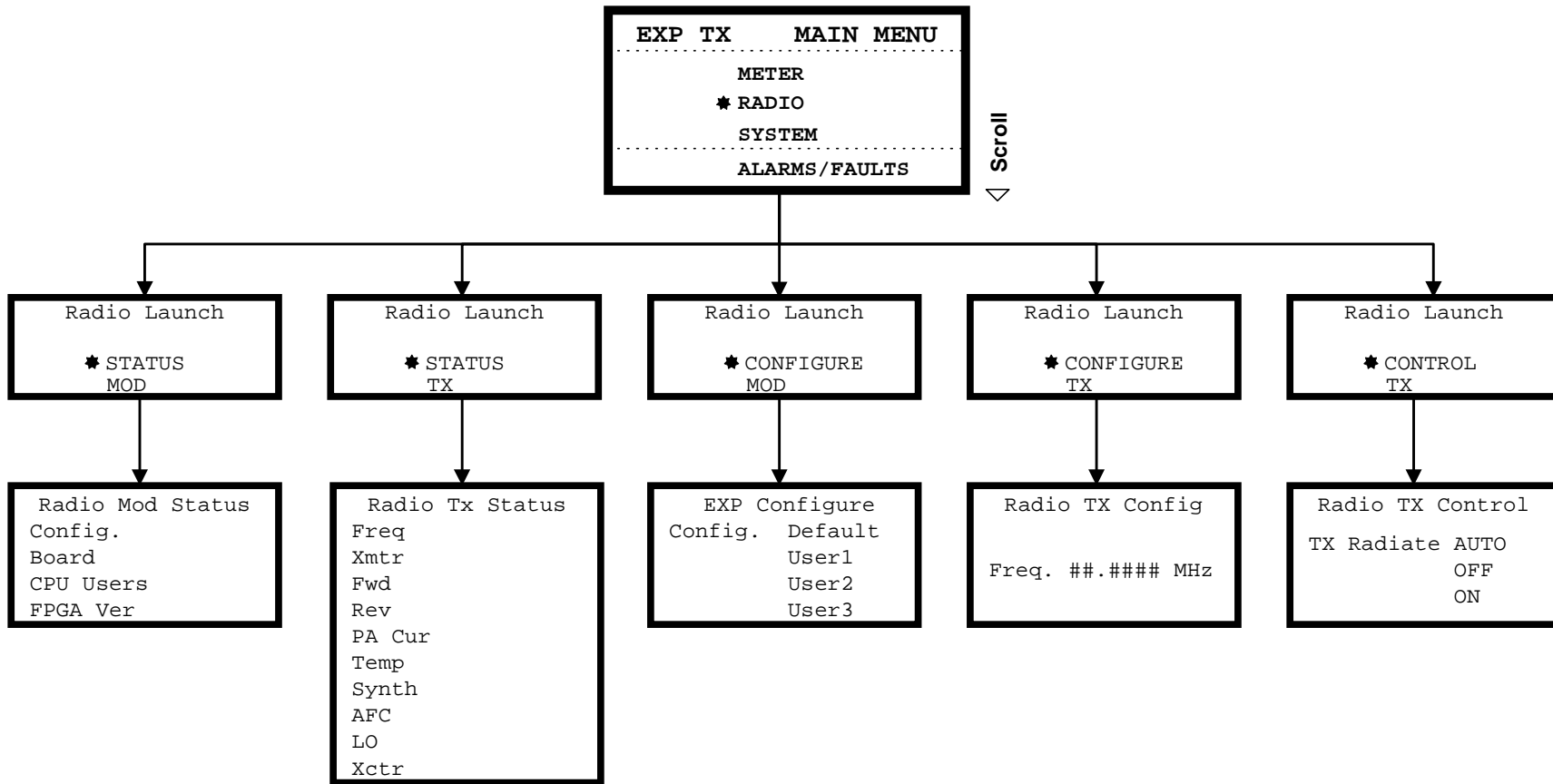

Figure 15: Radio Launch Screen Navigation Guide

This page is intentionally blank

