

# MDV850T

User's Manual

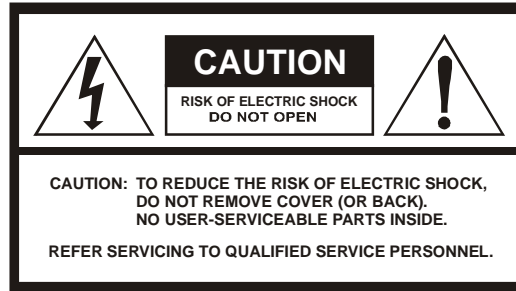



Symbols and supplementary warning on the terminal button.

**Alert**

To prevent fire or shock hazard, do not expose this device to rain or moisture.

**Repair**

Please contact your cable TV operator to have it repaired or replaced, if necessary.



The lightning symbol with an arrow inside the equilateral triangle indicates that the user should pay attention to "dangerous voltage" un-insulated in the frame, which is sufficient to be harmful to humans.



The exclamation mark inside the equilateral triangle indicates that there is important operation and service (maintenance) instructions in the attached printed documents.

**Note:**

No extension cord, socket, or other lead wire should be used with the plug, to avoid electrical shock. The plug should be fully plugged in, with no part exposed.

Never place the device where fluids may drop or splash. Never place any object with fluids, such as vases, on the device.

**In line with IS15245: 2002- BIS Rules**

The installation shall be performed by qualified service personnel in line with local rules and laws.

## Important Safety Measures

- 1 Reading Instructions**  
Read through all safety and operation instruction prior to operating the device.
- 2 Keeping Instructions**  
Keep all safety and operation instructions for future reference.
- 3 Note & Warning Description**  
All warning descriptions on the device and in the operation instructions should be followed.
- 4 Operate according to Instructions**  
All operation instructions should be followed.
- 5 Cleaning**  
Unplug the device from its power supply prior to cleaning. Never use fluid detergent or aerosol. Instead, simply clean with a wet cloth.
- 6 Accessories**  
Any accessory not recommended should not be used, and may result in danger.
- 7 Water and Moisture**  
Do not use this device near a bathtub, basin, sink, washtub, swimming pool or other place near a water supply, nor in a damp basement; any of which may cause a "grounding" effect.
- 8 Supporting Equipment**  
Don't place the device on an unstable cart, block, tripod, bracket, or table. It may fall, resulting in serious personal injuries or damage to the device.
- 9 Ventilation**  
Openings and drilled holes in the cabinet are for ventilation to ensure its reliable operation and to prevent overheating. Do not place the device on a bed, sofa, carpet, or similar surface; otherwise, the openings may be blocked. Do not place the device near or on a radiator or hot air vent, nor inside a bookcase or shelf, unless proper ventilation is provided. Never stack other electronic equipment on the device.
- 10 Power Supply (110V)**  
Only the power designated on the tab can be used (110V). If you are not sure what voltage your outlets support, please consult your local power supply company.
- 11 Protection of Power Cord**  
The power cord should not be walked upon nor overlaid by other cords or connectors.
- 12 Lightning Strike**  
To properly protect the device in a lightning strike, or when unattended or not in use for a long time, please unplug from the power supply or disconnect the antenna or cable network. By doing so, the damage to the video product from lightning strikes or the over-loading of the power supply (surge) can be prevented.
- 13 Overloading**  
Never overload the power supply circuit with other appliances, for it might lead to fire or electrical shock.

**14 Inflow of Articles or Fluids**

Never insert anything into the device, because foreign articles may contact dangerous high-voltage points or lead to a short circuit, causing fire or electrical shock. Never drop any fluid on the device.

**15 Repair**

Do not try to repair device yourself, for you may be exposed to dangerous voltage or other risks after removing or opening the cover. Have it repaired by experienced professional repair personnel.

**16 Damage to Be Repaired**

Unplug the device from the wall socket and have it repaired by qualified repair personnel if any of the following should occur:

- a The power cord or plug is damaged.
- b The device is exposed to rain or flooded with water.
- c Fluids or foreign objects fall into it.

- d The device does not operate properly after following the directions for use described in this manual. If this occurs, adjust only the controls introduced in the instructions, because any improper adjustment of other controls may result in damage, and, in most cases, may require work by a qualified technician to have it work properly again.
- e The device falls or the cabinet is damaged.
- f Its performance undergoes obvious changes, which indicate a repair is required.

**17 Replacing Parts**

When it is necessary to replace a part, be sure to have it replaced by service technicians with the part stipulated by the manufacturer or one having the same features as the original. Using unauthorized replacement parts may result in fire, electrical shock, or other dangers.

**18 Safety Inspection**

Whenever the device has been serviced or repaired, have it inspected for safety by a service technician (insulation standard testing) to ensure its proper operation.

### **FCC Compliance**

This device is intended to be attached to a receiver that is not used to receive over-the-air broadcast signals. Connection of this device in any other fashion may cause harmful interference to radio communications and is in violation of the FCC Rules, Part 15.

This device complies with Part 15 of the FCC Rules. Operation is subject to the following two conditions: (1) this device may not cause harmful interference, and (2) this device must accept any interference received, including interference that may cause undesired operation.

CAUTION: Any changes or modifications not expressly approved by the grantee of this device could void the user's authority to operate the equipment.

NOTE: This equipment has been tested and found to comply with the limits for a Class B digital device, pursuant to Part 15 of the FCC Rules. These limits are designed to provide reasonable protection against harmful interference in a residential installation. This equipment generates, uses and can radiate radio frequency energy and, if not installed and used in accordance with the instructions, may cause harmful interference to radio communications. However, there is no guarantee that interference will not occur in a particular installation.

If this equipment does cause harmful interference to radio or television reception, which can be determined by turning the equipment off and on, the user is encouraged to try to correct the interference by one or more of the following measures:

- Reorient or relocate the receiving antenna.
- Increase the separation between the equipment and receiver.
- Connect the equipment into an outlet on a circuit different from that to which the receiver is connected.
- Consult the dealer or an experienced radio/TV technician for help.

Copyright © 2007 Motorola, Inc. All Rights Reserved. No part of this publication may be reproduced in any form or by any means or used to make any derivative work (such as translation, transformation or adaptation) without written permission from Motorola, Inc.

Motorola reserves the right to revise this publication and to make changes in content from time to time without obligation on the part of Motorola to provide notification of such revision or change. Motorola provides this guide without warranty of any kind, express or implied, including, but not limited to, the implied warranties of merchantability and fitness for a particular purpose. Motorola may make improvements or changes in the product(s) described in this manual at any time. MOTOROLA and the Stylized M logo are registered trademarks of Motorola, Inc. All other products or service names are the sole property of their respective owners.

## CONTENTS

<b>Introduction .....</b>	<b>2</b>
Front Panel .....	3
Back Panel.....	5
<b>Remote Control .....</b>	<b>7</b>
Main Service .....	11
<b>Basic Front Panel Operations.....</b>	<b>12</b>
Power On/Off .....	12
Change Channel.....	12
<b>Rear Panel Audio-Video Connections .....</b>	<b>13</b>
<b>Record Connections .....</b>	<b>14</b>
<b>Rear Panel Connection — Mono.....</b>	<b>15</b>
<b>Rear Panel Connection — Stereo .....</b>	<b>16</b>
<b>Troubleshooting .....</b>	<b>18</b>

## INTRODUCTION

Congratulations on your purchase of a **Motorola MDV850T Set-top Box**. The **MDV850T** brings a series of interactive applications for your TV program viewing that allow you to enjoy digital TV programs with quality sound and video at home.

This manual describes the basic features of the **MDV850T** and provides several solutions for integrating the box with your current entertainment audio and video system. Please contact your service provider to ensure that the service is provided in your area. Your service provider also provides instructions on optional services.

With other available applications and networks, the **MDV850T** can provide hundreds of digital and analogue video channels.

If you encounter any difficulty in using this set-top box, please refer to the related part of the manual or consult your network program provider.

## INTRODUCTION

### Front Panel

There are 7 keys and 2 indicators on the front panel of the **MDV850T**. The keys perform basic functions. Each control and their possible functions are described in the following figure and table.

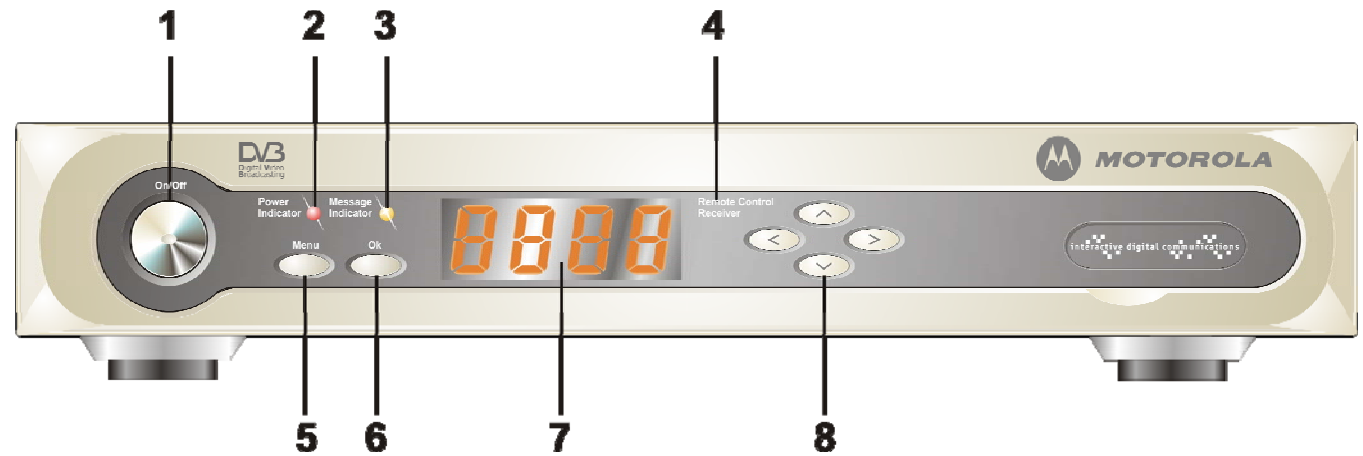



## INTRODUCTION

	<b>Functions</b>	<b>Description</b>
1	<b>On/Off</b>	Enter or exit the start-up mode
2	<b>Power Indicator</b>	Indicator, meaning the <b>MDV850T</b> has been started
3	<b>Message Indicator</b>	Indicator, meaning there is a message
4	<b>Remote Control Receiver</b>	Receives the remote control's signal
5	<b>Menu</b>	Press to display the Settings menu
6	<b>Ok</b>	Used to select or cancel while editing favorites; also used to confirm a selection
7	<b>Display</b>	Displays channel number, error message
8	<b>Four-direction Moving Key</b>	Used to change channels and scroll through selections

## INTRODUCTION



### NOTE:

SOME UNITS MAY HAVE A DIFFERENT BACK PANEL CONFIGURATION FROM THE FIGURE SHOWN BELOW. CONTACT YOUR SERVICE PROVIDER TO ENSURE YOUR CONNECTION IS SUPPORTED BY THE SYSTEM.

## Back Panel

The **MDV850T** is designed to connect with several standard TV sets. The back panel includes audio and video connectors and a Smart Card slot. The connecting terminals and their possible functions are described in the following figure and table.

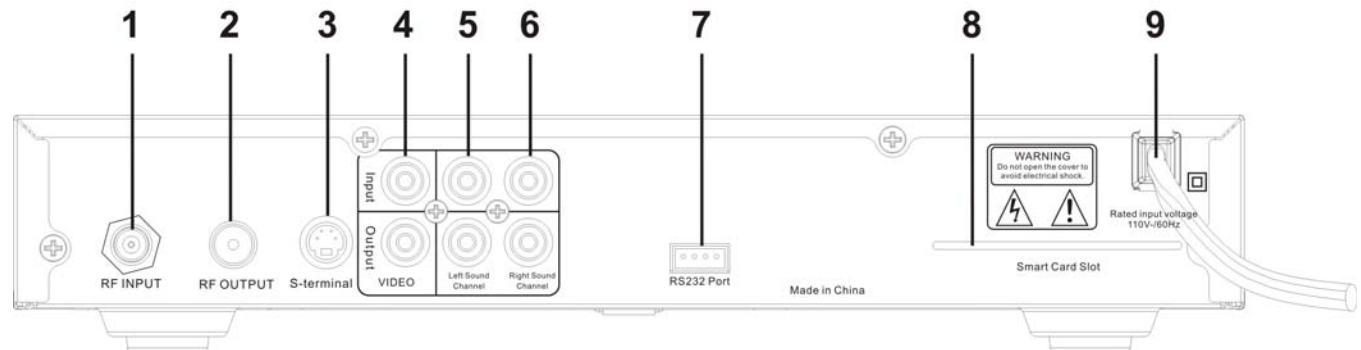

## INTRODUCTION

	<b>Functions</b>	<b>Description</b>
<b>1</b>	<b>RF INPUT</b>	The coaxial input terminal provides the receiving signal from your service provider.
<b>2</b>	<b>RF OUTPUT</b>	The coaxial output terminal is used to link your <b>MDV850T</b> to a standard TV set or a video recorder.
<b>3</b>	<b>S-terminal</b>	This is a single channel connector to provide video for your TV set or video recorder.
<b>4</b>	<b>VIDEO</b>	This is a single channel video connector to provide video for your TV set or video recorder.
<b>5</b>	<b>Left Sound Channel</b>	The single channel connector is used to provide the left channel audio signal to your stereo receiver.
<b>6</b>	<b>Right Sound Channel</b>	The single channel connector is used to provide the right channel audio signal to your stereo receiver.
<b>7</b>	<b>RS232 Port</b>	The RS232 Port is used by your service provider to offer quick solutions to you.
<b>8</b>	<b>Smart Card Slot</b>	The TV service card can be inserted into this Smart Card slot.
<b>9</b>	<b>Power Cord</b>	This is 2-core power cord, with which the plug is connected with the socket.

## REMOTE CONTROL

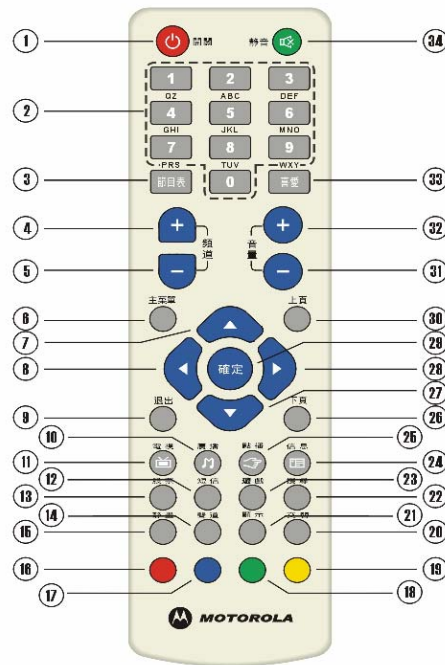

The **MDV850T's remote control** is specially designed to enable you to enjoy your service. All functions of the **MDV850T** can be achieved with this remote control; some functions can be realized on the front panel of the unit as well.





When you use the menu, except when in installation and reinstallation mode, simply press the **exit** key whenever you wish to return the normal TV/Radio mode. The download of new software which can be executed in "system update" may change some functions of the unit.

The functions of the remote control are listed in the following table.



**NOTE:**  
The remote control style may vary in different areas.





## REMOTE CONTROL

	Key	Description
1	On/Off 	Enter or exit the stand-on mode.
2	Numerical Key	Key-in numbers corresponding to channel 0-9. Each key also has its corresponding letters for entering Chinese or English. The details are as follows: 1-punctuation marks (including @), 2-ABC, 3-DEF, 4-GHI, 5-JKL, 6-MNO, 7-PQRS, 8-TUV, 9-WXYZ, 0-“ ”.
3	Program Schedule	Enters the program schedule of the current channel.
4	Channel +	Shifts to the nearest channel higher than the current channel.
5	Channel -	Shifts to the nearest channel lower than the current channel.
6	Main Menu	Displays the main menu.
7	 Up/Increase Channel	Menu cursor moving and selection parameter adjustment. Shifts up or down to the next program.
8	 Left/Lower Volume	Menu cursor moving and selection parameter adjustment. In the video playing or audio state, it can be used to lower the volume.
9	Exit	Exits the menu mode or returns to the information homepage in the radio mode.
10	 Radio	Shortcut to enter the digital radio program schedule.
11	 TV	Shortcut to enter the digital TV program schedule.
12	SMS	Shortcut to enter TV mailbox (reserved).
13	Stock	Shortcut to enter the financial and stock system.

## REMOTE CONTROL

	Key	Description
14	<b>Sound Channel</b>	Sound selection to shift between left, right, and stereo sound.
15	<b>Screen Freezing</b>	Freeze screen/cancel screen freezing, in which the audio continues while an icon appears on the upper right corner of the screen to indicate that the screen is frozen.
16	<b>Red Function Key</b>	In the TV/video/audio service mode, it displays channel and program information/supporting functions.
17	<b>Blue Function Key</b>	In the TV/video/audio service mode, it enters the system setup menu/supporting functions.
18	<b>Green Function Key</b>	In the video/audio service mode, it shifts between video, audio, and your favorites/supporting function.
19	<b>Yellow Function Key</b>	In the video/audio service mode, it is connected twice in two seconds to check signal operation/supporting function.
20	<b>Tab</b>	Returns to the upper layer of the menu to the last channel watched.
21	<b>Display</b>	Displays information on the current program, including EPG information such as channel name, program information, and next program. Pressing the button twice displays a brief introduction of the current program. EPG information disappears after 5 minutes.
22	<b>Search</b>	The search interface appears, in which a user may select to search or not. Press "ok" to search, and "exit" not to search.
23	<b>Game</b>	Shortcut to enter game interface (reserved).
24	 <b>Information</b>	Shortcut to enter the homepage for digital broadcasting.

## REMOTE CONTROL

	Key	Description
25	 VOD	Shortcut to enter NVOD.
26	Page down	Turns page down (previous) in the EPG menu.
27	 Down/decrease channel	Menu cursor moving and selection parameter adjustment. Shift to next program.
28	 Right/increase volume	Menu cursor moving and selection parameter adjustment. In the video playing or audio state, it can be used to increase volume input.
29	OK	Confirms your selection, reserved for play/pause.
30	Page up	Turns to previous (back) page in the EPG menu.
31	Volume -	Lowers volume in playing video or audio.
32	Volume +	Increases volume in playing video or audio.
33	Favorites	Enters the favorites and shifts between favorite channels, TV channel list, and radio channel list.
34	 Mute	Mute/cancel mute sound function.

## **Main Service**

In the watching mode, press **Main Service** to enter the main service menu, which includes the following services (these may vary depending upon your service provider): select with up/down keys and press **OK** to enter; after entering, press **Program +** or **Program -** to change to your desired channel.



## BASIC FRONT PANEL OPERATIONS



### NOTE:

*Power cord's plug should be inserted fully into the power socket.*

*If the "RF output" connector of the MDV850T is connected to the "CABLE IN" coaxial connection of your TV set, the TV set must be adjusted to the output channel of the MDV850T. The information is provided by your service provider.*

### Power On/Off

Press the "On/Off" key on the front panel.

### Change Channel

Press the "4-direction moving key" on the front panel of the **MDV850T** to select your desired channel.

## REAR PANEL AUDIO-VIDEO CONNECTIONS



**NOTE:**

**NEVER** PLACE ANYTHING ON TOP OF YOUR **MDV850T**, ESPECIALLY OTHER HOME VIDEO EQUIPMENT.

THE PROPER OPERATION OF THE **MDV850T** REQUIRES SUFFICIENT VENTILATION AND AIR FLOW TO AVOID OVERHEATING.

When you move or change any component of your entertainment system, please read through the following:

- For basic cable connection, please use the equipped 75-ohm F connector coaxial cable. (The coaxial connection between the “RF output” terminal of the **MDV850T** and a standard TV set or video recorder cannot provide the stereo effect for the digital channel.)
- Please use the supplied cable of the single-channel connector for the audio or video output.
- Shut off the power supply of the **MDV850T** prior to moving the device or changing the cable connection.

## RECORD CONNECTIONS

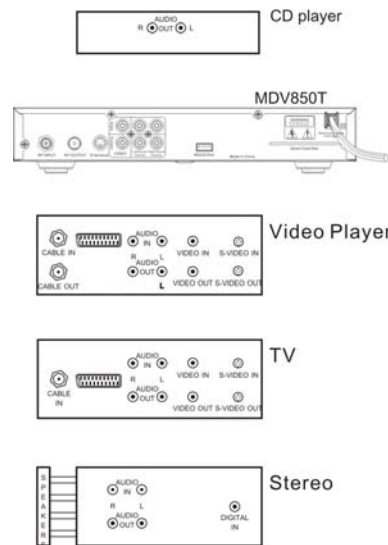

Please record the rear panel connections prior to using the **MDV850T**. Prior to re-connecting the system in the future, please refer to this connection diagram for reference.

## REAR PANEL CONNECTION — MONO

### Mono

Use this connection when you connect the **MDV850T** to your TV set or video player. This method only provides monophonic sound.

Connect to cable  
signal port

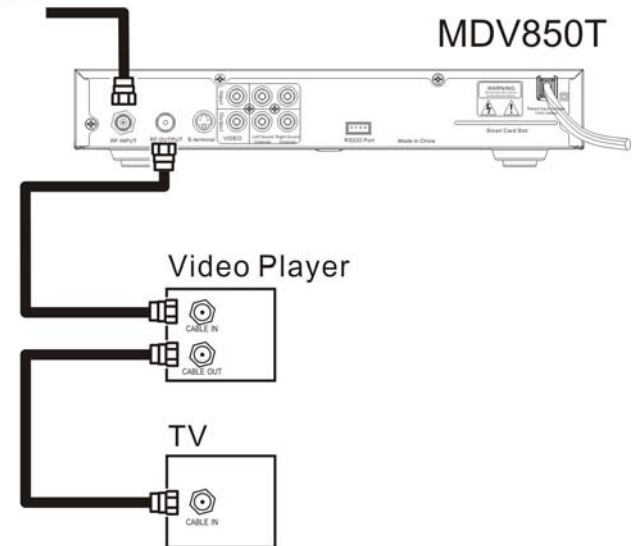

## REAR PANEL CONNECTION — STEREO

### Stereo

Follow this diagram when connecting a stereo TV or VCR. Link the **MDV850T** to the video connector and left/right sound channel connector of your TV set or video player.

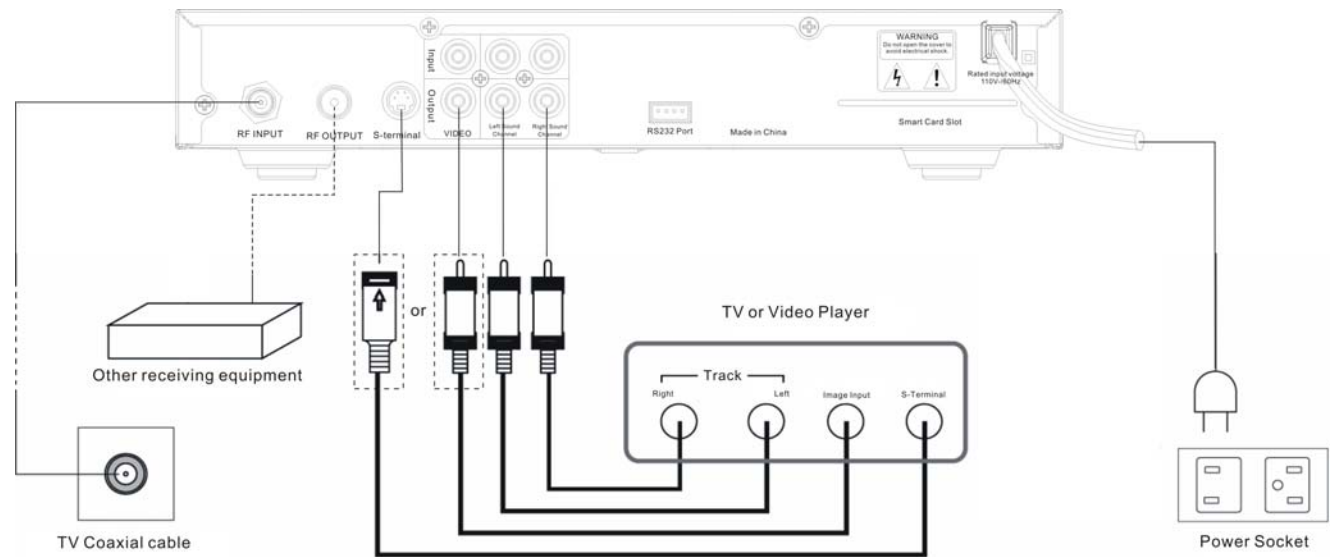

## TROUBLESHOOTING

Please read through the troubleshooting guidelines before calling your service provider. The information is to help you quickly solve your problems. If they remain unsolved, please contact your service provider.

<b>Problem</b>	<b>Reasons</b>	<b>Possible Solutions</b>
<b>No sound</b>	Pressed the “mute key” on the remote control accidentally.	Press the “mute” key on the remote control to resume the volume.
	The sound selection on the stereo equipment is set to a wrong component.	Check to ensure the input source of the stereo equipment is correct.
	The video player output is the TV output.	If you want to watch video using your TV set, please ensure the video player is on.
<b>No Video</b>	The cable signal may have not been transmitted to your house.	Check to ensure all cables are connected properly and the TV set is set to the cable TV channel designated by your service provider. If necessary, tighten the cable TV signal cable.
	The signal cable of cable TV is not correct.	If you use base band video connection, ensure the cable is connected properly.
	The video player output is in the TV output.	If you want to watch video using your TV set, please ensure the video player is on.
	The MDV850T may be receiving software updates from your cable TV provider.	Please wait for the completion of the download. After download, <b>MDV850T</b> should return to the channel you were watching before the download began.

## TROUBLESHOOTING

Problem	Reasons	Possible Solutions
<b>Video is unclear or accompanied by noise.</b>	The signal cable is disconnected or the connection is loose.	Check the connection; if necessary, tighten the connection manually.
<b>Only one stereo speaker produces sound</b>	The signal cable is disconnected or the connection is loose.	Check the connections; if necessary, tighten the connection manually, or reconnect the signal cable correctly. Ensure the signal cable is not worn, and the plug is not twisted or broken.
<b>No Power</b>	The power cord is disconnected.	Reconnect the power cord. Ensure the power socket in which the plug of the <b>MDV850T</b> is inserted always has a power supply.
<b>The remote control does not work.</b>	The battery is out of power.  There is a barrier between the remote control and the cable terminal.	Install fresh batteries in the remote control.  Make sure there is nothing blocking the signal transfer between the <b>MDV850T</b> and its remote control.

521852-005 Rev. B  
08/07  
English

MGBI

