

APPLICANT: MOTOROLA, INC.

FCC ID: IHDT56EU1

INSTRUCTION MANUAL

A preliminary draft copy of the Users Manual follows:

Welcome

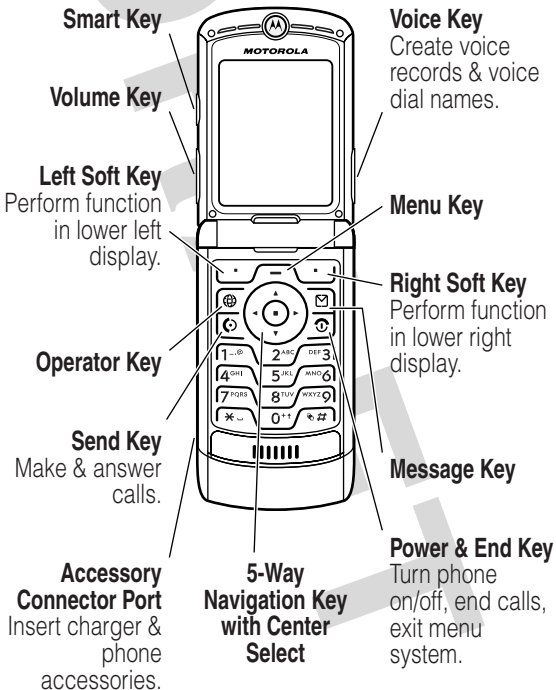

Welcome to the world of Motorola digital wireless communications! We are pleased that you have chosen the Motorola V3 GSM wireless phone.

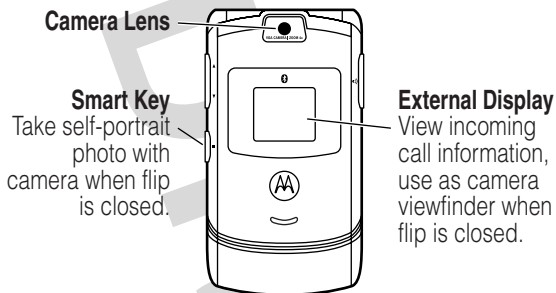

Check It Out!



Feature	Description
Take Photo	Press CAMERA (_) to activate the camera, point lens at subject, press CAPTURE (_) to take a photo.
Take Self-Portrait (flip closed)	Activate the camera, close the flip, use viewfinder to aim lens, press smart key to take a photo.
Send Photo	Send a photo to a phone number or email address: Take photo, then press STORE (_) > Send In Message.

Feature	Description
Set Photo as Picture ID	Assign a photo to a phonebook entry to allow picture caller ID: Take photo, then press STORE (📷) > Apply as Phonebook Entry.
Send Multimedia Message	Send a multimedia message with pictures, animations, sounds, and videos:  > Create Message > New Multimedia Msg
Wireless Connection	Set up a Bluetooth® wireless connection to a headset accessory, car kit, or external device:  > Settings > Connection > Bluetooth Link > Handsfree > [Look For Devices]



Motorola, Inc.
Consumer Advocacy Office
1307 East Algonquin Road
Schaumburg, IL 60196

1-800-331-6456 (United States)
1-888-390-6456 (TTY/TDD United States)
1-800-461-4575 (Canada)

www.motorola.com (United States)

www.motorola.ca (Canada)

MOTOROLA and the Stylized M Logo are registered in the US Patent & Trademark Office. The Bluetooth trademarks are owned by their proprietor and used by Motorola, Inc. under license. Java and all other Java-based marks are trademarks or registered trademarks of Sun Microsystems, Inc. in the U.S. and other countries. All other product or service names are the property of their respective owners.

© Motorola, Inc. 2004.

The information contained in Motorola's user's guides is believed to be correct at the time of printing. Motorola reserves the right to change or modify any information or specifications without notice. The contents of Motorola's user's guides are provided "as is." Except as required by applicable law, no warranties of any kind, either express or implied, including, but not limited to, the implied warranties of merchantability and fitness for a particular purpose, are made in relation to the accuracy, reliability, or contents of this guide.

Caution: Changes or modifications made in the radio phone, not expressly approved by Motorola, will void the user's authority to operate the equipment.

Manual number: 68XXXXXX50-O

Contents

Getting Started	8
About This Guide	8
Installing the SIM Card	10
Battery Use	10
Installing the Battery	12
Charging the Battery	12
Turning Your Phone On	14
Turning Your Phone Off	14
Adjusting Volume	15
Making a Call	15
Answering a Call	16
Viewing Your Phone Number	16
Highlight Features	17
Taking and Sending a Photo	17
Sending a Multimedia Message	20
Using a Bluetooth [®] Wireless Connection	23
Learning to Use Your Phone	26
Using the Display	26
Using the 5-Way Navigation Key	31
Using the Operator Key	31
Using the Message Key	31
Using Menus	32
Entering Text	34
Using the Smart Key	46
Using the External Display	46
Using the Handsfree Speaker	47
Changing a Code, PIN, or Password	48
Locking and Unlocking Your Phone	49

If You Forget a Code, PIN, or Password	50
Using the Phonebook	51
Setting Up Your Phone	54
Setting a Ring Style	54
Setting the Time and Date	54
Setting a Wallpaper Image	55
Setting a Screen Saver Image	56
Changing Phone Skin	57
Setting a Phone Theme	57
Setting Answer Options	58
Setting Display Brightness	59
Adjusting the Backlight	59
Setting Display Timeout	59
Storing Your Name and Phone Number	60
Calling Features	61
Turning Off a Call Alert	61
Viewing Recent Calls	61
Redialing a Number	63
Using Automatic Redial	63
Returning an Unanswered Call	64
Using the Notepad	64
Putting a Call On Hold or Mute	65
Using Call Waiting	65
Using Caller ID (Incoming Calls)	66
Calling an Emergency Number	67
Dialing International Numbers	67
Calling With 1-Touch Dial	67
Using Voicemail	68
Changing the Active Line	69

Phone Features	70
Main Menu	70
Settings Menu	71
Feature Quick Reference	72
Specific Absorption Rate Data	93
Index	95

DRAFT

Getting Started



CAUTION: Before using the phone for the first time, read the *Important Safety and Legal Information* included in the gray-edged pages at the back of this guide.

About This Guide

This guide describes the basic features of your Motorola wireless phone.

Note: A *More Here* reference guide for your phone is also available that describes your phone's features in more detail.

To obtain the *More Here* guide for your phone, or another copy of this guide, see the Motorola Web site at:

<http://motorola.com/consumer/manuals> (U.S.A.)



<http://motorola.ca/consumer> (Canada)

or contact the Motorola Customer Call Center at 1-800-331-6456 (U.S.A.) or 1-800-461-4575 (Canada).

Selecting a Menu Feature

Use the menu system to access your phone's features. This guide shows you how to select a menu feature from the home screen as follows:

Find the Feature  > **Recent Calls** > **Dialed Calls**

This example shows that, from the home screen, you must press the menu key  to open the menu, scroll to and select  **Recent Calls**, then scroll to and select **Dialed Calls**.

Press the 5-way navigation key  to scroll and highlight a menu feature. Press **SELECT** () to select the highlighted menu feature.

Optional Features



This label identifies an optional network, SIM card, or subscription-dependent feature that may not be offered by all service providers in all geographical areas. Contact your service provider for more information.

Optional Accessories



This label identifies a feature that requires an optional Motorola Original™ accessory.



Installing the SIM Card

Your *Subscriber Identity Module* (SIM) card contains your phone number, service details, and phonebook/message memory.

Caution: Do not bend or scratch your SIM card. Avoid exposing your SIM card to static electricity, water, or dirt.

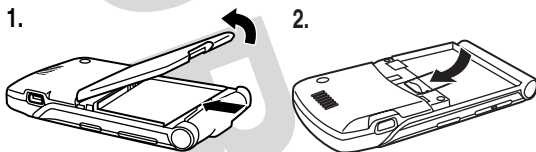

Battery Use

Battery performance depends on many factors, including your wireless carrier's network configuration; signal strength; the temperature at which you operate your phone; the features and/or settings you select and use; items attached to the phone's accessory connector; and your voice, data, and other application usage patterns.

Caution: To prevent injuries or burns, do not allow metal objects to contact or short-circuit the battery terminals.

To maximize your battery's performance:

- Always use Motorola Original batteries and battery chargers. The phone warranty does not cover damage caused from using non-Motorola batteries and/or battery chargers.



- New batteries or batteries that have been stored for a long time may require a longer charge time.
- Maintain the battery at or near room temperature when charging.
- Do not expose batteries to temperatures below -10°C (14°F) or above 45°C (113°F). Always take your phone with you when you leave your vehicle.
- When you do not intend to use a battery for a while, store it uncharged in a cool, dark, dry place, such as a refrigerator.
- Batteries gradually wear down and require longer charging times. This is normal. If you charge your battery regularly and notice a decrease in talk time or an increase in charging time, then it is probably time to purchase a new battery.



The rechargeable batteries that power this phone must be disposed of properly and may need to be recycled. Refer to your battery's label for battery type. Contact your local recycling center for proper disposal methods.

Warning: Never dispose of batteries in a fire because they may explode.

Installing the Battery



TM Your phone is designed to use only Motorola Original batteries and accessories. We recommend that you store batteries in their protective cases when not in use.

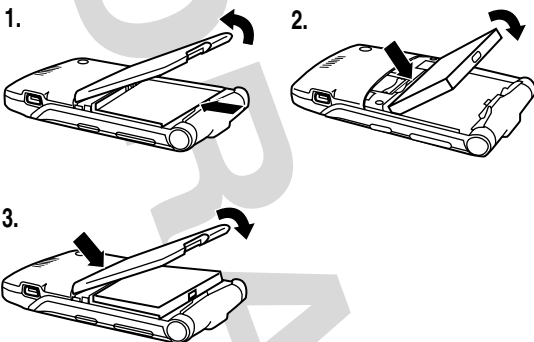

Charging the Battery

New batteries are shipped partially charged. Before you can use your phone, you need to install and charge the battery as described below. Some batteries perform best after several full charge/discharge cycles.

Tip: The USB adapter makes it easier for you to use your phone with an attached battery charger or phone accessory.

Action

- 1 Insert the travel charger plug into the detachable USB adapter as shown.
- 2 Insert the USB adapter plug into the USB connector port on your phone.

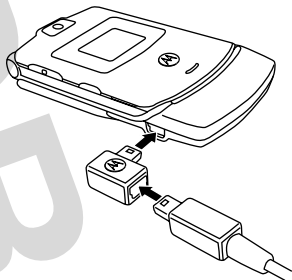

- 3 Plug the other end of the travel charger into the appropriate electrical outlet.

Note: It may take up to 10 seconds for your phone to provide a visible or audible indication that the battery is charging.

- 4 When your phone indicates **Charge Complete**, remove the travel charger.

Note: You can safely leave the travel charger connected to the phone after charging is complete. This will **not** damage the battery.



Turning Your Phone On

Action

- 1 Press and hold the power key  for 2 seconds to turn the phone on.

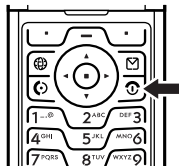

Note: It may take up to 4 seconds for the display to illuminate after you turn the phone on.



- 2 If necessary, enter your SIM card PIN code and press **OK** () to unlock the SIM card.

Caution: If you enter an incorrect PIN code 3 times in a row, your SIM card is disabled and your phone displays **SIM Blocked**.

- 3 If necessary, enter your 4-digit unlock code and press **OK** () to unlock the phone.

At startup, you are prompted to personalize your phone. Select **YES** () to set personal phone options, or **NO** () to go to the home screen. For more information about personalizing your phone, see page 77.

Turning Your Phone Off

Action

Press and hold the power key  for 2 seconds to turn the phone off.

Adjusting Volume

Press the volume key up or down to:

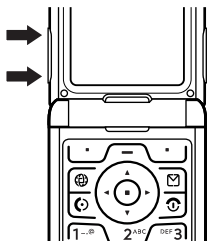

- silence an incoming call alert
- increase or decrease earpiece volume during a call
- increase or decrease ringer volume when the home screen is visible (flip must be open)



Tip: At the lowest volume setting, press the volume key down once to switch to vibrate alert. Press it down again to switch to silent alert. Press the volume key up to switch back to vibrate alert, then ring alert.

Making a Call

You must be in the home screen to dial a phone number (see page 26).

Press	To
1 keypad keys	dial the phone number
2 	make the call
3 	end the call and “hang up” the phone when you are finished

Tip: You can also close the phone flip to end the call.

Answering a Call



When you receive a call, your phone rings and/or vibrates and displays an incoming call message.

When the phone flip is active, open the phone to answer the call. (To activate, press $\sqrt{-}$ > **Settings** > **In Call Setup** > **Answer Options** > **Open To Answer.**)

If the phone flip is **not** active:

	Press	To
1	or ANSWER ($\sqrt{-}$)	answer the call
2		end the call and “hang up” the phone when you are finished

Viewing Your Phone Number

To view your phone number from the home screen, press $\sqrt{-}$ $\sqrt{*}$.

While you are on a call, press $\sqrt{-}$ > **My Tel. Numbers.**

Note: Your phone number must be stored on your SIM card to use this feature. To store your phone number on the SIM card, see page 60. If you do not know your phone number, contact your service provider.

Highlight Features

You can do much more with your phone than make and receive calls!



Taking and Sending a Photo

Shortcut: From the home screen, press **CAMERA** () to activate the camera.

To activate your phone's camera from the menu system:

Find the Feature  > **Multimedia** > **Camera**

The active viewfinder image appears on your display.

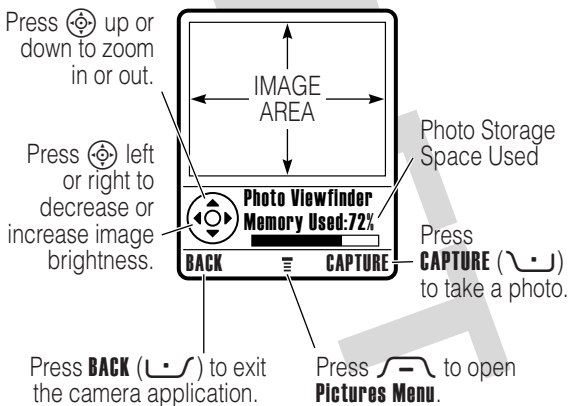

Point the camera lens at the photo subject, then:



Press	To
1 CAPTURE (📷)	take a photo
2 STORE (📷)	view storage options If you choose to store the photo, continue to step 3.
or	
DISCARD (📷)	delete the photo and return to active viewfinder
3 	scroll to Send in Message , Store Only , Apply as Wallpaper , Apply as Screen Saver , or Apply as Phonebook Entry
4 SELECT (📷)	perform the storage option

Taking a Self-Portrait

Action
1 From the home screen, press CAMERA (📷) to activate the camera, then close the flip. or Close the flip, then press and hold the smart key to activate the camera and external display viewfinder.
2 Use the external viewfinder to aim the camera lens.

Action

- 3 Press the smart key to take a photo.
- 4 Wait 2 seconds for your phone to save the photo and reset the external viewfinder.

or

Open the flip to store or discard the photo.



Adjusting Camera Settings

Press  to open the **Pictures Menu** when the camera is active. The **Pictures Menu** can include the following options:

Option	Description
Go To Pictures	View pictures and photos stored on your phone.
Auto-Timed Capture	Set a timer for the camera to take a photo.
Delete All	Delete all pictures.
Pictures Setup	Open the setup menu to adjust the following settings:
	<ul style="list-style-type: none">• Auto Repeat: Set pictures to display repeatedly when viewing a picture album.• Shuffle: Set pictures to display randomly when viewing a picture album.• Lighting Conditions: Set to Automatic, Sunny, Cloudy, Indoor (Home), Indoor (Office), or Night.• Exposure: Set to +2, +1, 0, -1, or -2.



Option	Description
	<ul style="list-style-type: none"> • Resolution: Set the camera to capture photos at the following resolutions: MMS (160x120 pixels), Medium (320x240 pixels, or High (640x480 pixels)
	<ul style="list-style-type: none"> • Shutter Tone: Activate a tone that sounds when you take a photo. Can be set to None, Chimp, Quack, Flix, Boing, or Click.
View Free Space	See how much memory remains for storing pictures.

Sending a Multimedia Message













A *Multimedia Messaging Service* (MMS)

multimedia message contains one or more pages with text and embedded media objects (including photos, pictures, animations, sounds, voice records, and/or video clips). You can send the multimedia message to other wireless phone users, and to email addresses.

Find the Feature











- ✉ > Create Message
- > New Multimedia Msg

Press	To
1 keypad keys	enter text on the page
2	open the MMS Menu
3	scroll to Insert
4 SELECT (display a list of items you can insert











Press	To
5 	scroll to Picture, Voice Record, Sound, Video, New Page, Quick Note, or Contact Info
6 SELECT ()	select the file type
7 	highlight the file you want
8 SELECT ()	insert the file
	To add another page to the message, continue to step 9. To send the message, go to step 14.
9 	open the MMS Menu to insert a new page
10 	scroll to Insert
11 SELECT ()	display a list of items you can insert
12 	scroll to New Page
13 SELECT ()	insert a new page after the current page
	Repeat steps 1 to 8 to enter contents for the new page.
14 OK ()	store the message





Press	To
15 	scroll to a Send To option: Highlight an existing phonebook entry. Or highlight [One Time Entry] to enter one or more phone numbers or email addresses. Or highlight [New Phonebook Entry] to enter a number/address and add it to the phonebook.
16 ADD ()	add a phonebook entry to the list of recipients
or	
SELECT ()	select [One Time Entry] or [New Phonebook Entry]
17 DONE ()	store the numbers/addresses
18 	scroll to Subject
19 CHANGE ()	select Subject
20 keypad keys	enter the subject
21 OK ()	store the subject
22 CHANGE ()	select Attachments to attach a file to the message, if desired
23 	scroll to Picture , Sounds , or Video
24 SELECT ()	select the file type



Press	To
25 	highlight the file you want
26 SELECT ()	attach the file
27 BACK ()	return to the message editor
28 	scroll to Receipt to request a receipt, if desired
29 CHANGE ()	select Receipt
30 ADD () or REMOVE ()	activate/deactivate the delivery report
31 DONE ()	return to the message editor
32 SEND ()	send the message
or 	view message details, save the message in the drafts folder, or cancel the message



Using a Bluetooth® Wireless Connection

Your phone supports Bluetooth wireless connections. You can set up a wireless link with a Bluetooth-enabled headset, speakerphone, or handsfree car kit, or connect to a computer or hand-held device to exchange and synchronize data.

Note: To extend battery life, turn off Bluetooth when not in use.

Searching for Other Devices

To connect your phone to a headset or handsfree device:



Find the Feature

- > Settings > Connection
- > Bluetooth Link
- > Handsfree
- > [Look For Devices]

If Bluetooth is turned off, your phone asks if you want to **Temporarily Power On?** Bluetooth. Press **YES** (↵) to proceed.

Your phone scans for and displays a list of device(s) located within range of the phone.

Note: If your phone is already connected to a device, you must disconnect from it to search for other devices.

To connect to a device, highlight the device name and press **SELECT** (↵).

The device may request permission to bond with your phone. Select **YES** (↵) and enter the correct PIN code to create a secure connection with the device. When the connection is made, the Bluetooth indicator  or a **Bluetooth Connected** message displays in the home screen.

Sending Objects to Another Device

You can use a Bluetooth wireless connection to send a picture, sound, video, phonebook entry, datebook event, or bookmark from your phone to another phone, computer, or hand-held device.

Sending a Picture, Sound, or Video

Highlight the object on your phone that you want to send to the other device, then press  > **Copy**.

Select a recognized device name listed in the **Object Exchange** menu, or **[Look For Devices]** to search for the device to which you want to send the object.

Sending a Phonebook Entry, Datebook Event, or Bookmark

Highlight the item on your phone that you want to send to the other device, then press  > **Send**.

Select a recognized device name listed in the **Object Exchange** menu, or **[Look For Devices]** to search for the device to which you want to send the item.





Learning to Use Your Phone



See page 1 for a basic phone diagram.

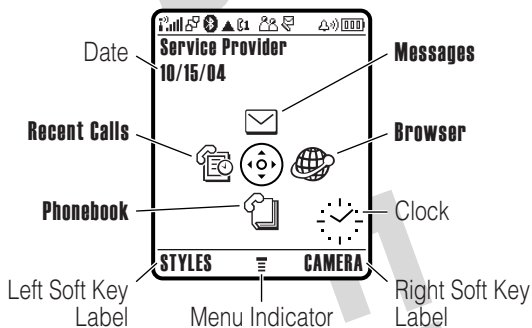

Using the Display

The *home screen* is displayed when you are **not** on a call or using the menu. You must be in the home screen to dial a phone number.



Press the 5-way navigation key  up, down, left, or right to select a menu feature icon. If you select a menu icon by mistake, press  to return to the home screen.

The menu indicator  shows that you can press the menu key  to enter the main menu.

Labels at the bottom corners of the display show the current soft key functions. Press the left soft key  or right soft key  to perform the indicated function.

Notes:

- Your home screen may appear different than shown. For example, the menu feature icons normally are hidden to allow a better view of the wallpaper image. You can still select the menu icons when they are hidden from view. To show or hide menu icons, see page 78.
- Your phone can display an analog or digital clock in the home screen (see page 77).
- Your phone's display normally is visible only when the display backlight is on, or when the display is viewed in direct sunlight. To extend battery life, the backlight turns off automatically when no activity is detected for a period of time. The backlight turns back on when you open the flip or press any key. To set the time that the backlight stays on, see page 59.
- To further extend battery life, you can set the display to turn off, in addition to the backlight, after a period of inactivity. The display turns back on when you open the flip or press any key. To set the time that the display stays on, see page 59.



The following status indicators can display:

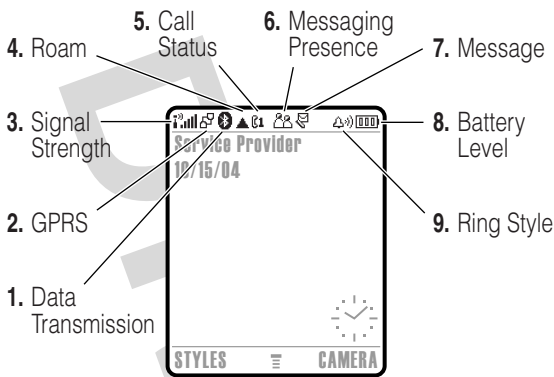



1. Data Transmission Indicator – Show connection and data transmission status. The Bluetooth[®] wireless connection indicator  shows when a Bluetooth connection is active. Other indicators can include:

 = secure packet data transfer

 = unsecure packet data transfer

 = secure application connection

 = unsecure application connection

 = secure *Circuit Switch Data* (CSD) call

 = unsecure CSD call





2. GPRS Indicator – Shows that your phone is using a high-speed *General Packet Radio Service* (GPRS) network connection. GPRS allows faster data transfer speeds. Other

indicators can include:

 = GPRS PDP context active

 = GPRS packet data available

3. Signal Strength Indicator – Vertical bars show the strength of the network connection. You cannot make or receive calls when the no signal indicator  or no transmit indicator  is displayed.



4. Roam Indicator – The roam indicator  shows when your phone is seeking or using another network outside your home network.





5. Call Status Indicator – Shows the call status of your phone. For dual-line-enabled SIM cards, shows the current active phone line. Indicators can include:

 = phone in call

 = call forward on

 = line 1 active

 = line 2 active

 = line 1 active, call forward on

 = line 2 active, call forward on

When you activate an alarm, the active alarm indicator  displays in this location.





6. Messaging Presence Indicator – Shows when instant messaging is active. Indicators can include:

 = IM active

 = available for IM

 = busy

 = invisible to IM

 = available for phone calls

 = offline

When a Java™ application is active, the Java midlet indicator  displays in this location.



7. Message Indicator – Displays when you receive a new message. Indicators can include:

 = text message

 = voicemail message

 = voicemail and text message

 = IM message

 = active chat session

8. Battery Level Indicator – Vertical bars show the battery charge level. Recharge the battery when **Low Battery** displays and the battery alert sounds.

9. Ring Style Indicator – Shows the ring style setting.

 = loud ring



 = soft ring

 = vibrate

 = vibrate and ring

 = silent

Using the 5-Way Navigation Key

Press the 5-way navigation key  up, down, left, or right to scroll through the menu system, highlight menu items, change feature settings, and play games. Press the *center select* key  in the center of the 5-way navigation key to select a highlighted menu item. The center select key usually performs the same function as the right soft key .



Using the Operator Key

From the home screen, press the operator key  to go to your service provider's portal site to access customized content and services.

If a portal site is not available, pressing the operator key launches the micro-browser.

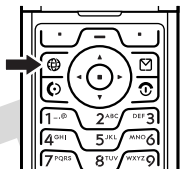

Using the Message Key

From the home screen, press the message key  to go to the message center. From the

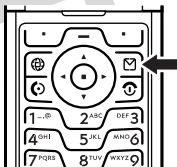



message center, you can send a message and read messages you have received.



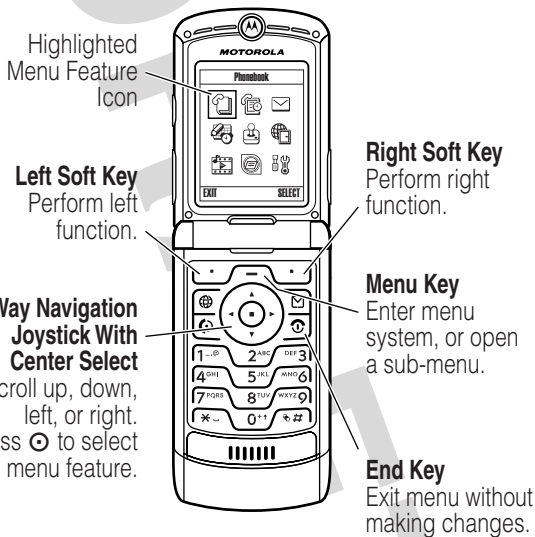







Using Menus

From the home screen, press  to enter the main menu.



Press  to scroll to and highlight a menu feature icon in the main menu. Press **SELECT** () or  to select the highlighted menu feature.

The following icons represent features that may display in the main menu, depending on your service provider and service subscription options.

Menu Icon	Feature	Menu Icon	Feature
	Phonebook		Recent Calls
	Messages		Office Tools
	Games & Apps		Web Access
	Multimedia		IM
	Settings		Chat



Selecting a Feature Option

Some features require you to select an option from a list:

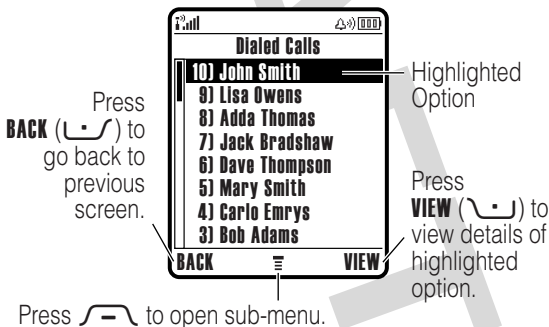

- Press (↑/↓) to scroll up or down to highlight the option you want.

- In a numbered list, press a number key to highlight the option.
- In an alphabetized list, press a key repeatedly to cycle through the letters on the key and highlight the closest matching list option.
- When an option has a list of possible values, press  left or right to scroll through and select a value.
 - When an option has a list of possible numeric values, press a number key to set the value.

Entering Text

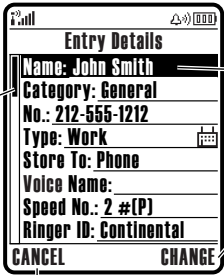

Some features require you to enter information.



Scroll down to bottom of list to view more options.

Highlighted option. Press  to scroll to other options.

Press **CHANGE** () to set or edit highlighted option.

Press **CANCEL** () to exit without making changes. **DONE** () displays when you enter or edit information.

The message center lets you compose and send text messages.

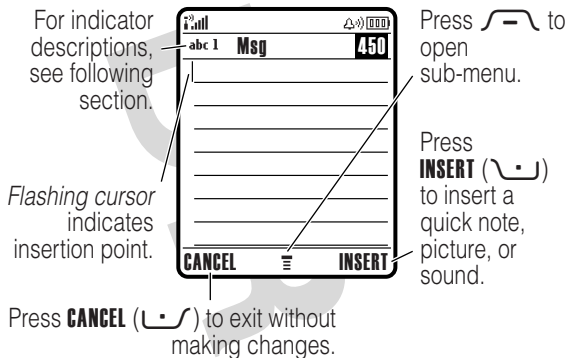

Choosing a Text Entry Mode

Multiple text entry modes make it easy for you to enter names, numbers, and messages. The mode you select remains active until you select another mode.

Press **⏏** in a text entry screen to select one of the following entry modes:

- | | |
|------------------|--|
| Primary | Your primary text entry mode (see below to set). |
| Numeric | Enter numbers only (see page 43). |
| Symbol | Enter symbols only (see page 44). |
| Secondary | Your secondary text entry mode (see below to set). |



Alternatively, you can select a text entry mode in any text entry screen by pressing $\sqrt{-}$ > **Entry Mode**.

Setting Primary and Secondary Text Entry Modes

You can set different primary and secondary text entry modes, and easily switch between modes as needed when you enter data or compose a message.

Press $\sqrt{-}$ > **Entry Setup** in a text entry screen. Select **Primary Setup** or **Secondary Setup**, and choose:

- | | |
|---------------------|--|
| iTAP | iTAP [®] software predicts each word as you enter it, to simplify and speed up text entry. |
| Tap | Enter individual letters and numbers by pressing a key one or more times. |
| Tap Extended | Enter individual letters, numbers, and symbols by pressing a key one or more times. |
| None | Hide the Secondary setting if you prefer not to set a secondary text entry mode (only available for Secondary Setup). |

Using Capitalization

Press $\sqrt{0^{++}}$ in a text entry screen to change text case. Indicators at the top of the display show the capitalization setting:

abc = no capital letters

ABC = all capital letters

Abc = capitalize next
letter only

Text Entry Mode Indicators

In **Primary** or **Secondary** text entry mode, indicators at the top of the display show the text entry setting:

Primary	Secondary	
1	2	Tap, no capital letters
1↑	2↑	Tap, capitalize next letter only
1↑	2↑	Tap, all capital letters
		iTAP, no capital letters
		iTAP, capitalize next letter only
		iTAP, all capital letters

The following indicators identify **Numeric** or **Symbol** entry mode:

123 = numeric mode

@ = symbol mode

Using iTAP[®] Mode

iTAP mode lets you enter words using one keypress per letter. The iTAP software combines your keypresses into common words, and predicts each word as you enter it.



For example, to type “the,” you would press

. The iTAP software recognizes that the most common word formed by this keypress combination is “the,” and predicts that “the” is the word you are spelling. Other common words or word fragments that can be spelled by the same keypress combination are presented as alternate choices at the bottom of the display.



If necessary, press $\sqrt{* \#}$ in a text entry screen to switch to **ITAP** mode. An indicator tells you which mode is active (see page 37). If **ITAP** mode is not set as the **Primary** or **Secondary** entry mode, see page 36.

Entering Words in iTAP Mode

	Press	To
1	keypad keys (one press per letter)	show possible letter combinations at the bottom of the display
2	 left or right	highlight the combination you want
3	 up	accept the predicted word completion
	or	
	$\sqrt{* \#}$	enter the highlighted combination, followed by a space
	or	
	SELECT ()	select the highlighted combination
		You can press keypad keys to add more letters at the end of the combination.



For example, if you press **7**^{PQRS} **7**^{PQRS} **6**^{MNO} **4**^{GHI}, your phone displays:

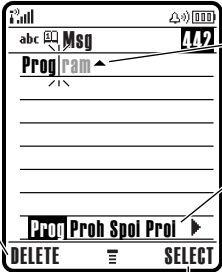

Press **DELETE** (**↶**) to delete last letter.

Press **SELECT** (**↷**) to select highlighted combination with no space.

Press **⬆** up to accept **Program**.

Press ***↵** to enter **Prog** and a space. Press **⬆** right to highlight another combination.

If you want a different word (such as **Progress**), continue pressing keypad keys to enter the remaining characters.

Entering Novel Words in iTAP Mode

You may enter a word that the iTAP software does not recognize. If your word is not shown as a letter combination choice at the bottom of the display:

Action

- 1 Press **DELETE** (**↶**) one or more times to delete letters, until you see a letter combination at the bottom of the display that matches the start of the word you want to enter.
- 2 Press **⬆** left or right to highlight the letter combination.



Action

- 3 Press **SELECT** (⌘) to select the letter combination.
- 4 Continue to enter letters and select letter combinations to spell the word.

Your phone automatically stores the novel word and displays it as an option the next time you enter its letter combination. When the memory space for storing novel words is filled, your phone deletes the oldest words to add new words.



Entering Numbers and Punctuation in iTAP Mode

To enter numbers quickly, press and hold a number key to temporarily switch to numeric mode. Press the number keys to enter the numbers you want. Enter a space to revert to **iTAP** mode.

Press $\sqrt{1\text{--}@\}$ to enter punctuation or other characters as shown in the “Character Chart” on page 43.





Using Tap Mode

This is the basic text entry mode on your phone.

Tap mode cycles through the letters and number of the key you press. **Tap Extended** mode also cycles through additional symbols as shown in the “Character Chart” on page 43.



If necessary, press $\sqrt{*#\}$ in a text entry screen to switch to **Tap** mode. An indicator shows which mode is active (see page 37). If **Tap** or **Tap Extended** is not set as the **Primary** or **Secondary** entry mode, see page 36.

Tap Mode Text Entry Rules

- Press a keypad key repeatedly to cycle through its characters. For example, you would press  one time to enter “a,” two times to enter “b,” three times to enter “c,” or four times to enter “2.”
- After 2 seconds, Tap mode accepts the character, and the cursor moves to the next position.
- The first character of every sentence is capitalized. If necessary, press  down to change the character to lowercase before the cursor moves to the next position.
- Press  to move the flashing cursor to enter or edit message text.
- If you do not want to save your text or text edits, press  to exit without saving.



Entering Words in Tap Mode

Press	To
1 a keypad key one or more times	enter a letter, number, or symbol
2 keypad keys	enter remaining characters
	Tip: Press  right to accept a word completion, or  to insert a space.
3 OK ()	store the text

For example, if you press **8^{TUV}** one time, your phone displays:

Character displays at insertion point.

Press **DELETE** (**↵**) to delete last character entered.

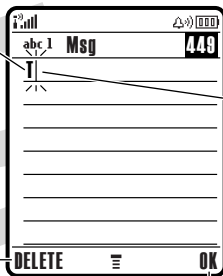

After 2 seconds, character is accepted and cursor moves to next position.

Press **OK** (**↵**) to accept and store text.

When you enter 3 or more characters in a row, your phone may guess the rest of the word. For example, if you enter **prog** your phone might display:

Press **⊙** right to accept **program**. Press ***↵** to reject it and enter a space after **prog**.

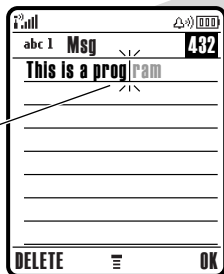

To enter a different word (such as **progress**), press keys to enter remaining characters.

Character Chart

Use this chart as a guide for entering characters with **Tap Extended** mode.

	. 1 ? ! , @ _ & ~ : ; " - () ' ¿ ¡ % £ \$ ¥ ¤ € + x * / \ [] = > < # §
	a b c 2 ä å á à â ã α β ç
	d e f 3 δ ë é è ê φ
	g h i 4 ï í î γ
	j k l 5 λ
	m n o 6 ñ ö ø ó ò ô õ ω
	p q r s 7 π β σ
	t u v 8 θ ü ú ù û
	w x y z 9 ξ ψ
	<i>change text case, for capital letters</i>
	<i>enter a space (hold to enter a return)</i>
	<i>change text entry mode (hold for default)</i>

Note: This chart may not reflect the exact character set available on your phone. In an email or Web address editor, first shows common characters for that editor.

Using Numeric Mode

In a text entry screen, press to switch entry modes until the numeric indicator 123 displays.





Press the number keys to enter the numbers you want. When you finish entering numbers, press $\sqrt{[*\#]}$ to switch to another entry mode.

Using Symbol Mode

In a text entry screen, press $\sqrt{[*\#]}$ to switch entry modes until the symbol indicator @ displays.



Press	To
1 keypad keys (one press per symbol)	show possible symbol combinations at the bottom of the display
2  left or right	highlight the combination you want
3 SELECT ()	select the highlighted combination
	You can press keypad keys to add more symbols to the end of the combination.
or	
	enter the highlighted combination

Symbol Chart

Use this chart as a guide for entering characters with symbol mode.

	. ? ! , @ _ & ~ : ; " - () ' ` ; ¡ % £ \$ ¥ ¤ €
	@ _
	/ : ;
	" & '
	() [] { }
	¿ ¡ ~
	< > =
	\$ £ ¥ ¤ €
	# % *
	+ - x * / = > < # §
	<i>enter a space (hold to enter a return)</i>
	<i>change text entry mode (hold for default)</i>

Note: This chart may not reflect the exact character set available on your phone. In an email or Web address editor, first shows common characters for that editor.

Deleting Letters and Words

Place the cursor to the right of the text you want to delete, and then:

Action

Press **DELETE** () to delete one letter at a time.

Hold **DELETE** () to delete all entered text.



Using the Smart Key

The *smart key* gives you another way to perform many basic phone functions. It anticipates the next action you are likely to perform. For example, when you highlight a menu item, you can press the smart key to select it. You can use the smart key to make and end calls, turn features on and off, and open your phonebook. The smart key usually performs the same function as the right soft key .

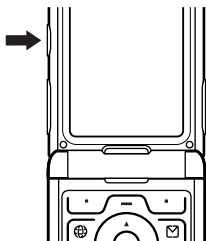

Using the External Display

When the flip is closed, the external display shows time and phone status information. It also displays messages to notify you of incoming calls and other events. You can perform the following functions in the external display.

Setting Phone Ring Style

Press	To
1 volume key	select Ring Styles
2 smart key	set a ring style
3 volume key	return to the home screen

Returning an Unanswered Call

Your phone keeps a record of your unanswered calls and displays **X Missed Calls** in the external display.

Action

- 1 Press the smart key to view the received calls list.

or

Press the volume key to dismiss the **Missed Calls** message.

- 2 If necessary, press the volume key to scroll through the list and highlight an unanswered call.

- 3 Press and hold the smart key to call the number.

or

Press the smart key to exit without calling.

- 4 Open the flip to talk to the other party.

Tip: With a headset or other handsfree device, you can use this feature to return a call without opening the flip.

Using the Handsfree Speaker

When you activate your phone's integrated handsfree speaker, you can talk to the other party without holding the phone to your ear.

Press **SPEAKER** (📞) to turn the handsfree speaker on or off during a call.



When you turn the handsfree speaker on, your phone displays **Spkrphone On** in the home screen. The handsfree speaker remains on until you press **SPEAKER** (🔊) again or end the call.

Note: The handsfree speaker is disabled when you connect your phone to a handsfree car kit or headset accessory.

Changing a Code, PIN, or Password

Your phone's 4-digit unlock code is originally set to 1234, and the 6-digit security code is originally set to 000000. Your service provider may reset these codes before you receive your phone.

If your service provider has **not** reset these codes, we recommend that you change them to prevent others from accessing your personal information. The unlock code must contain 4 digits, and the security code must contain 6 digits.

You can also reset your SIM card PIN code, PIN2 code, and/or call barring password if necessary.

To change a code or password:

Find the Feature

☰ > **Settings** > **Security**
> **New Passwords**

Locking and Unlocking Your Phone

You can lock your phone manually or set the phone to lock automatically whenever you turn it off.

To use a locked phone, you must enter the unlock code. A locked phone still rings or vibrates for incoming calls or messages, **but you must unlock it to answer.**

You can make emergency calls on your phone even when it is locked (see page 67).

Locking Your Phone Manually

Find the Feature

 > Settings > Security
> Phone Lock > Lock Now

Press	To
1 keypad keys	enter your unlock code
2 OK (↵)	lock the phone

Unlocking Your Phone

Tip: Your phone's unlock code is originally set to 1234. Your service provider may reset the unlock code to the last 4 digits of your phone number.

At the **Enter Unlock Code** prompt:

Press	To
1 keypad keys	enter your unlock code
2 OK (↵)	unlock your phone



Setting Your Phone to Lock Automatically

You can set your phone to lock every time you turn it off:

Find the Feature



 > Settings > Security
> Phone Lock
> Automatic Lock > On

Press	To
1 keypad keys	enter your unlock code
2 OK ()	activate automatic lock

If You Forget a Code, PIN, or Password

Note: Your phone's 4-digit unlock code is originally set to 1234, and the 6-digit security code is originally set to 000000. Your service provider may reset the unlock code to the last 4 digits of your phone number before you receive your phone.

If you forget your unlock code, try entering 1234 or the last 4 digits of your phone number. If that does not work, do the following at the **Enter Unlock Code** prompt:

Press	To
1 	display the unlock code bypass screen
2 keypad keys	enter your security code
3 OK ()	submit your security code

If you forget your security code, SIM card PIN code, PIN2 code, or call barring password, contact your service provider.

Using the Phonebook

This section describes basic phonebook operations. For more information about using the phonebook, see page 74 and the *More Here* guide (described on page 8).

Storing a Phone Number

Enter a phone number in the home screen, then press **STORE** () to create a phonebook entry with that number. Fill in the other fields to complete the entry.

Select **MORE** to store another number (for example, a work number) for the same **Name**.

Recording a Voice Name

When creating a phonebook entry, scroll to **Voice Name** and press **RECORD** (). Press and release the voice key and say the entry's name (within 2 seconds). When prompted, press and release the voice key and repeat the name.

Note: This option is not available for entries stored on the SIM card.

Dialing a Number

Press $\sqrt{\quad}$ > **Phonebook**, highlight the phonebook entry, press \odot to call.





Voice Dialing a Number

Press and release the voice key, and say the entry's name (within 2 seconds).

Sorting Phonebook Entries

Press $\sqrt{-}$ > **Phonebook**, press $\sqrt{-}$ > **Setup** > **Sort by**, then select whether you want to sort the phonebook list by **Name**, **Speed No.**, **Voice Name**, or **Email**.

When sorting by name, you can view **All** numbers or just the **Primary** number for each name. To set the primary number for a name, see page 76.

Tip: In **Primary** number view mode, highlight a name and press \odot left or right to view other numbers associated with the name.

Setting a Picture ID for a Phonebook Entry

Press $\sqrt{-}$ > **Phonebook** > *entry*, press $\sqrt{-}$ > **Edit** > **Picture** > *picture name*.

Also see pages 2 and 17.

Setting Picture ID View

Press $\sqrt{-}$ > **Phonebook**, press $\sqrt{-}$ > **Setup** > **View by** > **Picture**.

Viewing Entries By Category

Press $\sqrt{-}$ > **Phonebook**, press $\sqrt{-}$ > **Categories**, then select whether you want to view **All** entries, entries in a predefined category (**Business**, **Personal**, **General**, **VIPs**), or entries in a category you created.

To set the category for a phonebook entry, see page 75.

DRAFT



Setting Up Your Phone

Setting a Ring Style

Your phone rings or vibrates to notify you of an incoming call or other event. This ring or vibration is called an *alert*.

You can select one of 5 different ring styles. The ring style indicator in the display shows the current ring style (see page 30).

To set a ring style:

Find the Feature  > **Settings** > **Ring Styles**
> **Style** > *style name*

Each ring style has settings for specific event alerts, ringer ID, and ringer and keypad volume. To change these settings, press  > **Settings** > **Ring Styles** > *Style Detail*.

Setting the Time and Date









You must set the time and date to use the datebook.

Find the Feature  > **Settings** > **Initial Setup**
> **Time and Date**

Setting a Wallpaper Image

Set a photo, picture, or animation as a wallpaper (background) image in your phone's home screen. The wallpaper image appears as a faint watermark in text and menu displays.

Find the Feature  > **Settings** > **Personalize**
> **Wallpaper**

Press	To
1 	scroll to Picture
2 CHANGE (	open the picture viewer
3 	scroll to a picture/animation Scroll to (None) to turn off the wallpaper image.
4 SELECT (	select the image
5 	scroll to Layout
6 CHANGE (	adjust the image layout
7 	scroll to Center , Tile , or Fit-to-screen Center places the image in the center of the display. Tile fills the display with adjacent copies of the image. Fit-to-screen resizes the image, if necessary, to fit the display.
8 SELECT (	confirm the layout setting
9 BACK (	save wallpaper settings











Setting a Screen Saver Image

Set a photo, picture, or animation as a screen saver image. The screen saver image displays when the flip is open and no activity is detected for a period of time. If necessary, the image shrinks to fill the display. An animation repeats for 1 minute, then the first frame of the animation displays.

Tip: Turn off the screen saver to extend battery life.

Find the Feature  > **Settings** > **Personalize**
> **Screen Saver**

	Press	To
1		scroll to Picture
2	CHANGE ()	open the picture viewer
3	 up or down	scroll to a picture/animation Scroll to (None) to turn off the screen saver image.
4	SELECT ()	select the image
5		scroll to Delay
6	CHANGE ()	set the delay interval
7		scroll to the inactivity interval that starts the screen saver
8	SELECT ()	select the inactivity interval
9	BACK ()	save screen saver settings



Changing Phone Skin

Change the look and feel of your phone's user interface by selecting a different skin setting.

Find the Feature

 > Settings > Personalize
> Skin > skin

Your phone displays the new skin.

Setting a Phone Theme

A *phone theme* consists of a bundled set of image and sound files with a specific theme (such as a special event or cartoon character) that you can apply collectively to your phone. Phone themes typically include a wallpaper image, screen saver image, and ring tone. Your phone includes several preloaded themes. You can download and install additional themes on your phone.

Downloading a Theme

To download a theme from a Web page with the micro-browser, see page 90. When you install the theme, you can instantly apply its screen saver, wallpaper, and ring tone when your phone prompts you to **Apply Theme Now?**

Selecting a Theme

You can apply any of the themes installed on your phone.

Note: If one of a theme's components is not available, then a default setting is applied.

Find the Feature

 > Multimedia > Themes
> theme





Deleting a Theme



You cannot delete the preloaded themes on your phone. To delete one or all of the themes that you have downloaded and installed:

Find the Feature  > Multimedia > Themes > theme

Press	To
1 	open the Theme menu
2 	scroll to Delete or Delete All
3 SELECT ()	select the option





Setting Answer Options

You can use additional, alternative methods to answer an incoming call.

Multi-Key answer by pressing any key
Open to Answer answer by opening the flip

To activate or deactivate an answer option:

Find the Feature  > Settings > In-Call Setup > Answer Options

Press	To
1 	scroll to Multi-Key or Open to Answer
2 CHANGE ()	select the option
3 	scroll to On or Off
4 SELECT ()	confirm the setting

Setting Display Brightness

Find the Feature

 > Settings > Initial Setup
> Brightness

Adjusting the Backlight

Set the amount of time that the display backlight remains on.

Find the Feature

 > Settings > Initial Setup
> Backlight

Note: Your phone's display normally is visible only when the display backlight is on, or when the display is viewed in direct sunlight. To extend battery life, the backlight turns off automatically when no activity is detected for a period of time. The backlight turns back on when you open the flip or press any key.

Setting Display Timeout

To further extend battery life, you can set the display to turn off (in addition to the backlight) when no activity is detected for a period of time.

Find the Feature

 > Settings > Initial Setup
> Display Timeout

You can set the display to stay on for 1 or 2 minutes, or set **Off** to disable display timeout.

Note: The display turns back on when you open the flip or press any key.



Storing Your Name and Phone Number



To store or edit your name and phone number information on your SIM card:

Find the Feature

 > **Settings** > **Phone Status**
> **My Tel. Numbers**

Shortcut: Press   from the home screen to view and edit your name and phone number(s).

If you do not know your phone number, contact your service provider.



Calling Features

For basic instructions on how to make and answer calls, see page 15.

Turning Off a Call Alert

You can turn off your phone's incoming call alert before answering the call.

Action

- 1 Press the volume key to turn off the alert.
- 2 Open the flip (or press the button on a handsfree headset) to answer the call.

Viewing Recent Calls

Your phone keeps lists of incoming and outgoing calls, even for calls that did not connect. The most recent calls are listed first. The oldest calls are deleted as new calls are added.



Shortcut: Press  from the home screen to view the dialed calls list.

Find the Feature





 > Recent Calls

Press

To

- 1  scroll to **Received Calls** or **Dialed Calls**
- 2 **SELECT** () select the list





Press	To
3 	scroll to an entry Note: ✓ means the call connected.
4 	call the entry's number
or VIEW 	view entry details (such as time and date of call)
or 	open the Last Calls Menu to perform other procedures

The **Last Calls Menu** can include the following options:

Option	Description
Store	Create a phonebook entry with the number in the No. field.
Delete	Delete the entry.
Delete All	Delete all entries in the list.
Hide ID/Show ID	Hide or show your caller ID for the next call.
Send Message	Open a new text message with the number in the To field.
Add Digits	Add digits after the number.
Attach Number	Attach a number from the phonebook or recent calls lists.

Option	Description
Send Tones	Send the number to the network as DTMF tones. Note: This option displays only during a call.
Talk then Fax	Talk and then send a fax in the same call (see page 85). 



Redialing a Number

Press	To
1 	view the dialed calls list
2 	scroll to the entry you want to call
3 	redial the number

Using Automatic Redial



When you receive a busy signal, your phone displays **Call Failed, Number Busy**.

Press	To
 or RETRY ()	redial the number



When the call goes through, your phone rings or vibrates one time, displays **Redial Successful**, and connects the call.



Returning an Unanswered Call

Your phone keeps a record of your unanswered calls, and displays:

- the missed call indicator 
- **X Missed Calls**, where X is the number of missed calls

	Press	To
1	VIEW ()	display the received calls list
2		select a call to return
3		make the call

Using the Notepad

The most recent set of digits entered on the keypad are stored in your phone's *notepad* memory. This can be a phone number that you called, or a number that you jot down during a call, for later use. To retrieve the number stored in the notepad:

Find the Feature

 > **Recent Calls** > **Notepad**



Press

To



call the number

or

STORE ()

create a phonebook entry
with the number in the **No.** field

or



open the **Dialing Menu** to attach
a number or insert a special
character

Putting a Call On Hold or Mute

Press

To

 > **Hold**

put all active calls on
hold

or

 > **Mute**





mute all active calls

Using Call Waiting



When you are on a call, an alert tone sounds
to indicate that you have received a second call.



Press	To
1 	answer the new call
2 SWITCH ()	switch between calls
or	
LINK ()	connect the 2 calls
or	
 > End Call On Hold	end the call on hold

If necessary, you must turn on call waiting to use the feature. To turn call waiting on or off:

Find the Feature

 > Settings > In-Call Setup
> Call Waiting

Using Caller ID (Incoming Calls)



Calling line identification (caller ID) displays the phone number for incoming calls in your phone's external and internal displays.

The phone displays the caller's name (and picture ID, if available) when the name is stored in your phonebook, or **Incoming Call** when caller ID information is not available.

You can also set your phone to play a distinctive ringer ID for specific entries stored in your phonebook. For more information, see page 74.

Calling an Emergency Number

Your service provider programs one or more emergency phone numbers, such as 911 or 112, that you can call under any circumstances, even when your phone is locked or the SIM card is not inserted.

Note: Emergency numbers vary by country. Your phone's preprogrammed emergency number(s) may not work in all locations, and sometimes an emergency call cannot be placed due to network, environmental, or interference issues.

Press	To
1 keypad keys	dial the emergency number
2 	call the emergency number

Dialing International Numbers

Press and hold  to insert the local international access code (+) for the country from which you are calling. (Inserting + enables your phone to make an international call.) Then press the keypad keys as usual to dial the country code and phone number.

Calling With 1-Touch Dial

To call phonebook entries 1 through 9, press and hold the single-digit speed dial number for one second.

Tip: You must specify which phone number list you want to use with this feature: phone memory phonebook, or SIM card phonebook (see page 76).



Using Voicemail



Voicemail messages that you receive are stored on the network. To listen to your messages, you must call your voicemail phone number.

Note: Your service provider may include additional information about using this feature.

Listening to Voicemail Messages

Find the Feature

✉ > Voicemail

The phone calls your voicemail phone number. If no voicemail number is stored, your phone prompts you to store a number.

Receiving a Voicemail Message

When you receive a voicemail message, your phone displays the voicemail message indicator  and the **New Voicemail** notification.

Press	To
CALL (📞)	listen to the message

The phone calls your voicemail phone number. If no voicemail number is stored, your phone prompts you to store a number.



Storing Your Voicemail Number

If necessary, use the following procedure to store your voicemail phone number on your phone. Usually, your service provider has already done this for you.

Find the Feature

  > Voicemail Setup

Press	To
1 keypad keys	enter your voicemail number
2 OK ()	store the number

Note: You cannot store a **p** (pause), **w** (wait), or **n** (number) character in this number. If you want to store a voicemail number with these characters, create a phonebook entry for it. Then, you can use the entry to call your voicemail. For more about these characters, see the *More Here* guide.

Changing the Active Line



Change the active phone line to make and receive calls from your other phone number.

Note: This feature is available only for dual-line-enabled SIM cards.

Find the Feature

 > **Settings** > **Phone Status**
> **Active Line**

The call status indicator in the display shows the currently active phone line (see page 29).



Phone Features

Main Menu

This is the standard main menu layout. **Menu organization and feature names may vary on your phone.** Not all features may be available on your phone.

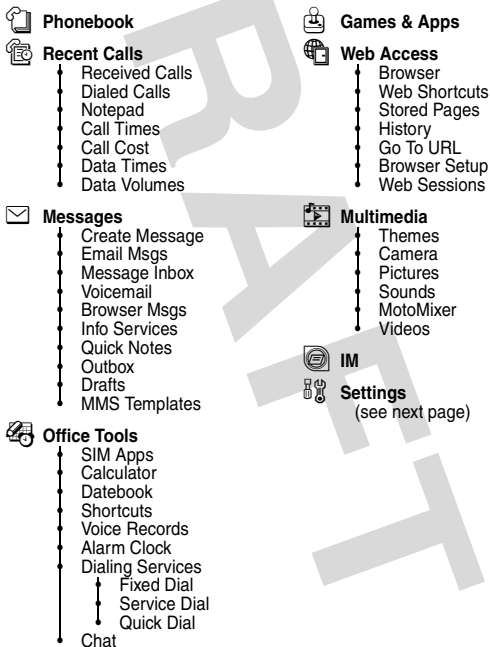

Settings Menu



Personalize

- Home Screen
- Main Menu
- Skin
- Greeting
- Wallpaper
- Screen Saver
- Quick Dial



Ring Styles

- Style
- Style Detail



Connection

- Bluetooth Link
- Sync



Call Forward

- Voice Calls
- Fax Calls
- Data Calls
- Cancel All
- Forward Status



In-Call Setup

- In-Call Timer
- Call Cost Setup
- My Caller ID
- Talk and Fax
- Answer Options
- Call Waiting



Initial Setup

- Time and Date
- 1-Touch Dial
- Display Timeout
- Backlight
- TTY Setup
- Scroll
- Language
- Brightness
- DTMF
- Master Reset
- Master Clear



Phone Status

- My Tel. Numbers
- Credit Info/Available
- Active Line
- Battery Meter
- Other Information



Headset

- Auto Answer
- Voice Dial



Car Settings

- Auto Answer
- Auto Handsfree
- Power-Off Delay
- Charger Time



Network

- New Network
- Network Setup
- Available Networks
- My Network List
- Service Tone
- Call Drop Tone



Security

- Phone Lock
- Lock Application
- Fixed Dial
- Call Barring
- SIM PIN
- New Passwords
- Certificate Mgmt



Java Settings









- Java App Loader
- Java System
- Delete All Apps
- App Vibration
- App Volume
- App Priority
- App Backlight
- Set Standby App
- DNS IP



Feature Quick Reference













This section helps you locate features on your phone that are not described in this guide. For more detailed information, see the *More Here* guide (described on page 8).

Calling Features

Feature	Description
Conference Call	During a call: Dial next number, press  , press LINK () 
Call Forwarding	Set up or cancel call forwarding:  > Settings > Call Forward 
Call Barring	Restrict outgoing or incoming calls:  > Settings > Security > Call Barring 
TTY Calls	Set up your phone for use with an optional TTY device:  > Settings > Initial Setup > TTY Setup 



Messages







Feature	Description
Send Text Message	Send a text message:  > Create Message > New Short Message 
Send Multimedia Message	Send a multimedia message:  > Create Message > New Multimedia Msg 
Send Letter	Send a multimedia letter:  > Create Message > New Letter 
Use MMS Template	Open an MMS template with preloaded media:  > Create Message > MMS Templates 
Read New Message	Read a new text or multimedia message that you have received: Press READ () when the New Message notification is displayed. 
Received Messages	Read received messages:  > Message Inbox Tip: Press  to perform various operations on the message. 



Feature	Description
Store Message Objects	Go to a multimedia message page, or highlight an object in a letter, then:  > Store



Phonebook

Feature	Description
Add New Entry	Add a new entry to the phonebook:  > Phonebook  > New > Phone Number or Email Address
Dial Number	Call a number stored in the phonebook:  > Phonebook , highlight the phonebook entry, press  to call
Voice Dial Number	Voice dial a number stored in the phonebook: Press and release the voice key, and say the entry's name (within 2 seconds).
Set Ringer ID for Entry	Assign a distinctive ringer alert to a phonebook entry:  > Phonebook > <i>entry</i>  > Edit > Ringer ID > <i>ringer name</i> Note: The Ringer ID option is not available for entries stored on the SIM card.



Feature	Description
Set Picture ID for Entry	Assign a photo or picture to a phonebook entry: ↶ > Phonebook > <i>entry</i> ↶ > Edit > Picture > <i>picture name</i> Note: The Picture option is not available for entries stored on the SIM card.
Set Picture ID View	View phonebook entries as text list, or with picture caller ID photos: ↶ > Phonebook ↶ > Setup > View by > <i>view name</i>
Set Category for Entry	Set the category for a phonebook entry: ↶ > Phonebook > <i>entry</i> ↶ > Edit > Category > <i>category name</i> Note: The Category option is not available for entries stored on the SIM card.
Set Category View	Set a phonebook category view: ↶ > Phonebook ↶ > Categories > <i>category view</i>
Sort Phonebook List	Set the order in which phonebook entries are listed: ↶ > Phonebook ↶ > Setup > Sort by > <i>sort order</i>







Feature	Description
Set Primary Number	Set the primary number for a phonebook entry with multiple numbers: ↵ > Phonebook , highlight the entry, press ↵ > Set Primary > <i>phone number</i> .
Copy Phonebook Entry	Copy a phonebook entry between the phone and SIM card: ↵ > Phonebook , highlight the entry, press ↵ > Copy > Entries > To
Send Phonebook Entry to Another Device	Send a phonebook entry to another phone, computer, or device: ↵ > Phonebook , highlight the entry, press ↵ > Send > Bluetooth
1-Touch Dial	Set 1-touch dial to call entries stored in your phone memory phonebook or the SIM card phonebook: ↵ > Settings > Initial Setup > 1-Touch Dial
Create Group Mailing List	Create a group mailing list as a phonebook entry: ↵ > Phonebook ↵ > New > Mailing List

Personalizing Features

Feature	Description
Ring Style	Change the ring alert for an event: ☞ > Settings > Ring Styles > Style Detail > <i>event name</i>
Ringer IDs	Activate distinctive ring alerts assigned to phonebook entries: ☞ > Settings > Ring Styles > Style Detail > Ringer IDs
Ring Volume	Set ringer volume: ☞ > Settings > Ring Styles > Style Detail > Ring Volume
Keypad Volume	Set keypad keypress volume: ☞ > Settings > Ring Styles > Style Detail > Key Volume
Reminders	Set reminder alerts for messages that you receive: ☞ > Settings > Ring Styles > Style Detail > Reminders
Clock View	Display an analog clock or digital time readout in the home screen: ☞ > Settings > Personalize > Home Screen > Clock
Menu View	Display the main menu as graphic icons or as a text-based list: ☞ > Settings > Personalize > Main Menu > View



Feature	Description
Main Menu	Reorder your phone's main menu:  > Settings > Personalize > Main Menu > Reorder
Show or Hide Menu Icons	Show or hide menu feature icons in the home screen:  > Settings > Personalize > Home Screen > Home Keys > Icons
Change Soft Keys & Menu Icons	Change soft key labels and menu feature icons in the home screen:  > Settings > Personalize > Home Screen > Home Keys
Shortcuts	Create a shortcut to a menu item: Highlight the menu item, then press and hold  . Use a shortcut: Press  , then press the shortcut number.

Instant Messaging

Feature	Description
Log In	Log in to instant messaging:  > IM > Log In
Find Others Online	After you sign on: Select Contact List to see a list of other users.



Feature	Description
Start Conversation	Start a conversation: From your Contact List , highlight a name in Online Contacts , press SEND IM (📞).
Open Active Conversation	Open a conversation in progress: From your Contact List , highlight a name in Conversations , press VIEW (📞).
End Conversation	From the conversation display: 📞 > End Conversation
Log Out	Log out of instant messaging: Select Log Out from the IM Online menu.

Chat

Feature	Description
Start Chat	Start a new chat session: 📞 > Office Tools > Chat 📞 > New Chat
Receive Chat Request	When you receive a chat request: Press ACCEPT (📞) or IGNORE (📞).





Feature	Description
End Chat	During a chat session:  > End Chat 

Email



Feature	Description
Send Email Message	Send an email message:  > Messages > Create Message > New Email 
Read Email Message	Read a new email message that you have received: Press READ (). 

Menu Features



Feature	Description
Language	Set menu language:  > Settings > Initial Setup > Language
Master Reset	Reset all options <i>except</i> unlock code, security code, and lifetime timer:  > Settings > Initial Setup > Master Reset

Feature	Description
Master Clear	<p>Reset all options <i>except</i> unlock code, security code, and lifetime timer, and clear all user settings and entries <i>except</i> SIM card information:</p> <p> > Settings > Initial Setup > Master Clear</p> <p>Caution: Master clear erases all user-downloaded content (including photos and sounds) and user-entered information (including phonebook and datebook entries) stored in your phone's memory. After you erase the information, you cannot recover it.</p>

Special Dialing Features

Feature	Description
Fixed Dial	<p>Turn fixed dialing on or off:</p> <p> > Settings > Security > Fixed Dial</p> <p>Use the fixed dial list:</p> <p> > Office Tools > Dialing Services > Fixed Dial</p>
Service Dial	<p>Dial service phone numbers:</p> <p> > Office Tools > Dialing Services > Service Dial</p>









Feature	Description
Quick Dial	Dial preprogrammed phone numbers:  > Office Tools > Dialing Services > Quick Dial
DTMF Tones	Activate DTMF tones:  > Settings > Initial Setup > DTMF Send DTMF tones during a call: Press number keys. Send stored numbers as DTMF tones during a call: Highlight a number in the phonebook or recent calls lists, then press  > Send Tones.



Call Monitoring

Network connection time is the elapsed time from the moment you connect to your service provider's network to the moment you end the call by pressing . This time includes busy signals and ringing.



The amount of network connection time you track on your resettable timer may not equal the amount of time for which you are billed by your service provider. For billing information, please contact your service provider directly.

Feature	Description
Call Times	View call timers:  > Recent Calls > Call Times 
In-Call Timer	Display time or cost information during a call:  > Settings > In-Call Setup > In-Call Timer 
Call Cost	View call cost trackers:  > Recent Calls > Call Cost 



Handsfree Features



Note: The use of wireless devices and their accessories may be prohibited or restricted in certain areas. Always obey the laws and regulations on the use of these products.

Feature	Description
Speakerphone	Activate a connected external speakerphone during a call: Press SPEAKER () (if available) or  > Spkrphone On .
Auto Answer (car kit or headset)	Automatically answer calls when connected to a car kit or headset:  > Settings > Car Settings or Headset > Auto Answer
Voice Dial (headset)	Enable voice dial with headset send/end key:  > Settings > Headset > Voice Dial
Auto Handsfree (car kit)	Automatically route calls to a car kit when connected:  > Settings > Car Settings > Auto Handsfree
Power-Off Delay (car kit)	Set the phone to stay on for a specified time after the ignition is switched off:  > Settings > Car Settings > Power-Off Delay

Feature	Description
Charger Time (car kit)	Charge the phone for a specified time after the ignition is switched off:  > Settings > Car Settings > Charger Time

















Data and Fax Calls

Feature	Description
Send Data or Fax	Connect your phone to the device, then place the call through the device application.
Receive Data or Fax	Connect your phone to the device, then answer the call through the device application.
Talk Then Fax	Connect your phone to the device, enter the number, press  > Dialing Menu > Talk Then Fax , then press  to make the call.



Bluetooth® Wireless Connections

Feature	Description	
Make Phone Visible to Other Device	Allow an unknown Bluetooth device to discover your phone:  > Settings > Connection > Bluetooth Link > Setup > Find Me	
Connect to Recognized Device	Connect to a recognized handsfree device:  > Settings > Connection > Bluetooth Link > Handsfree > <i>device name</i>	
Disconnect From Device	Disconnect from a device: Highlight the device name and press DROP ().	
Switch to Device During Call	Switch to a headset or car kit during a call:  > Use Bluetooth	
Copy Multimedia Object to Device	Copy a multimedia object to another device: Highlight the object, press  > Copy , select the device name.	

Feature	Description
Move Multimedia Object to Device	<p>Move a multimedia object to another device: Highlight the object, press  > Move, select the device name.</p> <p>Caution: Moving an object deletes the original object from your phone.</p>
Send Phonebook/Datebook Entry to Device	<p>Copy a phonebook entry, datebook event, or bookmark to another device: Highlight the item, press  > Send > Bluetooth, select the device name.</p>
Edit Device Properties	<p>Edit the properties of a recognized device: Highlight the device name and press  > Edit.</p>
Set Bluetooth Options	<p>Set your phone's Bluetooth options:  > Settings > Connection > Bluetooth Link > Setup</p>







Network Features

Feature	Description
Network Settings	<p>View network information and adjust network settings:  > Settings > Network</p>



Personal Organizer Features



Feature	Description
Set Alarm	Set an alarm: ☰ > Office Tools > Alarm Clock
Turn Off Alarm	Turn off alarm: Press DISABLE (⏏) or ⏸. Set 8-minute delay: Press SNOOZE (⏏).
Add New Datebook Event	Add a new event to the datebook: ☰ > Office Tools > Datebook , highlight the day, press ⏸, press ☰ > New
View Datebook Event	View or edit event details: ☰ > Office Tools > Datebook , highlight the day, press ⏸, press VIEW (⏏)
Event Reminder	View an event reminder: VIEW (⏏) Dismiss an event reminder: EXIT (⏏)
Send Datebook Event to Another Device	Send a datebook event to another phone, computer, or device: ☰ > Office Tools > Datebook , highlight the day, press ⏸, highlight the event, press ☰ > Send > Bluetooth

Feature	Description
Create Voice Record	<p>Create a voice record: Press and hold voice key, speak into the phone, release voice key</p> <p>Note: Recording phone calls is subject to varying state and federal laws regarding privacy and recording of conversations.</p>
Play Voice Record	<p>Play back a voice record:  > Office Tools > Voice Records > <i>voice record</i></p>
Calculator	<p>Calculate numbers:  > Office Tools > Calculator</p>
Currency Converter	<p>Convert currency:  > Office Tools > Calculator  > Exchange Rate</p> <p>Enter exchange rate, press OK () enter amount, press  > Convert Currency.</p>









Security











Feature	Description
SIM PIN	<p>Lock or unlock the SIM card:  > Settings > Security > SIM PIN</p> <p>Caution: If you enter an incorrect PIN code 3 times in a row, your SIM card is disabled and your phone displays SIM Blocked.</p>



Feature	Description
Lock Application	Lock phone applications:  > Settings > Security > Lock Application
Certificate Management	Enable or disable security certificates stored on your phone:  > Settings > Security > Certificate Mgmt

News and Entertainment

Feature	Description	
Launch Micro-Browser	Start a micro-browser session: Press 	
Download Objects from Web Page	Download a picture, sound, or phone theme from a Web page: Highlight the file, press SELECT () , press STORE () .	
Web Sessions	Select or create a Web session:  > Web Access > Web Sessions	
Apply Phone Theme	Apply a grouped set of image and sound files to your phone:  > Multimedia > Themes > <i>theme</i>	

Feature	Description
Download Game or Application (Micro-Browser)	Download a Java™ game or application with the micro-browser:  > Web Access > Browser , highlight the application, press SELECT (⏏), press DOWNLOAD (⏏) 
Download Game or Application (Computer)	Download a Java game or application from a computer: Press  > Settings > Java Settings > Java App Loader , connect your phone to the computer when prompted. 
Launch Game or Application	Launch a Java game or application:  > Games & Apps , highlight the application, press SELECT (⏏) 
Manage Pictures	Manage pictures and animations:  > Multimedia > Pictures 
Manage Sounds	Manage ring tones and music that you have composed or downloaded:  > Multimedia > Sounds
Manage Video Clips	Manage video clips:  > Multimedia > Videos



Feature	Description
Edit Sounds With MotoMixer	Edit MIDI-based songs that you can use with your phone: ⌘ > Multimedia > MotoMixer > [New Mix] or <i>mix file name</i>
Create Ring Tones	Create iMelody ring tones that you can use with your phone: ⌘ > Multimedia > Sounds > [New iMelody]

Specific Absorption Rate Data

The model wireless phone meets the government's requirements for exposure to radio waves.

Your wireless phone is a radio transmitter and receiver. It is designed and manufactured not to exceed limits for exposure to radio frequency (RF) energy set by the Federal Communications Commission (FCC) of the U.S. Government and by the Canadian regulatory authorities. These limits are part of comprehensive guidelines and establish permitted levels of RF energy for the general population. The guidelines are based on standards that were developed by independent scientific organizations through periodic and thorough evaluation of scientific studies. The standards include a substantial safety margin designed to assure the safety of all persons, regardless of age or health.

The exposure standard for wireless mobile phones employs a unit of measurement known as the Specific Absorption Rate, or SAR. The SAR limit set by the FCC and by the Canadian regulatory authorities is 1.6 W/kg.¹ Tests for SAR are conducted using standard operating positions accepted by the FCC and by Industry Canada with the phone transmitting at its highest certified power level in all tested frequency bands. Although the SAR is determined at the highest certified power level, the actual SAR level of the phone while operating can be well below the maximum value. This is because the phone is designed to operate at multiple power levels so as to use only the power required to reach the network. In general, the closer you are to a wireless base station, the lower the power output.

Before a phone model is available for sale to the public in the U.S. and Canada, it must be tested and certified to the FCC and Industry Canada that it does not exceed the limit established by each government for safe exposure. The tests are performed in positions and locations (e.g., at the ear and worn on the body) reported to the FCC and available for review by Industry Canada. The highest SAR value for this model phone when

tested for use at the ear is 0.89 W/kg, and when worn on the body, as described in this user guide, is 0.58 W/kg. The SAR value for this product in its data transmission mode (body-worn use) is 1.24 W/kg. (Body-worn measurements differ among phone models, depending upon available accessories and regulatory requirements).²

While there may be differences between the SAR levels of various phones and at various positions, they all meet the governmental requirements for safe exposure. Please note that improvements to this product model could cause differences in the SAR value for later products; in all cases, products are designed to be within the guidelines.

Additional information on Specific Absorption Rates (SAR) can be found on the Cellular Telecommunications & Internet Association (CTIA) Web site:

<http://www.phonefacts.net>

or the Canadian Wireless Telecommunications Association (CWTA) Web site:

<http://www.cwta.ca>

1. In the United States and Canada, the SAR limit for mobile phones used by the public is 1.6 watts/kg (W/kg) averaged over one gram of tissue. The standard incorporates a substantial margin of safety to give additional protection for the public and to account for any variations in measurements.
2. The SAR information includes the Motorola testing protocol, assessment procedure, and measurement uncertainty range for this product.

Index

A

- accessories 9, 47, 72
- active line indicator 29
- active line, changing 69
- alarm clock 88
- alert
 - creating 92
 - defined 54
 - setting 15, 46, 54, 77
 - turning off 15, 61

animation

- downloading 74, 90
 - screen saver 56
 - viewing 91
 - wallpaper 55
- answering a call 16, 58
- application, locking and
unlocking 90
- automatic redial 63

B

- backlight 59
- barring calls 72
- battery
 - charging 12
 - extending battery life 10,
27, 56, 59

installing 12

level indicator 30

Bluetooth 3, 23, 76, 86, 87,
88

brightness, setting 59

browser. *See* micro-browser

C

calculator 89

call

adding digits after phone
number 62

alert, turning off 15, 61

answer options 58

answering 16

barring 72

barring password,
changing 48

call waiting 65

costs 83

deleting 61

dialed calls list 61

dialing 15

emergency number 67

ending 15, 16

forwarding 72

handsfree speaker 47

hold 65

- international access code
 - 67
- making 15
- received calls list 61
- receiving 16
- recent calls 61
- ring style 15, 46, 54, 77
- speakerphone 84
- storing 61
- talk then fax 63
- timers 83
- unanswered call 47, 64
- Call Failed, Number Busy message 63
- call waiting 65
- caller ID 3, 18, 52, 62, 66, 75
- calling line identification.
See caller ID
- camera
 - self portrait 18
 - taking a photo 2, 17
- car kit 84
- center select key 31
- certificate management 90
- character chart 43
- chat 79
- clock 26, 54
- clock 77
- codes
 - changing 48
 - default 48, 49, 50

- forgetting 50
- conference call 72
- cursor 35
- customizing the menu 77

D

- data call 85
- date, setting 54
- datebook 88
 - sending entries 88
- deleting a call 61
- dialed calls list 61
- dialing a number 15, 81, 82
- display
 - backlight 59
 - brightness 59
 - description 26
 - home screen 26
 - language 80
 - personalizing 78
 - skin 57
 - timeout 59
- distinctive ringer alert 77
- drafts folder 23
- DTMF tones
 - activating 82
 - sending 63, 82

E

- earpiece volume 15
- email 80

reminders, turning on/off
77
emergency number 67
end key 15, 16
ending a call 15, 16
Enter Unlock Code
message 49, 50
external display 46

F

fax call 63, 85
5-way navigation key 31
fixed dial 81
flashing cursor 35
flip
external display 46
open to answer 16, 58
screen saver 56
forwarding calls 72

G

games 91
GPRS indicator 29
groove tunes 92

H

handsfree speaker 47
handsfree use 84
headset
using with external
display 47

headset accessory, using
84
Hide ID feature 62
hold a call 65
home keys, personalizing
78
home screen
clock 77
defined 26

I

IM 78
incoming call
answering 16
forwarding 72
Incoming Call message 66
indicators
active line 29
battery level 30
GPRS 29
Java midlet 30
loud ring style 30
message 30
messaging presence 30
missed call 64
ring style 30
roam 29
signal strength 29
silent alert 30
soft ring style 30
text case 37

- text entry mode 37
- transmission 28
- vibrate alert 30
- vibrate and ring style 30
- voicemail message 30, 68

- instant messaging. *See* IM
- international access code 67

- iTAP software 37

J

- Java applications 91
- Java midlet indicator 30

K

- key

- center select 31
- end 15, 16
- 5-way navigation 31
- left soft key 27, 78
- menu 9
- message 31
- operator 31
- power 14
- right soft key 27, 78
- send 15, 16, 61
- smart 46, 47
- volume control 15

- keypad

- answering calls 58

- volume, setting 77

L

- language, setting 80

- left soft key

- functions 27

- personalizing 78

- line, changing 69

- lock

- application 90

- phone 49

- SIM card 89

- Low Battery message 30

M

- making a call 15

- master clear 81

- master reset 80

- menu

- entering text 34

- icons, changing in home screen 78

- icons, converting to text 77

- icons, described 26

- icons, showing or hiding 78

- language, setting 80

- lists 33

- navigating 32

- personalizing 78

- rearranging features 78
- using features 33
- view, changing 77

menu key 9

message

- chat 79
- draft 23
- menu feature icon 26
- MMS template 73
- MMS, defined 20
- multimedia letter 73
- multimedia message 73
- reading 73
- reminders, turning on/off 77
- text 73

message indicator 30

message key 31

messages menu feature icon 26

messaging presence indicator 30

micro-browser

- browser setup 90
- Java applications 91
- menu feature icon 26
- using 90
- Web sessions 90

missed call indicator 64

Missed Calls message 47, 64

MMS template 73

MMS. *See* message

More Here guide 8

MotoMixer 92

multimedia letter, sending 73

multimedia message sending 3, 20, 73

multimedia messaging service. *See* message

music

- downloading 74, 90
- managing 91

my telephone number 16, 60

N

network settings 87

notepad 64

number

- entering 43
- storing your number 60
- viewing your number 16

O

object exchange 25

1-touch dial

- setting preference 76
- using 67

open to answer 58

operator key 31

optional accessory, defined

9

optional feature, defined 9

P

passwords. *See* codes

phone

active line indicator 29

active line, changing 69

alert, turning off 15, 61

answer options 58

clear stored information

81

codes 48

date, setting 54

flip 16

keypad, answering calls

58

language, setting 80

locking 49

network settings 87

reset all options 80

ring style 15, 46, 54, 77

security code 48

skin 57

time, setting 54

turning off 14

turning on 14

unlock code 48

unlocking 14, 49, 50

phone number

active line indicator 29

active line, changing 69

adding digits after 62

attaching 2 numbers 62

international access code

67

redialing 63

storing in phonebook 74

storing your number 60

viewing your number 16

phone theme 57, 90

phonebook

adding an entry 74

attaching 2 numbers 62

category views 52, 75

copying entries 76

dialing a number 74

entry category 75

group mailing list 76

1-touch dial 67

picture ID 3, 18, 52, 66,

75

primary number, setting

76

ringer ID 74, 77

sending entries 76

sorting entries 52, 75

voice dialing 74

photo

downloading 74, 90

picture ID 3, 18, 52, 66,

75

- self portrait 18
- self-portrait 2
- sending 2, 17
- taking 2, 17
- picture
 - downloading 74, 90
 - screen saver 56
 - viewing 91
 - wallpaper 55
- picture ID 3, 18, 52, 66, 75
- PIN code
 - changing 48
 - entering 89
- PIN2 code, changing 48
- power key 14
- predictive text entry 37
- primary text entry mode 35

Q

- quick dial 82

R

- received calls list 61
- recent calls 61
- redial
 - automatic redial 63
 - busy number 63
- reference guide 8
- reminders
 - turning on/off 77
- right soft key

- functions 27
 - personalizing 78
- ring style indicators 30
- ring style, setting 15, 46, 54, 77
- ring tone
 - creating 92
 - downloading 74, 90
 - editing with MotoMixer 92
 - managing 91
- ringer ID
 - setting 74
 - turning on/off 77
- ringer volume, setting 15, 77
- roam indicator 29

S

- screen saver 56
- secondary text entry mode 35
- security code
 - changing 48
 - default 48
 - forgetting 51
- self-portrait 2
- send key 15, 16, 61
- service dial 81
- shortcuts 78
- Show ID feature 62
- signal strength indicator 29

- silent alert indicator 30
- silent alert, setting 15, 46, 54, 77
- SIM Blocked message 14, 89
- SIM card
 - defined 10
 - installing 10
 - locking 89
 - PIN code entry 14
 - PIN code, changing 48
 - PIN2 code, changing 48
 - precautions 10
 - SIM Blocked message 14, 89
- SIM PIN code
 - changing 48
 - entering 89
- SIM PIN2 code, changing 48
- skin 57
- smart key 46, 47
- soft keys
 - functions 27
 - personalizing 78
- song
 - downloading 74, 90
 - managing 91
- sound
 - downloading 74, 90
 - managing 91
- Speaker On message 48

- speakerphone
 - activating 84
 - automatic answer 84
- standby time, increasing 56, 59
- storing a call 61
- symbol chart 45
- symbols, entering 44

T

- talk then fax call 63
- tap mode text entry 40
- telephone number
 - storing your number 60
 - viewing your number 16
- text
 - capitalization, changing 36
 - character chart 43
 - entering 34
 - entry mode, selecting 35
 - entry mode, setup 36
 - flashing cursor 35
 - iTAP software predictive text entry 37
 - numeric mode 43
 - symbol chart 45
 - symbol mode 44
 - tap mode 40
- text case indicator 37
- text entry mode

- selecting 35
- setup 36
- text entry mode indicator 37
- theme 57, 90
- time, setting 54
- timers 83
- transmission indicator 28
- travel charger 13
- TTY device 72

U

- unlock
 - application 90
 - phone 49
- unlock code
 - bypassing 50
 - changing 48
 - default 48, 49, 50
 - entering 14, 49, 50
 - forgetting 50

V

- vibrate alert
 - setting 15, 46, 54, 77
 - turning off 15, 61
- video clip
 - downloading 74, 90
 - managing 91
- voice dial 74, 84
- voice key
 - dialing a number 74

- voice record 89
- voicemail 68
- voicemail message indicator
 - 30, 68
- volume
 - earpiece 15
 - keypad 77
 - ringer 15, 77
- volume key 15

W

- wallpaper 55
- Web pages 90
- Web sessions 90

DRAFT