

Welcome

Thank you for choosing Motorola—a global leader in communications technology.

All Motorola phones are designed and manufactured in the United States to meet Motorola's exacting specifications and world-class quality standards. During development, our laboratory testing team took the durable Digital StarTAC® phone through its paces. They cooked it, steamed it, shook it, shocked it, dusted it, and dropped it—and the phone still worked! We are confident that the one you purchased will meet your own exacting standards.

Thank you for choosing Motorola, and we hope you enjoy your StarTAC ST7767D cellular phone!

Guide Overview

Okay, you've got a brand new phone with a bunch of nifty features.

Now what?

Afraid you'll press the wrong key?

Or forget a feature or two?

Don't sweat it!



We've designed this guide to take you step-by-step through each feature of your new Digital StarTAC® phone.

We'll show you what key to press and what happens when you press it. Follow along, chapter-by-chapter, and you'll find it's as easy as 1-2-3.

Here's an idea of what you'll learn in each chapter.

Getting Started

First things first. Once the box is open, this section will show you where to begin. We will explain what came with your new phone and show you how to use the battery. Turn to page 10 to get started.

The Basics

What do all those buttons and lights mean? How do I make my first phone call? In this section, we'll answer those questions and teach you everything necessary to start using your Digital StarTAC phone. Begin learning "The Basics" on page 22.

Guide Overview

Using Memory

Read “Using Memory,” beginning on page 36, and we will explain how to make the most of your new phone’s internal Phone Book. You will save time with dialing shortcuts and memory features that make it easy to place quick calls.

Using Messaging

This Digital StarTAC[®] phone supports optional messaging services, like Caller ID^{*}, which allows you to see who is calling before you answer. It can even receive alphanumeric messages just like a pager and tell you when you have Voice Mail. Turn to page 48 to begin “Using Messaging.”

The Works

When you are ready to learn the advanced features of your new phone, turn to page 56 for “The Works.” We will explain everything from navigating the menu system to electronically locking your phone.

So relax!

Let us show you what your Digital StarTAC phone can do!



* Contact your Service Provider for availability.

Introduction

Guide Overview 2
Safety Information 6

Getting Started

Package Content Options 10
Introduction to Batteries 12
Installing Batteries 14
Charging Batteries 16
Phone Overview 20
Using the Smart Button 21

The Basics

Turning Your Phone On 22
Reading the Indicators 24
Placing and Ending Calls 28
Redialing Numbers 29
Receiving Calls 31
Basic Tone Controls 32
Your Phone & Its Shortcuts 34

Using Memory

Introduction 36
Making the Most of Memory 37
Storing 38
Recalling 40
Pause Dialing 44
Using Calling Cards 46

Introduction	48
Receiving Messages	49
Viewing Your Caller IDs	50
Checking Your Voice Mail	52
Reading Your Messages	54

The Works

Introducing the Menu Features.	56
The Internal Phone Book	58
<i>Store and recall numbers</i>	
Using Call Timers	66
<i>Monitor the length of your calls</i>	
Setting Tone Controls.	72
<i>Adjust your phone's tone controls</i>	
Lock/Security Features.	80
<i>Control access to your phone</i>	
Phone Options	88
<i>Personalize your phone's operation</i>	

Reference Information

Accessory Options	106
Troubleshooting.	109
Glossary	111
Index	118

Safety Information

Exposure to Radio Frequency Signals



Your wireless handheld portable telephone is a low power radio transmitter and receiver. When it is ON, it receives and also sends out radio frequency (RF) signals.

In August 1996, the Federal Communications Commissions (FCC) adopted RF exposure guidelines with safety levels for hand-held wireless phones. Those guidelines are consistent with the safety standards previously set by both U.S. and international standards bodies:

- ANSI C95.1 (1992)*
- NCRP Report 86 (1986)*
- ICNIRP (1996)*

Those standards were based on comprehensive and periodic evaluations of the relevant scientific literature. For example, over 120 scientists, engineers, and physicians from universities, government health agencies, and industry reviewed the available body of research to develop the ANSI Standard (C95.1).

The design of your phone complies with the FCC guidelines (and those standards).

Antenna Care

Use only the supplied or an approved replacement antenna. Unauthorized antennas, modifications, or attachments could damage the phone and may violate FCC regulations.

Phone Operation

Normal Position:

Hold the phone as you would any other telephone, with the antenna pointed up and over your shoulder.

Tips on Efficient Operation:

For your phone to operate most efficiently:

- Extend your antenna fully.
- Do not touch the antenna unnecessarily when the phone is in use. Contact with the antenna affects call quality and may cause the phone to operate at a higher power level than otherwise needed.

* American National Standards Institute; National Council on Radiation Protection and Measurements; International Commission on Non-Ionizing Radiation Protection

Safety Information

Caution: All batteries can cause property damage, injury or burns if a conductive material, such as jewelry, keys or beaded chains, touches exposed terminals. The material may complete an electrical circuit and become quite hot. To protect against such unwanted current drain, exercise care in handling any charged battery, particularly when placing it inside your pocket, purse or other container with metal objects. When the battery is detached from the phone: your battery is packed with a protective cover; please use this cover for storing your battery when not in use.

Check the laws and regulations on the use of wireless telephones in the areas where you drive. Always obey them. Also, if using your phone while driving, please:

- Give full attention to driving—driving safely is your first responsibility;
- Use hands-free operation, if available;
- Pull off the road and park before making or answering a call if driving conditions so require.

Most modern electronic equipment is shielded from RF signals. However, certain electronic equipment may not be shielded against the RF signals from your wireless phone.

Pacemakers

The Health Industry Manufacturers Association recommends that a minimum separation of six (6") inches be maintained between a handheld wireless phone and a pacemaker to avoid potential interference with the pacemaker. These recommendations are consistent with the independent research by and recommendations of Wireless Technology Research.

Persons with pacemakers:

- Should ALWAYS keep the phone more than six inches from their pacemaker when the phone is turned ON;
- Should not carry the phone in a breast pocket;
- Should use the ear opposite the pacemaker to minimize the potential for interference.
- If you have any reason to suspect that interference is taking place, turn your phone OFF immediately.

Batteries



Driving



Electronic Devices



Safety Information

Hearing Aids

Some digital wireless phones may interfere with some hearing aids. In the event of such interference, you may want to consult your hearing aid manufacturer to discuss alternatives.

Other Medical Devices

If you use any other personal medical device, consult the manufacturer of your device to determine if they are adequately shielded from external RF energy. Your physician may be able to assist you in obtaining this information.

Turn your phone OFF in health care facilities when any regulations posted in these areas instruct you to do so. Hospitals or health care facilities may be using equipment that could be sensitive to external RF energy.

Vehicles

RF signals may affect improperly installed or inadequately shielded electronic systems in motor vehicles. Check with the manufacturer or its representative regarding your vehicle. You should also consult the manufacturer of any equipment that has been added to your vehicle.



Posted Facilities

Turn your phone OFF in any facility where posted notices so require.

FCC regulations prohibit using your phone while in the air. Switch OFF your phone before boarding an aircraft.

Aircraft



Safety Information

To avoid interfering with blasting operations, turn your phone OFF when in a “blasting area” or in areas posted: “Turn off two-way radio.” Obey all signs and instructions.

Turn your phone OFF when in any area with a potentially explosive atmosphere, and obey all signs and instructions. Sparks in such areas could cause an explosion or fire resulting in bodily injury or even death.

Areas with a potentially explosive atmosphere are often, but not always, clearly marked. They include fueling areas such as gasoline stations; below deck on boats; fuel or chemical transfer or storage facilities; areas where fuel odors are present, i.e. if a gas/propane leak occurs in a car or home; areas where the air contains chemicals or particles, such as grain, dust, or metal powders; and any other area where you would normally be advised to turn off your vehicle engine.

An air bag inflates with great force. DO NOT place objects, including both installed or portable wireless equipment, in the area over the air bag or in the air bag deployment area. If in-vehicle wireless equipment is improperly installed and the air bag inflates, serious injury could result.

Your cellular radiotelephone is designed for excellent durability under normal use conditions. Protect your cellular telephone from water damage that could result from spills or excessive exposure to rain. Never submerge your cellular phone.

Cleaning of this product should only be done with a damp cloth. The use of chemical cleaners may harm the finish and integrity of the radio housing and is not recommended.

Blasting Areas



Potentially Explosive Atmospheres



Vehicles Equipped with Air Bags

Equipment Care

Cleaning the Phone

Getting Started

Package Content Options

The Digital StarTAC® phone comes equipped with a standard battery and an AC Adapter to get you up and running. An exciting line of accessory options, now smaller and lighter than ever, can customize your cellular package for maximum performance and portability.



Digital StarTAC Phone



Slim Main Battery with Battery Cover



Standard Main Battery with Battery Cover

Slim Auxiliary Battery with Battery Cover



Package Content Options



Holster



Cigarette Lighter
Adapter



AC Adapter



Headset

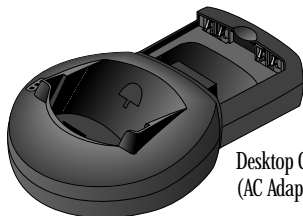

Desktop Charger
(AC Adapter required)

Your phone and accessories may not look exactly as pictured.

Introduction to Batteries

Each battery is shipped in an uncharged state with a protective cover on it. Before you can use your phone, you will need to remove the cover from the battery and charge it.

Battery Covers

It is a good idea to save the protective cover to store and carry the battery when not in use. The cover prevents objects from touching the battery terminals, thereby reducing the risk of injury or damage from a short circuit.

Removing the Main Battery Cover

- 1. Press In Latch** Press in the release latch.
- 2. Remove Battery** Rotate the battery upward and lift it out of the cover.

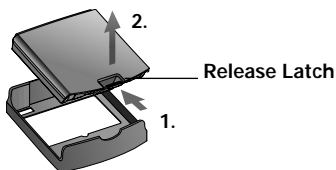

Attaching the Main Battery Cover

- 1. Lower Side** Lower the side, opposite the release latch, into the cover.
- 2. Click Latch** Drop the side with the release latch down until the latch clicks.

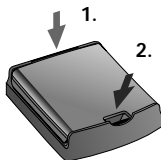

Introduction to Batteries

Removing the Auxiliary Battery Cover

- 1. Dislodge Cover** Hold the auxiliary battery securely with one hand. With your other hand's thumb, push up on the bottom of the cover.
- 2. Remove Battery** Continue to push up until the cover slides free of the pins on the bottom of the battery and swing the cover outward.

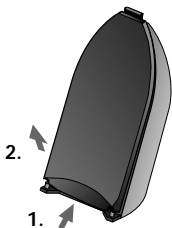

Attaching the Auxiliary Battery Cover

- 1. Insert Point** Slide the cover's narrow end into the small grooved hook on the top of the auxiliary battery.
- 2. Secure Cover** Push the cover firmly so the base slides past the pins on the auxiliary battery, and release.

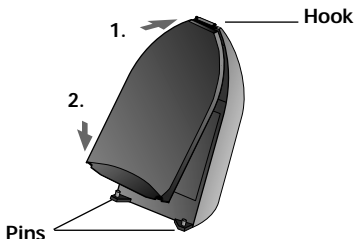

Installing Batteries

Main Battery Installation

To install a battery:

- 1. Insert Toe** Place the side of the battery opposite the release latch into the compartment.

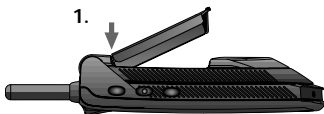

- 2. Snap Heel** Press the side with the release latch down until you hear it click into place.

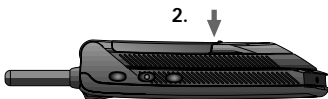

Main Battery Removal

To remove a battery:

- 1. Turn OFF Phone** If another battery is not attached, press and hold  to turn your phone OFF.
- 2. Remove Battery** Pull the release latch back toward the battery and lift the battery out.

Tip:

If you have a charged auxiliary battery attached to your phone, you can remove and change your main battery at any time – even during a call.

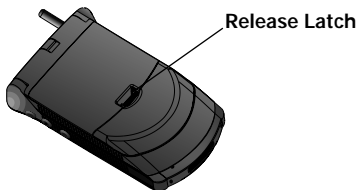

Installing Batteries

Auxiliary Battery Installation

The auxiliary battery clips onto the back of your phone.

- 1. Place Hook** Place the hook located on the narrow end of the battery into the slot on the back of the phone.
- 2. Pull Battery Down** Pull the battery down and slide the battery pegs over the bottom of the phone.
- 3. Release Battery** Once the battery clears the bottom of the phone, release it. Make sure that the pegs fit securely into place.

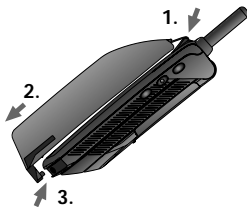

Auxiliary Battery Removal

To remove the auxiliary battery:

- 1. Pull Battery Down** Pull the battery down until the pegs come free, and pull the base away from the phone.
- 2. Remove Battery** Lift the battery's hook out of the slot on the back of the phone.

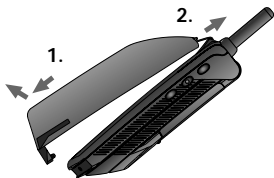

Tip:

If you have a charged main battery attached to your phone, you can remove and change your auxiliary battery at any time – even during a call.

Charging Batteries

Using the Internal Rapid Charger

Believe it or not, there is a battery charger built right into your phone! To make use of the internal charger, you will need one of the three available adapters, either a standard AC Adapter, a rapid rate AC Adapter, or a cigarette lighter adapter.*

Keep in mind: When the internal charger is in use and the phone is ON, you can still place and receive calls. However, talking on the phone requires energy, so your phone may not charge while the call is in progress.

- 1. Attach Adapter to Phone** Plug the AC or cigarette lighter adapter into the accessory connector on the bottom of your phone as shown, with the release tab facing up.
- 2. Plug In Adapter** Plug the adapter into the appropriate power source.

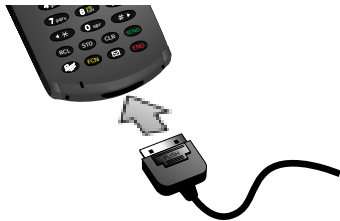

Keep in mind: In some cars, the ignition must be ON to use the cigarette lighter.

*Check with your dealer for availability of the adapters.

Charging Batteries

The Battery Indicator

In the upper right corner of your phone's display, there is a battery indicator filled with three segments. The more segments you see, the greater the charge.

- The border of the battery icon will flash during charging.
- When both batteries are fully charged, the battery icon will stop flashing and become solid.



High

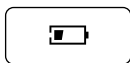

Low

Battery Storage and Disposal

To prolong the life of batteries, avoid exposing them to temperatures below -10°C (14°F) or above 45°C (113°F). It is a good idea to take your phone with you when you leave your car. Never dispose of batteries in fire.

Caution: To prevent injuries or burns, do not allow metal objects to contact or short circuit the battery terminals.

Expert Performance (E•P®) Charging System

The E•P system enables your phone's built-in charger to communicate with installed batteries and tailor its charging cycle to optimize performance. If you see `Invalid Battery` when you power up the phone, the built-in charger is not able to communicate with the battery and cannot charge it. There are several possible reasons for this message. The most likely one is that the battery is not a Motorola original and it does not have the appropriate E•P technology. We recommend that you use only Motorola original batteries and accessories and that you store your batteries in their protective covers when not in use.

Charging Batteries

Using the Desktop Charger

The Desktop Charger's front pocket can charge batteries while they are attached to your phone, and the rear pocket can charge batteries separately.

If you have a Desktop Charger:

- 1. Attach Adapter** Plug the AC Adapter into the back of the charger, with the release tab facing up.
- 2. Plug In Adapter** Plug the other end of the AC Adapter into a wall socket.
- 3. Insert Phone** Insert the phone into the front pocket with a main and/or auxiliary battery attached.
- & Insert Battery** If you like, insert a main or auxiliary battery into the rear pocket.

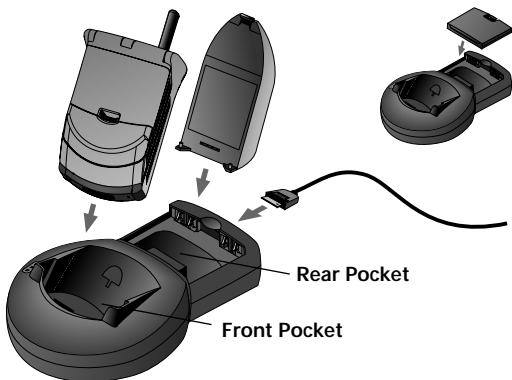

Note: If two or three batteries are loaded in the charger, the batteries will charge one at a time. The main battery attached to the phone will charge first, the attached auxiliary second, and the battery in the rear pocket last.

Charging Batteries

Desktop Charger Indicators

The three LED indicators on the left front of the Desktop Charger let you know the current state of any charging batteries. The first light provides information on the main battery attached to the phone, the second on the attached auxiliary battery, and the third on any battery loaded in the rear pocket.

- Red means the battery is charging.
- Flashing yellow means the battery is waiting to be charged.
- Green means the battery is charged within 90% of its capacity and can be used. An additional hour of charging will bring your battery up to 100% capacity.
- Flashing red means the battery is damaged and cannot be charged.











Desktop Charger Charging Times

The time it takes for your battery to obtain a full charge is affected by a variety of factors, including:

- **Temperature** Batteries should be at or near room temperature when charging. To prolong battery life and charge capacity, avoid exposing your batteries to temperatures below -10°C (14°F) or above 45°C (113°F). It is a good idea to take your phone with you when you leave your car.
- **Inactivity** New batteries, or batteries that have been stored for long periods of time, may not rapid charge properly. In these instances, the battery requires an overnight charge.
- **Extended Usage** Over extended periods of time, batteries gradually wear down and require longer charging times. This is normal. If you charge your battery regularly and notice a decrease in talk-time or an increase in charging time, then it is probably time to purchase a new battery.

Phone Overview

Function Keys

-  Turns the phone your ON and OFF.
-  Opens messaging menus.
-  Acts as a “shift” key to access the secondary functions of other keys.
-  Recalls phone numbers from memory.
-  Stores phone numbers into memory.
-  Clears characters from the screen.
-  Ends phone calls and exits the menu.
-  Places or answers calls. Your phone will have one of these two keys.
- 
-  Can be used to scroll through memory entries and menu features.
- 

Alphanumeric Display Displays your input from the keypad, information recalled from memory, and other messages.



Microphone Positioned for convenient conversation.

Retractable Antenna Extend for best performance.

Earpiece Ultra-compact phone speaker.

Headset Jack Provides the connection for an optional headset.

Accessory Connector Provides the connection for an external power supply.

Volume Keys Represented in this manual by  and , these keys adjust keypad, earpiece, and ringer volume. They also scroll up and down through memory locations and menu features.

Using the Smart Button

When in doubt, press the Smart Button! Easily recognized in this User's Guide by  and in your phone's display by * – the handy Smart Button puts a variety of functions at your fingertip.

The Smart Button



Use the Smart Button's fingertip convenience for:



Opening the Quick Menu

Press  when your phone is idle to display a menu containing shortcuts to your phone's most popular features. See page 34.

Opening Your Phone Book

Press  twice to open the Phone Book with your names and numbers. Turn to page 40 in "Using Memory" to learn more.

Entering the Menu System

Press  then press  to enter your phone's menu system. See page 56 for information on navigating the menu system.



Selecting Items in the Menu

The primary use of the Smart Button is to select. Whenever the phone offers you a choice, such as setting a ringer style, press  to select. You will see: Press * to Select.

Turning Features ON and OFF

Press  to toggle ON and OFF many menu features, like the call timers (pg. 66). You will see: Press * to Toggle.

Placing and Ending Calls



Press & hold  to place a call when the number you want to call is on the display. Press & hold  again to end a call. See page 28 for information on placing and ending calls.

The Basics

The next few pages will introduce you to the basic features of your phone. In the chapters that follow, we will explain every one of your phone's features, including storing names and numbers, using the call timers, locking the phone, and more.

Turning Your Phone On

Follow these steps to turn your phone ON:

- 1. Extend Antenna** Extend the antenna completely for best performance.
- 2. Open Phone** Open the phone to expose the keypad.
- 3. Turn ON Phone** Press  once to turn the phone ON.
- 4. Turn OFF Phone** When finished, press  again to turn the phone OFF.

What you will see:

Each time you turn your phone ON, it performs a short self-test to make sure it is operational and then it scans for service.



CDMA Digital

If your phone finds a CDMA digital system, you will see the time and date, the  icon, and either *Ready* or the personalizable banner (if programmed).



Turning Your Phone On

Analog

If your phone finds an analog system, you will see the  icon and either *Ready* or your personalized banner.



Quad Number

Your phone can be activated with up to four unique phone numbers. If there is more than one number programmed on your phone, you will see the currently active number whenever you turn on the phone. Turn to *Changing Your Number* on page 90 if you want to change your currently active number.

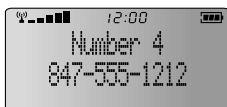

Power Save Mode

If you travel outside the range of available networks, your phone will continue to search for a signal. To save power, it stops searching every couple minutes. Your phone will automatically begin searching again in a minute or two – if you would like it to start searching immediately, just press any key.



Standby Mode

To conserve energy, your phone enters standby mode and turns off the backlight when you have not touched a key for a few seconds. The backlight will come back on as soon you press a key or open the phone. If you like, you can choose how long the backlight remains ON. See page 100.

Reading the Indicators

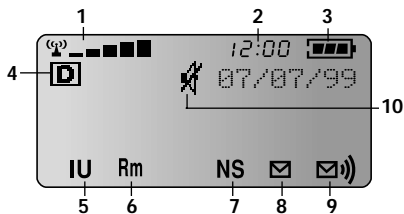

Strong

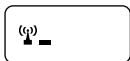

Weak



High



Low

Signal Strength (1)

Displays the strength of the connection between your phone and the local cellular system.

Clock (2)

When your phone is on a CDMA digital network, the display shows the current time and date. Wherever you are, you will have the correct local time. You can set your clock for 12- or 24-hour format. See page 101 for more information.

Battery Level (3)

The three bar segments on the phone's Battery Level Indicator show the amount of charge remaining in your battery. The more bar segments you see, the higher the charge. If your battery is low, the phone alerts you in three ways:

- No bar segments on the indicator will be highlighted.
- *Low Battery* will appear on your display.
- A hi-lo tone will sound periodically.

If you ignore these warnings, the phone will automatically turn itself OFF when the battery is exhausted. At this point, you should charge the battery or insert a new battery.

Digital (4)

Indicates you are in a digital service area, allowing for excellent voice quality. Check with your Service Provider for more information.

Reading the Indicators

Analog (4)

Appears when you are on an analog channel.

IU In Use (5)

Appears when a call is in progress.

Rm Roam (6)

Lights up when your phone accesses a cellular service outside of your home system. When you leave your cellular Service Area, your phone roams (seeks another CDMA cellular system).

NS No Service (7)

Appears when calls cannot be placed or received from your location.

Message (8)

Appears when you receive an alphanumeric message.* It will disappear after you have read the message.

Voice Mail (9)

Indicates that you have received a Voice Mail message in your Voice Mailbox. It will disappear after you have listened to the message.

When you select one of the VibraCall® Alert combinations (see page 75), the following indicators appear in the display:

VibraCall On (10)

Indicates that your phone's ringer is turned OFF and the VibraCall Alert is ON.

Silent Mode (10)

Indicates that all of your phone's tones are silenced and the VibraCall Alert is ON.

Vibrate Then Ring (10)

Indicates that both the ringer and VibraCall Alert are ON.

* Contact your Service Provider for availability.

Reading the Indicators

Detailed Battery Level Reading

Press **FCN** then press **4**.

The bar graph in the display represents the battery level. The higher the graph, the closer the battery is to full charge.



Full Charge



Low Charge

If you are using an auxiliary battery with the main battery, the display will indicate which one is in use.

Important: If the phone is being powered externally—from the cigarette lighter adapter for example—you will see:



Reading the Indicators

Service Light

The Service Light is on top of your phone and lights up when your phone is ON. The color it flashes depends on your phone's current state of service. Please read the chart below to learn how to understand your phone's state of service at a glance.

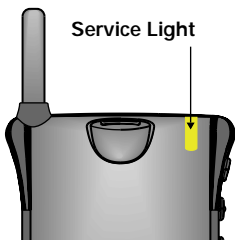

Red & Green, alternating	Incoming call or message
Green, flashing	In Service: home type system
Red, flashing	No Service
Yellow, flashing slow	Roaming: home type system
Yellow, flashing fast	Roaming: non-home type system

Note: If you would like to increase your phone's standby-time, you can turn the Service Light OFF. See page 101.

Placing and Ending Calls

Placing a Call

- 1. Extend Antenna** Extend the antenna completely for best performance.
- 2. Open Phone** Open the phone to expose the keypad.
If necessary, press **Power** to turn the phone ON.
- 3. Enter Number** Enter the number you want to call, for example: 555-1212.
Correct Errors Press **CLR** to erase one digit at a time if you make a mistake. Press & hold **CLR** to erase the entire entry and start again.
- 4. Place Call** Press **SEND** (or **TALK**) to place the call.
or
Press & hold **Call** until you hear a high tone.
You will see: *Calling 555-1212.*

Tip:

If you press **SEND** (or **TALK**) without entering a number, your phone will dial the last number entered.

You can dial phone numbers with up to 32 digits, but only the last twenty-four digits will appear in the display.

Press **RCL** to see the rest of the number.

Your phone will display the first 24 digits, then a second screen will show the digits remaining in the phone number.

Ending a Call

There are three ways to end a call:

- Close Phone** Close the phone to end a call.
- or **Press Key** Press **END**.
- or **Hold Smart Button** Press & hold **Call** until you hear a high tone.
You will see: *Press * to End Call.*
Press **Call** again to end the call.

Redialing Numbers

Automatic Redial

The cellular system may at times be too busy to handle your call. If this is the case, you may hear a fast busy signal and see **Call Failed** then **Press SEND to Redial** on the display. Using Automatic Redial, your phone will repeat the call attempt over the next four minutes. When the call succeeds, your phone will ring or vibrate until the person you are calling answers.

Auto Redial Press **SEND** (or **TALK**) or press & hold **↕** until you hear a high tone.
You will see: **Redialing**.

To make this feature even easier, turn Instant Redial ON. Your phone will instantly redial after a fast busy signal, and you will not have to push a button. To find out more, see page 97.

Redial

If you hear an ordinary busy signal:

- 1. Hang Up** Press **END** to hang up.
- 2. Redial** Press **SEND** (or **TALK**) to redial.
or
Press & hold **↕**. You will see: **Calling**.

Display Last Ten Numbers Dialed

Your phone keeps track of the last ten numbers you have dialed.

- 1. Enter List** Press **RCL** then press **0**, **0**. The display will show the last number you dialed.
- 2. Review List** Press **▲** or **▼** to scroll through the last ten numbers dialed, starting with the most recent.
- 3. Call Number** Press **SEND** (or **TALK**) or press & hold **↕** to call the number in your display. You will see: **Calling**.

Tip:

Your phone automatically remembers the last number entered. See page 43 to learn more.

Tip:

This feature is available through the Quick Menu. See page 34 to learn more.

Receiving Calls

Your phone must be ON to receive calls.

When a call is incoming:

- an alert will sound and/or vibrate.
- the Service Light (pg. 27) will flash red and green.

You can choose your phone's alert, selecting from nine ringer styles or silent vibration mode. See page 75.

Answering a Call

To answer a call:

- 1. Extend Antenna** Extend the antenna completely for best performance.
- 2. Open Phone** Open the phone to expose the keypad.
or
Press **SEND** (or **TALK**) if the phone is already open.

Caller ID

If Caller ID* is active on your phone, you will be able to see who is calling before you answer. The display will show either your caller's name (if it is in your Phone Book) or your caller's number. If you prefer to always see your caller's number, see page 63 to turn Number Preference ON.



The Caller IDs for your last 16 callers will be saved. See page 50 to learn how to view your stored Caller IDs.

*Contact your Service Provider for availability.

Receiving Calls

Ringer/Vibrator Suppress

If an incoming call catches you by surprise, you can turn the alert OFF using the upper or lower volume key. Your phone's ringer or vibrator will be OFF while the current call lasts. The caller will still hear ringing and you can still answer the call by pressing **SEND** (or **TALK**).

Suppress Alert When the phone rings or vibrates, press the upper or lower volume key.

Note: This feature works the same with a headset. To answer the call with a headset, press either volume key again or the Smart Button.

Unanswered Call Indicator

Even with the latest wireless technology, sometimes you are unavailable to answer calls. If your phone is ON, it keeps a count of unanswered calls. For example, if you miss two calls, your display will show: 2 Calls Unanswered.

Clear Display Press **CLR** or press **END** to clear the display, and you can begin placing calls again.

If you subscribe to Caller ID service, you can easily return the calls that you missed. See page 50 to learn how.

Call Waiting

If you subscribe to Call Waiting through your Service Provider, you may hear a tone while on a call, indicating that you are receiving a second call.

Answer Call Press **SEND** (or **TALK**) to answer the call and automatically place the current call on hold.

or End Current Call Press **END** to end the current call. Your phone will then ring and/or vibrate as usual. Press **SEND** (or **TALK**) to answer the call.

Basic Tone Controls

Vibration Mode

In situations where ringing may not be appropriate, or in noisy places where you may not hear your phone, select the **VibraCall®** Alert. Ringing will be replaced by gentle vibrations.

Toggle Alert Press **FCN** then press **8** to switch between ringer and vibrator alerts.

Silent Mode

For complete discretion, turn **Silent Mode ON**. All tones will be silenced. You can dial silently, and the ringer will be replaced by gentle vibrations.

Activate Silent Mode Press **FCN** then press & hold **8** until you see: **Silent Mode On**.

Note: This shortcut allows you to activate **Silent Mode** quickly. To learn how to turn **Silent Mode OFF**, see page 74.

Muting the Microphone

If you would like privacy while a call is in progress, you may mute the microphone—you will be able to hear the party on the other end, but they will not hear you.

Mute Phone Press **FCN** then press **6** to mute the microphone. You will see: **Muted**.

Unmute Phone Press **FCN** then press **6** again to resume your conversation.

Basic Tone Controls

The upper and lower volume keys are left of the display and can be used to adjust the earpiece, keypad, and ringer volume. As you press these keys, the phone's speaker will demonstrate the new volume level.

Adjusting Earpiece and Keypad Volume

The audio feedback your phone gives you when you press a key is called keypad tones. When your phone is idle, pressing the volume keys adjusts the volume of these tones. To adjust the volume of your conversation (the earpiece volume) use the volume keys during a call.

Raise Volume Press  to raise the volume.

Lower Volume Press  to lower the volume.

The bar graph in the display represents the volume level. The higher the graph, the louder the volume is.



High Volume



Low Volume

Adjusting Ringer Volume

To adjust ringer volume:

Raise Volume Press  then press  to raise the ringer volume.

Lower Volume Press  then press  to lower the ringer volume.

Tip:

See page 76 if you would like to silence the keypad tones.

Your Phone & Its Shortcuts

Throughout this guide you will see shortcuts that point out simple ways to reach some of your phone's features. If you have owned a Motorola phone before, some of these shortcuts will already be familiar to you.

The Quick Menu

Press the Smart Button and the Quick Menu opens on the display! The Quick Menu contains shortcuts to your phone's most popular features. Press the volume keys to scroll through the options shown below and the Smart Button to choose one.

Press  to open the Quick Menu:



Phone
Book

The Phone Book is the place to find all your personal names and numbers. See page 40.



Messaging

If you subscribe to messaging, you can use this shortcut or the one on page 48.



Last 10
Dialed

Your phone remembers the last ten numbers you dialed. Turn to page 29 to learn more.



Main
Menu

Select this to access your phone's menu system. See page 56 to find out more about the menu system.



Exit

Select this option or press  to exit the Quick Menu at any time.

Your Phone & Its Shortcuts

The Usual Shortcuts

The words “menu,” “batt,” “lock,” “mute,” and “vib” appear on the **1**, **4**, **5**, **6**, and **8** buttons. Press the **FCN** key first, then any one of these buttons, and your phone will perform that function.



Enter Menu

Press **FCN** then press **1** to enter the menu system.

Toggle Analog

Press **FCN** then press **2** to toggle Analog Only On or Analog Only Off.

Display Meter

Press **FCN** then press **4** to display the battery meter.

Lock Phone

Press **FCN** then press **5**.
You will see: Lock? Press **STD** to lock.

Mute Phone

Press **FCN** then press **6** to toggle mute ON and OFF during a conversation.

Silence Ringer

Press **FCN** then press **8** to toggle your phone's VibraCall® Alert ON and OFF.

Silence All Tones

Press **FCN** then press and hold **8** to turn ON Silent Mode.

Using Memory

Do you have places to go and people to see? Too many phone numbers to remember? Let your phone remember them for you. The internal Phone Book can store up to 99 names and numbers for easy access on the go!

In this chapter we will explain how to:

- store names and numbers into the Phone Book.
- recall phone numbers from memory.
- dial in a flash with the Super Speed Dial and Turbo Dial® functions.
- simplify automated calling systems and credit card calls.

Follow these symbols as a guide for using the keys on the side of your phone.

Press  to scroll up

Press  to select

Press  to scroll down



Making the Most of Memory

Each phone number is stored in a “memory location” numbered 01-99. You can arrange your Phone Book for convenient recall by storing related numbers in groups of ten. For example, store your ten most frequently called numbers in locations 01-09, then you can use the Turbo Dial® keys to call them with the push of a key. You could store business numbers in locations 10-19, family numbers in 20-29, friends in 30-39, and so on.

You can also store names to help identify phone numbers. If someone you know has more than one phone number, you could make each number easy to distinguish by storing names with descriptive labels. You can enter labels using the alphanumeric keypad or by selecting one of the convenient preset labels – choose from Home, Work, Mobile, or Pager. See page 39 for more information.

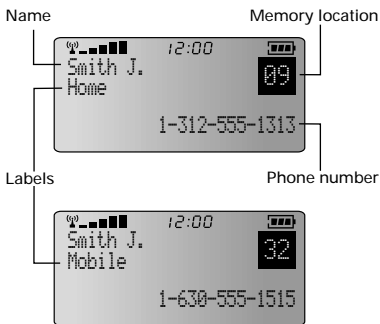

When you feel ready for more, try the advanced storing features at the end of the chapter. For instance, pages 44-45 describe how the Phone Book can help you access automated calling systems with only a few keystrokes.

Storing Names and Numbers

To take advantage of the internal Phone Book, you will need to store some names and numbers into memory. Your phone's dedicated **STD** key makes storing quick and easy.

Keep in mind: Your Phone Book sorts alphabetically by the first letter in the entry. If you store an entry without a name it will be placed at the back of the Phone Book.

- 1. Enter Number** Enter the phone number you want to store.
- 2. Begin Storing** Press **STD** to begin storing. You will see: Location XX? XX is the number of the lowest available location.
- 3. Accept Location** Press **STD** or **4*** to store the sequence in the displayed location.
or Enter New Location Press **CLR** to clear the location number from the display and enter a new two-digit location number.
- or Select Range of Ten** Enter the first digit of the memory location and press **4*** to store the sequence in the first available location beginning with that digit. (If you store personal numbers in the twenties, for instance, press **2**, **4***.)
- 4. Enter Name** Enter a name to identify the phone number. (See the next page for help entering names.) Press **♦** or **STD** when finished. Your phone will confirm the entry by displaying the information stored.

Tip:
Always store your Voice Mail number in location 98.

Tip:
The "♦" symbol in your display represents the Smart Button **♦**.

Note: To make it easy, your phone will let you know if you have already stored the name or number in your Phone Book. You will see: Duplicate Number or Duplicate Name. Press **STD** to store it again or **CLR** to exit.

Entering Names

When the display shows **Alpha** or **Press ***, you can use the keypad to produce any letter in the alphabet. Use the letters printed on the key as a guide. For example, press **2** to enter the letters "A," "B," or "C" as shown:

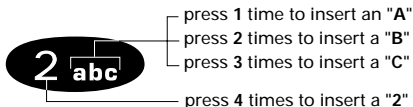

To enter a name into the Phone Book:

- 1. Enter Letter** Press a key as many times as necessary to enter a letter. The next letter on the key will appear with each press.
Toggle Case Press **▲** or **▼** to switch between upper and lowercase.
- 2. Advance Cursor** After each character, press **#▶** to advance the cursor to the next space.
Clear Letter Press **CLR** to erase a letter if you make a mistake.
Back Space Press **◀*** to move the cursor backward if you would like to insert a letter earlier in the sequence.
- 3. Choose Label** Press **◻** to scroll through the available labels. After **◻** you will see *Home, Mobile, Pager, or Work*.
- 4. Enter Marks** Press **1** to scroll through the available punctuation marks: `<space> 1 ! " $ % & ' @ () + , - . / \ : ; < = > ? [] _ * #`.
- 5. Finish Storing** Enter up to 20 letters, including labels. Press **◻** when you are finished. Your phone will confirm the entry by displaying the information stored.

Tip:
The preset labels make storing names simple!

Recalling from Memory

Recall by Name

Once you have stored names and numbers, you can recall them alphabetically and immediately place calls.

1. **Enter Directory** Press **2** twice to enter your name directory.

2. **Scroll to Name** Press **4** or **6** to scroll to the name you are looking for.

or **Search for Name** Enter the first letter of the name. (See page 39 for details on entering letters.) The display will show the name, phone number, and memory location of the first entry beginning with that letter.

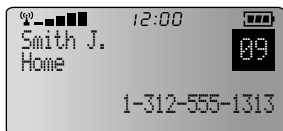

3. **Place Call** Press & hold **3** or press **SEND** (or **TALK**) to call the selected number. You will see: *Calling*.

4. **End Call** Press **END** or close the phone.

or Press & hold **3** until you hear a high tone. You will see: *Press * to End Call*.

then

Press **3** again.

Recalling from Memory

Recall by Memory Location

Each name and number you store is placed in a memory location numbered 01-99. Once you have stored names and numbers, you can recall them by memory location.

- 1. Begin Recalling** Press **RCL** to begin recalling.
- 2. Enter Location** Enter the two-digit memory location of the phone number you are looking for.
- 3. Place Call** Press & hold **☐** or press **SEND** (or **TALK**) to call the number you selected.
- 4. End Call** Press **END** or close the phone.
or
Press & hold **☐** until you hear a high tone.
You will see: Press * to End Call.
then
Press **☐** again.

Clear an Entry



To erase a memory entry:

- 1. Recall Entry** Press **☐** twice then press **▲** or **▼** to scroll to the entry you want to erase.
or
Press **RCL** and the two-digit location number of the entry.
- 2. Clear Entry** Press & hold **CLR** to clear the entry.
You will see: To Delete Press STO.
- 3. Confirm Erase** Press **STO** to confirm that you want to erase the entry.

Recall Shortcuts

Super Speed Dial



If you know the memory location of the number you wish to call, you may use the Super Speed Dial function.

- 1. Enter Location** Enter the two-digit memory location, 01-99.
- 2. Place Call** Press & hold  or press  (or ) to call the number you selected. The number stored in the memory location you entered will be dialed. You will see: *Calling.*

Note: If you enter the number of an empty location, you will see: *Location XX Is Empty.*

Turbo Dial

The Turbo Dial® keys let you dial numbers stored in locations 01-09 with the push of a button.

- Turbo Dial** Press & hold the memory location number of the entry you want to call,  through , and your call is placed.
You will see: *Calling.*

Your phone's Emergency Call feature gives you unrestricted access to any number stored in location 01, even if your phone is locked. To learn how to activate this feature, see page 83.

Scratchpad

If you need to take a quick note, but you do not want to save the number, use the Scratchpad, which always remembers the last phone number that was on your phone's display. The Scratchpad is helpful if you are on the phone and your party gives you another number to call.

- 1. Enter Number** Enter the number with the keypad.
(The person on the line will hear tones as you dial.)
 - 2. Store Number** Press **STO**, enter a two-digit location, enter a name with the keypad, and press **STO** again.
See page 38 for more details.
- or End Call** Press **END** to end your current call if necessary.
- & Place Call** Press **SEND** (or **TALK**) to call the number in the Scratchpad.

Pause Dialing

When you call automated systems like Voice Mail or bank by phone, a recorded message prompts you for PIN numbers, account numbers, etc. Pause Dialing can make using automated systems easy by allowing you to store these numbers in the same memory location as the automated system's access number. Separate each set of numbers with a "pause" – a special character that tells your phone to wait before sending additional numbers.

Storing a Number with Pause Dialing

The pause occupies a one-digit space in your phone's memory. Once you have entered a string of numbers and pauses, store the string in the same way you store other entries.

Tip:
You can store up to 32 digits, including pauses.

- 1. Enter Number** Enter the phone number you use to access the automated system.
- 2. Insert Pause** Press **FCN** and press **SEND** (or **TALK**). You will see: `Insert Pause`. Press **◀**. You will see a pause circle `o` inserted into the number entry.
- 3. Enter PIN** Enter the next group of numbers, for example, your PIN number. If the automated system requires a * or #, enter those symbols, too.
- 4. Insert Pause** Press **FCN** and press **SEND** (or **TALK**) then **◀**. Repeat steps 3 and 4 as many times as necessary.
- 5. Store Sequence** Press **STD**. Enter a two-digit location, enter a name if you like, and press **STD** or **◀** when finished. Your phone will confirm the entry by displaying the information you stored.

Using Pause Dialing

Once stored, you may recall the entry and place the call. All of the digits you have stored will be recalled, but your phone will only send the tones for the set of numbers before the first pause.

- 1. Place Call** Enter the two-digit memory location of the Pause Dialing number and press & hold **☛** or press **SEND** (or **TALK**). Your phone will dial the access number and wait for your input when it reaches the first pause.
- 2. Send More Numbers** When the automated system prompts you for information, press **☛** or **SEND** (or **TALK**) to send the next group of numbers. Repeat this step to send each group of numbers that you have stored.
- 3. End Call** Press **END**, close the phone, or press & hold **☛** until you hear a high tone and press **☛** again.

Using Memory Linking

Each memory location holds up to 32 digits, including pauses. Some automated systems, however, may require you to enter more than 32 digits. If this is required, split the numbers into two memory locations and recall the second set of digits as you need them.

- 1. Recall 2nd Location** Once you have sent the tones from the 1st location, press **RCL** and the two-digit memory location where you stored the second set of digits.
- 2. Send Tones** Press **RCL** and **SEND** (or **TALK**) to send the tones in the 2nd location. If you have stored a pause in the 2nd location, your phone will pause as usual when it reaches the pause character.

Using Calling Cards

Storing Calling Card Numbers

Number Characters are another way your phone can save you time in dialing. The Number Character saves a place in the memory sequence for whatever number you are calling when you use your calling card. You may use the Number Character along with Pause Dialing.

- 1. Enter Access Number** Enter the phone number you use to access the calling card system, usually a 1-800 phone number. Skip this step if you only dial 0.
- 2. Insert Pause** Press **FCN** then press **SEND** (or **TALK**). You will see: Insert+ Pause 0. Press **▶**.
- 3. Insert Number Character** Press **FCN** then press **SEND** (or **TALK**). Press **▲** or **▼** to scroll to Insert+ Number +#. Press **▶**. You will see the number character # inserted into the sequence. This special character saves a place for the number you will be calling when you use your calling card.
- 4. Insert Pause** Press **FCN** then **SEND** (or **TALK**) then **▶** as in step 2.
- 5. Enter Code** When you use your calling card, the system prompts you for an access code, usually a PIN code. Enter this number. Repeat steps 4 & 5 if your card requires more access codes.
- 6. Store Sequence** Press **STD**. Enter a two-digit location, enter a name if you like, and press **STD** or **▶** when finished. Your phone will confirm the entry by displaying the information you stored.

Tip:

You can protect your calling card information with your phone's call restriction features. See page 87 for details.

Placing a Calling Card Call

Once you have stored your calling card information, recall the information and place the call whenever you want to use your calling card. Before your phone begins dialing, it will prompt you for the number you want to call. Once you have entered the number, your phone will automatically insert the number in place of the Number Character you stored.

- 1. Recall Entry** Press **RCL** then enter the location number where your calling card sequence is stored.
- 2. Enter Number** Press **SEND** (or **TALK**). You will see: Enter Number. Enter the phone number you are calling. You may enter the number manually or recall it by location.
- 3. Place Call** Press & hold **☎** to place the call. Your phone will dial the number to access your long distance provider, then wait for your input when it reaches the first pause.
- 4. Send More Numbers** Press **☎** or press **SEND** (or **TALK**) to send the next group of numbers when the recording prompts you. The phone will automatically insert the number to call at the appropriate spot in the sequence. Press **☎** to send each set of numbers until finished.
- 5. End Call** Press **END**, close the phone, or press & hold **☎** until you hear a high tone, and press **☎** again to end the call.

Using Messaging*



The dedicated Message Key provides access to your phone's new and easy Messaging Menu. Through this menu, you can check your Voice Mail, read your pager-like alphanumeric Messages, and view the Caller IDs of your most recent callers.

In this chapter we will explain how to:

- view your Caller IDs.
- check your Voice Mail.
- read your Messages.
- explore your options with the Function Menus.

Follow these symbols as a guide for using the keys on your phone.

Press  to scroll up

Press  to select

Press  to scroll down

Press  to open messaging menus



*Contact your Service Provider for availability.

Receiving Messages

If your phone is ON and you receive a Voice Mail or alphanumeric message:

- **An alert sounds or vibrates:**

Your phone will beep or vibrate three times.

See Ringer or Vibrator Selection on page 75 to set your phone's alert. See page 79 to learn about Reminder Tones.

- **An indicator appears on the display:**

✉ Appears on the lower line of the display when you receive an alphanumeric message. It will stay on the display until you have read the message.

Urgent ✉ Appears in the main display when you receive an urgent message and your phone is in idle mode. After a few seconds, the screen will change to Press ✉ and begin flashing.

Msg Mem Low Appears when your phone's message memory is almost full (at approximately 85% capacity).

Msg Mem Full Appears in the main display when the message memory is completely full and your phone is in idle mode.

✉)) Appears when you receive a Voice Mail message. It will stay on the display until you have listened to the message. Your Service Provider will then signal your phone to turn the indicator OFF

- **Press ✉ to open the Messaging Menu:**

The specific icon will be flashing.

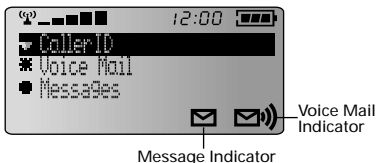

Tip:





See page 30 for information on receiving Caller IDs.

Tip:

Your Service Provider holds your messages and will forward them after you have made room. See page 55 to learn how to delete messages.



Viewing Your Caller IDs*

Your phone supports Caller ID service, which lets you see who is calling before you answer. The Caller IDs for the last 16 different callers are stored so they can be viewed at any time.

- 1. Enter Messaging** Press  to open the Messaging Menu.
- 2. Select Caller ID** Press  or  to scroll to **Caller ID** and press  to select.





You will see a Caller ID icon  for each stored Caller ID. Flashing icons represent Caller IDs that have not been viewed. Below the icons you will see information for the latest Caller ID:

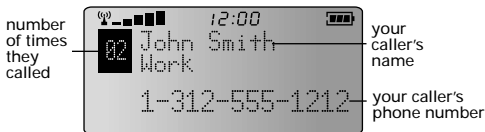

- 3. Select Caller** Press  or  to highlight a Caller ID to view and press  to view complete information for that call:



Keep in mind: You will see the caller's name only if it is stored in your Phone Book.

 A check mark will appear in the corner if you have answered or returned the call. Press  (or ) to return the call of the displayed caller. Press  to store the information.

*Contact your Service Provider for availability.







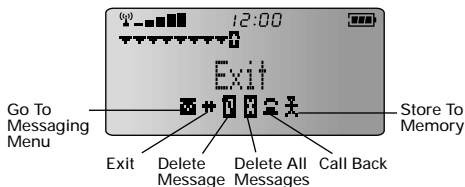







Caller ID Options

When viewing Caller IDs, press the Message Key to see the options available for the highlighted Caller ID.

- 4. Access Options** Press  to open the Caller ID Function Menu.







- 5. Choose Function** Press  or  to scroll to one of the following:

-  **Go To Messaging Menu** Press  to return your phone to the Messaging Menu.
-  **Exit** Press  to exit Messaging to idle mode.
-  **Delete Message** Press  to delete the currently selected Caller ID. Press  again to confirm.
-  **Delete All Messages** Press  to delete all your Caller IDs. Press  again to confirm.
-  **Call Back** Press  to return the call.
-  **Store To Mem** Press  to begin storing the number. Enter a two-digit location, enter a name, and press  again.

Checking Your Voice Mail*

When you receive Voice Mail, your Service Provider sends a notification to your phone and your phone displays an indicator. This way, you will be able to check for new Voice Mail simply by glancing at your phone's display.

- 1. Enter Messaging** Press  to open the Messaging Menu.
- 2. Select Voice Mail** Press  or  to scroll to Voice Mail and press  to select.

If you have one or more Voice Mail messages, you will see:

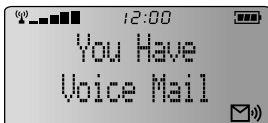

To listen to your messages, dial your access number. Your phone will do this automatically with one keypress.

- Dial Number** When viewing notifications, press  (or ) or press & hold  to call your Voice Mail box.

See the following page for more options.

Keep in mind: Some Service Providers send the Voice Mailbox number to your phone automatically. If the number has not been sent, then store it in location 98 of your Phone Book. To learn how, see Pause Dialing on page 44.

If you have no new messages, you will see:



*Contact your Service Provider for availability.







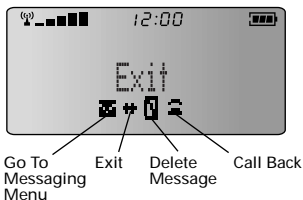

Voice Mail Options

When checking Voice Mail, press the Message Key to see options for the highlighted Voice Mail notification.

3. **Access Options** Press  to open the Voice Mail Function Menu.



4. **Choose Function** Press  or  to scroll to one of the following:

-  **Go To Msg Menu** Press  to return your phone to the Messaging Menu.
-  **Exit** Press  to exit Messaging to idle mode.
-  **Delete Message** Press  to delete the currently selected Voice Mail notification. Press  to confirm.
-  **Call Back** Press  to dial your Voice Mail box number.

Reading Your Messages*

Your phone can receive alphanumeric messages like a pager. The message memory stores up to 60 messages, depending on the size of each.

- 1. Enter Messaging** Press to open the Messaging Menu.
- 2. Select Messages** Press or to scroll to Messages and press to select.

Tip:
Flashing icons represent messages that have not been viewed.



- 3. Select a Message** Press or to highlight a message to read and press to select the message.

Once a message is selected, the following keys will help you read through your messages:

- 4. Scroll** Press or to scroll through the selected message.
- Previous Message** Press or to go to the previous message.
- Next Message** Press to go to the next message.

Tip:
If the Call Back number matches one in your Phone book, you will see the name of the caller when you view the message.

If the message includes a number in parentheses (a Call Back number) you can use the following shortcuts:

- Call Back** Press (or) to dial the Call Back number (in parentheses if included).
- Store** Press to store the Call Back number (in parentheses if included) in your Phone Book.

* Contact your Service Provider for availability.







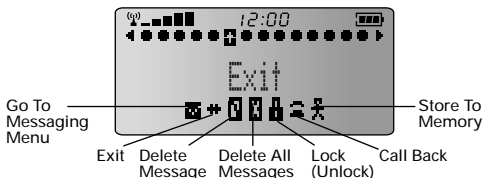





Message Options

When reading your messages, press the Message Key to see the options available for the highlighted message.





- 5. Access Options** Press  to open the Message Function Menu.



- 6. Choose Function** Press  or  to scroll to one of the following:

-  **Go To Msg Menu** Press  to return your phone to the Messaging Menu.
-  **Exit** Press  to exit Messaging to idle mode.
-  **Delete Message** Press  to delete the currently selected message. Press  again to confirm.
-  **Delete All Msgs** Press  to delete all messages. Press  again to confirm.
-  **Lock Message** Press  to lock or unlock the message. Lock important messages to protect them from accidental deletion.
-  **Unlock Message** Messages must be unlocked before they can be deleted.

If the message contains a Call Back number (in parentheses), you will also see these options:

-  **Call Back** Press  to dial the sender's number.
-  **Store To Mem** Press  to begin storing the number. Enter a two-digit location, enter a name, and press  again.

The Works

Introducing the Menu Features

The Digital StarTAC® phone is loaded with features that can help make life easier and more productive. The phone's user-friendly menu system will help you find what you need quickly and easily. You will see the following icons as you scroll through the menu system and each represents a menu.



Phone Book



Timers



Lock/Secure



Phone Options



Tone Control

Navigating the Menu

You can navigate through the menu system using the three keys located on the left side of the phone. Use the volume keys to scroll up and down through the options available on one level, and the Smart Button, in the middle, to select.

This manual uses these symbols to instruct you to use the navigation keys.

Press  to scroll up

Press  to select



Press  to scroll down



Road Maps

To help you navigate through the phone's menu system, chapters begin with an easy-to-follow visual “road map”—a quick overview of what you will find in the chapter that follows.

To use the menu system:

- 1. Enter Menu** Press **FCN** then press .
- 2. Scroll through Menu** Press  or  to scroll through the menu's top level, shown on the right.
- 3. Exit Menu** Press **END** to exit the menu.



Previous User Compatibility

If you are already familiar with previous Motorola phones, you may prefer to use your phone's ***>** and **#>** keys to scroll through the menu system.

In the Works

In the chapters that follow, detailed instructions describe the operation of each feature. We will explain everything you need to know about your new phone, including how to access and use a feature and what happens when you do.

Phone Book



In “Using Memory” you learned how to store and recall phone numbers with the internal Phone Book. You can access the same features, along with some other interesting features, using your phone’s convenient menu system.

In this chapter we will explain how to:

- recall and store phone numbers using the menu system.
- edit your memory information.
- view your own phone number.

Follow these symbols as a guide for using the keys on the side of your phone.

Press  to scroll up

Press  to select

Press  to scroll down



Road Map

Press **FCN** then press **▼** to enter the menu system.

Start:

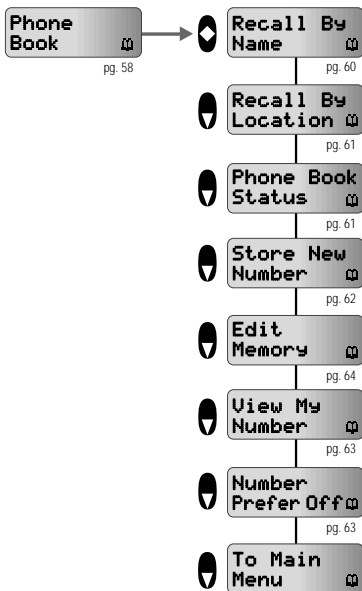

Getting to Phone Book...

- 1. Enter Menu** Press **FCN** then press **↵**.
- 2. Enter Phone Book** Press **↵** to enter Phone Book.

Recall By
Name 

Recalling By Name

Once you have stored names and numbers, you can recall them alphabetically with the Phone Book menu.

- 3. Begin Recalling** Press **↵** to select Recall By Name.
You will see: Enter 1st Letter.
- 4. Enter Name** Press the appropriate digit key as many times as necessary to enter the first letter of the name. (See page 39 for help entering letters.)
You will see the first entry with that letter.
- 5. Find Name** Press **▲** or **▼** to scroll to the name you are looking for.
- 6. Place Call** Press & hold **↵** or press **SEND** (or **TALK**).
You will see: Calling.
- 7. End Call** Press **END** or close the phone.
or
Press & hold **↵** until you hear a high tone.
You will see: Press * to End Call.
then
Press **↵** again.

Recalling By Location

Each name and number you store is placed in a memory location numbered 01-99. Once you have stored names and numbers, you can use this feature to recall them by memory location.

- 3. Begin Recalling** Press **▲** or **▼** to scroll to **Recall By Location** and press **▶** to select.
- 4. Enter Location** Enter the two-digit memory location of the number you are looking for. You will see the **Phone Book** screen for that memory location.
- 5. Place Call** Press & hold **▶** or press **SEND** (or **TALK**). You will see: **Calling**.
- 6. End Call** Press **END** or close the phone.
or
Press & hold **▶** until you hear a high tone. You will see: **Press * to End Call**.
then
Press **▶** again.

Phone Book Status

You can use this feature to see how many of your Phone Book's 99 locations have been used.

- 3. Select Feature** Press **▲** or **▼** to scroll to **Phone Book Status** and press **▶** to select. You will see: **XX Full XX Empty**.
- 4. Exit Menu** Press **END** to exit menu, or you may scroll to other features.

Recall By
Location 

Tip:

To place a quick call just enter the two-digit location and press **SEND** (or **TALK**).

Phone Book
Status 

Getting to Phone Book...

- 1. Enter Menu** Press **FCN** then press **⏏**.
- 2. Enter Phone Book** Press **⏏** to enter Phone Book.

Store New
Number 

Storing a New Number

Whether you store numbers as described in “Using Memory” or store numbers with this menu feature, you will get the same results.

- 3. Begin Storing** Press **▲** or **▼** to scroll to Store New Number and press **⏏** to select. You will see: Enter Number.
- 4. Enter Number** Enter the number you want to store and press **⏏**. You will see: Location XX? XX is the number of the lowest available location.
- 5. Enter Location** Press **STD** or **←*** to store the sequence in the displayed location or enter a new two-digit location.
- or Select Range of Ten** Enter the first digit of the memory location and press **←*** to store the sequence in the first available location beginning with that digit. (If you store personal numbers in the twenties, for instance, press **2**, **←***.)
- 6. Enter Name** Enter a name to identify the phone number or continue with step 7. See page 39 for details on entering names.
- 7. Store Number** Press **STD** or **⏏**. Your phone will confirm the entry by displaying: Stored At XX.
- 8. Exit Menu** Press **END** to exit menu, or return to Step 3 to store more numbers.

Tip:

Always store your Voice Mail number in location 98.

Tip:

If the name or number is already in your Phone Book, you will see: Duplicate Name or Number.

Viewing Your Number

Use this feature to view your phone's currently active number. If you have more than one phone number, you can change the active number with Changing Your Number on page 90.

- 3. View Number** Press **▲** or **▼** to scroll to *View My Number* and press **▶** to select. The display will show the currently active number on your phone.
- 4. Exit Menu** Press **END** to exit the menu, or you may scroll to other features.

Number Preference

When Placing Calls:

If you prefer to see the number (*Calling 555-1212*) instead of the name (*Calling Jane Smith*) when you place a call from the internal Phone Book, turn Number Preference ON.

When Receiving Calls:

If you subscribe to Caller ID, your phone automatically looks up callers in your Phone Book and displays the name stored in the entry. If you prefer to see the caller's number (*555-1212*), then turn Number Preference ON.

- 3. Find Feature** Press **▲** or **▼** to scroll to *Number Preferen.*
- 4. Toggle Feature** Press **▶** to toggle the feature ON or OFF.
- 5. Exit Menu** Press **END** to exit the menu, or you may scroll to other features.

View My
Number 

Shortcut:
Press **ACL** **#▶**.

Number
Prefer On 

Getting to Phone Book...

1. **Enter Menu** Press **FCN** then press **↵**.
2. **Enter Phone Book** Press **↵** to enter Phone Book.

Edit

Memory



Editing a Memory Location

You can edit an entry or move it to another location. When you move an entry, the original location remains untouched, allowing you to create a Phone Book entry similar to one you have already stored.

3. **Begin Editing** Press **↑** or **↓** to scroll to **Edit Memory** and press **↵** to select.
4. **Find by Location** Press **↑** or **↓** to scroll to **Edit By Location** and press **↵** to select. You will see: **Location_____**. Enter the two-digit memory location of the phone number you want to edit. Press **↵** to begin editing the displayed entry and continue with Step 5.
- or **Find by Name** Press **↑** or **↓** to scroll to **Edit By Name** and press **↵** to select. You will see: **Enter 1st Letter**. Enter the first letter of the name you want to edit. (See page 39 for information on entering letters.) You will see the first entry beginning with that letter. Press **↑** or **↓** to scroll to the name you are looking for and press **↵** to begin editing.
5. **Edit Phone Number** Enter changes to the phone number. Press **CLR** to erase one digit at a time, or press & hold **CLR** to erase the entire number. Press **←*** to move the cursor backward.

Editing (cont'd)

- 6. Finish Number** Press **↵** when you finish editing the phone number. The display will show the current location.
- 7. Move to a New Location** If you would like to move the entry to a new location and preserve the original entry, then press and hold **CLR** to erase the location and enter a new two-digit location. You will see the name associated with the entry.
- or Overwrite Original** If you would like to overwrite the original entry, then press **↵** or **STO**. You will see the name associated with the entry.
- 8. Edit Name** Enter your changes to the name. (See page 39 for details on entering names.) Press **CLR** to erase one letter at a time, or press and hold **CLR** to erase the entire name. Press **←*** to move the cursor backward. Skip this step to leave the name unchanged.
- 9. Confirm Changes** Press **↵** or **STO** when you finish editing the name. If you are overwriting an entry, then you will see: Location XX is Full. The display will then show the new information and you will see: Change? Press **↵** or **STO** again to save your changes. You will see: Stored At XX.
- or Choose Different Location** Press **CLR** to choose a new memory location and return to step 6.
- or Discard Changes** Press **END** to exit without saving your changes.
- 10. Exit Menu** Press **END** to exit the menu, or you may scroll to other features.

Call Timers



Your phone is equipped with three visual and three audible call timers. You can monitor or record the length of individual calls, set a timer to track monthly usage, or have the phone alert you at intervals that you specify.

In this chapter we will explain how to:

- monitor the length of your calls.
- set and view the resettable timer for long-term monitoring.
- program audible timers for your individual needs.

Follow these symbols as a guide for using the keys on the side of your phone.

Press  to scroll up

Press  to select

Press  to scroll down



Road Map

Press **FCN** then press **⬇** to enter the menu system.

Start:

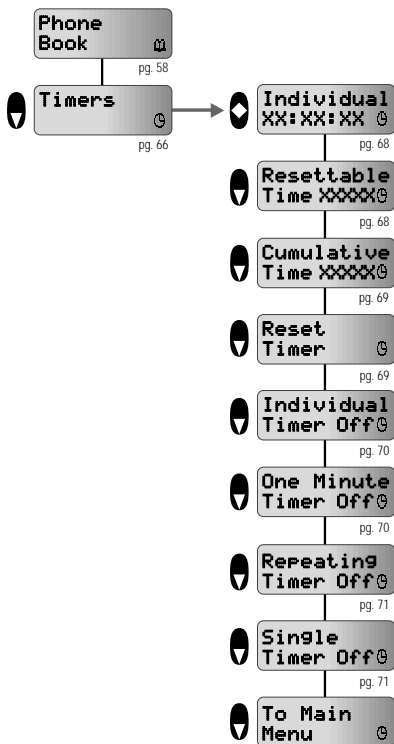

Getting to Call Timers...

- 1. Enter Menu** Press **FCN** then press **↓**.
- 2. Enter Call Timers** Press **▲** or **▼** to scroll to **Timers** and press **↓** to select.

Individual
XX:XX:XX ⌚

Shortcut:

Press **RCL** then **#▶** twice.

Shortcut:

Press **FCN**, **↓**, then **4**, **5**.

Resettable
Time:XXXX ⌚

Shortcut:

Press **RCL** then **#▶** three times.

Shortcut:

Press **FCN**, **↓**, then **4**, **6**.

Viewing the Individual Timer

The individual timer records the air-time of your most recent call in hours, minutes, and seconds. It resets before you place the next call and when you turn the phone OFF. You can have the timer display automatically while calls are in progress. See Auto Display Individual Timer on page 70.

- 3. View Timer** When you enter the Call Timers menu, you will see: Individual XX:XX:XX.
- 4. Exit Menu** Press **END** to exit the menu, or you may scroll to other features.

Viewing the Resettable Timer

You can track how much air-time you have accumulated during any time period you choose. For example, reset this timer at the beginning of each billing period to know where you stand at any given moment. Use this feature to view the time elapsed, and follow the instructions on page 69 to reset the timer.

- 3. View Timer** Press **▲** or **▼** to scroll to **Resettable Time**. You will see the air-time in minutes since you last reset the timer.
- 4. Exit Menu** Press **END** to exit the menu, or you may scroll to other features.

Viewing the Cumulative Timer

This is a non-resettable timer that keeps track of your phone's total air-time (in minutes) since your phone was activated.

- 3. View Timer** Press **▲** or **▼** to scroll to Cumulative Time. You will see the total air-time in minutes.
- 4. Exit Menu** Press **END** to exit the menu, or you may scroll to other features.

Resetting the Timer

This feature allows you to monitor elapsed air-time over a period of time that you choose. After you reset the timer, it will continue to keep track of your air-time (in minutes) until you reset it again.

- 3. Find Feature** Press **▲** or **▼** to scroll to Reset Timer.
- 4. Reset Timer** Press **▼** to reset. You will see: Resettable Time 00000.
- 5. Exit Menu** Press **END** to exit the menu, or you may scroll to other features.

Keep in mind: The shortcuts will not work if the Resettable Timer is already set at zero.

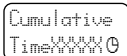

Cumulative
TimerXXXXX

Shortcut:
Press **FCL** then
#▶ four times.

Shortcut:
Press **FCN**,
then **4**, **7**.

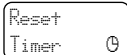

Reset
Timer 0

Shortcut:
Press **FCN**,
then **4**, **3**
and continue
with step 4.

Shortcut:
Press **FCN** then
0, **7**, **CLR**
to reset the
timer.

Getting to Call Timers...

- 1. Enter Menu** Press **FCN** then press **↓**.
- 2. Enter Call Timers** Press **▲** or **▼** to scroll to **Timers** and press **↓** to select.

Individual
Timer On 

Shortcut:

Press **FCN**, **↓**
then **4**, **8**
and continue
with step 4.

One Minute
Timer Off 

Shortcut:

Press **FCN**, **↓**
then **4**, **4**
and continue
with step 4.

Auto Display Individual Timer

When you turn this feature ON, your phone will automatically display your air-time in minutes and seconds during and after each call.

Note: Activating the Auto Display Timer may reduce standby-time and talk-time.

- 3. Find Feature** Press **▲** or **▼** to scroll to **Individual Timer**.
- 4. Toggle Display** Press **↓** to toggle ON or OFF the automatic display of the individual timer.
- 5. Exit Menu** Press **END** to exit the menu, or you may scroll to other features.

One Minute Audible Timer

Turn this feature ON to hear an audible beep 10 seconds before the end of every minute during a call. The party on the other end will not hear the beeps.

- 3. Find Feature** Press **▲** or **▼** to scroll to **One Minute Timer**.
- 4. Toggle Timer** Press **↓** to toggle the timer ON or OFF.
- 5. Exit Menu** Press **END** to exit the menu, or you may scroll to other features.

Repeating Audible Timer

You can set this timer to beep during your calls at an interval that you select—from 11-999 seconds. Like the One Minute Timer, you will hear the beep 10 seconds before the end of each interval, and the party on the other end will not hear the beeps.

- 3. Find Feature** Press or to scroll to `Repeating Timer`.
- 4. Toggle Timer** Press to toggle the timer ON or OFF.
- 5. Enter Seconds** If you toggle the timer ON, you will see: `Enter Seconds`. Enter the number of seconds you would like between beeps and press to set the timer. You will see: `Set At XXX Secs`.
- 6. Exit Menu** Press to exit the menu, or you may scroll to other features.

Single Audible Timer

You can set the Single Timer to beep at a time that you select—from 11-999 seconds. It will beep once during each call, 10 seconds before the end of the preset time. The party on the other end will not hear the beeps.

- 3. Find Feature** Press or to scroll to `Single Timer`.
- 4. Toggle Timer** Press to toggle the timer ON or OFF.
- 5. Enter Seconds** If you toggle the timer ON, you will see: `Enter Seconds`. Enter the number of seconds you would like before the beep and press to set the timer. You will see: `Set At XXX Secs`.
- 6. Exit Menu** Press to exit the menu, or you may scroll to other features.

Repeating
Timer Off

Shortcut:

Press ,
then ,
and continue
with step 4.

Single
Timer Off

Shortcut:

Press ,
then ,
and continue
with step 4.

Tone Controls



If you've been reading along diligently, this may be a good time for a break—put your feet up and have some fun with these features. Use the Tone Control features to select Silent Mode, personalize your phone's ringer styles, or set the phone to remind you of new messages.

In this chapter we will explain how to:

- choose from nine different ringer styles.
- activate and deactivate the VibraCall[®] Alert.
- silence the keypad.
- silence all your phone's tones with one convenient feature.
- set the Message Reminder.

Follow these symbols as a guide for using the keys on the side of your phone.

Press  to scroll up

Press  to select

Press  to scroll down



Road Map

Press **FCN** then press **⬇** to enter the menu system.

Start:



Getting to Tone Control...

- 1. Enter Menu** Press **FCN** then press **↕**.
- 2. Enter Tone Control** Press **▲** or **▼** to scroll to **Tone Control** and press **↕** to select.

Silent
Mode Off 

Shortcut:

Press **FCN** then
press & hold **B**.

Silent Mode

When you need to be discreet, just turn Silent Mode ON. All tones will be silenced. The ringer and incoming message tones will be replaced by vibrations.

- 3. Find Feature** Press **▲** or **▼** to scroll to **Silent Mode**.
- 4. Toggle Feature** Press **↕** to toggle the feature ON or OFF.
- 5. Exit Menu** Press **END** to exit the menu, or you may scroll to other features.

Ringer or Vibrator Selection

Motorola's VibraCall® Alert is ideal for situations where ringing may not be appropriate, or in noisy places where you might not hear the ringer. You can choose to be alerted to incoming calls using the vibrator, ringer, both or neither.

- 3. Enter Feature** Press or to scroll to Ring/Vib Select and press to select.
- 4. Select Ringer/Vibe** Press or to scroll to Vibrate Only, Ring Only, or Vibrate Then Ring and press to select the displayed option.
- 5. Exit Menu** Press to exit the menu, or you may scroll to other features.

Keep in mind: When both the ringer and vibrator are ON, the phone alerts you by vibrating for three ring cycles then ringing.

Selecting a Ringer Style

Your new phone offers nine different ringer styles. After you choose a style, the phone will give you a brief sample of your new alert sound, or vibrate if you have the VibraCall® Alert selected.

- 3. Enter Feature** Press or to scroll to Ringer Style and press to select.
- 4. Select Ringer** Press or to scroll through the ringer styles. As you scroll, your phone will give an audible sample of the currently displayed style. Press to select the displayed option.
- 5. Exit Menu** Press to exit the menu, or you may scroll to other features.

Ring/Vib
Select

Shortcut:

Press then press to toggle the VibraCall® Alert ON and OFF.

Shortcut:

Press , , and , or and continue with step 4.

Ringer
Style X

Getting to Tone Control...

- 1. Enter Menu** Press **FCIN** then press **↓**.
- 2. Enter Tone Control** Press **↑** or **↓** to scroll to **Tone Control** and press **↓** to select.

Keypad
Tones On 

Keypad Tones

Keypad Tones are the sounds you hear when you press any key on the phone. If you want to be discreet, use this feature to silence the audio feedback from the keypad.

Keep in mind: Turning Keypad Tones OFF does not silence the tones your phone sends across the line. See Transmit Tones on page 78 for more information.











Shortcut:

Press **FCIN**, **↓**
and **3**, **2**
and continue
with step 4.

- 3. Find Feature** Press **↑** or **↓** to scroll to **Keypad Tones**.
- 4. Toggle Feature** Press **↓** to toggle the feature ON or OFF.
- 5. Exit Menu** Press **END** to exit the menu, or you may scroll to other features.

Setup Message Tones

When you receive a new Voice Mail or alphanumeric message, your phone beeps three times. To change the number of beeps or to turn them OFF, use this feature.

- 3. Enter Feature** Press  or  to scroll to Setup Msg Tones and press  to select.
- 4. Select Msg Type** Press  or  to scroll to Text Msg Tone or Voice Mail Tone and press  to select.
- 5. Toggle Tone** Press  or  to scroll to 3Beep, 1Beep, or Off and press  to select.
- 6. Exit Menu** Press  to exit the menu, or you may scroll to other features.

Setup Msg
Tones 

Tip:
To make new messages easy to recognize, try making the number of beeps unique to each message type.

Getting to Tone Control...

- 1. Enter Menu** Press **FCN** then press **↕**.
- 2. Enter Tone Control** Press **▲** or **▼** to scroll to **Tone Control** and press **↕** to select.

DTMF

Select



Transmit Tones

Your phone transmits tones to communicate with automated calling systems like Voice Mail or bank by phone. These tones are called DTMF tones (Dual Tone Multi-Frequency tones), and this feature allows you to control the length of the tone your phone sends. For most systems, you should use the default setting of short tones, which sends the tones for a preset length of time. If you choose long tones, your phone will transmit the tones for as long as you press & hold the key. To silence the tones during conversations, turn the tones OFF.

Shortcut:

Press **FCN**, **↕**, then **3**, **3** and continue with step 4.

- 3. Enter Feature** Press **▲** or **▼** to scroll to **DTMF Select** and press **↕** to select.
- 4. Select Setting** Press **▲** or **▼** to scroll to **Transmit DTMF Long**, **Transmit DTMF Short**, or **Transmit DTMF Off** and press **↕** to select.
- 5. Exit Menu** Press **END** to exit the menu, or you may scroll to other features.

Note: If you turned the DTMF tones OFF, but you want to access a tone-activated system like Voice Mail, place your call, enter the numbers you need to transmit and:

Send Tones Press **RCL** then press **SEND** (or **TALK**) to send the tones if DTMF tones are OFF.

Reminder Tones Setup

If you subscribe to messaging services, this feature can help you remember to check your messages. Turn Message Reminder Tones ON and your phone will remind you of unread messages by beeping and /or vibrating every two minutes. This feature is especially helpful if you are busy or away from your phone.

- 3. Find Feature** Press **▲** or **▼** to scroll to *Reminder Tones Setup*.
- 4. Toggle Feature** Press **◀** to toggle the feature ON or OFF.
- 5. Exit Menu** Press **END** to exit the menu, or you may scroll to other features.

Service Tones

When Service Tones are ON, you will be instantly alerted to any change in your cellular service. You will hear two short beeps when your phone (1) starts to roam, (2) returns to a home system after roaming, (3) loses service, (4) finds service, or (5) moves from digital **D** to analog **A** service (or vice versa).

- 3. Find Feature** Press **▲** or **▼** to scroll to *Service Tones*.
- 4. Toggle Feature** Press **◀** to toggle the feature ON or OFF.
- 5. Exit Menu** Press **END** to exit the menu, or you may scroll to other features.

Keep in mind: Your phone will always beep if a call is dropped.

Reminder
Tones Setup

Service
Tones On

Lock/Security



While you probably would not want to leave your phone unattended, your phone has a number of built-in security features to prevent unauthorized use.

In this chapter we will explain how to:

- lock and unlock your phone.
- place emergency calls.
- view and change your lock code.
- restrict call placement and memory access.
- reset or clear your phone's settings.

Follow these symbols as a guide for using the keys on the side of your phone.

Press  to scroll up

Press  to select

Press  to scroll down



Road Map

Press **FCN** then press **▼** to enter the menu system.

Start:

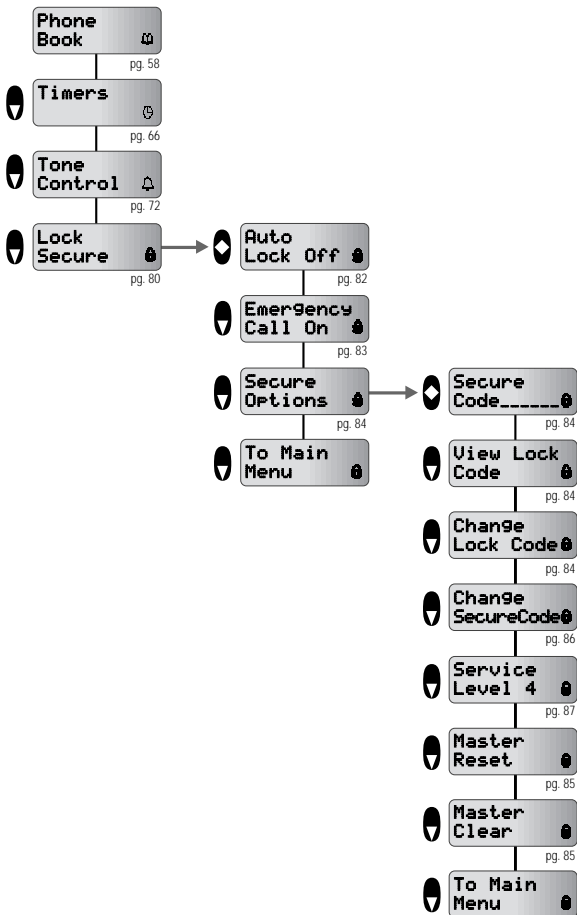

Getting to Lock/Security...

- 1. Enter Menu** Press **FCN** then press **⬇**.
- 2. Enter Lock/Secure** Press **⬆** or **⬇** to scroll to **Lock Secure** and press **⬇** to select.

Auto
Lock Off 

Auto Lock

Turn this feature ON and your phone will automatically lock itself each time the phone is turned OFF.

- 3. Find Feature** Press **⬆** or **⬇** to scroll to **Auto Lock**.
- 4. Toggle Lock** Press **⬇** to toggle the feature ON or OFF.
- 5. Exit Menu** Press **END** to exit the menu, or you may scroll to other features.

Locking the Phone

You can lock your phone manually at any time to help prevent unwanted use. Once locked, you can leave the phone ON or turn it OFF and the phone will remain locked.

- 1. Lock Phone** Press **FCN** then press **5**.
You will see: **Lock?**
- 2. Confirm** Press **⬇** or **STD**. You will see: **Locked**.

Unlocking the Phone

Unlocking your phone is quick and easy. Once your phone is ON, just enter your three-digit code. Your factory programmed lock code is 123. If you have changed this code and cannot remember what it is, see **Viewing the Lock Code** on page 84.

Keep in mind: You can still receive calls when the phone is locked. Follow these steps to answer an incoming call:

- Unlock & Answer** Enter your three-digit code and press **⬇** or **SEND** (or **TALK**) to answer.

Emergency Call

Your phone's emergency call feature allows you to instantly place a call from location 01 – even when your phone is locked.

- 3. Find Feature** Press **▲** or **▼** to scroll to Emergency Call.
- 4. Toggle** Press **◆** to toggle the feature ON or OFF.
- 5. Exit Menu** Press **END** to exit the menu, or you may scroll to other features.

Keep in mind: Some cellular systems only allow access to their own emergency numbers. Check with your Service Provider for more information.

Storing an Emergency Call Number

You should reserve memory location 01 for an emergency number or the number of a family member or close friend. To store your emergency number, follow these steps:

- 1. Enter Number** Enter your emergency number.
- 2. Save Number** Press **STO** and **0**, **1** to choose location 01. You will see: Alpha or Press *.
- 3. Enter Name** Enter a name if you like and press **◆** when finished. Your phone will confirm the entry by displaying the stored information.

Placing an Emergency Call

Place Call When Emergency Call is ON, press & hold **1** at any time.

Keep in mind: If call restriction Service Level 1 is enabled, the Turbo Dial® Keys will not be active. To override the restriction and place an emergency call, press **RCL**, **1**, **SEND** (or **TALK**). See page 87 for information on your phone's service levels.

Emergency
Call On 

Shortcut:

Press **FCN**, **◆**
then **2**, **9**
and continue
with step 4.

Getting to Lock/Security...

- 1. Enter Menu** Press **FCN** then press **⬇**.
- 2. Enter Lock/Secure** Press **⬆** or **⬇** to scroll to **Lock Secure** and press **⬇** to select.
- 3. Access Secure Options** Press **⬆** or **⬇** to scroll to **Secure Options** and press **⬇**. You will see: **Secure Code_____**
Enter your six-digit secure code.

Secure
Options 

View Lock
Code 

Shortcut:

Press **FCN**, **⬇**,
enter six-digit
security code,
then **RCL**.

Change
Lock Code 

Shortcut:

Press **FCN**, **⬇**,
enter your six-
digit secure
code, enter a new
lock code,
then **STD**.

Secure Options Submenu

For your protection, you must enter a six-digit secure code in order to access the features in the Secure Options submenu. The factory programmed secure code is 000000.

Viewing the Lock Code

To view the three-digit lock code:

- 4. View Code** Press **⬇** to select **View Lock Code**.
You will see: **Lock Code XXX**.
- 5. Exit Menu** Press **END** to exit the menu, or you may scroll to other features.

Changing the Lock Code







To change the three-digit lock code:

- 4. Begin Change** Press **⬆** or **⬇** to scroll to **Change Lock Code** and press **⬇** to select.
You will see: **Enter New Code_____**
- 5. Enter New Code** Enter a new three-digit lock code. You will see: **New Lock Code XXX**.
- 6. Exit Menu** Press **END** to exit the menu, or you may scroll to other features.

Master Reset

Use this feature to reset all user-selectable options back to their original factory settings.

Keep in mind: Once you select this feature, the reset process cannot be canceled or reversed.

4. **Reset Features** Press  or  to scroll to Master Reset and press  to select. You will see: Reset?
 5. **Confirm Reset** Press  to confirm. You will see: Standard Setting.
- or **Exit** Press  to exit without resetting.
6. **Exit Menu** Press  to exit the menu, or you may scroll to other features.









Master
Reset 

Master Clear

Use Master Clear to clear all user-selectable options, the resettable timer, the Phone Book, and the Messaging memory.

Keep in mind: Once you select this feature, the process cannot be canceled or reversed.

4. **Clear Settings** Press  or  to scroll to Master Clear and press  to select. You will see: Clear?
 5. **Confirm Clear** Press  to confirm. You will see: Busy. It will take a few seconds to reset all of your phone's options back to their factory settings.
- or **Exit** Press  to exit without resetting.
6. **Exit Menu** Press  to exit the menu, or you may scroll to other features.



Master
Clear 

Getting to Lock/Security...

- 1. Enter Menu** Press **FCN** then press **⬇**.
- 2. Enter Lock/Secure** Press **⬆** or **⬇** to scroll to `Lock Secure` and press **⬇** to select.
- 3. Access Secure Options** Press **⬆** or **⬇** to scroll to `Secure Options` and press **⬇**. You will see: `Secure Code_____`
Enter your six-digit secure code.

Secure Options Submenu

Change
SecureCode 







Changing the Secure Code

The Secure Code is a six-digit number factory set to 000000. You will probably want to change it to something unique and easy to remember.

- 4. Select Feature** Press **⬆** or **⬇** to scroll to `Change Secure Code` and press **⬇** to select. You will see: `New Code _____`
- 5. Enter New Code** Enter a new six-digit Secure Code. Your phone will briefly display the new code.
- 6. Exit Menu** Press **END** to exit the menu, or you may scroll to other features.

Service Level

When loaning your phone to others, you may want to restrict call placement or protect memory information. Your phone has two service levels that allow you to control the types of outgoing calls that can be made from your phone.

4. **Select Feature** Press  or  to scroll to Service Level and press  to select.
5. **Choose Level** Press  or  to scroll through service level settings and press  to select the setting. (See the chart below for descriptions.)
6. **Exit Menu** Press **END** to exit the menu, or you may scroll to other features.

Your phone has two service levels:

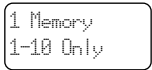
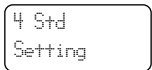
<p>Level 1: Calls can be placed from memory locations 1-10 only.</p> <ul style="list-style-type: none"> • No dialing from keypad. • No memory edit or storage. • No access to name directory. 	
<p>Level 4: This is the default setting.</p> <ul style="list-style-type: none"> • No restrictions. 	

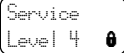

Phone Options



The Phone Options menu is your “command center” for adjusting the way your phone sends and receives calls. You can fine tune your phone for optimal performance, view information about your phone’s settings, and much more.

In this chapter we will explain how to:

- switch phone numbers.
- review your phone’s settings.
- select a variety of system specific settings.

Follow these symbols as a guide for using the keys on the side of your phone.

Press  to scroll up

Press  to select

Press  to scroll down



Road Map

Press **FCN** then press **▼** to enter the menu system.

Start:

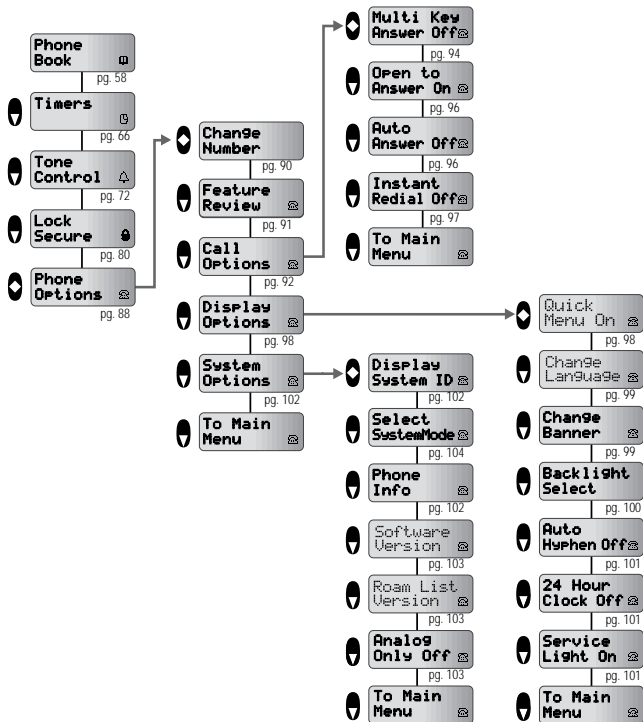

Getting to Phone Options...

1. **Enter Menu** Press **FCN** then press **↓**.
2. **Enter Phone Options** Press **↑** or **↓** to scroll to Phone Options and press **↓** to select.

Change
Number 

Changing Your Number

Your phone can be activated with two unique phone numbers. You could use one number for your home service and the other for a city that you travel to frequently. This feature allows you to select the number for the appropriate service.







Keep in mind: Only one number can be active on your phone at a time.

3. **Begin Change** Press **↓** to enter Change Number. The display will show your phone's currently active number.
4. **Choose Number** Press **↑** or **↓** to scroll through the phone numbers programmed into your phone. Press **↓** to select the desired number. You will see: Set.
5. **Exit Menu** Press **END** to exit the menu, or you may scroll to other features.

Feature Review

After you have spent some time adjusting your phone's settings, use this feature to review the changes you have made. When you enter Feature Review, your phone will display any features that you have changed from their default factory settings.

Keep in mind: Feature Review is simply an opportunity to review – but not change – your current settings.

- 3. Begin Review** Press  or  to scroll to Feature Review and press  to enter.
- 4. Browse Features** Press  or  to scroll through any features you have changed from their default settings. If all features are set to their default factory settings, the display will show: Standard Settings.
- 5. Exit Menu** Press  to exit the menu, or you may scroll to other features.

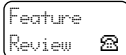



Shortcut:

Press  then , , .

Getting to Call Options...

1. **Enter Menu** Press **FCN** then press **↩**.
2. **Enter Phone Options** Press **▲** or **▼** to scroll to **Phone Options** and press **↩** to select.
3. **Enter Call Options** Press **▲** or **▼** to scroll to **Phone Options** and press **↩** to select.

Call
Options 

PIN
Inactive 

Call Options Submenu

This submenu gives you control over the way your phone places and receives calls.

Activating PIN Code

Your Service Provider may require a Personal Identification Number (PIN) when placing calls. If so, you will probably want to activate this feature, which allows you to send your PIN code with one touch of a button.

Keep in mind: If you enter a service area that does not require a PIN code, make sure PIN Inactive is set.

4. **Toggle PIN** Press **▲** or **▼** to scroll to **PIN Inactive** or **Active** and press **↩** to toggle.
5. **Exit Menu** Press **END** to exit the menu, or you may scroll to other features.

Storing PIN Code in Memory Location 07

When PIN Code is active, your phone automatically uses the number stored in location 07 as your PIN Code. Once you have activated the PIN code, you should store the PIN code in location 07.

- 1. Enter PIN** Enter your PIN Code.
- 2. Store PIN** Press **STD**, press **0**, **7**, and then press **◆**.

Placing a Call with PIN Code Active

When you place a call with PIN Code active, your phone will queue the number stored in location 07 and then send it when you press the Smart Button.

- 1. Place Call** Enter the number to be called, or recall it from memory and press **SEND** (or **TALK**) or press & hold **◆**.
- 2. Send PIN** After the call is placed, the system will prompt you for your PIN code. Press **SEND** (or **TALK**) or press & hold **◆** to send the PIN code.

Note: If you see *Invalid PIN*, the menu feature may be active but your PIN code is not stored in location 07. The PIN code must be less than seven digits.

Getting to Call Options...

1. Enter Menu Press **FCN** then press **↕**.
2. Enter Phone Options Press **▲** or **▼** to scroll to Phone Options and press **↕** to select.
3. Enter Call Options Press **▲** or **▼** to scroll to Phone Options and press **↕** to select.

Multi Key
Answer Off 

Call Options Submenu

Multiple Key Answer

With Multiple Key Answer ON, you can answer calls by pressing **↕** or any key in the center of the keypad, **1** through **#**.

4. Find Feature Press **▲** or **▼** to scroll to Multi Key Answer.
5. Toggle Feature Press **↕** to toggle the feature ON or OFF.
6. Exit Menu Press **END** to exit the menu, or you may scroll to other features.

Keep in mind: If there are any digits in your Scratchpad or if your phone is locked, this feature will not work.

Open to Answer

This feature allows you to set whether or not your phone automatically answers when opened. If you subscribe to Caller ID, you will probably want to set this feature OFF so you can open the phone and check who is calling before you answer.

- 4. Find Feature** Press **▲** or **▼** to scroll to **Open to Answer**.
- 5. Toggle Feature** Press **◆** to toggle the feature ON or OFF.
- 6. Exit Menu** Press **END** to exit the menu, or you may scroll to other features.

Note: To answer calls with Open to Answer OFF, press **SEND** (or **TALK**).

Open to
Answer On 

Getting to Call Options...

1. **Enter Menu** Press **FCN** then press **↕**.
2. **Enter Phone Options** Press **▲** or **▼** to scroll to Phone Options and press **↕** to select.
3. **Enter Call Options** Press **▲** or **▼** to scroll to Phone Options and press **↕** to select.

Auto
Answer Off 

Shortcut:

Press **FCN**, **↕**,
then **2**, **6**
and continue
with step 4.

Call Options Submenu

Automatic Answer

Turn Auto Answer ON to have your phone automatically answer incoming calls after two ring cycles.

4. **Find Feature** Press **▲** or **▼** to scroll to Auto Answer.
5. **Toggle Feature** Press **↕** to toggle the feature ON or OFF.
6. **Exit Menu** Press **END** to exit the menu, or you may scroll to other features.

Note: We recommend you use this feature only with vehicle accessories and with your phone's ringer active (pg. 75). Otherwise, your phone may answer a call in your absence.

Instant Redial

When placing calls, you may hear a fast busy signal and see **Press SMD to Redial**. This probably means the network is temporarily busy. If you turn Instant Redial ON, your phone will redial for the next four minutes or until the call goes through.

You will see: *Redialing*.

- 4. Find Feature** Press **▲** or **▼** to scroll to *Instant Redial*.
- 5. Toggle Feature** Press **◀▶** to toggle the feature ON or OFF.
- 6. Exit Menu** Press **END** to exit the menu, or you may scroll to other features.

Keep in mind: This feature redials only when the network is busy. If you hear a normal busy signal, this feature will not work.

Instant
Redial Off 

Tip:
See page 29 for
more redialing
options.

Getting to Display Options...

1. **Enter Menu** Press **FCN** then press **↩**.
2. **Enter Phone Options** Press **▲** or **▼** to scroll to **Phone Options** and press **↩** to select.
3. **Enter Display Options** Press **▲** or **▼** to scroll to **Display Options** and press **↩** to enter.

Display
Options 

Quick
Menu On 

Display Options Submenu

This submenu allows you to customize your phone's display.







Activating the Quick Menu

Press the Smart Button once and the Quick Menu appears on the display, offering shortcuts to the most popular features. This feature turns the Quick Menu OFF if you would rather use the Smart Button to go straight into the Phone Book. See page 34 for more information.

4. **Toggle Feature** When you enter Display Options, you will see: Quick Menu. Press **↩** to toggle the feature ON or OFF.
5. **Exit Menu** Press **END** to exit the menu, or you may scroll to other features.





Changing the Language

This feature allows you to select the language in the display.

- 4. Begin Selection** Press  or  to scroll to Change Language and press  to select.
- 5. Choose Option** Press  or  to scroll through the available languages and press  to select.
- 6. Exit Menu** Press  to exit the menu, or you may scroll to other features.

Changing the Banner

You may create your own message banner for the phone to display when it is idle. Your banner can be up to 12 characters long.

- 4. Enter Feature** Press  or  to scroll to Change Banner and press  to select. You will see the current banner or Alpha or Press *.
- 5. Enter Message** Enter your message using the alphanumeric keypad. Press  when your message is complete.
- 6. Exit Menu** Press  to exit the menu, or you may scroll to other features.

Change
Language 

Change
Banner 

Getting to Display Options...

1. **Enter Menu** Press **FCN** then press **↩**.
2. **Enter Phone Options** Press **▲** or **▼** to scroll to *Phone Options* and press **↩** to select.
3. **Enter Display Options** Press **▲** or **▼** to scroll to *Display Options* and press **↩** to enter.

Backlight
Selection 

Display Options Submenu

Customizing the Backlight





Your phone's backlight illuminates when you open the phone, press a key, or receive an incoming call signal. This feature allows you to choose how long it remains ON.

4. **Find Feature** Press **▲** or **▼** to scroll to *Backlight Selection* and press **↩** to select.
5. **Toggle Feature** Press **▲** or **▼** to scroll to *15 Seconds*, *30 Seconds*, or *Always On* and press **↩** to select the displayed option.
6. **Exit Menu** Press **END** to exit the menu, or you may scroll to other features.

Keep in mind: The backlight will always be illuminated when your phone is connected to an external power supply, like a charger or vehicle accessory.

Auto Hyphen





Just turn Auto Hyphen ON to have all phone numbers automatically hyphenated on the display. This allows you to easily distinguish between area codes, call prefixes, and other numbers.

4. **Find Feature** Press  or  to scroll to Auto Hyphen.
5. **Toggle Feature** Press  to toggle the feature ON or OFF.
6. **Exit Menu** Press  to exit the menu, or you may scroll to other features.

Auto
HyphenOff 

Displaying the 24-Hour Clock





Your phone can display the current time in 12-hour or 24-hour format. Use this feature to turn the 24-hour clock ON or OFF.

4. **Find Feature** Press  or  to scroll to 24 Hour Clock.
5. **Toggle Feature** Press  to toggle the feature ON or OFF.
6. **Exit Menu** Press  to exit the menu, or you may scroll to other features.

24 Hour
Clock Off 

Service Light

The Service Light can be useful to quickly check the current state of your phone's service. If you prefer to conserve standby-time, you can turn the Service Light OFF with this feature.

4. **Find Feature** Press  or  to scroll to Service Light.
5. **Toggle Feature** Press  to toggle the feature ON or OFF.
6. **Exit Menu** Press  to exit the menu, or you may scroll to other features.

Service
Light Off 

Getting to System Options...

- 1. Enter Menu** Press **FCN** then press **↵**.
- 2. Enter Phone Options** Press **▲** or **▼** to scroll to **Phone Options** and press **↵** to select.
- 3. Enter System Options** Press **▲** or **▼** to scroll to **System Options** and press **↵** to enter.

System
Options 

Display
SID 

Phone
Info 

System Options Submenu

The System Options submenu offers a couple features that will help you use your phone and cellular network.

Displaying the System ID

Use this feature to determine the unique System ID for your cellular phone.

- 4. View SID** Press **↵** to select **Display SID**. You will see the System ID for your phone.
- 5. Exit Menu** Press **END** to exit the menu, or you may scroll to other features.

Displaying Phone Information

This feature allows you to view information about your phone. If you require technical assistance, you may be asked to check here.

- 4. Find Feature** Press **▲** or **▼** to scroll to **Phone Info** then press **↵** to select.
- 5. Scroll** Press **▲** or **▼** to scroll through the options.
- 6. Exit Menu** Press **END** to exit the menu, or you may scroll to other features.

Displaying the Roam List Version

If you require technical assistance, you may need to check this feature, which displays your phone's Roam List Version.

4. **View Roam List** Press **▲** or **▼** to scroll to Roam List Version then press **▶** to select. You will see: Version XXXX.
5. **Exit Menu** Press **END** to exit the menu, or you may scroll to other features.

Roam List
Version 

Displaying the Software Version

This feature displays the Software Version used by your phone and may be useful if you require technical assistance.

4. **View Software Version** Press **▲** or **▼** to scroll to Software Version then press **▶** to select. You will see: Version XXXX.
5. **Exit Menu** Press **END** to exit the menu, or you may scroll to other features.

Software
Version 

Analog Only

Turning Analog Only ON tells your phone to select an analog channel  for the next call. If you do not place a call, your phone will revert to dual mode service after a few minutes.

Note: Some peripheral devices, like fax machines and modems, require analog operation.

4. **Find Feature** Press **▲** or **▼** to scroll to Analog Only.
5. **Toggle Feature** Press **▶** to toggle the feature ON or OFF.
6. **Exit Menu** Press **END** to exit the menu, or you may scroll to other features.

Analog
Only Off 

Shortcut:

Press **FCN** then **2** to toggle Analog Only ON or OFF.

Getting to System Options...

- 1. Enter Menu** Press **FCN** then press **↩**.
- 2. Enter Phone Options** Press **▲** or **▼** to scroll to **Phone Options** and press **↩** to select.
- 3. Enter System Options** Press **▲** or **▼** to scroll to **System Options** and press **↩** to enter.

Select
SystemMode 

Shortcut:
Press **RCL**
then **←***.

System Options Submenu

Selecting a System Mode

Your Service Provider configures Select System Mode when you receive your phone. This feature allows you to select the type of system your phone will attempt to access. See below for a chart of available settings.

- 4. Begin Selection** Press **▲** or **▼** to scroll to **Select SystemMode** and press **↩** to enter. The display will show your phone's current System Mode setting.
- 5. Choose Mode** Press **▲** or **▼** to scroll through the System Mode settings (see chart on next page). Press **↩** to select the displayed setting.
- 6. Exit Menu** Press **END** to exit the menu, or you may scroll to other features.

Selecting a System Mode

<p>Standard Mode: Your phone first seeks a home type system, then a non-home type system.</p> <p><i>If home system is non-wireline (type A)</i></p> <p><i>If home system is wireline (type B)</i></p>	<p>Std BA</p> <p>Std AB</p>
<p>Reversed Preference Mode: Your phone first seeks a non-home type system, then a home type system. (This mode may be useful in fringe areas or certain roaming situations.)</p> <p><i>If home system is non-wireline (type A)</i></p> <p><i>If home system is wireline (type B)</i></p>	<p>Scan BA</p> <p>Scan AB</p>
<p>Home Only Mode: Phone will not operate outside its home system.</p>	<p>Home Only</p>
<p>Scan A Mode: Phone will operate only within non-wireline (A) systems.</p>	<p>Scan A</p>
<p>Scan B Mode: Phone will operate only within wireline (B) systems.</p>	<p>Scan B</p>
<p>Preferred System ID Mode: Phone will scan for home or programmed preferred SIDs first. This choice requires entry of up to 60 System ID numbers for those systems in which you wish to operate. Contact your Cellular Service Provider for SID information.</p>	<p>Preferred SID Scan</p>

Accessory Options

An exciting line of accessories can enhance and personalize your digital cellular experience.

Lithium Ion Batteries

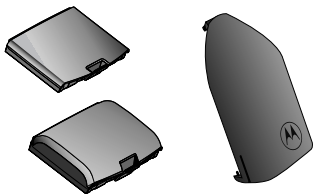

Motorola's Lithium Ion (LiIon) batteries are high energy-density batteries that offer increased capacity and are lighter in weight than similar sized Nickel Cadmium and Nickel Metal Hydride batteries.

Nickel Metal Hydride Batteries

Nickel Metal Hydride batteries (NiMH) are high-capacity batteries that offer up to 30% more talk-time than comparable Nickel Cadmium batteries. To help achieve maximum life and capacity for your NiMH battery, do not leave the battery in the charger for more than 24 hours, and use only Motorola-approved chargers.

Cigarette Lighter Adapter

Lets you plug into a reliable power source on the road. Uses your car's battery to power your phone and rapid charge its battery at the same time. The Cigarette Lighter Adapter will not overcharge your battery and contains circuitry to protect against overvoltage and power surges in the vehicle. In some cars, the engine must be running in order for the cigarette lighter to operate.



Accessory Options

Desktop Charger (AC Adapter Required)

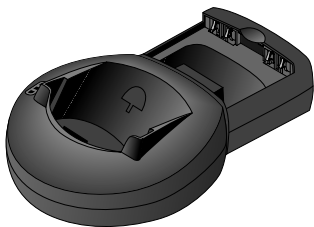

This charger can be loaded with up to three batteries. Equipped with one LED charging status indicator for each battery, the charger's front pocket can charge both a main and an auxiliary battery attached to a phone, and the rear pocket can charge one battery by itself. For use with Lithium Ion, Nickel Cadmium and Nickel Metal Hydride batteries.

Holster

Your Digital StarTAC® phone is so small and light, it is positively wearable. Slip it in the holster and clip the holster on— for the ultimate in high-tech fashion.



Headset



The convenient headset provides both an earphone and microphone in one small piece for simple hands-free and private telephone conversations. The headset plugs directly into the jack on the top of your phone, so that you can wear your phone and move freely. Place the foam cover on the earpiece for a more comfortable fit. See pages 92-97 for Call Options that make using a headset with your phone even more convenient.

PCMCIA Modems

These compact modems are made for mobility, with cable attachments that plug directly into the bottom of your Motorola cellular phone. They support fax, e-mail, and data transmission. The PCMCIA modems work with data devices using a standard PCMCIA Type II slot.

Accessory Options

Hands-Free Vehicle Kit

Optional Hands-Free Kits give you the convenience of hands-free, speaker phone operation while in your car. Full duplex operation lets you simultaneously talk and listen, so both parties can interrupt each other for a normal sounding conversation.

The Hands-Free Kit powers the phone and charges its battery whenever your car's engine is running.

Keep in mind: Motorola offers a 3-Watt Vehicular Kit, which includes a 3-watt booster for analog signals. Since the Digital StarTAC® phone is a digital phone, it is not compatible with the 3-Watt Kit.

Important: We recommend you use genuine Motorola batteries and accessories. Under its cellular telephone warranty, Motorola specifically disclaims any responsibility for damage caused by the use of portable cellular telephone accessories not manufactured by Motorola.

Zero Install Car Kit

For the quickest and easiest mobile solution, use the Zero Install Car Kit. Just plug it in, attach the microphone, and you are ready to go!



Troubleshooting

Q. I pressed the power button, but nothing happened. What's wrong with my phone?

- A.** Check that you have installed a battery and that the battery is charged. See page 12 for information about installing your battery.

Q. The display says *Locked*. How do I unlock my phone?

- A.** Try entering the last three digits of your cellular number. If that does not work, try using the factory preset lock code: 123. If this fails, call your Service Provider (the company that sends you your monthly cellular bill) for assistance. For more information on your phone's security features, see the Lock/Security chapter, page 80.

Q. My battery did not last as long as I expected. What can I do to extend battery life?

- A.** To get the most from your battery, make sure it is fully charged. To charge the battery to 100% of its capacity, leave it in the charger for an extra hour after the charger's light turns green.

Exposing your battery to extreme temperatures—below -10°C (14°F) or above 45°C (113°F)—can shorten battery life. Batteries are especially sensitive to high temperature extremes. It is a good idea to always take your phone with you when you leave your car.

Q. I tried to place a call and received a fast busy signal.

- A.** This sound means that your call was not processed. For example, the network may be temporarily busy. To redial the number, press the Smart Button or press **SEND** (or **TALK**) before ending your call attempt, or press **END** and try the call again later. See page 97 for more information on redialing.

Troubleshooting

Q. I tried to place a call but received an alternating high/low tone. What does this mean?

- A.** This sound means your call did not connect to the network. Most likely, you dialed the number too soon after turning the phone ON. Wait until the NS indicator disappears before placing a call.

An alternating tone may also indicate that your phone's signal is blocked. Make sure the antenna is fully extended and move clear of any obstructions, like bridges, parking garages, tall buildings, etc.

Q. Whenever I turn the phone ON, the display says: Invalid Battery. What does this mean and why am I not able to charge the battery?

- A.** Your cellular phone uses the Motorola Expert Performance (E•P) Charging System. The E•P system enables the built-in charger to communicate with attached batteries and tailor its charging cycle to optimize performance.

If you see *Invalid Battery* when you power up the phone, the built-in charger is not able to communicate with the battery and cannot charge it. You could see this message for several reasons. The most likely one is that the battery is not a Motorola original and it does not have the appropriate E•P technology. We recommend that you use only Motorola original batteries and accessories and that you store your batteries in their protective covers when not in use.

Q. My phone started beeping, and the display says: 1 Call Unanswered. What happened?

- A.** Someone tried to call you while you were in an area where the signal was weak. Press **CLR** to clear your display, extend your phone's antenna, and avoid obstructions like tunnels, parking garages and tall buildings whenever possible.

Q. My phone was stolen. What should I report and to whom?

- A.** Report a stolen phone to the police and to your Service Provider (the company that sends you your monthly cellular service bills).

Glossary

A

AC Adapter An accessory device that allows you to power and/or charge your phone from a wall outlet. See page 16.

accessory connector A socket on the bottom of the phone where you can attach accessories such as an AC Adapter or cigarette lighter adapter. To learn more, see page 16.

air-time The amount of time you spend using a cellular system, between the time you successfully place a call and the termination of that call.

alkaline A battery technology used in personal cellular telephones.

analog The traditional method of cellular transmission. In addition to analog capability, your phone is equipped to handle digital transmission. See also CDMA.

antenna The device on your phone that sends and receives cellular signals.

Auto Answer When you activate this feature, your phone automatically answers after two rings. See page 96.

Automatic Redial When your cellular network cannot handle your call, this feature enables your phone to automatically redial with one button push. See page 29.

C

Call Back number A phone number in a text message, provided by the sender. See page 54.

Caller ID A network/subscription dependent service that allows you to view information on incoming calls before answering. See page 50.

CDMA (Code Division Multiple Access) CDMA takes digitized voice and encodes it in a unique scheme that is sent out over the air. CDMA digital reduces the probability of dropped calls. Your phone is equipped to handle CDMA digital voice transmission.

cellular carrier One of multiple competing companies in a given geographic area that owns and operates a cellular system.

Cellular Service Provider A company affiliated with a cellular carrier that provides cellular service to its customers.

cellular signal The radio waves that carry information between your cellular phone and the cellular system.

cellular system The cellular equipment in a given geographic area that relays signals to and from individual cellular telephones and the landline telephone system.

cigarette lighter adapter An accessory device that allows you to power and/or charge your phone from a car's cigarette lighter.

Glossary

D

dedicated Message Key See Message Key.

default A feature's original setting as programmed in the factory.

digital See CDMA.

DTMF Dual Tone Multi-Frequency are the tones that your phone transmits to communicate with tone activated phone systems like Voice Mail or bank-by-phone. See page 78. Keep in mind: "DTMF Tones" does not refer to the sounds produced by your phone's speaker. See Keypad Tones for information on the sounds produced by your phone's speaker.

E

Emergency Call This feature allows you to place a call from memory location 01 even if the phone is locked. See page 83.

F

fringe area The outermost range of a cellular system where cellular signals are weak.

function keys The non-numeric keys on your phone used to access and navigate menu features, as well as perform memory functions. See page 20.

H

Home Only Mode When your phone is active in this System Mode setting and you are beyond the range of your home Service Provider, your phone will not operate. See page 104. See also system type.

home system The local cellular system where you obtain your cellular service.

home type system A cellular system of the same type as the local cellular system where you obtain your service. See also non-home type system and system type.

I

icon One of the variety of symbols used to designate menu features and messages.

indicator A symbol on your phone that gives you information about your phone's status. See pages 24-27.

Instant Redial This feature enables your phone to redial when your cellular network is temporarily unable to handle your call. Your phone will automatically attempt the call for four minutes or until it is picked up by the network. See page 97.

Internal Rapid Charger A charger built into your phone for use with an AC Adapter or cigarette lighter adapter. See page 16.

Glossary

K

Keypad Tones The sounds produced through your phone's speaker when you press the keys. See page 76. Keep in mind: "Keypad Tones" does not refer to the tones sent by your phone to communicate with automated phone systems. See Transmit Tones for information on the tones used to access automated phone systems.

L

landline The telephone system used for conventional office and home phones.

Lithium Ion (LiIon) A battery technology used in personal cellular telephones. Lithium Ion batteries generally provide more energy capacity than Nickel Metal Hydride batteries of the same weight.

lock To prevent unauthorized access to the cellular telephone. See page 82.

lock code A three-digit code used to access your phone once it has been locked. The factory programmed lock code is 123. To view or change your lock code, see page 84.

M

memory location A space in the Phone Book where you can store a telephone number and a name. Each of the Phone Book's 99 memory locations (numbered 01-99) can hold up to 32 digits and 24 letters.

menu This system contains five features: Phone Book, Timers, Tone Control, Lock/Secure, and Phone Options.

menu feature Any feature that can be accessed through the menu system.

Message Key Located on the bottom row of the keypad, the dedicated Message Key offers One-Touch Access to messages and messaging functions. See page 48. See also Caller ID, Messages, and Voice Mail.

Messages A network/subscription dependent service that enables your phone to receive text messages and numeric pages just like a pager. See page 54.

Messaging Function Menus While viewing your Caller IDs, reading your Messages, or checking your Voice Mail, you can use these menus to manage your messages: lock or unlock a text message, delete one or all of your Caller ID or text messages and numeric pages, or select a different message type.

Glossary

N

Nickel Cadmium (NiCd) A battery technology used in personal cellular telephone batteries.

Nickel Metal Hydride (NiMH) A battery technology used in personal cellular telephone batteries.

non-home type system A system type different from your home system. See also home type system and system type.

non-wireline See system type.

P

pause A special character that tells your phone to wait before sending the next set of numbers stored in one memory location. See Pause Dialing.

Pause Dialing A method of storing Phone Book entries that allows you to store multiple strings of numbers in one memory location; useful, for instance, in accessing automated phone systems. See page 44.

Personal Identification Number (PIN) A private numeric password which protects personal accounts such as bank-by-phone or Voice Mail.

Phone Book An alphabetical list of the names and telephone numbers you have stored into your phone's internal memory.

Preferred System ID Mode When your phone is in this system mode setting, it will scan for systems on a preferred list. This choice requires entry of up to 60 System ID numbers. Contact your Service Provider for SID information.

prompt A display message requesting input.

Q

Quad Number Your phone can be activated with up to four different phone numbers. See page 90 to learn how to change the number active on your phone.

R



Reversed Preference Mode When your phone is active in this System Mode setting and you are beyond the range of your home Service Provider, your phone will seek a non-home type system, then a home type system. See pages 103-104. See also system type.

road map The visual representation of your phone's menu system provided in this manual.



roam To use a cellular system outside of your home system, usually when you travel beyond the range of your home system.

Glossary

S

- Scan A Mode** When your phone is active in this System Mode setting and you are beyond the range of your home Service Provider, your phone will only operate on non-wireline type systems. See pages 103-104. See also system type.
- Scan B Mode** When your phone is active in this System Mode setting and you are beyond the range of your home Service Provider, your phone will only operate on wireline type systems. See pages 103-104. See also system type.
- Scratchpad** A memory feature that automatically remembers the most recent number entered into the keypad. See page 43.
- Scratchpad tones** See DTME.
- scroll** To move backward or forward through a list; for example, to move backward or forward through the menu system or the Phone Book using either the volume keys or the  and  keys.
- secure code** A six-digit code used to access and change certain security features. The factory programmed secure code is 000000.
- Service Provider** See Cellular Service Provider.
- Service Tones** Two short beeps used to alert you to changes in your cellular service. See page 79.
- signal** See cellular signal.
- Silent Mode** Select this feature and all your phone's tones will be silenced and the VibriCall® Alert activated. See page 74.
- Smart Button** The middle key on the side of your phone used to access the Phone Book, place calls, end calls, select the Phone Book, enter the menu system, and toggle features ON and OFF.
- soft-handoff** Unlike traditional analog technology where you are disconnected from one site and then connected to another, CDMA digital technology connects you to a new site before disconnecting you from the old site. This is known as a "soft-handoff." With soft-handoff technology, you could experience fewer dropped calls.
- Standard Mode** When your phone is active in this System Mode setting and you are beyond the range of your home Service Provider, your phone will seek a home type system, then a non-home type system. See page 104. See also system type.
- standby-time** The total time your phone is ON but not used for talking.

Glossary

Super Speed Dial A dialing shortcut that allows you to quickly dial any number in the Phone Book. To use this feature, enter the two-digit location of the number, 01-99, then press and hold Smart Button or press  (or ) and the call is placed. See page 42.

System ID Every cellular system has a unique number to identify itself. See page 102.

System Mode A setting that determines the system type that your cellular phone will access. See page 104 to select a System Mode.



system type A designation that indicates one of the two competing cellular carriers in a given geographic area. The non-wireline carrier operates on the “A” block of cellular frequencies, and the wireline carrier operates on the “B” block of cellular frequencies.

T

talk-time The total time that you can talk on your phone before the battery is fully discharged.

toggle To switch between two possible options; for example: ON vs. OFF. Pressing the Smart Button toggles features ON or OFF.

Transmit Tones See DTMF.

Turbo Dial® keys To use this feature, press and hold a number on the keypad,  through , and your call is placed.

U

unlock code See lock code.

V

VibraCall® Alert When activated, this feature alerts you silently of incoming calls by vibrating. It can be used alone or in conjunction with the ringer. See page 75.

Voice Mail Contact your Service Provider for availability.

volume keys Located on the side of your phone, the upper and lower volume keys are used to adjust ringer and keypad volume. They also scroll within the menu system and the Phone Book.

W

wireline See system type.

Patent Information

Manufactured under one or more of the following U.S. patents:

4121218	4630305	D299136	5004992	5166596	5363071	D367640
4138681	4633141	4797929	D315907	5175759	5365549	5499394
4193036	4636593	4798975	5008925	5175874	D352497	5506490
4254382m	4636741	4800348	D316417	D332261	5366826	D368696
4302845	D288432	4802236	D316859	5182749	D353131	5510693
4312074	4648125	4809356	5017856	D332785	D353361	5511235
4327319	4649543	4811377	5018188	5185566	5375143	D369162
4329666	D288683	4811404	5020091	5187809	5375258	5513078
4369516	4654655	4827226	5020092	5193223	5379324	D369359
4369522	D289156	4827507	5020093	5195106	D354055	5519303
4378603	4662691	4829274	5028083	5195108	D354062	5519346
4390963	4667333	4837534	5028859	5201069	5384825	5524276
D269873	4668917	D301476	5029044	5204977	D356084	5524278
4398265	4670747	4843621	5029233	5210793	5402447	D370463
4400584	4672502	4845772	5031028	5214675	5406146	5530922
4400585	4680787	D302015	5036532	5222104	5406562	5542116
D270835	4681476	4851966	5053924	5222251	D357224	5544250
D271491	4683585	4868576	5057762	D337332	D357457	D372481
Re. 31470	4692726	4870686	D320780	5230007	5410741	5546275
4431977	4704588	D303656	5059885	5230093	D357680	5546380
4434461	D292578	4876552	5060294	5233633	D357681	D372896
4455534	4706036	4879533	D322783	5235492	5428836	5551078
4462098	D292920	D305427	D322955	5237257	D359734	5559471
D275951	4710724	4896124	5081674	5239127	D359735	D374424
4484153	4711361	4897873	5083304	5241545	D359959	D374872
4485486	4715063	D305717	D324024	5241548	5432017	5572193
4486624	4716319	4904549	D324388	5241650	D360632	5574976
D276809	4716391	4905288	5095503	5241693	5438684	D377268
4491972	4723305	4905301	D325028	5242767	D361070	D375732
D277667	D294257	D306293	D325583	D339582	5442680	D375733
4504834	4727306	D306441	5109536	5249302	5446763	D375734
D278708	4727583	D306594	D325915	5251331	5448763	D375932
4523155	4730195	4912602	5113436	D340710	5448771	D375952
4546329	4734635	4918732	5117450	5260988	5453997	D376127
4550426	4736277	4922178	5121047	5261119	D362840	5588041
4551696	4737976	4945570	5122480	5262710	5457744	5589796
4564821	4740794	4954796	5122722	5263052	5459640	5590177
D282169	4741018	4959851	D327061	5276707	5463646	5594778
4571595	4741034	4963812	5128834	5278994	5465412	5594951
4573017	4742562	4963843	D328302	D343173	5469177	D377792
4574243	D295627	4965537	5142551	5280637	5475752	D377934
4585957	4746242	4972355	5142696	D344087	D365094	5604050
4602218	D295973	4972432	5146620	5287553	D365817	5606730
D284759	D295975	4972455	5148471	5287555	5486843	D378366
D285439	4751737	4975808	5148473	5287556	5487184	5613229
4616314	D296187	4984290	5148961	D344511	5488335	5613863
4617520	4761621	D314173	5150359	5301365	5488649	5615233
D286778	4764737	D315330	5150384	5321847	D366872	5621763
4626309	D297734	D315346	5152006	D348880	5493198	
4628529	D297735	D315543	5157693	5349588	5493714	
4629829	4777564	D315559	5163159	5359696	5497126	
4630304	Re. 32768	D315565	5164652	5361400	5497382	

Other patents pending.

Index

A

- AC adapter 16–18
- accessory connector 20
- account numbers, storing 44–45
- adjusting volume 33
- alpha characters, entering 39
- Analog Indicator 23, 25
- Analog Only 103
- answering calls 30–31
 - automatic answer 96
 - multiple key answer 94
- antenna 20
- audible timers
 - one minute 70
 - repeating 71
 - single 71
- Authentication Entry 87
- auto display timer 70
- auto lock 82
- automated systems
 - calling 44–45
 - storing number 44–45
- automatic answer 96
- automatic redial 29

B

- banner 99
- batteries 12–17
 - chargers 16–19
 - charging 16–21
 - covers 12–13
 - installing 14–15
 - storage & disposal 17
 - varieties 106
- battery level
 - indicator 24
 - shortcut 35

C

- Call Back messages 54
- Call Options 92–97
- Call Timers 66–71
 - road map 67
- Caller ID 30
 - deleting 51
 - number preference 63
 - options 51

- viewing 50
- calling cards
 - storing numbers 46
 - using 47
- changing lock code 84
- changing secure code 86
- changing the banner 99
- changing your number 90
- chargers 16–19
 - desktop 18–19
 - Internal Rapid 16
- charging batteries 16–19
- checking your voice mail 52
- cigarette lighter adapter 16, 106
- clear key 20
- Clear, Master 85
- clearing
 - Caller ID 51
 - Messages 55
 - Phone Book entries 41
 - settings 85
 - Voice Mail notification 53
- clock 24
 - display format 101
- cumulative call timer 69

D

- deleting
 - Caller ID 51
 - Messages 55
 - Phone Book entries 41
 - Voice Mail notification 53
- desktop charger 18–19
 - indicator lights 19
 - times 19
- dialing
 - emergency call 83
 - restricting 87
- Digital Indicator 24
- display 20
 - individual call timer 68, 70
 - last ten numbers dialed 29
 - lock code 84
 - system ID 102
 - your number 63
- Display Options 99–101
- displaying

caller's numbers **63**
displaying the 24-Hour Clock **101**
DTMF tones **78**
storing **44–47**

E

earpiece **20**
editing memory **64–65**
emergency call **83**
ending calls **28**
entering names **39**
entries, clearing **41**

F

fax compatibility **107**
flip **20**
function key **20**

G

Getting Started **10–21**
Glossary **111–116**

H

Hands-Free Vehicle Kit **106**
headset **107**
headset jack **20**
holster **107**
Home Only Mode **105**

I

In Use Indicator **25**
incoming calls **30–31**
indicators
 Analog **25**
 battery level **24, 26**
 desktop charger lights **19**
 Digital **24**
 In Use **25**
 No Service **25**
 Roam **25**
 Service Light **27**
 Signal Strength **24**
 Silent Mode **25**
 Unanswered Call **31**
 VibraCall® On **25**
 Vibrate Then Ring **25**
individual call timer **68**
 auto display **70**
installing batteries **14–15**
Instant Redial **97**

Internal Rapid Charger **16**

K

keypad cover **20**
Keypad Tones **76**

L

LAN compatibility **107**
last ten numbers dialed **29**
letters, entering **39**
Lithium Ion Batteries **106**
lock
 automatically **82**
 manually **82**
 messages **55**
lock code
 changing **84**
 viewing **84**
Lock/Security **80–86**
 road map **81**

M

Master Clear **85**
Master Reset **85**
memory **36–43**
 editing **64–65**
 Phone Book **58–63**
 recalling **40–42, 60–61**
 storing **38, 62**
 tips **37**
menu features **56**
Messages
 Call Back **54**
 lock/unlock **55**
 options **55**
 reading **54**
 receiving **49**
Messaging Menu **48**
microphone **20**
modem compatibility **107**
multiple key answer **94**
mute the phone **32**

N

names
 clearing **41**
 entering **39**
 recalling **40, 60, 61**
 viewing **63**
navigating the menu **56**

Nickel Metal Hydride Batteries **106**

No Service Indicator **25**

number

changing yours **90**

viewing others **63**

viewing yours **63**

number character **46–47**

Number Preference **63**

numbers

recalling **40–42**

storing **38**

O

one minute timer **70**

outgoing calls

controlling **87**

placing **28**

P

Pause Dialing **44–45**

PCMCIA Modems **107**

personalizable banner **99**

Phone Book **58–63**

editing **64–65**

memory **36–43**

recalling **60–61**

road map **59**

status **61**

storing **38, 62**

phone lock

automatically **82**

manually **82**

phone number

changing yours **90**

viewing others **63**

viewing yours **63**

Phone Options **88–103**

road map **89**

PIN code

activating **92**

storing **93**

using **93**

placing calls **28**

emergency call **83**

redial **29**

power key **20, 22**

Preferred System ID Mode **105**

R

reading the indicators **24–27**

reading your messages **54**

real time clock **24**

recall key **20**

recalling

by location **41**

by name **40, 60, 61**

shortcuts **42**

receiving calls **30–31**

automatic answer **96**

multiple key answer **94**

receiving messages **49**

redial **29**

automatic **29**

Instant **97**

last ten numbers dialed **29**

repeating timer **71**

Reset, Master **85**

resettable call timer

resetting **69**

viewing **68**

Reversed Preference Mode **105**

ringer

silencing **74–75**

style **75**

volume **33**

ringer/vibrator **74–75**

road maps **57**

Call Timers **67**

Lock/Security **81**

Phone Book **59**

Phone Options **89**

Tone Control **73**

Roam Indicator **25**

roam list version **103**

S

Safety Information **6–9**

Scan A Mode **105**

Scan B Mode **105**

Scratchpad **43**

Scratchpad Tones **78**

scroll keys **20**

secure code, changing **86**

Secure Options **84–86**

security **80–86**

selecting a system mode **104–105**

selecting ringer style **75**

send key **20**

service level **87**

Service Light **27, 101**

Service Tones **79**
shortcuts **34**
signal strength **24**
Silent Mode **74–75**
 Indicator **25**
silent mode **32**
single timer **71**
Smart Button **21**
software version **103**
Standard Mode **105**
store key **20**
storing **38, 62**
 Call Back number **54**
 while on a call **43**
Super Speed Dial **42**
system ID, viewing **102**
System Mode **104–105**
system mode **104**
System Options **102–103**

T

Three-Watt Vehicular Kit **108**
timers
 audible **70–71**
 cumulative **69**
 individual **68, 70**
 one minute **70**
 repeating **71**
 resettable **68, 69**
 single **71**
Tone Controls **72–78**
 Basic **32–33**
 road map **73**
 volume **33**
tones
 keypad **76**
 service **79**
 storing **44–47**
Transmit Tones **78**
 storing **44–47**
Turbo Dial® keys **42**
 emergency call **83**
Turning Your Phone On **22**

U

unanswered call indicator **31**
unlock/lock **82**
Using Messaging **48–55**

V

VibraCall® Alert **32, 74–75**
VibraCall® On Indicator **25**
Vibrate Then Ring Indicator **25**
vibration mode **32**
viewing
 Caller IDs **50**
 cumulative call timer **69**
 individual call timer **68, 70**
 lock code **84**
 resettable call timer **68**
 your number **63**
Voice Mail
 calling **44–45**
 checking **52**
 deleting notification **53**
 options **53**
 storing number **44–45**
volume keys **20**
volume, adjusting **33**

Y

Your Phone & Its Shortcuts **34**

Z

Zero Install Car Kit **108**