

APPLICANT: MOTOROLA, INC.

TRANSCIVER TYPE: IHDT5YD1

A preliminary user manual follows.

Welcome

Thank you for choosing Motorola—a global leader in communications technology.

All Motorola cellular phones are designed and manufactured in the United States to meet Motorola's exacting specifications and world-class quality standards. During development, our laboratory testing team took the durable dual mode StarTAC™ phone through its paces. They cooked it, steamed it, shook it, shocked it, dusted it, and dropped it—and the phone still worked! We are confident that the one you purchased will meet your own exacting standards.

Thank you for choosing Motorola, and by all means, enjoy your dual mode StarTAC cellular phone!

Guide Overview

Okay, you've got a brand new phone with a bunch of nifty features.

Now what?

Afraid you'll press the wrong key?

Or forget a feature or two?

Don't sweat it!



We've designed this guide to take you step-by-step through each feature of your new dual mode StarTAC™ phone. We'll show you what key to press and what happens when you press it. Follow along, chapter-by-chapter, and you'll find it's as easy as 1-2-3.

Here's an idea of what you'll learn in each chapter:

Introduction

There are many exciting features on your new phone, like the new, enlarged display and a clock that sets itself automatically. Find out exactly what's in store by turning to the "Introduction" on page 6.

Getting Started

First things first. Turn to page 14, and we'll explain what came with your phone. Then, we'll show you how to install and charge your battery so that you can get started with "The Basics" in the next section.

The Basics

What do all those buttons and lights mean? How do I make my first phone call? In this section, we'll answer those questions and get you going with your dual mode StarTAC phone. Start learning "The Basics" on page 24.

Using Memory

Read “Using Memory,” beginning on page 38, and you’ll learn how to make the most of your new phone’s built-in Phone Book. Plus, learn how to save time with dialing shortcuts using the Turbo Dial™ keys or Super Speed Dial.

Using Messaging

Did you know that your dual mode StarTAC phone supports optional messaging services, like Caller ID*, which allows you to see who’s calling before you answer? Your new phone can even receive alphanumeric messages just like a pager and tell you when you have Voice Mail*. Simply turn to page 46 to begin “Using Messaging.”

The Works

When you’re ready to get into the more advanced features your new phone has to offer, just turn to page 54 for “The Works.” Learn about everything from navigating the menu system to electronically locking your phone.

So relax! Let us show you what your dual mode StarTAC™ phone can do!



*Contact your Service Provider for availability.

Contents

Introduction

What's New	6
Highlights	9
Important Safety Information	10

Getting Started

Package Content Options	14
Installing the Battery	16
Charging the Battery	20

The Basics

Phone Overview	24
Using the Smart Button	25
Turning Your Phone On	26
Reading the Indicators	28
Placing and Ending Calls	27
Receiving Calls	32
Redialing Numbers	33
Basic Tone Controls	35
Your Phone & Its Shortcuts	36

Using Memory

Introduction	38
Making the Most of Memory	39
Storing	40
Recalling	42

Using Messaging

Introduction	46
Receiving Messages	47
Viewing Your Caller IDs	48
Checking Your Voice Mail	50
Reading Your Messages	52

The Works

Introducing the Menu Features.	54
The Internal Phone Book	56
<i>Learn how to store and recall numbers</i>	
Using Call Timers	66
<i>Learn how to monitor the length of your calls</i>	
Setting Tone Control	72
<i>Learn how to adjust your phone's tone controls</i>	
Lock/Security Features.	78
<i>Learn how to restrict access to your phone</i>	
Phone Options	86
<i>Learn how to personalize your phone's operation</i>	

Reference Information

Accessory Options.	98
Troubleshooting.	102
Glossary	104
Index	113

What's New?

The company that brought you the world's first commercially available portable cellular phone has done it again!

Motorola is proud to present the dual mode StarTAC™ cellular phone—the latest breakthrough in personal cellular communications. Utilizing the latest advances in CDMA digital technology, your dual-mode phone automatically switches between high capacity CDMA digital and traditional analog systems.

Just look what else your new phone has to offer:

Real Time Clock

When CDMA digital service is active on your phone, a Real Time Clock that automatically updates itself will appear on the display along with today's date to help keep you on time! See page 28.

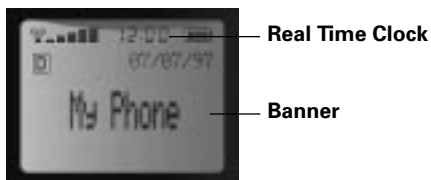

Personalizable Banner

Personalize your dual mode StarTAC phone with the message of your choice (up to 12 characters long) by selecting the new Change Banner feature. Your message will then appear whenever your phone is in idle mode. See page 94.

Messaging Menu

Viewing Caller IDs*, checking Voice Mail*, and reading messages* are made simple! Just press the dedicated Message Key  to open your phone's new and easy Messaging Menu. See page 46.

Caller ID Name Look-up

If you subscribe to Caller ID* through your Service Provider, your phone will automatically look up the caller's number in your Phone Book and display the name of the caller! See page 65.

New Expanded Display

Read information with ease on your phone's new, enlarged display. With 24-character alpha entry (up from 14) and 32 numeric, everything you need to know is right there!



Auto Hyphen

Now your phone numbers are easier to read too! When Auto Hyphen is turned ON, all of the phone numbers in your phone's memory will be automatically hyphenated. See page 95.

Turn the page for more new features.

*Contact your Service Provider for availability.

What's New?

Here are more new features to help simplify your life!

Silent Mode

When you need to be discreet, just turn Silent Mode ON. All tones will be silenced. The ringer and incoming message tones will be replaced by vibrations. Don't worry, even though you don't hear anything when you dial a number, you can still access services like Voice Mail and bank-by-phone. See page 74.

Service Tones

Two short beeps let you know when there is a change in your cellular service, such as moving from analog to digital service. See page 77.

Phone Book Status

Just check your Phone Book Status to see exactly how much room you have in your phone's memory. See page 59.

Instant Redial

Turn Instant Redial ON to have your phone instantly redial the number you're calling when the cellular system is busy. See page 93.

Quad Number

Your dual mode StarTAC phone can be activated with up to four unique phone numbers. You could use one number for personal use, one for business, and the other two for cities that you travel to frequently. Turn to Changing Your Number to learn how to select an appropriate number. See page 88.

Highlights

As one of the most sophisticated cellular phones around, your dual mode StarTAC™ phone offers exceptional features that make life easier, more organized, and more fun! This miracle of modern technology can help you...

- receive calls discreetly with the VibraCall™ alert.
- know when to charge with the dedicated Battery Level Indicator.
- make calls in a flash using the Turbo Dial™ keys.
- charge on-the-go with the Internal Rapid Charger and an AC adapter or cigarette lighter adapter.
- navigate phone features with a user-friendly, icon-driven menu interface.
- enjoy the convenience of hands-free operation with the headset jack and an optional headset.
- remember phone numbers with the enhanced internal Phone Book.
- personalize your phone with multiple ringer styles.

Also, if you're already a Motorola cellular phone user, you'll be happy to know that many of your Motorola accessories can be used with your dual mode StarTAC phone. In fact, your new phone also uses many of the same keystrokes. So, if you're familiar with Motorola phones, you're familiar with the dual mode StarTAC phone!

Exposure to Radio Frequency Signals



Antenna Care



Phone Operation

Safety Information

Your wireless handheld portable telephone is a low power radio transmitter and receiver. When it is ON, it receives and also sends out radio frequency (RF) signals.

In August 1996, the Federal Communications Commissions (FCC) adopted RF exposure guidelines with safety levels for hand-held wireless phones. Those guidelines are consistent with the safety standards previously set by both U.S. and international standards bodies:

- ANSI C95.1 (1992)*
- NCRP Report 86 (1986)*
- ICNIRP (1996)*

Those standards were based on comprehensive and periodic evaluations of the relevant scientific literature. For example, over 120 scientists, engineers, and physicians from universities, government health agencies, and industry reviewed the available body of research to develop the ANSI Standard (C95.1).

The design of your phone complies with the FCC guidelines (and those standards).

Use only the supplied or an approved replacement antenna. Unauthorized antennas, modifications, or attachments could damage the phone and may violate FCC regulations.

Normal Position:

Hold the phone as you would any other telephone, with the antenna pointed up and over your shoulder.

Tips on Efficient Operation:

For your phone to operate most efficiently:

- Extend your antenna fully.
- Do not touch the antenna unnecessarily when the phone is in use. Contact with the antenna affects call quality and may cause the phone to operate at a higher power level than otherwise needed.

*American National Standards Institute; National Council on Radiation Protection and Measurements; International Commission on Non-Ionizing Radiation Protection

Safety Information

Caution: All batteries can cause property damage, injury or burns if a conductive material, such as jewelry, keys or beaded chains, touches exposed terminals. The material may complete an electrical circuit and become quite hot. To protect against such unwanted current drain, exercise care in handling any charged battery, particularly when placing it inside your pocket, purse or other container with metal objects. Your battery is packed with a protective cover. Please use this cover for storing your battery when not in use.

Check the laws and regulations on the use of wireless telephones in the areas where you drive. Always obey them.

Also, if using your phone while driving, please:

- Give full attention to driving—driving safely is your first responsibility;
- Use hands-free operation, if available;
- Pull off the road and park before making or answering a call if driving conditions so require.

Most modern electronic equipment is shielded from RF signals. However, certain electronic equipment may not be shielded against the RF signals from your wireless phone.

Pacemakers

The Health Industry Manufacturers Association recommends that a minimum separation of six (6") inches be maintained between a handheld wireless phone and a pacemaker to avoid potential interference with the pacemaker. These recommendations are consistent with the independent research by and recommendations of Wireless Technology Research.

Persons with pacemakers:

- Should ALWAYS keep the phone more than six inches from their pacemaker when the phone is turned ON;
- Should not carry the phone in a breast pocket;
- Should use the ear opposite the pacemaker to minimize the potential for interference.
- If you have any reason to suspect that interference is taking place, turn your phone OFF immediately.

Batteries



Driving



Electronic Devices



Safety Information

Electronic Devices



Hearing Aids

Some digital wireless phones may interfere with some hearing aids. In the event of such interference, you may want to consult your hearing aid manufacturer to discuss alternatives.

Other Medical Devices

If you use any other personal medical device, consult the manufacturer of your device to determine if they are adequately shielded from external RF energy. Your physician may be able to assist you in obtaining this information.

Turn your phone OFF in health care facilities when any regulations posted in these areas instruct you to do so. Hospitals or health care facilities may be using equipment that could be sensitive to external RF energy.

Vehicles

RF signals may affect improperly installed or inadequately shielded electronic systems in motor vehicles. Check with the manufacturer or its representative regarding your vehicle. You should also consult the manufacturer of any equipment that has been added to your vehicle.

Aircraft



Posted Facilities

Turn your phone OFF in any facility where posted notices so require.

FCC regulations prohibit using your phone while in the air. Switch OFF your phone before boarding an aircraft.

Blasting Areas



To avoid interfering with blasting operations, turn your phone OFF when in a “blasting area” or in areas posted: “Turn off two-way radio.” Obey all signs and instructions.

Safety Information

Turn your phone OFF when in any area with a potentially explosive atmosphere, and obey all signs and instructions. Sparks in such areas could cause an explosion or fire resulting in bodily injury or even death.

Areas with a potentially explosive atmosphere are often, but not always, clearly marked. They include fueling areas such as gasoline stations; below deck on boats; fuel or chemical transfer or storage facilities; vehicles using liquefied petroleum gas (such as propane or butane); areas where the air contains chemicals or particles, such as grain, dust, or metal powders; and any other area where you would normally be advised to turn off your vehicle engine.

An air bag inflates with great force. DO NOT place objects, including both installed or portable wireless equipment, in the area over the air bag or in the air bag deployment area. If in-vehicle wireless equipment is improperly installed and the air bag inflates, serious injury could result.

Your Motorola cellular radiotelephone is designed for excellent durability under normal use conditions. Protect your cellular telephone from water damage that could result from spills or excessive exposure to rain. Never submerge your cellular phone.

Potentially Explosive Atmospheres



Air bags

Equipment Care

Getting Started

Package Content Options

The dual mode StarTAC™ phone comes equipped with a standard battery and an AC adapter to get you up and running. A whole new line of accessory options, now smaller and lighter than ever, can customize your wireless package for maximum performance and portability.



Dual Mode StarTAC Phone

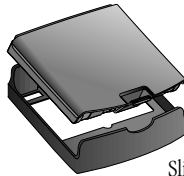

Slim Main Battery
with Battery Cover

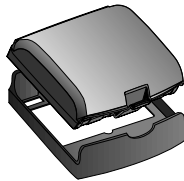

Standard Main Battery
with Battery Cover



Standard Auxiliary Battery
with Battery Cover



Slim Auxiliary Battery
with Battery Cover

Package Content Options



Holster



Cigarette Lighter Adapter



AC Adapter



Headset

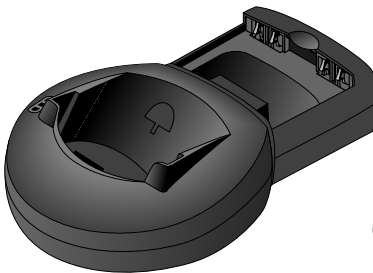

Desktop Charger
(AC Adapter required)

Your phone and accessories may not look exactly as pictured above.

Battery Information

Your phone's batteries are shipped in an uncharged state with protective covers on them. Save these covers; use them to carry batteries and to store batteries when they are not in use. The cover prevents objects from touching the battery terminals, thereby reducing the risk of injury or damage from a short circuit.

To begin using your phone, just slip a battery out of its protective cover, install and charge the battery.

Removing the Main Battery Cover

1. Press in release latch.
2. Continue pushing in and upwards until battery slips free from its cover.

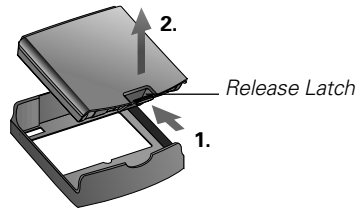

Attaching the Main Battery Cover

1. Lower the side, opposite the release latch, into the cover.
2. Slip the side with the release latch down until it clicks.

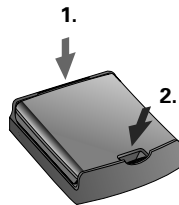

Battery Information

Removing the Auxiliary Battery Cover

1. Hold auxiliary battery securely with one hand. With your other hand's thumb, push up on bottom of the cover.
2. Continue to push up until the cover slides free of the pins on the bottom of the battery, then swing the cover outwards.

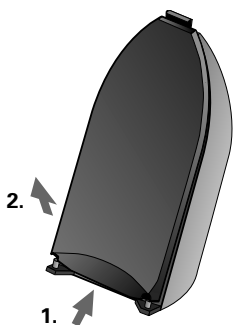

Attaching the Auxiliary Battery Cover

1. Slide the cover's narrow end into the small grooved hook on the top of the auxiliary battery.
1. Push cover firmly so the base of cover slides past the pins on the auxiliary battery, then release.

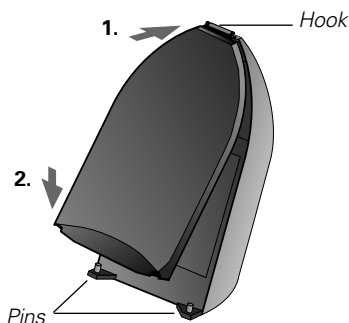

Battery Covers

Installing the Battery

Main Battery Installation

The main battery fits into the top of your phone like a ski boot fits into a ski.

1. Place the battery's "toe" into the compartment as shown.

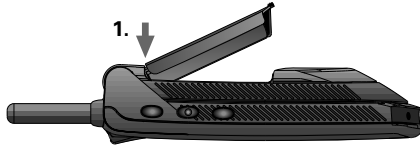

2. Press its "heel" down until you hear it click into place.

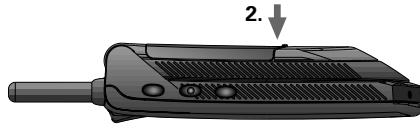

Main Battery Removal

Tip: If you have a charged auxiliary battery attached to your phone, you can remove and change your main battery during a call.

To remove the main battery:

1. Turn your phone OFF.
2. Pull the release latch back toward battery and lift the battery out.



Installing the Battery

Auxiliary Battery Installation

The auxiliary battery clips onto the back of your phone:

1. Place the hook located on the narrow end of the battery into the slot on the back of the phone.
2. Pull the battery downward and toward the bottom of the phone.
3. Release the battery so that it clicks upward into place.
Make sure that the bottom of the battery is firmly attached.

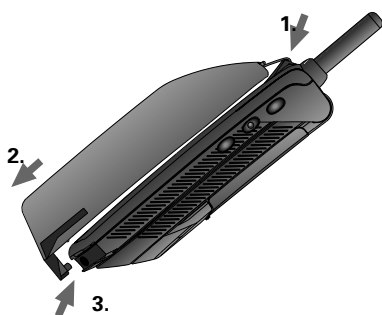

Auxiliary Battery Removal

Tip: If you have a charged main battery attached to your phone, you can remove and change your auxiliary battery during a call.

To remove the auxiliary battery:

1. Pull the battery down and away from the phone.
2. Lift the battery's hook out of the slot on the back of the phone.

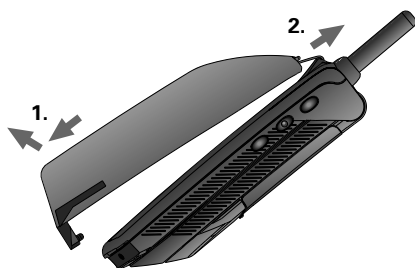

The Auxiliary Battery

Charging the Battery

With the Internal Rapid Charger

Believe it or not, there's a battery charger built right into your phone! If your phone came with an AC adapter or cigarette lighter adapter, you can plug your phone directly into a power supply and charge the battery – whether the phone is ON or OFF. When the Internal Rapid Charger is in use and the phone is ON, you can still place and receive calls. Just remember, talking on the phone requires energy, so charging will take more time.

Note: The AC adapter and cigarette lighter adapter may or may not have been included with your phone.

1. Plug the AC or cigarette lighter adapter into the accessory connector on the bottom of your phone as shown, with the release tab facing up.
2. Plug the adapter into the appropriate power source.

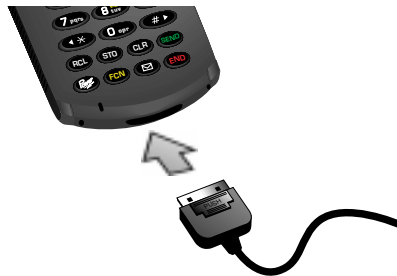

Keep in mind: In some cars, the ignition must be ON to use the cigarette lighter.

What you will see:

- The border of the battery icon will flash during charging.
- When both batteries are fully charged, the battery icon will stop flashing and become solid.

Charging the Battery

Using the Desktop Charger

The desktop charger's front pocket can charge batteries while they are attached to your phone, and the rear pocket can charge batteries separately.

First plug the AC adapter into the back of the charger, with the release tab facing up. Plug the other end of the adapter into an AC wall socket, and you can begin charging your batteries. With battery(s) attached, place the phone into the charger's front pocket. You can also charge an extra auxiliary or main battery in the rear pocket as shown:

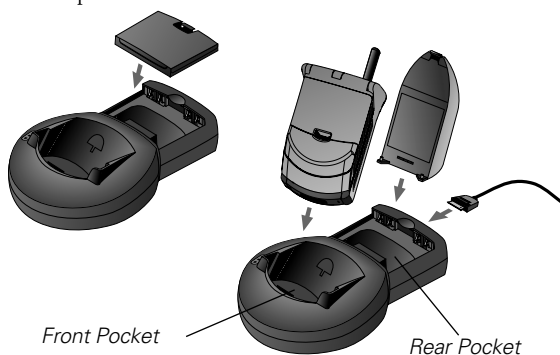

Tip: When you charge the main and an auxiliary battery, the main battery will be charged first.

What you will see when charging:

- Red means the battery is charging.
- Flashing yellow means the battery is waiting to be charged.
- Green means the battery is charged within 90% of its capacity and can be used. An additional hour of charging will bring your battery up to 100% capacity.
- Flashing red means the battery is damaged and can't be charged.

Charging the Battery

Desktop Charger Charging Times

The time it takes for your battery to obtain a full charge is affected by a variety of factors, including:

- **Temperature** Batteries should be at or near room temperature when charging. To prolong battery life and charge capacity, avoid exposing your batteries to temperatures below 10°C (14°F) or above 45°C (113°F). As a good rule of thumb, always take your phone with you when you leave your car.
- **Inactivity** New batteries, or batteries that have been stored for long periods of time, may not rapid charge properly. In these instances, the battery requires an overnight charge.
- **Extended Usage** Over extended periods of time, batteries gradually wear down and require longer charging times. This is normal. If you've been charging your battery regularly and notice a decrease in talk-time or an increase in charging time, then it's probably time to purchase a new battery.

Charging the Battery

Battery Storage and Disposal

To prolong the life of your batteries, avoid exposing them to temperatures below -10°C (14°F) or above 45°C (113°F).

As a good rule of thumb, always take your phone with you when you leave your car. To dispose of batteries, check with your local recycling center for a battery recycler near you. Never dispose of batteries in fire.

Caution: To prevent injuries or burns, do not allow metal objects to contact or short circuit the battery terminals.

Phone Overview

Power Key

 Turns the phone ON and OFF.

Dedicated Message Key

 Opens messaging menus.

Function Keys

 Acts as a “shift” key to access the secondary functions of other keys. See page 36.



 Recalls phone numbers from memory.

 Stores phone numbers into memory.

 Clears characters from the screen.

 Ends phone calls and exits the menu.

 Places or answers calls.

 and  can be used to scroll through memory entries and menu features.

Alphanumeric Display Displays your input from the keypad, information recalled from memory, and other messages.

Microphone Positioned for convenient conversation.

Keypad Cover Open to answer; close to hang up.



Clock Appears when you have CDMA digital service.

Retractable Antenna Extend for best performance.



Earpiece Ultra-compact phone speaker.

Headset Jack Provides the connection for an optional headset.

Accessory Connector Provides the connection for an external power supply.

Volume Keys Represented in this manual by  and ; these keys adjust keypad, earpiece, and ringer volume. They also scroll up and down through memory locations and menu features.

Using the Smart Button

Easily recognized in this User's Guide by  and in your phone's display by —the handy Smart Button puts a variety of functions right at your fingertip.

The Smart Button





Use the Smart Button's fingertip convenience for:



Opening Your Phone Book

Simply press  when your phone is idle to open the Phone Book on the display! Turn to page 38 in “Using Memory” for more information.



Entering the Menu System

Press  then press  to enter your phone's menu system. See page 54 for information on navigating the menu system.



Selecting Items in the Menu

The most basic use of the Smart Button is to select. Whenever the phone offers you a choice, such as setting a ringer style, just press  to select. You will see: *Press  To Select.*

Turning Features ON and OFF

Press  to toggle displayed menu features ON and OFF. You will see: *Press  To Toggle.*

Placing and Ending Calls



Just press & hold  to place a call when the number you want to call is on the display. Press & hold  again to end a call. See page 31 for information on placing and ending calls.

Turning Your Phone On

The next few pages will introduce you to the basic features of your dual mode StarTAC™ phone. Once you learn these, you'll be hooked. But don't stop with "The Basics"—there's so much more to know!

In the chapters that follow, we'll take you step-by-step through every one of your new phone's features — storing names and numbers, using the call timers, locking the phone, and more.

Follow these steps to turn your phone ON and OFF:

1. Extend the antenna for best performance.
2. Open keypad cover to expose the keypad.
3. Press  once to turn the phone ON.
Press  again to turn the phone OFF.
You will see: `Powering Off.`

What you will see:

Each time you turn your phone ON, it will light up and perform a short self-test to let you know it's operational. While your phone seeks an available network, you will see: `Searching.`

If your phone finds a CDMA digital system, you will see the time and date, the  icon, and either `Ready` or the personalizable banner (if programmed).



Turning Your Phone On

If your phone finds an analog system, you will see the  icon and either *Ready* or your personalized banner.



Your phone can be activated with up to four unique phone numbers. If there's more than one phone number programmed on your phone, you'll see the currently active number instead of *Ready* or the personalized banner.



Turn to *Changing Your Number* on page 88 if you want to change your currently active number.

To conserve energy, your phone enters standby mode and turns off the back light when you haven't touched a key for a few seconds. The back light will come back on as soon you press a key or open the phone.

Turn the page to learn about your phone's expanded display screen and all of its helpful indicators.

Analog

Quad Number

Standby Mode

Reading the Indicators

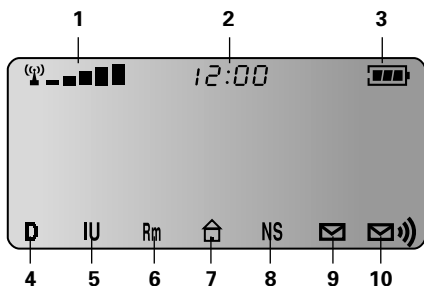

Strong



Weak



High



Low

Signal Strength (1)

Displays the strength of the connection between your phone and the local cellular system.

12:00 Clock (2)

When your phone is on a CDMA digital network, the display shows the current time and date transmitted by your digital Service Provider. Wherever you are, you'll have the correct local time. You can set your clock for 12- or 24-hour format. See page 95 for more information.

Battery Level (3)

The three bar segments on the phone's Battery Level Indicator show the amount of charge remaining in your battery. The more bar segments you see, the higher the charge.

If your battery is low, the phone alerts you in three ways:

- No bar segments on the indicator will be highlighted.
- **Low Battery** will appear on your display.
- A hi-lo tone will sound periodically (except in Silent Mode).

If you ignore these warnings, the phone will automatically turn itself OFF when the battery is exhausted. At this point, you should charge the battery or install a new battery.

Reading the Indicators

Digital (4)

Indicates you're on a digital channel, allowing for better voice quality. Check with your Service Provider for more information.

Analog (4)

Appears when you're on an analog channel.

IU In Use (5)

Appears when a call is in progress.

Rm Roam (6)

Lights up when your phone accesses a cellular service outside of your home system. When you leave your cellular service area, your phone roams (seeks another cellular system).

In-Building (7)

The In-Building Indicator lights up when your phone accesses an In-Building Cellular system.

NS No Service (7)

Appears when calls cannot be placed or received from your location.

Caller ID/Message (9)

Appears when you receive a Caller ID* or alphanumeric message. It will disappear after you've viewed the Caller ID or read the message.

Voice Mail (10)

Indicates that you've received a Voice Mail* message in your Voice Mailbox. It will disappear after you've listened to the message.

The following indicators appear in the idle display when you select one of the VibraCall™ alert combinations (see page 75):



VibraCall On— Indicates that your phone's ringer is turned OFF and the VibraCall alert is ON.



Silent Mode— Indicates that all of your phone's tones are silenced and the VibraCall alert is ON.



Vibrate Then Ring— Indicates that both your phone's ringer and VibraCall alert are ON.

*Contact your Service Provider for availability.

Reading the Indicators

Detailed Battery Level Reading

Press **FCN** then press **4** to view the battery level.

The bar graph in the display represents the battery level. The higher the graph, the closer the battery is to full charge.



Full Charge



Low Charge

Important: If the phone is being powered externally—from the cigarette lighter adapter for example—you will see:



Incoming Call Indicator

The Incoming Call Indicator on the top of your phone flashes red and green when you have an incoming call.

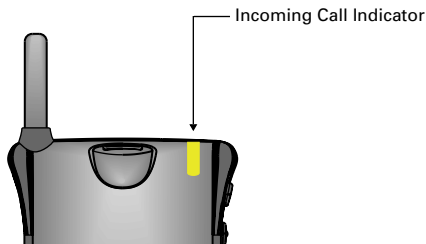

Placing and Ending Calls

First check that your phone is ON.

To place a call:

1. Extend the antenna completely for best performance.
2. Open keypad cover to expose the keypad.
3. Enter the number you want to call, for example: 555-1234.
Press **CLR** to erase one digit at a time if you make a mistake.
Hold **CLR** to erase the entire entry.
4. Press **SEND** to place the call.
You will see: *Dialing 555-1234.*
or
Press & hold Smart Button until you hear a high tone. You will see: *Dialing 555-1234.*

You can dial phone numbers with up to 32 digits, but only the last twenty-four digits will appear in the display.

Press **RCL** to see the rest of the number.

Your phone will display the first 24 digits, then a second screen will show the remaining digits in the phone number.

To end a call:

Close keypad cover to hang up your phone.
or
Press **END**.
or
Press & hold Smart Button until you hear a high tone. You will see: *Press * to End Call.*
then
Press Smart Button again to end the call.

Placing a Call

Ending a Call

Receiving Calls

Your phone is ringing and/or vibrating.

- It must be ON to receive calls.

If Caller ID* service is active on your phone, you can see who's calling before you answer! The display will show either your caller's name (if it's in your Phone Book) or your caller's number. If you prefer to always see your caller's number, see page 65 to turn Number Preference ON.

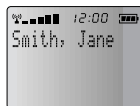
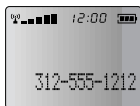

The Caller IDs for your last 16 different callers will be saved. Turn to page 48 to learn how to view your Caller IDs.

Answering a Call

To answer a call:

1. Extend the antenna completely for best performance.
2. Open keypad cover when the phone rings.
or
Press **SEND**.

Ending a Call

To end a call:

- Close keypad cover to hang up your phone.
or
Press **END**.
or
Hold Smart Button until you hear a high tone.
You will see: Press * to End Call.
then
Press Smart Button again to end the call.

Unanswered Call Indicator

Even with the latest wireless technology, sometimes you are unavailable to answer calls. While your phone is ON, it keeps a count of unanswered or missed calls. For example, if you miss two calls, your display will show: 2 Calls Unanswered.

Press **CLR** or press **END** to clear the display, and you can begin placing calls again.

*Contact your Service Provider for availability.

Redialing Numbers

If you hear a fast busy signal and see `Press SND to Redial`, the cellular system is too busy to handle your call.

To automatically redial:

Press **SEND**.

or

Press Smart Button.

You will see: `Redialing`.

Your phone will automatically redial the number for the next four minutes. When the call goes through, your phone will ring or vibrate until the person you are calling answers.

If the call does not go through in four minutes, you will see:

`Press SND to Redial` again.

To automatically redial again:

Press **SEND**.

or

Press Smart Button.

You will see: `Redialing`.

You can also have your phone instantly redial after a fast busy signal without pushing a button. Just turn Instant Redial ON. To find out how, see page 93.

If you hear an ordinary busy signal:

1. Press **END** to hang up.
2. Press **SEND** to redial.
or
Press & hold Smart Button.
You will see: `Dialing 555-1234`.

Automatic Redial

Instant Redial

Redial

Display Last Ten Numbers Dialed

Redialing Numbers

Your phone keeps track of the last ten numbers you've dialed.

1. Press **RCL** then press **0**, **0**.
The display will show the last number you dialed.

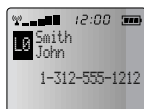

2. Use the volume keys to scroll up or down through the last ten numbers, starting with the most recent call.
3. Press **SEND** to call the number in your display.
or
Press & hold Smart Button.
You will see: *Dialing 1-312-555-1212.*

Basic Tone Controls

The upper and lower volume keys can be used to adjust both the earpiece and ringer volume. As you press these keys, the phone's speaker will demonstrate the new volume level.

To adjust earpiece and keypad volume:

Hold  to raise or lower the volume.

The bar graph in the display represents the volume level. The higher the graph, the louder the volume is.



Low Volume



High Volume

To adjust ringer volume:

1. Press **FCN**.
2. Hold  to raise or lower the ringer volume.

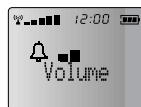

Low Volume



High Volume

If you need some privacy while a call is in progress, try muting the microphone—you'll be able to hear the party on the other end, but they will not hear you.

1. Press **FCN** then press **6** to mute the microphone. You will see: Muted.
2. Press **FCN** then press **6** again to resume your conversation.

The following page will provide more information on the dual mode StarTAC™ phone's shortcuts.

Adjusting Earpiece Volume

Adjusting Ringer Volume

Muting the Microphone

Your Phone & Its Shortcuts

Throughout this guide you will see **Shortcut:** boxes that point out simple ways to reach some of your phone's features. If you've owned a Motorola phone before, many of these shortcuts will already be familiar to you.

The Usual Shortcuts

You'll notice the words "menu," "batt," "lock," "mute," and "vib" written on the **1**, **4**, **5**, **6**, and **8** buttons. Press the **FCN** key first, then any one of these buttons, and your phone will perform that function. It's easy, so give it a try!

Just press:

FCN then **1** to enter the menu system.

FCN then **2** to toggle Analog Only On or Analog Only Off.

FCN then **4** to display the battery meter.

FCN then **5** and hold, you will see: Lock? Then press **STD** to lock. Your factory lock code is set to 123. See page 82, Locking the Phone, for more information.

FCN then **6** to toggle mute ON and OFF during a conversation.

FCN then **8** to toggle your phone's VibraCall™ alert ON and OFF.

FCN then **8** and hold to turn ON Silent Mode.

Your Phone & Its Shortcuts



Using Memory

Do you have places to go and people to see? Too many phone numbers to remember? Let your phone remember them for you. Your dual mode StarTAC™ phone's internal Phone Book can store up to 99 names and numbers for easy access on the go.

In this chapter you will learn how to:

- store names and numbers into the Phone Book
- recall phone numbers from memory
- dial a number with the Super Speed Dial and Turbo Dial™ functions

Follow these symbols as a guide for using the keys on the side of your phone.

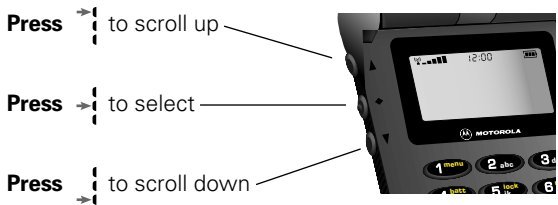

Making the Most of Memory

Each phone number is stored in a “memory location” numbered 01-99. You can arrange your Phone Book for convenient recall by storing related numbers in groups. For example, store your most important numbers in locations 01-09, then you can use the Turbo Dial™ keys to call them with the push of a button. Location 01 should be reserved for your Emergency Call number (see page 81).

You can also store names of up to 24 characters, in 2 lines of 12, to help identify phone numbers. Then you can easily recall numbers by either the name or memory location.

If someone you know has more than one phone number, you can organize the entries to quickly find the number you need by using line 1 for the name and line 2 for information unique to that number, as in the example below:

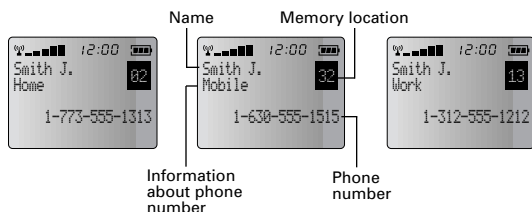

The possibilities are endless, so give it a try!

When you feel ready for more advanced memory features, move on to the “Phone Book” section, beginning on page 56. In “Phone Book” we will show you things like how to edit a memory location and access automated calling systems like Voice Mail with just the touch of a button!

Storing Names & Numbers

To take advantage of your phone's internal Phone Book, you'll first want to store some names and numbers into memory.

1. Enter the phone number you want to store.
2. Press **STD** to begin storing. The phone will prompt you for a memory location.
You will see: Location ____.
3. Enter the two-digit memory location where you want the phone number stored.
or
Press **←*** to store it in the next available location.
or
Enter the first digit of the memory location and press **←*** to store the number in the first available location beginning with that digit.
You will see: Alpha or Press *.
4. Enter a name to identify the phone number, or skip this step and go to step 5. (See the next page for details on entering names.)
5. Press **STD** when you are finished entering the name. You will see: Stored At XX.

Keep in mind: Your Phone Book sorts alphanumerically by the first letter of the entry. If you've entered a phone number without a name, it will be placed at the end of your Phone Book.

Entering Names

When the display shows Alpha or Press *, you can use the keypad to produce any letter in the alphabet. For example, press **2** to enter the letters "A," "B," or "C" as shown:

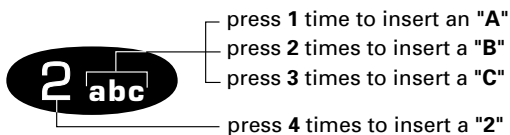

To enter a name:

1. Enter a letter by pressing a key as many times as necessary.

Tip: Use the volume keys to toggle between upper and lowercase.

2. Press **#>** to advance the cursor.
3. Press **CLR** or **<*** to erase a letter if you make a mistake.
4. Continue with step 5 on the previous page when you are finished entering the name.

To enter punctuation:

Using this chart as a guide, press **1** as many times as indicated to produce the desired punctuation:

1	2	3	4	5	6	7	8	9	10
	1	/	'	,	?	\$.	&	!

**Recall by
Name**

Recall from Memory Using the Smart Button

Once you've stored names and numbers, simply press the Smart Button to open your Phone Book. You can then recall numbers by name and instantly place calls—just press & hold the Smart Button.

1. Press Smart Button once to enter your Phone Book.
2. Press the volume keys to scroll to the name you are looking for.
or
Enter the first letter of the name you want to recall from memory. The display will show the name, phone number, and entry location of the first entry beginning with that letter.
Press the volume keys to scroll to the name you are looking for.



3. Press & hold Smart Button or press **SEND** to call the number you selected.
You will see: Dialing 1-630-555-1515.
4. Press **END** or close the phone to end the call.
or
Press & hold Smart Button until you hear a high tone.
You will see: Press * to End Call.
then
Press Smart Button again to end the call.

Recall from Memory

Each name and number you store is placed in a memory location numbered 01-99. Once you have stored names and numbers, you can recall them by memory location.

1. Press **RCL** then enter the two-digit memory location of the phone number you're looking for.
2. Press & hold Smart Button or press **SEND** to call the number you selected.
You will see: *Dialing 555-1234.*
3. Press **END** or close the phone to end the call.
or
Press & hold Smart Button until you hear a high tone.
You will see: *Press * to End Call.*
then
Press Smart Button again to end the call.

Clearing a memory entry is easy:

1. Press Smart Button once to enter your Phone Book.
2. Press the volume keys to scroll to the name you are looking for.
3. Press **CLR**. You will see: *Clear?*
4. Press **STD** to confirm that you want to erase the entry. The two-digit location of the entry will show in the display with no other information to confirm that you have erased the entry.

Recall by Memory Location

Clear an Entry

Super Speed Dial

If you know the memory location of the number you want to call, try the Super Speed Dial function:

1. Enter the two-digit memory location 01-99.
2. Press & hold Smart Button to place the call.
or
Press **SEND** to place the call.
You will see: Dialing 555-1234.

Turbo Dial

The Turbo Dial™ keys allow you to dial numbers stored in locations 01-09 with the push of a button:

Press & hold a number on the keypad,
1 through **9**, and your call is placed!
You will see: Dialing 555-1234.

Your phone's Emergency Call feature gives you fast access to any number stored in location 01 – even if your phone is locked. To learn how to activate this feature, see Emergency Call on page 81.

Scratchpad

For quick notes on-the-fly, you can use the built-in Scratchpad. The Scratchpad remembers the last phone number that was on your display. If you are on the phone and your party gives you another number, just enter the number into the Scratchpad to place the call or store the number later.

During a call:

1. Enter the number into the keypad. (The person on the line will hear tones as you dial.)
Do not press **CLR** or you will erase the number.
2. Press **END** to end the call you are currently in, if necessary.
3. Press **SEND** to call the number on the Scratchpad.

You can also store numbers while you are on a call:

1. Enter the number into the keypad. (The person on the line will hear tones as you dial.)
Do not press **CLR** or you will erase the number.
2. Press **STO** and continue storing with step 3 under Storing Names & Numbers on page 40.

Using Messaging*



Just press the dedicated Message Key to open your dual mode StarTAC™ phone's new and easy Messaging Menu. Through this menu, you can view Caller IDs, check your Voice Mail, and read your pager-like alphanumeric Messages.

In this chapter you will learn how to:

- view your Caller IDs
- check your Voice Mail
- read your Messages
- explore your options with the Function Menus

Follow these symbols as a guide for using the keys on your phone.

Press  to scroll up

Press  to select

Press  to scroll down

Press  to open messaging menus



*Contact your Service Provider for availability.



Receiving Messages

If your phone is ON and you receive a Caller ID, Voice Mail, or alphanumeric message:

1. An alert sounds or vibrates:

- Your phone will beep or vibrate three times.
See Ring/Vib Select on page 75 to set your phone's alert.

2. An indicator appears on the display:

-  Appears when you receive a Caller ID or alphanumeric message. It will stay on the display until you've viewed the Caller ID or read the message.
- Urgent Msg Appears when you receive an urgent message and your phone is in idle mode.
- Msg Mem Full Appears when your alphanumeric message memory is full and your phone is in idle mode. Your Service Provider holds your messages and will forward them after you've made room. See Message Options on page 53 to learn how to delete messages.
-  Appears when you receive a Voice Mail message. It will stay on the display until you've listened to the message. Your Service Provider will then signal your phone to turn the indicator OFF.

3. Press to open the Messaging Menu.

- The specific icon will be flashing.

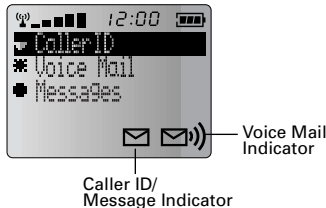

Tip: Messaging can be used with the keypad cover closed.

Note:

See Receiving Calls on pg. 32 for more about receiving Caller IDs.

See page 77 to learn about Message Reminder Tones.

Viewing Your Caller IDs*

Your phone supports Caller ID service which lets you see who's calling before you answer. The Caller IDs for the last 16 different callers are stored in a special memory so they can be viewed at any time.

1. Press **Ⓜ** to open Messaging Menu.
2. Press volume keys to scroll to Caller ID.
3. Press Smart Button to select.

You will see a Caller ID icon **☎** for each stored Caller ID. Flashing icons have not been viewed. Below the icons you'll see information for the latest Caller ID:

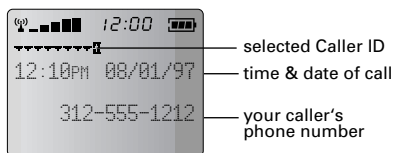

4. Press volume keys to highlight Caller ID to view.
5. Press Smart Button to view complete information for that call:



Keep in mind: You will see the caller's name only if it is stored in your Phone Book.

✓ A check mark will appear in the black box in the corner if you've answered or returned the call.

Press **SEND** to dial the caller's number.

Press **STD** to store the caller's number in your Phone Book.

*Contact your Service Provider for availability.

Call Back

**Store to
Memory**

Caller ID Options

While viewing Caller IDs, just press the Message Key to see the options available for the highlighted Caller ID.

6. Press  to open Function Menu.

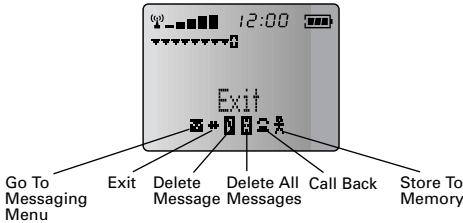

7. Press volume keys to scroll to the desired option, then press Smart Button to select:

 **Go To Msg Menu** Returns your phone to the Messaging Menu.

 **Exit** Exits Messaging to idle mode.

 **Delete Message** Deletes the currently selected Caller ID. Press Smart Button again to confirm.

 **Delete All Msgs** Deletes all your Caller IDs. Press Smart Button again to confirm.

 **Call Back** Dials the caller's number.

 **Store To Mem** Allows you to store the caller's number into your Phone Book by following the steps on page 40.

Caller ID Function Menu

Checking Your Voice Mail*

When you receive Voice Mail, your Service Provider sends a notification to your phone. You can check your Voice Mail at any time by following these simple steps.

1. Press  to open Messaging Menu.
2. Press volume keys to scroll to Voice Mail.
3. Press Smart Button to select.

If you have one or more Voice Mail messages, you will see:

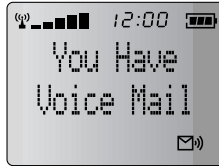

(or XX Voice Mail Msgs if the notification includes the number of messages you've received.)

4. Press  or press & hold Smart Button to dial your Voice Mailbox number.

Keep in mind: Some Service Providers send the Voice Mailbox number to your phone automatically. If the number has not been sent, all you need to do is store it in location 98 of your Phone Book. To learn how, see Pause Dialing on page 61.

If you have no new messages, you will see:



*Contact your Service Provider for availability.

Voice Mail Options

While checking Voice Mail, just press the Message Key to see the available options.

5. Press  to open Function Menu.

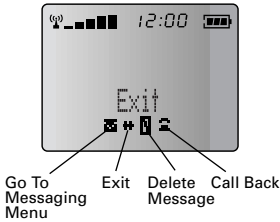

6. Press volume keys to scroll to the desired option, then press Smart Button to select:

 **Go To Msg Menu** Returns your phone to the Messaging Menu.

 **Exit** Exits Messaging to idle mode.

 **Delete Message** Deletes the Voice Mail Notification. Press Smart Button again to confirm.

 **Call Back** Dials your Voice Mailbox number.

Voice Mail Function Menu

Reading Your Messages*

Your phone can receive alphanumeric messages just like a pager. The message memory stores up to 60 messages (depending on the size) so they can be read at any time.

1. Press **Ⓜ** to open Messaging Menu.
2. Press volume keys to scroll to Messages.
3. Press Smart Button to select.

You will see a row of message icons **■**, one for each message. You may also see **!** for urgent messages and **🔒** for locked messages. Flashing icons have not been viewed. If there are more messages than can be shown on one line, arrows will point to the rest of the messages. Below the icons you'll see the latest message:

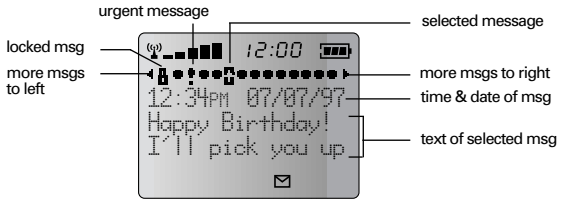

4. Press volume keys to highlight message to read.
5. Press Smart Button to read message.

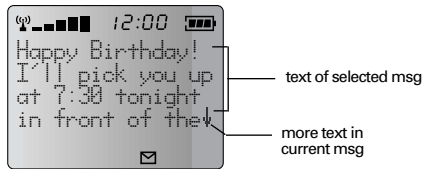

6. Press Smart Button to scroll through message.
or
Press volume keys to scroll to other messages.

Press **SEND** to dial Call Back number (in parentheses).

Press **STO** to store Call Back number in your Phone Book.

*Contact your Service Provider for availability.

Call Back

Store to Memory

Message Options

While reading your messages, just press the Message Key to see the options available for the highlighted message.

7. Press  to open Function Menu.

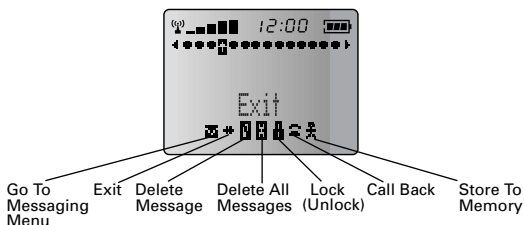



8. Press volume keys to scroll to the desired option, then press Smart Button to select:

 **Go To Msg Menu** Returns your phone to the Messaging Menu.

 **Exit** Exits Messaging to idle mode.

 **Delete Message** Deletes the currently selected message. Press Smart Button again to confirm.

 **Delete All Msgs** Deletes all messages from memory. Press Smart Button again to confirm.

 **Lock Message** /  **Unlock Message**
Lock important messages to protect them from accidental deletion. Messages must be unlocked before they can be deleted.

If the message contains a Call Back number (in parentheses), you will also see these options:

 **Call Back** Dials the number.

 **Store To Mem** Allows you to store the number into your Phone Book by following the steps on page 40.

Message Function Menu

The Works

Introducing the Menu Features

The dual mode StarTAC™ cellular phone is loaded with handy features that can help make life easier, more productive, and just a bit more exciting. The phone's user-friendly menu system will help you find what you need quickly and easily. Each of the icons that appear in your phone's display represents a menu.



Phone Book



Lock/Secure



Timers



Phone Options





Tone Control

You can navigate through the menu system using the three keys located on the left side of the phone. Use the upper and lower volume keys to scroll to submenus and functions. Use the Smart Button in the middle to choose menus and functions.

Navigating the Menu

This guide uses these symbols to instruct you to use the Smart Button and the upper and lower volume keys.

Press  to scroll up

Press  to select

Press  to scroll down



Road Maps

To help you navigate through the phone's menu system, each chapter begins with an easy-to-follow visual "road map." Simply press the key shown and observe the message that appears in the display. For example, try this:

1. Press **FCN** then Smart Button or **1** to enter the menu.
You will see: Phone Book.
2. Press the upper or lower volume keys to scroll through the menu's top level, shown here in the margin.
3. Press **END** to exit the menu.

Detailed instructions in each chapter take you step-by-step through each feature.

Now it's time to take the plunge. Move at your own pace, experiment, and have fun!

Previous User Compatibility

If you are already familiar with previous Motorola cellular phones, you can use your phone's ***←** and **→#** keys to scroll through the menu system.

Shortcuts

Experienced Motorola Users: Watch for the **Shortcut:** box. You will find many of the same key sequences that you have used with other Motorola models!

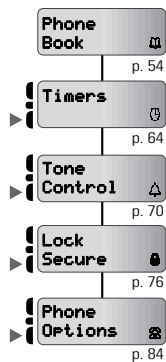

Phone Book



In “Using Memory” you learned how to store and recall phone numbers with your internal Phone Book. You can access the same features using your phone’s convenient menu system—the choice is yours! We’ll also show you how to use your phone’s advanced memory features.

In this chapter you will learn how to:

- recall and store phone numbers using the menu system
- simplify automated calling systems like Voice Mail
- edit your memory information
- view your own phone number

Follow these symbols as a guide for using the keys on the side of your phone.

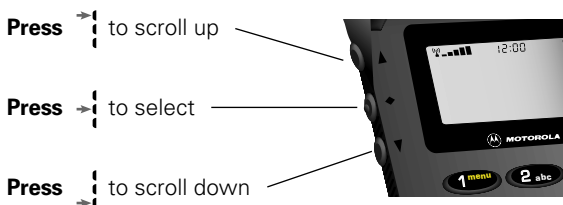

Road Map

Press **FCN** then press **→** to enter the menu system.

Start:

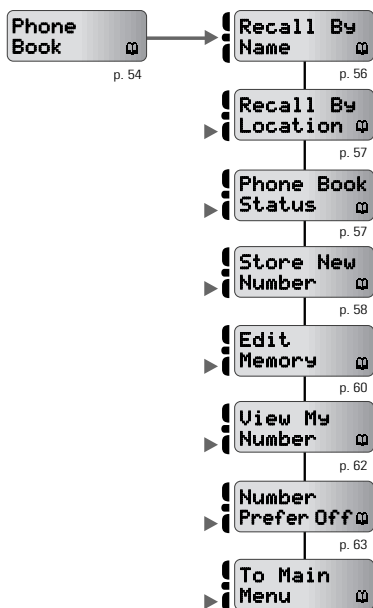

Getting to Phone Book...

1. Press **FCN** then press **Smart Button** to enter the menu system.
2. Press **Smart Button** to select **Phone Book**.
3. Press  to scroll to the following features:

Recall By Name

Once you have stored names and numbers, you can recall them alphabetically with the Phone Book menu.

Recall By
Name 

4. Press Smart Button to select Recall By Name.
You will see: Enter 1st Letter.
5. Enter the first letter of the name you want to recall from memory. The display will show the first name that begins with that letter and the telephone number.
6. Press the volume keys to scroll to the name you are looking for.
7. Press & hold Smart Button or press **SEND** to call the number you selected.
You will see: Dialing 555-1234.
8. Press **END** or close the phone to end the call.
or
Press & hold Smart Button until you hear a high tone. You will see: Press * to End Call.
then
Press Smart Button again to end the call.

Recall By Location

Each name and number you store is placed in a memory location numbered 01-99. Once you have stored names and numbers, you can recall them by memory location with the Phone Book menu.

4. Press Smart Button to select **Recall By Location**. You will see: **Location ___**.
5. Enter the two-digit memory location of the number you're looking for. You will see the Phone Book screen for that memory location.
6. Press & hold Smart Button or press **SEND** to call the number you selected.
You will see: **Dialing 555-1234**.
7. Press **END** or close the phone to end the call.
or
Press & hold Smart Button until you hear a high tone. You will see: **Press * to End Call**.
then
Press Smart Button again to end the call.





Recall By
Location 

Phone Book Status

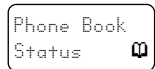

You can use this feature to see how many of your Phone Book's 99 locations have been used.

4. Press Smart Button to select **Phone Book Status**. Your phone will display the number of full locations.
You will see: **XX Full XX Empty**.
5. Press **END** to exit the menu, or you may scroll to other features.



Phone Book
Status 

Getting to Phone Book...

1. Press **FCN** then press **Smart Button** to enter the menu system.
2. Press **Smart Button** to select **Phone Book**.
3. Press  or  to scroll to the following features:

Store New Number

You can use the menu system to store names and numbers in the Phone Book. Whether you store numbers as described in “Using Memory” or store numbers with the menu, you will get the same results – so give it a try!

Store New
Number 

4. Press Smart Button to select **Store New Number**. You will see: *Enter Number*.
5. Enter the phone number you want to store.
6. Press Smart Button when you are finished entering the number.
You will see: *Location ___*.
7. Enter the two-digit number of the memory location where you want the number stored.
or
Press **4*** to store the sequence in the next available location.
or
Enter the first digit of the memory location and press **4*** to store the sequence in the first available location with that first digit.
You will see: *Alpha or Press **.
8. Enter a name to identify the phone number, or skip this step and continue with Step 9. See page 41 for more information on entering names.
9. Press **STD** or Smart Button when you are finished entering the name. Your phone will confirm the entry by displaying: *Stored At XX*. Proceed with Step 10 or return to Step 5 to store more numbers.
10. Press **END** to exit the menu, or you may scroll to other features.

Pause Dialing

When you call automated systems like Voice Mail, a recorded message prompts you for PIN numbers, account numbers, etc. You can make using automated systems easy by storing these numbers in the same memory location as the automated system's access number. Just separate the numbers with "pauses"—special characters that tell your phone to wait before sending additional numbers—and store the string in the same way you would other numbers.

1. Enter the phone number you use to access the automated system.
2. Press **FCN** then press **SEND**.
You will see a pause circle inserted into the number entry: ○.
3. Enter the next group of numbers, for example, your PIN number. If the automated system requires a * or #, enter those symbols, too.
4. Insert another pause and enter the next group of numbers by repeating steps 2 through 4 as many times as necessary.

Tip: You can store up to 32 digits, including pauses.



5. Press **STO** to begin storing.
You will see: Location ____.

Always store your Voice Mail number in location number 98.

6. Enter the two-digit number of the memory location where you want the number stored.
You will see: Alpha or Press *.
7. Enter a name for your sequence.
See Entering Names on page 41.
8. Press **STO** or Smart Button when you are finished entering the name. Your phone will confirm the entry by displaying: Stored At XX.

Once stored, simply recall the entry and place the call. When the recording asks for your information, press **SEND** or the Smart Button to transmit the numbers you've stored. Continue to press **SEND** or the Smart Button when you are prompted for more numbers.

Getting to Phone Book...

1. Press **FCN** then press **Smart Button** to enter the menu system.
2. Press **Smart Button** to select **Phone Book**.
3. Press  or  to scroll to the following features:

Edit
Memory 

Editing a Memory Location

After you have stored names and numbers in the Phone Book, you can edit entries at any time by location or name.

4. Press Smart Button to select Edit Memory.
5. Press the volume keys to scroll to Edit By Location or Edit By Name.
then
Press Smart Button to select.
6. Edit By Location
You will see: Location __.
Enter the two-digit memory location of the phone number you want to edit.
You will see the Phone Book screen for that memory location.
Continue with Step 7.
or
Edit By Name
You will see: Enter 1st Letter.
Enter the first letter of the name you want to edit. See page 41 for information on entering alpha characters. You will see the Phone Book screen for the first memory location beginning with that letter.
then
Press the volume keys to scroll to the name you are looking for.
7. Press Smart Button to begin editing the phone number. The display will show the name briefly, then the phone number.



Continued on next page.

Editing a Memory Location

8. Enter your changes to the phone number.
Press **CLR** to erase one digit at a time.
Press & hold **CLR** to erase the entire number.
9. Press Smart Button when you finish editing the phone number. The display will show the location where your number is currently stored. You will see: Location XX.
10. Press **CLR** to erase the memory location and enter a new two-digit location.
or
Press Smart Button or **STO** to keep the phone number in its current location. The display will show the name.
11. Enter your changes to the name.
See page 41 for details on entering names.

Press **CLR** to erase one letter at a time, or skip this step to leave the name unchanged.
12. Press Smart Button or **STO** when you finish editing the name. You will see: Location XX Is Full. The display will show the new information and ask if you want to save your changes. You will see: Change?
13. Press Smart Button or **STO** to save your changes. You will see: Stored At XX.
or
Press **CLR** to choose a new memory location and return to step 10.
or
Press **END** to exit without saving your changes.
14. Press **END** to exit the menu, or you may scroll to other features.

Getting to Phone Book...

1. Press **FCN** then press **Smart Button** to enter the menu system.
2. Press **Smart Button** to select **Phone Book**.
3. Press  or  to scroll to the following features:

Viewing Your Number

Use this feature to view your cellular phone's currently active phone number. If you have more than one phone number, you can change the active number with Changing Your Number on page 88.

View My
Number 

4. Press **Smart Button** to select **View My Number**. The display will show the currently active number on your phone.
5. Press **END** to exit the menu, or you may scroll to other features.

Shortcut: Press **RCL** **#** **>**.

Number Preference

When Placing Calls:

If you prefer to see the phone number (Dialing 555-1212) instead of the name (Calling Jane Smith) when you place a call from your Phone Book, just turn Number Preference ON.

When Receiving Calls:

If you subscribe to Caller ID, your phone automatically looks up the caller's name in your Phone Book and flashes it in the display (Jane Smith). If you prefer to see the caller's number (555-1212), just turn Number Preference ON.

4. Press Smart Button to toggle between Number Prefer Off or Number Prefer On.
5. Press **END** to exit the menu, or you may scroll to other features.

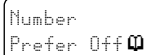

Number
Prefer Off 



Call Timers



Your phone is equipped with three visual and three audible Call Timers to help you manage your time. The three visual timers record the time spent talking on your phone just like a stop watch. The three audible timers can be set to beep at specific intervals so that you can keep track of air-time without even looking at the phone.

In this chapter you will learn how to:

- view the air-time of your individual calls
- set and view the Resettable Timer for long-term timing
- view your phone's total air-time
- set audible timers to beep at intervals that you choose

Follow these symbols as a guide for using the keys on the side of your phone.

Press  to scroll up

Press  to select

Press  to scroll down



Road Map

Press **FCN** then press **▶** to enter the menu system.

Start:



Getting to Call Timers...

1. Press **FCN** then press **Smart Button** to enter the menu system.
2. Press **or** to scroll to **Timers** and press **Smart Button** to select.
3. Press **or** to scroll to the following features:

Individual
XX:XX:XX 

View Individual Timer

The Individual Timer records the air-time of the most recent call or the call in progress in hours, minutes, and seconds. It resets automatically when you place your next call.

4. The display will show the air-time of your last call in hours, minutes, and seconds.
5. Press **END** to exit the menu, or you may scroll to other features.

Shortcut: Press **RCL** then **#▶** twice.

View Resettable Timer

You can record the air-time you've used during any time period. For example, reset it at the beginning of each billing period to know exactly where you stand at any given moment. The air-time of all calls is displayed in minutes from the point at which it is reset. See Reset Resettable Timer on page 69 to learn how to reset this timer.

Resettable
Time XXXXX 

4. The display will show your air-time in minutes since you last reset the timer.
5. Press **END** to exit the menu, or you may scroll to other features.

Shortcut: Press **RCL** then **#▶** three times.

Shortcut: Press **FCN** then press **Smart Button**, then **4**, **6** and continue with step 4.

View Cumulative Timer

This non-resettable timer records your phone's total air-time (in minutes) since the day you began using your phone.

4. The display will show your air-time in minutes since your phone was activated.
5. Press **END** to exit the menu, or you may scroll to other features.

Shortcut: Press **RCL** then **#** four times.

Shortcut: Press **FCN** then press Smart Button, then **4**, **7** and continue with step 4.

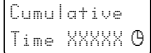

Cumulative
Time XXXXX 0

Reset Resettable Timer

After you reset the Resettable Call Timer, it will record your air-time in minutes from that point until you reset it again.

4. Press Smart Button to reset the timer.
You will see: Resettable Time 00000.
5. Press **END** to exit the menu, or you may scroll to other features.

Shortcut: Press **FCN** then press Smart Button, then **4**, **3** and continue with step 4.

Shortcut: Press **FCN** then **0**, **7**, **CLR**.

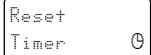

Reset
Timer 0

Auto Display Individual Timer

When you turn this feature ON, your phone will automatically display the Individual Call Timer during and after each call.

4. Press Smart Button to toggle Individual Timer On or Individual Timer Off.
5. Press **END** to exit the menu, or you may scroll to other features.

Shortcut: Press **FCN** then press Smart Button, then **4**, **8** and continue with step 4.

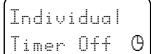

Individual
Timer Off 0

Getting to Call Timers...

1. Press **FCN** then press **Smart Button** to enter the menu system.
2. Press **or** to scroll to **Timers** and press **Smart Button** to select.
3. Press **or** to scroll to the following features:

One Minute
Timer Off

One Minute Audible Timer

Turn this feature ON to hear a beep 10 seconds before the end of every minute during a call. Don't worry, the party on the other end will not hear the beep.

4. Press Smart Button to toggle One Minute Timer On or One Minute Timer Off.
5. Press **END** to exit the menu, or you may scroll to other features.

Shortcut: Press **FCN** then press Smart Button, then **4**, **4** and continue with step 4.

Repeating Audible Timer

You can set this timer to beep during your calls at an interval that you select – from 11-999 seconds. The party on the other end will not hear the beep.

Repeating
Timer Off

4. Press Smart Button to toggle Repeating Timer On or Repeating Timer Off.
If ON, you will see: Enter Seconds.
If OFF, you will see: Repeating Timer Off.
5. Enter the number of seconds you would like between audible beeps.
You will see: Beep At XXX Secs.
6. Press Smart Button to set the timer. The phone will confirm by displaying your entry:
Set At XXX Secs.
7. Press **END** to exit the menu, or you may scroll to other features.

Shortcut: Press **FCN** then press Smart Button, then **4**, **1** and continue with step 4.

Single Audible Timer

You can set the Single Timer to beep once at a time that you select – from 11-999 seconds. The party on the other end will not hear the beep.

4. Press Smart Button to toggle Single Timer On or Single Timer Off.
If ON, you will see: Enter Seconds.
If OFF, you will see: Single Timer Off.
5. Enter the number of seconds you would like before the audible beep.
You will see: Beep At XXX Secs.
6. Press Smart Button to set the timer. The phone will confirm by displaying your entry:
Set At XXX Secs.
7. Press **END** to exit the menu, or you may scroll to other features.

Tip: If the Single Timer is already ON, but you want to change the length of the timer, toggle Single Timer OFF then ON again.

Shortcut: Press **FCN** then press Smart Button, then **4**, **2** and continue with step 4.

```
Single  
Timer Off 0
```

Tone Control



If you've been reading along diligently, this may be a good time for a break—put your feet up and have some fun with the Tone Controls. Use these features to select Silent Mode, personalize your phone's ringer styles, or turn them off for some peace and quiet.

In this chapter you will learn how to:

- choose from nine different ringer styles
- select Silent Mode for occasions when your phone's beeps and beeps aren't appropriate
- set the Message Reminder

Follow these symbols as a guide for using the keys on the side of your phone.

Press  to scroll up

Press  to select

Press  to scroll down



Road Map

Press **FCN** then press **▶** to enter the menu system.

Start:

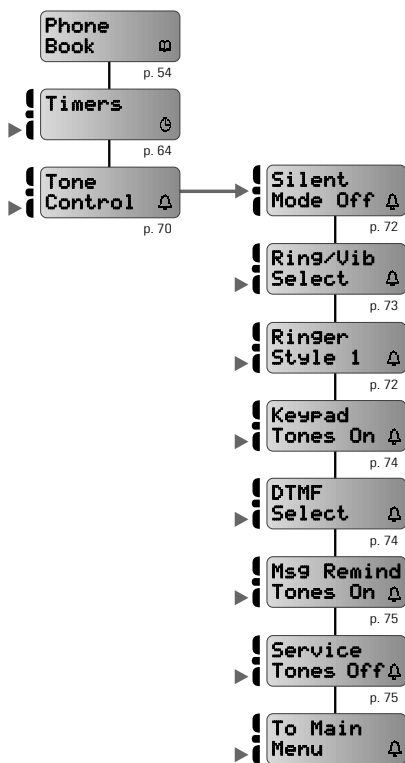

Tone Control

Getting to Tone Control...

1. Press **FCN** then press **Smart Button** to enter the menu system.
2. Press **or** to scroll to **Tone Control** and press **Smart Button** to select.
3. Press **or** to scroll to the following features:

Silent
Mode Off 

Silent Mode

When you need to be discreet, just turn Silent Mode ON. All tones will be silenced. The ringer and incoming message tones will be replaced by vibrations.

4. Press Smart Button to toggle Silent Mode Off or Silent Mode On.
5. Press **END** to exit the menu, or you may scroll to other features.

Shortcut: Press **FCN** then press and hold **8** to activate Silent Mode.

Select Ringer Style

Your phone offers nine different ringer styles. After selecting a ringer, your phone will demonstrate the new ringer style.

Keep in mind: If you have VibraCall™ alert set, your phone will demonstrate a new vibration style.

Ringer
Style 1 

4. You will see: Ringer Style X.
X is the ringer currently set.
5. Press Smart Button to select a new ringer. You will hear the ringer currently set and see: Select 1-9.
6. Press **1** through **9** to hear that ringer style, or scroll through all the styles with the volume keys.
7. Press Smart Button when you find the ringer style you want. You will see: Ringer X Set.
8. Press **END** to exit the menu, or you may scroll to other features.

Ringer/Vib Select

The VibraCall™ alert is ideal when you need to be discreet or in noisy places where you might not hear the ringer. Just select *Vibrate Only* and your phone's ringer will be replaced by gentle vibrations. Or have it all by selecting *Vibrate Then Ring* to have your phone vibrate three times then ring.

4. Press Smart Button to select *Ring/Vib Select*. You will see the current setting.
5. Press volume keys to scroll through the following: *Vibrate Only*, *Ring Only*, *Vibrate Then Ring*.
6. Press Smart Button to select the setting you want.
7. Press **END** to exit the menu, or you may scroll to other features.

Shortcut: Press **FCN** then press **8** to toggle the Vibra-Call™ alert ON and OFF.

Shortcut: Press **FCN** then press Smart Button, then **3**, **0** and continue with step 4.

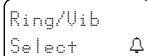

Shortcut: Press **FCN** then press Smart Button, then **3**, **1** and continue with step 4.



Ring/Vib
Select 



Getting to Tone Control...

1. Press **FCN** then press **Smart Button** to enter the menu system.
2. Press  to scroll to **Tone Control** and press **Smart Button** to select.
3. Press  to scroll to the following features:

Keypad
Tones On 

Keypad Tones

Keypad Tones are the sounds made when your phone's keys are pressed. If you need to be discreet, use this feature to silence the Keypad Tones.

Keep in mind: Even with Keypad Tones OFF, the party on the line with you will still hear the tones.

4. Press Smart Button to toggle Keypad Tones On or Keypad Tones Off.
5. Press **END** to exit the menu, or you may scroll to other features.

Shortcut: Press **FCN** then press Smart Button, then **3**, **2** and continue with step 4.

Transmit Tones

Your phone transmits DTMF tones to communicate with automated calling systems like Voice Mail. For most systems, you should choose short tones. If you choose long tones, your phone will transmit the tones for as long as you press and hold the key. To silence the tones during conversations, just turn the tones OFF.

DTMF
Select 

4. Press Smart Button to select DTMF Select. You will see the current setting.
5. Press volume keys to scroll through the following: Transmit DTMF Long, Transmit DTMF Short, or Transmit DTMF Off.
6. Press Smart Button to select the setting you want.
7. Press **END** to exit the menu, or you may scroll to other features.

Shortcut: Press **FCN** then press Smart Button, then **3**, **3** and continue with step 4.

Tip: You can still use automated calling systems with Transmit DTMF OFF. When the system prompts you for input, follow this sequence to transmit the tones:

1. Enter the numbers you need to transmit.
then
Press **RCL** then press **SEND** to send the tones.
2. Repeat step 1 for each set of numbers you need to transmit.

Message Reminder Tones

There's no need to worry about missing the new message alert or the new message indicators. Just turn Message Reminder Tones ON and your phone will remind you of unread messages by beeping or vibrating every two minutes.

4. Press Smart Button to toggle Msg Remind Tones On or Msg Remind Tones Off.
5. Press **END** to exit the menu, or you may scroll to other features.

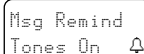

Msg Remind
Tones On 



Service Tones

When Service Tones are ON, you'll be alerted to any change in your cellular service. You'll hear two short beeps when your phone (1) starts to roam, (2) returns to a home system after roaming, (3) loses service, (4) finds service, or (5) moves from digital **D** to analog **A** service (or vice versa).

4. Press Smart Button to toggle Service Tones On or Service Tones Off.
5. Press **END** to exit the menu, or you may scroll to other features.

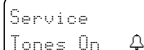

Service
Tones On 

Keep in mind: Your phone will always beep if a call is dropped.

Lock/Security



While you probably would not want to leave it unattended, your phone has a number of built-in security features to prevent unauthorized use.

In this chapter you will learn how to:

- lock and unlock your phone
- place emergency calls
- view and change your lock code
- restrict call placement and memory access
- reset or clear your phone's settings
- activate your phone's Authentication* feature

Follow these symbols as a guide for using the keys on the side of your phone.

Press  to scroll up

Press  to select

Press  to scroll down



*Contact your Service Provider for availability.

Road Map

Press **FCN** then press **▶** to enter the menu system.

Start:

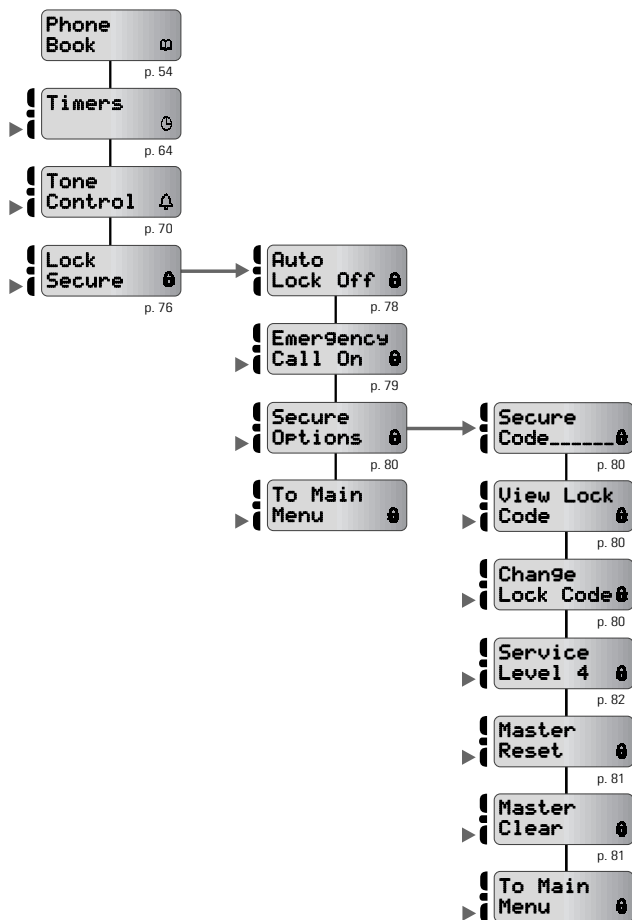

Getting to Lock/Security...

1. Press **FCN** then press **Smart Button** to enter the menu system.
2. Press **or** to scroll to **Lock Secure** and press **Smart Button** to select.
3. Press **or** to scroll to the following features:

Auto
Lock Off 

Auto Lock

Turn this feature ON and your phone will automatically lock itself each time the phone is turned OFF.

4. Press Smart Button to toggle Auto Lock Off or Auto Lock On.
5. Press **END** to exit the menu, or you may scroll to other features.

Locking the Phone

You can lock your phone manually at any time to help prevent unwanted use. Once locked, you can leave the phone ON or turn it OFF and the phone will remain locked.

1. Press **FCN** then press and hold **5**.
You will see: Lock?
2. Press Smart Button or **STD**.
You will see: Locked.

Unlocking the Phone

Unlocking your phone is quick and easy. Once your phone is ON, just enter your three-digit code. Your factory programmed lock code is 123. If you've changed this code and can't remember what it is, see View Lock Code on page 82.

Tip: You can still receive calls when the phone is locked. Follow these steps to answer an incoming call:

1. Enter your three-digit code.
2. Press Smart Button.
or
Press **SEND** to answer the call.

Emergency Call

You can make an emergency call even when your phone is locked. Just press and hold **1**. First you'll need to store an emergency number or the number of a close friend or relative in your memory location 01. See page 40 for more information on storing numbers into a memory location.

4. Press Smart Button to toggle Emergency Call On or Emergency Call Off.
5. Press **END** to exit the menu, or you may scroll to other features.

Shortcut: Press **FCN** then press Smart Button, then **2**, **9** and continue with step 4.

Keep in mind: Some cellular systems have their own emergency numbers and do not allow access to conventional emergency numbers like 911. Check with your Service Provider for more information.

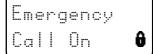
A screenshot of a mobile phone's emergency call menu. The text "Emergency Call On" is displayed in a monospaced font. To the right of the text is a small icon of a padlock with a keyhole, indicating that the feature is currently turned on.

Getting to Secure Options...

1. Press **FCN** then press **Smart Button** to enter the menu system.
2. Press **or** to scroll to **Lock Secure** and press **Smart Button** to select.
3. Press **or** to scroll to **Secure Options** Submenu and press **Smart Button** to select.
4. Enter your **six-digit secure code** and scroll to the following features:

Secure
Options 

View Lock
Code 

Change
Lock Code 

Secure Options Submenu

The Secure Options submenu contains a number of features to put your mind at ease. For your protection, you must enter a six-digit secure code in order to access these features. The factory programmed secure code is 000000.

View Lock Code

Forgot your lock code or need to double-check it? Help is only a few keystrokes away:

5. Press Smart Button to display your three-digit lock code.
6. Press **END** to exit the menu, or you may scroll to other features.

Shortcut: Press **FCN** then **0**, enter your six-digit security code, then press **RCL**.

Change Lock Code

Changing your lock code is easy—just follow these simple steps:

5. Press Smart Button to select.
You will see: Enter New Code ____.
6. Enter a new three-digit lock code. Your phone will confirm by displaying: New Lock Code XXX.
7. Press **END** to exit the menu, or you may scroll to other features.

Shortcut: Press **FCN** then **0**, enter your six-digit secure code, enter a new lock code, then press **STD**.

Master Reset

Use this feature to reset all user-selectable options back to their original factory settings.

Keep in mind: Once you select this feature, the reset process cannot be canceled or reversed.

5. Press **END** to exit the menu if you do not want to reset your phone's options.

or

Press Smart Button to select *Master Reset*.
You will see: *Standard Settings*.

6. Press **END** to exit the menu, or you may scroll to other features.

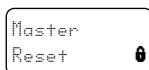

Master Clear

If you want to start with a clean slate, use Master Clear to clear all user-selectable options, the resettable timer, the Phone Book, and the Messaging memory.

Keep in mind: Once you select this feature, the process cannot be canceled or reversed.

5. Press **END** to exit the menu if you do not want to clear your phone's memory and reset its options.

or

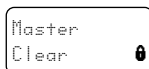

Press Smart Button to select *Master Clear*.
You will see: *Busy*. It will take a few seconds to reset all of your phone's options back to their factory settings.

6. Press **END** to exit the menu, or you may scroll to other features.



Lock/Security

Getting to Secure Options...

1. Press **FCN** then press **Smart Button** to enter the menu system.
2. Press  to scroll to **Lock Secure** and press **Smart Button** to select.
3. Press  to scroll to **Secure Options** Submenu and press **Smart Button** to select.
4. Enter your **six-digit secure code** and scroll to the following features:

Service
Level 4 

Service Level

When loaning your phone to others, you may want to restrict call placement or hide memory information. Your phone has two service levels that allow you to control the types of outgoing calls that can be made from your phone.

5. Press Smart Button to select Service Level X. (X is the number of the current level.) The phone will display a brief description of your current Service Level.
6. Press the volume keys to scroll through the Service Level settings.
7. Press Smart Button to select the Service Level you want.
8. Press **END** to exit the menu, or you may scroll to other features.

Your phone has two service levels:

<p>Level 1: Calls can be placed from memory locations 1-10 only.</p> <ul style="list-style-type: none">• No dialing from keypad.• No memory edit or storage.• No access to the Phone Book.• No Turbo Dial™ calls.• No access to messaging.	<p>1 Memory 1-10 Only</p>
<p>Level 4: This is the standard setting.</p> <ul style="list-style-type: none">• No restrictions.	<p>4 Standard Setting</p>

Authentication (A-Key) Entry

Your A-Key feature acts like a PIN code and helps to protect your phone from unauthorized users. Contact your Service Provider for your personalized A-Key number.

Keep in mind: This feature should only be programmed once.

To activate the A-Key feature:

1. Press **2**, **5**, **3**, **9** then **FCN**, **FCN**. You will see your phone's active phone number.

Tip: If the phone number displayed is not the number you want the A-Key programmed to, press **#▶** to select another number. This will be the phone number your phone will operate with once you exit the A-Key feature.

2. Enter your new A-Key (6- to 26-digit number) as provided by your Service Provider, then **STO**, **STO**.

Press **CLR** to correct any errors.

3. Press Smart Button to validate the A-Key entry. You will see **Valid** if the A-Key was entered correctly, or you'll see **A-Key Invalid** if you need to re-enter your A-Key number.
4. Press **END** to exit the menu, or you may scroll to other features.

Phone Options



The Phone Options menu is your “command center” for adjusting the way your phone sends and receives calls. You can fine tune your phone for optimal performance, view information about your phone’s settings, and much more.

In this chapter you will learn how to:

- switch phone numbers
- review your phone’s settings
- select a variety of system specific settings

Follow these symbols as a guide for using the keys on the side of your phone.

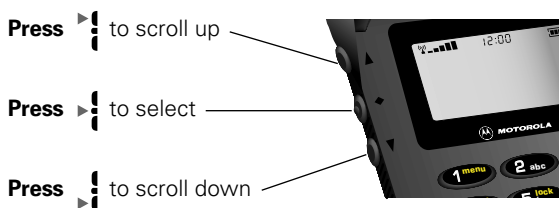



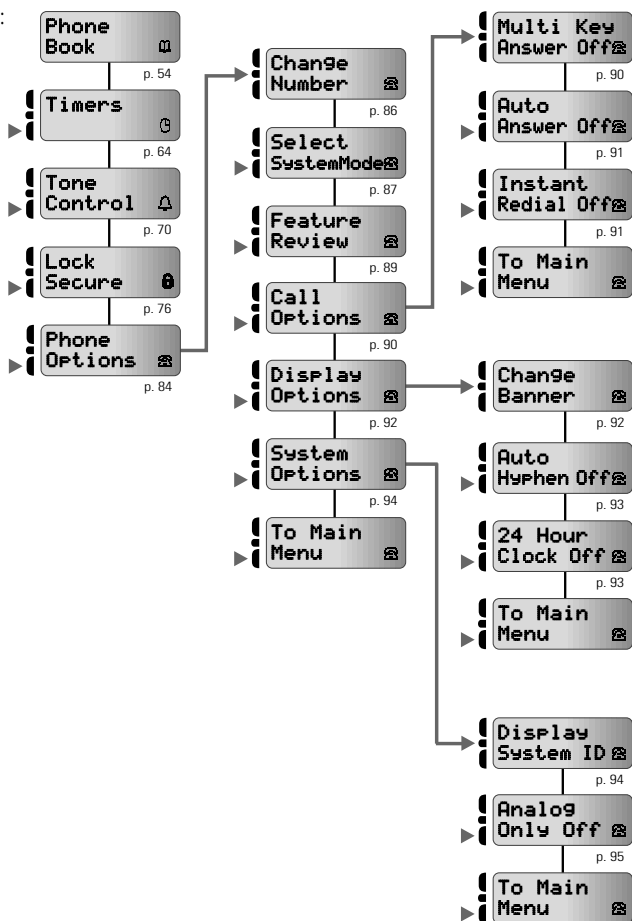

Road Map

Press **FCN** then press **▶** to enter the menu system.

Start:



Getting to Phone Options...

1. Press **FCN** then press **Smart Button** to enter the menu system.
2. Press  or  to scroll to **Phone Options** and press **Smart Button** to select.
3. Press  or  to scroll to the following features:

Changing Your Number

Your phone can be activated with up to four unique phone numbers. You could use one number for personal use, one for business, and the other two for cities that you travel to frequently. Use this feature to select an appropriate number.

Change
Number 

4. Press Smart Button to enter Change Number.
The display will show your phone's currently active number.
5. Press the volume keys to scroll through the phone numbers programmed into your phone.
6. Press Smart Button to select desired number.
You will see: **Set**.
7. Press **END** to exit the menu, or you may scroll to other features.

Selecting a System Mode

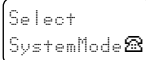

If you want to get into the nitty-gritty of your cellular phone's operation, read on. Your Service Provider configures this feature when you receive a cellular phone number. Select System Mode allows you to select the type of cellular system your phone will attempt to access. See the next page for a chart of available settings.

4. Press Smart Button to enter `Select SystemMode`. The display will show your phone's current System Mode setting.
5. Press the volume keys to scroll through the System Mode settings (see chart on next page).
6. Press Smart Button to select the setting that you want. You will see: `Set`.
7. Press **END** to exit the menu, or you may scroll to other features.











Select
SystemMode

Getting to Phone Options...

1. Press **FCN** then press **Smart Button** to enter the menu system.
2. Press  to scroll to **Phone Options** and press **Smart Button** to select.
3. Press  to scroll to the following features:

Selecting a System Mode

<p>Standard Mode: Your phone first seeks a home type system, then a non-home type system.</p> <p><i>If home system is non-wireline (type A)</i></p> <p><i>If home system is wireline (type B)</i></p>	<div style="border: 1px solid black; padding: 5px; margin-bottom: 5px;">Std AB </div> <div style="border: 1px solid black; padding: 5px;">Std BA </div>
<p>Reversed Preference Mode: Your phone first seeks a non-home type system, then a home type system. (This mode may be useful in fringe areas or certain roaming situations.)</p> <p><i>If home system is non-wireline (type A)</i></p> <p><i>If home system is wireline (type B)</i></p>	<div style="border: 1px solid black; padding: 5px; margin-bottom: 5px;">Scan BA </div> <div style="border: 1px solid black; padding: 5px;">Scan AB </div>
<p>Home Only Mode: Phone will not operate outside its home system.</p>	<div style="border: 1px solid black; padding: 5px;">Home Only </div>
<p>Scan A Mode: Phone will operate only within non-wireline (A) systems.</p>	<div style="border: 1px solid black; padding: 5px;">Scan A </div>
<p>Scan B Mode: Phone will operate only within wireline (B) systems.</p>	<div style="border: 1px solid black; padding: 5px;">Scan B </div>
<p>Preferred System ID Mode: Phone will scan for home or programmed preferred SIDs first. This choice requires entry of up to 60 System ID numbers for those systems in which you wish to operate. Contact your Cellular Service Provider for SID information.</p>	<div style="border: 1px solid black; padding: 5px;">Preferred SID Scan </div>

Feature Review

After you've spent some time adjusting your phone's settings, use this feature to review the changes you've made. When you enter Feature Review, your phone will display any features that you have changed from their default factory settings.



Keep in mind: Feature Review is simply an opportunity to review – but not change – your current settings.

4. Press Smart Button to enter Feature Review.
5. Press the volume keys to scroll through any features you have changed from their default settings.
or
If all features are set to their default factory settings, the display will show: Standard Settings.
6. Press **END** to exit the menu, or you may scroll to other features.

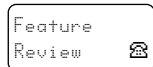
Shortcut: Press **FCN** then **0**, **9**, **RCL**.



Getting to Call Options...

1. Press **FCIN** then press **Smart Button** to enter the menu system.
2. Press  to scroll to **Phone Options** and press **Smart Button** to select.
3. Press  to scroll to **Call Options** Submenu and press **Smart Button** to select.
4. Press  to scroll to the following features:

Multiple Key Answer

Why fumble for the **SEND** key to answer calls? With Multiple Key Answer ON, you can answer calls by pressing the Smart Button, the upper or lower volume keys, or any key in the center of the keypad, **1** through **#▶**.

5. Press Smart Button to toggle between Multi Key Answer Off or Multi Key Answer On.
6. Press **END** to exit the menu, or you may scroll to other features.

Keep in mind: If there are any digits in your Scratchpad or if your phone is locked, this feature will not work.

Multi Key
Answer Off 

Auto Answer

Turn Auto Answer ON to have your phone automatically answer incoming calls after two rings.

Keep in mind: If the ringer and VibraCall™ alert are OFF and Auto Answer is ON, your phone will answer without ringing or vibrating.

5. Press Smart Button to toggle between Auto Answer On or Auto Answer Off.
6. Press **END** to exit the menu, or you may scroll to other features.

Shortcut: Press **FCN** then press Smart Button, then **2**, **6**, and continue with step 5 above.

Auto
Answer Off 

Instant Redial



When you hear a fast busy signal and see System Busy or No Service, the network may not be able to handle your call at the moment. Turn Instant Redial ON to have your phone automatically redial for the next four minutes.

5. Press Smart Button to toggle Instant Redial On or Instant Redial Off.
6. Press **END** to exit the menu, or you may scroll to other features.

Keep in mind: If you receive a normal busy signal, this feature will not work.

Instant
Redial Off 

Getting to Display Options...

1. Press **FCM** then press **Smart Button** to enter the menu system.
2. Press  to scroll to **Phone Options** and press **Smart Button** to select.
3. Press  to scroll to **Display Options** Submenu and press **Smart Button** to select.
4. Press  to scroll to the following features:

Change Banner

Want to give your phone even more personality? Then create your own message banner for the phone to display when it's idle. Your banner can be up to 12 characters long.

Change
Banner 

5. Press Smart Button to enter **Change Banner**.
You will see either the current banner or if no banner is programmed: Alpha or Press *.
6. Enter your message using the alphanumeric keypad. (See page 38 for more information on entering alphanumeric messages.)
7. Press Smart Button when your message is complete.
8. Press **END** to exit the menu, or you may scroll to other features.

Auto Hyphen

Just turn Auto Hyphen ON to have all phone numbers automatically hyphenated on the display. This allows you to easily distinguish between area codes, call prefixes, and other numbers.

5. Press Smart Button to toggle Auto Hyphen On or Auto Hyphen Off.
6. Press **END** to exit the menu, or you may scroll to other features.

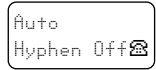



Auto
Hyphen Off 

Display 24-Hour Clock

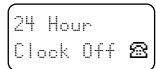

Your phone can display the current time in 12-hour or 24-hour format.

5. Press Smart Button to toggle 24 Hour Clock On or 24 Hour Clock Off.
6. Press **END** to exit the menu, or you may scroll to other features.



24 Hour
Clock Off 

Getting to System Options...

1. Press **FCN** then press **Smart Button** to enter the menu system.
2. Press  to scroll to **Phone Options** and press **Smart Button** to select.
3. Press  to scroll to **System Options** Submenu and press **Smart Button** to select.
4. Press  to scroll to the following features:

Display System ID

Use this feature to determine the unique System ID for your dual mode StarTAC cellular phone.

Display
System ID 

5. Press Smart Button to enter Display System ID.
6. Press **END** to exit the menu, or you may scroll to other features.

Analog Only

Turning Analog Only ON tells your phone to select an analog channel  for the next call. If you don't place a call, your phone will revert to dual mode service after a few minutes.

5. Press Smart Button to toggle Analog Only On or Analog Only Off.
6. Press **END** to exit the menu, or you may scroll to other features.

Shortcut: Press **FCN** then **2** to toggle Analog Only On or Analog Only Off.

Tip: Some peripheral devices, like fax machines and modems, require analog operation.



Analog
Only Off

Accessory Options

An exciting line of StarTAC™ phone accessories, now smaller and lighter than ever, can enhance and personalize your cellular experience.

Lithium Ion Batteries

Motorola's Lithium Ion (LiIon) batteries are high energy-density batteries that offer increased capacity and are lighter in weight than similar sized Nickel Cadmium and Nickel Metal Hydride batteries.

Nickel Metal Hydride Batteries

Nickel Metal Hydride batteries (NiMH) are high-capacity batteries that offer up to 30% more talk-time than comparable Nickel Cadmium batteries. To help achieve maximum life and capacity for your NiMH battery, do not leave the battery in the charger for more than 24 hours, and use only Motorola-approved chargers.

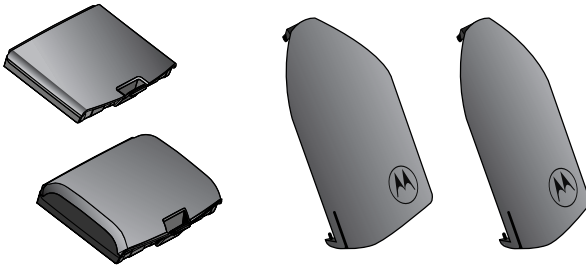

Cigarette Lighter Adapter

Lets you plug into a reliable power source on the road. Uses your car's battery to power your phone and rapid charge its battery at the same time. The Cigarette Lighter Adapter will not over-charge your battery and contains circuitry to protect against overvoltage and power surges in the vehicle. In some cars, the engine must be running in order for the cigarette lighter to operate.



Accessory Options

Desktop Charger (AC Adapter required)

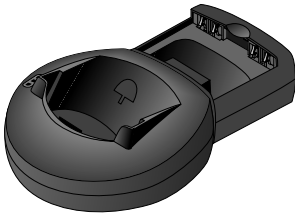

This charger has two pockets to charge up to two batteries simultaneously. Each pocket has its own sequential charging status LEDs. The desktop charger's front pocket can charge batteries while they are attached to your phone, and the rear pocket can charge batteries separately. It's easy to rotate batteries and always have a charged spare. For use with Lithium Ion, Nickel Cadmium and Nickel Metal Hydride batteries.

Holster

StarTAC is so small and light, it's positively wearable. Slip it in the holster and clip the holster on—for the ultimate in high-tech fashion.



Headset



The convenient headset provides both an earphone and microphone in one small piece for simple hands-free and private telephone conversations. The headset plugs directly into the jack on the top of your phone, so that you can wear your phone and move freely. Place the foam cover on the earpiece for a more comfortable fit.

See pages 86-87 for Call Options that make using a headset with your phone even more convenient. To answer with any key on the side of your phone, you can set Multiple Key Answer ON, or use Auto Answer to set your phone to automatically answer after two rings. You can even use the Smart Button to end calls (see page 25). You don't have to open your phone to take a call.

Accessory Options

3-Watt Vehicular Kit

The 3-Watt Vehicular Kit delivers a full 3 watts of power. This booster works behind the scenes to increase performance, especially in fringe areas.

Keep in mind: This kit only works when your phone is on an analog system (). If you plan to use your phone on a CDMA digital system, we recommend that you purchase the Hands-Free Vehicle Kit on the previous page.

3-Watt Vehicular Kit components:

- Hands-Free phone holder with rapid battery charger
- External microphone
- External speaker
- 3-watt booster
- External antenna (not included)

We recommend you use genuine Motorola batteries and accessories. Under its cellular telephone warranty, Motorola specifically disclaims any responsibility for damage caused by the use of portable cellular telephone accessories not manufactured by Motorola.

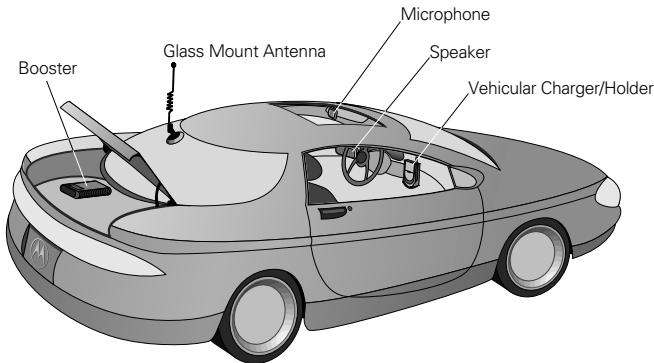

Accessory Options

Hands-Free Vehicle Kit

Optional Hands-Free Kits give you the convenience of hands-free, speaker phone operation while in your car. Full duplex operation lets you simultaneously talk and listen, so both parties can interrupt each other for a normal sounding conversation.

The Hands-Free Kit powers the phone and rapid charges its battery whenever your car's engine is running.

Montana Modem/Fax PC Card

If you have a Motorola Montana 33.6 Modem/Fax PC Card, you can use your dual mode StartAC™ phone to transmit data and faxes. Just connect your phone to a personal computer with Type II or Type III PCMCIA slots and your phone can transmit data at 33.6 Kbps and faxes at 14.4 Kbps.

Mariner 33.6 Modem/Fax/LAN PC Card

This accessory adds Ethernet capability to all the features of the Motorola Montana 33.6 Modem/Fax PC Card described above.

Troubleshooting

- Q.** I pressed the power button, but nothing happened. What's wrong with my phone?
- A.** Check that you have installed a battery and that the battery is charged. See page 16 for information about installing your battery.
- Q.** The display says *Locked*. How do I unlock my phone?
- A.** Try entering the last three digits of your cellular number. If that doesn't work, try using the factory preset lock code: 123. If all else fails, call your Service Provider (the company that sends you your monthly cellular bill) for assistance. For more information on your phone's security features, see the Lock/Security chapter, page 78.
- Q.** My battery didn't last as long as I expected. What can I do to extend battery life?
- A.** To get the most from your battery, make sure it is fully charged. To charge the battery to 100% of its capacity, leave it in the charger for an extra hour after the charger's light turns green.
- Exposing your battery to extreme temperatures—below -10°C (14°F) or above 45°C (113°F)—can shorten battery life. Batteries are especially sensitive to high temperature extremes. As a good rule of thumb, always take your phone with you when you leave your car.
- Q.** I tried to place a call and received a fast busy signal.
- A.** This sound means that the cellular system did not process your call. For example, the cellular system may be overloaded with call attempts. To redial the number, press the Smart Button or press **SEND** before ending your call attempt, or press **END** and try the call again later. See page 93 for more information on redialing.

Troubleshooting

- Q.** I tried to place a call and received an alternating high/low tone.
- A.** This sound means your call did not reach the cellular system. Most likely, you dialed the number too soon after turning the phone ON. Wait until the NS indicator disappears before placing a call.
- An alternating tone may also indicate that your phone's signal is blocked. Make sure the antenna is fully extended and move clear of any obstructions, like bridges, parking garages, tall buildings, etc.
- Q.** My phone started beeping, and the display says: 1 Call Unanswered. What happened?
- A.** Someone tried to call you while you were in an area where the cellular signal was weak. Press **CLR** to clear your display, extend your phone's antenna, and avoid obstructions like tunnels, parking garages and tall buildings whenever possible.
- Q.** My phone was stolen. What should I report and to whom?
- A.** Report a stolen phone to the police and to your Service Provider (the company that sends you your monthly cellular service bills).

Glossary

A

AC adapter An accessory device that allows you to power and/or charge your phone from a wall outlet. See page 20.

accessory connector A socket on the bottom of the phone where you can attach accessories such as an AC adapter or cigarette lighter adapter. To learn more, see page 20.

air-time The amount of time you spend using a cellular system, between the time you successfully place a call and the termination of that call.

alkaline A battery technology used in personal cellular telephones.

analog The traditional method of cellular transmission. In addition to analog capability, your dual mode StarTAC phone is equipped to handle digital transmission. See also CDMA.

antenna The device on your phone that sends and receives cellular signals. For tips on antenna use and efficiency, see page 10.

Auto Answer When you activate this feature, your phone automatically answers after two rings. See page 93.

Auto Hyphen A feature that automatically inserts hyphens into displayed phone numbers for easier visibility. See page 95.

Automatic Redial When your cellular network cannot handle your call, this feature enables your phone to automatically redial with one button push. See page 93.

C

Call Back number A phone number in an alphanumeric message, provided by the sender. See page 52.

Caller ID A network/subscription dependent service that allows you to view information on incoming calls before answering. See page 32.

CDMA (Code Division Multiple Access) CDMA takes digitized voice and encodes it in a unique scheme that is sent out over the air. CDMA digital reduces the probability of dropped calls. Your dual mode StarTAC™ phone is equipped to handle CDMA digital voice transmission.

cellular carrier One of multiple competing companies in a given geographic area that owns and operates a cellular system.

Cellular Service Provider A company affiliated with a cellular carrier that provides cellular service to its customers.

cellular signal The radio waves that carry information between your cellular phone and the cellular system.

cellular system The cellular equipment in a given geographic area that relays signals to and from individual cellular telephones and the landline telephone system.

cigarette lighter adapter An accessory device that allows you to power and/or charge your phone from a car's cigarette lighter.

Glossary

D

dedicated Message Key See Message Key.

default A feature's original setting as programmed in the factory.

digital See CDMA.

DTMF Dual Tone Multi-Frequency are the tones that your phone transmits to communicate with tone activated phone systems like Voice Mail or bank-by-phone. See page 72. Keep in mind: "DTMF Tones" does not refer to the sounds produced by your phone's speaker. See Keypad Tones for information on the sounds produced by your phone's speaker.

E

Emergency Call This feature allows you to place a call from memory location 01 even if the phone is locked. See page 81.

F

fringe area The outermost range of a cellular system where cellular signals are weak.

function keys The non-numeric keys on your phone used to access and navigate menu features, as well as perform memory functions. See page 24.

H

Home Only Mode When your phone is active in this System Mode setting and you are beyond the range of your home Service Provider, your phone will not operate. See pages 89-90. See also system type.

home system The local cellular system where you obtain your cellular service.

home type system A cellular system of the same type as the local cellular system where you obtain your service. See also non-home type system and system type.

I

icon One of the variety of symbols used to designate menu features and messages.

indicator A symbol on your phone that gives you information about your phone's status. See pages 28-29.

Glossary

K

Instant Redial When your cellular network cannot handle your call, this feature enables your phone to continuously redial for four minutes or until your call is picked up by the network. See page 93.

Internal Rapid Charger A charger built into your phone for use with an AC adapter or cigarette lighter adapter. See page 20.

Keypad Tones The sounds produced through your phone's speaker when you press the keys. See page 76. Keep in mind: "Keypad Tones" does not refer to the tones sent by your phone to communicate with automated phone systems. See Transmit Tones for information on the tones used to access automated phone systems.

L

landline The telephone system used for conventional office and home phones.

Lithium Ion (LiIon) A battery technology used in personal cellular telephones. Lithium Ion batteries generally provide more energy capacity than Nickel Metal Hydride batteries of the same weight.

lock To prevent unauthorized access to the cellular telephone. See page 80.

lock code A three-digit code used to access your phone once it has been locked. The factory programmed lock code is 123. To view or change your lock code, see page 82.

M

memory location A space in the internal Phone Book where you can store a telephone number and a name. Each of the Phone Book's 99 memory locations (numbered 01-99) can hold up to 32 digits and 24 letters.

menu This system contains five features: Phone Book, Timers, Tone Control, Lock/Secure, and Phone Options.

menu feature Any feature that can be accessed through the menu system.

Message Key Located in the upper right corner of the keypad, the dedicated Message Key offers one-touch access to messages and messaging functions. See page 46. See also Caller ID, Messages, and Voice Mail.

Messages A network/subscription dependent service that enables your phone to receive alphanumeric messages just like a pager. See page 53.

Messaging Function Menus While viewing your Caller IDs, reading your Messages, or checking your Voice Mail, you can use these menus to manage your messages: lock or unlock an alphanumeric message, delete one or all of your Caller ID or alphanumeric messages, or select a different message type.

N

Nickel Cadmium (NiCd) A battery technology used in personal cellular telephone batteries.

Nickel Metal Hydride (NiMH) A battery technology used in personal cellular telephone batteries.

Glossary

non-home type system A system type different from your home system. See also home type system and system type.

non-wireline See system type.

P

pause A special character that tells your phone to wait before sending the next set of numbers stored in one memory location. See Pause Dialing.

Pause Dialing A method of storing Phone Book entries that allows you to store multiple strings of numbers in one memory location; useful, for instance, in accessing automated phone systems. See page 61.

Personal Identification Number (PIN) A private numeric password which protects personal accounts such as bank-by-phone or Voice Mail.

Phone Book An alphabetical list of the names and telephone numbers you have stored into your phone's internal memory.

Preferred System ID Mode When your phone is in this system mode setting, it will scan for systems on a preferred list. This choice requires entry of up to 60 System ID numbers. Contact your Service Provider for SID information.

prompt A display message requesting input.

Q

Quad Number Your phone can be activated with up to four different phone numbers.
See page 27 to learn how to change the number active on your phone.

R

Reversed Preference Mode When your phone is active in this System Mode setting and you are beyond the range of your home Service Provider, your phone will seek a non-home type system, then a home type system. See pages 89-90. See also system type.

road map The visual representation of your phone's menu system provided in this manual.

roam To use a cellular system outside of your home system, usually when you travel beyond the range of your home system.

S



Scan A Mode When your phone is active in this System Mode setting and you are beyond the range of your home Service Provider, your phone will only operate on non-wireline type systems. See pages 89-90. See also system type.

Scan B Mode When your phone is active in this System Mode setting and you are beyond the range of your home Service Provider, your phone will only operate on wireline type systems. See pages 89-90. See also system type.

Glossary

Scratchpad A memory feature that automatically remembers the most recent number entered into the keypad. See page 45.

Scratchpad tones See DTME.

scroll To move backward or forward through a list; for example, to move backward or forward through the menu system or the Phone Book using either the volume keys or the  and  keys.

secure code A six-digit code used to access and change certain security features. The factory programmed secure code is 000000.

Service Provider See Cellular Service Provider.

Service Tones Two short beeps used to alert you to any changes in your cellular service. See page 77.

signal See cellular signal.

Silent Mode Select this feature and all your phone's tones will be silenced and the VibraCall™ alert activated. See page 74.

soft-handoff Unlike traditional analog technology where you are disconnected from one cell site and then connected to another, CDMA digital technology connects you to a new site before disconnecting you from the old site. This is known as a “soft-handoff.” With soft-handoff technology, you could experience fewer dropped calls as you travel between cell sites.

Smart Button The middle key on the side of your phone used to access the Phone Book, place calls, end calls, select the Phone Book, enter the menu system, and toggle features ON and OFF.

Standard Mode When your phone is active in this System Mode setting and you are beyond the range of your home Service Provider, your phone will seek a home type system, then a non-home type system. See pages 89-90. See also system type.

standby-time The total time your phone is ON but not used for talking.

Super Speed Dial A dialing shortcut that allows you to quickly dial any number in the internal Phone Book. To use this feature, enter the two-digit location of your number, 01-99, then press and hold Smart Button or press  and the call is placed. See page 44.

System ID Every cellular system has a unique number to identify itself. See page 96.

System Mode A setting that determines the system type that your cellular phone will access. See pages 89-90 to select a System Mode.

system type A designation that indicates one of the two competing cellular carriers in a given geographic area. The non-wireline carrier operates on the “A” block of cellular frequencies, and the wireline carrier operates on the “B” block of cellular frequencies.

Glossary

T

talk-time The total time that you can talk on your phone before the battery is fully discharged.

toggle To switch between two possible options; for example: ON vs. OFF. Pressing the Smart Button toggles features ON or OFF.

Transmit Tones See DTMF.

Turbo Dial™ keys To use this feature, press and hold a number on the keypad, **1** through **9**, and your call is placed.

U

unlock code See lock code.

V

VibraCall™ alert When activated, this feature alerts you silently of incoming calls by vibrating. It can be used alone or in conjunction with the ringer. See page 75.

Voice Mail Contact your Service Provider for availability.

volume keys Located on the side of your phone, the upper and lower volume keys are used to adjust ringer and keypad volume. They also scroll within the menu system and the Phone Book.

W

wireline See system type.

Patent Information

Manufactured under one or more of the following U.S. patents:

4121218	4654655	4851966	5083304	D340710	5475752
4138681	D289156	4686576	D324024	5260988	D365094
4193036	4662691	4870686	D324388	5261119	D365817
4254382	4667333	D303656	5095503	5262710	5486843
4302845	4668917	4876552	D325028	5263052	5487184
4312074	4670747	4879533	D325583	5276707	5488335
4327319	4672502	D305427	5109536	5278994	5488649
4329666	4680787	4896124	D325915	D343173	D366872
4369516	4681476	4897873	5113436	5280637	5493198
4369522	4683585	D305717	5117450	D344087	5493714
4378603	4692726	4904549	5121047	5287553	5497126
4390963	4704588	4905288	5122480	5287555	5497382
D269873	D292578	4905301	5122722	5287556	D367640
4398265	4706036	D306293	D327061	D344511	5499394
4400584	D292920	D306441	5128834	5301365	5506490
4400585	4710724	D306594	D328302	5321847	D368696
D270835	4711361	4912602	5142551	D348880	5510693
D271491	4715063	4918732	5142696	5349588	5511235
Re.31470	4716319	4922178	5146620	5359696	D369162
4431977	4716391	4945570	5148471	5361400	5513078
4434461	4723305	4954796	5148473	5363071	D369359
4455534	D294257	4959851	5148961	5365549	5519303
4462098	4727306	4963812	5150359	D352497	5519346
D275951	4727583	4963843	5150384	5366826	5524276
4484153	4730195	4965537	5152006	D353131	5524278
4485486	4734635	4972355	5157693	D353361	D370463
4486624	4736277	4972432	5163159	5375143	5530922
D276809	4737976	4972455	5164652	5375258	5542116
4491972	4740794	4975808	5166596	5379324	5544250
D277667	4741018	4984290	5175759	D354055	D372481
4504834	4741034	D314173	5175874	D354062	5546275
D278708	4742562	D315330	D332261	5384825	5546380
4523155	D295627	D315346	5182749	D356084	D372896
4546329	4746242	D315543	D332785	5402447	5551078
4550426	D295973	D315559	5185566	5406146	5559471
4551696	D295975	D315565	5187809	5406562	D374424
4564821	4751737	5004992	5193223	D357224	D374872
D282169	D296187	D315907	5195106	D357457	5572193
4571595	4761621	5008925	5195108	5410741	5574976
4573017	4764737	D316417	5201069	D357680	5577268
4574243	D297734	D316859	5204977	D357681	D375732
4585957	D297735	5017856	5210793	5428836	D375733
4602218	4777564	5018188	5214675	D359734	D375734
D284759	Re.32768	5020091	5222104	D359735	D375932
D285439	D299136	5020092	5222251	D359959	D375952
4616314	4797929	5020093	D337332	5432017	D376127
4617520	4798975	5028083	5230007	D360632	5588041
D286778	4800348	5028859	5230093	5438684	5589796
4626309	4802236	5029044	5233633	D361070	5590177
4628529	4809356	5029233	5235492	5442680	5594778
4629829	4811377	5031028	5237257	5446763	5594951
4630304	4811404	5036532	5239127	5448763	D377792
4630305	4827226	5053924	5241545	5448771	D377934
4633141	4827507	5057762	5241548	5453997	5604050
4636593	4829274	D320780	5241650	D362840	5606730
4636741	4837534	5059885	5241693	5457744	D378366
D288432	D301476	5060294	5242767	5459640	5613229
4648125	4843621	D322783	D339582	5463646	5613863
4649543	4845772	D322955	5249302	5465412	5615233
D288683	D302015	5081674	5251331	5469177	5621763

Other patents pending.

Index

A

- AC adapter 20–21
- Accessory Options 98–101
- adjusting volume 35
- alpha entry 41
- alphanumeric messages 7
- Analog Indicator 27, 29
- Analog Only 97
- audible timers
 - One Minute 70
 - Repeating 70
 - Single 71
- Authentication Entry 85
- Auto Answer 93
- Auto Display Individual Timer 69
- Auto Hyphen 7, 95
- Auto Lock 80
- Automatic Redial 33

B

- banner 94
- batteries 16–23
 - chargers 20–23
 - covers 16–17
 - installing 18–19
 - storage & disposal 23
 - varieties 98
- battery level
 - checking 30
 - indicator 28
 - shortcut 36

C

- Call Back
 - Caller ID 48
 - Messages 52
- Call Options 92–93
- Call Timers 66–71
 - Cumulative 69
 - Individual 68, 69
 - One Minute Audible 70

- Repeating Audible 70
- Resettable 68, 69
 - road map 67
 - Single Audible 71
- Caller ID 7, 32
 - Call Back 48
 - deleting 49
 - Message Indicator 29
 - name look-up 7
 - Number Preference 65
 - options 49
 - storing 48
 - viewing 48
- CDMA Digital Service 6, 26
- Change Banner 94
- Change Lock Code 82
- Changing Your Number 88
- chargers 20–23
 - desktop 21–23
 - Internal Rapid 20
- Charging the Battery 20–23
- Checking Your Voice Mail 50
- cigarette lighter adapter 20, 98
- Clear Resettable Call Timer 69
- Clear, Master 83
- clock 6, 28
 - display format 95
- Cumulative Timer 69

D

- Dedicated Message Key 24
- deleting
 - Caller ID 49
 - Messages 53
- desktop charger 21–23
 - indicator lights 21
 - times 23
- Digital Indicator 29
- display 7
- Display 24-Hour Clock 95
- Display Last Ten Numbers Dialed 34

Display Options **94–95**
Display System ID **96**
DTMF **76**

E

earpiece volume **35**
Editing a Memory Location **62–63**
Emergency Call **81**
ending calls **31, 32**
Entering Names **41**

F

fax compatibility **101**
Feature Review **91**
Function Key **24**

G

Glossary **104–109**

H

Hands-Free Vehicle Kit **98**
Hyphen, Auto **95**

I

In Use Indicator **29**
Incoming Call Indicator **30**
indicators
 Analog **29**
 Battery Level **28, 30**
 shortcut **36**
 Caller ID/Message **29**
 desktop charger lights **21**
 Digital **29**
 In Use **29**
 Incoming Call **30**
 No Service **29**
 Roam **29**
 Signal Strength **28**
 Silent Mode **29**
 VibraCall™ On **29**
 Vibrate Then Ring **29**
 Voice Mail **29**

Individual Call Timer
 Auto Display **69**
 viewing **68**
Installing the Battery **18–19**
Instant Redial **8, 93**
Internal Rapid Charger **20**

K

Key Answer, Multiple **92**
Keypad Tones **76**

L

Last Ten Numbers Dialed **34**
Lithium Ion Batteries **98**
lock code
 changing **82**
 viewing **82**
Lock/Security **78–85**
 road map **79**
locking/unlocking **80**
 shortcut **36**

M

Making the Most of Memory **39**
Mariner Modem/Fax/LAN PC Card
 101
Master Clear **83**
Master Reset **83**
memory **38–45**
 editing **62–63**
 Entering Names **41**
 Making the Most of **39**
 recalling **42–43, 58–59**
 storing **40, 60**
 while calling **45**
 Super Speed Dial **44**
 Turbo Dial™ keys **44**
menu
 features **54**
 navigating **54**
Message Indicator **29**
Message Reminder Tones **77**

Messages

- Call Back **52**
- dedicated key **24**
- deleting **53**
- options **53**
- reading **52**
- receiving **47**
- Reminder Tones **77**
- store Call Back number **52**

Messaging Menu **7, 46**

- modem compatibility **101**
- Montana Modem/Fax PC Card **101**
- Multiple Key Answer **92**
- mute **35**
 - shortcut **36**

N

- Nickel Metal Hydride Batteries **98**
- No Service Indicator **29**
- Number Preference **65**

O

- One Minute Audible Timer **70**

P

- Pause Dialing **61**
- personalizable banner **6, 94**
- Phone Book **56–65**
 - editing **62–63**
 - Entering Names **41**
 - recalling **42–43, 58–59**
 - road map **57**
 - status **8, 59**
 - storing **40, 60**
 - while calling **45**
 - Super Speed Dial **44**
 - Turbo Dial™ keys **44**
 - Using Memory **38–45**
- Phone Options **86–96**
 - road map **87**
- Phone Overview **24**
- placing calls **31**

power key **24**

- Preferred System ID Mode **90**
- Previous User Compatibility **55**
- programmable timers
 - Repeating Audible **70**
 - Single Audible **71**

Q

- Quad Number **8, 88**

R

- Reading the Indicators **28–30**
 - Reading Your Messages **52**
 - Real Time Clock **6, 28**
 - recalling
 - by location **43, 59**
 - by name **42, 58**
 - receiving calls **32**
 - Receiving Messages **47**
 - redial
 - Automatic **33**
 - Instant **93**
 - Last Ten Numbers Dialed **34**
 - Reminder Tones, Message **77**
 - Reset, Master **83**
 - Resettable Call Timer
 - clearing **69**
 - viewing **68**
 - ringer
 - Ringer/Vib Select **75**
 - silencing **74**
 - style **74**
 - volume **35**
 - road maps **55**
 - Roam Indicator **29**
- ## **S**
- Safety Information **10–13**
 - Scratchpad **45**
 - secure code **82**
 - Secure Options **82–85**
 - Select Ringer Style **74**

Service Level **84**
Service Tones **8, 77**
shortcuts **36, 55**
Signal Strength Indicator **28**
Silent Mode **8, 74**
 Indicator **29**
 shortcut **36**
Slim Nickel Metal Hydride Batteries
 98
Smart Button **25, 42**
storing **40, 60**
 Caller ID **48**
Super Speed Dial **44**
System ID **96**
System Mode **89–90**
System Options **96**

T

Three-Watt Vehicular Kit **100**
timers
 Cumulative **69**
 Individual **68, 69**
 One Minute Audible **70**
 Repeating Audible **70**
 Resettable **68, 69**
 Single Audible **71**
Tone Controls **72–77**
 Basic **35**
 road map **73**
 volume **35**
Tones
 Keypad **76**
 Message Reminder **77**
 Service **77**
 Transmit **76**
Transmit Tones **76**
Troubleshooting **102–103**
Turbo Dial™ keys **44**
Turning Your Phone On **26**

U

unlocking **80**

Using Memory **38–45**
Using Messaging **46–53**

V

vehicle accessories **100–101**
VibraCall™ alert **74–75**
 shortcut **36**
VibraCall™ On Indicator **29**
Vibrate Then Ring Indicator **29**
View Cumulative Timer **69**
View Individual Timer **68**
View Lock Code **82**
View Resettable Timer **68**
Viewing Your Caller IDs **48**
Viewing Your Number **64**
Voice Mail **7**
 checking **50**
 Indicator **29**
 options **51**
volume, adjusting **35**

W

What's New? **6–8**

Y

Your Phone & Its Shortcuts **36**