

APPLICANT: MOTOROLA, INC.

FCC ID: IHDT6EA1

**INSTRUCTION MANUAL**

A preliminary draft copy of the Users Manual follows:

# Welcome

---

Welcome to the world of Motorola digital wireless communications! We are pleased that you have chosen the Motorola V690 wireless phone.



**Tip:** 5-way navigation key (except **OK**) also serves as shortcuts to menu features by setting home keys (see page 94).

Personal Communications Sector  
600 North U.S. Highway 45  
Libertyville, Illinois 60048

1-800-331-6456 (United States)  
1-888-390-6456 (TTY/TDD United States)  
1-800-461-4575 (Canada)

[www.motorola.com](http://www.motorola.com) (United States)  
[www.motorola.ca](http://www.motorola.ca) (Canada)

MOTOROLA and the Stylized M Logo are registered in the US Patent & Trademark Office. Java and all other Java-based marks are trademarks or registered trademarks of Sun Microsystems, Inc. in the U.S. and other countries. All other product or service names are the property of their respective owners.

© Motorola, Inc. 2003.

### **Software Copyright Notice**

The Motorola products described in this manual may include copyrighted Motorola and third-party software stored in semiconductor memories or other media. Laws in the United States and other countries preserve for Motorola and third-party software providers certain exclusive rights for copyrighted software, such as the exclusive rights to distribute or reproduce the copyrighted software. Accordingly, any copyrighted software contained in the Motorola products may not be modified, reverse-engineered, distributed, or reproduced in any manner to the extent allowed by law. Furthermore, the purchase of the Motorola products shall not be deemed to grant either directly or by implication, estoppel, or otherwise, any license under the copyrights, patents, or patent applications of Motorola or any third-party software provider, except for the normal, non-exclusive, royalty-free license to use that arises by operation of law in the sale of a product.

Manual number: SJJN5732A

# Menu Map

---

You can display your phone's main menu as icons or as a text list. Each has its own organization and is different from the other. By default, your phone displays the main menu as icons.

To change the menu display mode:

## Find the Feature



> **Settings**

> **Menu style**

**Note:** The following is the standard phone menu layout. Menu organization and feature names may vary on your phone. Not all features may be available for all users.

# Main Menu Display



## Msg. center \*

- Text messages
- Multimedia msgs.
- Voice mailbox
- Cell broadcast
- Settings
- Sending history
- Service command



## Games

- Five ball
- Flying
- Popo car
- Sound effect



## Alarm clock

- On
- Off



## Chatroom \*



## Quick access

- Browser
- Media center
- Last call time
- Wallpaper
- Add entry to phonebook
- Calculator
- Games
- Meeting mode
- Ringing tone
- Edit



## Media center

- New picture
- Photo album
- Picture
- Animation
- Melody
- Voice notes
- Video
- Download media
- View free space



## Tools

- Calendar
- Calculator
- Stopwatch
- Tone editor
- Voice commands
- Video player
- My picture



## Java

- BombHunt
- SpaceFighter



## Settings

- Language
- Backlight
- Adjust contrast
- Clock
- Auto power off
- Display
- Key lock
- Input mode
- Home keys
- Restore factory
- Security
- Call features
- Network
- Connection indication
- Minute reminder
- Menu style
- Java settings
- Light sensor

\* Optional network, SIM card, or subscription-dependent feature.

# Main Menu Display



## Profile

- Normal
- Meeting
- Outdoors
- Car
- Customized
- Office
- Handsfree
- Headset
- Silence



## Recent calls

- Missed calls
- Received calls
- Dialed calls
- Erase all
- Call time
- Call cost
- GPRS data counter
- GPRS connection time
- In-call count
- Session information



## Phonebook

- Search
- Add
- Erase
- Copy
- Option
- Speed dial
- Caller group
- Personal number
- Fixed dial number
- Voice tags
- My Own Card



## Ringing style

- Ringing volume
- Ringing tone
- Incoming call alert
- Vibrating
- Message alert tone
- Key tone volume
- Key tone type
- Warning tones
- Startup music



## Camera



## V. recorder



## Browser \*

- Home
- Bookmark
- Profiles
- Appearance settings
- Download settings
- Go to address
- Clear the cache
- Service Inbox
- Certificates



## Bookmark



## Voice notes



## STK \*

### Shortcuts

#### Open menu options:

Press  (in idle).

#### Go to dialed calls list:

Press  (in idle).

#### Turn on voice-activated commands:

Press and hold the voice activation key (in idle) and then say a command into the microphone.

#### Turn off the ringer:

Press and hold  (in idle).

#### Exit menu system:

Press .

\* Optional network, SIM card, or subscription-dependent feature.

# Contents

---

<b>Menu Map</b> .....	<b>3</b>
<b>Safety and General Information</b> .....	<b>12</b>
<b>Getting Started</b> .....	<b>19</b>
What's in the Box? .....	19
About This Guide .....	19
Installing the SIM Card .....	20
Installing the Battery .....	20
Charging the Battery .....	21
Battery Use .....	22
Turning On Your Phone .....	23
Adjusting the In-Call Volume .....	24
Displaying Your Phone Number .....	25
Making a Call .....	25
Answering a Call .....	26
Muting/Unmuting a Call .....	26
<b>Learning to Use Your Phone</b> .....	<b>27</b>
Using the Internal Display .....	27
Using Menus .....	30
Entering Text .....	31
Using the External Display .....	38
Locking and Unlocking Your Phone .....	38
Setting and Changing Codes .....	40
If You Forget Codes .....	40
If You Enter the Wrong PIN or PIN2 Code 3 Times in a Row .....	40
<b>Setting Up Your Phone</b> .....	<b>42</b>
Adjusting the Backlight .....	42
Adjusting Display Contrast .....	42

Setting Time and Date. . . . .	42
Setting Local Time. . . . .	43
Setting Power-Off Time. . . . .	43
Setting Display Color. . . . .	43
Setting a Wallpaper Image . . . . .	44
Setting a Screen Saver Image . . . . .	44
Using Anykey Answer . . . . .	44
Using Flip Answer . . . . .	45
Setting an Ambient Light Sensor. . . . .	45
<b>Calling Features . . . . .</b>	<b>46</b>
Putting a Call on Hold . . . . .	46
Answering a New Call . . . . .	46
Making a New Call . . . . .	47
Making an Emergency Call . . . . .	47
Selecting a Phone Number to Use . . . . .	48
Redialing Automatically. . . . .	48
Checking Recent Calls . . . . .	48
Erasing Recent Calls. . . . .	48
Redialing Recent Calls . . . . .	49
Saving Recent Calls in Your Phonebook. . . . .	50
<b>Messages and Chat . . . . .</b>	<b>51</b>
Writing an SMS Message . . . . .	51
Sending an SMS Message . . . . .	52
Saving an SMS Message as a Draft . . . . .	53
Writing an MMS Message. . . . .	54
Sending an MMS Message. . . . .	58
Saving an MMS Message as a Draft. . . . .	60
Checking a Received SMS/MMS Message. . . . .	61
Checking a Sent or Unsent SMS/MMS Message . . . . .	61
Checking a Draft SMS/MMS Message . . . . .	62
Managing an SMS/MMS Message . . . . .	62
Editing an MMS Template . . . . .	64



Setting a Voice Mail Service Number . . . . .	64
Setting Message Topics . . . . .	65
Setting Service Commands . . . . .	65
Opening a Chatroom. . . . .	65
Setting SMS . . . . .	69
Setting MMS . . . . .	69
Setting Memory for Saving SMS Messages . . . . .	69
Checking SIM Card/Phone Memory for Saving SMS Messages. . . . .	69
Checking Phone Memory for Saving MMS Messages . .	69
<b>Setting Up Your Phonebook . . . . .</b>	<b>70</b>
Setting Memory for Saving Your Phonebook . . . . .	70
Checking SIM Card/Phone Memory for Saving Your Phonebook . . . . .	70
Creating a Phonebook Entry. . . . .	71
Phonebook Entry Options. . . . .	71
Sorting Phonebook Entries. . . . .	73
Looking Up Your Phonebook to Make a Call. . . . .	73
Setting 1-Touch Dialing Numbers . . . . .	73
Renaming a Caller Group. . . . .	76
Setting a Caller Group Ring Tone. . . . .	77
Setting a Default Image as a Caller Group Icon . . . . .	77
Setting a Multimedia Center Object as a Caller Group Icon . . . . .	79
Creating Your Personal Phonebook Entries . . . . .	80
Setting Fixed Dialing Numbers . . . . .	83
Setting Voice Dialing Numbers . . . . .	87
Sending a Phonebook Entry. . . . .	89
Sending a Phonebook Entry as an SMS Message. . . . .	91
Creating Your Name Card. . . . .	92
Checking Your Name Card . . . . .	92
Sending Your Name Card. . . . .	93

Erasing Your Name Card . . . . .	93
<b>Personalizing Your Phone . . . . .</b>	<b>94</b>
Setting a Language . . . . .	94
Replacing the Service Provider Name . . . . .	94
Setting Home Keys . . . . .	94
Restoring Factory Settings . . . . .	95
Creating an Option Shortcut . . . . .	95
Using an Option Shortcut . . . . .	95
Setting a Phone Profile . . . . .	96
<b>Getting More Out of Your Phone . . . . .</b>	<b>99</b>
Sending DTMF Tones . . . . .	99
Making a Conference Call . . . . .	99
Ending a Conference Call . . . . .	100
Diverting Calls . . . . .	100
Blocking Calls . . . . .	101
Setting Fax, Data, and Voice Calls . . . . .	101
Setting a Service Network . . . . .	101
Setting a Voice Call Connected Reminder . . . . .	102
Setting a Call Time Reminder . . . . .	102
Checking Call Time . . . . .	102
Clearing Call Time . . . . .	102
Setting a Call Cost Counter . . . . .	103
Clearing Call Cost . . . . .	103
Checking Call Cost . . . . .	103
Checking Call Credit . . . . .	103
Displaying In-Call Time/Cost . . . . .	104
Displaying Call Time/Cost after a Call . . . . .	104
Using STK Services . . . . .	104
<b>Personal Organizer Features . . . . .</b>	<b>105</b>
Turning On the Alarm Clock . . . . .	105
Turning Off the Alarm Clock . . . . .	106
Creating a Calendar Note . . . . .	106

Moving/Copying a Calendar Note to Another Date . . . .	108
Sending a Calendar Note as an SMS Message . . . . .	109
Making a Call from a Calendar Note . . . . .	110
Checking a Calendar Note . . . . .	110
Erasing a Calendar Note . . . . .	110
Creating an Account Book . . . . .	111
Checking Your Income . . . . .	112
Checking Your Expense . . . . .	112
Checking Your Balance . . . . .	112
Erasing Account Books . . . . .	112
Using the Calculator . . . . .	112
Using the Stopwatch . . . . .	114
Setting Voice-Activated Options . . . . .	116
Displaying World Time . . . . .	119
Turning On Your Phone's Voice Recorder . . . . .	120
Renaming a Voice Note . . . . .	121
Deleting a Voice Note . . . . .	122
Deleting All Voice Notes . . . . .	122
Sending a Voice Note . . . . .	123
Checking a Voice Note . . . . .	125
Sorting Voice Notes . . . . .	126
<b>Security . . . . .</b>	<b>127</b>
Locking and Unlocking the Keypads . . . . .	127
Setting a Closed User Group . . . . .	128
<b>News and Entertainment . . . . .</b>	<b>129</b>
Playing a Game . . . . .	129
Managing a Photo Folder . . . . .	129
Drawing a Picture . . . . .	129
Composing a Melody . . . . .	136
Displaying a Multimedia Object . . . . .	141
Deleting a Multimedia Object . . . . .	142
Sending a Multimedia Object . . . . .	142

Renaming a Multimedia Object . . . . .	145
Moving a Photo/Picture to Another Photo Folder . . . .	146
Checking a Multimedia Object. . . . .	147
Sorting Multimedia Objects . . . . .	147
Playing a Java Game . . . . .	148
Setting Java. . . . .	148
Turning On Your Phone Camera . . . . .	148
Customizing Your Phone Camera . . . . .	154
Turning On Your Phone's Video Recorder. . . . .	159
Renaming a Video. . . . .	161
Deleting a Video . . . . .	162
Sending a Video . . . . .	162
Checking a Video . . . . .	165
Sorting Videos. . . . .	166
Setting Network Connection . . . . .	166
Connecting to the Internet. . . . .	167
Setting a Bookmark. . . . .	169
Downloading Multimedia Objects . . . . .	169
Setting Web Page Display Style . . . . .	169
Allowing/Rejecting Cookies. . . . .	170
Clearing Cache Memory . . . . .	170
Reading Your Networking Provider's Messages . . . .	170
Reading Certificates . . . . .	170
<b>Troubleshooting . . . . .</b>	<b>171</b>
<b>Specific Absorption Rate Data . . . . .</b>	<b>177</b>
<b>Index. . . . .</b>	<b>179</b>

# ***Safety and General Information***

---

IMPORTANT INFORMATION ON SAFE AND EFFICIENT OPERATION.  
READ THIS INFORMATION BEFORE USING YOUR PHONE.

The information provided in this document supersedes the general safety information in user guides published prior to December 1, 2002.

## ***Exposure To Radio Frequency (RF) Energy***

Your phone contains a transmitter and a receiver. When it is ON, it receives and transmits RF energy. When you communicate with your phone, the system handling your call controls the power level at which your phone transmits.

Your Motorola phone is designed to comply with local regulatory requirements in your country concerning exposure of human beings to RF energy.

## ***Operational Precautions***

To assure optimal phone performance and make sure human exposure to RF energy is within the guidelines set forth in the relevant standards, always adhere to the following procedures.

### ***Internal Antenna Care***

Use only the supplied or Motorola-approved replacement antenna. Unauthorized antennas, modifications, or attachments could damage the phone.

Do NOT block the internal antenna (which is built-in at the top end of your phone) when the phone is IN USE. Blocking the internal antenna affects call quality and may cause the phone to operate at a higher power level than needed. In addition, use of unauthorized antennas may result in non-compliance with the local regulatory requirements in your country.

## ***Phone Operation***

When placing or receiving a phone call, hold your phone as you would a wireline telephone.

## ***Body-Worn Operation***

To maintain compliance with RF energy exposure guidelines, if you wear a phone on your body when transmitting, always place the phone in a Motorola-supplied or approved clip, holder, holster, case, or body harness for this phone, if available. Use of accessories not approved by Motorola may exceed RF energy exposure guidelines. If you do not use one of the body-worn accessories approved or supplied by Motorola, and are not using the phone held in the normal use position, ensure the phone and its antenna are at least 1 inch (2.5 centimeters) from your body when transmitting.

## ***Data Operation***

When using any data feature of the phone, with or without an accessory cable, position the phone and its antenna at least 1 inch (2.5 centimeters) from your body.

## ***Approved Accessories***

Use of accessories not approved by Motorola, including but not limited to batteries and antenna, may cause your phone to exceed RF energy exposure guidelines. For a list of approved Motorola accessories, visit our website at [www.Motorola.com](http://www.Motorola.com).

## ***RF Energy Interference/Compatibility***

**Note:** Nearly every electronic device is susceptible to RF energy interference from external sources if inadequately shielded, designed, or otherwise configured for RF energy compatibility. In some circumstances your phone may cause interference.

## ***Facilities***

Turn off your phone in any facility where posted notices instruct you to do so. These facilities may include hospitals or health care facilities that may be using equipment that is sensitive to external RF energy.

## ***Aircraft***

When instructed to do so, turn off your phone when on board an aircraft. Any use of a phone must be in accordance with applicable regulations per airline crew instructions.

## ***Medical Devices***

### **Pacemakers**

Pacemaker manufacturers recommend that a minimum separation of 6 inches (15 centimeters) be maintained between a handheld wireless phone and a pacemaker.

Persons with pacemakers should:

- ALWAYS keep the phone more than 6 inches (15 centimeters) from your pacemaker when the phone is turned ON.
- NOT carry the phone in the breast pocket.
- Use the ear opposite the pacemaker to minimize the potential for interference.
- Turn OFF the phone immediately if you have any reason to suspect that interference is taking place.

### **Hearing Aids**

Some digital wireless phones may interfere with some hearing aids. In the event of such interference, you may want to consult your hearing aid manufacturer to discuss alternatives.

### **Other Medical Devices**

If you use any other personal medical device, consult the manufacturer of your device to determine if it is adequately shielded from RF energy. Your physician may be able to assist you in obtaining this information.

## ***Use While Driving***

Check the laws and regulations on the use of phones in the area where you drive. Always obey them.

When using your phone while driving, please:

- Give full attention to driving and to the road.
- Use hands-free operation, if available.
- Pull off the road and park before making or answering a call if driving conditions so require.

Responsible driving best practices may be found in the “Wireless Phone Safety Tips” at the end of this manual and at the Motorola website:

[www.Motorola.com/callsmart](http://www.Motorola.com/callsmart).

## ***Operational Warnings***

### ***For Vehicles With an Air Bag***

Do not place a phone in the area over an air bag or in the air bag deployment area. Air bags inflate with great force. If a phone is placed in the air bag deployment area and the air bag inflates, the phone may be propelled with great force and cause serious injury to occupants of the vehicle.

### ***Potentially Explosive Atmospheres***

Turn off your phone prior to entering any area with a potentially explosive atmosphere, unless it is a phone type especially qualified for use in such areas and certified as “Intrinsically Safe.” Do not remove, install, or charge batteries in such areas. Sparks in a potentially explosive atmosphere can cause an explosion or fire resulting in bodily injury or even death.

**Note:** The areas with potentially explosive atmospheres referred to above include fueling areas such as below decks on boats, fuel or chemical transfer or storage facilities, areas where the air contains chemicals or particles, such as grain, dust, or metal powders. Areas with potentially explosive atmospheres are often but not always posted.

### ***Blasting Caps and Areas***





To avoid possible interference with blasting operations, turn OFF your phone when you are near electrical blasting caps, in a blasting area, or in areas posted “Turn off electronic devices.” Obey all signs and instructions.



## Batteries

Batteries can cause property damage and/or bodily injury such as burns if a conductive material such as jewelry, keys, or beaded chains touch exposed terminals. The conductive material may complete an electrical circuit (short circuit) and become quite hot. Exercise care in handling any charged battery, particularly when placing it inside a pocket, purse, or other container with metal objects. **Use only Motorola original batteries and chargers.**

Your battery or phone may contain symbols, defined as follows:

Symbol	Definition
	Important safety information will follow.
	Your battery or phone should not be disposed of in a fire.
	Your battery or phone may require recycling in accordance with local laws. Contact your local regulatory authorities for more information.
	Your battery or phone should not be thrown in the trash.
	Your phone contains an internal lithium ion battery.

## Seizures/Blackouts

Some people may be susceptible to epileptic seizures or blackouts when exposed to blinking lights, such as when watching television or playing video games. These seizures or blackouts may occur even if a person never had a previous seizure or blackout.

If you have experienced seizures or blackouts, or if you have a family history of such occurrences, please consult with your doctor before playing video games on your phone or enabling a blinking-lights feature on your phone. (The blinking-light feature is not available on all products.)

Parents should monitor their children's use of video game or other features that incorporate blinking lights on the phones. All persons should discontinue use and consult a doctor if any of the following symptoms occur: convulsion, eye or muscle twitching, loss of awareness, involuntary movements, or disorientation.

To limit the likelihood of such symptoms, please take the following safety precautions:

- Do not play or use a blinking-lights feature if you are tired or need sleep.
- Take a minimum of a 15-minute break hourly.
- Play in a room in which all lights are on.
- Play at the farthest distance possible from the screen.

## ***Repetitive Motion Injuries***

When you play games on your phone, you may experience occasional discomfort in your hands, arms, shoulders, neck, or other parts of your body. Follow these instructions to avoid problems such as tendonitis, carpal tunnel syndrome, or other musculoskeletal disorders:

- Take a minimum 15-minute break every hour of game playing.
- If your hands, wrists, or arms become tired or sore while playing, stop and rest for several hours before playing again.
- If you continue to have sore hands, wrists, or arms during or after play, stop playing and see a doctor.

## European Union Directives Conformance Statement



Hereby, Motorola declares that this product is in compliance with

- The essential requirements and other relevant provisions of Directive 1999/5/EC
- All other relevant EU Directives

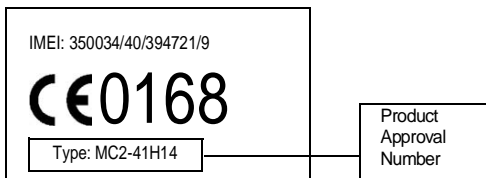

The above gives an example of a typical Product Approval Number.

You can view your product's Declaration of Conformity (DoC) to Directive 1999/5/EC (the R&TTE Directive) at [www.motorola.com/rtte](http://www.motorola.com/rtte) - to find your DoC, enter the product Approval Number from your product's label in the "Search" bar on the Web site.

# Getting Started

---



## What's in the Box?

Your digital wireless phone comes with a battery and charger. You can purchase other accessories to customize your phone for maximum performance and portability.

To purchase Motorola Original™ accessories, contact the Motorola Customer Call Center at 1-800-331-6456 in the United States or 1-800-461-4575 in Canada.

## About This Guide

### Optional Features



This label identifies an optional network, SIM card, or subscription-dependent feature that may not be offered by all service providers in all geographical areas. Contact your service provider for more information.

### Optional Accessories



This label identifies a feature that requires an optional Motorola Original™ accessory.

## Installing the SIM Card



Your Subscriber Identity Module (SIM) card contains your phone number, service details, and phonebook/message information.

**Caution:** Do not bend or scratch your SIM card. Avoid exposing your SIM card to static electricity, water, or dirt.

### Action

With your phone facing down, fit the SIM card into the slot, with the metal contacts facing down and the beveled corner pointed at the notch of the slot (as shown).

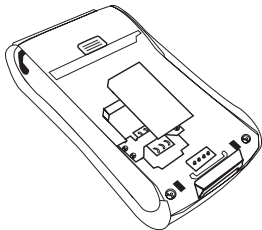

**Note:** Turn off your phone every time when you remove/insert the SIM card.

## Installing the Battery

You must install and charge the battery to use your phone.



Your phone is designed to use only Motorola Original batteries and accessories. We recommend that you store batteries in their protective cases when not in use.

### Action

- 1 Remove the battery from the plastic case.

## Action

- 2 Insert the battery with the 2 tabs wedged into the battery slots.

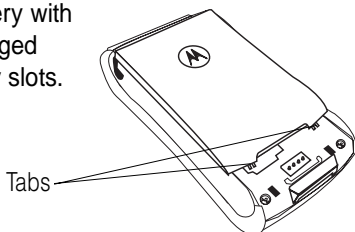

- 3 Latch the other end of battery door so that it clicks into place.

## Charging the Battery

New batteries are partially charged. Before using your phone, charge the battery as described below. Some batteries perform best after several full charge/discharge cycles.

## Action

- 1 With your phone facing up, plug in the travel charger, with the LED facing up.

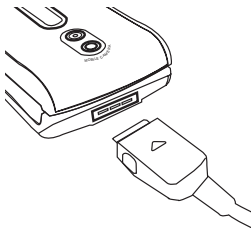

- 2 Plug the other end into the appropriate electrical outlet. The LED turns green when the battery is being charged.



## Action

- 3 When done charging, unplug the charger from the outlet, and press the release tabs to remove the charger from your phone.
- 
- 



When you charge the battery, the battery power level indicator in the external and internal displays shows how much of the charging process is complete. At least 1 segment of the battery power level indicator must be visible to ensure full phone functionality while charging.

When battery power is low, your phone will play the warning tones to warn you (see page 97). Charge the battery immediately.

If battery power runs out, your phone turns off.

## Battery Use

To maximize your battery's performance:

- Always use Motorola Original™ batteries and battery chargers. The phone warranty does not cover damage caused from using non-Motorola batteries and/or battery chargers.
- Charging begins when LED on connector is lit. Batteries stored for a long time may require 10-20 minutes to charge before the display is turned on.
- Maintain the battery at or near room temperature when charging.
- Do not expose batteries to temperatures below -10°C (14°F) or above 45°C (113°F). Always take your phone with you when you leave your vehicle.



- When you do not intend to use a battery for a while, store it uncharged in a cool, dark, dry place, such as a refrigerator.
- Over time, batteries gradually wear down and require longer charging times. This is normal. If you charge your battery regularly and notice a decrease in talk time or an increase in charging time, then it is probably time to buy a new battery.



The rechargeable batteries that power this phone must be disposed of properly and may need to be recycled. Contact your local recycling center for proper disposal methods. Never dispose of batteries in a fire because they may explode. Refer to your battery's label for battery type.

## Turning On Your Phone

### Action

- 1 Open your phone's flip.
- 2 Press and hold  to turn on the phone.
- 3 If necessary, enter your SIM card PIN code and press  to unlock the SIM card.

**Caution:** If you enter an incorrect PIN code 3 times in a row, your phone disables the SIM card and displays **SIM Blocked**.

- 4 If necessary, enter your 4-digit unlock code and press  to unlock the SIM card.



## Action

- 5 Enter the current time (*HH:MM*) and press **OK** to confirm.
- 6 Enter the current date (*YYYY/MM/DD*) and press **OK** to confirm.

**Tip:** To reset time and date, press  > **Settings** > **Clock** > **Set the time** and **Set the date**.

Your phone starts to connect to your service provider and then enters the idle display if connection is successfully established.

## Adjusting the In-Call Volume

	Press	To
1	up in-call volume key	increase earpiece volume during a call
	<b>or</b>	<b>or</b>
	down in-call volume key	decrease earpiece volume during a call
2	<b>OK</b>	save the setting

**Note:** Adjust the in-call volume from the idle display.



# Displaying Your Phone Number



You can display your phone number to people you call.





**Tip:** Scroll to **Preset** to use the default set by your service provider.





## Find the Feature

-  > **Settings**
- > **Call features**
- > **Show number > On**

## Making a Call

	Press	To
1	keypad keys	enter a phone number
		<b>Tip:</b> If you make a mistake, press <b>CLEAR</b>  to clear the last digit, or press and hold <b>CLEAR</b>  to clear all digits.
2		make the call
3		end the call

**Tip:** Press and hold  to insert a “P” (pause character) and then enter an extension following it.

**Tip:** Press and hold  to insert a “+” and then enter the country code, area code (omitting the starting 0), and phone number to make an international call.

**Note:** Dial phone numbers from the idle display.

## Answering a Call

When you receive a call, your phone rings and/or vibrates and displays an incoming call message.



	Press	To
1		answer the call
2		end the call

**Tip:** When **Flip answer** is active, open the phone to answer the call. (To activate, press > **Settings** > **Call features** > **Flip answer** > **ON**.)

**Tip:** When **Anykey answer** is active, press any of the keys except to answer the call. (To activate, press > **Settings** > **Call features** > **Anykey answer** > **ON**.)

**Note:** If the phone is locked, you must unlock it to answer calls.

## Muting/Unmuting a Call

When you are on a call:

	Press	To
1	<b>OPTIONS</b>	open the options menu
2		scroll to <b>Mute</b> or <b>Unmute</b>
3		mute or unmute the call

# Learning to Use Your Phone



---

## Using the Internal Display

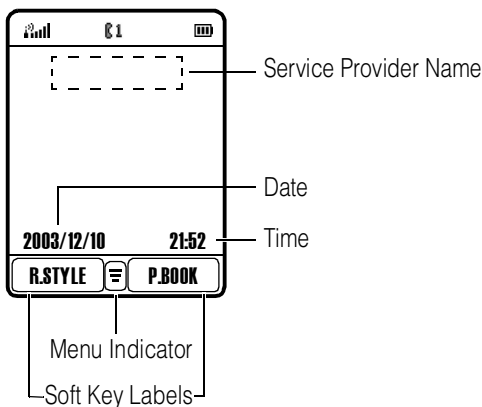
The *idle display* is the standard display when you are *not* on a call or using the menu.



The Menu indicator indicates that you can press the menu key  to display the main or options menu.



Labels at the bottom corners show the current soft key functions. Press the left soft key  or right soft key  to perform the function indicated by the left or right soft key label.











Press  from the idle display to select 4 menu features.

You can also decide which 4 menu features you would like to select by setting the home keys (see page 94).

At the top of the display are the following status indicators:

Icon	Name	Description
	<b>Signal Strength</b>	Indicates strength of signal being received. The more vertical bars, the better the reception (5 bars maximum).  Bars differ in color by the signal strength: <b>green &gt; orange &gt; red.</b>
	<b>Battery Power Level</b>	Indicates remaining battery power. The more bars, the more battery power available (3 bars maximum).  Bars differ in color by power level: <b>green &gt; orange &gt; red.</b> The icon flashes when battery power is near empty.



Icon	Name	Description
	<b>New SMS Message</b>	Indicates new unread SMS message(s). The icon flashes when the SMS memory is full. You must read new SMS messages to receive more SMS messages.
	<b>New Voicemail Message</b>	Indicates new unheard voicemail message(s).
	<b>New SMS/Voicemail Message</b>	Indicates new unread/unheard message(s).
	<b>New MMS Message</b>	Indicates new unread MMS message(s).
	<b>MMS Memory Full</b>	indicates the MMS memory is full. You must read new MMS messages to receive more MMS messages.
	<b>MMS Message Processing</b>	Indicates you are receiving/sending MMS message(s).
	<b>Ringer On</b>	Indicates ringer is turned on.
	<b>Vibrator On</b>	Indicates vibrator is turned on.
	<b>Ringer/Vibrator On</b>	Indicates ringer and vibrator are turned on.



Icon	Name	Description
	<b>Silent</b>	Indicates ringer is turned off.
	<b>GPRS Mode</b>	Indicates you are on the GPRS network.
	<b>Roaming</b>	Indicates you are on another network.
	<b>Chatroom Mode</b>	Indicates you open <b>Chatroom</b> to have an online chat.
	<b>Line 1/Line 2</b>	Indicates telephone line you are using.
	<b>Call Connected</b>	Indicates you are on a call.
	<b>Call Waiting</b>	Indicates a call is waiting to answer.
	<b>Call Muted</b>	Indicates a call is muted.

## Using Menus



From the idle display, press to display the main menu.

### Selecting a Menu Feature

To select a menu feature, starting from the idle display:

#### Find the Feature

 > Phonebook  
> Add



Use  to scroll, and the left/right soft keys to select the soft key functions listed in the bottom left and right corners of the display.  functions the same as the right soft key.

To select **Add** in a list, you may press .

**Note:** In this user's guide, "Find the Feature" always indicates the feature's position in the main menu.

## Entering Feature Information

Some features require you to enter information:

- Enter numbers or text with alphanumeric keys. A *flashing cursor* shows where text is entered.
- Press  to select an option.
- If you enter or edit information and do not want to save changes, press  to exit without saving.

## Entering Text

Multiple text entry modes make it easy for you to enter names, numbers, and messages on your phone.

## Setting Ready-to-Use Text Entry Modes



### Find the Feature

 > **Settings**  
> **Input mode**  
> **Preferred input mode**

Press	To
1 	scroll to the desired text entry mode





Press	To
2 ON 	select the mode
3 BACK 	change the settings
4 	save the settings

## Choosing a Text Entry Mode

Most text entry screens let you enter letters, numbers, and/or symbols as required.

Press  (or  > **Input mode**) from a text entry screen to select a text entry mode:

<b>TAP English</b>	Type letters, numbers, and symbols by pressing a key 1 or more times (see “Using TAP English” on page 33).
<b>iTAP English</b>	Let the phone predict each word as you type it (see page 34).
<b>123</b>	Enter numbers only.
<b>Symbol</b>	Enter symbols only.

**Note:** The text entry mode you select remains active until you change it by selecting another mode.

To select a text entry mode with ease:

### Action

Press  to insert a space.

Press and hold  to switch among **abc/Abc/ABC** text entry modes.

## Action

Press  to select **Symbol**.

Press and hold  to switch between **123**/the default text entry mode.

## Using TAP English

**TAP English** is the standard mode for entering text on your phone.

Press  > **Input mode** from any text entry screen and select **TAP English**.



	Press	To
1	keypad key 1 or more times	select a letter, number, or symbol
2	keypad keys	enter remaining characters
3	<input type="button" value="OK"/>	store text

## General Text Entry Rules

Press a key repeatedly to cycle through its characters.

- If you do not press a key for 2 seconds, the highlighted character is accepted, and the cursor moves to the next position.

## Setting Words to Complete Automatically



**Word completion** allows you to select a word from a list after you enter the 1st 3 characters.

### Find the Feature

 > **Settings**  
> **Input mode**  
> **Word completion** > **ON**

To enter text using **TAP English**:





	<b>Press</b>	<b>To</b>
1	keypad keys	enter the 1st 3 characters of a word
2	 up	open the possible words list
3		scroll to the desired word
4		select the word

## Using iTAP™ Software Predictive Text Entry Mode

**iTAP English** is a predictive text entry mode that lets you enter a word using 1 key press per letter.

Press  > **Input mode** from any text entry screen, and select **iTAP English**.

## Entering Words

Press	To
1 keypad key 1 time	enter the 1st letter of a word <b>Tip:</b> The letters associated with the key are shown at the bottom of the display.
2 keypad keys (1 per letter)	enter the rest of a word <b>Tip:</b> Alternative words and letter combinations are shown at the bottom of the display. The word choices update with each key press.
3 	highlight the word you want
4 	enter the word at flashing cursor location <b>Tip:</b> iTAP English automatically inserts a space after each word.

For example, to spell the word “art,”

press    . The display shows **art**.



## Entering Novel Words

You can coin words **iTAP English** does not recognize.

### Action

- 1 Press **CLEAR**  1 or more times to delete letters until a letter combination matches the start of the word.

---

- 2 Press  to highlight letter or letter combination.

---

- 3 Press **OK**  to select letter or letter combination.

---



- 4 Press  left to move cursor to the left and “lock” the selected word portion.

---

- 5 Continue to enter letters and highlight letter combinations to spell the word.

Your phone stores the unrecognized word and includes it in the list of alternative word choices. When memory space for unrecognized words is filled, your phone deletes the oldest words as it adds new words.



## Entering Punctuation

Press	To
 or 	enter punctuation

---

---

## Entering Numbers



	Press	To
1	keypad key 1 time	prepare to put <b>ITAP English</b> in <b>123</b> text entry mode
2		scroll to the number
3	keypad keys	enter numbers
4		enter the numbers at flashing cursor location

---

---

## Deleting Letters and Words

With the cursor to the right of the text you want to delete:

Action
Press <b>CLEAR</b>  to delete 1 letter at a time.
Press and hold <b>CLEAR</b>  to delete the entire line.

---

---



## Using the External Display

The external display shows the phone status, including network signal and battery power level. Press the in-call volume key to show/hide time and date.

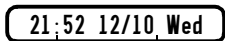

Time

Date



When you receive an incoming call, the external display may show the caller's number and name.

**Note:** To see a caller's name in the external display, the caller's number must match an entry in your phonebook. To create a phonebook entry, see page 71.

## Locking and Unlocking Your Phone

You can lock your phone manually or set the phone to lock automatically whenever you turn it off. To use a locked phone, you must enter the unlock code. A locked phone still rings and/or vibrates for incoming calls/messages, *but you must unlock it to answer/read.*

You can make emergency calls on your phone even when it is locked.

**Tip:** Contact your service provider for the phone codes.

## Locking Your Phone Manually

### Find the Feature

-  > **Settings**
- > **Security**
- > **Code status** > **Phone lock**
- > **Lock now**

	<b>Press</b>	<b>To</b>
1	keypad keys	enter your unlock code
2		lock the phone

## Unlocking Your Phone

	<b>Press</b>	<b>To</b>
1	keypad keys	enter your unlock code
2		unlock the phone

## Setting Your Phone to Lock Automatically

To lock your phone every time you turn it off:

### Find the Feature

-  > **Settings**
- > **Security**
- > **Code status** > **Phone lock**
- > **Automatic lock** > **ON**





# Setting and Changing Codes

You can set and change the following codes that block other people from using your phone and data in it:

<b>PIN code</b>	Lock your SIM card when you turn off your phone.
<b>PIN2</b>	Lock certain subscription-dependent features every time you use them.
<b>Phone code</b>	Lock your phone when you turn it off.
<b>SIM lock</b>	Lock your phone when you insert an unidentified SIM card.

**Tip:** Contact your service provider for those codes.

To set codes:

## Find the Feature

 > **Settings**  
> **Security** > **Code status**

To change codes:

## Find the Feature

 > **Settings**  
> **Security** > **Change code**

## If You Forget Codes

If you forget your codes, contact your service provider.

## If You Enter the Wrong PIN or PIN2 Code 3 Times in a Row

If you enter a wrong PIN or PIN2 code 3 times in a row, your phone prompts you to enter the PUK or PUK2 code to

unlock your SIM card. For the PUK and PUK2 codes, contact your service provider.



# Setting Up Your Phone

## Adjusting the Backlight

You can set the amount of time that the display and keypad backlights remain on, or turn off backlights to extend battery life.

### Find the Feature



 > Settings  
> Backlight

## Adjusting Display Contrast

### Find the Feature

 > Settings  
> Adjust contrast



	Press	To
1	 right/left	scroll to the desired contrast
2		select the contrast

## Setting Time and Date

To see time and date in the idle displays, set time and date first:

### Find the Feature

 > Settings  
> Clock  
> Set the time/Set the date

Then set the date format:

### Find the Feature

 > Settings  
> Clock > Date format

To see time and date in the internal idle display:

### Find the Feature

 > Settings  
> Clock > Show clock > ON

To see time and date in the external idle display:

Press	To
the in-call volume key	display time and date in the external display

## Setting Local Time

### Find the Feature

 > Settings  
> Clock > Local time zone

## Setting Power-Off Time

### Find the Feature

 > Settings  
> Auto power off > On

Tip: Press  right/left to select a Repeat type.

## Setting Display Color

### Find the Feature

 > Settings  
> Display > Color scheme



## Setting a Wallpaper Image

You can set a picture or animation as a wallpaper (background) image in your phone's internal display.

**Note:** When you set an animation as a wallpaper image, only the 1st frame of the animation displays.

### Find the Feature

 > Settings  
> Display  
> Wallpaper

## Setting a Screen Saver Image

You can set a picture or animation as a screen saver image in your phone's internal display. The image displays when no activity occurs in 1 minute (the default, but it depends on regions).

An animation repeats for 3 minutes; then the last frame of the animation displays.

### Find the Feature

 > Settings  
> Display  
> Screen saver

**Tip:** Scroll to **Off** or **Power saving** to turn off **Screen saver** to extend battery life.

## Using Anykey Answer

Press any keys except  to answer calls.

### Find the Feature

 > Settings  
> Call features  
> Anykey answer > ON

## ***Using Flip Answer***

**Find the Feature**

-  > Settings
- > Call features
- > Flip answer > ON

## ***Setting an Ambient Light Sensor***

**Find the Feature**



-  > Settings
- > Light sensor



# Calling Features

## Putting a Call on Hold

When you are on a call, you can put the call on hold.

Press	To
1 <b>OPTIONS</b> 	open the options menu
2 	scroll to <b>Hold</b> <b>Tip:</b> Scroll to <b>Activate</b> to answer the call on hold.
3 	put the call on hold

## Answering a New Call

When you are on a call, you can answer a new incoming call.





To turn on **Call waiting**:



**Find the Feature**

 > **Settings**  
> **Call features** > **Call waiting**  
> **On**

To answer a new incoming call:



Press	To
1 	put the call on hold and answer the new call

Press	To
2 	end the new call and continue with the call

**Tip:** If you have an active call, a held call, and a new incoming call, you must end the active or held call to answer the new incoming call. Depending on your service provider, you can also transfer an incoming call to another phone. (To activate, press **OPTIONS**  > **Deflection** > enter the desired phone number > press .)

## Making a New Call

When you are on a call, you can make a new outgoing call.

Press	To
1 <b>OPTIONS</b> 	open the options menu
2 	select <b>Dial new call</b>
3 keypad keys	enter the phone number
4 	dial the phone number

## Making an Emergency Call

With or without your SIM card installed, you can make an emergency call to the Emergency phone number your service provider gave you.

Press	To
1 keypad keys	enter the phone number





**Press**

**To**

2



dial the phone number

## Selecting a Phone Number to Use



You can select a phone number (line) to make and receive calls.

**Find the Feature**



> **Settings**

> **Call features** > **Phone lines**

## Redialing Automatically

**Find the Feature**



> **Settings**

> **Call features**

> **Auto redial** > **ON**

## Checking Recent Calls

**Find the Feature**



> **Recent calls**

> **Missed calls/Received calls/  
Dialed calls**

**Tip:** If the phone number of the selected recent call displays, press  to dial.





## Erasing Recent Calls

You can erase 1 or all of the recent calls.

## Erasing a Recent Call

### Find the Feature

-  > Recent calls  
> Missed calls/Received calls/  
Dialed calls

Press	To
1 	scroll to a recent call you want to erase
2 	open the options menu
3 	scroll to <b>Erase</b>
4 	erase the selected recent call

## Erasing All Recent Calls

### Find the Feature

-  > Recent calls  
> Erase all

## Redialing Recent Calls



You can redial recent calls if the phone number displays.

### Find the Feature

-  > Recent calls  
> Missed calls/Received calls/  
Dialed calls

Press	To
1 	scroll to the desired recent call









Press	To
2 	open the options menu
3 	scroll to <b>Call</b>
4 	make the phone call

## ***Saving Recent Calls in Your Phonebook***

You can save recent calls as phonebook entries if the phone number displays.

### **Find the Feature**

 > **Recent calls**  
> **Missed calls/Received calls/Dialed calls**

Press	To
1 	scroll to the desired recent call
2 	open the options menu
3 	scroll to <b>Save</b>
4 	select <b>Save</b>
5 keypad keys	enter a name
6 	save the entry in your phonebook

# Messages and Chat

You can write, send, and receive messages, either by Short Messaging Service (SMS) or by Multimedia Messaging Service (MMS). You can also open a chatroom to have an online chat.







## Writing an SMS Message

You can insert quick notes, phonebook entries (numbers or names), image objects (pictures or animations), and sound objects (sounds or melodies) when writing an SMS message.

### Find the Feature

-  > **Msg. center**
- > **Text messages**
- > **Write message**

	<b>Press</b>	<b>To</b>
1	keypad keys	enter text
2		open the options menu
3		scroll to the desired option
4		select the option
5		scroll to the desired sub-option, if necessary
6		select the sub-option, if necessary



	Press	To
7		scroll to the desired object you want to insert to your SMS message
8		select the object
		<b>Tip:</b> Repeat steps 7-8, if necessary.

## ***Sending an SMS Message***

After you finish writing an SMS message:

	Press	To
1	<b>SEND</b>	select <b>SEND</b>
2	<b>P.BOOK</b>	open your phonebook
3		scroll to the desired entry
4		select the entry
5		scroll to the desired phone number
6		select the phone number
7	<b>BACK</b>	return to the previous menu
		<b>Tip:</b> Repeat steps 3-7 to add other recipients.
8	<b>BACK</b>	return to the previous menu
9		open the options menu



	Press	To
10		scroll to <b>Send</b>
11		send your SMS message



## ***Saving an SMS Message as a Draft***

After you finish writing an SMS message:

	Press	To
1		open the options menu
2		scroll to <b>Save to drafts</b>
3		select <b>Save to drafts</b>
4	<b>P.BOOK</b>	select a recipient
5		scroll to the desired entry
6		select the entry
7		scroll to the desired phone number
8		select the phone number
9	<b>SAVE</b>	save your SMS message in <b>Msg. center &gt; Text messages &gt; Drafts</b>

## Writing an MMS Message









An MMS message may consist of several page sets. A page set includes an image object  (photo/picture/animation/video), a sound object  (melody/voice note), and/or text objects (quick note/phone number).

**Note:** You can insert only 1 image or sound object to a page set. To insert more objects, press **YES**  when displays ... existed, add to next page?.

### Find the Feature

-  > **Msg. center**
- > **Multimedia msgs.**
- > **Write message**

	Press	To
1	keypad keys	enter text
2		open the options menu
3		scroll to <b>Insert object</b>
4		select <b>Insert object</b>
5		scroll to the desired option
6		select the option
7		scroll to the desired sub-option, if necessary



	Press	To
8		select the sub-option, if necessary  <b>Tip:</b> Repeat steps 7-8, if necessary.
9		scroll to the desired object you want to insert to your MMS message
10		select the object  <b>Tip:</b> Repeat steps 9-10, if necessary.
11		insert the selected object

## Going to a Page Set

In any page set:





	Press	To
1		open the options menu
2		scroll to <b>Go to...</b>
3		select <b>Go to...</b>
4		scroll to the desired page set
5		go to the selected page set



## Displaying an Object in a Page Set







In the desired page set:



	Press	To
1		open the options menu
2		scroll to <b>View object</b>
3		select <b>View object</b>
4		scroll to the desired object
5		display the selected object

## Deleting an Object from a Page Set



In the desired page set:

	Press	To
1		open the options menu
2		scroll to <b>Remove object</b>
3		select <b>Remove object</b>
4		scroll to the desired object
5		select the object
6		delete the selected object



## Deleting a Page Set

You can delete a page set, including all objects and a page. If there is only 1 page set, you can delete all objects, not a page from it.

In the desired page set:

	Press	To
1		open the options menu
2		scroll to <b>Delete page</b>
3		delete the selected page set, including all objects and a page

In the only 1 page set:

	Press	To
1		open the options menu
2		scroll to <b>Delete page</b>
3		delete all objects, not a page from the only 1 page set

## Previewing an MMS Message

In any page set:

	Press	To
1		open the options menu





	Press	To
2		scroll to <b>Preview</b>
3		select <b>Preview</b>
4		preview the next/previous page set





## ***Sending an MMS Message***

**Note:** To send/receive MMS messages, you must apply for MMS from your service provider(s) and then select a service provider to use MMS, which are offered via GPRS your selected service provider provides. To select a service provider, press > **Browser** > **Profiles**, or press > **Msg. center** > **Settings** > **Multimedia msgs.** > **Connection settings**.







To send by a phone number:

	Press	To
1	<b>SEND</b>	select <b>SEND</b>
2	<b>P.BOOK</b>	open your phonebook
3		scroll to the desired entry
4		select the entry
5		scroll to the desired phone number
6		select the phone number



Press	To
7 <b>BACK</b> 	return to the previous menu <b>Tip:</b> Repeat steps 3-7 to add other recipients.
8 <b>BACK</b> 	return to the previous menu
9 	open the options menu
10 	scroll to <b>Send</b>
11 	send your MMS message

To send by an e-mail address:







Press	To
1 <b>SEND</b> 	select <b>SEND</b>
2 	open the options menu
3 	scroll to <b>New e-mail address</b>
4 	select <b>New e-mail address</b>
5 keypad keys	enter an e-mail address
6 	add the e-mail address to the <b>Recipients</b> box <b>Tip:</b> Repeat steps 2-6 to add other recipients.
7 	open the options menu
8 	scroll to <b>Send</b>



Press	To
9 	send your MMS message

## ***Saving an MMS Message as a Draft***

After you finish writing an MMS message:



Press	To
1 	open the options menu
2 	scroll to <b>Set title</b>
3 	select <b>Set title</b>
4 keypad keys	enter a name
5 	save the name
6 	open the options menu
7 	scroll to <b>Save to drafts</b>
8 	save your MMS message in <b>Msg. center &gt; Multimedia msgs. &gt; Drafts</b>

# Checking a Received SMS/MMS Message

## Find the Feature

 > **Msg. center**  
> **Text messages/**  
**Multimedia msgs. > Inbox**



Press	To
1 	scroll to the desired message
2 	check the selected message

# Checking a Sent or Unsent SMS/MMS Message

## Find the Feature

 > **Msg. center**  
> **Text messages/**  
**Multimedia msgs. > Outbox**



This icon indicates a sent SMS message.



This icon indicates an unsent SMS message.



This icon indicates a sent MMS message.



This icon indicates an unsent MMS message.

Press	To
1 	scroll to the desired message



Press	To
2 	check the selected message

## Checking a Draft SMS/MMS Message

### Find the Feature



 > **Msg. center**  
> **Text messages/**  
**Multimedia msgs.** > **Drafts**



This icon indicates a draft SMS message.



This icon indicates a draft MMS message.

Press	To
1 	scroll to the desired message
2 	check the selected message

## Managing an SMS/MMS Message

You can perform these functions on a SMS/MMS message stored in your **Inbox**, **Outbox**, or **Drafts** folder:





- **Erase**
- **Send**
- **Reply**
- **Forward**



- **Edit**
- **View** (to display objects)/**Save object/Object info.** (to check objects)
- **Use address** (to dial or save a phone number, to connect to a URL, or to save a URL as a bookmark)
- **Detail info.** (to check messages)
- **Callback** (to call to senders)
- **Open chatroom** (to chat with senders)

### Find the Feature

-  > **Msg. center**
- > **Text messages/  
Multimedia msgs.**
- > **Inbox/Outbox/Drafts**

	Press	To
1		scroll to the desired message
2		select the message
3	<b>OPTIONS</b> 	open the options menu
	or	
		



## Editing an MMS Template

You can edit an MMS template and save it either in **Msg. center > Multimedia msgs. > Drafts**, or in **Msg. center > Multimedia msgs. > MMS template**.



### Find the Feature

 > **Msg. center**  
> **Multimedia msgs.**  
> **MMS template**

## Setting a Voice Mail Service Number

Your service provider may set a voice mail service number before you receive your phone. If not, refer to the following procedures.

### Find the Feature

 > **Msg. center**  
> **Voice mailbox**

Press	To
1 keypad keys	enter the voice mail service number your service provider provided
2 	save the setting

## Setting Message Topics

You can set topic messages you want to receive from your service provider, such as traffic reports and today's news.

### Find the Feature

 > **Msg. center**  
> **Cell broadcast**

## Setting Service Commands

You can set service commands you want your service provider to operate.

### Find the Feature

 > **Msg. center**  
> **Service command**

Press	To
1 keypad keys	enter the service command you want your service provider to operate
2 	send the service command to your service provider

## Opening a Chatroom



You can open up to 4 chatrooms and have an online chat.

### Find the Feature

 > **Chatroom**





	Press	To
1		scroll to any chatroom
2	<b>NAMES</b>	select from your phonebook a person you want to have a chat with
3		scroll to the desired entry
4		select the entry
5		scroll to the desired phone number
6		select the phone number
7		save the setting
8	keypad keys	enter your nickname
9		save the setting
10	keypad keys	enter your message
11	<b>SEND</b>	send your message

## ***Adding a Quick Note to Your Chatroom Message***

	Press	To
1		open the options menu
2		scroll to <b>Insert quick note</b>



	Press	To
3		select <b>Insert quick note</b>
4		scroll to the desired quick note
5		add the selected quick note to your message

## ***Adding a Smiley Symbol to Your Chatroom Message***

	Press	To
1		open the options menu
2		scroll to <b>Insert smiley</b>
3		select <b>Insert smiley</b>
4		scroll to the desired smiley symbol
5		add the selected smiley symbol to your message





## ***Editing Your Nickname***

	Press	To
1		open the options menu
2		scroll to <b>Nickname</b>
3		select <b>Nickname</b>





Press	To
4 keypad keys	edit your nickname
5 	save the setting

## *Editing a Chatroom Phone Number*

Press	To
1 	open the options menu
2 	scroll to <b>Chat Numbers</b>
3 	select <b>Chat Numbers</b>
4 keypad keys	edit a chatroom phone number
5 	save the setting

## *Checking Old Chatroom Messages*

Press	To
1 	open the options menu
2 	scroll to <b>View history</b>
3 	check old messages

## Setting SMS

Find the Feature

 > Msg. center  
> Settings > Text messages

## Setting MMS

Find the Feature

 > Msg. center  
> Settings > Multimedia msgs.

## Setting Memory for Saving SMS Messages

Find the Feature

 > Msg. center  
> Settings > Memory in use  
> Select SMS memory

## Checking SIM Card/Phone Memory for Saving SMS Messages

Find the Feature

 > Msg. center  
> Settings > Memory in use  
> SMS status

## Checking Phone Memory for Saving MMS Messages

Find the Feature

 > Msg. center  
> Settings > Memory in use  
> MMS status



# Setting Up Your Phonebook

---

## Setting Memory for Saving Your Phonebook



Find the Feature

 > Phonebook  
> Option > Memory

## Checking SIM Card/Phone Memory for Saving Your Phonebook

Find the Feature

 > Phonebook  
> Option > Memory status



Number ( $X$ ) of phone numbers in SIM card memory. You can store up to 100 phone numbers in SIM card memory.

**Note:** The capacity of SIM card memory depends on your service provider settings.



Number ( $X$ ) of phone numbers in phone memory. You can store up to 300 phone numbers in phone memory.



**X/100**

Number (X) of notes in phone memory. You can store up to 100 notes in phone memory.

## Creating a Phonebook Entry

### Find the Feature

 > Phonebook  
> Add

Press	To
1 keypad keys	enter a name
2 	save the name
3 keypad keys	enter a phone number
4 	save the phone number



## Phonebook Entry Options

You can perform several functions on a phonebook entry:

Option	Description
<b>Edit</b>	edit a phone number/name
<b>Add number*</b>	add phone number(s) (up to 4)
<b>Set as default*</b>	set a phone number to be called by default
<b>Change type</b>	change a phone number type
<b>Add text*</b>	add note(s)
<b>Change group</b>	set a caller group









Option	Description
<b>Add picture*</b>	create an incoming call display icon
<b>Remove picture*</b>	remove an incoming call display icon
<b>Copy</b>	copy/move a phonebook entry saved on SIM card or phone memory to phone or SIM card memory
<b>Erase</b>	remove phonebook entry(ies) or note(s)

\* The option is available only for the phone number/name saved on phone memory.

### Find the Feature

 > **Phonebook**  
> **Search**

Press	To
1 keypad keys	enter the 1st letter(s) of a name
2 	open your phonebook
3 	scroll to the desired entry
4 	select the entry
5 	scroll to the name or the desired phone number/note
6 	open the options menu

# Sorting Phonebook Entries

Find the Feature

 > Phonebook  
> Option > Sort by

## Looking Up Your Phonebook to Make a Call



You can look up your phonebook and then make a phone call from the idle display.

To turn on **Dialing number lookup** 1st:



Find the Feature

 > Phonebook  
> Option  
> Dialing number lookup > ON

To dial from the idle display:

	Press	To
1	keypad keys	enter the 1st letter(s) of a name
2		scroll to the desired entry
3		make a phone call

## Setting 1-Touch Dialing Numbers

You can press and hold a key from  to  to make the phone call from the idle display.



To turn on **Speed dialing** 1st:

### Find the Feature





-  > **Settings**
- > **Call features**
- > **Speed dialing** > **ON**

To set 1-touch dialing numbers:

### Find the Feature

-  > **Phonebook**
- > **Speed dial**







	<b>Press</b>	<b>To</b>
1		scroll to the desired speed dial key
2		open your phonebook
3		scroll to the desired entry
4		assign the key for the selected phone number

## Checking 1-Touch Dialing Numbers

### Find the Feature

-  > **Phonebook**
- > **Speed dial**







	<b>Press</b>	<b>To</b>
1		scroll to the desired name

Press	To
2 	open the options menu
or	or
VIEW 	check the selected phonebook entry
3 	check the selected phonebook entry

## Changing 1-Touch Dialing Numbers

### Find the Feature

 > Phonebook  
> Speed dial

Press	To
1 	scroll to the desired name
2 	open the options menu
3 	scroll to <b>Change</b>
4 	select <b>Change</b>
5 	scroll to the desired phonebook entry
6 	assign the speed dial key for the selected phone number

## Erasing 1-Touch Dialing Numbers

### Find the Feature

 > Phonebook  
> Speed dial





	Press	To
1		scroll to the desired name
2		open the options menu
3		scroll to <b>Erase</b>
4		erase the speed dial key from the selected phone number

## Renaming a Caller Group

### Find the Feature

> Phonebook  
> Caller group







	Press	To
1		scroll to the desired caller group
2		select the caller group
3		select <b>Rename</b>
4	keypad keys	enter a new name
5		save the new name

# Setting a Caller Group Ring Tone

You can select a ring tone for a caller group to use. The ring tone plays when 1 of the caller group calls you.

## Find the Feature

 > Phonebook  
> Caller group

	Press	To
1		scroll to the desired caller group
2		select the caller group
3		scroll to <b>Ring tone</b>
4		select <b>Ring tone</b>
5		scroll to the desired ring tone
6		select the ring tone

# Setting a Default Image as a Caller Group Icon





You can select a default image for a caller group to use. The image displays when 1 of the caller group calls you.

## Find the Feature





 > Phonebook  
> Caller group



To turn on **Graphic 1st**:

	<b>Press</b>	<b>To</b>
1		scroll to the desired caller group
2		select the caller group
3		scroll to <b>Graphic</b>
4		select <b>Graphic</b>
5	<b>ON</b> 	turn on <b>Graphic</b>

To set a caller group icon:

	<b>Press</b>	<b>To</b>
1		scroll to <b>View</b>
2		select <b>View</b>
3		scroll to the desired icon
4		select the icon





# Setting a Multimedia Center Object as a Caller Group Icon

You can also set a photo, picture, or an animation in **Media center** as a caller group icon.



## Find the Feature

 > **Phonebook**  
> **Caller group**

To turn on **Graphic** 1st:

	Press	To
1		scroll to the desired caller group
2		select the caller group
3		scroll to <b>Graphic</b>
4		select <b>Graphic</b>
5	<b>ON</b> 	turn on <b>Graphic</b>

To set a caller group icon:

	Press	To
1		scroll to <b>View</b>
2		select <b>View</b>
3		scroll to <b>Media center</b>







	Press	To
4		select <b>Media center</b>
5		scroll to the desired option
6		select the option
7		scroll to the desired folder, if necessary
8		select the folder, if necessary
9		scroll to the desired object
10		select the object
11		set the selected object as the caller group icon

## Creating Your Personal Phonebook Entries

### Find the Feature





> **Phonebook**  
> **Personal number**

To create the 1st phonebook entry of your own:

	Press	To
1	keypad keys	enter your name
2		save your name
3	keypad keys	enter your phone number

Press	To
4 	save your phone number

To add other phonebook entries of your own:

Press	To
1 	open the options menu
2 	scroll to <b>Add</b>
3 	select <b>Add</b>
4 keypad keys	enter your name
5 	save your name
6 keypad keys	enter your phone number
7 	save your phone number

## *Editing Your Personal Phonebook Entries*





### Find the Feature

 > **Phonebook**  
> **Personal number**

Press	To
1 	scroll to the desired entry









	Press	To
2	EDIT 	prepare to edit the selected entry
	or	
	 > 	
3	keypad keys	enter your name
4		save your name
5	keypad keys	enter your phone number
6		save your phone number

## Erasing Your Personal Phonebook Entries

### Find the Feature

 > **Phonebook**  
> **Personal number**

	Press	To
1		scroll to the desired entry
2		open the options menu
3		scroll to <b>Erase</b>
4		erase the selected entry

# Setting Fixed Dialing Numbers





You can restrict outgoing calls to phone numbers that begin with the same digit(s) you set on the fixed dialing list.

**Tip:** Enter the PIN2 code to set **Fixed dial number**.





## Find the Feature

 > **Phonebook**  
> **Fixed dial number**

To turn on **Fixed dial number** 1st:

	Press	To
1	ON 	turn on <b>Enable fixed dialing</b>
2	keypad keys	enter the PIN2 code
3		turn on <b>Fixed dial number</b>

To set the 1st fixed dialing number:

	Press	To
1		scroll to <b>Number list</b>
2		select <b>Number list</b>
3		select <b>Add</b>
4	keypad keys	enter the PIN2 code
5		confirm the code
6	keypad keys	enter a name





Press	To
7	save the name
8 keypad keys	enter a phone number
9	save the phone number

To add other fixed dialing numbers:

### Find the Feature







> **Phonebook**  
 > **Fixed dial number**  
 > **Number list**

Press	To
1	scroll to any fixed dialing entry
2	open the options menu
3	scroll to <b>Add</b>
4	select <b>Add</b>
5 keypad keys	enter the PIN2 code
6	confirm the code
7 keypad keys	enter a name
8	save the name
9 keypad keys	enter a phone number
10	save the phone number

## Changing Fixed Dialing Numbers

### Find the Feature

-  > Phonebook
- > Fixed dial number
- > Number list

	Press	To
1		scroll to the desired fixed dialing entry
2	EDIT 	select EDIT/Edit
	or	
	 > 	
3	keypad keys	enter the PIN2 code
4		confirm the code
5	keypad keys	enter a name
6		save the name
7	keypad keys	enter a phone number
8		save the phone number







## Erasing a Fixed Dialing Number

### Find the Feature

-  > Phonebook
- > Fixed dial number
- > Number list











Press	To
1 	scroll to the desired fixed dialing entry
2 	open the options menu
3 	scroll to <b>Erase</b>
4 	select <b>Erase</b>
5 keypad keys	enter the PIN2 code
6 	confirm the code
7 	erase the selected fixed dialing entry

## Erasing All Fixed Dialing Numbers

### Find the Feature

-  > Phonebook
- > Fixed dial number
- > Number list

Press	To
1 	scroll to any fixed dialing entry
2 	open the options menu
3 	scroll to <b>Erase all</b>
4 	select <b>Erase all</b>
5 keypad keys	enter the PIN2 code
6 	confirm the code

Press	To
7 	erase all fixed dialing entries







## Setting Voice Dialing Numbers

To dial by voice activation, press and hold the voice activation key from the idle display until **Please say name or command** displays; then say a name into the microphone. You can create up to 10 voice dialing numbers.

**Note:** This option is available only for phone numbers saved on phone memory.

### Find the Feature

 > Phonebook  
> Search

Press	To
1 keypad keys	enter the 1st letter(s) of a name
2 	open your phonebook
3 	scroll to the desired entry
4 	select the entry
5 	scroll to the desired phone number
6 	open the options menu
7 	scroll to <b>Add voice tag</b>
8 	select <b>Add voice tag</b>











Press	To
9 	say a name into the microphone
	<b>Tip:</b> Repeat this step until <b>Voice tag saved</b> displays.

## Playing Voice Dialing Number Commands

### Find the Feature



 > Phonebook  
> Voice tags



Press	To
1 	scroll to the desired entry
2 	play the selected entry command
or	
 > 	

## Changing Voice Dialing Number Commands

### Find the Feature

 > Phonebook  
> Voice tags

Press	To
1 	scroll to the desired entry
2 	open the options menu



Press	To
3 	scroll to <b>Change</b>
4 	select <b>Change</b>
5 	say a name into the microphone

**Tip:** Repeat this step until **Voice tag saved** displays.

## Erasing Voice Dialing Numbers

### Find the Feature

 > Phonebook  
> Voice tags

Press	To
1 	scroll to the desired entry
2 	open the options menu
3 	scroll to <b>Erase</b>
4 	erase the selected voice dialing entry













## Sending a Phonebook Entry

### Find the Feature

 > Phonebook  
> Search





	Press	To
1	keypad keys	enter the 1st letter(s) of a name
2		open your phonebook
3		scroll to the desired entry
4		select the entry
5		open the options menu
6		scroll to <b>Send business card</b>
7		select <b>Send business card</b>
8		select <b>Send as SMS</b>
9	<b>NAMES</b> 	open your phonebook
10		scroll to the desired recipient
11		select the recipient
12		scroll to the desired phone number
13		select the phone number
14	 down	add other recipient(s), if necessary







**Tip:** Repeat steps 9-14 to add other recipient(s).

Press	To
15 SEND 	send the selected phonebook entry

## ***Sending a Phonebook Entry as an SMS Message***

### **Find the Feature**

 > Phonebook  
> Search

Press	To
1 keypad keys	enter the 1st letter(s) of a name
2 	open your phonebook
3 	scroll to the desired entry
4 	select the entry
5 	open the options menu
6 	scroll to <b>Send message/Send business card</b>
7 	select <b>Send message/Send business card</b>

**Tip:** If you select **Send message**, see page 51 to write and send an SMS message. If you select **Send business card**, continue the following steps.



**Press****To**

8

scroll to **Send as text**

9

select **Send as text**

**Tip:** See page 51 to write and send an SMS message.

## Creating Your Name Card

You can create your personal profile.

**Find the Feature**> **Phonebook**> **My Own Card > Edit****Press****To**

1



scroll to any blank box

2

keypad keys

enter the suitable words

3



save the settings

## Checking Your Name Card





**Find the Feature**> **Phonebook**> **My Own Card > View**

# ***Sending Your Name Card***

To select information on your name card you want to send:

## **Find the Feature**

-  > Phonebook
- > My Own Card
- > Send my own > Info. setting

	<b>Press</b>	<b>To</b>
1		scroll to the desired information
2	<b>ON</b> 	send the selected information
3	<b>BACK</b> 	return to the previous menu
4		save the settings

To send your name card:

## **Find the Feature**

-  > Phonebook
- > My Own Card
- > Send my own
- > Send as SMS/Send as text

To **Send as SMS**, see “Sending a Phonebook Entry” on page 89.

To **Send as text**, see “Sending a Phonebook Entry as an SMS Message” on page 91.

# ***Erasing Your Name Card***

## **Find the Feature**

-  > Phonebook
- > My Own Card > Erase



# Personalizing Your Phone

---

## Setting a Language

Find the Feature

 > Settings  
> Language



## Replacing the Service Provider Name

You can replace the service provider name in the idle display with the standby logo you downloaded.

Find the Feature

 > Settings  
> Display > Standby logo > ON

## Setting Home Keys

You can set the navigation key , right soft key , and left soft key  as shortcuts to menu features.

Find the Feature

 > Settings  
> Home keys

# Restoring Factory Settings

## Find the Feature



 > Settings  
> Restore factory settings

**Note:** Enter your phone's unlock code to restore factory settings.

# Creating an Option Shortcut

## Find the Feature



 > Quick access  
> Edit

	Press	To
1		scroll to the desired option
2		select the option
3	keypad keys	enter a number between 1 and 9
4	SAVE 	save the setting

# Using an Option Shortcut

## Find the Feature

 > Quick access

	Press	To
1		scroll to the desired option shortcut
2		open the selected option





## Setting a Phone Profile

You can set a phone profile, which includes ring tone, key tone, and vibrator settings. You can also rename a phone profile.

**Tip:** Press and hold **OK** from the idle display to change phone profiles.

### Turning On a Phone Profile

#### Find the Feature

-  > Profile
- > Normal/Meeting/Outdoors/  
Car/ Customized/Office
- > Activate

**Tip:** To turn on **Handsfree**, plug a handsfree kit in your phone's accessory port.



**Tip:** To turn on **Headset**, plug a headset kit in your phone's accessory port.

### Customizing a Phone Profile

You can customize the following options for a phone profile:

**Ringing volume** Select ring tone volume. Maximum is **Volume 5**.

**Ringing tone** Select a ring tone.

- Incoming call alert** Select how the ring tone works with incoming calls.
- Tip:** Scroll to **Off** to turn off **Ringtone**. If you turn off **Ringtone** and turn on **Vibrating**, your phone vibrates when you receive calls.
- Vibrating** Turn vibrator on or off.
- Message alert tone** Select an alert tone when your phone receive messages.
- Tip:** Scroll to **Off** to turn off **Message alert tone**. If you turn off **Message alert tone** and turn on **Vibrating**, your phone vibrates when it receive messages.
- Key tone volume** Select key tone volume. Maximum is **Level 5**.
- Key tone type** Select a key tone.
- Tip:** Scroll to **Off** to turn off the key tone.
- Warning tones** Turn on/off **Warning tones**, which are played when battery power is low or there is any operation error.
- Startup music** Turn on/off **Startup music**, which is played when you turn on/off your phone.
- Voice dial** Turn on/off **Voice dial**. To set voice dialing numbers, see page 87.
- Note:** **Voice dial** is for **Handsfree/Headset** only.
- Auto answer** Turn on/off **Auto answer**.
- Note:** **Auto answer** is for **Handsfree/Headset** only.



## Find the Feature

-  > Profile
- > Normal/Meeting/Outdoors/  
Car/ Customized/Office/  
Handsfree/Headset
- > Customize

## Renaming a Phone Profile

### Find the Feature

-  > Profile
- > Meeting/Outdoors/Car/  
Customized/Office > Rename

## Muting Your Phone

### Find the Feature

-  > Profile
- > Silence > ON



**Tip:** Press and hold  to turn on/off **Silence** from the idle display.

# Getting More Out of Your Phone

---

## Sending DTMF Tones

When you are on a call, you can send Dual Tone Multi-Frequency (DTMF) tones, for example, to enter your account number during a banking service call.



Press	To
keypad keys	enter your account number

---

## Making a Conference Call





In the idle display:

	Press	To
1	keypad keys	enter a phone number
2		make the 1st call
3	keypad keys	enter a phone number
4		make the 2nd call
		<b>Tip:</b> The 1st call is held when the 2nd call is active.
5	<b>OPTIONS</b> 	open the options menu





---



Press	To
6 	scroll to <b>Conference</b>
7 	make a conference call



## Ending a Conference Call

Press	To
1 <b>OPTIONS</b> 	open the options menu
2 	scroll to <b>End calls</b>
3 	select <b>End calls</b>
4 	scroll to the call you want to end
	<b>or</b>
	scroll to <b>All calls</b> (to end all calls at once)
5 	confirm your selection

## Diverting Calls



You can turn on **Call divert** to divert incoming calls to another phone number.

## Find the Feature

 > **Settings**  
> **Call features** > **Call divert**

## Blocking Calls



You can block outgoing or incoming calls.

**Note:** Set a password to turn on/off **Call barring**.

## Find the Feature

 > **Settings**  
> **Call features** > **Call barring**

## Setting Fax, Data, and Voice Calls

In addition to voice calls, you can receive fax and data calls.



Use an optional Motorola Original™ data cable to connect your phone to your computer to receive fax and data calls.

## Find the Feature

 > **Settings**  
> **Call features** > **Next call**

## Setting a Service Network

You can either set your phone to connect to a service network manually, or set your phone to connect to a



service network automatically whenever you turn on your phone.

### Find the Feature

 > Settings  
> Network

## Setting a Voice Call Connected Reminder

Tip: Scroll to **Off** to turn off the reminder.

### Find the Feature

 > Settings  
> Connection indication

## Setting a Call Time Reminder

Tip: Scroll to **Off** to turn off the reminder.

### Find the Feature

 > Settings  
> Minute reminder

## Checking Call Time

You can check the time you spent on different calls.

### Find the Feature

 > Recent calls  
> Call time > Last call/All calls/Received calls/Dialed calls

## Clearing Call Time

### Find the Feature

 > Recent calls  
> Call time > Clear timer

## Setting a Call Cost Counter



Set a call cost counter to check the cost you spent on different calls.

**Note:** Enter the PIN2 code to set a call cost counter.

### Find the Feature

 > Recent calls  
> Call cost > Setting

## Clearing Call Cost



**Note:** Enter the PIN2 code to clear all call costs.

### Find the Feature

 > Recent calls  
> Call cost > Clear cost

## Checking Call Cost



After setting a call cost counter, you can check the cost you spent on different calls.



### Find the Feature

 > Recent calls  
> Call cost > Last call/All calls

## Checking Call Credit



**Tip:** Reset the call cost counter if you exceed the credit limit and cannot make more phone calls.



**Find the Feature**

-  > Recent calls
- > Call cost > Credit remaining



## ***Displaying In-Call Time/ Cost***

**Find the Feature**

-  > Recent calls
- > In-call count
- > Call time/Call cost



## ***Displaying Call Time/Cost after a Call***

**Find the Feature**

-  > Recent calls
- > Session information > ON

## ***Using STK Services***



You can use SIM Tool Kit (STK) services your service provider provides.

**Find the Feature**







-  > STK

# Personal Organizer Features

## Turning On the Alarm Clock

Find the Feature

 > Alarm clock  
> On

	Press	To
1	keypad keys	enter the time
2	 down	highlight the <b>Repeat type</b> box
3	 right/left	scroll to the desired option
4	 down	highlight the <b>Vibrator</b> box
5	 right	turn on (put a check in) or turn off (delete a check from) the vibrator
6	 down	highlight the <b>Alarm tone</b> box
7	 right/left	scroll to the desired tone
8	<b>SAVE</b> 	save the settings and turn on the alarm clock



# Turning Off the Alarm Clock

Find the Feature



 > Alarm clock  
> Off

# Creating a Calendar Note



## Selecting a Date

Find the Feature













 > Tools  
> Calendar > Month mode

Press	To
1 	scroll to the desired date  <b>Tip:</b> If you created a calendar note on a date, the date is highlighted. The bold-faced date is the current date.
2 	select the date

## Writing a Calendar Note





Press	To
1 	select <b>Add new</b>
2 keypad keys	enter the time
3  down	highlight the <b>Note type</b> box
4  right/left	scroll to the desired option



	Press	To
5	 down	highlight the <b>Content</b> box
6	keypad keys	enter the content
7	 down	highlight the <b>Name</b> box
8		open the options menu
9		scroll to <b>From phonebook</b>
10		select <b>From phonebook</b>
11		scroll to the desired entry
12		select the entry
13		scroll to the desired phone number
14		select the phone number
15	 down	highlight the <b>Circulation type</b> box
16	 right/left	scroll to the desired option
17	 down	highlight the <b>Alarm</b> box
18	 right/left	scroll to the desired option

**Tip:** Scroll to **Off** to make the following **Vibrator** and **Alarm tone** options unavailable.







	Press	To
19	 down	highlight the <b>Vibrator</b> box
20	 right	turn on (put a check in) or turn off (delete a check from) the vibrator
21	 down	highlight the <b>Alarm tone</b> box
22	 right/left	scroll to the desired option
23	<b>SAVE</b> 	save the settings

## Moving/Copying a Calendar Note to Another Date

### Find the Feature

 > **Tools**  
> **Calendar** > **View all notes**

	Press	To
1		scroll to the desired calendar note
2		select the calendar note
3		open the options menu
4		scroll to <b>Move</b> or <b>Copy</b>
5		select <b>Move</b> or <b>Copy</b>
6	keypad keys	enter a date









Press	To
7 	move or copy the selected calendar note to the specified date

## ***Sending a Calendar Note as an SMS Message***

### **Find the Feature**

 > **Tools**  
> **Calendar** > **View all notes**

Press	To
1 	scroll to the desired calendar note
2 	select the calendar note
3 	open the options menu
4 	scroll to <b>Send note</b>
5 	select <b>Send note</b>
6 	scroll to <b>Send as text</b>
7 	select <b>Send as text</b>





**Tip:** See page 51 to write and send an SMS message.



# Making a Call from a Calendar Note

Find the Feature

 > Tools  
> Calendar > View all notes

	Press	To
1		scroll to the desired calendar note
2		select the calendar note
3		open the options menu
4		scroll to <b>Call</b>
5		make a call

# Checking a Calendar Note

Find the Feature

 > Tools  
> Calendar > View all notes



	Press	To
		check the desired calendar note

# Erasing a Calendar Note

Find the Feature

 > Tools  
> Calendar > Erase notes  
> One by one







	Press	To
1		scroll to the desired calendar note
2		erase the selected calendar note

## Creating an Account Book

### Find the Feature

 > **Tools**  
 > **Calendar** > **Account book**  
 > **Make accounts**

	Press	To
1	keypad keys	enter a date
2	 down	highlight the <b>Amount</b> box
3	keypad keys	enter an amount
4	 down	highlight the <b>Item</b> box
5	keypad keys	describe an item
6	 down	highlight the <b>In/Out</b> box
7	 right/left	scroll to the desired option
8	<b>SAVE</b> 	save the settings





## Checking Your Income

Find the Feature

-  > Tools
- > Calendar > Account book
- > Total count > Of chosen month/All accounts > In

## Checking Your Expense

Find the Feature

-  > Tools
- > Calendar > Account book
- > Total count > Of chosen month/All accounts > Out

## Checking Your Balance

Find the Feature

-  > Tools
- > Calendar > Account book
- > Total count > Of chosen month/All accounts
- > Balance

## Erasing Account Books

Find the Feature

-  > Tools
- > Calendar > Account book
- > Erase accounts







## Using the Calculator

Find the Feature





-  > Tools
- > Calculator











To perform simple calculations:

	<b>Press</b>	<b>To</b>
1	number keys	enter numbers
		enter a decimal point
	 up	<b>Add</b>
	 down	<b>Subtract</b>
	 right	<b>Divide</b>
	 left	<b>Multiply</b>
2		display the result

To convert currency:

	<b>Press</b>	<b>To</b>
1	<b>OPTIONS</b> 	open the options menu
2		scroll to <b>Exchange rate</b>
3		select <b>Exchange rate</b>
4		scroll to <b>Foreign unit expressed in domestic units</b> or <b>Domestic unit expressed in foreign units</b>



	Press	To
5		select <b>Foreign unit expressed in domestic units</b> or <b>Domestic unit expressed in foreign units</b>
6	keypad keys	enter an exchange rate  <b>Tip:</b> Press  to enter a decimal point.
7	OK 	save the setting
8	BACK 	return to the previous menu
9	BACK 	return to the previous menu
10	number keys	enter numbers
11	OPTIONS 	open the options menu
12		scroll to <b>In foreign</b> or <b>In domestic</b>
13		display the result

## Using the Stopwatch



To use your phone's stopwatch to perform split or lap timing:

### Find the Feature

-  > **Tools**
- > **Stopwatch**
- > **Split timing/Lap timing**





	Press	To
1	START 	start the operation



Press	To
2 <b>SPLIT/LAP</b> 	end the current timing and continue to start a new 1
3 <b>STOP</b> 	stop the operation



## *Saving Records*

To save records after you stop the operation:

Press	To
1 <b>OPTIONS</b> 	open the options menu
2 	scroll to <b>Save</b>
3 	select <b>Save</b>
4 keypad keys	enter a name
5 <b>OK</b> 	save records

## *Resuming the Operation*



To resume the operation after you stop it:

Press	To
1 <b>OPTIONS</b> 	open the options menu
2 	resume the operation



## Clearing Records

To clear records after you stop the operation:

	Press	To
1	OPTIONS 	open the options menu
2		scroll to <b>Reset</b>
3		clear records

## Checking a Records File

Find the Feature

 > Tools  
> Stopwatch > View times

## Erasing a Records File

Find the Feature

 > Tools  
> Stopwatch  
> Erase times > One By One

## Erasing All Records Files

Find the Feature

 > Tools  
> Stopwatch  
> Erase times > All at once







## Setting Voice-Activated Options

To turn on an option using voice activation, press and hold the voice activation key from the idle display until **Please say**

**name or command** displays; then say a command into the microphone.

### Find the Feature



 > **Tools**  
> **Voice commands**

	<b>Press</b>	<b>To</b>
1		scroll to <b>Add command</b> , if necessary
2		select <b>Add command</b>
3		scroll to the desired option
4		select the option
5		say a command into the microphone
		<b>Tip:</b> Repeat this step until <b>Voice command saved</b> displays.

## *Playing Voice-Activated Option Commands*

### Find the Feature

 > **Tools**  
> **Voice commands**

	<b>Press</b>	<b>To</b>
1		scroll to the desired voice-activated option
2		select the voice-activated option







	Press	To
3		play the selected voice-activated option command

## Changing Voice-Activated Option Commands

### Find the Feature

 > Tools  
> Voice commands

	Press	To
1		scroll to the desired voice-activated option
2		select the voice-activated option
3		scroll to <b>Change</b>
4		select <b>Change</b>
5		say a command into the microphone





**Tip:** Repeat this step until **Voice command saved** displays.

## Erasing Voice-Activated Options

### Find the Feature

 > Tools  
> Voice commands





	Press	To
1		scroll to the desired voice-activated option
2		select the voice-activated option
3		scroll to <b>Erase</b>
4		select <b>Erase</b>
5		erase the voice-activated option

## Displaying World Time

### Find the Feature

 > **Settings**  
> **Clock** > **World clock**

	Press	To
1		scroll to the desired place
2		display information on the selected place





# Turning On Your Phone's Voice Recorder



You can use your phone's voice recorder to record up to 30 seconds for every voice note.

**Caution:** Obey the local law or regulations when you use your phone's voice recorder to record.

## Find the Feature



 > Voice notes

## Starting to Record

	Press	To
1		record
2	<b>STOP</b> 	stop recording, if necessary
3	keypad keys	enter a name
4	<b>OK</b> 	save the voice note

## Playing a Voice Note





To turn on your phone's speaker 1st:

	Press	To
1		scroll to any voice note
2		open the options menu
3		scroll to <b>Speaker setting</b>



Press	To
4 ON 	turn on your phone's speaker

To play a voice note:



Press	To
1 	scroll to the desired voice note
2 	open the options menu
3 	scroll to <b>Playback</b>
4 	play the selected voice note
5 STOP 	stop playing the selected voice note, if necessary

## Turning Off Your Phone's Voice Recorder



Press	To
	turn off your phone's voice recorder

## Renaming a Voice Note

**Find the Feature**  > Voice notes





Press	To
1 	scroll to the desired voice note
2 	open the options menu



Press	To
3 	scroll to <b>Rename</b>
4 	select <b>Rename</b>
5 keypad keys	enter a new name
6 OK 	save the new name

## Deleting a Voice Note

Find the Feature  > Voice notes





Press	To
1 	scroll to the desired voice note
2 	open the options menu
3 	scroll to <b>Delete</b>
4 	select <b>Delete</b>
5 	delete the selected voice note

## Deleting All Voice Notes

Find the Feature  > Voice notes

Press	To
1 	scroll to any voice note











Press	To
2 	open the options menu
3 	scroll to <b>Delete all</b>
4 	select <b>Delete all</b>
5 	delete all voice notes

## ***Sending a Voice Note***







### **Find the Feature**

 > **Voice notes**







To send by a phone number:

Press	To
1 	scroll to the desired voice note
2 	open the options menu
3 	scroll to <b>Send in message</b>
4 	select <b>Send in message</b>
5 keypad keys	enter your message
6 <b>SEND</b> 	select <b>SEND</b>
7 <b>P.BOOK</b> 	open your phonebook
8 	scroll to the desired entry
9 	select the entry









	Press	To
10		scroll to the desired phone number
11		select the phone number
12	<b>BACK</b> 	return to the previous menu <b>Tip:</b> Repeat steps 8-12 to add other recipients.
13	<b>BACK</b> 	return to the previous menu
14		open the options menu
15		scroll to <b>Send</b>
16		send the selected voice note

To send by an e-mail address:

	Press	To
1		scroll to the desired voice note
2		open the options menu
3		scroll to <b>Send in message</b>
4		select <b>Send in message</b>
5	keypad keys	enter your message
6	<b>SEND</b> 	select <b>SEND</b>
7		open the options menu







Press	To
8 	scroll to <b>New e-mail address</b>
9 	select <b>New e-mail address</b>
10 keypad keys	enter an e-mail address
11 	add the e-mail address to the <b>Recipients</b> box
<b>Tip:</b> Repeat steps 7-11 to add other recipients.	
12 	open the options menu
13 	scroll to <b>Send</b>
14 	send the selected voice note

## Checking a Voice Note

### Find the Feature

 > Voice notes







Press	To
1 	scroll to the desired voice note
2 	open the options menu
3 	scroll to <b>Details</b>
4 	check the selected voice note



# Sorting Voice Notes

## Find the Feature

 > Media center  
> Voice notes

	Press	To
1		scroll to any voice note
2		open the options menu
3		scroll to <b>Sort files</b>
4		select <b>Sort files</b>
5		scroll to the desired option
6		sort voice notes by the selected option



# Security

---



## Locking and Unlocking the Keypads

You can press  to answer calls after you lock the keypads.

### Locking the Keypads Manually

**Find the Feature**

 > Settings  
> Key lock > Lock now

### Unlocking the Keypads

In the idle display:

**Press**

**To**

 and 

unlock the keypads

---

---

### Setting the Keypads to Lock Automatically

To lock the keypads after no activity occurs in 20 seconds:

**Find the Feature**

 > Settings  
> Key lock > Auto



# Setting a Closed User Group



You can set a user group that is able to call you and receive your calls.

**Tip:** Scroll to **Preset** to use the default user group you subscribed to your service

provider.

Security

## Find the Feature

- > **Settings**
- > **Security**
- > **Closed user group > On**

# News and Entertainment

---

## Playing a Game

Find the Feature  > Games





## Managing a Photo Folder

Find the Feature  > Media center  
> Photo album

## Drawing a Picture

Find the Feature  > Media center  
> Picture

## Setting a Background Image (Optional)

Press	To
1 	scroll to any picture
2 	open the options menu
3 	select <b>New</b>
4 <b>OPTIONS</b> 	open the options menu
or	
	







	Press	To
5		select <b>Open</b>
6		scroll to the desired option
7		select the option
8		scroll to the desired folder, if necessary
9		select the folder, if necessary
10		scroll to the desired object
11		select the object
12		set the selected object as a background image

## Setting a Pen Mode

On a canvas:

	Press	To
1	<b>OPTIONS</b>	open the options menu
	<b>or</b>	
2		scroll to <b>Pen mode</b>
3		select <b>Pen mode</b>







	Press	To
4		scroll to the desired pen mode
5		select the pen mode

Tip: On a canvas, press  to set **Pen mode**.

## Setting a Pen Color

Note: The option is not available for an eraser.

On a canvas:







	Press	To
1	<b>OPTIONS</b>  or 	open the options menu
2		scroll to <b>Pen color</b>
3		select <b>Pen color</b>
4		scroll to the desired pen color
5		select the pen color

Tip: On a canvas, press  to set **Pen color**.



## Setting a Pen Size



On a canvas:

	Press	To
1	OPTIONS 	open the options menu
	or	
		
2		scroll to <b>Pen size</b>
3		select <b>Pen size</b>
4		scroll to the desired pen size
5		select the pen size



Tip: On a canvas, press  to set **Pen size**.

## Setting a Pen Step

On a canvas:









	Press	To
1	OPTIONS 	open the options menu
	or	
		
2		scroll to <b>Pen step</b>



	Press	To
3		select <b>Pen step</b>
4		scroll to the desired pen step
5		select the pen step

## Setting a Canvas Size











On a canvas:

	Press	To
1	<b>OPTIONS</b> 	open the options menu
	or	
		
2		scroll to <b>Picture size</b>
3		select <b>Picture size</b>
4	 right/left	scroll to the desired width
5	 down	highlight the <b>Height</b> box
6	 right/left	scroll to the desired height
7		save the settings





## Beginning a Picture

On a canvas:

	Press	To
1		move the cursor to the desired direction
	<b>or</b>	
		
		
		
		
2		draw/remove a dot or line
	<b>or</b>	
		

## Zooming In/Out on a Picture





On a canvas:

	Press	To
1	<b>OPTIONS</b> 	open the options menu
	<b>or</b>	
		
2		scroll to <b>Zoom in</b> or <b>Zoom out</b>

	Press	To
3		zoom in or zoom out on a picture





## *Clearing a Canvas*

On a canvas:

	Press	To
1	OPTIONS  or 	open the options menu
2		scroll to <b>Clear screen</b>
3		clear a canvas

## *Saving a Picture*

On a canvas:

	Press	To
1	OPTIONS  or 	open the options menu
2		scroll to <b>Save</b>
3		select <b>Save</b>





Press	To
4 keypad keys	enter a name
5 	save a picture in <b>Media center</b> < <b>Picture</b>









## Composing a Melody

Find the Feature

 > **Media center**  
> **Melody**















### Changing an Existing Melody

Press	To
1 	scroll to any melody
2 	open the options menu
3 	select <b>New</b>
4 <b>OPTIONS</b> 	open the options menu
5 	select <b>Open</b>
6 	scroll to the desired melody
7 	select the melody
8 	insert the selected melody to a staff
9  right/left	scroll to the desired note/rest



Press	To
10 keypad keys	change the selected note/rest (see page 137)

Use the following keypad keys to change or create a melody:





Press	To
	insert a C sharp note
	insert a D sharp note
	insert an E sharp note
	insert an F sharp note
	insert a G sharp note
	insert an A sharp note
	insert a B sharp note
	increase the length of the selected note/rest
	move the selected note 1 octave up
	decrease the length of the selected note/rest
	move the selected note 1 octave down
	insert a rest
	remove the selected note/rest







Press	To
 up	move the selected note up on a staff
 down	move the selected note down on a staff





## Creating a New Melody

	Press	To
1		scroll to any melody
2		open the options menu
3		select <b>New</b>
4		move the pointer
5	keypad keys	compose a melody (see page 137)

## Setting an Instrument





On a staff:

	Press	To
1	<b>OPTIONS</b> 	open the options menu
2		scroll to <b>Instruments</b>
3		select <b>Instruments</b>

	Press	To
4		scroll to the desired instrument
5		select the instrument
6		scroll to the desired option
7		select the option

## Setting a Tempo

On a staff:

	Press	To
1	<b>OPTIONS</b> 	open the options menu
2		scroll to <b>Tempo</b>
3		select <b>Tempo</b>
4		scroll to the desired tempo
5		select the tempo

## Playing a Melody

On a staff:

	Press	To
1	<b>OPTIONS</b> 	open the options menu





	Press	To
2		scroll to <b>Play</b>
3		play a melody with the selected instrument and tempo

## *Saving a Melody*

On a staff:

	Press	To
1	<b>OPTIONS</b>	open the options menu
2		scroll to <b>Save</b>
3		select <b>Save</b>
4	keypad keys	enter a name
5		save a melody in <b>Media center &lt; Melody</b>

## *Clearing a Staff*

On a staff:

	Press	To
1	<b>OPTIONS</b>	open the options menu
2		scroll to <b>Clear screen</b>

Press	To
3 	clear a staff

## Displaying a Multimedia Object







Multimedia objects include photos, pictures, animations, melodies, voice notes, and videos.

To play voice notes, see page 120.

To play videos, see page 160.

### Find the Feature

 > **Media center**  
> **Photo album/Picture/**  
**Animation/Melody**







Press	To
1 	scroll to the desired folder, if necessary
2 	select the folder, if necessary
3 	scroll to the desired object
4 	select the object
5 	display/play the selected object
6  up/down	zoom in/out on the selected object
	<b>Note:</b> This is for photos and pictures only.



# Deleting a Multimedia Object

## Find the Feature

 > Media center  
> Photo album/Picture/  
Animation/Melody

	Press	To
1		scroll to the desired folder, if necessary
2		select the folder, if necessary
3		scroll to the desired object
4		open the options menu
5		scroll to <b>Delete</b>
6		select <b>Delete</b>
7		delete the selected object















# Sending a Multimedia Object

## Find the Feature

 > Media center  
> Photo album/Picture/  
Animation/Melody

To send by a phone number:

	Press	To
1		scroll to the desired folder, if necessary











	Press	To
2		select the folder, if necessary
3		scroll to the desired object
4		open the options menu
5		scroll to <b>Send</b>
6		select <b>Send</b>
7	keypad keys	enter your message
8	<b>SEND</b> 	select <b>SEND</b>
9	<b>P.BOOK</b> 	open your phonebook
10		scroll to the desired entry
11		select the entry
12		scroll to the desired phone number
13		select the phone number
14	<b>BACK</b> 	return to the previous menu
		<b>Tip:</b> Repeat steps 10-14 to add other recipients.
15	<b>BACK</b> 	return to the previous menu
16		open the options menu
17		scroll to <b>Send</b>









Press	To
18 	send the selected object

To send by an e-mail address:

Press	To
1 	scroll to the desired folder, if necessary
2 	select the folder, if necessary
3 	scroll to the desired object
4 	open the options menu
5 	scroll to <b>Send</b>
6 	select <b>Send</b>
7 keypad keys	enter your message
8 <b>SEND</b> 	select <b>SEND</b>
9 	open the options menu
10 	scroll to <b>New e-mail address</b>
11 	select <b>New e-mail address</b>
12 keypad keys	enter an e-mail address









Press	To
13 	add the e-mail address to the <b>Recipients</b> box  <b>Tip:</b> Repeat steps 9-13 to add other recipients.
14 	open the options menu
15 	scroll to <b>Send</b>
16 	send the selected object



## Renaming a Multimedia Object

### Find the Feature

 > **Media center**  
> **Photo album/Picture/Animation/Melody**

Press	To
1 	scroll to the desired folder, if necessary
2 	select the folder, if necessary
3 	scroll to the desired object
4 	open the options menu
5 	scroll to <b>Rename</b>
6 	select <b>Rename</b>
7 keypad keys	enter a new name

**Press****To**

8



save the new name

## Moving a Photo/Picture to Another Photo Folder

**Find the Feature**> **Media center**> **Photo album/Picture****Press****To**

1



scroll to the desired folder, if necessary

2



select the folder, if necessary

3



scroll to the desired object

4



open the options menu

5

scroll to **Move to**

6

select **Move to**

7



scroll to the desired folder

8









move the object to the selected folder



# Checking a Multimedia Object

## Find the Feature



 > Media center  
> Photo album/Picture/  
Animation/Melody

	Press	To
1		scroll to the desired folder, if necessary
2		select the folder, if necessary
3		scroll to the desired object
4		open the options menu
5		scroll to <b>Details</b>
6		check the selected object

# Sorting Multimedia Objects

## Find the Feature

 > Media center  
> Photo album/Picture/  
Animation/Melody

	Press	To
1		scroll to the desired folder, if necessary
2		select the folder, if necessary
3		scroll to any object





	Press	To
4		open the options menu
5		scroll to <b>Sort files</b>
6		select <b>Sort files</b>
7		scroll to the desired option
8		sort objects by the selected option

## Playing a Java Game

**Find the Feature** > Java

**Tip:** Before playing a Java game, set the amount of time that the display and keypad backlights remain on to maximum. (To set **Backlight** to maximum, press > **Settings** > **Backlight** > 20 secs.)

## Setting Java

**Find the Feature** > **Settings**  
> **Java settings**



## Turning On Your Phone Camera



**Caution:** Obey the local law or regulations when you use your phone camera to capture images.

**Find the Feature** > **Camera**



## Taking and Saving a Picture

**Tip:**  (The viewfinder icon) indicates the image area you can capture.

**Tip:**  indicates you can press  or  to save the picture you took in **Media center > Photo album >** the default folder. The picture is automatically named. To rename it, see page 145.



**Tip:**  indicates you can press  to turn off the camera.

With your phone's flip open (using the internal display to view images):

Press	To
1 	take a picture
2 	save the picture

## Naming a Picture

After taking a picture:

Press	To
1 	open the options menu
2 	scroll to <b>Rename</b>
3 	select <b>Rename</b>
4 keypad keys	enter a name









Press	To
5 	save the picture

## Rotating a Picture



After taking a picture:



Press	To
1 	open the options menu
2 	scroll to <b>Rotate</b>
3 	select <b>Rotate</b>
4 	scroll to the desired option
5 	rotate the picture

**Tip:** The option is available only for pictures with **128x160** resolution.

## Setting a Picture as a Wallpaper Image





After taking a picture:

Press	To
1 	open the options menu
2 	scroll to <b>Apply as wallpaper</b>
3 	select <b>Apply as wallpaper</b>

	Press	To
4		scroll to any entry
5		set the picture as a wallpaper image and save it in <b>Media center &gt; Photo album</b> > the default folder and in <b>Settings &gt; Display &gt; Wallpaper</b>

## Setting a Picture as a Screen Saver Image

After taking a picture:













	Press	To
1		open the options menu
2		scroll to <b>Apply as screen saver</b>
3		select <b>Apply as screen saver</b>
4		scroll to any entry
5		set the picture as a screen saver image and save it in <b>Media center &gt; Photo album</b> > the default folder and in <b>Settings &gt; Display &gt; Screen saver</b>















## ***Sending a Picture***

To send by a phone number after taking a picture:

	<b>Press</b>	<b>To</b>
1		open the options menu
2		select <b>Send</b>
3	keypad keys	enter your message
4	<b>SEND</b> 	select <b>SEND</b>
5	<b>P.BOOK</b> 	open your phonebook
6		scroll to the desired entry
7		select the entry
8		scroll to the desired phone number
9		select the phone number
10	<b>BACK</b> 	return to the previous menu
		<b>Tip:</b> Repeat steps 6-10 to add other recipients.
11	<b>BACK</b> 	return to the previous menu
12		open the options menu
13		scroll to <b>Send</b>
14		send the picture

To send by an e-mail address after taking a picture:

Press	To
1 	open the options menu
2 	select <b>Send</b>
3 keypad keys	enter your message
4 <b>SEND</b> 	select <b>SEND</b>
5 	open the options menu
6 	scroll to <b>New e-mail address</b>
7 	select <b>New e-mail address</b>
8 keypad keys	enter an e-mail address
9 	add the e-mail address to the <b>Recipients</b> box
	<b>Tip:</b> Repeat steps 5-9 to add other recipients.
10 	open the options menu
11 	scroll to <b>Send</b>
12 	send the picture

## Turning Off Your Phone Camera

Press	To
	turn off your phone camera



# Customizing Your Phone Camera

Find the Feature

 > Camera

## Using the Zoom Lens

Tip:  indicates the zoom lens control.

With your phone's flip open:



**Press**

**To**



up/down

zoom in/out on images

## Using the Brightness Control

Tip:  indicates the brightness control.

**Press**



**To**



right/left

increase/decrease brightness of images

## Using the Flash

Tip:  and  indicate the flash is turned on.

Tip:  indicates the flash is turned off.

**Press**



**To**







ON/OFF 

turn on/off the flash

## Setting Resolution

The better resolution your picture has, the more phone memory your picture uses. Your phone camera includes the following picture resolutions:

- 160x120** supports **Landscape**  mode and 3x digital zoom lens.
- 320x240** supports **Landscape**  mode and 2x digital zoom lens.
- 640x480** supports **Landscape**  mode, not supporting digital zoom lens.
- 128x160** supports **Portrait**  mode and 3x digital zoom lens.

	Press	To
1		open the options menu
2		select <b>Resolution</b>
3		scroll to the desired resolution
4		select the resolution
5	<b>BACK</b> 	return to the previous menu
6	<b>BACK</b> 	prepare to capture images



## Setting Quality







The better quality your picture has, the more phone memory your picture uses. Your phone camera includes the following picture qualities:

**Fine**  provides best quality.

**Normal**  provides regular quality.







**Basic**  provides poor quality.



	Press	To
1		open the options menu
2		scroll to <b>Quality</b>
3		select <b>Quality</b>
4		scroll to the desired quality
5		select the quality
6	<b>BACK</b> 	return to the previous menu
7	<b>BACK</b> 	prepare to capture images

## Framing a Picture





	Press	To
1		open the options menu

	Press	To
2		scroll to <b>Frame</b>
3		select <b>Frame</b>
4		select <b>On</b>
5		scroll to the desired frame
6		select the frame
7		prepare to capture images

**Tip:** The option is available only for pictures with **128x160** resolution.

## ***Turning On/Off the Twilight Mode***





**Tip:**  indicates **Twilight mode** is turned on.

	Press	To
1		open the options menu
2		scroll to <b>Twilight mode</b>
3	<b>ON/OFF</b> 	turn on/off the twilight mode
4		prepare to capture images







## Turning On the 10-Second Self Timer

Tip:  indicates **Self timer** is turned on.

	Press	To
1		open the options menu
2		scroll to <b>Self timer</b>
3	ON 	turn on the self timer
4		prepare to capture images
5		take a picture in 10 seconds

## Turning On/Off the Shutter Sound

	Press	To
1		open the options menu
2		scroll to <b>Shutter sound</b>
3	ON/OFF 	turn on/off the shutter sound
4		prepare to capture images

## Setting the White Balance

Your phone camera includes 4 modes for taking pictures:

Auto 

indicates your phone camera will adjust itself to the environment where you want to capture images.

**Sunlight** 







indicates you want to capture images outdoors on a sunny day.

**Fluorescent** 

indicates you want to capture images in a room with fluorescent lighting.

**Incandescent** 

indicates you want to capture images under incandescent light.

	Press	To
1		open the options menu
2		scroll to <b>White balance</b>
3		select <b>White balance</b>
4		scroll to the desired mode
5		select the mode
6	<b>BACK</b> 	return to the previous menu
7	<b>BACK</b> 	prepare to capture images

## ***Turning On Your Phone's Video Recorder***

You can use your phone's video recorder to record up to 15 seconds of every video.

**Caution:** Obey the local law or regulations when you use your phone's video recorder to record.





**Find the Feature**

 > **V. recorder**









## Setting Time to Record





	Press	To
1		open the options menu
2		scroll to <b>Time to record</b>
3		select <b>Time to record</b>
4		scroll to the desired duration
5		select the duration

## Starting to Record

	Press	To
1		record
2		stop recording, if necessary
3		prepare to save the video
4	keypad keys	enter a name
5		save the video

## Playing a Video

	Press	To
1		open the options menu

Press	To
2 	select <b>Open</b>
3 	scroll to the desired video
4 	play the selected video
5 	stop playing the selected video, if necessary

## *Turning Off Your Phone's Video Recorder*







Press	To
	turn off your phone's video recorder

## *Renaming a Video*

**Find the Feature**

 > **V. recorder**

Press	To
1 	open the options menu
2 	select <b>Open</b>
3 	scroll to the desired video
4 	open the options menu
5 	scroll to <b>Rename</b>



Press	To
6	select <b>Rename</b>
7 keypad keys	enter a new name
8	save the new name

## Deleting a Video

Find the Feature

> V. recorder















Press	To
1	open the options menu
2	select <b>Open</b>
3	scroll to the desired video
4	open the options menu
5	scroll to <b>Delete</b>
6	select <b>Delete</b>
7	delete the selected video

## Sending a Video

Find the Feature

> V. recorder



To send by a phone number:

Press	To
1 	open the options menu
2 	select <b>Open</b>
3 	scroll to the desired video
4 	open the options menu
5 	scroll to <b>Send</b>
6 	select <b>Send</b>
7 keypad keys	enter your message
8 <b>SEND</b> 	select <b>SEND</b>
9 <b>P.BOOK</b> 	open your phonebook
10 	scroll to the desired entry
11 	select the entry
12 	scroll to the desired phone number
13 	select the phone number
14 <b>BACK</b> 	return to the previous menu
15 <b>BACK</b> 	return to the previous menu











**Tip:** Repeat steps 10-14 to add other recipients.









Press	To
16 	open the options menu
17 	scroll to <b>Send</b>
18 	send the selected video

To send by an e-mail address:

Press	To
1 	open the options menu
2 	select <b>Open</b>
3 	scroll to the desired video
4 	open the options menu
5 	scroll to <b>Send</b>
6 	select <b>Send</b>
7 keypad keys	enter your message
8 <b>SEND</b> 	select <b>SEND</b>
9 	open the options menu
10 	scroll to <b>New e-mail address</b>
11 	select <b>New e-mail address</b>
12 keypad keys	enter an e-mail address







	Press	To
13		add the e-mail address to the <b>Recipients</b> box
<b>Tip:</b> Repeat steps 9-13 to add other recipients.		
14		open the options menu
15		scroll to <b>Send</b>
16		send the selected video



## Checking a Video

### Find the Feature









 > V. recorder

	Press	To
1		open the options menu
2		select <b>Open</b>
3		scroll to the desired video
4		open the options menu
5		scroll to <b>Details</b>
6		check the selected video

# Sorting Videos

**Find the Feature**

 > V. recorder

	<b>Press</b>	<b>To</b>
1		open the options menu
2		select <b>Open</b>
3		scroll to any video
4		open the options menu
5		scroll to <b>Sort files</b>
6		select <b>Sort files</b>
7		scroll to the desired option
8		sort videos by the selected option

## Setting Network Connection

Your service provider may set a network connection profile, including the service provider and connection settings, before you receive your phone. You can also customize it or create a new 1.

**Find the Feature**





 > **Browser**  
> **Profiles**

# Connecting to the Internet

You can use your phone to connect to your networking provider's homepage, any bookmark, or any URL.

If network connection is established, refer to the following instructions to activate an option, return to the last page, and end network connection.

To activate an option:

Press	To
1 	scroll to the desired option
2 	activate the selected option
or	
 > 	

To return to the last page:

Press	To
<b>BACK</b> 	return to the last page



To end network connection:

Press	To
	end network connection







Press	To
1 	open the options menu
2 	scroll to <b>Exit</b>
3 	end network connection

## Connecting to Your Networking Provider's Homepage

### Find the Feature



 > **Browser**  
> **Home**

## Connecting to a Bookmark

You can use your phone to connect to a factory-set or self-created bookmark.

### Find the Feature

 > **Browser**  
> **Bookmark**

Press	To
1 	scroll to the desired bookmark
2 	select the bookmark
3 	connect to the selected bookmark

## Connecting to a URL

### Find the Feature

 > Browser  
> Go to address

	Press	To
1	keypad keys	enter a URL
2		connect to the URL

## Setting a Bookmark

You can create, edit, or erase a bookmark.

**Tip:** To connect to a bookmark, see page 168.

### Find the Feature

 > Browser  
> Bookmark

## Downloading Multimedia Objects

You can download multimedia objects, such as pictures, ring tones, or animations from the Internet.

### Find the Feature

 > Media center  
> Download media

## Setting Web Page Display Style

### Find the Feature

 > Browser  
> Appearance settings



## ***Allowing/Rejecting Cookies***

**Find the Feature**



> **Browser**

> **Download settings > Cookies**

## ***Clearing Cache Memory***

**Find the Feature**



> **Browser**

> **Clear the cache**



## ***Reading Your Networking Provider's Messages***

**Find the Feature**



> **Browser**

> **Service Inbox**

## ***Reading Certificates***

**Find the Feature**



> **Browser**

> **Certificates**

# Troubleshooting

---

Check these questions first if your phone does not seem to work properly. If you need additional help, contact the Motorola Customer Call Center at 1-800-331-6456 (USA) or 1-800-461-4575 (Canada).

Question	Answer
Is your battery charged?	The battery level indicator should have at least 1 segment showing. If it does not, recharge your battery (see page 21).
Have you installed a valid SIM card?	If necessary, turn off your phone and make sure that you have inserted a valid SIM card (see page 20).
Does the phone have a signal?	The signal strength indicator should have at least 1 segment showing. If it does not, move to an area with a stronger signal.
Is the other party unable to hear you?	Your phone may be muted. If necessary, press <b>OPTIONS</b>  > <b>Unmute</b> to unmute the phone.  Also, make sure that your phone's microphone is not blocked by its carrying case or a sticker.



Question	Answer
Has the phone been damaged, dropped, or gotten wet?	Dropping your phone, getting it wet, or using a non-Motorola battery or battery charger can damage the phone. The phone's limited warranty does not cover these types of damages.
Was a non-Motorola battery or battery charger used?	

The following refers to specific symptoms:

Symptom	Solution
My phone was stolen. To whom should I report this?	Report a stolen phone to the police and to your service provider (the company that sends you your monthly wireless service bill).
I forgot my password.	Contact your service provider.
I pressed the power key, but nothing happened.	Be sure to press and hold  (the power key) until you see the welcome display and an alert sounds. This could take several seconds. If nothing happens, check that a charged battery is installed (see page 20).



Symptom	Solution
The display shows: <b>Insert SIM Card or Check SIM Card</b> even though I have inserted my SIM card in the phone.	The SIM card may be incorrectly inserted. Check the SIM card to make sure that it is inserted properly (see page 20).
The display shows: <b>SIM Blocked. How do I unblock my SIM card?</b>	Call your service provider to obtain the PIN Unlocking Key (PUK) code.
The display shows: <b>Enter Unlock Code. How do I unlock my phone?</b>	Enter the factory-preset unlock code (1234), or the last 4 digits of your phone number. If this fails, call your service provider.
<b>My phone prompts for an unlock code when I try to open a feature.</b>	The feature you want is locked. If you do not know the unlock code, call your service provider.
<b>My phone does not ring.</b>	The ringer may be set to <b>Silence</b> even though your phone is set to an audible ring style. To turn off <b>Silence</b> , press and hold <input type="text" value="#"/> from the idle display.





Symptom	Solution
I tried to place a call and heard an alternating high/low tone.	Your call did not reach the wireless system. You may have dialed the number too soon after turning the phone on. Wait until the display shows the name of your service provider before placing a call.
I cannot send/receive calls.	<p>Make sure that you have a phone signal (the signal strength indicator should have at least 1 segment showing). Avoid electrical or radio interference, and obstructions such as bridges, parking garages, or tall buildings.</p> <p>Your phone also may have the <b>Call barring</b> feature turned on. If you know the unlock code, you can change this setting in the call barring menu (  &gt; <b>Settings</b> &gt; <b>Call features</b> &gt; <b>Call barring</b> &gt; <b>Cancel all</b> ).</p> <p>Also, check to be sure your SIM card is installed and working.</p>

Symptom	Solution
My phone has poor reception and drops calls.	<p>Make sure that your antenna is not bent or damaged.</p> <p>Also, make sure you have a phone signal (the signal strength indicator should have at least 1 segment showing). Stay clear of any obstructions such as bridges, parking garages, or tall buildings.</p>
I cannot hear others on my phone.	<p>While on a call, press the up in-call volume key. Your phone display should show the volume increasing.</p> <p>Also, make sure that your phone's earpiece is not blocked by its carrying case.</p>
How do I see the calls I sent or received?	<p>To see the most recent calls you dialed or received:</p> <p> &gt; <b>Recent calls</b> &gt; <b>Dialed calls</b> or <b>Received calls</b></p>
My phone's display is too dark.	<p>Use the <b>Adjust contrast</b> feature to change the level of contrast in your display (see page 42).</p> <p>You can also use the <b>Backlight</b> feature to change the length of time that the display backlight stays on (see page 42).</p>







Symptom	Solution
My phone's battery charge doesn't last as long as I expected. What can I do to extend battery life?	Battery performance is affected by charge time, feature use, temperature changes, backlight use, and other factors. For tips on extending battery life, see page 22.
I am unable to record a voice note, voice name, or voice option	Try moving to a quieter location to make your voice recording. Hold the phone about four inches (10 centimeters) from your mouth, and speak directly into your phone's microphone in a normal tone of voice.
I launched the micro-browser but the display shows: <b>Network Not Available.</b>	You may be in an area without service, or you may be connected to a network that does not support Internet access.
I launched the micro-browser but the display shows: <b>Server Not Responding.</b>	Try again in a few minutes. The servers may be temporarily busy.

## ***Specific Absorption Rate Data***

---

**This model phone meets the international standards for exposure to radio waves.**

Your mobile phone is a radio transmitter and receiver. It is designed and manufactured not to exceed limits for exposure to radio frequency (RF) energy. These limits are part of comprehensive guidelines and establish permitted levels of RF energy for the general population. The guidelines are based on standards that were developed by independent scientific organizations through periodic and thorough evaluation of scientific studies. The guidelines include a substantial safety margin designed to assure the safety of all persons, regardless of age and health.

The exposure standard for mobile phones employs a unit of measurement known as the Specific Absorption Rate, or SAR. Under the guidelines for your phone model, the SAR limit is 2.0 W/kg.<sup>1</sup> Tests for SAR are conducted in accordance with CENELEC<sup>2</sup> testing procedures using standard operating positions with the phone transmitting at its highest certified power level in all tested frequency bands. Although the SAR is determined at the highest certified power level, the actual SAR of the phone while operating can be well below the maximum value. This is because the phone is designed to operate at multiple power levels so as to use only the power required to reach the network. In general, the closer you are to a base station, the lower the power output of the phone.

Before a phone model is available for sale to the public, it is tested to confirm compliance with the guidelines. The tests are performed in positions that conform to a uniform testing methodology determined by an expert standards body. The highest SAR value for this model phone when tested for use at the ear is 0.88 W/kg.<sup>3</sup>

While there may be differences between the SAR levels of various phones and at various positions, they all meet the governmental requirements for safe exposure. Please note that improvements to this product model

could cause differences in the SAR value for later products; in all cases, products are designed to be within the guidelines.

1. The SAR limit recommended by international guidelines (ICNIRP) for mobile phones used by the public is 2.0 watts/kilogram (W/kg) averaged over ten grams of tissue. The limit incorporates a substantial margin for safety to give additional protection for the public and to account for any variations in measurements.
2. CENELEC is a European Union standards body.
3. Additional related information includes the Motorola testing protocol, assessment procedure, and measurement uncertainty range for this product.

# Index

---

## A

- accessories 19
- alert
  - defined 25, 31, 34, 40, 44, 45, 48, 73, 94, 95, 100, 101, 102, 128
  - turning off 26, 46, 47, 100
- animation
  - screen saver 31, 40, 44, 45, 94, 95, 101, 102, 127, 128
  - wallpaper 44
- answering a call 26, 46, 47, 99

## B

- backlight 42
- battery
  - charging 21
  - extending battery life 22, 42, 44
  - installing 20
  - level indicator 22, 23
- block cursor 31

## C

- call
  - alert, turning off 26, 46, 47, 100
  - answering 26, 46, 47, 99
  - barring password, changing 40
  - dialing 25
  - ending 26, 46, 47, 100
  - making 25
  - receiving 26, 46, 47, 99
- clock
  - setting 42, 43, 119
- codes
  - changing 40
  - forgetting 40
- color, setting 43
- contrast, setting 42
- cursor 31

## D

- date, setting 42, 43, 119
- dialing a number 25
- display
  - backlight 42
  - color 43
  - contrast 42
  - description 27

idle display 30  
idle display, defined 27

## E

earpiece volume 24  
end key 26, 46, 47, 100  
ending a call 26, 46, 47,  
100  
**Enter Unlock Code** message 39,  
40  
external display 38

## F

flashing cursor 31  
flip  
    activating 24, 26, 148  
    external display 38  
    screen saver 31, 34, 44,  
    94, 127

## I

idle display 27  
idle display, defined 30  
indicators  
    battery level 22, 23

## K

key  
    end 26, 46, 47, 100  
    left soft key 27  
    menu 31

power 23  
right soft key 27  
send 25, 26, 46, 47, 99,  
100

keypad  
    backlight 42

## L

left soft key  
    functions 27  
lock  
    phone 38

## M

making a call 25  
menu  
    entering text 31  
    navigating 30  
menu key 31  
my telephone number 26,  
46, 47, 48, 49, 50,  
51, 52, 53, 58, 60,  
61, 62, 64, 65, 66,  
67, 68, 94, 95, 96,  
100, 102, 104, 105,  
106, 129, 141, 142,  
145, 146, 147, 148

## N

number

storing your number 48,  
49, 50, 51, 52, 53,  
58, 60, 61, 62, 64,  
65, 66, 67, 68, 94,  
95, 96, 102, 104,  
105, 106, 129,  
141, 142, 145,  
146, 147, 148

viewing your number 26,  
46, 47, 100

numeric text entry method  
32

## O

optional accessory, defined  
19

optional feature, defined 19

## P

passwords. *See* codes

phone

alert, turning off 26, 46,  
47, 100

codes 40

date, setting 42, 43, 119

flip 24, 26, 148

locking 38

time, setting 42, 43, 119

turning on/off 23

unlocking 23, 24, 38, 40

phone number

storing your number 48,  
49, 50, 51, 52, 53,  
58, 60, 61, 62, 64,  
65, 66, 67, 68, 94,  
95, 96, 102, 104,  
105, 106, 129,  
141, 142, 145,  
146, 147, 148

viewing your number 26,  
46, 47, 100

picture

screen saver 31, 40, 44,  
45, 94, 95, 101,  
102, 127, 128

wallpaper 44

PIN code

changing 40

PIN2 code

changing 40

power key 23

predictive text entry 34

## R

right soft key

functions 27

ring alert

turning off 26, 46, 47,  
100

ring style

setting 25, 31, 34, 40, 44,  
45, 48, 73, 94, 95,

100, 101, 102,  
128, 148

## S

screen saver 31, 40, 44, 45,  
94, 95, 101, 102,  
127, 128

security code  
changing 40  
forgetting 40

send key 25, 26, 46, 47, 99,  
100

shortcuts 5

silent ring alert, setting 25,  
31, 34, 40, 44, 45,  
48, 73, 94, 95, 100,  
101, 102, 128, 148

**SIM Blocked** message 23

SIM card

defined 20

installing 20

PIN code entry 23

PIN code, changing 40

PIN2 code, changing 40

precautions 20

**SIM Blocked** message 23

SIM PIN code

changing 40

SIM PIN2 code

changing 40

soft keys

functions 27

standby time, increasing  
42, 44

## T

tap method text entry 33

telephone number

storing your number 48,  
49, 50, 51, 52, 53,  
58, 60, 61, 62, 64,  
65, 66, 67, 68, 94,  
95, 96, 102, 104,  
105, 106, 129,  
141, 142, 145,  
146, 147, 148

viewing your number 26,  
46, 47, 100

text

block cursor 31

entering 31

entry method, changing  
32

flashing cursor 31

iTAP software predictive  
text entry 34

tap method 33

text entry method

iTAP software 34

numeric 32

text entry method, changing  
32

time, setting 42, 43, 119

travel charger 21

## **U**

unlock

    phone 38

unlock code

    bypassing 40

    changing 40

    entering 23, 24, 39

    forgetting 40

## **V**

vibrate alert

    turning off 26, 46, 47,  
        100

vibrate ring alert, setting

    25, 31, 34, 40, 44,

    45, 48, 73, 94, 95,

    100, 101, 102, 128,

    148

volume

    earpiece 24

## **W**

wallpaper 44