

APPLICANT: MOTOROLA, INC.

FCC ID: IHDT6GN1

**INSTRUCTION MANUAL**

A preliminary draft copy of the Users Manual follows:



# *MOTOMANUAL*

V3xx  
3G

[motorola.com](http://motorola.com)

# HELLOMOTO

---

Introducing your new Motorola V3xx 3G wireless phone. Here's a quick anatomy lesson.

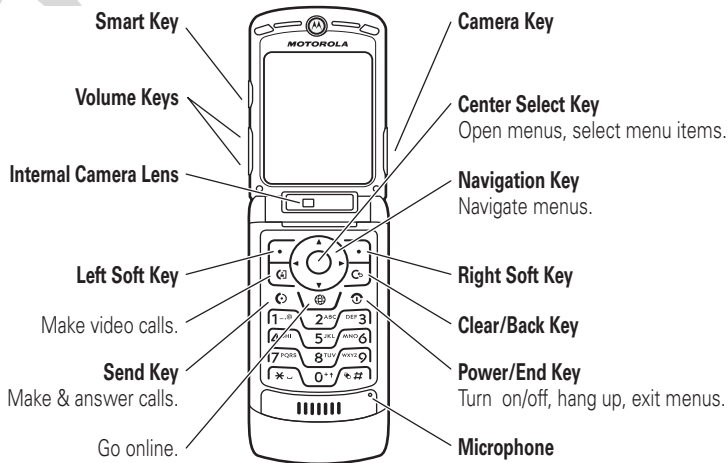

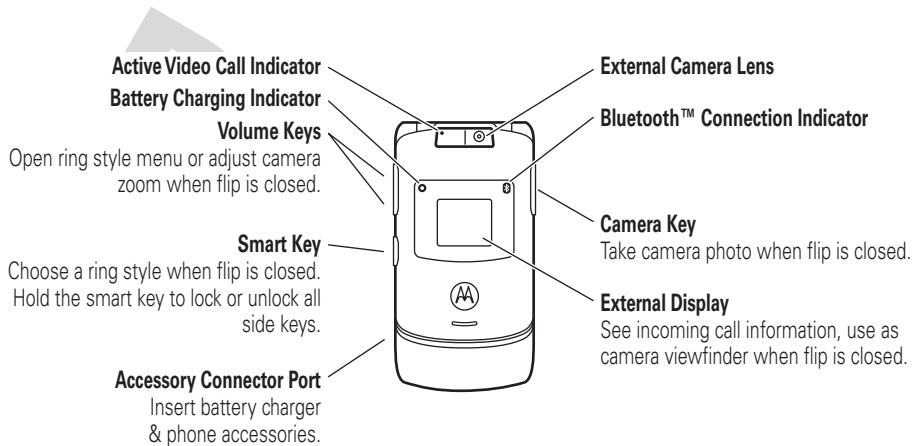

## Home Screen



**1** Press and hold the **Power Key**  for a few seconds or until the display lights up to turn on your phone.

**2** Press the **Center Key**  to open the **Main Menu**.

## Main Menu

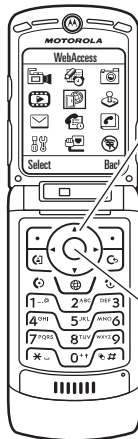

**3** Press the Navigation Key **up, down, left, or right** () to highlight a menu feature.

**4** Press the **Center Key**  to select it.

Motorola, Inc.  
Consumer Advocacy Office  
1307 East Algonquin Road  
Schaumburg, IL 60196

[www.hellomoto.com](http://www.hellomoto.com)

Certain mobile phone features are dependent on the capabilities and settings of your service provider's network. Additionally, certain features may not be activated by your service provider, and/or the provider's network settings may limit the feature's functionality. Always contact your service provider about feature availability and functionality. All features, functionality, and other product specifications, as well as the information contained in this user's guide are based upon the latest available information and are believed to be accurate at the time of printing. Motorola reserves the right to change or modify any information or specifications without notice or obligation.

MOTOROLA and the Stylized M Logo are registered in the US Patent & Trademark Office. All other product or service names are the property of their respective owners. The Bluetooth trademarks are owned by their proprietor and used by Motorola, Inc. under license. Java and all other Java-based marks are trademarks or registered trademarks of Sun Microsystems, Inc. in the U.S. and other countries. Microsoft, Windows and Windows Me are registered trademarks of Microsoft Corporation; and Windows XP is a trademark of Microsoft Corporation.

© Motorola, Inc., 2006.

**Caution:** Changes or modifications made in the radio phone, not expressly approved by Motorola, will void the user's authority to operate the equipment.

### **Software Copyright Notice**

The Motorola products described in this manual may include copyrighted Motorola and third-party software stored in semiconductor memories or other media. Laws in the United States and other countries preserve for Motorola and third-party software providers certain exclusive rights for copyrighted software, such as the exclusive rights to distribute or reproduce the copyrighted software. Accordingly, any copyrighted software contained in the Motorola products may not be modified, reverse-engineered, distributed, or reproduced in any manner to the extent allowed by law. Furthermore, the purchase of the Motorola products shall not be deemed to grant either directly or by implication, estoppel, or otherwise, any license under the copyrights, patents, or patent applications of Motorola or any third-party software provider, except for the normal, non-exclusive, royalty-free license to use that arises by operation of law in the sale of a product.

Manual Number: 68XXXXX148-0

# contents

---

<b>menu map</b> . . . . .	<b>7</b>	<b>main attractions</b> . . . . .	<b>23</b>	handsfree speaker . . .	52
<b>Safety Information</b> . . . . .	<b>9</b>	Bluetooth™ wireless .	23	codes & passwords . .	52
<b>Use and Care</b> . . . . .	<b>14</b>	audio player . . . . .	29	lock & unlock phone . .	52
<b>EU Conformance</b> . . . . .	<b>15</b>	photos . . . . .	31	<b>customize</b> . . . . .	<b>54</b>
<b>Recycling Information</b> .	<b>16</b>	videos . . . . .	33	ring style . . . . .	54
<b>essentials</b> . . . . .	<b>17</b>	video calls . . . . .	35	time & date . . . . .	55
about this guide . . . . .	17	text messages . . . . .	36	wallpaper . . . . .	56
SIM card . . . . .	17	memory card . . . . .	38	screen saver . . . . .	56
battery . . . . .	18	cable connections . . .	40	themes . . . . .	57
turn it on & off . . . . .	20	phone updates . . . . .	42	display appearance . . .	57
make a call . . . . .	21	<b>basics</b> . . . . .	<b>43</b>	answer options . . . . .	58
answer a call . . . . .	21	display . . . . .	43	<b>calls</b> . . . . .	<b>59</b>
store a phone number	21	text entry . . . . .	46	turn off a call alert . . .	59
call a stored phone		volume . . . . .	50	recent calls . . . . .	59
number . . . . .	21	navigation key . . . . .	51	redial . . . . .	60
your phone number . .	22	smart key . . . . .	51	return a call . . . . .	61
		external display . . . . .	51	caller ID . . . . .	61

emergency calls . . . . .	62	<b>index</b> . . . . .	<b>99</b>
voicemail . . . . .	62		
<b>other features . . . . .</b>	<b>64</b>		
advanced calling . . . . .	64		
phonebook . . . . .	69		
messages . . . . .	74		
instant messaging . . . . .	77		
personalizing . . . . .	79		
call times & costs . . . . .	80		
handsfree . . . . .	81		
data calls . . . . .	82		
network . . . . .	84		
personal organizer . . . . .	85		
security . . . . .	87		
fun & games . . . . .	88		
<b>service and repairs . . . . .</b>	<b>92</b>		
<b>SAR Data . . . . .</b>	<b>93</b>		
<b>Warranty . . . . .</b>	<b>94</b>		
<b>WHO Information . . . . .</b>	<b>98</b>		



# menu map

## main menu



### Video Camera



### Tools

- USIM \*
- Calculator
- Datebook
- Alarm Clock
- Dialing Services
  - Fixed Dial \*
  - Service Dial \*
  - Quick Dial
- Activation List
- Messenger \*
- Voice Message
- World Clock



### Camera



### Multimedia

- Media Finder
  - Music
  - Pictures
  - Videos
  - Voice Records
  - Ring Tones
  - Wallpapers
- Themes
- Camera
- Video Camera
- Voice Record



### Web Access

- Browser
- Bookmarks
- History
- Go To Page
- Browser Setup
- Web Sessions \*



### Games & Apps



### Messages

- Create Message
- Voicemail
- Message Inbox
- Email Msgs
- Hot Messages
- Browser Messages
- Info Services \*
- Outbox
- Drafts
- Templates



### Recent Calls

- (press the  or  to scroll through the call lists)



### Phonebook



### Settings

- (see next page)



### Connection

- Bluetooth™ Link
- USB Settings
- MOTOSYNC™ \*



### Airplane Mode

- Airplane Mode
- Prompt at Startup

\* optional features

This is the standard main menu layout. Your phone's menu may be a little different.

## settings menu



### Personalize

- Home Screen
- Main Menu
- Voice Dial Setup
- Skin
- Greeting
- Wallpaper
- Screen Saver



### Ring Styles

- Style
- style Detail



### Connection

- Bluetooth™ Link
- USB Settings
- MOTOSYNC™ \*



### Call Forward \*

- Voice Calls
- Video Calls
- Cancel All
- Forward Status
- Push to Call Fwd No.



### In-Call Setup

- In-Call Timer
- Call Cost Setup \*
- My Caller ID
- Answer Options
- Call Waiting
- MSG Alert

\* optional features



### Initial Setup

- Time and Date
- Speed Dial
- Auto Redial
- Display Timeout
- Backlight
- Charging Lights
- TTY Setup \*
- Scroll
- Language
- Battery Save
- Brightness
- DTMF
- Master Reset
- Master Clear



### Phone Status

- My Tel. Numbers
- Credit Info/Available \*
- Active Line \*
- Battery Meter
- Download Location
- Storage Devices
- Voice Dial Languages
- Software Update \*
- Other Information



### Headset

- Auto Answer
- Ringer Options
- Voice Dial



### Car Settings

- Auto Answer
- Auto Handsfree
- Power-Off Delay
- Charger Time



### Network

- New Network
- Network Setup
- Available Networks
- My Network List \*
- Service Tone
- Call Drop Tone



### Security

- Phone Lock
- Keypad Lock
- Lock Application
- Show Private Entries
- Fixed Dial \*
- Restrict Calls \*
- Call Barring \*
- SIM PIN
- New Passwords
- Certificate Mgmt \*



### Java™ Settings

- Java System
- Delete All Apps
- App Vibration
- App Volume
- App Priority \*
- App Backlight
- Set Standby App \*
- DNS IP \*



### Airplane Mode

- Airplane Mode
- Prompt at Startup

# Safety and General Information

---

**This section contains important information on the safe and efficient operation of your mobile device. Read this information before using your mobile device.\***

## Exposure to Radio Frequency (RF) Energy

Your mobile device contains a transmitter and receiver. When it is ON, it receives and transmits RF energy. When you communicate with your mobile device, the system handling your call controls the power level at which your mobile device transmits.

Your Motorola mobile device is designed to comply with local regulatory requirements in your country concerning exposure of human beings to RF energy.

## Operational Precautions

For optimal mobile device performance and to be sure that human exposure to RF energy does not exceed the guidelines set forth in

the relevant standards, always follow these instructions and precautions.

### External Antenna Care

If your mobile device has an external antenna, use only a Motorola-supplied or approved replacement antenna. Use of unauthorized antennas, modifications, or attachments could damage the mobile device and/or may result in your device not complying with local regulatory requirements in your country.

**DO NOT** hold the external antenna when the mobile device is IN USE. Holding the external antenna affects call quality and may cause the mobile device to operate at a higher power level than needed.

### Product Operation

When placing or receiving a phone call, hold your mobile device just like you would a landline phone.

If you wear the mobile device on your body, always place the mobile device in a Motorola-supplied or approved clip, holder, holster, case, or body harness. If you do not use a body-worn accessory supplied or approved by Motorola, keep the mobile device and its antenna at least 2.5 centimeters (1 inch) from your body when transmitting.

---

\* The information provided in this document supersedes the general safety information in user's guides published prior to May 1, 2006.

When using any data feature of the mobile device, with or without an accessory cable, position the mobile device and its antenna at least 2.5 centimeters (1 inch) from your body.

Using accessories not supplied or approved by Motorola may cause your mobile device to exceed RF energy exposure guidelines. For a list of Motorola-supplied or approved accessories, visit our Web site at: [www.motorola.com](http://www.motorola.com).

## RF Energy Interference/Compatibility

Nearly every electronic device is subject to RF energy interference from external sources if inadequately shielded, designed, or otherwise configured for RF energy compatibility. In some circumstances your mobile device may cause interference with other devices.

### Follow Instructions to Avoid Interference Problems

Turn off your mobile device in any location where posted notices instruct you to do so. These locations include hospitals or health care facilities that may be using equipment that is sensitive to external RF energy.

In an aircraft, turn off your mobile device whenever instructed to do so by airline staff. If your mobile device offers an airplane mode or similar feature, consult airline staff about using it in flight.

## Pacemakers

If you have a pacemaker, consult your physician before using this device.

Persons with pacemakers should observe the following precautions:

- ALWAYS keep the mobile device more than 20 centimeters (8 inches) from your pacemaker when the mobile device is turned ON.
- DO NOT carry the mobile device in the breast pocket.
- Use the ear opposite the pacemaker to minimize the potential for interference.
- Turn OFF the mobile device immediately if you have any reason to suspect that interference is taking place.

## Hearing Aids

Some mobile devices may interfere with some hearing aids. In the event of such interference, you may want to consult your hearing aid manufacturer or physician to discuss alternatives.

## Other Medical Devices

If you use any other personal medical device, consult your physician or the manufacturer of your device to determine if it is adequately shielded from RF energy.

## Driving Precautions

Check the laws and regulations on the use of mobile devices in the area where you drive. Always obey them.

When using your mobile device while driving, please:

- Give full attention to driving and to the road. Using a mobile device may be distracting. Discontinue a call if you can't concentrate on driving.
- Use handsfree operation, if available.
- Pull off the road and park before making or answering a call if driving conditions so require.

Responsible driving practices can be found in the "Smart Practices While Driving" section at the end of this guide and/or at the Motorola Web site: [www.motorola.com/callsmart](http://www.motorola.com/callsmart).

## Operational Warnings

Obey all posted signs when using mobile devices in public areas, such as health care facilities or blasting areas.

### Automobile Air Bags

Do not place a mobile device in the air bag deployment area.

### Potentially Explosive Atmospheres

Areas with potentially explosive atmospheres are often but not always posted, and can include fueling areas such as below decks

on boats, fuel or chemical transfer or storage facilities, or areas where the air contains chemicals or particles, such as grain, dust, or metal powders.

When you are in such an area, turn off your mobile device, and do not remove, install, or charge batteries. In such areas, sparks can occur and cause an explosion or fire.

## Damaged Products

If your mobile device or battery has been submerged in water, punctured, or subjected to a severe fall, do not use it until you take it to a Motorola Authorized Service Center. Do not attempt to dry it with an external heat source, such as a microwave oven.







## Batteries and Chargers

If jewelry, keys, beaded chains, or other conductive materials touch exposed battery terminals, this could complete an electrical circuit (short circuit), become very hot, and could cause damage or injury. Be careful when handling a charged battery, particularly when placing it inside a pocket, purse, or other container with metal objects. **Use only Motorola Original batteries and chargers.**

**Caution:** To avoid risk of personal injury, do not dispose of your battery in a fire.

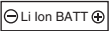

Your battery, charger, or mobile device may contain symbols, defined as follows:

Symbol	Definition
	Important safety information follows.
	Do not dispose of your battery or mobile device in a fire.
	Your battery or mobile device may require recycling in accordance with local laws. Contact your local regulatory authorities for more information.
	Do not throw your battery or mobile device in the trash.
	Your mobile device contains an internal lithium ion battery.
	Do not let your battery, charger, or mobile device get wet.
	Listening at full volume to music or voice through a headset may damage your hearing.

## Choking Hazards

Your mobile device or its accessories may include detachable parts, which may present a choking hazard to small children. Keep your mobile device and its accessories away from small children.

## Glass Parts

Some parts of your mobile device may be made of glass. This glass could break if the product is dropped on a hard surface or receives a substantial impact. If glass breaks, do not touch or attempt to remove. Stop using your mobile device until the glass is replaced by a qualified service center.

## Seizures/Blackouts

Some people may be susceptible to epileptic seizures or blackouts when exposed to flashing lights, such as when playing video games. These may occur even if a person has never had a previous seizure or blackout.

If you have experienced seizures or blackouts, or if you have a family history of such occurrences, please consult with your physician before playing video games or enabling a flashing-lights feature (if available) on your mobile device.

Discontinue use and consult a physician if any of the following symptoms occur: convulsion, eye or muscle twitching, loss of awareness, involuntary movements, or disorientation. It is always a good idea to hold the screen away from your eyes, leave the

lights on in the room, take a 15-minute break every hour, and stop use if you are very tired.

## Caution About High Volume Usage



Listening at full volume to music or voice through a headset may damage your hearing.

## Repetitive Motion

When you repetitively perform actions such as pressing keys or entering finger-written characters, you may experience occasional discomfort in your hands, arms, shoulders, neck, or other parts of your body. If you continue to have discomfort during or after such use, stop use and see a physician.

# Use and Care

---

To care for your Motorola phone, please keep it away from:



## liquids of any kind

Don't expose your phone to water, rain, extreme humidity, sweat, or other moisture.



## dust and dirt

Don't expose your phone to dust, dirt, sand, food, or other inappropriate materials.



## extreme heat or cold

Avoid temperatures below -10°C/14°F or above 45°C/113°F.



## cleaning solutions

To clean your phone, use only a dry soft cloth. Don't use alcohol or other cleaning solutions.



## microwaves

Don't try to dry your phone in a microwave oven.



## the ground

Don't drop your phone.



# European Union Directives Conformance Statement

---



Hereby, Motorola declares that this product is in compliance with

- The essential requirements and other relevant provisions of Directive 1999/5/EC
- All other relevant EU Directives

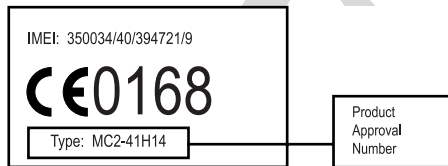

The above gives an example of a typical Product Approval Number.

You can view your product's Declaration of Conformity (DoC) to Directive 1999/5/EC (to R&TTE Directive) at [www.motorola.com/rtte](http://www.motorola.com/rtte). To find your DoC, enter the product Approval Number from your product's label in the "Search" bar on the web site.

# Caring for the Environment by Recycling

---



This symbol on a Motorola product means the product should not be disposed of with household waste.

## Disposal of your Mobile Telephone and Accessories

---

Please do not dispose of mobile telephones or electrical accessories, such as chargers or headsets, with your household waste. In some countries or regions, collection systems have been set up to handle waste electrical and electronic items. Please contact your regional authorities for more details. If no suitable scheme exists, you may return unwanted mobile telephones and electrical accessories to any Motorola Approved Service Centre in your region.

# essentials







---

## about this guide

This guide shows how to open a menu feature as follows:

**Find it:**  >  **Messages** > **Create Message**

This means that, from the home screen:

- 1 Press the *center key*  to open the menu.
- 2 Press the *navigation key*  to scroll to  **Messages**, and press the *center key*  to select it.
- 3 Press the navigation key  to scroll to **Create Message**, and press the center key  to select it.

### symbols



This means a feature is network, SIM card, or subscription dependent and may not be available in all areas. Contact your service provider for more information.



This means a feature requires an optional accessory.

## SIM card

**Caution:** Don't bend or scratch your SIM card. Keep it away from static electricity, water, and dirt.

Your *Subscriber Identity Module* (SIM) card contains personal information like your phone

number and phonebook entries. It can also contain your voicemail, text message, and Internet access settings. If you put your SIM card in another phone, that phone uses your phone number.

To insert and use a **memory card**, see page 38.

**Turn off your phone and remove your battery before you install or remove a SIM card.**

1

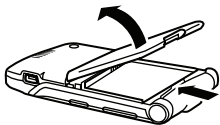

2

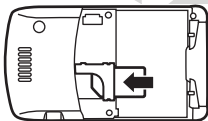

## battery

### battery tips

Battery life depends on the network, signal strength, temperature, features, and accessories you use.

- Always use Motorola Original batteries and chargers. The warranty does not cover damage caused by non-Motorola batteries and/or chargers.
- New batteries or batteries stored for a long time may take more time to charge.
- When charging your battery, keep it near room temperature.



When storing your battery, keep it uncharged in a cool, dark, dry place.

- Never expose batteries to temperatures below  $-10^{\circ}\text{C}$  ( $14^{\circ}\text{F}$ ) or above  $45^{\circ}\text{C}$  ( $113^{\circ}\text{F}$ ). Always take your phone with you when you leave your vehicle.
- It is normal for batteries to gradually wear down and require longer charging times. If you notice a change in your battery life, it is probably time to purchase a new battery.



Contact your local recycling center for proper battery disposal.

**Warning:** Never dispose of batteries in a fire because they may explode.

Before using your phone, read the battery safety information in the “Safety and General Information” section included in this guide.

## battery installation

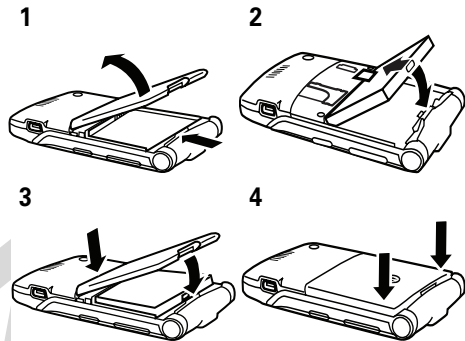

## battery charging

New batteries are not fully charged. Plug the battery charger into your phone and an electrical outlet.

Your phone might take

several seconds to start charging the battery. Your display shows **Charge Complete** when finished.

**Tip:** Relax, you can't overcharge your battery. It will perform best after you fully charge and discharge it a few times.

The battery charger shipped with this device is designed for Motorola 3G mobile phones. Other chargers might take longer to charge

Battery Charging Indicator

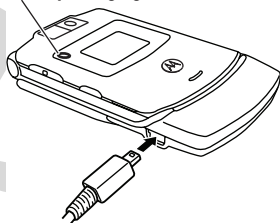

your battery, or cause your calls to fail during charging.

## turn it on & off

**Caution:** Some phones ask for your SIM card PIN code when you turn them on. If you enter an incorrect PIN code three times before the correct code, your SIM card is disabled, and your display shows **SIM Blocked**. Contact your service provider.

**To turn on your phone,**

press and hold  for a few seconds or until the keypad or display lights up. If

prompted, enter your eight-digit SIM card PIN code and/or four-digit unlock code.



**To turn off your phone,** press and hold  for a few seconds.

## make a call

Enter a phone number and press  to make a call.

To “hang up,” close the flip or press .

To make video calls, see page 35.

## answer a call

When your phone rings and/or vibrates, just open the flip or press  to answer.

To “hang up,” close the flip or press .

## store a phone number

You can store a phone number in your **Phonebook**:

- 1 Enter a phone number in the home screen.



- 2 Press the **Store** key.

Select **Create New Contact**, if necessary.



- 3 Enter a name and other details for the phone number. To select a highlighted item, press the *center key* .

- 4 Press the **Done** key to store the number.

To edit or delete a **Phonebook** entry, see page 70.

To store an email address from the home screen, press  >  **Phonebook** > **New Entry**. Enter the new contact's name and **Email** information.



## call a stored phone number

**Find it:**  >  **Phonebook**



- 1 Scroll to the phonebook entry.

**Shortcut:** In the phonebook, press keypad keys to enter the first letters of an entry you want.



2 Press  to call the entry.

**Note:** Your phonebook can show you the entries stored in your phone's memory or on your SIM card. To choose which entries you see, press  >  **Phonebook**, then press **Options** > **View**. You can select **Phone & SIM Card**, **SIM Card**, or **Phone Contacts**.

## your phone number

From the home screen, press *the clear key*  then  to see your number.

**Tip:** Want to see your phone number while you're on a call? Press **Options** > **My Tel. Number**.

You can edit the name and phone number stored on your SIM card. From the home screen, press  , select an entry, press the **View** key, press the **Options** key, and select **Edit**. If you don't know your phone number, contact your service provider.





# main attractions

---

You can do much more with your phone than make and receive calls!

## Bluetooth™ wireless

Your phone supports Bluetooth wireless connections. You can connect your phone with a Bluetooth headset or car kit to make handsfree calls. You can also connect your phone with a phone or computer that supports Bluetooth connections to exchange files.

You can also use Bluetooth™ A2DP stereo headphones to listen to music files you store on your phone.

**Note:** The use of wireless phones while driving may cause distraction. Discontinue a

call if you can't concentrate on driving. Additionally, the use of wireless devices and their accessories may be prohibited or restricted in certain areas. Always obey the laws and regulations on the use of these products.

**For maximum Bluetooth security**, you should always connect Bluetooth devices in a safe, private environment.

## use a headset or handsfree car kit

**Before you try to connect your phone with a handsfree device**, make sure the device is **on** and **ready** in *pairing* or *bonding* mode (see the user's guide for the device).

**Find it:**  >  Settings > Connection  
> Bluetooth Link > [Add Audio Device]



Your phone lists the devices it finds within range.

- 1 Scroll to a device in the list and press the *center key* .
- 2 Press the **Yes** or **OK** key to connect to the device.
- 3 If necessary, enter the device passkey (such as **0000**) and press the **OK** key.

When your phone is connected, the Bluetooth indicator  shows in the home screen.

You cannot play some copyrighted files over a Bluetooth connection.

**Shortcut:** When Bluetooth power is on, your phone can automatically connect to a handsfree device you have used before. Just

turn on the device or move it near the phone. During a call or while playing a sound file, you can press **Options** > **Use Bluetooth** to connect to a headset or handsfree device you have used before.

**Tip:** Want to know more about your headset or car kit? For specific information about a device, refer to the instructions that came with it.

## copy files to another device

You can copy a media file, phonebook entry, datebook event, or Web shortcut from your phone to a computer or other device.



**Note:** You can't copy some copyrighted objects.

- 1 On your phone, scroll to the object that you want to copy to the other device.





- 2 Press **Options**, then select:
  - **Manage > Copy** for media files.
  - **Send Contact** for phonebook entries.
  - **Send** for datebook events.
- 3 Select a recognized device name, or **[Look For Devices]** to search for the device where you want to copy the file.

**If your phone could not copy the file to the other device**, make sure the device is **on** and **ready** in *discoverable* mode (see the user's guide for the device). Also, make sure the device is not busy with another similar Bluetooth connection.



**Note:** Once you connect your phone to a Bluetooth device, that device can start similar Bluetooth connections with your phone. Your display shows the Bluetooth indicator  at the top when there is a Bluetooth connection.

To change a device's **Access** setting, see page 28.

## receive files from another device

If you do not see the Bluetooth indicator  at the top of your phone display, turn on your phone's Bluetooth feature by pressing  >  **Settings** > **Connection** > **Bluetooth Link** > **Setup** > **Power** > **On**. 

- 1 Place your phone near the device, and send the file from the device.

If your phone and the sending device don't recognize each other, place your phone in discoverable mode so the sending device can locate it. Press  >  **Settings** > **Connection** > **Bluetooth Link** > **Find Me**.

- 2 Press the **Accept** key on your phone to accept the file from the other device.

Your phone notifies you when file transfer is complete. If necessary, press the **Save** key to save the file.

## send files to a printer

You can use a Bluetooth connection to send a picture, message, phonebook entry, or datebook view from your phone to a printer. 

**Note:** You cannot print message **Templates** or a phonebook **Mailing List**.

- 1 On your phone, scroll to the object that you want to print, then press **Options > Print > Bluetooth**. In the datebook, you can print the month, week, or day.





**Tip:** If you see it, you can print it. After you capture a picture in the camera, you can press the **Options** key and select **Print**.



- 2 If available, choose additional objects or print options.
- 3 Select a recognized printer name listed in the **Printers** menu, or **[Look For Devices]** to search for the printer where you want to print the object.



**Note:** If you see **Service Not Supported** when you try to print, select **Options > Manage > Copy > Bluetooth** instead. Always use this option to print 4x6 photos.





## advanced Bluetooth features



A device is *recognized* after you connect to it once (see page 23).

features	
<b>make phone visible to other device</b>	Allow a Bluetooth device to discover your phone:  >  <b>Settings</b> > <b>Connection</b> > <b>Bluetooth Link</b> > <b>Find Me</b>
<b>connect to recognized device</b>	Connect your phone to a recognized handsfree device:  >  <b>Settings</b> > <b>Connection</b> > <b>Bluetooth Link</b> > <b>Audio Devices</b> > <i>device name</i>

features	
<b>drop connection with headset or handsfree device</b>	 >  <b>Settings</b> > <b>Connection</b> > <b>Bluetooth Link</b> > <b>Audio Devices</b> Scroll to the device name and press the <b>Drop</b> key.
<b>switch to headset or handsfree device during call</b>	During a call, press <b>Options</b> > <b>Use Bluetooth</b> to switch to a recognized headset or car kit. Your phone connects automatically, or shows a list of devices you can select.

features	
<b>play sound files on a recognized headset</b>	<p>While playing a sound file, press </p> <p><b>Options</b> &gt; <b>Use Bluetooth</b> to switch to a recognized headset.</p> <p>Your phone connects automatically, or shows a list of devices you can select.</p> <p>You cannot play some copyrighted files over a Bluetooth connection.</p>
<b>move multimedia object to device</b>	<p><b>Caution:</b> Moving an object <b>deletes</b> the original object from your phone.</p> <p>Scroll to the object, press </p> <p><b>Options</b> &gt; <b>Manage</b> &gt; <b>Move</b>, select the device name.</p>



features	
<b>copy multimedia object to device</b>	<p>Scroll to the object, press </p> <p><b>Options</b> &gt; <b>Manage</b> &gt; <b>Copy</b>, select the device name.</p>
<b>edit device properties</b>	<p> &gt;  <b>Settings</b> </p> <p>&gt; <b>Connection</b></p> <p>&gt; <b>Bluetooth Link</b> &gt; <b>Found Devices</b></p> <p>Scroll to the device name and press the <i>center key</i> .</p> <p><b>Note:</b> The <b>Access</b> setting can restrict how this device connects to your phone. You can choose <b>Automatic</b> (always connects), <b>Always Ask</b> (asks you before connecting), <b>Just Once</b>, <b>Never</b>, or <b>Custom</b>.</p>

features	
set	 >  Settings 
Bluetooth	> Connection
options	> Bluetooth Link > Setup

## audio player

Your phone can play and store AU, WMA, and MP3 song files. You can use a removable memory card with your phone to store more songs (see page 38). 



**Find it:**  >  Multimedia > Media Finder > Music

Press  up or down to scroll to an option, and press the *center key*  to select it:

options	
All Songs	Show and play individual songs.  <b>Note:</b> All of your phone's songs appear in this list. Some songs do not have any <b>Artist</b> , <b>Album</b> , or <b>Genre</b> information, so they don't appear in those lists.
Recently Played	Show songs you played recently.
Playlists	Create or play a playlist (see page 31).
Artists	Select an artist to show or play their songs.
Albums	Select an album to show or play its songs.

options	
<b>Genres</b>	Select a type of music to show or play songs.
<b>Composers</b>	Select a composer to show or play songs.

When you select a song:

- **Play or pause** the song by pressing the *center key* .
- **Skip back or forward** by pressing  left or right.
- **Change volume** by pressing the volume keys.
- **Hide the player** by pressing **Options** > **Hide**. This lets you use other phone features while the song plays. To stop the hidden audio player, press  in the home screen.

**Tip:** You can listen to tunes on your way. You can use Bluetooth™ A2DP stereo headphones (page 23), and use *airplane mode* to make your phone safe to use even while you're on a plane (page 91).

Your phone also has a **Ring Tones** player. To use it, press  > **Multimedia** > **Media Finder** > **Ring Tones**.

## load music files

To download songs from the Internet, see page 89. To copy files between your phone and a computer, see page 41.

**Note:** Your phone may not play MP3 files that have a bit rate higher than 128 kbps. If you try to download or play one of these files, your phone might show you an error or ask you to delete the file.



## create a playlist

**Find it:**  >  Multimedia > Media Finder > Music > Playlists > [Create New Playlist]

Open a song list, and press the *center key*  to select each song you want. After you press the **Done** key, enter a name for your list.

To hear your playlist, highlight it under **Playlists** and press **Options** > **Play**.

## play music with your phone closed

You can close your phone while you listen to music. When your phone is closed, the external display shows the song artist, title, and time. While a song is playing:

- **Press the volume keys** to adjust playback volume.

- **Hold the smart key** to lock or unlock the side keys.
- **Press the smart key** to open the audio player menu. Press your volume keys to scroll through the menu, and press the smart key to select a menu item (or pause a song).

## photos

To view, edit, or delete photos you've taken, see page 88.

Your camera lens is on the back of your phone when the phone is open.

1 Press  >  > **Camera** to see the camera viewfinder.

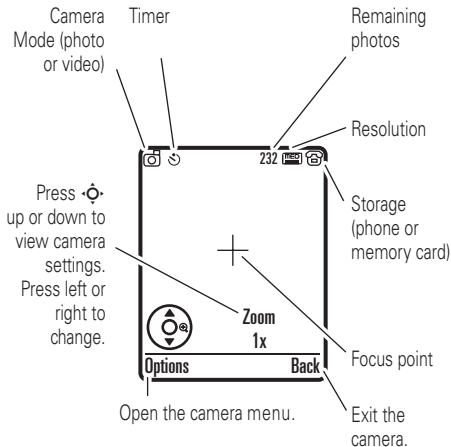

2 Press the *center key*  to take the photo in the viewfinder. You can:

- Press the **Options** key to store or discard the photo.

If you press **Options** > **Print**, you can print the picture over a Bluetooth™ connection (see page 26).

- Press the **Send** key to send the photo in a message.

Your phone might tell you that this is a **Multimedia Msg**, since it has a picture in it. Some other phones or networks do not support picture messages. Press the **Yes** key to send the message.

- Press  to discard the photo and return to the active viewfinder.

Before you capture the photo, you can press **Options** to open the camera menu:

options	
<b>Go To Pictures</b>	See stored pictures and photos.
<b>Go To Video Mode</b>	Switch to the video camera.
<b>Internal / External View</b>	Switch to the camera facing you ( <b>Internal</b> ) or facing away from you ( <b>External</b> ).
<b>Auto-Timed Capture</b>	Set a timer for the camera to take a photo.
<b>Camera Setup</b>	Open the setup menu to adjust photo settings.
<b>Switch Storage Device</b>	Choose to store videos on your phone or a memory card. 

## options

<b>Free Space</b>	See how much memory remains.  <b>Note:</b> Your service provider may store some content in user memory before you receive the phone.
-------------------	--

## self portrait

If you close your phone while the viewfinder is active, the external display shows the image. Press the volume keys to zoom, or press the smart key to capture and store the image.

## videos

To view, edit, or delete videos you've recorded, see page 89.

Your camera lens is on the back of your phone, when your phone is open.

Press  >  **Video Camera** to see the video viewfinder.

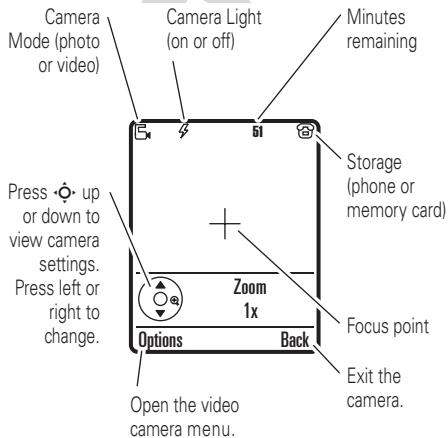



**Note:** The number of minutes remaining is an estimate.

**Tip:** If you want to send your video in a message, the video length must be set to **MMS**. To set length, press **Options > Video Camera Setup > Video Length**.

**1** Press the *center key*  to start recording the video in the viewfinder.

**2** Press the **Stop** key to stop recording the video. You can:

- Press the **Options** key to preview, store, or discard the video.

To play a stored video from the home screen, press  >  **Multimedia** > **Media Finder** > **Videos** > **All Videos** > *video name*.

- Press the **Send** key to send the video in a message. 

Enter text and press **Send To**, then scroll to a recipient address and press the *center key*  to select it. Press the **Options** key to enter a new number. To send the message, press the **Send** key.

**Note:** Some other phones or networks do not support messages with videos.



- Press  to discard the video and return to the active viewfinder.

## video calls

If you call someone who has a 3G video phone, you can see each other while you talk. If your phone is roaming on a **non-3G network**, video calls will not work (see the Roam indicator on page 45). 

**Note:** Your phone's external **video call indicator** blinks during a video call, to let people around you know that they might be in your video.

## make a video call

- 1 Enter a phone number and press  to see the video call preview.
- 2 Press  to make the call.

During the call:

- Press the **Stop Video** key to change the call to a voice call with the speakerphone on.
- If you accept another **incoming voice call**, your phone changes this video call to a voice call.
- If you accept another **incoming video call**, your phone ends this video call.

**3** To end the call, press .

## text messages

To create a group mailing list, see page 72.  
For more message features, see page 74.

### send a text message

A text message can contain text and pictures, sounds, or other media objects. You can add multiple pages to a message, and you can put text and media objects on each page. You can send a message to other compatible phones or to email addresses.

**Find it:**  >  **Messages** > **Create Message**  
> **Message**

**1** Press keypad keys to enter text on the page (for details about text entry, see page 46).

To insert a **picture, sound, or other object** on the page, press **Options** > **Insert**. Select the file type and the file.

To insert **another page** in the message, enter text or objects on the current page and press **Options** > **Insert** > **New Page**. You can enter more text and objects on the new page.

- 2** When you finish the message, press the key.
- 3** To **send** the message, press the **Send** key.

### receive a text message

When you receive a message, your phone plays an alert, and the display shows **New Message** with a message indicator, such as .

Press the **Read** key to open the message.

If a multimedia message contains media objects:

- Photos, pictures, and animations show as you read the message.
- A sound file plays when its slide shows. Use the volume keys to adjust the sound volume.
- Attached files are added to the end of the message. To open an attachment, scroll to the file indicator/filename and press the **View** key (image), **Play** key (sound), or **Open** key (phonebook vCard, datebook vCalendar entry, or unknown file type).



## manage text messages

You can sort and move your messages.

**Find it:**  >  Messages > Message Inbox





Scroll to a message and press the **Options** key. Your options include:

options	
<b>Sort by</b>	Sort messages by <b>Time</b> , <b>Sender</b> , <b>Priority</b> , or other details. <b>Note:</b> You can also sort the messages in your <b>Email Msgs</b> and <b>Outbox</b> lists.
<b>Move to Hot Messages</b>	Move the selected message your <b>Hot Messages</b> list, where you can keep your most important messages. To see your <b>Hot Messages</b> list:  >  Messages > Hot Messages

## options

**Mark / Unmark as SPAM** Mark the selected message with a SPAM icon.

**Note:** To turn on a SPAM filter, press  >  **Messages**, then press > **Options** > **Setup** > **Message Setup** > **SPAM Filter** > **On**. This automatically adds a SPAM icon and turns off notification for new messages from anyone not in your phonebook.

## memory card

You can use a removable memory card with your phone to store and retrieve multimedia objects (such as photos and sounds).



**Note:** If you download a copyrighted file and store it on your memory card, you can use the

file only while your memory card is inserted in your phone. You cannot send, copy, or change copyrighted files.

## install a memory card

- 1 Remove the battery door.
- 2 Push the card into the metal holder until it clicks into place.

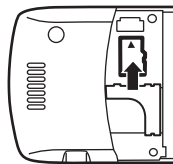

**To remove the memory card**, push it in until it clicks again. It begins to slide out, and you can slide it the rest of the way out.

- 3 Replace the battery door.



## see and change memory card information

To **see the files** stored on your memory card and on your phone, open a file list, such as **Pictures** (see page 88). Icons can indicate if a file is stored in your phone memory (📁) or on your memory card (📁). To copy or move a file from your phone to your memory card, highlight it in the list and press **Options > Manage > Copy** or **Move > Memory Card**. You cannot copy or move some copyrighted files.

To **copy files** between your memory card and a computer, you can use a cable connection (see page 41) or a Bluetooth connection (see page 24).

To see your **memory card name, available memory**, and other information about the card:

**Find it:** 📶 > ⚙️ **Settings** > **Phone Status**  
> **Storage Devices**

- 1 Press 📶 to scroll to the memory card that is installed.
- 2 Press the *center key* 📶 to see the memory card information. Your phone stores any content that you add, like ring tones or games, in *user memory*. Your service provider may store some content in user memory before you receive the phone.

**or**

Press **Options** to see the **Storage Device** menu, which lets you **Format** or **Rename** the memory card.

## store and use protected content

If you try to play a copyrighted file, it might ask you to download a license. Some licenses

only let you play a file for a certain number of times or days. You cannot send, copy, or change copyrighted files.

For example, a license may allow you to play the content of your download five times or use the content for three days before it expires.

To download a file, see page 89. To activate downloaded copyrighted files:

**Find it:**  >  **Tools** > **Activation List** > *file type*  
> *file*

You can see file's **Status**, **Type**, **Activation**, and **Counts Remaining**.

## cable connections

 Your phone has a mini-USB port so you can connect it to a computer to transfer data.

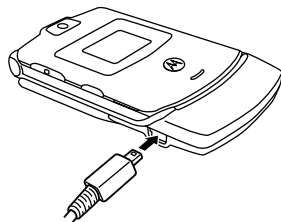

### **Note:** Motorola

Original USB data cables and supporting software may be sold separately. Check your computer or hand-held device to determine the type of cable you need. To make **data calls** through a connected computer, see page 82.





## connect your memory card to a computer

You can use a cable connection to access your phone's memory card with a PC.

**Note:** When your phone is connected to a computer, you can only access the memory card through the computer.

### On your phone:

**Disconnect the cable** from your phone, if it is connected, then press  >  **Settings**  
> **Connection** > **USB Settings** > **Default Connection**  
> **Memory Card**.

This directs the USB connection to your memory card.

**Connect the cable** to your phone and to an available USB port on your computer. Then follow these steps:

### On your computer:

- 1 Open your "My Computer" window, where your phone's memory card shows as a "Removable Disk" icon.
- 2 Click on the "Removable Disk" icon to access the files on your phone's memory card.
- 3 To store the desired files onto the memory card, drag and drop them as follows:  
**audio files:** > mobile > audio  
**screen savers:** > mobile > picture  
**wallpapers:** > mobile > picture  
**video clips:** > mobile > video
- 4 When you finish, disconnect your phone by selecting the "Safely Remove Hardware" icon in the system tray at the bottom of your computer screen. Then disconnect the "USB Mass Storage Device."

- 5 Disconnect the cable from your phone and computer.

### On your phone:

To return to **Data** as your USB default connection, press  >  **Settings** > **Connection** > **USB Settings** > **Default Connection** > **Data Connection**.

## phone updates

Sometimes we think of ways to make your phone's software faster or more efficient after you've purchased your phone. You can find out if your phone can be updated and register for free update notifications at: <http://www.hellomoto.com/support/update>



**Note:** Software updates do not affect your phonebook entries or other personal entries. If you receive a software update but choose to install it later, see page 84.

# basics

---

See page 1 for a basic phone diagram.

## display

The *home screen* shows when you turn on the phone.

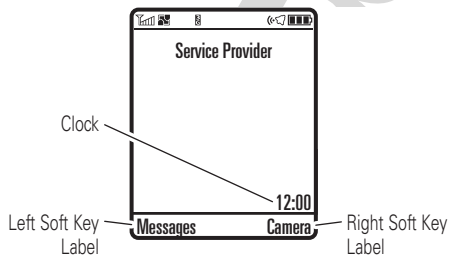

**Note:** Your home screen might look different from the one shown, depending on your service provider.



To dial a number from the home screen, press number keys and .

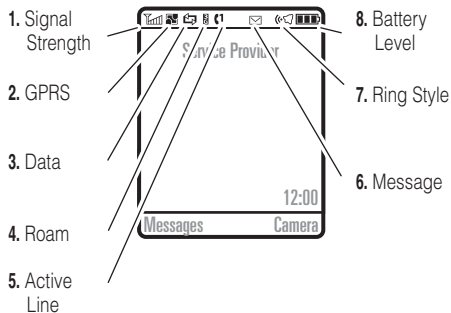

Press  up, down, left, or right in the home screen to open basic menu features.

Press the *center key*  to open the menu. *Soft Key Labels* show the current soft key functions. For soft key locations, see page 1.

Status indicators can show at the top of the home screen:



- 1 **Signal Strength Indicator** – Vertical bars show the strength of the network connection. You can't make or receive calls when  or  shows.
- 2 **GPRS Indicator** – Shows when your phone is using a high-speed *General Packet Radio Service* (GPRS) 

network connection. Indicators show PDP context active  or packet data available .

- 3 **Data Indicator** – Shows connection status. 

 secure packet data transfer

 unsecure packet data transfer

 secure application connection

 unsecure application connection

 secure *Circuit Switch Data* (CSD) call

 unsecure CSD call

 *High-Speed Downlink Packet Access* (HSDPA) data transfer

 Bluetooth™ connection is active

- 4 Roam Indicator** – Shows when your phone is seeking or using a network outside your home network. Indicators can include:



 2G home

 2G roam

 2.5G home

 2.5G roam



 3G home

 3G roam

 HSDPA home

 HSDPA roam

HSDPA is *High-Speed Downlink Packet Access*, available on some networks.

- 5 Active Line Indicator** – Shows  to indicate an active call, or  to indicate when call forwarding is on.





Indicators for dual-line-enabled SIM cards can include:

 line 1 active

 line 1 active, call forward on

 line 2 active

 line 2 active, call forward on

When an alarm is activated,  can show here.

- 6 Message Indicator** – Shows when you receive a new message. Indicators can include:



 text message

 voice message

 IM message

**7 Ring Style Indicator** – Shows the ring style setting.



**8 Battery Level Indicator** – Vertical bars show the battery charge level. Recharge the battery when your phone shows **Low Battery**.

## text entry

Some features let you enter text.

For indicator descriptions, see following section.

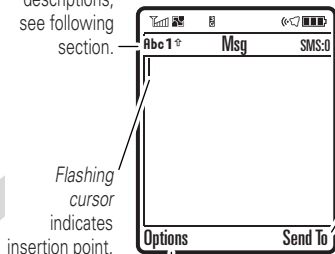

After you enter text, press the **Send To** key to enter recipients.

Press the **Options** key to open the sub-menu.



Press **#** in a text entry view to select an entry mode:

entry modes	
<b>1</b> or <b>1</b>	Your <b>Primary</b> text entry mode can be set to any iTAP™ <b>1</b> or tap <b>1</b> mode.
<b>2</b> or <b>2</b>	Your <b>Secondary</b> text entry mode can be set to any iTAP™ <b>2</b> or tap <b>2</b> mode, or set to <b>None</b> if you don't want a secondary entry mode.
<b>123</b>	<b>Numeric</b> mode enters numbers only.
<b>@%</b>	<b>Symbol</b> mode enters symbols only.

To set your primary and secondary text entry modes, press **Options > Text Setup** in a text entry view and select **Primary Text** or **Secondary Text**.

### iTAP™ and Tap mode tips

- Press **0** in a text entry view to change text case to all capital letters

(**ABC**), no capitals (**abc**), or next letter capital (**Abc**).

- To enter numbers quickly, press and hold a number key to temporarily switch to numeric mode. Press the number keys to enter the numbers you want. Enter a space to change back to iTAP or Tap mode.
- Press **1** to enter punctuation or other characters.
- Press **⦿** to move the flashing cursor to enter or edit message text.
- Press **C** to delete the character to the left of the cursor. Hold **C** to delete the word.
- To cancel your message, press **⏏**.

## iTAP™ mode

Press **#** in a text entry view to switch to iTAP mode. If you don't see **1** or **2**, press **Options > Text Setup** to set iTAP mode as your primary or secondary text entry mode.

iTAP mode lets you enter words using one keypress per letter. The iTAP software combines your keypresses into common words and predicts each word as you enter it.

For example, if you press **7 7 6 4**, your display shows:

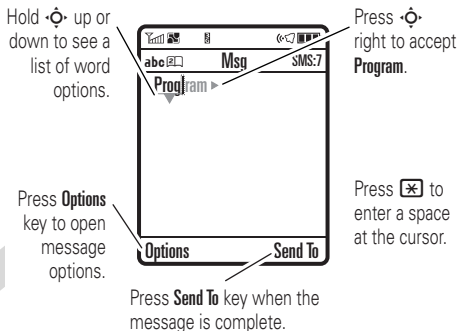

If you want a different word (such as **Progress**), continue pressing keypad keys to enter the remaining letters.

**Tip:** Don't worry if you forget how iTAP works. In a text entry display, you can press

**Options** > **Text Setup** > **Text Tutorial** to see an explanation.

## tap and tap extended modes

Press **#** in a text entry view to switch to tap mode. If you don't see **Abc 1** or **Abc 2**, press **Options** > **Text Setup** to set tap mode as your primary or secondary text entry mode.

To enter text in **Tap** mode, press a keypad key repeatedly to cycle through the letters and number on the key. Repeat this step to enter each letter. The **Tap Extended** mode works the same way, but includes more special characters and symbols.

For example, if you press **7** one time, your display shows:

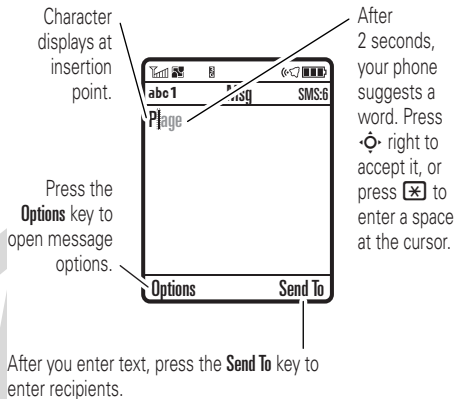

The first character of every sentence is capitalized. If necessary, press **⬇** down to change the character to lowercase before the cursor moves to the next position.

## numeric mode

Press **#** in a text entry view until you see **123**. Press the number keys to enter the numbers you want.

**Shortcut:** You can press and hold a number key to temporarily switch to numeric mode from iTAP™ or Tap modes. Press the number keys to enter the numbers you want. Enter a space to change back to iTAP mode.

## symbol mode

Press **#** in a text entry view until your phone shows a list of symbols. Scroll to the symbol you want, then press the *center key* .

## volume

Press the volume keys to:

- turn off an incoming call alert
- change the earpiece volume during calls
- change the ringer volume from the home screen

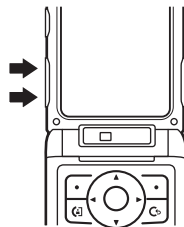

**Tip:** Sometimes silence really is golden. That's why you can quickly set your ringer to **Vibrate** or **Silent** by holding the down volume key while you are in the home screen. You can also switch to **Silent** or back by holding **#** in the home screen.

To change your ringer volume when your phone is closed, see page 51.



## navigation key

Press the *navigation key*  up, down, left, or right to scroll to items in the display.

When you scroll to an item, press the *center key*  to select it.



## smart key

The smart key gives you another way to do things. For example, when you scroll to a menu item, you can press the smart key to select it (instead of pressing the *center key* ). The smart key usually does the same thing as pressing the *center key* . To find the smart key, see page 1. To change what the smart key does in the home screen, see page 80.

## external display

When you close your phone, the external display shows the date, status indicators, and notifications for incoming calls and other events. For a list of phone status indicators, see page 44.

### set phone ring style in external display

- 1 Press a volume key to see **Ring Styles**.
- 2 Press the smart key repeatedly, until the style you want appears.
- 3 Press a volume key to return to the home screen.

## handsfree speaker

You can use your phone's handsfree speaker to make calls without holding the phone to your ear.

During a call, press the **Options** key and select **Speakerphone On** to turn the handsfree speaker on. Your display shows **Speakerphone On** until you turn it off or end the call.

**Note:** The handsfree speaker won't work when your phone is connected to a handsfree car kit or headset.

## codes & passwords

Your phone's four-digit **unlock code** is originally set to **1234**. The six-digit **security code** is originally set to **000000**. If your service provider didn't change these codes, you should change them:

**Find it:**  >  **Settings** > **Security**  
> **New Passwords**

You can also change your **SIM PIN** or call barring passwords.



**If you forget your unlock code:** At the **Enter Unlock Code** prompt, try entering 1234 or the last four digits of your phone number. If that doesn't work, press  and enter your six-digit security code instead.

**If you forget other codes:** If you forget your security code, SIM PIN code, PIN2 code, or call barring password, contact your service provider.

## lock & unlock phone

You can lock your phone to keep others from using it. To lock or unlock your phone, you need the four-digit unlock code.

To **manually lock** your phone:

Press  >  **Settings** > **Security** > **Phone Lock**  
> **Lock Now**.

To **automatically lock** your phone whenever you turn it off: Press  >  **Settings** > **Security**  
> **Phone Lock** > **Automatic Lock** > **On**.

**Note:** You can make emergency calls on a locked phone (see page 62). A locked phone still rings or vibrates for incoming calls or messages, **but you need to unlock it to answer**.

# customize

---

## ring style



Each ring style profile uses a different set of sounds or vibrations for incoming calls and other events. Here are the profiles you can choose:

 Loud     Vibrate     Vibe Then Ring  
 Soft     Vibe & Ring     Silent

The ring style profile's indicator shows at the top of your home screen. To choose your profile:

**Find it:**  >  **Settings** > **Ring Styles**  
> **Style:** *style name*

**Shortcut:** In the **home screen**, press the volume keys up or down to quickly change your ring style profile. With your **phone closed**, press a volume key to see your ring style profile, press the smart key to change it, then press a volume key to store the change.

**Tip:** Do you get a lot of text messages? If you don't want to hear incoming message alerts during phone calls, press  >  **Settings** > **In-Call Setup** > **MSG Alert** > **Not in Call**.

## change alerts in a ring style

You can change the alerts for incoming calls and other events. Your changes are saved in the current ring style profile.



**Find it:**  >  **Settings** > **Ring Styles**  
> *style Detail*

**Note:** *Style* represents the current ring style. You can't set an alert for the **Silent** ring style setting.



- 1 Scroll to **Calls** (or **Line 1** or **Line 2** for dual-line phones), then press the **Change** key to change it.
- 2 Scroll to the alert you want, then press the *center key* .
- 3 Press the **Back** key to save the alert setting.



## time & date



Your phone can automatically update your time zone, time, and date. It uses the time and date for the datebook.

To **synchronize** the time zone, time, and date with the network: Press



 >  **Settings** > **Initial Setup** > **Time and Date**  
> **Autoupdate** > **Time & Time Zone**. If you don't want your phone to automatically update your time zone and date, choose **Time Only** instead.

To **manually** set the time zone, time, and date, turn off **Autoupdate**, then: Press  >  **Settings** > **Initial Setup** > **Time and Date** > **Time Zone**, *time* or *date*. To jump to a city in the time zone list, enter the first letter of its name by pressing keypad keys.

**Tip:** To choose three time zones for easier access, press  >  **Tools** > **World Clock**. When you open **World Clock**, you can press the **Options** key to see the **Map View** of time zones.

To choose an **analog or digital** clock for your home screen, press  >  **Settings** > **Personalize** > **Home Screen** > **Clock**.

## wallpaper

Set a photo, picture, or animation as a wallpaper (background) image in your home screen.

**Note:** Your *theme* can also set your wallpaper (page 57).

**Find it:**  >  **Settings** > **Personalize** > **Wallpaper**

options	
<b>Picture</b>	Press  up or down to select a picture, or select <b>None</b> for no wallpaper.
<b>Layout</b>	Select <b>Center</b> to center the image in the display, <b>Tile</b> to repeat the image across the display, or <b>Fit-to-screen</b> to stretch the image across the display.

## screen saver

Set a photo, picture, or animation as a screen saver. The screen saver shows when the flip is open and no activity is detected for a specified time.

**Note:** Your *theme* can also set your screen saver (page 57).

**Tip:** This feature helps save your screen, but not your battery. To extend battery life, turn off the screen saver.

**Find it:**  >  **Settings** > **Personalize** > **Screen Saver**

options	
<b>Picture</b>	Press  up or down to select a picture or animation, or select <b>None</b> for no screen saver.
<b>Delay</b>	Select the length of inactivity before the screen saver shows.

## themes



A *phone theme* is a group of image and sound files that you can apply to your phone. Most themes include a wallpaper image, screen saver image, and ring tone. Your phone may come with some themes, and you can download more.



To **apply** a theme, press  >  **Multimedia** > **Themes** > *theme*.

To **download** a theme, see page 89.

To **delete themes you downloaded**, press  >  **Multimedia** > **Themes**, scroll to the theme, and press **Options** > **Delete** or **Delete All**.

To **preview** a theme, press  >  **Multimedia** > **Themes**, scroll to the theme, and press **Options** > **Preview**.

## display appearance

**Note:** The **Battery Save** feature tells your phone not to light the display or keypad unless you're in a dark place. To turn on this feature, press  >  **Settings** > **Initial Setup** > **Battery Save** > **On**.

To choose a phone **skin** that sets the look and feel of your phone's display: Press  >  **Settings** > **Personalize** > **Skin**. Your *theme* can also set your phone skin (page 57).

To set your display **brightness**: Press  >  **Settings** > **Initial Setup** > **Brightness**.

To save battery life, your keypad **backlight** turns off when you're not using your phone. The backlight turns on when you open the flip or press any key. To set how long your phone waits before the backlight turns off:

Press  >  **Settings** > **Initial Setup** > **Backlight**.

**Note:** To turn the backlight on or off for Java™ applications, press  >  **Settings**  
> **Java Settings** > **App Backlight**.

To save battery life, the **display** can turn off when you're not using your phone. The display turns back on when you open the flip or press any key. To set how long your phone waits before the display turns off:

Press  >  **Settings** > **Initial Setup**  
> **Display Timeout**.

## answer options

You can use different ways to answer an incoming call. To turn on or turn off an answer option:

**Find it:**  >  **Settings** > **In-Call Setup**  
> **Answer Options**

options	
<b>Multi-Key</b>	Answer by pressing any key.
<b>Open to Answer</b>	Answer by opening the flip.

# calls

---

To make and answer calls, see page 21.

## turn off a call alert

You can press the volume keys to turn off a call alert before answering the call.



## recent calls

Your phone keeps lists of incoming and outgoing calls, even for calls that didn't connect. The most recent calls are listed first. The oldest calls are deleted as new calls are added.

**Shortcut:** Press  from the home screen to see a list of dialed calls.



**Find it:**  >  **Recent Calls**, press  or  to select > **Received Calls** or **Dialed Calls**

Scroll to a call. A ✓ next to a call means the call connected.

- To call the number, press .
- To see call details (like time and date), press the *center key* .
- To see the **Last Calls Menu**, press **Options**. This menu can include:

options	
<b>Store</b>	Create a phonebook entry with the number in the <b>No.</b> field. <b>Store</b> does not appear if the number is already stored.



options	
<b>Video Call</b>	Make a video call to the number.
<b>Delete</b>	Delete the entry.
<b>Delete All</b>	Delete all entries in the list.
<b>Hide ID / Show ID</b>	Hide or show your caller ID for the next call.
<b>Send Message</b>	Open a new text message with the number in the <b>To</b> field.
<b>Send Voice Msg</b>	Record and send a voice message to the number.
<b>Add Digits</b>	Add digits after the number.
<b>Attach Number</b>	Attach a number from the phonebook or recent calls lists.

options	
<b>Send Tones</b>	Send the number to the network as DTMF tones.  <b>Note:</b> This option shows only during a call.
<b>Filter by</b>	Select dialed or received calls.
<b>Notepad</b>	Open the number in a text editor.
<b>Call Times</b>	Open your call time information. 
<b>Call Cost</b>	Open your call cost information. 

## redial

- 1 Press  from the home screen to see a list of recent calls.

- 2 Scroll to the entry you want to call, then press .

If you hear a **busy signal**, and you see **Call Failed**, you can press  or the **Retry**  key to redial the number. When the call goes through, your phone rings or vibrates one time, shows **Redial Successful**, and connects the call.

## return a call

Your phone keeps a record of your unanswered calls, and shows **X Missed Calls**, where **X** is the number of missed calls.

- 1 Press the **View** key to see the received calls list.
- 2 Scroll to the call you want to return, then press .

## caller ID

*Calling line identification* (caller ID)  shows the phone number for an incoming call in your external and internal displays.

Your phone shows the caller's name and picture when they're stored in your phonebook, or **Incoming Call** when caller ID information isn't available.

You can set your phone to play a different ringer ID for an entry stored in your phonebook (see page 71).

To show or hide **your phone number** from the next person you call, enter the phone number and press **Options > Hide ID/Show ID**.

## emergency calls

Your service provider programs one or more emergency phone numbers, such as 911 or 112, that you can call under any circumstances, even when your phone is locked or the SIM card is not inserted.

**Note:** Emergency numbers vary by country. Your phone's preprogrammed emergency number(s) may not work in all locations, and sometimes an emergency call cannot be placed due to network, environmental, or interference issues.

- 1 Press the keypad keys to dial the emergency number.
- 2 Press  to call the emergency number.

## voicemail

Your network stores the voicemail messages you receive. To listen to your messages, call your voicemail number. 

**Note:** Your service provider may include additional information about using this feature.

When you **receive** a voicemail message, your phone shows the voicemail message indicator  and **New Voicemail**. Press the **Call** key to listen to the message.

To **check** voicemail messages:

**Find it:**  >  **Messages** > **Voicemail**

Your phone may prompt you to store your voicemail phone number. If you don't know your voicemail number, contact your service provider.



**Note:** You can't store a **p** (pause), **w** (wait), or **n** (number) character in this number. If you want to store a voicemail number with these characters, create a phonebook entry for it. Then you can use the entry to call your voicemail.

DRAFT

# other features

---

## advanced calling

### features

#### voice dial a number not stored in the phonebook (digit dial)

Press and hold .

When prompted, say “**digit dial**” (within two seconds). When prompted again, say the digits you want to dial (within two seconds per digit).

Your phone recognizes the digits you want. To voice dial a phonebook entry, see page 69.

### features

#### adapt your voice dial

You can improve voice dial operations by training the phone to recognize your voice.

 >  **Settings** > **Personalize** > **Voice Dial Setup**  
> **Adapt digits**

#### attach a phone number



Dial an area code or prefix for a phonebook number, then press **Options**  
> **Attach Number**.

## features

### notepad

Press  >  **Recent Calls**, press the **Options** key, then > **Notepad**.

- To call the number, press .
- To create a phonebook entry with the number in the **No.** field, press the **Store** key.
- To open the **Dialing Menu** to attach a number or insert a special character, press **Options**.

### international calls



If your phone service includes international dialing, press and hold  to insert your local international access code (indicated by +). Then, press the keypad keys to dial the country code and phone number.

## features

### hold a call

Press **Options** > **Hold** to put all active calls on hold.

### mute a call

Press the **Mute** key (if available) or **Options** > **Mute** to put all active calls on mute.

## features



### call waiting



When you're on a call, you'll hear an alert if you receive a second call.

Press  to answer the new call.

- To switch between calls, press the **Switch** key.
- To connect the two calls, press the **Link** key.
- To end the call on hold, press **Options > End Call On Hold**.

To turn the call waiting feature on or off, press  >  **Settings > In-Call Setup > Call Waiting > On or Off**.

## features

### conference call



During a call:

Dial next number, press , press the **Link** key.

### transfer a call



During a call:

**Options > Transfer**, dial transfer number, press .

## features

### automatic call forwarding

Set up or cancel automatic call forwarding:

 >  **Settings** > **Call Forward**

Choose **Voice Calls** or **Video Calls** to set up forwarding, or **Cancel All** to cancel forwarding.



You can set how long your phone waits before it forwards a call (**5, 10, 15, 20, or 25** seconds).

## features

### manual call forwarding

You can set your phone to forward an incoming call only when you press a key.

To set the number where your phone forwards the calls:

 >  **Settings** > **Call Forward**  
> **Push to Call Fwd No.**, and enter the phone number

To choose which key you press to forward incoming calls:

 >  **Settings** > **Personalize** > **Home Screen**  
> **Home Keys**, select one of the key presses in the list, and then select **Push to Call Forward**

## features

### restrict calls



Restrict outgoing or incoming calls:



 >  **Settings** > **Security** > **Restrict Calls**

Tell your phone to allow **All**, **None**, or only the calls from your **Phonebook**.

### call barring



Restrict your voice or video calls to block all calls, international calls, or all calls except ones on your home network.

 >  **Settings** > **Security** > **Call Barring**

### TTY calls



Set up your phone for use with an optional TTY device:

 >  **Settings** > **Initial Setup** > **TTY Setup**



## features

### fixed dial



When you turn on fixed dialing, you can call only numbers stored in the fixed dial list.

Turn fixed dialing on or off:

 >  **Settings** > **Security** > **Fixed Dial**

Use the fixed dial list:

 >  **Tools** > **Dialing Services** > **Fixed Dial**

### service dial



Your service provider might give you phone numbers for taxi companies or other services. These phone numbers are stored on your SIM card. To see them:

 >  **Tools** > **Dialing Services** > **Service Dial**

## features

### quick dial



Dial preprogrammed phone numbers:

 >  Tools > Dialing Services > Quick Dial

### DTMF tones

Activate DTMF tones:

 >  Settings > Initial Setup > DTMF

To send DTMF tones during a call, just press number keys or scroll to a number in the phonebook or recent calls lists and press **Options** > **Send Tones**.

# phonebook

## features

### voice dial a phonebook entry (name dial)

Voice dial a number stored in the phonebook:

Press and hold .

When prompted, say “**name dial**” (within two seconds). When prompted again, say the entry’s name (within two seconds).

Your phone matches your voice to a phonebook entry name. To voice dial a number not stored in the phonebook, see page 64.

## features

### speed dial a phonebook entry

You can assign the keys **1** through **9** to phonebook entries. Then, when you press and hold a key, your phone calls the entry.

**Note:** Your service provider might have assigned some keys, such as **1** for your voicemail number. You can only speed dial phonebook entries that are stored on your phone (not on your SIM card).

To **assign a speed dial key**, press **⬇** > **☎ Phonebook** and scroll to the phonebook entry. Then, press **Options** > **Add to Speed Dial** and pick a speed dial key.

To **use a speed dial key**, just press and hold the key while in your home screen.

## features

### edit or delete a phonebook entry

Edit a number stored in the phonebook:

**⬇** > **☎ Phonebook**, scroll to the phonebook entry, and press **Options**. You can select **Edit Contact**, **Delete**, or other options.

**Shortcut:** In the phonebook, press keypad keys to enter the first letters of an entry you want. You can also press **✖** and **#** to see the entries you use frequently or entries in other categories.



## features

### set ringer ID for a phonebook entry

Assign a ring alert (ringer ID) to an entry:

•📶 > 📁 Phonebook > *entry*, then press  
**Options** > **Edit Contact** > **Ringer ID** > *ringer name*

**Note:** The **Ringer ID** option isn't available for entries stored on the SIM card. To copy an entry from SIM to phone memory, see page 73.

Activate ringer IDs:

•📶 > ⚙️ Settings > **Ring Styles** > *style Detail*  
> **Ringer IDs**

## features

### set picture ID for a phonebook entry

Assign a photo or picture to show when you receive a call from an entry:

•📶 > 📁 Phonebook > *entry*, then press  
**Options** > **Edit Contact** > **Picture** > *picture name*

**Note:** The **Picture** option isn't available for entries stored on the SIM card. To copy an entry from SIM to phone memory, see page 73

### set picture ID view for phonebook

Show entries as a text list, or with picture caller ID photos:

•📶 > 📁 Phonebook, then press **Options** > **Setup**  
> **View by** > *view name*

## features

### set category for a phonebook entry

☛ > ☑ Phonebook > *entry*, then press  
Options > Edit Contact > Category > *category name*

**Note:** The **Category** option isn't available for entries stored on the SIM card. To copy an entry from SIM to phone memory, see page 73

When you open your phonebook, press ☒ or ☑ to see your categories.

### set category view for phonebook

☛ > ☑ Phonebook, then press Options  
> Filter by > Category > *category name*

You can show **All** entries, entries in a predefined category (**Business**, **Personal**, **General**, **VIPs**), or entries in a category you create.

**Shortcut:** When you open your phonebook, press ☒ or ☑ to see your categories.

## features

### create group mailing list

You can put several phonebook entries in a group mailing list, then send a message to the list. To create a list:

☛ > ☑ Phonebook, then press  
Options > Create New > Message List

You can select the list name as an address for multimedia messages.

**Note:** A **Message List** cannot include entries stored on the SIM card. To copy an entry from SIM to phone memory, see page 73

### sort phonebook list

Set the order in which entries are listed:

☛ > ☑ Phonebook, then press  
Options > Setup > Sort by > *sort order*

You can sort the phonebook list by **First Name** or **Last Name**.

## features



### copy one phonebook entry

Copy an entry from the phone to the SIM card, or from the SIM card to the phone:

 >  **Phonebook**, scroll to the entry, press **Options** > **Copy to SIM Card** or **Copy to Phone**

### copy multiple phonebook entries



Copy multiple phonebook entries between the phone and SIM card:

 >  **Phonebook**, scroll to one entry, press **Options** > **Select Multiple to**, then select **Copy to SIM Card** or **Copy to Phone**

## features

### send phonebook entry to another device

Send a phonebook entry to another phone, computer, or device:

 >  **Phonebook**, scroll to the entry, press **Options** > **Send Contact**

For more information about copying files to another device, see page 24.

### print phonebook entry over Bluetooth™ connection



You can use a Bluetooth wireless connection to send a phonebook entry from your phone to a printer.

 >  **Phonebook**

Scroll to the entry you want to print, and press **Options** > **Select Multiple to** > **Print**.

You cannot print a **Mailing List**. For more about Bluetooth connections, see page 23.

# messages

For basic text message features, see page 36.

Your phone reads message settings from the USIM card. If you put another USIM card in your phone, your phone sends and receives messages for the phone number on the new card.

## features

### send email

•◉ > ✉ Messages > Email Msgs  
> Create Email

**Note:** To use email, you might need to enter a **User ID** and **Password** in your email settings (see page 77).

## features

### send voice message

•◉ > ✉ Messages > Create Message  
> New Voice Msg

To record the voice message, press the **Record** key, speak, then press the **Stop** key. Your phone inserts the voice recording into a message and lets you enter email addresses or phone numbers to receive the message.

## features

### read and manage messages



•◂◃ > ✉ Messages > Message Inbox

Icons next to each message indicate if it is read or unread . Icons can also indicate if the message is locked , urgent , or low priority , or if it has an attachment

To **Reply**, **Forward**, **Lock**, or **Delete** a message, scroll to it and press **Options**.

To open a message, press •◂◃. Then, you can press **Options** to use or store any phone numbers, email addresses, Web sites, or files in the message.

## features

### read and manage email



•◂◃ > ✉ Messages > Email Msgs

To **Reply**, **Forward**, **Lock**, or **Delete** a message, scroll to it and press **Options**.

To open a message, press •◂◃. Then, you can press **Options** to use or store any phone numbers, email addresses, Web sites, or files in the message.

### store message objects



Go to a multimedia message page, or scroll to an object in a message, then:

**Options > Store**

## features

### print message over Bluetooth™ connection

You can use a Bluetooth wireless connection to send a message from your phone to a printer.

 >  **Messages** > **Message Inbox, Email Msgs, Outbox, or Drafts**



Scroll to the message you want to print and press **Options** > **Print**.

You cannot print message **Templates**. For more about Bluetooth connections, see page 23.

## features

### store text messages on your SIM card

To store incoming text messages on your SIM card, press:

 >  **Messages**, then press **Options** > **Setup** > **Message Setup** > **Text Msg Setup** > **Default Storage** > **SIM Card**.

## features



### edit email settings

You can edit the settings for your Email connections. To use email, you need to store your email **User ID** and **Password**.

 >  **Messages**, then press **Options** > **Setup** > **Email Msg Setup** > **Account Settings**

If you have more than one email account, select an account to edit.

Your phone shows a list of email settings. Here is where you store your email **User ID** and **Password**.

**Note:** To create a new account, select **New Entry** in the **Account Settings** list. Your display shows a folder for each email account under  >  **Messages** > **Email Msgs**.

## features

### browser messages

Read messages received by your micro-browser:

 >  **Messages** > **Browser Msgs**

### info services

Read subscription-based information services messages:

 >  **Messages** > **Info Services**

## instant messaging



## features

### log in

 >  **Tools** > **Messenger**

Select an IM account, or select **[New Account]** to set up an IM account.

features	
<p><b>add contacts</b></p> <p>After you log in:</p> <p>Press <b>Options &gt; Add Contact</b> and enter the contact's name, mobile number, IM ID, and alias.</p>	
<p><b>find others online</b></p> <p>After you log in:</p> <p>Select <b>Online Contacts</b> to see a list of others online.</p>	
<p><b>start conversation</b></p> <p>Scroll to a name in <b>Online Contacts</b> and press the <b>Send IM</b> key.</p>	
<p><b>open active conversation</b></p> <p>Scroll to a name in <b>Conversations</b> and press the <b>Select</b> key.</p>	

features	
<p><b>insert items during a conversation</b></p> <p>From the conversation view:</p> <p><b>Options &gt; Insert</b></p> <p>You can insert an <b>Emoticon</b>, <b>Quick IM</b> (such as <b>Are you there?</b>), or <b>Contact Info</b> (selected from your phonebook).</p>	
<p><b>end conversation</b></p> <p>From the conversation view:</p> <p><b>Options &gt; End Conversation</b></p>	
<p><b>log out</b></p> <p>Select <b>Log Out</b> from the <b>IM Online</b> menu.</p>	



# personalizing

<b>features</b>
<b>language</b> Set menu language: •📶 > ⚙️ Settings > Initial Setup > Language
<b>scroll</b> Set the scroll bar to <b>Up/Down</b> or <b>Wrap Around</b> in menu lists: •📶 > ⚙️ Settings > Initial Setup > Scroll
<b>activate ringer IDs</b> Activate ringer IDs assigned to phonebook entries and categories: •📶 > ⚙️ Settings > Ring Styles > <i>style</i> Detail > Ringer IDs

<b>features</b>
<b>ring volume</b> •📶 > ⚙️ Settings > Ring Styles > <i>style</i> Detail > Ring Volume
<b>keypad volume</b> •📶 > ⚙️ Settings > Ring Styles > <i>style</i> Detail > Key Volume
<b>reminders</b> Set reminder alerts for messages that you receive: •📶 > ⚙️ Settings > Ring Styles > <i>style</i> Detail > Reminders
<b>menu view</b> Show the main menu as graphic icons or as a text-based list: •📶 > ⚙️ Settings > Personalize > Main Menu > View

## features

### main menu

Reorder your phone's main menu:

📶 > ⚙️ Settings > Personalize > Main Menu  
> Reorder

### show/hide menu icons

Show or hide menu feature icons in the home screen:

📶 > ⚙️ Settings > Personalize > Home Screen  
> Home Keys > Icons

### change home keys

Change features for the soft keys, navigation key, and smart key in the home screen:

📶 > ⚙️ Settings > Personalize > Home Screen  
> Home Keys

## features

### master reset

Reset all options **except** unlock code, security code, and lifetime timer:

📶 > ⚙️ Settings > Initial Setup > Master Reset

### master clear

**Caution:** Master clear **erases all information you have entered** (including phonebook and datebook entries) **and content you have downloaded** (including photos and sounds) stored in your phone's memory. After you erase the information, you can't recover it.







📶 > ⚙️ Settings > Initial Setup > Master Clear

## call times & costs

**Network connection time** is the elapsed time from the moment you connect to your

service provider's network to the moment you end the call by pressing . This time includes busy signals and ringing.

**The amount of network connection time you track on your resettable timer may not equal the amount of time for which you are billed by your service provider. For billing information, contact your service provider.**



features	
<b>call times</b>	
Show call timers:	
•  >  <b>Recent Calls</b> , press the <b>Options</b> key, then > <b>Call Times</b>	
<b>in-call timer</b>	
Show time or cost information during a call:	
•  >  <b>Settings</b> > <b>In-Call Setup</b> > <b>In-Call Timer</b>	

## features

### call cost









Show call cost trackers:

•  >  **Recent Calls**, press the **Options** key, then > **Call Cost**

## handsfree

**Note:** The use of wireless phones while driving may cause distraction. Discontinue a call if you can't concentrate on driving. Additionally, the use of wireless devices and their accessories may be prohibited or restricted in certain areas. Always obey the

laws and regulations on the use of these products.

features	
<b>speakerphone</b>	
Activate the speakerphone during a call:  Press the <b>Speaker</b> key (if available, or <b>Options &gt; Spkrphone On</b> ).	
<b>auto answer</b> (car kit or headset)	
Automatically answer calls when connected to a car kit or headset:   >  <b>Settings &gt; Car Settings or Headset &gt; Auto Answer</b>	
<b>voice dial</b> (headset)	
Enable voice dial with headset send/end key:   >  <b>Settings &gt; Headset &gt; Voice Dial</b>	

## features

### auto handsfree (car kit)



Automatically route calls to a car kit when connected:

 >  **Settings > Car Settings > Auto Handsfree**

## data calls

To connect your phone with a USB cable, see page 40.

## features

### send data



Connect your phone to the device, then place the call through the device application.

## features

### receive data



Connect your phone to the device, then answer the call through the device application.



## features

### setting up Exchange ActiveSync



You can use the Internet to synchronize your phone's phonebook and datebook entries with an email account on a Microsoft® Exchange 2003 Server.



You need to know the email account's **user name** and **password**, the Microsoft® Exchange **server name**, and the **user domain name**. Confirm that the **Mobility** option is enabled on the email account, and that **data service** is activated with your phone service provider.

To **set up** an ActiveSync partner, press  >  **Settings** > **Connection** > **MOTOSYNC** > **Exchange**, press the **Options** key, then > **Setup**. Enter the server details, including **Server Name**, **Domain**, and the **Web Session** to use. To set up a **Web Session**, see page 89.

## features

### using Exchange ActiveSync

Once you set up an Exchange ActiveSync partner, you can schedule your phone to synchronize with the account automatically.

To **schedule** synchronization, press  >  **Settings** > **Connection** > **MOTOSYNC** > **Exchange**, press the **Options** key, then > **Auto Sync Setup**. Enter the time and days you want your phone to synchronize.

## network

### features

#### network settings

See network information and adjust network settings:

 >  **Settings** > **Network**

#### software update

Your service provider can send updated phone software over the air to your phone. When your phone receives a software update, you can choose to download it and install it later. To install a software update you downloaded:

 >  **Settings** > **Phone Status** > **Software Update** > **Install Now**

# personal organizer

features
<b>set alarm</b>
•◂ > 🗄️ Tools > Alarm Clock
<b>turn off alarm</b>
When an alarm happens: To turn off the alarm, press the <b>Disable</b> key or  . To set an eight-minute delay, press the <b>Snooze</b> key.
<b>Note:</b> The <b>Snooze</b> key is available only if the phone is already powered on when the alarm sounds.

features
<b>add new datebook event or task</b>
Your datebook can store events (with a start and end time that can repeat) or tasks (with a due date).
•◂ > 🗄️ Tools > Datebook, scroll to the day, press •◂, press <b>Options</b> > <b>Create New Event</b> or <b>Create New Task</b>
<b>see datebook event or task</b>
See or edit event or task details:
•◂ > 🗄️ Tools > Datebook, scroll to the day, press •◂
<b>Tip:</b> Keeping up with life can be tough work. To see a list of your upcoming events or tasks, open the datebook and press <b>Options</b> > <b>View</b> > <b>Organized Events</b> or <b>Organized Tasks</b> .

## features

### change datebook settings

•◂ >  **Tools** > **Datebook**, then press **Options** > **Setup**

You can choose the **Default View** that appears when you open your datebook, and you can show or hide the **Tasks On Day View**. You can tell your phone to **Power On** if it is turned off when a datebook alert occurs. Turn on **Lunar Calendar** if you do not want to use a solar calendar.

### event reminder

When an event reminder happens:  
To see reminder details, press the **View** key.  
To close the reminder, press the **Back** key.

## features

### send datebook event to another device

Send a datebook event to another phone, computer, or device:

•◂ >  **Tools** > **Datebook**, scroll to the day, press •◂, scroll to the event, press **Options** > **Send**

### print datebook month, week, or day over Bluetooth™ connection

You can use a Bluetooth wireless connection to send a datebook month, week, or day from your phone to a printer.

•◂ >  **Tools** > **Datebook**

Go to the month, week, or day view and press **Options** > **Print**.

For more about Bluetooth connections, see page 23.



## features

### create voice record

 >  **Multimedia** > **Voice Record**

Press . When prompted, speak into the phone.

**Note:** Recording phone calls is subject to varying state and federal laws regarding privacy and recording of conversations. Always obey the laws and regulations on the use of this feature.

### play voice record

Play back a voice record:



 >  **Media Finder** > **Voice Record**  
> **All Voice Records** > *voice record*

### calculator

 >  **Tools** > **Calculator**

## features

### currency converter

 >  **Tools** > **Calculator**, then press  
**Options** > **Exchange Rate**

Enter exchange rate, press the **OK** key, enter amount, and press **Options** > **Convert Currency**.



## security

## features

### SIM PIN

**Caution:** If you enter an incorrect PIN code three times before the correct code, your SIM card is disabled and your display shows **SIM Blocked**.

Lock or unlock the SIM card:



 >  **Settings** > **Security** > **SIM PIN**

## features

### lock feature

 >  Settings > Security > Lock Application

## fun & games

**Note:** Icons next to a picture, sound, or other object can indicate if the file is locked () , or if it is stored on your phone () or on your memory card () .



For basic information on the camera, see page 31.

## features

### view, delete, or manage pictures

Manage photos, pictures, and animations:

 >  Multimedia > Media Finder > Pictures > All Pictures



To **copy or move** a file from your memory card () to your phone memory () , highlight it in the list and press **Options > Manage > Copy or Move > Memory Card**. You cannot copy or move some copyrighted files.



## features

### view, delete, or manage video clips

•> >  **Multimedia** > **Media Finder** > **Videos**  
> **All Videos**

To **copy or move** a file from your memory card () to your phone memory () , highlight it in the list and press **Options** > **Manage** > **Copy** or **Move** > **Memory Card**. You cannot copy or move some copyrighted files.



### start micro-browser

Just press .

Your phone reads micro-browser settings from the USIM card. When you remove the USIM card, your phone clears the browser cache. To edit your settings, press  
•> >  **Web Access** > **Web Sessions**.



## features

### download objects from Web page



Download a picture, sound, or other object from a Web page:

Press , go to the page that links to the file, scroll to the link, and select it.

**Note:** Normal airtime and/or carrier usage charges apply.

### Web sessions



A *Web Session* stores settings that your phone uses to access the Internet. To select or create a Web session:

•> >  **Web Access** > **Web Sessions**

## features

### clear micro-browser history



Clear the micro-browser's history, cache, or cookies:

•◉ >  **Web Access** > **Browser Setup**  
> **Clear History**, **Reset Cache**, or **Clear Cookies**

### download game or application



You can download a Java™ game or application the same way you download pictures or other objects:

Press , go to the page that links to the file, scroll to the link, and select it.

**Note:** Normal airtime and/or carrier usage charges apply.

## features

### start game or application



Start a Java™ game or application:

•◉ >  **Games & Apps**, scroll to the game or application, press the *center key* •◉

**Note:** To install and run games stored on your memory card, press

•◉ >  **Games & Apps** > **[Install New]**.

## features

### airplane mode

You can switch your phone to airplane mode to prevent it from communicating with the network. This lets you use games or other applications while you are on an airplane, without interfering with airplane communications.

•◂ > ⓧ **Airplane Mode > Airplane Mode > On**

You can make the airplane mode option appear whenever you turn on your phone:

•◂ > ⓧ **Airplane Mode > Prompt At Startup > On**

# service and repairs

---

If you have questions or need assistance, we're here to help.

Go to [www.motorola.com/consumer/support](http://www.motorola.com/consumer/support), where you can select from a number of customer care options. You can also contact the Motorola Customer Support Center at 1-800-331-6456 (United States), 1-888-390-6456 (TTY/TDD United States for hearing impaired), or 1-800-461-4575 (Canada).

# Specific Absorption Rate Data

---

## THIS MODEL MEETS INTERNATIONAL GUIDELINES FOR EXPOSURE TO RADIO WAVES

Your wireless phone is a radio transmitter and receiver. It is designed and manufactured not to exceed limits for exposure to radio frequency (RF) energy set by the Federal Communications Commission (FCC) of the U.S. Government and by the Canadian regulatory authorities. These limits are part of comprehensive guidelines and establish permitted levels of RF energy for the general population. The guidelines are based on standards that were developed by independent scientific organizations through periodic and thorough evaluation of scientific studies. The standards include a substantial safety margin designed to assure the safety of all persons, regardless of age or health.

The exposure standard for wireless mobile phones employs a unit of measurement known as the Specific Absorption Rate, or SAR. The SAR limit set by the FCC and by the Canadian regulatory authorities is 1.6 W/kg. Tests for SAR are conducted using standard operating positions accepted by the FCC and by Industry Canada with the phone transmitting at its highest certified power level in all tested frequency bands. Although the SAR is determined at the highest certified power level, the actual SAR level of the phone while operating can be well below the maximum value. This is because the phone is designed to operate at multiple power levels so as to use only the power required to reach the network. In general, the closer you are to a wireless base station, the lower the power output.

Before a phone model is available for sale to the public in the U.S. and Canada, it must be tested and certified to the FCC and Industry Canada that it does not exceed the limit established by each government for safe exposure. The tests are performed in positions and locations (e.g., at the ear and worn on the body) reported to the FCC and available for review by Industry Canada. The highest SAR value for this model phone when tested for use at the ear is 0.32 W/kg, and when worn on the body, as described in this user guide, is 0.50 W/kg. (Body-worn measurements differ among phone models, depending upon available accessories and regulatory requirements).<sup>2</sup>

While there may be differences between the SAR levels of various phones and at various positions, they all meet the governmental requirements for safe exposure. Please note that improvements to this product model could cause differences in the SAR value for later products; in all cases, products are designed to be within the guidelines.

The World Health Organisation has stated that present scientific information does not indicate the need for any special precautions for the use of mobile devices. They note that if you want to reduce your exposure then you can do so by limiting the length of calls or using a 'hands-free' device to keep the mobile phone away from the head and body.

Additional Information can be found on the websites of the World Health Organisation (<http://www.who.int/emf>) or Motorola, Inc. (<http://www.motorola.com/rfhealth>).

- \* The tests are carried out in accordance with international guidelines for testing. The limit incorporates a substantial margin for safety to give additional protection for the public and to account for any variations in measurements. Additional related information includes the Motorola testing protocol, assessment procedure, and measurement uncertainty range for this product.
- \*\* Please see the Safety and General Information section about body worn operation.

# Motorola Limited Warranty for the United States and Canada

---

## What Does this Warranty Cover?

Subject to the exclusions contained below, Motorola, Inc. warrants its telephones, pagers, messaging devices, and consumer and professional two-way radios (excluding commercial, government or industrial radios) that operate via Family Radio Service or General Mobile Radio Service, Motorola-branded or certified accessories sold for use with these Products ("Accessories") and Motorola software contained on CD-ROMs or other tangible media and sold for use with these Products ("Software") to be free from defects in materials and workmanship under normal consumer usage for the period(s) outlined below. This limited warranty is a consumer's exclusive remedy, and applies as follows to new Motorola Products, Accessories and Software purchased by consumers in the United States or Canada, which are accompanied by this written warranty:

## Products and Accessories

<b>Products Covered</b>	<b>Length of Coverage</b>
<b>Products and Accessories</b> as defined above, unless otherwise provided for below.	<b>One (1) year</b> from the date of purchase by the first consumer purchaser of the product unless otherwise provided for below.
<b>Decorative Accessories and Cases.</b> Decorative covers, bezels, PhoneWrap™ covers and cases.	<b>Limited lifetime warranty</b> for the lifetime of ownership by the first consumer purchaser of the product.
<b>Monaural Headsets.</b> Ear buds and boom headsets that transmit mono sound through a wired connection.	<b>Limited lifetime warranty</b> for the lifetime of ownership by the first consumer purchaser of the product.



Products Covered	Length of Coverage
<b>Consumer and Professional Two-Way Radio Accessories.</b>	<b>Ninety (90) days</b> from the date of purchase by the first consumer purchaser of the product.
<b>Products and Accessories that are Repaired or Replaced.</b>	<b>The balance of the original warranty or for ninety (90) days</b> from the date returned to the consumer, whichever is longer.

#### Exclusions

**Normal Wear and Tear.** Periodic maintenance, repair and replacement of parts due to normal wear and tear are excluded from coverage.

**Batteries.** Only batteries whose fully charged capacity falls below 80% of their rated capacity and batteries that leak are covered by this limited warranty.

**Abuse & Misuse.** Defects or damage that result from: (a) improper operation, storage, misuse or abuse, accident or neglect, such as physical damage (cracks, scratches, etc.) to the surface of the product resulting from misuse; (b) contact with liquid, water, rain, extreme humidity or heavy perspiration, sand, dirt or the like, extreme heat, or food; (c) use of the Products or Accessories for commercial purposes or subjecting the Product or Accessory to abnormal usage or conditions; or (d) other acts which are not the fault of Motorola, are excluded from coverage.

**Use of Non-Motorola Products and Accessories.** Defects or damage that result from the use of Non-Motorola branded or certified Products, Accessories, Software or other peripheral equipment are excluded from coverage.

**Unauthorized Service or Modification.** Defects or damages resulting from service, testing, adjustment, installation, maintenance, alteration, or modification in any way by someone other than Motorola, or its authorized service centers, are excluded from coverage.

**Altered Products.** Products or Accessories with (a) serial numbers or date tags that have been removed, altered or obliterated; (b) broken seals or that show evidence of tampering; (c) mismatched board serial numbers; or (d) nonconforming or non-Motorola housings, or parts, are excluded from coverage.

**Communication Services.** Defects, damages, or the failure of Products, Accessories or Software due to any communication service or signal you may subscribe to or use with the Products Accessories or Software is excluded from coverage.

#### Software

Products Covered	Length of Coverage
<b>Software.</b> Applies only to physical defects in the media that embodies the copy of the software (e.g. CD-ROM, or floppy disk).	<b>Ninety (90) days</b> from the date of purchase.

## Exclusions

**Software Embodied in Physical Media.** No warranty is made that the software will meet your requirements or will work in combination with any hardware or software applications provided by third parties, that the operation of the software products will be uninterrupted or error free, or that all defects in the software products will be corrected.

**Software NOT Embodied in Physical Media.** Software that is not embodied in physical media (e.g. software that is downloaded from the internet), is provided "as is" and without warranty.

## Who Is Covered?

This warranty extends only to the first consumer purchaser, and is not transferable.

## What Will Motorola Do?

Motorola, at its option, will at no charge repair, replace or refund the purchase price of any Products, Accessories or Software that does not conform to this warranty. We may use functionally equivalent reconditioned/refurbished/pre-owned or new Products, Accessories or parts. No data, software or applications added to your Product, Accessory or Software, including but not limited to personal contacts, games and ringer tones, will be reinstalled. To avoid losing such data, software and applications please create a back up prior to requesting service.

## How to Obtain Warranty Service or Other Information

<b>USA</b>	<b>Phones</b> 1-800-331-6456 <b>Pagers</b> 1-800-548-9954 <b>Two-Way Radios and Messaging Devices</b> 1-800-353-2729
<b>Canada</b>	<b>All Products</b> 1-800-461-4575
<b>TTY</b>	1-888-390-6456
For <b>Accessories</b> and <b>Software</b> , please call the telephone number designated above for the product with which they are used.	

You will receive instructions on how to ship the Products, Accessories or Software, at your expense, to a Motorola Authorized Repair Center. To obtain service, you must include: (a) a copy of your receipt, bill of sale or other comparable proof of purchase; (b) a written description of the problem; (c) the name of your service provider, if applicable; (d) the name and location of the installation facility (if applicable) and, most importantly; (e) your address and telephone number.

## What Other Limitations Are There?

ANY IMPLIED WARRANTIES, INCLUDING WITHOUT LIMITATION THE IMPLIED WARRANTIES OF MERCHANTABILITY AND FITNESS FOR A PARTICULAR PURPOSE, SHALL BE LIMITED TO THE DURATION OF THIS LIMITED WARRANTY, OTHERWISE THE REPAIR, REPLACEMENT, OR REFUND AS PROVIDED UNDER THIS EXPRESS LIMITED WARRANTY IS THE EXCLUSIVE REMEDY OF THE CONSUMER, AND IS PROVIDED IN LIEU OF ALL OTHER WARRANTIES, EXPRESS OR IMPLIED. IN NO EVENT SHALL MOTOROLA BE LIABLE, WHETHER IN CONTRACT OR TORT (INCLUDING NEGLIGENCE) FOR DAMAGES IN EXCESS OF THE PURCHASE PRICE OF THE PRODUCT, ACCESSORY OR SOFTWARE, OR FOR ANY INDIRECT, INCIDENTAL, SPECIAL OR CONSEQUENTIAL DAMAGES OF ANY KIND, OR LOSS OF REVENUE OR PROFITS, LOSS OF BUSINESS, LOSS OF INFORMATION OR DATA, SOFTWARE OR APPLICATIONS OR OTHER FINANCIAL LOSS ARISING OUT OF OR IN CONNECTION WITH THE ABILITY OR INABILITY TO USE THE PRODUCTS, ACCESSORIES OR SOFTWARE TO THE FULL EXTENT THESE DAMAGES MAY BE DISCLAIMED BY LAW.

**Some states and jurisdictions do not allow the limitation or exclusion of incidental or consequential damages, or limitation on the length of an implied warranty, so the above limitations or exclusions may not apply to you. This warranty gives you specific legal rights, and you may also have other rights that vary from state to state or from one jurisdiction to another.**

Laws in the United States and other countries preserve for Motorola certain exclusive rights for copyrighted Motorola software such as the exclusive rights to reproduce and distribute copies of the Motorola software. Motorola software may only be copied into, used in, and redistributed with, the Products associated with such Motorola software. No other use, including without limitation disassembly of such Motorola software or exercise of the exclusive rights reserved for Motorola, is permitted.

# Information from the World Health Organization

---

Present scientific information does not indicate the need for any special precautions for the use of mobile phones. If you are concerned, you may want to limit your own or your children's RF exposure by limiting the length of calls or by using handsfree devices to keep mobile phones away from your head and body.

Source: WHO Fact Sheet 193

Further information: <http://www.who.int./peh-emf>

# index

---

- A**
- accessories 17, 81
  - accessory connector port 1
  - active line indicator 45
  - airplane mode 91
  - alarm clock 85
  - alarm indicator 45
  - alert
    - set 50, 51, 54
    - turn off 50, 54, 59
  - animation 88
  - answer a call 21, 58
  - attach a number 60, 64
  - audio player 29
- B**
- backlight 57
  - battery 19, 20
    - extending battery life 18
  - battery indicator 46
  - battery life, extending 56, 57, 58
  - Bluetooth connection
    - datebook entry, printing 86
    - datebook entry, sending 86
    - description 23
    - messages, printing 76
    - phonebook entries 73
    - restricting access 28
  - brightness 57
  - browser messages 77
  - browser. See micro-browser
- C**
- cables 40
  - calculator 87
  - call
    - answering 21, 58
    - barring 52, 68
    - end 21
    - ending 21, 36
    - forwarding 67
    - making 21
    - timers 81
    - waiting 66
  - call forward indicator 45
  - caller ID 60, 61, 71
  - camera 31
  - car kit 81
  - categories 72

center key 1, 51  
center select key 17  
clock 55  
codes 52  
conference call 66  
copy files 24  
copyrighted files 39  
costs, tracking 81

## D

data call 82, 83  
data indicator 44  
date, setting 55  
datebook 85, 86  
dial a phone number 21, 68,  
69  
dialed calls 59  
digit dial 64  
digital audio 29  
display 3, 43, 57  
downloaded files

from Web pages 89  
in messages 75  
DTMF tones 60, 69

## E

earpiece volume 50  
email  
    reading and managing 75  
    sending 74  
    settings 77  
emergency number 62  
emoticon 78  
end a call 21, 36  
end key 1, 21  
Enter Unlock Code message  
    52  
external display 33, 51

## F

fax call 82, 83  
fixed dial 68

flip 21, 58  
forward calls 67

## G

games 90  
GPRS indicator 44  
group mailing list 72

## H

handsfree speaker 52  
headset 81  
headset jack 1  
hold a call 65  
home screen 3, 43, 80  
hot message 37

## I

IM 77  
in-call indicator 45  
Incoming Call message 61

information services 77  
instant messaging. See IM  
international access code 65  
iTAP text entry mode 48

## **J**

Java applications 90

## **K**

keypad 58, 79

## **L**

language 79  
licenses 39  
linking. See Bluetooth  
    connection  
lock  
    application 88  
    phone 52  
    SIM card 87

Low Battery message 46

## **M**

make a call 21  
master clear 80  
master reset 80  
Media Finder 29  
memory card 38  
menu 3, 17, 43, 79, 80  
menu icons 43, 79, 80  
message 74, 75, 76  
message alerts 54  
message indicator 36, 45  
message reminders 79  
micro-browser 77, 89, 90  
Missed Calls message 61  
MMS, defined 36  
MP3 sound files 29, 30  
multimedia message 36, 75,  
    76  
mute a call 65

## **N**

name dial 69  
navigation key 1, 17, 51  
network settings 84  
notepad 65  
number. See phone number  
numeric entry mode 50

## **O**

object exchange 24  
open to answer 58  
optional accessory 17  
optional feature 17

## **P**

pairing. See Bluetooth  
    connection  
passwords. See codes  
personalize 79  
phone number 22

phonebook 60, 64, 69, 70  
photo 31, 88  
picture 88  
picture ID 61, 71  
PIN code 20, 52, 87  
PIN2 code 52  
power key 1, 20  
printing 26

## **Q**

quick dial 69

## **R**

received calls 59  
recent calls 59  
redial 60  
reminders 79  
restrict calls 68  
return a call 61  
ring style indicator 46  
ring style, setting 50, 51, 54

ringer ID 61, 71, 79  
ringer volume 50, 79  
roam indicator 45

## **S**

safety information 9  
screen saver 56  
scrolling 79  
security code 52  
send key 1, 21  
service dial 68  
signal strength indicator 44  
SIM Blocked message 20,  
87  
SIM card 17, 20, 52, 68, 76,  
87  
skin 57  
smart key 51, 80  
smiley. See emoticon  
soft keys 1, 43, 80  
software update 84

speakerphone 81  
speed dial 70  
store your number 22  
symbol entry mode 50  
synchronizing 83, 84

## **T**

tap text entry mode 49  
telephone number. See  
    phone number  
text entry 46  
text message 75, 76  
theme 57  
time zone 55  
time, setting 55  
timers 81  
transfer a call 66  
TTY device 68  
turn on/off 20



## U

unlock  
    application 88  
    phone 20, 52  
    SIM card 87  
unlock code 52  
USB cables 40

## V

video clip 89  
videos 34  
voice dial 64, 69, 82  
voice message 74  
voice record 87  
voicemail 62  
voicemail message indicator  
    45, 62  
volume 50, 79

## W

wallpaper 56  
warranty 94  
Web pages 89  
Web sessions 89

## Y

your phone number 22  
  
U.S. patent Re. 34,976