

User / Operational Manual

Operational or User's Manual

The manual should include instruction, installation, operator, or technical manuals with required 'information to the users'. This manual should include a statement that cautions the user that changes or modifications not expressly approved by the party responsible for compliance could void the user's authority to operate the equipment. The manual shall include RF Hazard warning statements, if applicable.

The instruction and service manual for this base radio are not published at this time. However, draft copy of some of the manual information has been assembled and has been included as part of this filing package.

Upon request, published and/or printed manuals will be sent to the commission and/or telecommunication certification body (TCB) as soon as they become available. All of the descriptions, block diagrams, and schematics that are included in this filing package are current as of the package submittal date.

EXHIBIT DESCRIPTION

- D1-1 Manual Front Matter (Draft)
- D1-2 Specifications (Draft)
- D1-3 Field Replaceable Units and Orderable Parts (Draft)
- D1-4 Tune-Up Procedure
- D1-5 Functional Description / Operation of Modules (Draft)

User / Operational Manual

Manual Front Matter (Draft)

COMPUTER SOFTWARE COPYRIGHTS

The Motorola products described in this instruction manual may include copyrighted Motorola computer programs stored in semiconductor memories or other media. Laws in the United States and other countries preserve for Motorola certain exclusive rights for copyrighted computer programs, including the exclusive right to copy or reproduce in any form the copyrighted computer program. Accordingly, any copyrighted Motorola computer programs contained in the Motorola products described in this instruction manual may not be copied or reproduced in any manner without the express written permission of Motorola. Furthermore, the purchase of Motorola products shall not be deemed to grant either directly or by implication, estoppel, or otherwise, any license under the copyrights, patents or patent applications of Motorola, except for the normal non-exclusive, royalty free license to use that arises by operation of law in the sale of a product.

EPS-34440-B

**COMMERCIAL WARRANTY
(STANDARD)**

Motorola radio communications products are warranted to be free from defects in material and workmanship for a period of ONE (1) YEAR, (except for crystals and channel elements which are warranted for a period of ten (10) years) from the date of shipment. Parts, including crystals and channel elements, will be replaced and labor will be provided free of charge for the full warranty period. Thereafter purchaser must pay for the labor involved in repairing the product or replacing the parts at the prevailing rates together with any transportation charges to or from the place where warranty service is provided. This express warranty is extended by Motorola Communications and Electronics, Inc., 1301 E. Algonquin Road, Schaumburg, Illinois 60196, to the original purchaser only, and only to those purchasing for purpose of leasing or solely for commercial, industrial, or governmental use.

THIS WARRANTY IS GIVEN IN LIEU OF ALL OTHER WARRANTIES EXPRESSED OR IMPLIED WHICH ARE SPECIFICALLY EXCLUDED, INCLUDING WARRANTIES OF MERCHANTABILITY OR FITNESS FOR A PARTICULAR PURPOSE. IN NO EVENT SHALL MOTOROLA BE LIABLE FOR INCIDENTAL OR CONSEQUENTIAL DAMAGES TO THE FULL EXTENT SUCH MAY BE DISCLAIMED BY LAW.

In the event of a defect, malfunction or failure to conform to specifications established by seller, or if appropriate, to specifications accepted by Seller in writing, during the period shown, Motorola, at its option, will either repair or replace the product or refund the purchase price thereof, and such action on the part of Motorola shall be the full extent of Motorola's liability hereunder.

This warranty is void if:

- a. the product is used in other than its normal and customary manner;
- b. the product has been subject to misuse, accident, neglect or damage;
- c. unauthorized alterations or repairs have been made, or unapproved parts used in the equipment.

This warranty extends only to individual products, batteries are excluded. Because each radio system is unique, Motorola disclaims liability for range, coverage, or operation of the system as a whole under this warranty except by a separate written agreement signed by an officer of Motorola.

LICENSED PROGRAMS — Motorola software provided in connection with this order is warranted to be free from reproducible defects for a period of one (1) year. All material and labor to repair any such defects will be provided free of charge for the full warranty period, and **SUBJECT TO THE DISCLAIMER IN BOLD FACE TYPE.**

Non-Motorola manufactured products are excluded from this warranty, but subject to the warranty provided by their manufacturers, a copy of which will be supplied to you on specific written request.

In order to obtain performance of this warranty, purchaser must contact its Motorola salesperson or Motorola at the address first above shown, attention Quality Assurance Department.

This warranty applies only within the United States.

EPS-48759-O

FCC INTERFERENCE WARNING

The FCC Requires that manuals pertaining to Class A and Class B computing devices must contain warnings about possible interference with local residential radio and TV reception. This warning reads as follows:

NOTE: This equipment has been tested and found to comply with the limits for a Class B digital device, pursuant to Part 15 of the FCC Rules. These limits are designed to provide reasonable protection against harmful interference when the equipment is operated in a commercial or residential environment. This equipment generates, uses, and can radiate radio frequency energy and, if not installed and used in accordance with the instruction manual, may cause harmful interference to radio communications.

User / Operational Manual

Manual Front Matter (Draft, Continued)

About This Volume

Volume 2 of the Enhanced Base Transceiver System (EBTS) manual, *Base Radios*, provides the experienced service technician with an overview of the EBTS operation and functions, and contains information regarding the 800 MHz, 900 MHz, 800/900 MHz QUAD Channel, and 800/900 MHz QUAD+2 Channel base radios.

The EBTS has three major components:

- Generation 3 Site Controller (Gen 3 SC) or integrated Site Controller (iSC)
- Base Radios (BRs)
- RF Distribution System (RFDS)

Installation and testing is described in Volume 1, *System Installation and Testing*, and RFDS are described in Volume 3, *RF Distribution Systems (RFDS)*. Detailed information about the Gen 3 SC is contained in the *Gen 3 SC Supplement Manual, 68P80801E30*. Detailed information about the iSC is contained in the *iSC Supplement Manual, 68P81098E05*.

The information in this manual is current as of the printing date. If changes to this manual occur after the printing date, they will be documented and issued as Schaumburg Manual Revisions (SMRs).

Audience Profile

The target audience of this document includes field service technicians responsible for installing, maintaining, and troubleshooting the EBTS.

In keeping with Motorola's field replaceable unit (FRU) philosophy, this manual provides sufficient functional information to the FRU level. Please refer to the appropriate section of this manual for removal and replacement instructions.

Manuals On-line

This manual is available on the World Wide Web at *myetworksupport*, the iDEN customer site. This site was created to provide secure access to critical iDEN Infrastructure information. This web site features a library of iDEN Infrastructure technical documentation such as bulletins, system release documents and product manuals.

The documents are located on the secured extranet website at the URL:

<https://myetworksupport.motorola.com>

For information on obtaining an account on this site, go to:

<https://membership.motorola.com/motorola>

User / Operational Manual

Manual Front Matter (Draft, Continued)

General Safety

Important Remember Safety depends on you!!

General safety precautions must be observed during all phases of operation, service, and repair of the equipment described in this manual. Failure to comply with these precautions or with specific warnings elsewhere in this manual violates safety standards of design, manufacture, and intended use of the equipment.

You must heed the safety precautions and warnings listed in the product manuals for your equipment. Any individual using or maintaining the product(s), should follow these warnings and all other safety precautions necessary for the safe operation of the equipment in your operating environment. Motorola, Inc. assumes no liability for failure to comply with these requirements.

Keep Away From
Live Circuits



DANGER

HAZARDOUS VOLTAGE, CURRENT, AND ENERGY LEVELS ARE PRESENT IN THIS PRODUCT. POWER SWITCH TERMINALS CAN HAVE HAZARDOUS VOLTAGES PRESENT EVEN WHEN THE POWER SWITCH IS OFF. DO NOT OPERATE THE SYSTEM WITH THE COVER REMOVED. ALWAYS REPLACE THE COVER BEFORE TURNING ON THE SYSTEM.

Operating personnel must:

- Not remove equipment covers. Only Factory Authorized Service Personnel or other qualified maintenance personnel may remove equipment covers for internal subassembly, or component replacement, or any internal adjustment.
- Not replace components with power cable connected. Under certain conditions, dangerous voltages may exist even with the power cable removed.
- Always disconnect power and discharge circuits before touching them.

User / Operational Manual

Manual Front Matter (Draft, Continued)

General Safety

Ground the Equipment

To minimize shock hazard, the equipment chassis and enclosure must be connected to an electrical earth ground. The power cable must be either plugged into an approved three-contact electrical outlet or used with a three-contact to two-contact adapter. The three-contact to two-contact adapter must have the grounding wire (green) firmly connected to an electrical ground (safety ground) at the power outlet. The power jack and mating plug of the power cable must meet International Electrotechnical Commission (IEC) safety standards.

Electro-Static Discharge

Motorola strongly recommends that you use an anti-static wrist strap and a conductive foam pad when installing or upgrading the system. Electronic components, such as disk drives, computer boards, and memory modules, can be extremely sensitive to Electro-Static Discharge (ESD). After removing the component from the system or its protective wrapper, place the component flat on a grounded, static-free surface, and in the case of a board, component-side up. Do not slide the component over any surface.

If an ESD station is not available, always wear an anti-static wrist strap that is attached to an unpainted metal part of the system chassis. This will greatly reduce the potential for ESD damage.

Do Not Operate In An Explosive Atmosphere

Do not operate the equipment in the presence of flammable gases or fumes. Operation of any electrical equipment in such an environment constitutes a definite safety hazard.

Do Not Service Or Adjust Alone

Do not attempt internal service or adjustment, unless another person, capable of rendering first aid and resuscitation, is present.

Use Caution When Exposing Or Handling a Cathode-Ray Tube

Breakage of the Cathode-Ray Tube (CRT) causes a high-velocity scattering of glass fragments (implosion). To prevent CRT implosion, avoid rough handling or jarring of the equipment. The CRT should be handled only by qualified maintenance personnel, using approved safety mask and gloves.

Do Not Substitute Parts Or Modify Equipment

Because of the danger of introducing additional hazards, do not install substitute parts or perform any unauthorized modification of equipment. Contact Motorola Warranty and Repair for service and repair to ensure that safety features are maintained.

User / Operational Manual

Manual Front Matter (Draft, Continued)

GENERAL SAFETY INFORMATION

The following general safety precautions must be observed during all phases of operation, service, and repair of the equipment described in this manual. The safety precautions listed below represent warnings of certain dangers of which we are aware. You should follow these warnings and all other safety precautions necessary for the safe operation of the equipment in your operating environment.

General Safety Precautions

- ▶ Read and follow all warning notices and instructions marked on the product or included in this manual before installing, servicing or operating the equipment. Retain these safety instructions for future reference. Also, all applicable safety procedures, such as Occupational, Safety, and Health Administration (OSHA) requirements, National Electrical Code (NEC) requirements, local code requirements, safe working practices, and good judgement must be used by personnel.
- ▶ Refer to appropriate section of the product service manual for additional pertinent safety information.
- ▶ Because of danger of introducing additional hazards, do not install substitute parts or perform any unauthorized modifications of equipment.
- ▶ Identify maintenance actions that require two people to perform the repair. Two people are required when:
 - A repair has the risk of injury that would require one person to perform first aid or call for emergency support. An example would be work around high voltage sources. A second person may be required to remove power and call for emergency aid if an accident occurs to the first person.
Note Use the National Institute of Occupational Safety and Health (NIOSH) lifting equation to determine whether a one or two person lift is required when a system component must be removed and replaced in its rack.
- ▶ If troubleshooting the equipment while power is applied, be aware of the live circuits.
- ▶ DO NOT operate the transmitter of any radio unless all RF connectors are secure and all connectors are properly terminated.
- ▶ All equipment must be properly grounded in accordance with Motorola Standards and Guideline for Communications Sites "R56" 68P81089E50 and specified installation instructions for safe operation.
- ▶ Slots and openings in the cabinet are provided for ventilation. To ensure reliable operation of the product and to protect it from overheating, these slots and openings must not be blocked or covered.
- ▶ Only a qualified technician familiar with similar electronic equipment should service equipment.
- ▶ Some equipment components can become extremely hot during operation. Turn off all power to the equipment and wait until sufficiently cool before touching.

Human Exposure Compliance

This equipment is designed to generate and radiate radio frequency (RF) energy by means of an external antenna. When terminated into a non-radiating RF load, the base station equipment is certified to comply with Federal Communications Commission (FCC) regulations pertaining to human exposure to RF radiation in accordance with the FCC Rules Part 1 section 1.1310 as published in title 47 code of federal regulations and procedures established in TIA/EIA TSB92, Report On EME Evaluation for RF Cabinet Emissions Under FCC MPE Guidelines. Compliance to FCC regulations of the final installation should be assessed and take into account site specific characteristics

User / Operational Manual

Manual Front Matter (Draft, Continued)

such as type and location of antennas, as well as site accessibility of occupational personnel (controlled environment) and the general public (uncontrolled environment). This equipment should only be installed and maintained by trained technicians. Licensees of the FCC using this equipment are responsible for insuring that its installation and operation comply with FCC regulations Part 1 section 1.1310 as published in title 47 code of federal regulations.

Whether a given installation meets FCC limits for human exposure to radio frequency radiation may depend not only on this equipment but also on whether the "environments" being assessed are being affected by radio frequency fields from other equipment, the effects of which may add to the level of exposure. Accordingly, the overall exposure may be affected by radio frequency generating facilities that exist at the time the licensee's equipment is being installed or even by equipment installed later. Therefore, the effects of any such facilities must be considered in site selection and in determining whether a particular installation meets the FCC requirements.

FCC OET Bulletin 65 provides materials to assist in making determinations if a given facility is compliant with the human exposure to RF radiation limits. Determining the compliance of transmitter sites of various complexities may be accomplished by means of computational methods. For more complex sites direct measurement of the power density may be more expedient. Additional information on the topic of electromagnetic exposure is contained in the Motorola Standards and Guideline for Communications Sites publication. Persons responsible for installation of this equipment are urged to consult the listed reference material to assist in determining whether a given installation complies with the applicable limits.

In general the following guidelines should be observed when working in or around radio transmitter sites:

- ▶ All personnel should have electromagnetic energy awareness training
- ▶ All personnel entering the site must be authorized
- ▶ Obey all posted signs
- ▶ Assume all antennas are active
- ▶ Before working on antennas, notify owners and disable appropriate transmitters
- ▶ Maintain minimum 3 feet clearance from all antennas
- ▶ Do not stop in front of antennas
- ▶ Use personal RF monitors while working near antennas
- ▶ Never operate transmitters without shields during normal operation
- ▶ Do not operate base station antennas in equipment rooms

For installations outside of the U.S., consult with the applicable governing body and standards for RF energy human exposure requirements and take the necessary steps for compliance with local regulations.

References

TIA/EIA TSB92 "Report On EME Evaluation for RF Cabinet Emissions Under FCC MPE Guidelines," Global Engineering Documents: <http://global.ihs.com/>

FCC OET Bulletin 65 "Evaluating Compliance with FCC Guidelines for Human Exposure to Radiofrequency Electromagnetic Fields": <http://www.fcc.gov/oet/rfsafety/>.

Motorola Standards and Guideline for Communications Sites, Motorola manual 68P81089E50.

IEEE Recommended Practice for the Measure of Potentially Hazardous Electromagnetic Fields – RF and Microwave, IEEE Std C95.3 – 1991, Publication Sales, 445 Hoes Lane, P.O. Box 1331, Piscataway, NJ 08855–1331

IEEE Standard for Safety Levels with Respect to Human Exposure to Radio Frequency Electromagnetic Fields, 3 kHz to 300 GHz, IEEE C95.1 – 1991, Publication Sales, 445 Hoes Lane, P.O. Box 1331, Piscataway, NJ 08855–1331.

User / Operational Manual

Specifications (Draft)

Gen3 Base Radio General Specifications

Specification	Value or Range
Dimensions:	
Height	5.25" (133 mm)
Width	19" (482.6 mm)
Depth	18" (457 mm)
Weight	45 lbs. (20 kg)
Operating Temperature	32° to 122° F (0° to 50° C)
Storage Temperature	-22° to 140° F (-30° to 60° C)
Rx Frequency Range:	806 - 902 MHz
Tx Frequency Range:	851 - 941 MHz
Tx – Rx Spacing:	
800 MHz iDEN	45 MHz
900 MHz iDEN	39 MHz
Carrier Spacing	25 kHz
Carrier Capacity	1
Frequency Generation	Synthesized
Digital Modulation	QPSK, M-16QAM, and M-64QAM
Power Supply Inputs:	
VDC	-48 VDC (-41 to -60 VDC)
VAC	
Diversity Branches	Up to 3

Gen3 Base Radio Receive Specifications

Specification	Value or Range
Static Sensitivity †: 800/900 MHz BR	-108 dBm (BER = 8%)
BER Floor (BER = 0.01%)	≥ -80 dBm
IF Frequencies	
1st IF (All bands):	73.375 MHz
2nd IF:	450 kHz (2nd IF)
Frequency Stability *	1.5 ppm

User / Operational Manual

Specifications (Draft) (Continued)

Gen3 Base Radio Receive Specifications (Continued)

Specification	Value or Range
RF Input Impedance	50 Ω (nom.)
FCC Designation (FCC Rule Part 15):	ABZ89FR5816

Note † Measurement referenced from single receiver input port of BR.

Note * Stability without site reference connected to station. Receive frequency stability locks to an external site reference, which controls ultimate frequency stability to a level of 50 ppb.

Gen3 Base Radio Transmit Specifications

Specification	Value or Range	
	Low average output power per carrier	High average output power per carrier
Average Power Output: (800/900 MHz) Single Carrier	5.0W	70W/52.0W
Transmit Bit Error Rate (BER)	0.01%	
Occupied Bandwidth	17.7 kHz for single carrier	
Frequency Stability *	1.5 ppm	
RF Input Impedance	50 Ω (nom.)	
FCC Designation (FCC Rule Part 90):	ABZ89FC5815	

Note * Transmit frequency stability locks to an external site reference, which controls ultimate frequency stability to a level of 50 ppb.

User / Operational Manual

Field Replaceable Units and Orderable Parts (Draft)

Field replaceable units, or FRUs, include special packaging to allow shipment to customers. Parts and FRUs available for customer order are listed in this section. All parts and FRUs are sourced through the Radio Products and Service Division (RPSD).

Structure of Part / FRU #	Description
T7423A	iDEN Gen3 800 / 900 MHz Base Radio
CLF1847A	Power Amplifier Tanapa
CLF6542A	Combiner board (New kit number for 800/900)
CLF6506E	PA Driver module
CLF6530B	PA Final
CLF6531C	PA Low Pass Filter
CLN8053E	PA DC Board
CLN8117C	NULL Modulator Board
CLF6547A	PA Housing Kit
0174000A75	PA Mechanics specific
0173000A19	PA Heatsink and Cover
PCUF1003B	Transceiver, Single Carrier 800 / 900 MHz
MCPN1085A	BR DC/DC Power Supply Tanapa
0180706H71	Chassis and Backplane
CLN8251B	BR Card Cage Kit
0173000A67	RF cable, retainer clip, and RJ45 plugs
CLN8332A	Blank Panel 2U rack filler w/ Hardware
CLN8333A	FCC Label
CLN1834A	iDEN Gen3 800 / 900 MHz Base Radio Super Tanapa
0180706H35	Fan Assembly
X899AF	BR FRU packing option (must be added to order for BR to ship standalone)
CBN6250B	BR Packing kit
DLN1399A	iDEN Gen3 Transceiver FRU number
PCUF1003B	Transceiver, 6 Channel 800 / 900 MHz
CBN6239A	PA / Transceiver Packing kit
DLN1401A	Power Amplifier FRU number
CLF1847A	Power Amplifier Tanapa
CBN6239A	PA / Transceiver Packing kit
DLN1400A	iDEN Gen3 DC Power Supply FRU number
MCPN1085A	BR DC/DC Power Supply Tanapa
CBN6240A	Power Supply Packing kit
DLN6657A	Fan Assembly FRU number
0180706H35	Fan Assembly Tanapa
CBN6244A	Fan Packing kit

User / Operational Manual

Tune-Up Procedure

There is no field tune-up procedure. All adjustments are software controlled and are pre-set at the factory. Certain station operating parameters can be changed via man-machine interface (MMI) commands, within predetermined limits. Examples include transmit / receiver operating frequencies and transmitter power level.

User / Operational Manual

Functional Description / Operation of Modules (Draft)

The following pages are excerpts from the manual and are intended to give an overview of the base radio and the modules that comprise the base radio.

The Gen3 Base Radio is very similar to a previous product, the Quad+2 Base Radio. The main differences between the two products are 1) the power supply is DC-only; and 2) the Gen3 BR is capable of a single Transmit / Receive RF channel, whereas the Quad+2 BR was capable of up to 6 contiguous RF channels. What follows is draft copy of the Quad+2 BR manual sections edited for use with Gen3. The content of the finalized Gen3 BR manual will be similar to what is shown here.

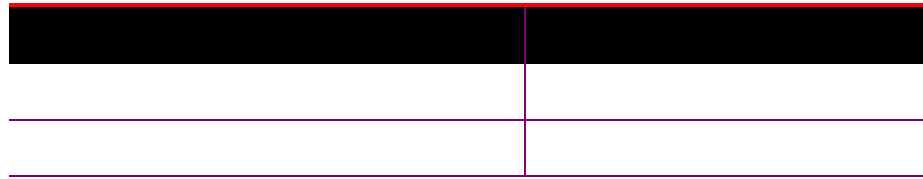

Gen3 Base Radio Theory of Operation

The Gen3 BR operates together with other site controllers and equipment that are properly terminated. The following description assumes such a configuration. Figure 1-11 shows an overall block diagram of the BR.

Power is applied to the DC Power inputs located on the Gen3 BR backplane. The DC Power input is connected if -48 VDC or batteries are used in the site.

Power is applied to the BR by setting the Power Supply power switch to the ON position. Upon power-up, the Gen3 BR performs self-diagnostic tests to ensure the integrity of the unit. These tests, which include memory and Ethernet verification routines, primarily examine the EX / CNTL.

After completing self-diagnostic tests, the Gen3 BR reports alarm conditions on any of its modules to the site controller via Ethernet. Alarm conditions may also be verified locally. Local verification involves using the service computer and the STATUS port located on the front of the Gen3 BR.

The software resident in FLASH on the XCVR registers the BR with the site controller via Ethernet. After BR registration on initial power-up, the BR software downloads via Ethernet and executes from RAM. The download includes operating parameters for the BR. These parameters allow the BR to perform call processing functions.

5-May-08

After software downloads to the BR via Ethernet, FLASH memory stores the software object. Upon future power-ups, the software object in FLASH loads into RAM for execution.

The BR operates in a TDMA (Time Division Multiple Access) mode. This mode, combined with voice compression techniques, increases channel capacity by a ratio of as much as six to one. TDMA divides both the receive and transmit signals of the BR into six individual time slots. Each receive slot has a corresponding transmit slot. This pair of slots comprises a logical RF channel.

The BR uses diversity reception for increased coverage area and improved quality. The Receiver module within the Gen3 BR contains three receiver paths. Two-branch diversity sites use two Receiver paths, and three-branch diversity sites use three Receiver paths.

All Receiver paths within the Transceiver module are programmed to the same receiver frequency. Signals from each receiver are diversity combined and undergo error-correction. Then, via Ethernet, the site controller acquires the signal, along with control information about signal destination.

Two separate FRUs comprise the transmit section of the Gen3 BR. These are the Exciter and Control (XCVR) portion of the Transceiver and the Power Amplifier (PA). The Exciter processes commands from the CNTL, assuring transmission in the proper modulation format. Then the low-level signal enters the PA. The PA amplifies this signal to the desired output power level. The PA is a continuously keyed linear amplifier. A power control routine monitors the output power of the BR. The routine adjusts the power as necessary to maintain the proper output level.

5-May-08

Overview

Overview

This chapter provides information on the Gen3 Base Radio Transceiver (XCVR).

FRU Number to Kit Number Cross Reference

Base Radio Transceiver (XCVR) Field Replaceable Units (FRUs) are available for the iDEN EBTS. The FRU contains the XCVR kit and required packaging. Table 3-1 provides a cross reference between XCVR FRU numbers and kit numbers.

Table 3-1 FRU Number to Kit Number Cross Reference

Description	FRU Number	Kit Number
Gen3 Base Radio Transceiver	DLN1399	PCUF1003

5-May-08

Gen3 Base Radio Transceiver

Gen3 Base Radio Overview

The transceiver (XCVR) module provides the control, exciter and receiver functions for the Base Radio.

The XCVR generates the station reference which typically needs to be locked on to one of many possible external sources. The external source can be either the site controller 20 MHz TDM clocks or the external reference operating at 5 or 10 MHz.

The XCVR SPI bus allows communication with its receiver and exciter circuitry, as well as the power supply and power amplifier modules.

The XCVR circuit board contains two major sections:

- n XCVR Control : Performs the control management, digital signal processing, and transmit and receive data formatting for the Base Radio.
- n XCVR RF : Contains DC power conversion/regulation and performs receiver and exciter functions.

Figure 3-1 shows a top view of the Transceiver.

Figure 3-1 800/900 MHz Gen3 Channel Transceiver (Front View)



Transceiver Control Section

The main operating software for the base radio is loaded in the XCVR's control section. As the main manager for the base radio, the XCVR control provides operational control over the other station modules. It handles three types of information flow, in the following ways:

- n Serves as a gateway between the network and RF functionality, by distributing the RF payload to and from the network
- n Supports operational and diagnostic functions with digital control data (for example: site information, channel assignments, and identification numbers for call processing)
- n Ensures the flow of other network management configuration information

Figure 3-2 shows the information flow through the transceiver Control and RF sections for HPD systems.

Figure 3-2 800/900 MHz Gen3 Transceiver Information Flow

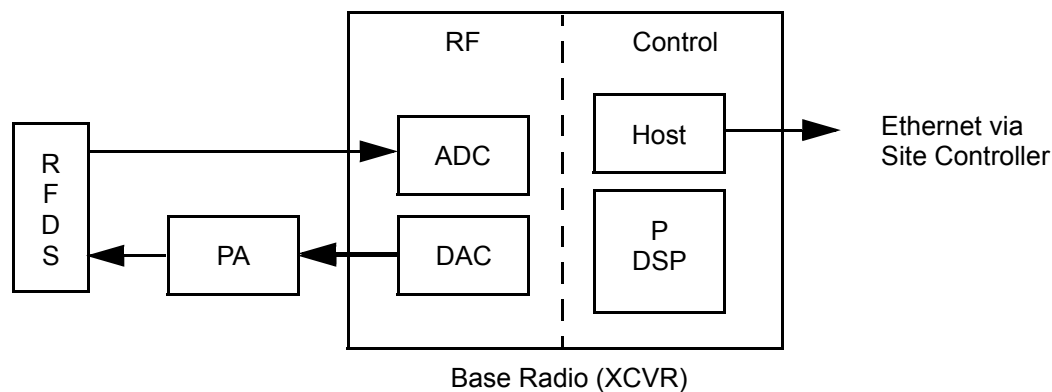

Transceiver RF Section

In addition to DC power conversion/regulation, the XCVR RF section provides circuitry for the following receiver and exciter functions.

Exciter

The exciter on the XCVR RF section provides the transmitter functions for the base radio. The exciter circuitry generates a low-level, modulated RF signal that passes to the power amplifier. It supports various modulation types as well as bandwidths up to 25 kHz, through software programming.

The exciter also provides a controlled output power level to the power amplifier.

*Gen3 Base Radio Transceiver***Receiver**

The Gen3 receiver provides multiple receiver inputs for one to three diversity branches with multiple channels of up to six channels within each branch. The receiver is tuned to pass frequencies anywhere between 806 MHz and 901 MHz. The receiver is best suited for:

- n Low density RF environments
- n Stations with external multicouplers
- n Stations with requirements for multi-frequency operation beyond 14 MHz

Controls and Indicators

The transceiver external interfaces include 2 external ports, a switch and LEDs. The ports and switch are described here. The LED states are listed in the reference section of the documentation. Figure 3-3 shows the port, switch and LED locations when the access door is opened. Figure 3-4 shows the Rear View connectors.

Figure 3-3 800/900 MHz Gen3 Transceiver (with access door opened)

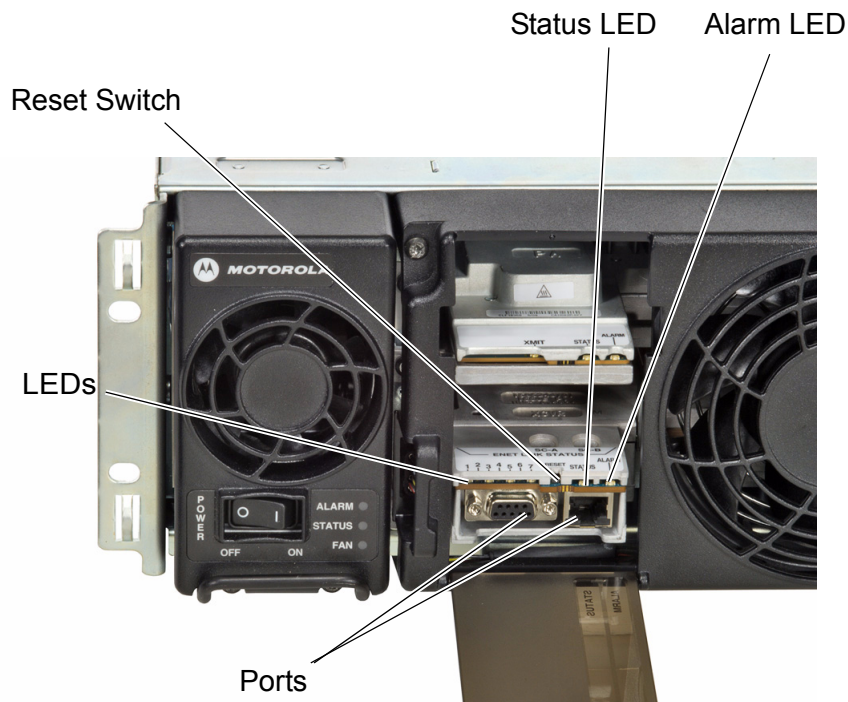
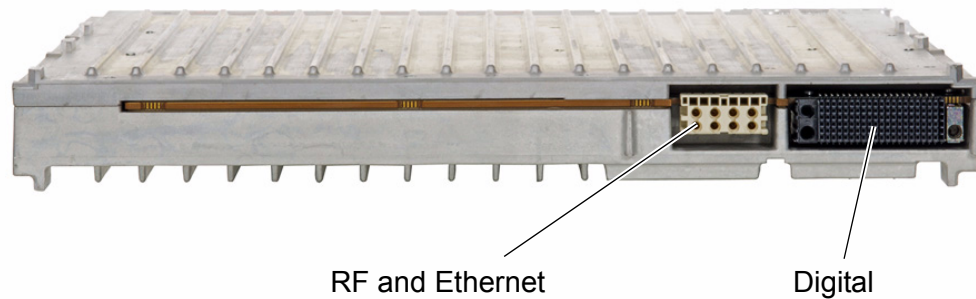

Figure 3-4 800/900 MHz Gen3 Transceiver Backplane (Rear View)

Transceiver Ports - Front

Two ports are accessible via a dropdown door to the left of the fans. An asynchronous port and a synchronous port.

Table 3-2 Transceiver Connections

XCVR Port / Type	Connects to this Device/Port	Description
RJ-45	10/100BaseT port	Ethernet port for future use.
Service port, DB-9	Service PC, RS-232 port	Serial service port for configuration.

Transceiver Ports - Rear

The transceiver interconnects to the backplane using a 120-pin HVDML digital connector and 8-pack RF connector, as shown in Figure 3-4. These connections handle multiple signals including power, power supply communications, power amplifier communications, 10Base2 Ethernet, fan interface and peripheral interface. The digital connection receives alarm data and the site controllers' TDM signals, which are used to pass reference and control data to the station.

Transceiver Switch

There is one multifunction switch on the front of the transceiver module, accessible via the dropdown door to the left of the fans.

Gen3 Base Radio Transceiver

Table 3-3 lists the Transceiver Front Switch Functions.

Table 3-3 XCVR Front Switch Functions

User Action	Result
Press switch for less than 1 second	Access Disable
Press switch for greater than 3 seconds	Transceiver Control Module Reset

Transceiver LEDs

Table 3-4 and Table 3-5 lists the Transceiver LEDs. \

Table 3-4 Gen3 Base Radio Status and Alarm LED Indications

Condition	Status LED	Alarm LED
No Power	Off	Off
Lamp Test	Green	Red
Failure	Off	Red
Impaired	Green	Red (blinking)
Booting Up	Green (blinking)	Off
Online	Green	Off

Table 3-5 Gen3 Base Radio Transceiver LED Indications

Label	LED State	Description
1	Green	Proper Base Radio operation with no alarm conditions and channel 1 is keyed
	Green (Blinking)	Channel 1 is not keyed
	Off	Channel 1 is not in operation or the Base Radio is out of service or power is removed
2	Green	Proper Base Radio operation with no alarm conditions and channel 2 is keyed
	Green (Blinking)	Channel 2 is not keyed
	Off	Channel 2 is not in operation or the Base Radio is out of service or power is removed

Gen3 Base Radio Transceiver

Table 3-5 Gen3 Base Radio Transceiver LED Indications (continued)

Label	LED State	Description
3	Green	Proper Base Radio operation with no alarm conditions and channel 3 is keyed
	Green (Blinking)	Channel 3 is not keyed
	Off	Channel 3 is not in operation or the Base Radio is out of service or power is removed
4	Green	Proper Base Radio operation with no alarm conditions and channel 4 is keyed
	Green (Blinking)	Channel 4 is not keyed
	Off	Channel 4 is not in operation or the Base Radio is out of service or power is removed
5 (See Note)	Green	Proper Base Radio operation with no alarm conditions and channel 5 is keyed
	Green (Blinking)	Channel 5 is not keyed
	Off	Channel 5 is not in operation or the Base Radio is out of service or power is removed
6 (See Note)	Green	Proper Base Radio operation with no alarm conditions and channel 6 is keyed
	Green (Blinking)	Channel 6 is not keyed
	Off	Channel 6 is not in operation or the Base Radio is out of service or power is removed

Note Five and six carrier operation is only supported in Test Application mode and requires licensing agreement with Motorola for activation in Call Processing mode.

Transceiver Band States

Table 3-6 lists the Transceiver Band States

Table 3-6 Gen3 Base Radio Band State

Label	LED State	BR Band
7	Solid Red	Install Band Failure
	Solid Green	800 MHz
	Solid Amber	900 MHz

Gen3 Base Radio Transceiver

Table 3-3 lists the Transceiver Front Switch Functions.

Table 3-3 XCVR Front Switch Functions

User Action	Result
Press switch for less than 1 second	Access Disable
Press switch for greater than 3 seconds	Transceiver Control Module Reset

Transceiver LEDs

Table 3-4 and Table 3-5 lists the Transceiver LEDs. \

Table 3-4 Gen3 Base Radio Status and Alarm LED Indications

Condition	Status LED	Alarm LED
No Power	Off	Off
Lamp Test	Green	Red
Failure	Off	Red
Impaired	Green	Red (blinking)
Booting Up	Green (blinking)	Off
Online	Green	Off

Table 3-5 Gen3 Base Radio Transceiver LED Indications

Label	LED State	Description
1	Green	Proper Base Radio operation with no alarm conditions and channel 1 is keyed
	Green (Blinking)	Channel 1 is not keyed
	Off	Channel 1 is not in operation or the Base Radio is out of service or power is removed
2	Green	Proper Base Radio operation with no alarm conditions and channel 2 is keyed
	Green (Blinking)	Channel 2 is not keyed
	Off	Channel 2 is not in operation or the Base Radio is out of service or power is removed

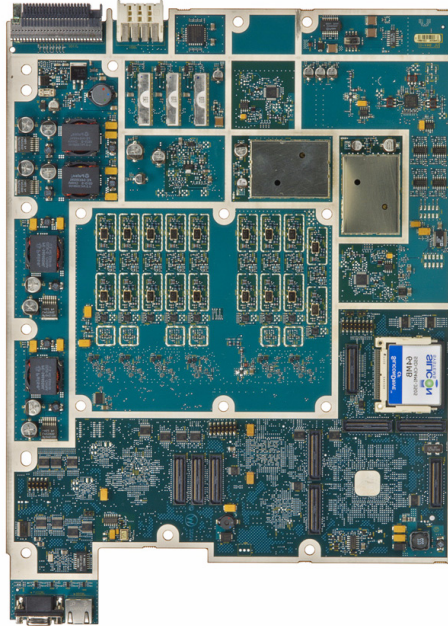
Figure 3-5 Controller Section (with housing removed)

Host Microprocessor

The host microprocessor is the main controller for the BR. The processor operates at a 266-MHz core clock speed. The processor controls Base Radio operation according to station software in memory. Station software resides in FLASH memory. For normal operation, the system transfers this software to volatile S-DRAM memory.

Note At BR power-up and normal conditions, the Status and Alarm LEDs transition through the Conditions stated in Table 3-4 as follows: Power Off, Failure, Lamp Test, Booting Up and Online states as indicated in Table 3-4. Any other sequence of Conditions indicates an impairment or failure.

Serial Communication Buses

The microprocessor provides a general-purpose SMC serial management controller bus.

Gen3 Base Radio Transceiver

Table 3-3 lists the Transceiver Front Switch Functions.

Table 3-3 XCVR Front Switch Functions

User Action	Result
Press switch for less than 1 second	Access Disable
Press switch for greater than 3 seconds	Transceiver Control Module Reset

Transceiver LEDs

Table 3-4 and Table 3-5 lists the Transceiver LEDs. \

Table 3-4 Gen3 Base Radio Status and Alarm LED Indications

Condition	Status LED	Alarm LED
No Power	Off	Off
Lamp Test	Green	Red
Failure	Off	Red
Impaired	Green	Red (blinking)
Booting Up	Green (blinking)	Off
Online	Green	Off

Table 3-5 Gen3 Base Radio Transceiver LED Indications

Label	LED State	Description
1	Green	Proper Base Radio operation with no alarm conditions and channel 1 is keyed
	Green (Blinking)	Channel 1 is not keyed
	Off	Channel 1 is not in operation or the Base Radio is out of service or power is removed
2	Green	Proper Base Radio operation with no alarm conditions and channel 2 is keyed
	Green (Blinking)	Channel 2 is not keyed
	Off	Channel 2 is not in operation or the Base Radio is out of service or power is removed

Gen3 Base Radio Transceiver

Non-Volatile Memory

Base Radio software resides in a minimum of 32M x 16 bits of Compact FLASH memory and 16M x 16 bits of additional board FLASH. The Host Microprocessor addresses the Compact FLASH memory with 4 of the host address bus' 32 lines in conjunction with the data lines. The host accesses FLASH data over the 16-line host data bus. A host-operated chip-select line provides control signals for these transactions.

FLASH memory contains the operating system and application code. The system stores application code in Compact FLASH for fast recovery from reset conditions. Application code transfers from network or site controllers may occur in a background mode. Background mode transfers allow the station to remain operational during new code upgrades.

The data that determines the station personality (codeplug) resides in the 16M x 16 bit FLASH. The microprocessor addresses the FLASH with 24 of the host address bus' 32 lines. The host accesses FLASH data with 16 of the data bus' 32 lines. A host-operated chip-select line provides control signals for these transactions.

During the manufacturing process, the factory programs the codeplug's default data. The BRC must download field programming data from network and site controllers. This data includes operating frequencies and output power level. The station permits adjustment of many station parameters, but the station does not store these adjustments. Refer to the Software Commands chapter for additional information.

Volatile Memory

Each BRC contains 16MB x 32 bits of SDRAM. The BRC downloads station software code into SDRAM for station use. SDRAM also provides short-term storage for data generated and required during normal operation. SDRAM is volatile memory. A loss of power or system reset destroys SDRAM data.

The system performs read and write operations over the Host Address and Data buses. These operations involve column and row select lines under control of the Host processor's DRAM controller. The Host address bus and column row signals sequentially refresh SDRAM memory locations.

Ethernet Interface

The Host processor's Communications Processor Module (CPM) provides the Local Area Network (LAN) Controller for the Ethernet Interface. The LAN function implements the CSMA/CD access method, which supports the IEEE 802.3 10Base2 standard.

The LAN coprocessor supports all IEEE 802.3 Medium Access Control, including the following:

Gen3 Base Radio Transceiver

- n framing
- n preamble generation
- n stripping
- n source address generation
- n destination address checking

The PCM LAN receives commands from the CPU.

The Ethernet Serial Interface works directly with the CPM LAN to perform the following major functions:

- n 10 MHz transmit clock generation (obtained by dividing the 20 MHz signal provided by on-board crystal)
- n Manchester encoding/decoding of frames
- n electrical interface to the Ethernet transceiver

An isolation transformer provides high-voltage protection. The transformer also isolates the Ethernet Serial Interface (ESI) and the transceiver. The pulse transformer has the following characteristics:

- n Minimum inductance of 75 μ H
- n 2000 V isolation between primary and secondary windings
- n 1:1 Pulse Transformer

The Coaxial Transceiver Interface (CTI) is a coaxial cable line driver and receiver for the Ethernet. CTI provides a 10Base2 connection via a coaxial connector on the board. This device minimizes the number of external components necessary for Ethernet operations.

A DC/DC converter provides a constant voltage of -9 Vdc for the CTI from a 3.3 Vdc source.

The CTI performs the following functions:

- n Receives and transmits data to the Ethernet coaxial connection
- n Reports any collision that it detects on the coaxial connection
- n Disables the transmitter when packets are longer than the legal length (Jabber Timer)

Digital Signal Processors

The BRC includes one Digital Signal Processor for receive and transmit processing. This DSP and related circuitry process compressed station transmit and receive audio and data. The related circuitry includes the Integrated Circuit (2QIC). The DSP only accepts input and output signals in digitized form.

Gen3 Base Radio Transceiver

The DSP inputs are digitized receiver signals. The DSP outputs are digitized voice audio and data (modulation signals). These signals pass from the DSP to the Exciter section of the Gen3. DSP communicates with the Microprocessor via a 32-bit, host data bus on the host processor side. Interrupts drive communication between the DSP and the host.

The DSP operate from an external 49 MHz clock, provided by the CPLD and phase locked to the 16.8 MHz local station reference clock. The DSP internal core operating clock signal is 394MHz, produced by an internal Phase-Locked Loop (PLL).

The DSP accepts receive digitized signals from the 2QIC through the Time-Division Multiplexing (TDM) interface ports. The Gen3 uses 3 of these ports. All 3 ports use the same clock and framesync signals to input data. Each port handles digital data for 1 of the 3 branches. Each port handles digitized data for 6 channels, 2 status words, and 2 power detect words.

The Gen3 accesses its DSP program and signal-processing algorithms in 1440 kB of internal memory. The DSP communicates with the host bus over an 32-bit interface.

The DSP communicates with the 2QIC to provide serial communications to the receiver paths for receiver control over a Serial Peripheral Interface (SPI) link. The 2QIC provides a parallel-to-serial conversion circuit that accepts parallel data from the DSP and serial data to the receive circuitry.

The DSP sends up to six carriers of digitized signal to the 2QIC along with embedded control signals. Two framed and synchronized data streams are output. One data stream is I-data, and the other is the Q-data stream. The control bits are appended at the end of the data streams. The 2QIC extracts and applies the control signals. The 2QIC synchronizes the 2QIC I and Q output frames with system timing signals that exist in the 2QIC. The synchronized outputs are sent to a Digital to Analog Converter (DAC) in the exciter section that converts the digital signals to analog.

2QICplus

The 2QIC controls internal DSP operations. This circuit provides the following functions:

The 2QICplus is a DSP programmable FPGA that provides the circuit integration needed to condition, route and control receive and transmit data between the RF circuitry and the DSP, and provide consolidated monitoring and control for transceiver. Following are the major functions of the 2QICplus

- n For nitialization and control, the 2QICplus interfaces with the DSP through address and data buses.
- n Provides six Independent Abacus III receiver data and control interfaces with fault detection and handling

Gen3 Base Radio Transceiver

- n RF Signal Gain Control for 18 receiver paths
- n Programmable General-Purpose Input/Output pins for monitor and control of the transceiver
- n Provides clocks required for the transceiver
- n Phase detector for the 16.8MHz Synthesizer and PLL with PLL steering line gate control
- n Inputs a site reference signal, demodulates a 1PPS timing marker from this signal and outputs the 1PPS signal for network timing alignment.
- n 15 ms and 7.5 ms timing signals generation. (These signals are synchronize to the 1 PPS time mark. The system decodes the time mark from the site reference. Then the system routes the reference to the DSP.)
- n Programmable Interrupt Controller for metering and status.
- n Provides serial transmit data translation and transmit control and synchronization to the network timing
- n Complex Mixer capability to translate each of the six receive channels to DC
- n Polyphase 256 FIR filter with decimation by 10 for enhancing channel selectivity
- n Signal Energy detector for signal strength indication used for system signal path attenuator control
- n Provides output serializers to Time Division Multiplex information for six channels two status values and two Energy Detection values for each branch

Station Reference Circuitry

The Station Reference Circuitry is a phase-locked loop (PLL). This PLL consists of a high-stability, Voltage-Controlled, Crystal Oscillator (VCXO) and a PLL IC. GPS output from the iSC connects to the 5 MHz/1 PPS BNC connector on the BR backplane. Wiring at this connector routes signals to EXBRC station reference circuitry.

The PLL compares the 5 MHz reference frequency to the 16.8 MHz VCXO output. Then the PLL generates a DC correction voltage. The PLL applies this correction voltage to the VCO through an analog gate. The analog gate closes when three conditions coexist: (1) The 5 MHz tests stable. (2) The PLL IC is programmed. (3) Two PLL oscillator and reference signal output alignments occur.

A loss of the 5 MHz/1PPS signal causes the control voltage enable switch to open. This permits the PLL to free run, which allows the BR to retain a clock for control purposes.

When the gate enables, the control voltage from the PLL can adjust the high-stability VCXO frequency. The adjustment can achieve a stability nearly equivalent to that of the external, 5 MHz frequency reference.

Gen3 Base Radio Transceiver

The correction voltage from the PLL continuously adjusts the VXCO frequency. The VXCO outputs a 16.8 MHz clock signal. The circuit applies this clock signal to the receiver, 48 MHz reference and TISIC.

The receivers use the 16.8MHz as the clock input and synthesizer reference.

The 48 MHz EXBRC synthesizer uses the 16.8 MHz as its synthesizer reference. The 48 MHz synthesizer output is the clock input for the TXDSP I and Q data reclock circuitry.

The TISIC divides the 16.8 MHz signal by seven, and outputs a 2.4 MHz signal. This output signal then becomes the 2.4 MHz reference for the Exciter.

Input Ports

One general-purpose input register provides for BRC and station circuit input signals. The register has 16 input ports. The Host Data Bus conveys input register data to the Host Microprocessor. Typical inputs include 16.8 and 48 MHz Station Reference Circuitry status outputs and reset status outputs.

Output Ports

Two general-purpose output registers distribute control signals from the Host Microprocessor to the BRC and station circuitry. One register has 32 output ports and the other register has 8 output ports. Control signal distribution occurs over the backplane. The Host Data Bus drives the output ports' latched outputs. Typical control signals include front-panel LED signals and SPI peripheral enable and address lines.

Remote Station Shutdown

The BRC contains power supply shutdown circuitry. This circuitry can send a shutdown pulse to the Base Radio Power Supply. BRC software generates the shutdown control pulse.

After receiving a shutdown pulse, the power supply turns off BR power. Shut down power sources include 3.3, 28.6 and 14.2 Vdc sources throughout the BR. Due to charges retained by BR storage elements, power supply voltages may not reach zero. The shutdown only assures that the host processor enters a power-on-reset state.

A remote site uses the shutdown function to perform a hard reset of all BR modules.

Theory of Operation - Exciter and Power Amplifier Section

The Exciter and the Power Amplifier (PA) provide the transmitter functions of the Gen3 800/900 MHz Base Radio. The Exciter module consists of a printed circuit board, a slide in housing, and associated hardware. The BRC shares the printed circuit board and housing.

The Exciter connects to the Base Radio backplane through a 168-pin connector and two blindmate RF connectors. Controller and exciter circuitry also interconnect on the Exciter/Controller module. Two Torx screws on the front of the Exciter secure it to the chassis.

An LED identifies the Exciter's operational condition, as described in the manual's Controller section. The Base Radio section of the manual provides specifications for transmitter circuitry. This information includes data on the Exciter and PAs.

RF- Exciter Board

Table 3-8 describes the basic circuitry of the Exciter. Figure 3-6 shows the Exciter with the housing removed. Figure 3-9 show the Exciter's functional block diagram.

Table 3-8 Exciter Board Circuitry

Circuit	Description
LNODCT IC	<ul style="list-style-type: none"> Up-converts baseband data to the transmit frequency Down-converts the PA feedback signal to baseband Uses a baseband Cartesian feedback loop system, necessary to obtain linearity from the transmitter and avoid splattering power into adjacent channels Performs training functions for proper linearization of the transmitter
Memory & A/D Converter	Serves as the main interface between the synthesizer, Tranlin IC, A/D, and EEPROM on the Exciter, and the BRC via the SPI bus
Frequency Synthesizer Circuitry	<ul style="list-style-type: none"> Consists of a phase-locked loop and VCO Provides a LO signal to the LNODCT IC for the second up-conversion and first down-conversion of the feedback signal from the PA
1025 MHz VCO (900 MHz BR)	Provides a LO signal to the LNODCT IC, for up-conversion to the transmit frequency

Table 3-8 Exciter Board Circuitry

Circuit	Description
90.3 MHz VCO (900 MHz BR)	Provides a LO signal to LNODCT IC, for the up-conversion and for the down-conversion of the feedback signal. The mixed output becomes the LO signal for Transmit signal up- and down- conversion
Regulator Circuitry	Provides a regulated voltage to various ICs and RF devices located on the Exciter
Linear RF amplifier Stages	Amplifies the RF signal from the Exciter IC to an appropriate level for input to the PA

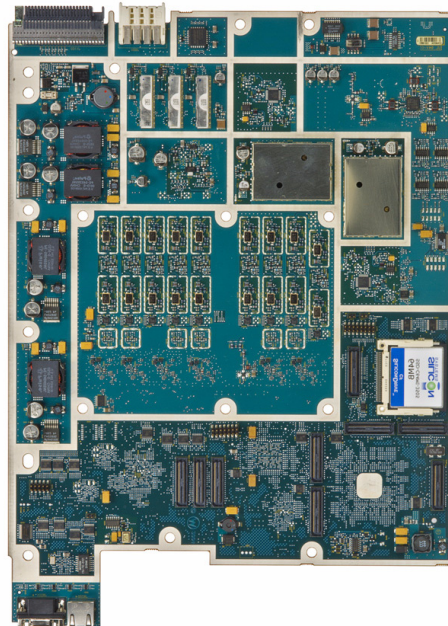
Figure 3-6 Exciter Board (with housing removed)

Memory Circuitry

The memory circuitry is an EEPROM on the Controller portion of the Exciter/Controller module. The Controller performs memory read and write operations over the parallel bus. The memory device stores the following data...

- n kit number
- n revision number
- n module specific scaling and correction factors
- n serial number
- n free form information (scratch pad)

A/D Converter Circuitry

Analog signals from various areas throughout the Exciter board enter the A/D converter (A/DC). The A/DC converts these analog signals to digital form. Upon request of the BRC, A/DC output signals enter the BRC via SPI lines. The Controller periodically monitors all signals.

Some of the monitored signals include amplifier bias and synthesizer signals.

Low Noise Offset Direct Conversion Transmit (LNODCT) IC Circuitry

The Low Noise IC is a main interface between the Exciter and BRC. The BRC's Digital Signal Processor (DSP) sends digitized signals (baseband data) to the Exciter over the DSP data bus.

The differential data clock signal serves as a 2.4 MHz reference signal to the Low Noise IC's internal synthesizer. The Low Noise IC compares the reference signal with the outputs of Voltage Controlled Oscillators (VCOs). The Low Noise IC might sense that a VCO's output is out of phase or off-frequency. If so, then the Low Noise IC sends correction pulses to the VCO. The pulses adjust VCO output, thereby matching phase and frequency with the reference.

The Low Noise IC up-converts baseband data from the BRC to the transmit frequency. The Low Noise IC also down-converts the Transmit signal from the Power Amplifier to baseband data for cartesian feedback linearization.

The BRC uses the Serial Peripheral Interface (SPI) bus to communicate with the Low Noise IC. The SPI bus serves as a general purpose, bi-directional, serial link between the BRC and other Base Radio modules, including the Exciter. The SPI carries control and operational data signals to and from Exciter circuits.

Synthesizer Circuitry

The synthesizer circuit consists of the Phase-Locked Loop (PLL) IC and associated circuitry. This circuit's controls the 1025 MHz VCO signal. An internal phase detector generates a logic pulse. This pulse is proportional to the phase or frequency difference between the reference frequency and loop pulse signal.

The charge pump circuit generates a correction signal. The correction signal moves up or down in response to phase detector output pulses. The correction signal passes through the low-pass loop filter. The signal then enters the 1025 MHz Voltage Controlled Oscillator (VCO) circuit.

*Gen3 Base Radio Transceiver***1025 MHz Voltage Controlled Oscillator (VCO)**

For proper operation, the VCO requires a very low-noise, DC supply voltage. An ultra low-pass filter prepares the necessary low-noise voltage and drives the oscillator.

A portion of the oscillator output signal enters the synthesizer circuitry. The circuitry uses this feedback signal to generate correction pulses.

The 1025MHz VCO output mixes with the 90.3 MHz VCO output. The result is a Local Oscillator [LO] signal for the Low Noise IC. The LNODCT uses this LO signal to up-convert the programmed transmit frequency. The Low Noise IC also uses the LO signal to down-convert the PA feedback signal.

90.3 MHz Voltage Controlled Oscillator (VCO)

The synthesizer within the Low Noise IC sets the 90.3 MHz signal. The 90.3 MHz VCO provides a LO signal to the LNODCT IC. The Low Noise IC uses this signal in up-converting and down-converting the feedback signal.

Regulator Circuitry

The voltage regulators generate three regulated voltages: +3 Vdc, +5 Vdc and +11.7 Vdc. The regulators obtain input voltages from the +3.3 Vdc and +14.2 Vdc backplane voltages. The regulated voltages power various ICs and RF devices in the Exciter.

Linear RF Amplifier Stages

The linear RF amplifiers boost the RF signal from the Low Noise IC. The RF Amplifier generates an appropriate signal level to drive the PA.

RF- Receiver Board

Table 3-9 lists the Receiver circuitry. Figure 3-7 shows the Receiver Board with the housing removed. Figure 3-10 shows the Receiver's functional block diagram.

Table 3-9 Receiver Circuitry

Circuit	Description
Frequency Synthesizer Circuitry	Consists of a phase-locked loop and VCO. It generates the 1st LO injection signal for all three receivers.
Receiver Front-End Circuitry	Provides filtering, amplification, and the 1st down conversion of the receive RF signal. This block includes digital step attenuators at the 1st IF.
Custom Receiver IC Circuitry	Consists of a custom IC to perform the 2nd down conversion, filtering, amplification, and conversion of the receive signal. This block outputs the receive signal as differential data to the BRC.
Address Decode, A/D Converter, & Memory Circuitry	Performs address decoding for board and chip-select signals. Converts analog status signals to digital format for use by the BRC. A memory device holds module-specific information.
Local Power Supply Regulation	Accepts +14.2 VDC input from the backplane interconnect board. Also generates two +10 VDC, a +11.5 VDC, and two +5 VDC signals for the receiver.

Frequency Synthesizer and VCO Circuitry

The synthesizer and VCO circuitry generate the RF signal used to produce the 1st LO injection signal for the first mixer in all the Receiver front end circuits. Functional operation of these circuits involves a Phase-Locked Loop (PLL) and VCO.

The PLL IC receives frequency selection data from the BRC module micro-processor via the SPI bus. Once programmed, the PLL IC compares a 2.1 MHz reference signal from the BRC with a feedback sample of the VCO output from its feedback buffer.

The PLL ICC generates correction pulses, depending on whether the feedback signal is higher or lower in frequency than the 2.1 MHz reference. The width of these pulses depends on the amount of difference between the 2.1 MHz reference and the VCO feedback.

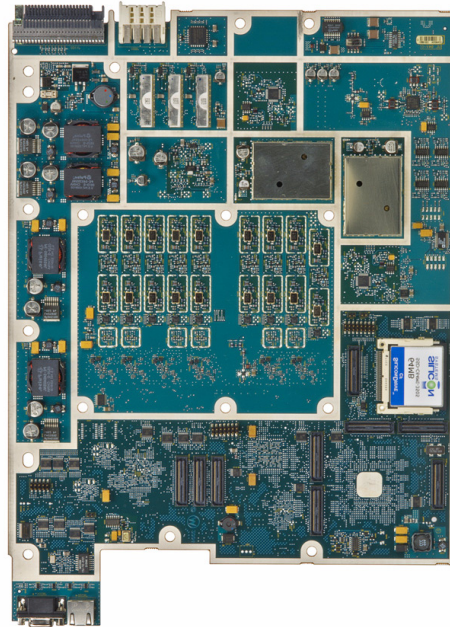
Figure 3-7 Receiver Board (with housing removed)

The up/down pulses enter a charge pump circuit. The charge pump outputs a DC voltage proportional to the pulse widths. After low-pass filtering, this DC voltage enters the VCO circuit as the control voltage. The control voltage measures between +2.5 VDC and +7.5 VDC.

The DC control voltage from the synthesizer enters the VCO. The VCO generates the RF signal that the circuit uses to produce the 1st LO injection signal. The VCO responds to the DC control voltage by generating the appropriate RF signal. This signal passes through a buffer to the 1st LO injection amplifier. A sample of this signal returns to the PLL IC through a buffer to close the VCO feedback loop.

Receiver Front End Circuitry

The station receive RF signal enters the Receiver through the RF-type connector on the back of the Receiver board. The circuit low-pass filters and amplifies this signal. The amplified output passes through an image filter before entering the 1st mixer. The signal mixes with the 1st LO injection signal to produce a 73.35 MHz 1st IF signal.

The 1st IF signal passes through a four-pole, bandpass filter and enters a buffer amplifier. The buffer amplifier output signal again undergoes four-pole, bandpass filtering. The resultant signal then passes through a digital attenuator. The BRC determines the amount of attenuation. The resulting signal then enters the RF input of the custom Receiver IC.

Custom Receiver IC Circuitry

The custom Receiver IC provides additional amplification, filtering, and a second down-conversion. The IC converts the 2nd IF signal to a digital signal. The digital signal exits the receiver IC via differential driver circuitry, and passes to the BRC. This data signal contains I and Q information, AGC information, and other data transfer information. The BRC uses this information to facilitate processing of the receive signal.

The remainder of the custom Receiver IC circuitry consists of timing and tank circuits. These circuits support the internal oscillator, 2nd LO synthesizer, and 2nd IF circuitry.

A serial bus provides data communications between the custom Receiver IC and the DSP Glue ASIC (DGA). These circuits are on the BRC. The serial bus enables the DGA to perform several control functions...

- n control various current and gain settings
- n establish the data bus clock rate
- n program the 2nd LO
- n perform other control functions

Address Decode Circuitry

Address decode circuitry enables the BRC to use the SPI bus to select a specific device on a specific Receiver for control or data communication purposes.

If board-select circuitry decodes address lines A2 through A5 as the Receiver address, it enables the chip select circuitry. The chip select circuitry then decodes address lines A0 and A1. The decoding process generates the chip select signals for the EEPROM, A/D converter, and PLL IC.

Memory Circuitry

The memory circuitry consists of three EEPROMs located on the Receiver. The BRC performs memory read and write operations via the SPI bus. Information stored in this memory device includes...

- n the kit number
- n revision number
- n module specific scaling and correction factors
- n free form module information (scratch pad)

*Gen3 Base Radio Transceiver***A/D Converter Circuitry**

Analog signals from various strategic operating points throughout the Receiver board pass through the A/D converter. These analog signals become a digital signal. Upon request of the BRC, this signal travels to the BRC via the SPI lines.

Voltage Regulator Circuitry

The voltage regulator circuitry consists of two +10 VDC, a +10.8 VDC, and two +5 VDC regulators. The two +10 VDC and the +10.8 VDC regulators accept the +14.2 VDC input from the backplane interconnect board. These regulators produce operating voltages for the Receiver circuitry.

The +10 VDC regulators each feed a +5 VDC regulator. One of these regulators outputs Analog +5 VDC. The other regulator outputs Digital +5 VDC operating voltages for use by the custom Receiver IC.

The backplane interconnect board also produces a +5.1 VDC operating voltage. This voltage powers the remainder of the Receiver circuitry.

**Gen3
Receiver Diversity
Uses and Cautions**

The Gen3 BR Receiver board can be used in one, two, or three-branch diversity systems. The **diversity** parameter determines the number of active receivers. To view the **diversity** parameter, use the MMI command. **(See software commands.)** Each repeater's configuration can be changed in the field to match the number of receivers connected to antennas. To change the **diversity** parameter, use the command **(see software commands)**. For the iDEN system to work optimally, the **diversity** parameter must match the number of receivers connected to antennas.

CAUTION

Improperly setting the diversity parameter will cause serious system degradation.

Modifying Base Radios from Three Branch to Two Branch Diversity

When modifying a three-branch Base Radio to a two-branch Base Radio, observing all precautionary statements in the previous paragraph is important.

To modify a three-branch Base Radio to a two-branch Base Radio:

1. Disconnect the RF cable from the RX3 connector on the Base Radio.

Gen3 Base Radio Transceiver

2. Connect an SMA male load (Motorola part number 5882106P03) to the RX3 connector on the Base Radio.

The SMA male load is required to limit the amount of radiated emissions.

3. Verify that the **diversity** parameter is set properly, according to the Diversity Uses and Caution paragraph above.

Modifying Base Radios from Two Branch to Three Branch Diversity

1. Remove the SMA male load from the RX3 connector of the Base Radio that you wish to convert from two-branch diversity to three-branch diversity.
2. Connect the Receive Antenna #3 RF cable to the RX3 connector on the Base Radio.
3. Verify that the **diversity** parameter is set properly, according to the Diversity Uses and Cautions paragraph.

5-May-08

*PA Theory of Operation***Fan Module**

The PA contains a fan assembly to maintain normal operating temperature through the use of a cool air intake. The fan assembly consists of three individual fans in which airflow is directed across the PA heatsink.

The current draw of the fans is monitored by the DC/Metering Board. A voltage representative of the current draw is monitored by the BRC. The BRC flags the iSC if an alarm is triggered. The PA LED on the front panel of the BRC also lights, however the PA does not shut down due to a fan failure alone.

DC Core Board

The Core Board communicates with the other base radio modules as well as internal PA modules. It utilizes non-volatile memory (NVM) via an EEPROM to store unique PA calibration information.

Driver Board

The Driver Amplifier Board provides the first two stages of RF amplification within the PA. It accepts the output RF signal from the transceiver module (via the core board) and amplifies it to an intermediate power level. The Driver Amplifier Board also provides:

- Gain compensation over temperature.
- On-board DC regulation.
- Transmitter standby functionality

Final Board

The Final Amplifier Board provides the last two stages of RF amplification, including the second RF gain stage (parallel stage). Final utilizes two Final Amplifier Boards:

- RF power splitting (4-way)
- RF power combining (4-way)
- Diagnostics
- Transmitter standby functionality

Isolator Board

The Isolator provides proper RF loading to the final module output regardless of the load presented to the output of the PA itself. The Isolator contains a load resistor to dissipate any reflected power caused by load mismatches at the output of the PA.

Low Pass Filter (LPF) Board

The LPF Board reduces harmonic power levels conducted through the PA RF output connector to acceptable levels. The LPF Board has forward and feedback RF power detectors to monitor forward and reflected output power from the PA, in reference to its output connector. It has a single stage isolator that provides > 20dB isolation with < 0.35dB insertion loss. It also provides a low pass filter with < 0.54dB of in-band insertion loss.

Null Board

The Null Board provides the +28Vdc supply routing from the Core board to the Distribution board (which routes it to the Final board). It also provides the necessary bulk capacitance that is warranted by the Final board.

Distribution Board

The Distribution Board provides for all signal routing from the Core and the Null boards to the Final and LPF boards:

- RF signal from the driver module is split and provided as the input to each of the two final modules.
- RF output from both of the final modules is combined to a single path and provided as the input to the isolator.
- RF power is coupled off the combined port and fed back to the XCVR
- DC Power routing from the NULL board to the Final board
- Forward and reverse DC signaling from the LPF board

DC Power Supply for Gen3 Base Radio

Gen3 Power Supply Overview

When operating from a DC source (43.2 VDC to 60 VDC, positive or negative ground), the supply generates two DC output voltages of 29 VDC with reference to output ground. The battery charger is not usable when operating from a DC input power source.

Figure 6-3 shows the **Gen3** Power Supply.

5-May-08

Figure 6-3



FRONT

REAR

**Gen3
Power Supply
Controls and
Indicators**

Table 6-8 summarizes LED indications on the Gen3 Power Supply during normal operation. Table 6-9 summarizes the Power Supply and

Table 6-8 Power Supply Indicators		
Green	Solid (on)	Power Supply is on, and operating under normal conditions with no alarms
	Off	Power Supply is turned off or required power is not available
	Solid (on)	Power Supply fault or load fault on any output, or input voltage is out of range
Red	Blinking	Power Supply is impaired
	Off	Power Supply is operating normally, with no alarms

DC Power Supply for Gen3 Base Radio

Table 6-11 Normal Operational Parameters (continued)

Description	Value or Range
Battery Charger Ripple	
Efficiency	

Note “Load Ohms” corresponds to the setting on the electronic load for the equivalent Aux DC or battery charger output current, based on a maximum expected Aux DC voltage of 29.72V and a maximum battery charger output of 57.6VDC.

Table 6-12 Normal DC Operational Parameters

Description	Value or Range
DC Input Voltage	43.0 VDC (minimum) 54.3 VDC (nominal) 62.4 VDC (maximum)
Main DC Output Load	0.1 ADC (minimum) 10.5 ADC (nominal) 21.0 ADC (maximum)
Aux DC Output Load	0.1 ADC / 290 Load Ohms (minimum) 1.5 ADC / 19 Load Ohms (nominal) 3.0 ADC / 9.5 Load Ohms (maximum)
Main DC Output Voltage	28.16 VDC (minimum) 28.94 VDC (nominal) 29.72 VDC (maximum)
Aux DC Output Voltage	28.07 VDC (minimum) 28.94 VDC (nominal) 29.81 VDC (maximum)
Main DC Output VDC Ripple	250 mVp-p
Aux DC Output Ripple	250 mVp-p
Efficiency	82 % (minimum) 85% (nominal)
Low Voltage Disconnect	41 VDC (minimum) 42 VDC (nominal) 43 VDC (maximum)
DC Input Overvoltage Lockout	62.4 VDC (minimum) 62.7 VDC (nominal) 63.0 VDC (maximum)

Note “Load Ohms” corresponds to the setting on the electronic load for the equivalent Aux DC output current, based on a maximum expected Aux DC voltage of 29.72V.

DC Power Supply for Gen3 Base Radios

Table 6-11 Normal Operational Parameters (continued)

Description	Value or Range
Startup Settle Time	5 seconds
Main DC Output Load	0.1 ADC (minimum) 9.0 ADC (nominal) 18.0 ADC (maximum)
Aux DC Output Load	0.1 ADC / 290 Load Ohms (minimum) 1.5 ADC / 19 Load Ohms (nominal) 3.0 ADC / 9.5 Load Ohms (maximum)
Battery Charger Load	0.1 ADC / 576 Load Ohms (minimum) 1.5 ADC / 38 Load Ohms (nominal) 3.0 ADC / 19 Load Ohms (maximum)
Main DC Output Voltage	28.16 VDC (minimum) 28.94 VDC (nominal) 29.72 VDC (maximum)
Aux DC Output Voltage	28.07 VDC (minimum) 28.94 VDC (nominal) 29.81 VDC (maximum)
Battery Charger Output Voltage	-42.00 VDC (minimum) -60.00 VDC (maximum)
Main DC Output Overcurrent	20.0 ADC (minimum) 23.0 ADC (nominal) 26.0 ADC (maximum)
Aux DC Overcurrent	4.0 ADC (minimum) 5.0 ADC (nominal) 6.0 ADC (maximum)
Battery Charger Overcurrent	3.0 ADC (minimum) 3.5 ADC (nominal) 4.0 ADC (maximum)
Main DC Output Open Circuit Voltage	32.5 VDC
Aux DC Open Circuit Voltage	32.5 VDC
Battery Charger Open Circuit Voltage	62.5 VDC
Main DC Output Overvoltage Limit	30.0 VDC (minimum) 32.5 VDC (maximum)
Battery Charger Overvoltage Limit	32.5 VDC
Main DC Output VDC Ripple	250 mVp-p
Aux DC Output Ripple	250 mVp-p



DC Power Supply for Gen3 Base Radio



Table 6-9 Power Supply ON/OFF Switch

Switch Position	Power Supply State	Battery Charger State
On	<ul style="list-style-type: none"> Power Factor Correction (PFC) section is active (AC input only) Main DC converter runs to create the MAIN and AUX DC outputs 	Can be started if desired (DC input only)
Off	<ul style="list-style-type: none"> Main DC converter is turned OFF and the MAIN and AUX DC outputs become 0.0VDC PFC section continues to run in an idle mode 	Disabled (DC input only)

Gen3 Power Supply Performance Specifications

Table 6-10 through Table 6-12 lists the specifications for the Gen3 Power Supply.

Table 6-10 Environmental Specifications

Description	Operational (No Derating)	Functional (With Derating)	Storage	Shipment
Temperature	-30° to 60° C	60° to 70° C	-40° to 85° C Non-condensing	40° to 85° C
Relative Humidity	5 to 95% Non-condensing	5 to 95% Non-condensing	5 to 95% Non-condensing	5 to 95% Non-condensing
Altitude	Sea Level to 10,000 ft. (3050 Meters)	Sea Level to 10,000 ft. (3050 Meters)	Sea Level to 10,000 ft. (3050 Meters)	Sea Level to 10,000 ft. (3050 Meters) nonpressurized, 50,000 ft. (15250 Meters) pressurized
