

User / Operational Manual

Operational or User's Manual

The manual should include instruction, installation, operator, or technical manuals with required 'information to the users'. This manual should include a statement that cautions the user that changes or modifications not expressly approved by the party responsible for compliance could void the user's authority to operate the equipment. The manual shall include RF Hazard warning statements, if applicable.

The instruction and service manual for this base radio are not published at this time. However, draft copy of available manual information has been assembled and has been included as part of this filing package.

Upon request, published manuals will be sent to the commission and/or telecommunication certification body (TCB) as soon as they become available. All of the descriptions, block diagrams, and schematics that are included in this filing package are current as of the package submittal date.

EXHIBIT DESCRIPTION

- D1-1 Manual Front Matter (Draft)
- D1-2 Specifications (Draft)
- D1-3 Field Replaceable Units and Orderable Parts (Draft)
- D1-4 Tune-Up Procedure (Draft)
- D1-5 Racking Configurations (Draft)
- D1-6 Functional Description / Operation of Modules (Draft)

User / Operational Manual*Manual Front Matter (Draft)*

i

Foreword

This manual covers all versions of the MOTOTRBO™ MTR3000 Base Station/Repeater, unless otherwise specified. It includes all the information necessary to maintain peak product performance and maximum working time, using levels 1 and 2 maintenance procedures. This level of service goes down to the module replacement level and is typical of some local service centers, Motorola Authorized Dealers, self-maintained customers, and distributors.



These servicing instructions are for use by qualified personnel only. To reduce the risk of electric shock, do not perform any servicing other than that contained in the Operating Instructions unless you are qualified to do so. Refer all servicing to qualified service personnel.

General Safety Precautions

See "General Safety and Installation Standards and Guidelines," on page ii.

Computer Software Copyrights

The Motorola products described in this manual may include copyrighted Motorola computer programs stored in semiconductor memories or other media. Laws in the United States and other countries preserve for Motorola certain exclusive rights for copyrighted computer programs, including, but not limited to, the exclusive right to copy or reproduce in any form the copyrighted computer program. Accordingly, any copyrighted Motorola computer programs contained in the Motorola products described in this manual may not be copied, reproduced, modified, reverse-engineered, or distributed in any manner without the express written permission of Motorola. Furthermore, the purchase of Motorola products shall not be deemed to grant either directly or by implication, estoppel, or otherwise, any license under the copyrights, patents or patent applications of Motorola, except for the normal non-exclusive license to use that arises by operation of law in the sale of a product.

Document Copyrights

No duplication or distribution of this document or any portion thereof shall take place without the express written permission of Motorola. No part of this manual may be reproduced, distributed, or transmitted in any form or by any means, electronic or mechanical, for any purpose without the express written permission of Motorola.

Disclaimer

The information in this document is carefully examined, and is believed to be entirely reliable. However, no responsibility is assumed for inaccuracies. Furthermore, Motorola reserves the right to make changes to any products herein to improve readability, function, or design. Motorola does not assume any liability arising out of the applications or use of any product or circuit described herein; nor does it cover any license under its patent rights nor the rights of others. Controlled copies of this document is available via Motorola On-Line (MOL).

Trademarks

MOTOROLA and the Stylized M logo are registered in the U.S. Patent & Trademark Office. All other product or service names are the property of their respective owners.

© 2010 by Motorola, Inc.
All rights reserved.

User / Operational Manual

Manual Front Matter (Draft, Continued)

General Safety and Installation Standards and Guidelines

ATTENTION!



WARNING

WARNING: For safe installation, operation, service and repair of this equipment, follow the safety precautions and instructions described below, as well as any additional safety information in Motorola's product service and installation manuals and the Motorola R56 Standards and Guidelines for Communications Sites manual (6881089E50). To obtain copies of these materials, please contact Motorola as directed at the end of this section. After installation, these instructions should be retained and readily available for any person operating or servicing this base station or working near it.

Failure to follow these safety precautions and instructions could result in serious injury or property damage.

The installation process requires preparation and knowledge of the site before installation begins. Review installation procedures and precautions in the Motorola R56 manual before performing any site or component installation. Personnel must use safe work practices and good judgment, and always follow applicable safety procedures, such as requirements of the Occupational Safety and Health Administration (OSHA), the National Electrical Code (NEC), and local codes.

The following are additional general safety precautions that must be observed:

- To continue compliance with any applicable regulations and maintain the safety of this equipment, do not install substitute parts or perform any unauthorized modifications.
- All equipment must be serviced by Motorola trained personnel.
- If troubleshooting the equipment while the power is on, be aware of live circuits which could contain hazardous voltage.
- Do not operate the radio transmitters unless all RF connectors are secure and all connectors are properly terminated.
- All equipment must be properly grounded in accordance with the Motorola R56 and specified installation instructions for safe operation.
- Slots and openings in the cabinet are provided for ventilation. Do not block or cover openings that protect the devices from overheating.
- Some equipment components can become extremely hot during operation. Turn off all power to the equipment and wait until sufficiently cool before touching.
- Maintain emergency first aid kits at the site.
- Never store combustible materials in or near equipment racks. The combination of combustible material, heat and electrical energy increases the risk of a fire hazard.
- Equipment shall be installed in a site that meets the requirements of a "restricted access location," per (UL60950-1 & EN60950-1), which is defined as follows: "Access can only be gained by service persons or by users who have been instructed about the reasons for the restrictions applied to the location and

User / Operational Manual

Manual Front Matter (Draft, Continued)

about any precautions that shall be taken; and access is through the use of a tool or lock and key, or other means of security, and is controlled by the authority responsible for the location.”

- Burn hazard. The metal housing of the product may become extremely hot. Use caution when working around the equipment.
- RF energy burn hazard. Disconnect power in the cabinet to prevent injury before disconnecting and connecting antennas.
- Shock hazard. The outer shields of all TX and RX RF cables outer shields must be grounded per Motorola R56 manual.
- Shock hazard. DC input voltage shall be no higher than 60 VDC. This maximum voltage shall include consideration of the battery charging “float voltage” associated with the intended supply system, regardless of the marked power rating of the equipment.
- All TX and RX RF cables shall be connected to a surge protection device according to Motorola R56 manual. Do not connect TX and RX RF cables directly to an outside antenna.
-  Compliance with National and International standards and guidelines for human exposure to Electromagnetic Energy (EME) at Transmitter Antenna sites generally requires that persons having access to a site shall be aware of the potential for exposure to EME and can exercise control of exposure by appropriate means, such as adhering to warning sign instructions. See this installation manual and Appendix A of Motorola R56.

This product complies with the requirements set forth by the European R&TTE regulations and applicable CENELEC standards concerning human exposure to Electromagnetic Energy (EME) at Transmitter Antenna sites. "Appendix D: MOTOTRBO Base Station/ Repeater – EME ASSESSMENT" in this manual includes an EME exposure analysis of a typical system configuration for this product.

For a different system configuration than the typical configuration, compliance with applicable EME exposure standards (current versions of the EN50384 and EN50385 standards for occupational and general public exposure, respectively) can be evaluated by either employing the method illustrated in the typical system configuration EME exposure analysis included in "Appendix D: MOTOTRBO Base Station/Repeater – EME ASSESSMENT" in this manual, or employing another suitable method among those described in the current version of the EN50383 standard.

Once the occupational and general public compliance boundaries are determined, means to ensure that workers and people are outside the respective boundaries, for instance using appropriate signage or restricted access, should be implemented; if this is not possible or practically achievable for the specific system configuration, the configuration should be modified in order to make it possible. The R56 Standards and Guidelines for Communications Sites (6881089E50) manual provides examples of signage that can be used to identify the occupational or general public compliance boundaries.

Refer to product specific manuals for detailed safety and installation instructions. Manuals can be obtained with product orders, downloaded from <https://businessonline.motorola.com>, or purchased through the Motorola Aftermarket & Accessory Department.

 WARNING	<p>This is a class A product. In a domestic environment, this product may cause radio interference in which case the user may be required to take adequate measures.</p>
--	---

Environmental Information

Material Content

Note The Motorola MOTOTRBO™ MTR3000 Base Station/Repeater system and its subsystems have been created in compliance with the environmental goals of the European Union's **Restriction of Hazardous Substances (RoHS)** and the **Waste Electrical and Electronic Equipment (WEEE)** Directive 2002/96/EC as well as Motorola's corporate goals to minimize environmental impact of its products.

This Motorola policy is reflected throughout the entire design, procurement, assembly, and packaging process.

In support of these efforts to provide environmentally-responsible products, please comply with the information in the following sections regarding product disposal for systems being replaced.

Disposal of your Electronic and Electric Equipment

Please do not dispose of electronic and electric equipment or electronic and electric accessories with your household waste. In some countries or regions, collection systems have been set up to handle waste of electrical and electronic equipment.

In European Union countries, please contact your local equipment supplier representative or service center for information about the waste collection system in your country.

Disposal Guideline

The following symbol on a Motorola product indicates that the product should not be disposed of with household waste.



User / Operational Manual

Specifications (Draft)

General Performance			
Model	T2003		
Number of Channels	16		
Frequency Generation	Synthesized		
H x W x D	5.25" x 19" x 16.5" (133x483x419mm)		
Weight	40 lbs (19 kg)		
Power Requirements			
	AC: 85-264 VAC, 47-63 Hz	Standby 0.7A, Rated Power 4.5A @ 117 VAC	
	DC: 21.6 - 32 Volts DC	Standby 1A, Rated Power 10A @ 28 VDC	
Temperature Range	-30 to 60 °C (-22 to 140 °F)		
Input / Output Impedance	50 ohms		
Antenna Connectors Tx / Rx	N-Type		
Modes of Operation	Half-Duplex / Duplex		
Frequency Bands	800 MHz		
Internal Frequency Stability	1.0 PPM		
External Reference Capable	Yes		
Channel Spacing	25 kHz, 12.5 kHz		
Transmitter			
Frequency Range	900 MHz: 935-941 MHz		
Rated Output Power	20 - 75 Watts, Variable		
Intermodulation Attenuation	50 dB		
Adjacent Channel Power	-75 dBc (25 kHz) / -60 dBc (12.5 kHz)		
Wideband Noise (1 MHz)	-152 dBc/Hz		
Rated System Deviation	5 kHz (25 kHz) / 2.5 kHz (12.5 kHz)		
Audio Distortion	<3%		
FM Hum and Noise	50 dB (25 kHz) / 45 dB (12.5 kHz)		
Spurious Harmonic Emissions Attenuation	80 dBc		
FCC Type Acceptance			
	FCC Identifier:	Frequency Range	Type
	ABZ89FC5821	935-941 MHz	Transmitter
	ABZ89FR5822	896-902 MHz	Receiver
			Power Output
			Variable 20-75 W
			N/A

User / Operational Manual

Field Replaceable Units and Orderable Parts (Draft)

Motorola provides the following approved accessories to improve the productivity of your base station / repeater. For a list of Motorola-approved accessories, visit the following web site:

<http://www.motorola.com/governmentandenterprise>.

MOTOTRBO MTR3000 Ordering Guideline

Model	Description
T3000	MTR3000 Base Station/Repeater
X340MT	UHF 100W Power (403–470 MHz)
X540MT	UHF 100W Power (470–524 MHz)
X450MT	800 MHz 100W Power (806–870 MHz)
X460MT	900 MHz 100W Power (896–940 MHz)
X182UL	Duplexer, UHF 403–435 MHz
X182UM	Duplexer, UHF 435–470 MHz
X182UN	Duplexer, UHF 470–494 MHz
X182UH	Duplexer, UHF 494–512 MHz
X182EB	800 MHz Duplexer
X265UL	Preselector, UHF 380–435 MHz
X265UM	Preselector, UHF 435–470 MHz
X265UH	Preselector, UHF 470–524 MHz
X676UL	Dual Circulator, UHF (403–470 MHz)
X676UH	Dual Circulator, UHF (470–524 MHz)
X676EB	800 MHz Circulator
X371BA	Antenna Relay
Note: Antenna Relay is not compatible if ordering X182, Duplexer	
X189AA	Power Cable, Europe
X162AD	Power Cable, UK
X191AD	Power Cable, Australia
CA01520AA	Power Cable, DC
U178AB	Cabinet Mount Hardware
X153BA	Rack Mount Hardware
X347AF	Manual Install and User CD
X244AJ	Auxiliary System Cable
X244AG	Community Base Station/Repeater Panel Cable
X244AH	Phone Patch Cable
C540AD	System Connector Cable
HKLN4439_	MTR3000 Capacity Plus Software Upgrade
HKVN4044_	MTR3000 Dynamic Mixed Mode Software Upgrade (NAG)

Customer Replaceable Power Cables for Standalone Base Radio

Part Number	Description
TRN7663A	Power Cable, North America
TRN7755A	Power Cable, Continental Europe
TTN5049A	Power Cable, UK / Ireland
TTN5103A	Power Cable, Australia

User / Operational Manual

Field Replaceable Units and Orderable Parts (Draft) (Continued)

MOTOTRBO MTR3000 Field Replaceable Units

Model	Description
DLN6714_	800/900 MHz 100W PA
DLN6715_	800/900 MHz Exciter
DLN6716_	800/900 MHz Receiver
DLN6707_	AC/DC Power Supply
DLN6719_	Station Control TCXO
DLN6718_	Station Control OCXO
DLN6720_	2 Wire/4 Wire Wireline
DLN6721_	Backplane Interface Board
CLN8629	MOTOTRBO MTR3000 Installation and User CD
X347AF	Manual Install and User CD

Note The Manual Install and User CD contains:

- MOTOTRBO MTR3000 Installation and User Manual (Including MTR2000 to MTR3000 MOTOTRBO Upgrade Kit)
- MOTOTRBO MTR3000 Basic Service Manual

Microphones/Speakers

Model	Description
GMMN4063	Noise Cancelling Mic
0185180U01	Cable For External Speaker
HSN1006	Speaker

Miscellaneous Accessories

Model	Description
RRX4025	ISB50LNC2 Bulkhead Arrestor 125-100
RRX4032	T-1 ISB50 Series Round Member Mount
RRX4021	Lightening / Surge Arrestor
RRX4034	Lightening / Surge Arrestor (110/220V AC Line Surge Protector)
TRN4589	Dual Line Suppressor
3083908X02	Cable, Field System Adapter
CLN1317*	Antenna Relay
CLN1316**	Antenna Relay For Preselector

Note

(*) Includes Antenna Relay and required cables for stations without X265, Preselector

(**) Includes Antenna Relay and required cables for stations that include X265, Preselector

CKN1039*	Preselector Cable Kit
CKN1040**	Preselector Cable For Antenna Relay

Note

(*) Order this cable for stations without X371, Antenna Relay

(**) Order this cable for stations with X371, Antenna Relay

Cabinets/Racks and Hardware

Model	Description
THN6700	12 inch Indoor Cabinet
THN6701	30 inch Indoor Cabinet
THN6702	46 inch Indoor Cabinet
THN6752	30 inch Modular Rack (16 RK U)
THN6753	45 inch Modular Rack (24 RK U)
THN6754	52 inch Modular Rack (27 RK U)
THN6788_	Slides Motorola Cabinet
CLN6833_	Slides Non-Motorola Cabinet
CLN6679_	Rack Mount Hardware

User / Operational Manual*Tune-Up Procedure (Draft)*

See the following manual excerpts (Chapter 10 and Chapter 13 of **MOTOTRBO MTR3000 Base Station / Repeater, Basic Service Manual**) for instruction on performing the field digital upgrade, operational verification, and programming / tuning.

All adjustments are software controlled and are pre-set at the factory. Certain station operating parameters can be changed using Customer Programming Software (CPS), within predetermined limits. Examples include transmit / receiver operating frequencies and transmitter power level.

After the base station / repeater and ancillary equipment have been mechanically installed, properly cabled, and power applied, the equipment must then be optimized; that is, before placing the base station / repeater in operation. The cable required is a standard "USB A to B" cable. Optimization is performed through the Customer Programming Software (CPS), kit number RVN5115.

After the base station / repeater is operational, the base station / repeater's codeplug data must be copied to a PC- compatible computer.

Optimization involves the following tasks:

1. Reading the base station / repeater codeplug from the base station / repeater (this ensures a match between the base station / repeater serial number (resident in the codeplug) and the serial number (part of the customized base station / repeater codeplug data) that is written back to the base station / repeater (see task 5).
2. Customizing the base station / repeater codeplug and saving the data to the base station / repeater.
3. Aligning the base station / repeater for:
 - Modulation Limit
 - Speaker Level
 - Station Reference
 - MTR2000 PA Calibration
 - Receiver Squelch Adjust
4. Performing post-optimization procedures.
5. Writing the customized codeplug to the base station / repeater codeplug.

For details on these tasks, refer to the Customer Programming Software (CPS) Online Help.

Chapter 10 MTR2000 MOTOTRBO Digital Upgrade

10.1 Overview

The MTR3000 platform supports a digital upgrade kit which allow customers with fielded analog MTR2000 radios to upgrade the station control module (SCM), Receiver and Exciter modules and migrate their radio to a digital MOTOTRBO product. These modules are not assembled together when it is shipped.

An "upgraded base station/repeater" is comprised of a new front bezel, new Exciter module, new Receiver module, new SCM module, and utilizing the remaining components from the MTR2000 Base Station/Repeater (BR). Existing peripherals that are being utilized for the MTR2000 Base Station/Repeater can retrofit the MTR3000 Base Station/Repeater once it is upgraded. There is no need to purchase a new Duplexer, Preselector, External Dual Circulator or Antenna Relay.

The MTR2000 MOTOTRBO Digital Upgrade allows a MTR2000 customer to migrate from analog to digital. The available digital systems are:

- MOTOTRBO (2 slot TDMA digital over the air DMR standard)
- Capacity Plus
- IP Site Connect

The features that are upgradeable from MTR2000 are:

- Air Interface/Conventional – Analog Conventional
- Station Operation – Base Station Analog, Repeater Analog
- Channel Configuration – Half Duplex, Full Duplex
- Air Interface/Trunked – Analog Trunking (LTR and Passport)
- Frequency
 - Rx/Tx : 403–470 MHz (UHF)
 - Rx : 806–825 MHz (800 MHz), 896–902 MHz (900 MHz)
 - Tx : 851–870 MHz (800 MHz), 935–941 MHz (900 MHz)
- Transmitter Capability
 - UHF : 30 W (low power), 40 W (low power) or 100 W (high power)
 - 800/900 MHz : 75 W
- Hardware Peripheral Compatibility – Preselector, Duplexer, External Dual Circulator Tray, Antenna Relay, External Frequency Reference, Angus Battery Charger

The information below is an overview for installing the base station/repeater and ancillary equipment.

- Unpacking and inspecting the equipment
- Mechanically install the equipment at the site
- Make necessary electrical and cabling connections:
 - Audio
 - GPIO
 - Ethernet
- Perform Alignment
- Perform Configuration
- Perform a post-install functional checkout test to verify installation

Note For the correct procedure in handling static-sensitive parts, refer to Section 14.4 on page 14-3.

Note Once the upgrade is performed, the Wireline and Auxiliary I/O board functionality will no longer be supported.

10.2 Unpacking

This section describes the procedures to unpack the new front bezel, new SCM module, new Exciter and Receiver modules from the packaging prior to installing them.

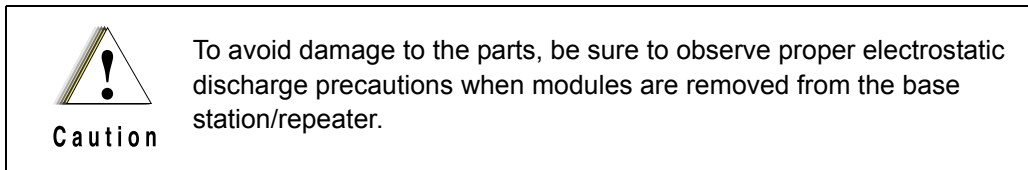

10.2.1 Equipment Unpacking and Inspection

10.2.1.1 Introduction

The new front bezel, new Exciter module, new Receiver module and new SCM module may be shipped by either air freight or electronic van (as specified by customer), except where noted.

Thoroughly inspect the equipment as soon as possible after delivery. If any part of the equipment is damaged during transit, immediately report the extent of the damage to the transportation company and to Motorola.

10.2.1.2 Unpacking Equipment

The new front bezel, new Exciter Module, new Receiver Module and new Station Control Module are packed in four separate boxes which are packed together in a common box. The individual boxes are cushioned between corrugated cardboard in a common box.

10.2.1.3 Analog to Digital Migration Path – Removal and Replacement

1. Remove the MTR2000 Base Station/Repeater front bezel from its chassis locking clip by carefully pulling the bezel forward (Refer to Figure 10-1).

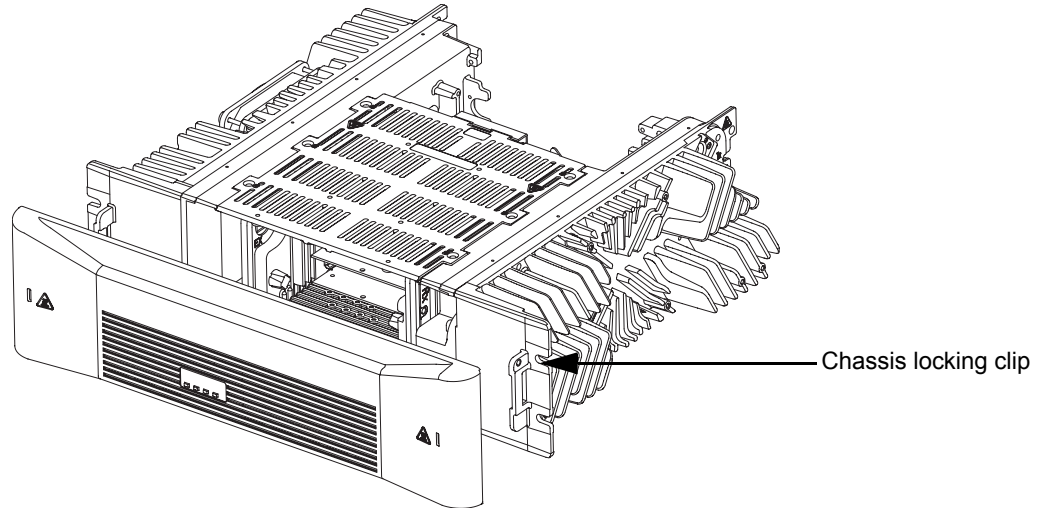

Figure 10-1 Removing Front Bezel

2. Disconnect the Exciter-to-PA Coaxial Cable and Rx Input Cable (Refer to Figure 10-2). By disconnecting the cables, the Exciter Module, Receiver Module, Station Control Module (SCM) are accessible.

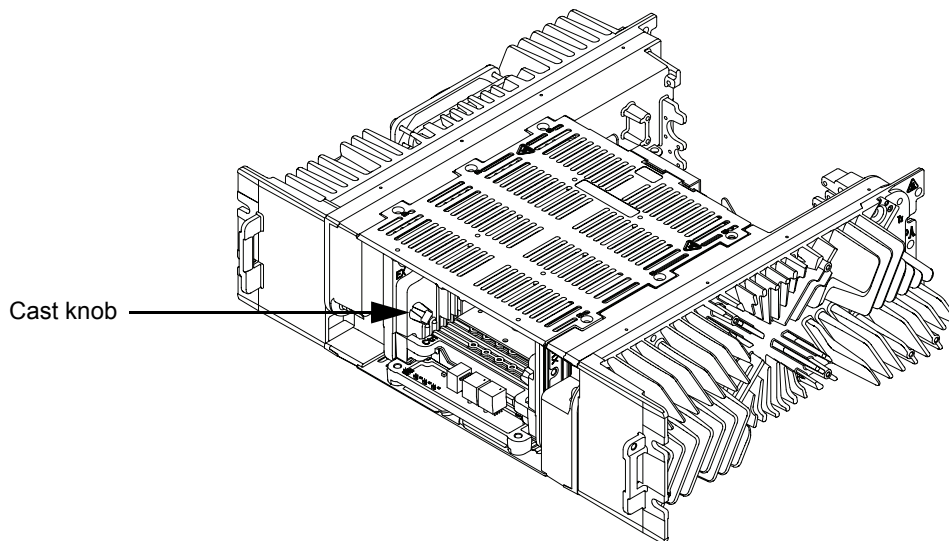

Figure 10-2 Removing RF cable

3. Remove the two screws securing the Transceiver (SCM, Exciter, and Receiver modules) to the bottom plate. Pull forward on the cast knobs, carefully slide the assembly out of the base station/repeater (Refer to Figure 10-3) and place it aside.

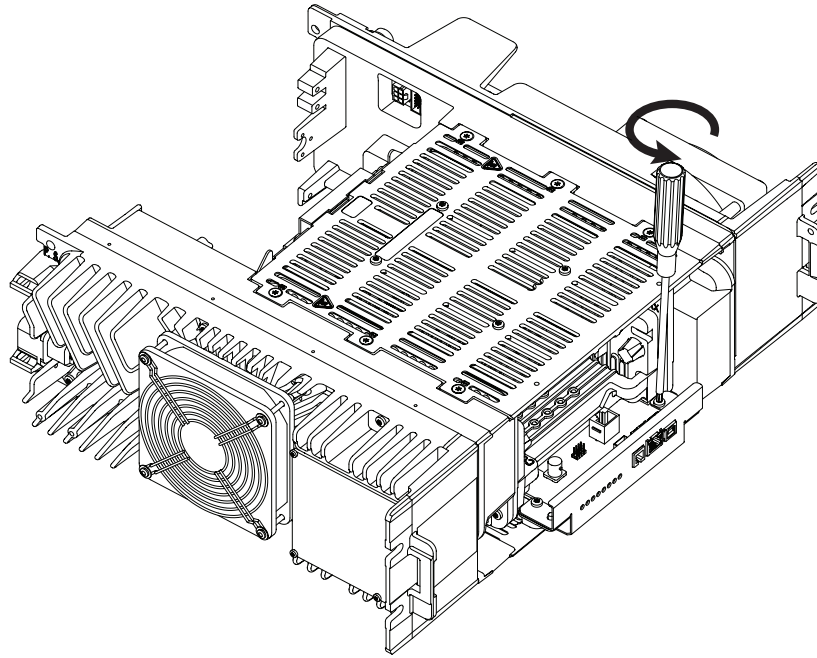

Figure 10-3 Removing two screws securing the Transceiver Assembly

4. Remove the Wireline and Auxiliary I/O Card(s) (if any are installed) as the card(s) will not be supported in an upgraded MTR2000.
5. Secure the new Station Control Module (SCM), Exciter and Receiver Modules using the eight screws (Refer to Figure 10-4) supplied with the MTR2000 MOTOTRBO Digital Upgrade kit to form the new Transceiver Assembly.

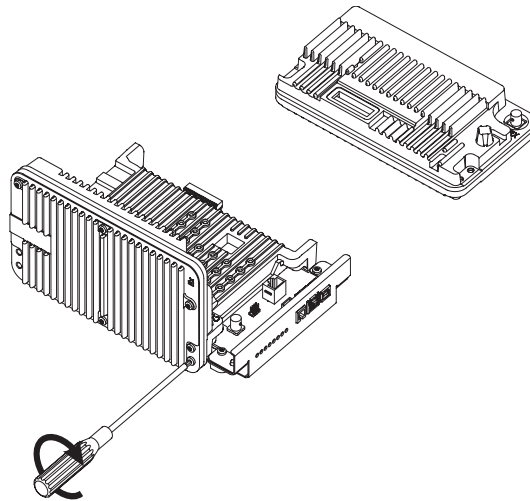

Figure 10-4 Putting together new SCM, Exciter and Receiver

6. Slide the new Transceiver Assembly into the MTR2000 Base Station/Repeater (along the guide rails) to mate with the connector on the backplane interface board.

7. Secure the Transceiver Assembly to the bottom plate by fastening the screws in Step 3 (Refer to Figure 10-3).
8. Affix the provided MTR3000 FCC upgrade label to the area noted in Figure 10-5.

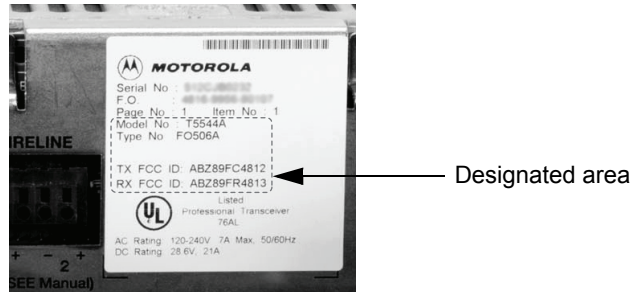

Figure 10-5 Location to affix the MTR3000 FCC upgrade label

Note The label must not cover the serial number of the MTR2000 Base Station/Repeater.

9. Affix the provided Part 68 label to the area noted in Figure 10-6 (if not already present).

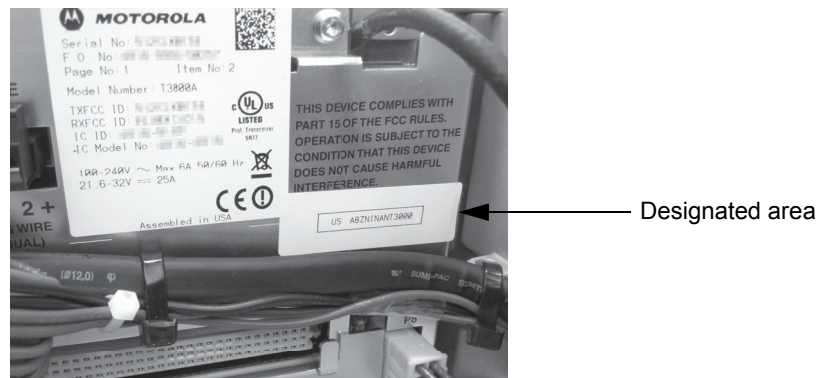

Figure 10-6 Location to affix the Part 68 label

Note The Part 68 label is supplied if the MTR3000 Wireline Card is ordered as an option with the MTR2000 MOTOTRBO Digital Upgrade Base Station/Repeater.

10. Reconnect the Exciter-to-PA Coaxial Cable and Rx Input Cable.

10.3 New Connections

After the base station/repeater equipment has been mechanically installed, connections must be made. This involves making the following new connections to:

- J7 Backplane Connector to support the following analog third party boxes (If applicable)
 - Community Repeater Panel
 - Tone Remote Controller (Console Connection)
 - LTR Trunking Controller
 - Passport (NTS) Controller
 - Phone Patch
 - Deskset

- Ethernet to support the following MOTOTRBO features
 - IP Site Connect
 - RDAC
 - Capacity Plus
 - Connect Plus

- Note**
1. It is not recommended to perform a digital upgrade and use the upgraded base station/ repeater in analog mode as certain analog functionality will be lost. Refer to Product Planner for details.
 2. 14.2 VDC power (Pin 20) and GPIO_9 (Pin 5) are not supported on an upgraded MTR2000 J7 backplane connector. If 12 VDC power is required on an upgraded MTR2000, then it must be obtained from Pin32 of connector J5.

10.3.1 AUX Connector

The location of the AUX connector is located at the base station/repeater rear panel. The following cables are the reference cables used for this connector:

- Auxiliary System Cable, Part no. X244AJ
- System Connector Cable, Part no. C540AD

10.3.2 System Connector

For details on the system connectors, refer to "Chapter 6".

10.3.3 Telephone Line Connections

For details on the telephone line connections, refer to "Chapter 6".

10.3.4 Station Maintenance Connections

Table 10-1 provides a description of the maintenance connections located on the front of the Station Control Module.

Table 10-1 Station Maintenance Connections on the SCM

Connector Name	Function	Details
5/10 MHz External Reference (J3008)	For alignment and for receipt of external reference.	Achieved automatically and does not require configuration in the CPS. This is a 50 Ω input that is compatible with a 2Vpp (min) to 5Vpp (max) sine or square wave.
Service Speaker (J3010) ¹	Output to Power Voice speaker	Adjustable between 0 to 500 mV across 50 kΩ @60% system deviation. Audio signal appears between Pins 3 and 4 on the connector. Must use speaker type HSN1000 (older model) or HSN1006 via adapter cable Part.No. 0185180U01. Note : The Speaker port is only supported in analog mode regardless of the speaker used.
Microphone (J3000) ¹	Local Microphone Input	Use local microphone type GMN6147 (older model) or GMMN4063. Modulation sensitivity for 60% system deviation is typically 56 mV rms. Note : The Mic port is only supported in analog mode regardless of the Mic used. For older model of microphone (GMN6147), the 3 control buttons for speaker volume control, Rx monitor and Intercom control functions are not supported.

Note 1. Only work in analog mode.

10.4 Operational Verification

After the base station/repeater equipment has been mechanically installed and all electrical connections have been made, replace the new MTR3000 Base Station/Repeater front bezel by inserting one of the front bezel locking clip into corresponding latch on the base station/repeater housing, and carefully pressing the bezel on the opposite side until the second locking clip snaps into place.

10.4.1 Applying Power

Before applying power to the base station/repeater, make sure all modules are securely seated in the appropriate connectors on the backplane interface board and that all RF cables are securely connected.

Plug in the AC line cord that supplies power to the base station/repeater Power Supply, or switch on the DC-breaker to a base station/repeater with a DC power source to the Power Supply.

10.4.2 Alignment and Configuration

After the base station/repeater and ancillary equipment have been mechanically installed, properly cabled, and power applied, the equipment must be optimized before placing the base station/repeater in operation. Align with the Tuner application followed by configuration with the CPS application.

- Note**
1. The base station/repeater will be locked after alignment with the Tuner application. To unlock it, the codeplug must be read and then written to by the CPS application.
 2. The base station/repeater reference must be aligned as shown in Section 14.3.3 on page 14-2, before the base station/repeater is placed on the air.

10.4.3 Optimizing Tasks

Refer to "Chapter 13" for optimizing tasks.

10.4.4 Verifying Radio Operation

Refer to "Chapter 12" for procedures to verify Exciter and Receiver circuitry operation.

10.4.5 Verifying Proper Operation

For details in this section, refer to Table 1-9.

Chapter 13 MTR3000 Programming and Tuning

13.1 Introduction

This chapter provides an overview of the MOTOTRBO Customer Programming Software (CPS) for the MTR3000 and MTR2000 MOTOTRBO Digital Upgrade, as well as the MOTOTRBO Tuner application for use on Windows XP™, Windows Vista Home Premium™ or Windows Vista Business Edition™ 32 bit and 64 bit operating system.

Note Refer to the appropriate program on-line help files for the programming procedures.

13.2 Customer Programming Software Setup

The Customer Programming Software setup, shown in Figure 13-1 is used to program the base station/repeater. Refer to Figure 13-2 and Figure 13-3 for the actual connectors on the front and rear panels of the base station/repeater.

Note Refer to the appropriate program on-line help files for the programming procedures.



Caution Computer USB ports can be sensitive to Electronic Discharge. Employ proper ESD practices (wrist strap, grounding, etc.) and do not touch exposed contacts on cables when connected to a computer.

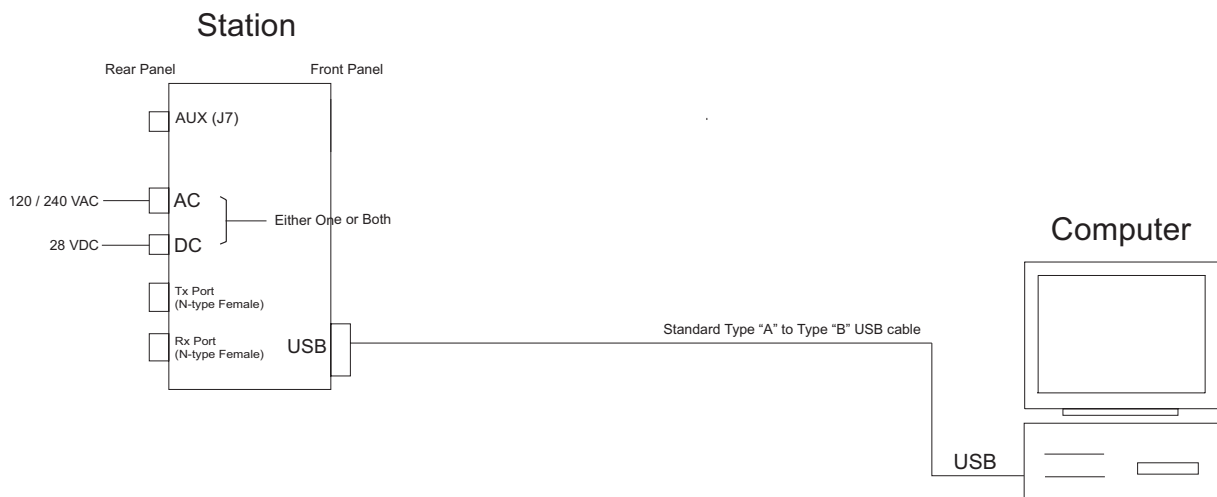

Figure 13-1 Customer Programming Software Setup from Rear Accessory Connector



Figure 13-2 Front view (without front bezel) of MTR3000 Base Station/Repeater

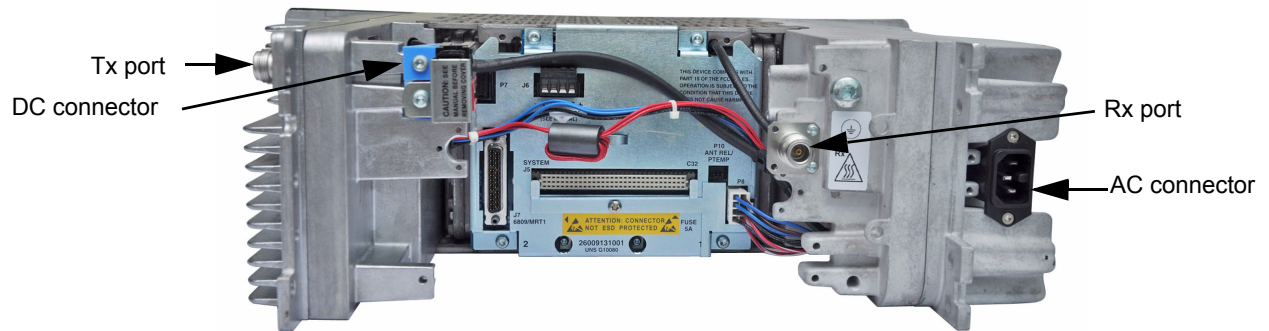

Figure 13-3 Rear view of MTR3000 Base Station/Repeater

13.3 Base Station/Repeater Tuning Setup

A personal computer (PC), Windows™ operating system, and the MOTOTRBO Tuner application are required to tune the Station. To perform the tuning procedures, the base station/repeater must be connected to the PC and test equipment setup as shown in Figure 13-4.

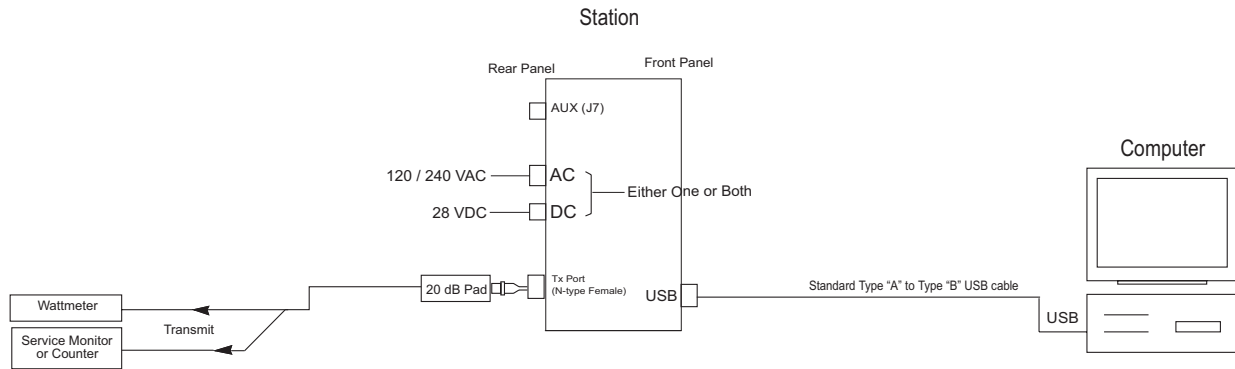

Figure 13-4 MTR3000 Base Station/Repeater Tuning Equipment Setup

13.4 Tuning Setup (MTR2000 MOTOTRBO Digital Upgrade)

Note Section 13.4 on page 13-3 only applies to an upgraded MTR2000 Base Station/Repeater.

13.4.1 MTR2000 Calibration Coefficient Entry

This feature is used to allow entry of the transmitter (Tx) output power coefficients of an MTR2000 Power Amplifier (PA) into the MTR3000 tuning codeplug.

Since an upgraded MTR2000 Base Station/Repeater does not have its PA upgraded, its PA calibration coefficients must be entered into the tuning codeplug, as the non-upgraded MTR2000 PA does not have an Electrically Erasable Programmable Read-only Memory (EEPROM). The calibration coefficients, which exist on a sticker on the face plate, consist of two 7 digit hexadecimal numbers and two 6 digit hexadecimal numbers. The sticker itself is created and applied at the factory in which the PA was calibrated.

13.4.1.1 Tuning Procedure

1. Power the Station from either an AC or DC source.
2. Launch the MOTOTRBO Tuner application on the computer.

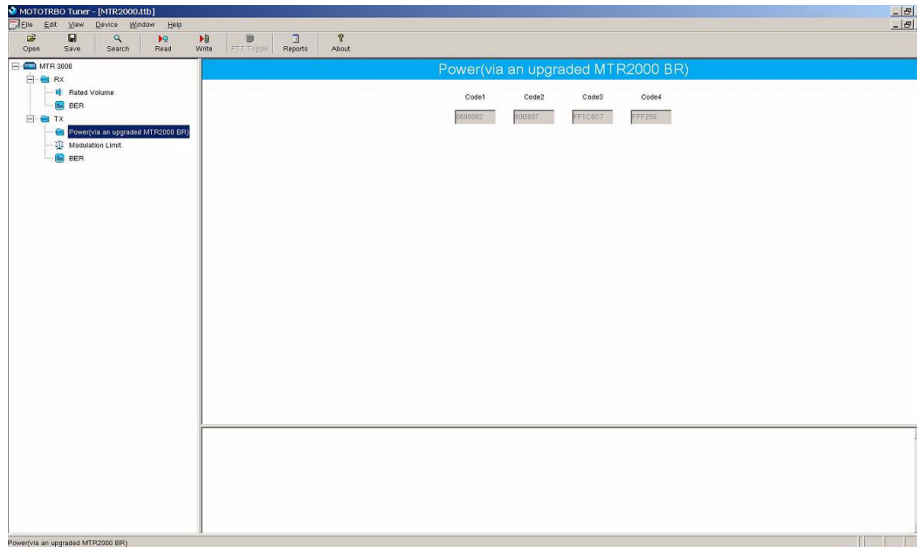

Figure 13-5 Tx Menu tree (Tuning Procedure)

3. Click the “Read” button in the Tuner to read the current code values from the radio’s tuning codeplug.
4. Select “Power” under the Tx menu in the tree view (Refer to Figure 13-5).
 - If the returned codeplug values match the PA calibration sticker values, click the directory tree to exit from the “Power” menu, or click the “Write” button to save the tuned power values into the radio’s codeplug.
 - If the returned codeplug values do not match the PA calibration sticker value, proceed to Step 5 below. Otherwise, proceed to Step 9 to exit.
5. Enter the upper left code from the PA calibration sticker to Code 1.
6. Enter the upper right code from the PA calibration sticker to Code 2.
7. Enter the lower left code from the PA calibration sticker to Code 3.
8. Enter the lower right code from the PA calibration sticker to Code 4.
9. Click the “Write” button to save the tuned power values into the radio’s codeplug.
10. Exit from the Tuner application to reset the radio. After reset, the radio will be locked.
11. To unlock the radio, launch the CPS. Read the codeplug, then write to the codeplug.
 - CPS can be used to configure the codeplug prior to the write procedure (e.g. setting up frequency)
12. Alignment is complete.

13.4.1.2 Verification or Test Procedure for High Power

1. Power the Station from either an AC or DC source.
2. Connect the radio's Tx antenna port, through an attenuation pad and calibrate the path loss, to the Communication Analyzer.
3. Via the CPS, program the radio with all user frequencies supported by the base station/ repeater in analog mode.
4. Enter the test frequency into the Communication Analyzer and set the analyzer in power meter mode.
5. Connect a Mic to the RJ45 connector at the front panel.
6. Press the PTT button on the Mic.
7. Measure the transmit power.
8. If the measured transmit power is not within the original MTR2000 specifications range, the PA must be replaced as it cannot be calibrated in the field.
9. Repeat Step 4 to Step 7 for the remaining frequencies.

13.5 Tuning Setup (Wireline)

13.5.1 Wireline Receive Level Tuning

The procedure outlined in this section is used to set the output level on the Wireline board's Rx path for a given RF signal deviation on the received signal. Perform this procedure during initial Wireline installation or any time the Rx audio level needs adjustment.

13.5.1.1 Tuning Procedure

1. Connect the radio's receiver antenna port to the Communication Analyzer.
2. Power the base station/repeater from either an AC or DC source.
3. Launch the Tuner application and click the "Read" button to read the softpot values.
4. Select "Wireline Receive Level" under the Rx menu in the tree view (Refer to Figure 13-6).

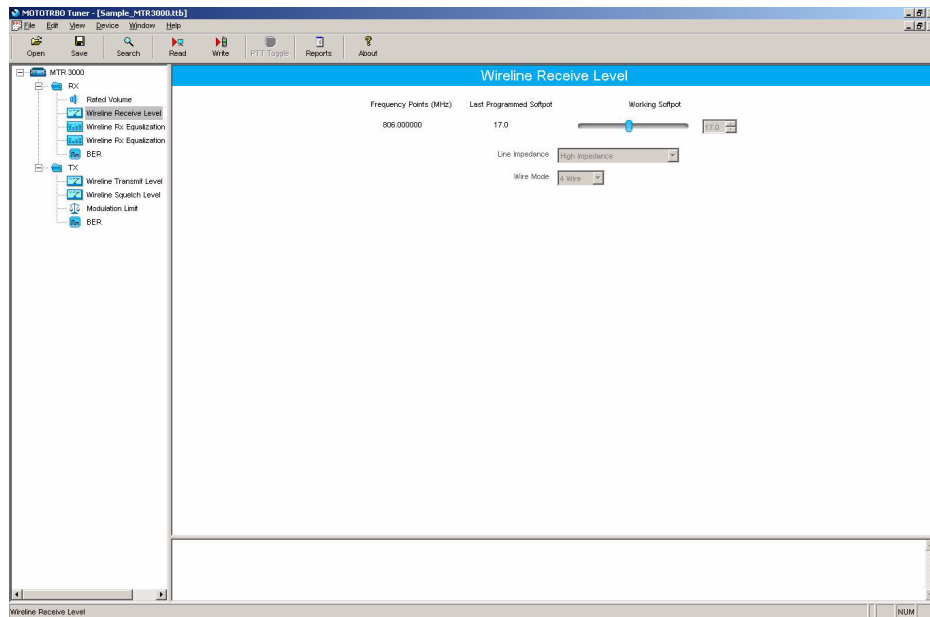

Figure 13-6 Rx Menu tree (Wireline Receive Level)

- Set the Communication Analyzer to output a -47 dBm RF signal modulated with a 1 kHz tone at 60% of full deviation on the tuning frequency. The tuning frequency is the value displayed on the Tuner GUI under the heading of "Frequency Points".

Note The Tuner aligns this parameter in a 12.5 kHz channel spacing, so 60% is 1.5 kHz of deviation. If the CPS is set for 25 kHz operation, the base station/repeater will automatically scale the deviation by a factor of two when it is outside the Tuner environment.

Note Programmed TPL and DPL squelch requirements are automatically disabled for the tuning frequency while in the Tuner environment.

- Adjust the softpot value until the desired receive audio level is achieved (-30 dBm to +7 dBm) across line two of the J6 Wireline backplane connector terminals.

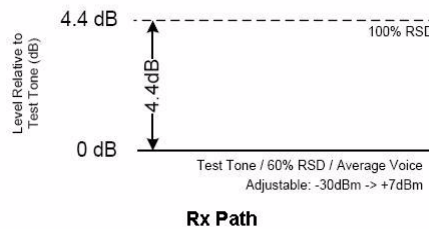
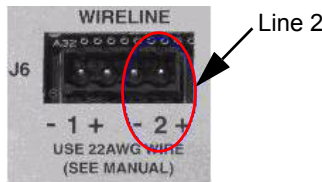

Note It is imperative that the load the Wireline board is driving, matches that of the Wireline board's source impedance setting noted in the Tuner environment. Optimally, it is recommended to use the actual load which is used during normal operation of the radio.

- Click "Write" to save the new tuned softpot value into the radio's codeplug.

13.5.2 Wireline Rx Equalization – 2800 Hz Tuning

The Rx Equalization feature allows the frequency response adjustment of the Rx Audio relative to a specified rated system deviation, to compensate (equalize) for the response of the wireline backhaul network itself. This section outlines the procedure for high frequency adjustment. Perform this procedure only after setting the Wireline Receive Level. Refer to Section 13.5.1 on page 13-5.

The Rx Equalizer is adjusted relative to the response at 1 kHz. Note the 1 kHz response observed when performing the tuning procedure for Wireline Receive Level. Equalizer adjustments are approximate. Typical adjustments range from 0 dB to approximately +6 dB.

13.5.2.1 Tuning Procedure

1. Connect the radio’s receiver antenna port to the Communication Analyzer.
2. Power the base station/repeater from either an AC or DC source.
3. Launch the Tuner application and click the “Read” button to read the softpot values.
4. Select “Wireline Rx Equalization – 2800 Hz” under the Rx menu in the tree view (Refer to Figure 13-7).

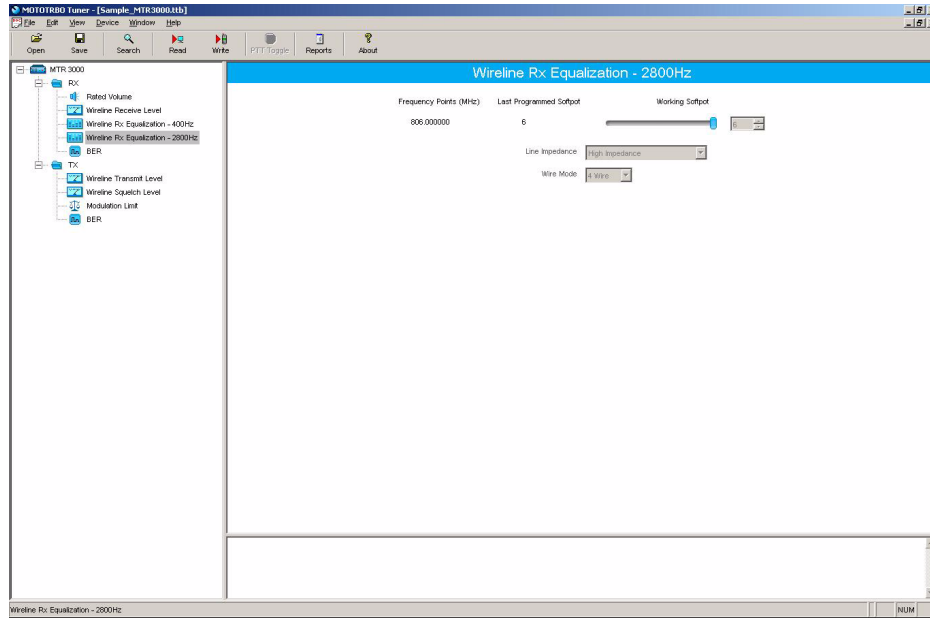

Figure 13-7 Rx Menu tree (Wireline Rx Equalization – 2800 Hz)

5. Set the Communication Analyzer to output a -47 dBm RF signal modulated with a 2800 Hz tone at 60% of full deviation on the tuning frequency. The tuning frequency is the value displayed on the Tuner GUI under the heading of “Frequency Points”.

Note The Tuner aligns this parameter in a 12.5 kHz channel spacing, so 60% is 1.5 kHz of deviation. If the CPS is set for 25 kHz operation, the base station/repeater will automatically scale the deviation by a factor of two when it is outside the Tuner environment.

Note The emphasis setting of the Communication Analyzer must be turned off for this alignment procedure.

Note Programmed TPL and DPL squelch requirements are automatically disabled for the tuning frequency while in the Tuner environment.

6. Adjust the softpot value until the best equalization is achieved across line two of the J6 Wireline backplane connector terminals. Best equalization is achieved when the far side of the Wireline cable measures a flat response across the upper region of the audio spectrum. Compare the response at 2800 Hz with the response measured at 1000 Hz. The values should be approximately equal.

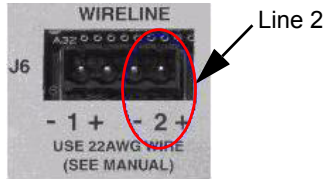

Note It is imperative that the load the Wireline board is driving, matches that of the Wireline board's source impedance setting noted in the Tuner environment. Optimally, it is recommended to use the actual load which is used during normal operation of the radio.

7. Click "Write" to save the new tuned softpot value into the radio's codeplug.

13.5.3 Wireline Rx Equalization – 400 Hz Tuning

The Rx Equalization feature allows the frequency response adjustment of the Rx Audio relative to a specified rated system deviation, to compensate (equalize) for the response of the Wireline backhaul network itself. This section outlines the procedure for low frequency adjustment. Perform this procedure only after setting the Wireline Receive Level. Refer to Section 13.5.1 on page 13-5.

The Rx Equalizer is adjusted relative to the response at 1 kHz. Note the 1 kHz response observed when performing the tuning procedure for Wireline Receive Level. Equalizer adjustments are approximate. Typical adjustments range from 0 dB to approximately +6 dB.

13.5.3.1 Tuning Procedure

1. Connect the radio’s receiver antenna port to the Communication Analyzer.
2. Power the base station/repeater from either an AC or DC source.
3. Launch the Tuner application and click the “Read” button to read the softpot values.
4. Select “Wireline Rx Equalization – 400 Hz” under the Rx menu in the tree view (Refer to Figure 13-8).

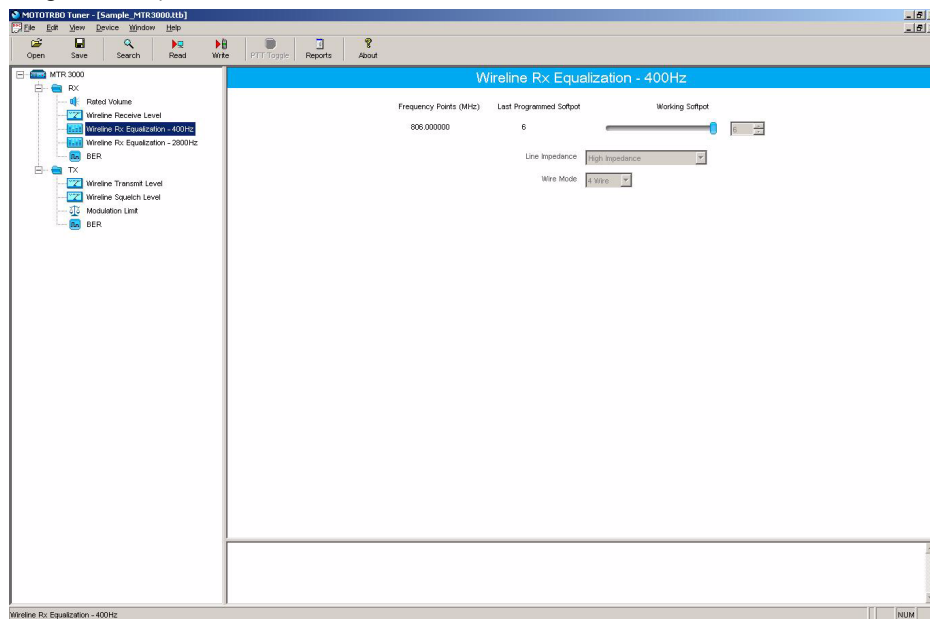

Figure 13-8 Rx Menu tree (Wireline Rx Equalization – 400 Hz)

5. Set the Communication Analyzer to output a –47 dBm RF signal modulated with a 400 Hz tone at 60% of full deviation on the tuning frequency. The tuning frequency is the value displayed on the Tuner GUI under the heading of “Frequency Points”.

Note The Tuner aligns this parameter in a 12.5 kHz channel spacing, so 60% is 1.5 kHz of deviation. If the CPS is set for 25 kHz operation, the base station/repeater will automatically scale the deviation by a factor of two when it is outside the Tuner environment.

Note The emphasis setting of the Communication Analyzer must be turned off for this alignment procedure.

Note Programmed TPL and DPL squelch requirements are automatically disabled for the tuning frequency while in the Tuner environment.

- Adjust the softpot value until the best equalization is achieved across line two of the J6 Wireline backplane connector terminals. Best equalization is achieved when the far side of the Wireline cable measures a flat response across the lower region of the audio spectrum. Compare the response at 400Hz with the response measured at 1000 Hz. The values should be approximately equal.

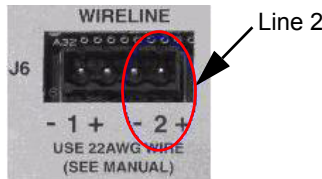

Note It is imperative that the load the Wireline board is driving, matches that of the Wireline board's source impedance setting noted in the Tuner environment. Optimally, it is recommended to use the actual load which is used during normal operation of the radio.

- Click "Write" to save the new tuned softpot value into the radio's codeplug.

13.5.4 Wireline Transmit Level Tuning

The procedure outlined in this section is used to adjust the level the Wireline is expecting on the Tx pair of the J6 Wireline connector. Adjusting the expected level has the effect of increasing or decreasing RF signal deviation for a given Wireline Tx audio level. Perform this procedure during initial Wireline installation or any time the Tx audio level needs adjustment.

13.5.4.1 Tuning Procedure

- Connect the radio's transmitter antenna port to the Communication Analyzer.
- Power the base station/repeater from either an AC or DC source.
- Apply a 1 kHz signal at the desired input level (-36 dBm to +4 dBm) to the J6 Wireline backplane connector terminals. This signal is known as "Test Tone" and corresponds with the level of average voice. Optimally, it is recommended to use the actual source which is used during normal operation of the radio to provide the signal.

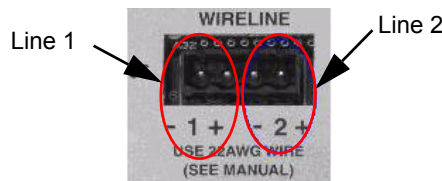

Note Most Motorola dispatch consoles can generate a 1 kHz tone at the correct level by using the "Alert Tone" feature. Consult the appropriate console manual for more information.

Note If the Wire Mode is set for 2 Wire operation, then inject the signal into the line two terminals of connector J6. Otherwise, inject the signal into the line one terminals of J6.

- Launch the Tuner application and click the "Read" button to read the softpot values.

5. Select “Wireline Transmit Level” under the Tx menu in the tree view (Refer to Figure 13-9).

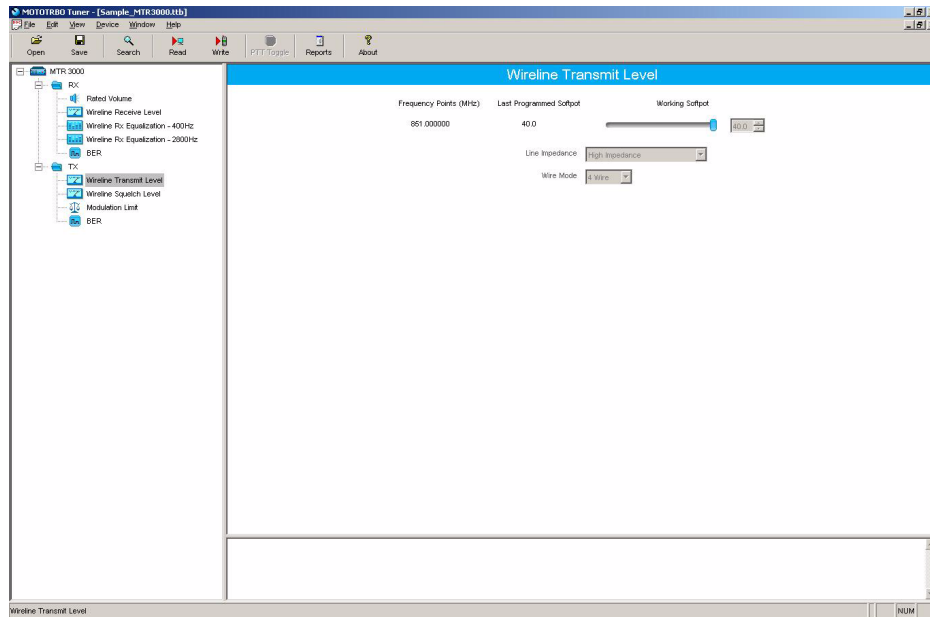

Figure 13-9 Tx Menu tree (Wireline Transmit Level)

6. Enter the tuning frequency into the Communication Analyzer (the value displayed on the Tuner GUI under the heading of “Frequency Points”).
7. Click the “PTT Toggle” button within the Tuner environment to key up the radio.

Note If enabled, the Wireline’s Automatic Level Control (ALC) and Wireline Squelch Hysteresis features are automatically turned off when the radio is keyed up from the “PTT Toggle” button within the Tuner environment. The features are automatically re-enabled when the radio is de-keyed by pressing the “PTT Toggle” button or when leaving the Tuner environment.

8. Adjust the softpot value until 60% of the rated system deviation (RSD) is achieved.

Note The Tuner aligns this parameter in a 12.5 kHz channel spacing, so 60% is 1.5 kHz of deviation. If the CPS is set for 25 kHz operation, the base station/repeater will automatically scale the deviation by a factor of two when it is outside the Tuner environment.

9. Click the “PTT Toggle” button within the Tuner environment to de-key the radio.
10. Click “Write” to save the new tuned softpot value into the radio’s codeplug.

13.5.5 Wireline Squelch Level Tuning

The Wireline Squelch feature is used to mute Wireline Tx audio when the audio level falls below a designated threshold. The procedure in this section is used to set the nominal squelch threshold. An additional hysteresis value can be added to the nominal squelch threshold by adjusting the “Squelch Hysteresis” setting in the Wireline configuration options of the CPS tool.

Note This calibration procedure should be performed after adjusting the Wireline Transmit Level. Refer to Section 13.5.4 on page 13-10.

The Wireline Squelch level is adjusted relative to the expected audio level for High Level Guard Tone. This is true regardless of the Remote Control method selected. The expected level of High Level Guard Tone is 6 dB above the “Test Tone” level used during the Wireline Transmit Level tuning procedure of Section 13.5.4 on page 13-10.

Note It is possible to set the Wireline Squelch threshold higher than the level of average voice. Setting the Squelch threshold too high can result in unintended audio drop-outs or no audio at all.

13.5.5.1 Tuning Procedure

1. Connect the radio's transmitter antenna port to the Communication Analyzer.
2. Power the base station/repeater from either an AC or DC source.
3. Apply a 1 kHz signal, at the desired squelch threshold, to the J6 Wireline backplane connector terminals. Optimally, it is recommended to use the actual source which is used during normal operation of the radio to provide the signal.

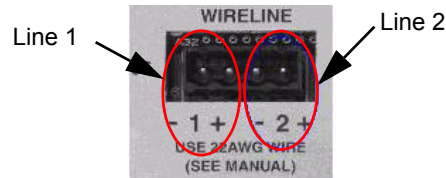

Note If the Wire Mode is set for 2 Wire operation, then inject the signal into the line two terminals of connector J6. Otherwise, inject the signal into the line one terminals of J6. In addition, the Wire Mode used must be the same configuration as that was used in the Wireline Transmit Level alignment in Section 13.5.4 on page 13-10.

4. Launch the Tuner application and click the “Read” button to read the softpot values.

5. Select “Wireline Squelch Level” under the Tx menu in the tree view (Refer to Figure 13-10).

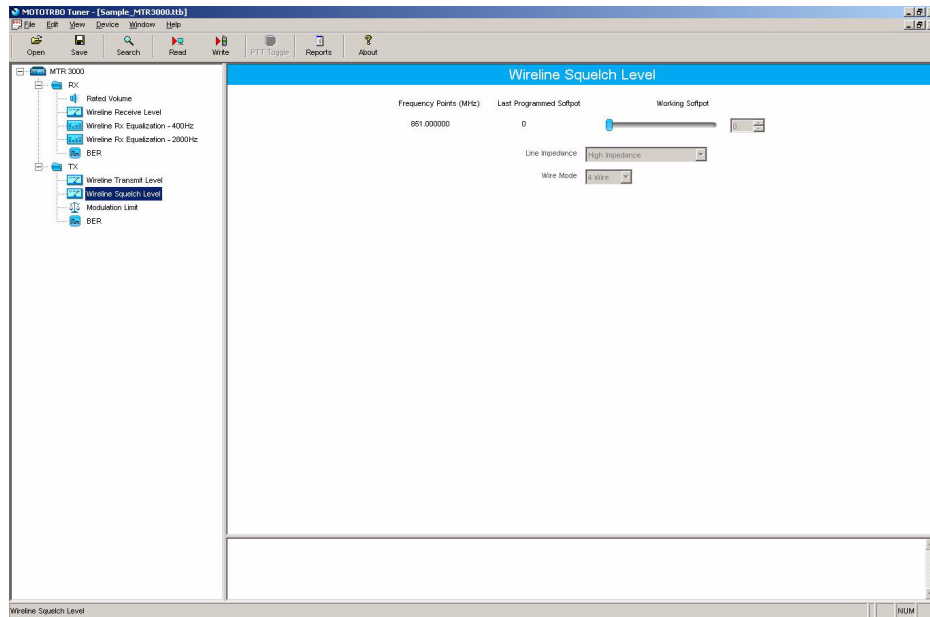

Figure 13-10 Tx Menu tree (Wireline Squelch Level)

6. Enter the tuning frequency into the Communication Analyzer (the value displayed on the Tuner GUI under the heading of “Frequency Points”).
7. Click the backplane “PTT Toggle” button within the Tuner environment to key up the radio.

Note If enabled, the Wireline’s Automatic Level Control (ALC) and Wireline Squelch Hysteresis features are automatically turned off when the radio is keyed up from the “PTT Toggle” button within the Tuner environment. The features are automatically re-enabled when the radio is de-keyed by pressing the “PTT Toggle” button or when leaving the Tuner environment.

Note The Wireline’s Automatic Level Control (ALC) alignment procedure can result in a difference between the Wireline Squelch Threshold set during this procedure and the actual value observed in normal operation. This difference can be eliminated or minimized, by carefully following the Wireline Transmit Level tuning procedure found in Section 13.5.4 on page 13-10 to obtain an accurate alignment.

8. Adjust the softpot value until the Communication Analyzer indicates that the deviation has dropped out (< 100 Hz of deviation).
9. Click the “PTT Toggle” button within the Tuner environment to de-key the radio.
10. Click “Write” to save the new tuned softpot value into the radio’s codeplug.

13.6 Modulation Limit Alignment

This feature is to set the modulation limit of the radio for MTR3000 and MTR2000 MOTOTRBO Digital Upgrade.

Note A modulation limit alignment is not needed if the radio is used in repeat mode. This is always the case when the radio is in digital mode.

13.6.1 Tuning Procedure (with no Tx Data and no PL)

Note

1. Under the “Accessories” menu within the CPS, if the “Audio Type” is set to “Rx & Tx Filtered Squelch” and the “Analog Accessory Emphasis” is set to “De & Pre”, then a modulation limit alignment is not needed. In this configuration, the modulation limit is always set to 92% RSD by the base station/repeater software.
2. If data or PL signaling is applied to Pin 13 of the J7 connector, proceed to Section 13.6.3 on page 13-16.

1. Connect the radio’s antenna port to the attenuation pad, if necessary, before connecting to the Communication Analyzer.
2. Power the base station/repeater from either an AC or DC source.
3. Apply a 1 kHz signal at 1.2 Vrms to Pin 1 of the J7 backplane connector.
 - Signal ground is Pin 9 of the J7 backplane connector.
4. Launch the Tuner application and click the “Read” button to read the softpot values.
5. Select “Modulation Limit” under the Tx menu in the tree view (Refer to Figure 13-11).

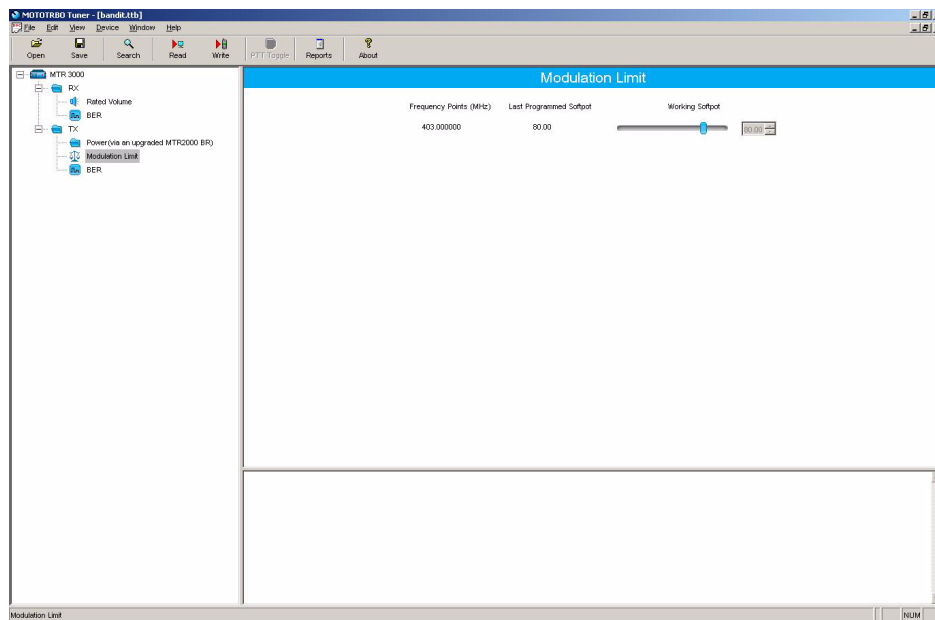

Figure 13-11 Tx Menu tree (Tuning Procedure with no Tx data)

6. Enter the tuning frequency into the Communication Analyzer (the value displayed on the Tuner GUI).
7. Click the “PTT Toggle” button within the Tuner environment to key up the radio.

8. Adjust the softpot value until the maximum deviation is 92% of the rated system deviation (RSD). This will be tested in a 12.5 kHz channel spacing, so 92% of 2.5 kHz is 2.3 kHz.

Note Set the modulation limit to 92% so that any additional deviation incurred by the transmitter VCOs over temperature is compensated for.

Channel Spacing	RSD	92% of RSD	Tolerance
12.5 kHz	2.5 kHz	2.3 kHz	+0Hz / -50Hz

9. Click the “PTT Toggle” button within the Tuner environment to de-key the radio.
10. Click “Write” to save the new tuned softpot value into the radio’s codeplug.

13.6.2 Verification (with no Tx Data and no PL)

1. Connect the radio’s antenna port to the attenuation pad, if necessary, before connecting to the Communication Analyzer.
2. Power the base station/repeater from either an AC or DC source.
3. Via CPS, program the radio with any frequency within the specified range of the base station/repeater under test, and set the radio for low power and disable the repeat path.
4. Apply a 1 kHz signal at 1.2 Vrms to Pin 1 of the J7 backplane connector.
 - Signal ground is Pin 9 of the J7 backplane connector.
5. Key up the radio and measure the deviation
 - Key the radio by grounding Pin 2 of the J7 backplane connector.
 - CPS must have Pin 2 configured as an active low with the PTT function.
6. De-key the radio.

The deviation shall meet the limits shown in the table below.

Channel Spacing	Relative Standard Deviation (RSD)	92% of RSD	Tolerance
12.5 kHz	2.5 kHz	2.3 kHz	+0Hz / -50Hz
20.0 kHz	4.0 kHz	3.68 kHz	+0Hz / -80Hz
25.0 kHz	5.0 kHz	4.6 kHz	+0Hz / -100Hz

Note The base station/repeater will be factory-tuned in accordance to the above procedure and specification.

13.6.3 Tuning Procedure (with Tx Data or PL)

1. Connect the radio’s antenna port to the attenuation pad, if necessary, before connecting to the Communication Analyzer.
2. Turn on the base station/repeater using an AC or DC source.
3. Click the “Read” button on the Tuner application to read the radio’s softpot values.
4. Select “Modulation Limit” under the Tx menu in the tree view.
5. Enter the tuning frequency into the Communication Analyzer (the value displayed by the Tuner application).
6. Click the “PTT Toggle” button within the Tuner environment to key up the radio.
7. Apply a 1 kHz signal at 1.2Vrms to Pin 22 of the J7 backplane connector.
 - Signal ground is Pin 9 of the J7 backplane connector.
 - If the manufacturer of the third party controller specifies that the Tx Audio is not to be pre-emphasized, use Pin 1 instead of Pin 22.
8. Adjust the Modulation Limit softpot to a value that limits the maximum deviation to “X”% RSD, where “X” is equal to “92% RSD” minus “Tx Data’s % RSD”.
 E.g. If Tx Data deviation is equal to 17%,
 $X = 92\% - 17\% = 75\%$ as the maximum deviation limit.

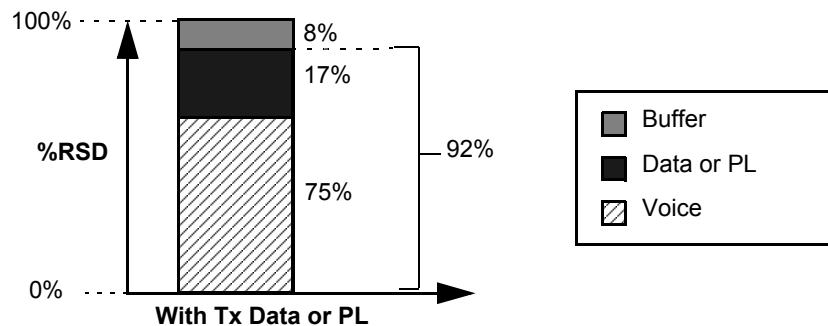

Figure 13-12 Example of maximum deviation limit calculation

9. Click the “PTT Toggle” button within the Tuner environment to de-key the radio.
10. Click “Write” to save the newly tuned softpot value into the radio’s codeplug.
11. Alignment is complete.

- Note** Refer to Figure 5-2 for details regarding the audio and data flow.
- Note** Set the modulation limit to 92% to compensate for any additional deviation incurred by the transmitter VCOs over temperature.
- Note** The Tuner application always aligns the Modulation Limit parameter in a 12.5 kHz channel spacing regardless of the CPS setting, so calculate the tuning % RSD accordingly. If the CPS is set for 25 kHz operation, the base station/repeater will automatically scale the deviation by a factor of two when outside of the Tuner environment.

13.6.4 Verification (with Tx Data or PL)

Refer to Section 13.6.2 on page 13-15 with the following exceptions:

- The same Tx data signal level determined (obtained from Step 8 in Section 13.6.3 on page 13-16), is applied to Pin 13 during the validation process.
- Pin 22 may be used instead of Pin 1, depending on the recommendation by the manufacturer of the third party controller.

User / Operational Manual

Racking Configurations (Draft)

There are various equipment racking configurations available to customers. The following section depicts some of the racking alternatives.

Floor-Mount Cabinet

The front, side and top views for all available floor-mount cabinets are shown below. Cabinet models and hardware are shown in the following table:

Model	Description
THN6700	12 inch Indoor Cabinet
THN6701	30 inch Indoor Cabinet
THN6702	46 inch Indoor Cabinet
THN6788	Motorola Cabinet Slides
CLN6833	Non-Motorola Cabinet Slides

See the installation manual for recommended equipment ventilation clearances. For improved access to the unit, tray slides are available as shown in the table above.

 WARNING	Ensure that the cabinet is securely anchored to the floor, thereby avoiding possible equipment tipping and personal injury. Refer to Mounting Floor-Mount Cabinets for details on proper cabinet installation.
---	---

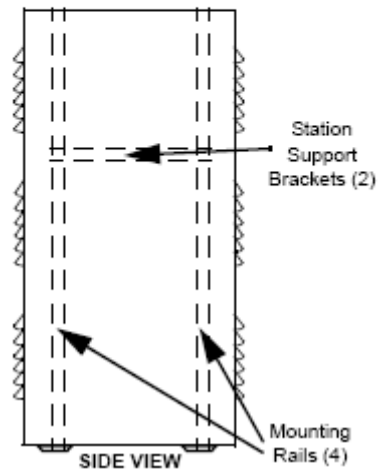
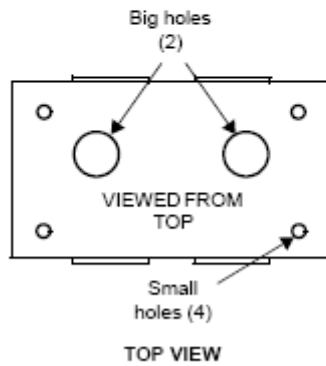
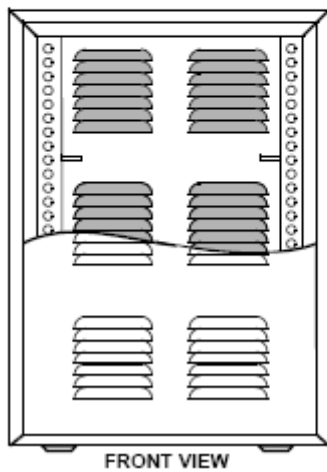

User / Operational Manual

Racking Configurations (Draft, Continued)

Modular Racks

The front, side and top views for all available floor-mount cabinets are shown below. The cabinet models and associated description are shown in the following table:

Rack Model	Description
THN6752	30 inch Modular Rack (16 RK U)
THN6753	45 inch Modular Rack (24 RK U)
THN6754	52 inch Modular Rack (27 RK U)

The side, top and bottom views for all available modular racks are shown below. The top and bottom plates are identical, and all dimensions and clearances are common to all racks.

Recommended clearance front and rear is 91.44 cm (36 in) minimum for servicing access. Refer to Equipment Ventilation for recommended ventilation clearances.

FRU kit CLN6679 (Rack Mount Hardware) is included with each rack model. This allows proper installation of the MTR3000 base station / repeater within the rack's center of gravity.

NOTE: This kit includes two rack mount standoffs and eight mounting screws.

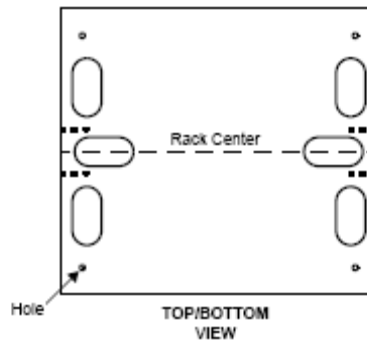
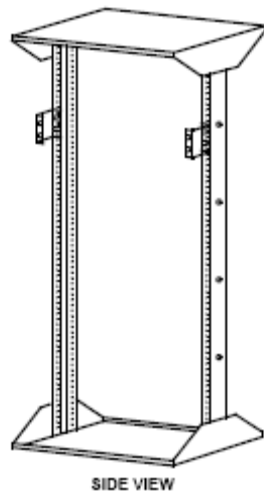

User / Operational Manual

Functional Description / Operation of Modules (Draft)

Base Radio Module Overview

The Motorola MTR3000 Base Station / Repeater (BR) provides a modular, flexible analog and digital station design for today's communication systems and of the future. The stations are available for use in Analog Conventional, Digital Conventional (MOTOTRBO), LTR Trunking, Passport Trunking, MOTOTRBO Capacity Plus Trunking, and MOTOTRBO Connect Plus Trunking configurations.

The MTR3000 BR can either be configured as a stand-alone base station / repeater or as a base station / repeater connected to a back-end network, as in the case of operating in IP Site Connect mode. As a base station / repeater, it listens on one uplink frequency, and then re-transmits on a downlink frequency thus providing the RF interface to the field subscribers. When configured for analog station operation, the BR is designed to operate with most existing analog systems, therefore making a smooth migration to the MOTOTRBO system.

When configured for digital operation, the BR offers additional services. The digital BR operates in TDMA mode, which essentially divides one channel into two virtual channels using time slots; therefore the user capacity is doubled. The BR utilizes embedded signaling to inform the field radios of the busy/idle status of each channel (time slot), the type of traffic, and even the source and destination information.

Note: When configured in Digital Mode, the BR can only be used as a repeater.

Note: At any given time, the BR either operates as a digital repeater or as an analog repeater.

The MTR3000 BR is divided into functional modules that separate the frequency band specific and transmitter power specific circuits from other circuits and has separate modules for the control interface. These modules are self contained functional blocks with module-specific alarms. This design facilitates the field replaceable unit (FRU) concept of field repair to maximize system uptime.

Indicators and Connections

This section describes the LED indicators and connectors provided on the base station / repeater. The set of LEDs indicate the operational status of the base station / repeater. There are two sets of connectors for devices external to the base station / repeater:

- One set connects to external devices to enable full operation of the base station / repeater. These are located at the back of the base station / repeater.
- Another set connects to external devices for servicing the base station / repeater. These are located on the Station Control Module.

LED Indicators

A set of eight LEDs is located on the base station / repeater front bezel. The position of the eight LEDs on the front bezel is shown below. These LEDs indicate the status of the base station / repeater during normal operation.



Front Bezel LEDs and Connectors

After booting up the base station / repeater, the six LEDs (Power/Status, TX Slot 1, TX Slot 2, RX Slot 1, RX Slot 2 and the Mode LEDs) flashes in unison. The general status and condition of the MTR3000 Base Station / Repeater can be obtained by observing the eight LED indicators on the front bezel. The following tables show the LED symbols and their meaning and identify the information conveyed via the LED indicators.

User / Operational Manual

Functional Description / Operation of Modules (Draft)

LED	Definition
	Status
	TX Slot 1 (for label number 1) TX Slot 2 (for label number 2)
	RX Slot 1 (for label number 1) RX Slot 2 (for label number 2)
	Mode
	Ethernet Link
	Reference

LED Function Name	LED Color	LED State	Status Indication
Boot-up	Green (All LED)	Flashing	Station booting up
Power/Status	Off	Off	Station Off
		Flashing	Station Operating Normally, with DC power
	Green	Flashing	Station Operating Normally, with AC power
		Solid	Station Operating Normally, with AC power
	Red	Flashing	Station Operational – Minor Alarm
Solid		Station Not Operational – Major Alarm	
Amber	Flashing	Station in Service Mode	
	Solid	Station is Disabled (Dekeyed)	
TX Slot 1 TX Slot 2	Off	Off	Transmitter is not transmitting
		Green	Transmitter is transmitting
		Flashing	Transmitter is transmitting, but at reduced power out
RX Slot 1 RX Slot 2	Off	Off	Receiver qualifier has not been met
		Green	Receiver qualifier has been met
Mode	Off	Off	Analog Mode (FM)
		Blue	Digital Mode (2 Slot TDMA, 4FSK)
Ethernet Link	Off	Off	No Ethernet connection
		Green	Linked
		Flashing	Network traffic
Reference	Off	Off	No external reference is present
		Green	Training process is completed and the calibration data has been written to the EEPROM or external reference is present after training which the BR has phase locked to.
		Amber	Lock to external reference and training is in progress

Front Bezel LED Indicators

External Connections - Electrical Connections for the base station / repeater external connectors and line cord are located on the back panel and are shown below.

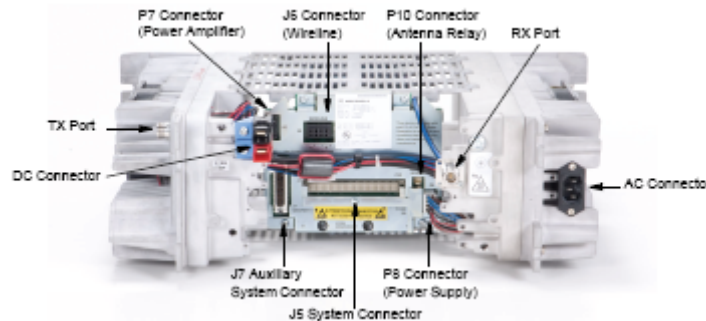

Location of External Connectors at Rear of Base Station / Repeater

The connection to external devices on the back panel is the J7 Auxiliary System Connector. The connector is a 25-pin connector used for connecting to an external device such as a trunking controller, tone remote adaptor, or phone patch.

Service ports and LEDs are located on the front of the Station Control Module (SCM). The connection to external devices on the front of the station control module is the BNC connector. The connector allows the base station / repeater to be connected to a 5 MHz or 10 MHz external reference signal. The service ports include connectors for:

- 5/10 MHz External Reference Signal
- Ethernet Connector
- Service Speaker Connector
- USB Connector
- Service Microphone Connector

User / Operational Manual

Functional Description / Operation of Modules (Draft)

The locations of the connectors on the front of the station control module are shown below.

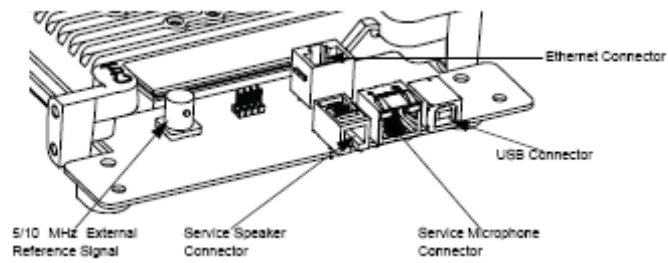

User / Operational Manual*Functional Description / Operation of Modules (Draft)**Control Overview*

The heart of the Station Control Module (SCM) is the two Texas Instruments OMAP1710 processors. Each OMAP processor contains an ARM Host and a C55 DSP processor. One of these OMAP processor is dedicated to Receiver DSP operations, while the other OMAP provides for all other operations, including the transmitter functions.

The SCM controls the entire coordination of the base station/repeater functions. Specifically, the SCM provides for the following functionalities:

- Contains and runs the preloaded base station/repeater software
- Manages inbound and outbound RF and Audio traffic
- Provides external speaker and microphone ports
- Provides an on-board USB port for local configuring, alignment and diagnostics via the following applications:
 - Customer Programming Software (CPS)
 - Tuner application
 - Repeater Diagnostic and Control (RDAC) software
 - Online Help
- Provides an Ethernet port for IP site connectivity and remote RDAC
- Provides GPIO connectivity for third party controller interfaces
- Provides for analog base station/repeater audio connectivity
- Data and Control to the Receiver via the SPI and SSI respectively
- Data and Control to the Exciter via the SPI and SSI respectively
- Control of the PA's set power via the SPI
- Generates the internal station reference
- Provides control of the front panel status indicators

Functional Description / Operation of Modules (Draft)

Receiver Overview

The Receiver Module consists of a Receiver RF board in a clamshell housing assembly. It provides the Receiver functionality for the MTR3000 Base Station/Repeater and performs highly-selective bandpass filtering and dual down-conversion of the desired RF signal. A custom Receiver IC then performs an analog-to-digital conversion of the desired received signal and outputs a differential data signal to the Station Control Module (SCM). The Receiver Module kit contains an on-board, varactor-tuned preselector, which covers multiple frequency ranges. The UHF range receivers utilize an external coaxial-resonator bandpass filter (BPF) for some configurations but not the 800/900MHz range Receivers.

Overview of Circuitry

The Receiver Module contains the following circuitry:

- Frequency Synthesizer Circuitry – consists a phase-locked loop and Voltage-Controlled Oscillator (VCO), generates the first LO injection signal
- Varactor-tuned Preselector Filter / Fixed Preselector Filter (800/900 MHz) – provides bandpass filtering of the station Receiver RF input
- Receiver Front End Circuitry – performs filtering, amplification, and the first down conversion of the Receiver RF signal
- Custom Receiver IC Circuitry – consists a custom IC which performs the second down conversion, filtering, amplification, and analog-to-digital conversion of the receive signal
- Analog to Digital Converter (ADC) Converter Circuitry – converts analog Receiver status signals to digital format for transfer, upon request, to the SCM
- Local Power Supply Regulation – accepts +8V, +10V and +14.2V inputs and outputs +2.775V, +3.3V, +5V, +10V, and +14.2V operating voltages

Input and Output Connections

The following shows the Receiver module input and output external connections.

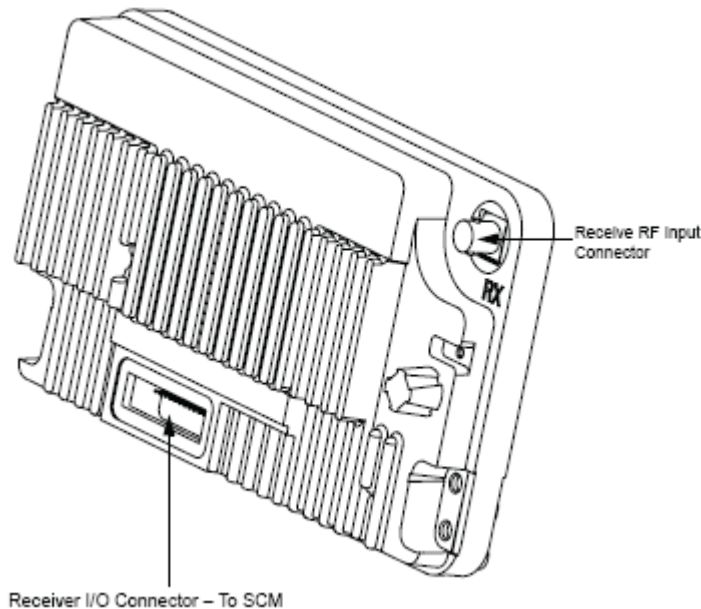

User / Operational Manual

Functional Description / Operation of Modules (Draft)

Specifications

The following table shows the specifications of MTR3000 Base Station / Repeater's Receiver.

<u>Parameter</u>	<u>Specification</u>
Frequency Ranges	806–825 MHz and 896–902 MHz
Electronic Bandwidth	Full Bandwidth
Analog Sensitivity 12 dB SINAD	0.291 μ V (-117.7 dBm)
Intermodulation Rejection	85 dB
Adjacent Channel Rejection*	75 dB at 12 kHz, 85 dB at 25 kHz
Spurious and Image Response Rejection	90 dB
Intermediate Frequencies	1st: 73.35 MHz 2nd: 2.25 MHz
RF Impedance	50 Ω
Current Draw (Maximum)	0.04A from 14.2 VDC supply 0.52A from 10 VDC supply 0.11A from 8 VDC supply

User / Operational Manual

Functional Description / Operation of Modules (Draft)

Exciter Overview

The Exciter Modules (in conjunction with the Power Amplifier Module) provides the transmitter functions for the station. Contained within a metal clamshell housing, the Exciter board generates a low-level modulated Radio Frequency (RF) signal which is input to the power amplifier module for further amplification and output to the transmit antenna. The Exciter Modules interfaces directly with the Station Control Module (SCM), which provides control signals and monitoring, and routes transmit audio to the Exciter.

The RF carrier is generated by a frequency synthesizer consisting of synthesizer circuitry and Voltage-Controlled Oscillator (VCO) circuitry. Exciter module control signals, monitoring, and audio processing are handled by the Station Control Module (SCM). The Exciter Modules differ only in the range of operation. Unless otherwise noted, the information provided in this section applies to all models.

The Exciter board contains the following circuitry:

- Frequency Synthesizer Circuitry – consists of a phase-locked loop and Voltage-Controlled Oscillator (VCO), generates a modulated RF signal at the transmitter carrier frequency
- RF Isolation Switch – allows the SCM to turn on/off the Exciter RF output signal to the power amplifier module
- Analog to Digital Converter (ADC) Converter Circuitry – converts the analog Exciter status signals to the digital format for transfer, upon request, to the SCM
- Local Power Supply Regulation/Filtering – accepts +8V, +10V and +14.2V inputs and provides +5V, +10V, and +12V operating voltages

Input and Output Connections - The following shows the Exciter module input and output external connections.

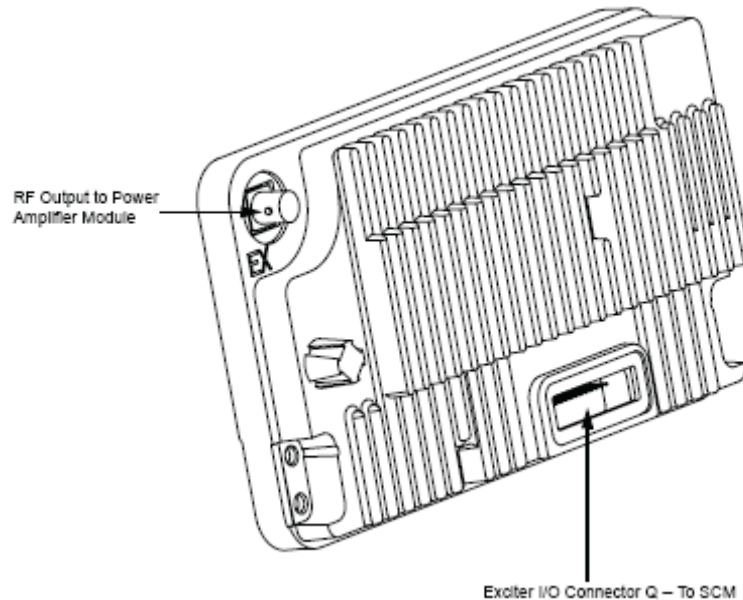

Specifications of Exciter Module

Parameter	Specification
Frequency Ranges	851–870 MHz (800 MHz) and 935–941 MHz (900 MHz)
Electronic Bandwidth	Full Bandwidth
Output Power	13–18 dBm (800 MHz), 14 – 18 dBm (900 MHz)
Current Draw (Maximum)	0.05A from 14.2 VDC supply 0.15A from 10 VDC supply 0.2A from 8 VDC supply
Harmonics	-20 dBc

User / Operational Manual

Functional Description / Operation of Modules (Draft)

Power Amplifier Module Overview

The Power Amplifier (PA) is a forced convection-cooled RF power amplifier. It accepts a low-level modulated RF signal from the Exciter Module and amplifies the signal for transmission via the site transmit antenna. The output power is continually monitored and regulated by a feedback and control loop, with a power output control voltage being generated by the transmitter control circuitry located on the PA Input/Output boards.

Overview of Circuitry

The Power Amplifier contains the following sub-circuits:

- Intermediate Power Amplifier (IPA) – hybrid substrate amplifier stage which accepts low-level input from Exciter Module, amplifies the signal, and outputs a 0 W to 10 Watt RF signal
- Driver Module (DPA) – the driver module is a single stage hybrid amplifier. It amplifies the output of the IPA to a power level between 10 Watts and 35 Watts.
- Dual Device Module (DDM) – hybrid substrate amplifier stage which accepts output from DPA and provides final amplification. The resulting output of the PA is 75 Watts
- Directional Coupler/Power Detector/Low Pass Filter – couples amplified RF signal to transmit antenna connector; also generates dc voltages proportional to forward and reflected power for use in TX power control loop; provides harmonic suppression for the station
- Single Circulator – provides isolation between Power Amplifier output and transmit antenna
- Temperature Sense Circuitry – provides variable resistance signal proportional to heat sink temperature; signal is monitored by the PA power control circuitry

Input and Output Connections

The following shows the PA input and output external connections.

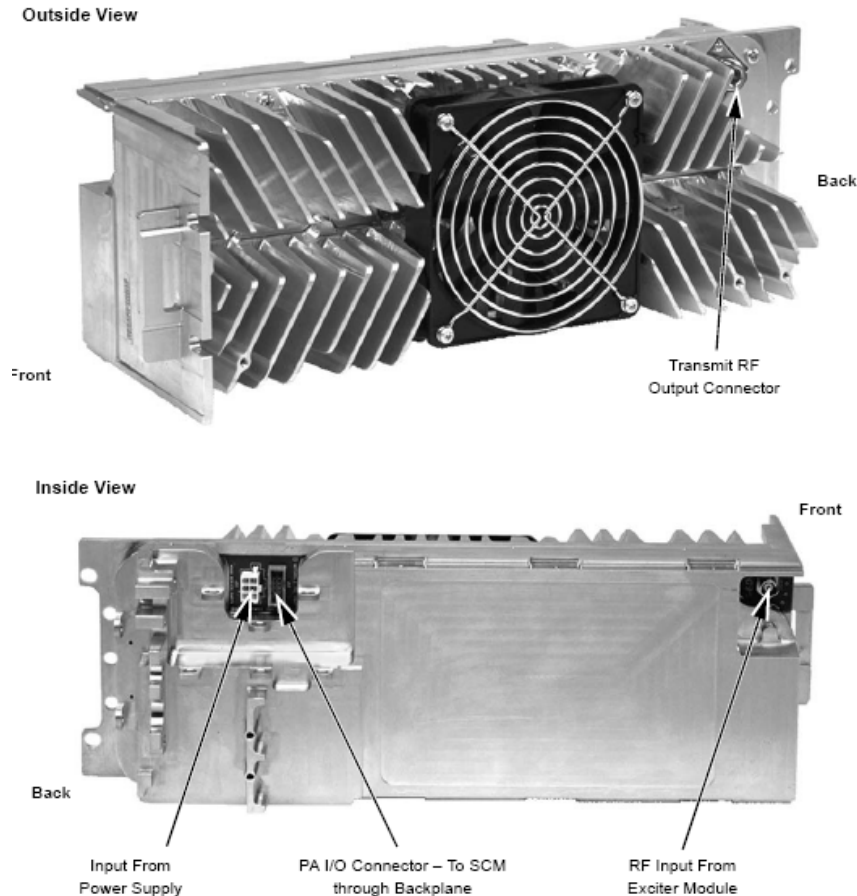

User / Operational Manual

Functional Description / Operation of Modules (Draft)

The following table shows the specifications of MTR Power Amplifier (PA).

Specifications of Power Amplifier

Parameter	Specification
Operational Frequency Range	851–870 MHz (800 MHz), 935 – 941 MHz (900 MHz)
Minimum Input Return Loss (TX mode)	10 dB
Rated RF Output Power Range	20–75 W
Rated RF Input Power Range	12.8–18.5 dBm
28.6V Supply Nominal Voltage (AC Power)	28.6V (+/- 4%)
14.2V Supply Nominal Voltage	14.2V (+/- 3%)
28.6V Supply Maximum Current Draw	12.6A
14.2V Supply Maximum Current Draw	2.0A
Maximum Standby Power Consumption	1.5 W

Functional Theory of Operation

A low-level modulated RF signal (approximately +16 dBm) from the Exciter Module enters the PA Input board via a coax cable. The signal is input to the IPA and amplified to approximately 0 to 5.5 W (depending on the dc power control voltage (V_CNTL) from the PA output board). The IPA output is then fed to the Driver PA module and amplified to greater than 10 Watts (depending on the dc power control voltage). The Driver output is then fed to the Dual Device Module for further amplification.

The output of the DDM is then transferred to the circulator and then to the harmonic filter/coupler via the PA output board. The signal then exits from the Power Amplifier Module via an N-type coax connector.

A single circulator is built into the Power Amplifier Module to provide isolation between the PA module and the transmit antenna.

A thermistor mounted on the PA printed circuit board outputs a variable resistance proportional to the heat sink temperature. This signal is fed to the power control circuitry on the PA output board, which monitors the signal and reduces the PA output power (and enables a fan) if the PA temperature exceeds set limits.

A feedback and control loop configuration is used to regulate the PA output power. The Directional Coupler generates a dc voltage proportional to the PA Module output power. This voltage is fed to power control circuitry on the PA output board where it is compared to reference voltages to generate a dc power control voltage. The Station Control Module sends current and power limit signals to a D/A converter (via the SPI bus) to control the maximum current/control voltage levels. The control voltage is fed to the IPA module where it controls the IPA output, thus controlling the overall output from the PA Module.

Analog signals from various strategic operating points throughout the PA module are fed to an A/D converter, which converts them to a digital signal and, upon request by the Station Control Module, outputs the signal to the Station Control Module via the SPI bus.

For example, the directional coupler generates a dc voltage proportional to the reflected power. This signal is converted to a digital signal and sent to the SCM. If the sense line indicates an impedance mismatch (high VSWR), the PA is either cut back in power or shut down completely.

Functional Description / Operation of Modules (Draft)

Power Supply Module Overview

The Power Supply is described in this section. The information provided is sufficient to give service personnel a functional understanding of the module, allowing maintenance and troubleshooting to the module level. Refer to the service manual for Maintenance and Disassembly/Reassembly Procedures for detailed removal or installation procedures for all modules in the station.

Over-current conditions on either the 28.6 VDC or 14.2 VDC outputs cause the total supply to shutdown and try to restart. If the over-current continues to exist, the power supply will ‘hiccup’ until the overload condition is removed, and will not be damaged by the overload. The 28.6 VDC output is protected by a primary current sense method such that its current limit point varies depending on the load on the other outputs at the time. The trip point for the 14.2 V and 5.1 V outputs is greater than 115% of the maximum current specified for the outputs. The power supply recovers automatically after the removal of the overload condition.

The 28.6 V and 14.2 V outputs are protected from continuous over-voltages by detection circuits that cause the supply to shutdown and then try to restart itself. If the over-voltage condition continues to occur, the supply goes into a ‘hiccup’ mode of shutting down and trying to restart. If the over-voltage condition is removed, the supply automatically recovers. In addition, the 14.2 V and the 5 V outputs are protected by crowbar circuits.

An AC Fail detect signal is provided to indicate (when used with battery backup option) that the power supply is operating from an external dc source rather than the ac mains. This signal is a TTL compatible output capable of sinking 1 mA, and is routed to the Station Control Module. The active-low state indicates ac operation. For the nominal 120 VAC operation, the signal is active-high impedance (indicating an ac mains failure) when the ac voltage is less than 85 Vrms, but more than the minimum voltage that guarantees that all outputs will be in regulation at full load. For the nominal 240 AC operation, the detect point is less than 170 Vrms but more than the minimum ac input voltage that guarantees that all outputs be in regulation at full load.

The supply incorporates temperature sense/fan enable circuitry for controlling a 12VDC fan mounted on the surface of the heatsink assembly. The power supply circuitry senses the internal temperature of the power supply. When the internal temperature exceeds +60°C (± 5°C), +12 V is enabled at J1-1 to turn on the fan. The +12 V fan supply is derived from the +14.2 V output. Power to the fan is off when the temperature is below the set limit. The fan turns for approximately 5 seconds when power is first applied as a diagnostic indicator that the fan is functional.

The power supply will turn off all outputs when an operational ambient temperature of +80°C (±2°C) has been reached with the supply operating at any input within its operating input voltage range (dc and ac).

The following shows the electrical performance specifications for the power supply.

Power Supply Module AC Performance Specifications:

Parameter	Value or Range
Input Voltage Range	85 VAC to 264 VAC
Operating Temperature	-30° to +60° C (-22° to +140° F)
Input Frequency Range	47 to 63 Hz
Steady State Output Voltage	28.6 V @ 13 A, 14.2 V @ 8 A, 5.1 V @ 2 A
Output Power (Rated)	500 W
Output Ripple:	
+28.6 VDC	50 mV p-p, @ 25°C (77°F)
+14.2 VDC	50 mV p-p, @ 25°C (77°F)
+5.1 VDC	100 mV p-p, @ 25°C (77°F)
Efficiency	Greater than 75% (Full Load)

User / Operational Manual

Functional Description / Operation of Modules (Draft)

Power Supply Module DC Performance Specifications:

Parameter	Value or Range
Input Voltage Range	21.6 - 32 VDC
Operating Temperature	-30° to +60° C (-22° to +140° F)
Steady State Output Voltage	28.6 V @ 13 A, Input Voltage Dependent 14.2 V @ 8 A, Regulated 5.1 V @ 2 A, Regulated
Output Power (Rated)	500 W
Output Ripple: +28.6 VDC +14.2 VDC +5.1 VDC	Input Voltage Dependent, 0-0.5V below input 50 mV p-p, @ 25°C (77°F) 100 mV p-p, @ 25°C (77°F)
Efficiency	Greater than 75% (Full Load)