



RM Series/Séries RM Two- Way Radios Radios bidirectionnelles

User Guide
Guide de l'utilisateur



Models RMU2040, RMM2050 / Modèles RMU2043

MOTOROLA, MOTO, MOTOROLA SOLUTIONS and the Stylized M Logo are trademarks or registered trademarks of Motorola Trademark Holdings, LLC and are used under license. All other trademarks are the property of their respective owners. ©2013 Motorola, Inc. All rights reserved. Printed in Malaysia.

Motorola Solutions, Inc. 1301 East Algonquin Road Schaumburg, Illinois 60196, U.S.A.
800-367-2346 motorolasolutions.com

CONTENTS

Contents	1	Antenna	11
Safety	4	LED Indicator	11
Introduction	5	Side Buttons	11
Package Contents	5	The Lithium-Ion (Li-Ion) Battery	11
FCC Licensing Information	7	Battery Features	13
Canada Licensing Information	7	About the Li-Ion Battery	13
General Information	7	Battery Recycling and Disposal	14
The License Application	7	Installing the Lithium-Ion (Li-Ion) Battery	15
Batteries and Chargers		Removing the Lithium-Ion (Li-Ion) Battery	15
Safety Information	8	Power Supply, Adaptor and Drop-in Tray Charger	17
Operational Safety Guidelines	9	Battery Life Information	18
Radio Overview	10	Charging the Battery	20
Parts of the Radio	10		
On/Off/Volume Knob	11		
Accessory Connector	11		
Model Label	11		
Microphone	11		

Getting Started	27	Reading CTCSS/DPL Values	38
Turning radio ON/OFF	27	Reading Auto-Scan Values	39
Adjusting Volume	27	Programming Frequencies, Codes and Auto-Scan	39
Selecting a Channel	27	Programming Mode FAQ	40
Talking and Monitoring	27	Programming Values Example	41
Receiving a Call	28	Example of Programming a Frequency ..	41
Talk Range	28	Example of Programming a Code	42
Radio LED Indicators	30	Example of Programming Auto-Scan ..	43
Hands-Free Use/VOX	31	Other Programming Features	44
With Compatible VOX Accessories ..	31	Scan	44
Setting VOX Sensitivity	32	Editing Scan List	45
Microphone Gain	32	Nuisance Channel Delete	45
Battery Save	32	CPS (Computer Programming Software) ..	46
Reset to Factory Defaults	32	Bandwidth Select	47
End of Transmission Tone (Roger Beep Tone)	33	Time-Out Timer	47
Programming Features	34	Power Select	47
Programming Mode	34	Battery Type Setting	47
Learning to Read the Values the Radio Signals You	34	Call Tones	47
Entering Programming Mode	37	Scramble 	48
Reading Frequencies Values	37	Reverse Burst	48
		Cloning Radios	49

Cloning with a Multi Unit		Antennas	71
Charger (MUC)	49	Audio Accessories	71
Cloning Radio using the Radio to Radio (R2R) Cloning Cable (Optional Accessory).	51	Battery	71
Cloning using the CPS (Computer Programming Software)	53	Carry Accessories	72
Troubleshooting	54	Power Supplies AC Pin Adaptors.	72
Use and Care	58	Software Applications.	72
Frequency and Code Charts	59	Cables	72
RMU2043 - UHF Default		Chargers	72
Frequencies Chart.	59	Power Supplies	73
RMU2040 - UHF Default			
Frequencies Chart.	60		
CTCSS and PL/DPL Codes	61		
Programming Customized Frequencies	66		
Motorola Limited Warranty for the United States and Canada	67		
Accessories	71		

SAFETY

PRODUCT SAFETY AND RF EXPOSURE COMPLIANCE



Caution

Before using this product, read the operating instructions and RF energy awareness information contained in the Product Safety and RF Exposure booklet enclosed with your radio.

ATTENTION!

This radio is restricted to occupational use only to satisfy FCC RF energy exposure requirements.

This device complies with Part 15 of the FCC Rules. Operation is subject to the condition that this device does not cause harmful interference.

INTRODUCTION

Thank you for purchasing the Motorola® RM Series Radio. This radio is a product of Motorola's 80 plus years of experience as a world leader in the designing and manufacturing of communications equipment. The RM Series radios provide cost-effective communications for businesses such as retail stores, restaurants, schools, construction sites, manufacturing, property and hotel management and more. Motorola professional two-way radios are the perfect communications solution for all of today's fast-paced industries.

Note: Read this user guide carefully to ensure you know how to properly operate the radio before use

**Business Radios,
Mailstop 1C15, Motorola
8000 West Sunrise Boulevard
Plantation, Florida 33322**

PACKAGE CONTENTS

- Radio
- Holster
- Lithium-Ion Battery
- Power Supply
- Quick Reference Guide
- Warranty Card
- Drop-in Tray Charger
- Product Safety & RF Exposure Booklet

This User Guide can be downloaded from
www.motorolasolutions.com/RMSeries.
Product-related questions, contact:

1-800-448-6686 (US and Canada)

**1-888-390-6456 on your TTY (Text
Telephone)**

FCC LICENSING INFORMATION

INTERFERENCE INFORMATION

This device complies with Part 15 of the FCC Rules. Operation is subject to the condition that this device does not cause harmful interference.

RM Series Business two-way radios operate on radio frequencies that are regulated by the Federal Communications Commission

(FCC). To transmit on these frequencies, you are required to have a license issued by the FCC. Application is made available on FCC Form 601 and Schedules D, H, and Remittance Form 159.

To obtain these FCC forms, request document 000601 which includes all forms and instructions. If you wish to have the document faxed, mailed or have questions, use the following contact information.

**Faxed contact the
Fax-On-Demand
system at:**

1-202-418-0177

Mailed call the FCC forms hotline at:

1-800-418-FORM
1-800-418-3676

**Questions regarding FCC
license contact the FCC at:**

1-888-CALL-FCC
1-888-225-5322
Or: <http://www.fcc.gov>

Before filling out your application, you must decide which frequency(ies) you can operate on. See “Frequencies and Code Charts”. For questions on determining the radio frequency, call Motorola Product Services at:

1-800-448-6686

Changes or modifications not expressly approved by Motorola may void the user's authority granted by the FCC to operate this radio and should not be made. To comply with FCC requirements, transmitter adjustments should be made only by or under the supervision of a person certified as technically qualified to perform transmitter maintenance and repairs in the private land mobile and fixed services as certified by an organization representative of the user of those services.

Replacement of any transmitter component (crystal, semiconductor, etc.) not authorized by the FCC equipment authorization for this radio could violate FCC rules.

Use of this radio outside the country where it was intended to be distributed is subject to government regulations and may be prohibited

CANADA LICENSING INFORMATION

GENERAL INFORMATION

The operation of your Motorola radio is subject to the Radiocommunications Act and must comply with rules and regulations of the Federal Government's department of Industry Canada. Industry Canada requires that all operators using Private Land Mobile frequencies obtain a radio license before operating their equipment.

An application for your Industry Canada license is made on the form included with your radio. Additional forms and latest license application versions can be obtained from the nearest Industry Canada District office. A list of these offices is included for your information.

THE LICENSE APPLICATION

General Instructions

1. Fill in the items as per the instructions. If you need additional space for any item use the reverse side of the application.
2. Be sure to use a typewriter or print legibly.
3. Make a copy for your files.
4. Prepare a cheque or money order made out to the "Receiver General for Canada", for an amount, which is on the following schedule, for each radio purchased. (License is valid until April 1st of each year, and the renewed.
5. Mail your completed application, along with your cheque or money order to the closest Industry Canada District office, according to the list on pages

To obtain the latest Canadian License Application form, please go to:

www.ic.gc.ca

BATTERIES AND CHARGERS SAFETY INFORMATION

This document contains important safety and operating instructions. Read these instructions carefully and save them for future reference.

Before using the battery charger, read all the instructions and cautionary markings on

- The charger,
 - The battery, and
 - The radio using the battery
1. To reduce risk of injury, charge only the rechargeable Motorola-authorized batteries. Other batteries may explode, causing personal injury and damage.
 2. Use of accessories not recommended by Motorola may result in risk of fire, electric shock, or injury.
 3. To reduce risk of damage to the electric plug and cord, pull by the plug rather than the cord when disconnecting the charger.
 4. An extension cord should not be used unless absolutely necessary. Use of an improper extension cord could result in risk of fire and electric shock. If an extension cord must be used, make sure that the cord size is 18AWG for lengths up to 6.5 feet (2.0 m), and 16AWG for lengths up to 9.8 feet (3.0 m).
 5. To reduce risk of fire, electric shock, or injury, do not operate the charger if it has been broken or damaged in any way. Take it to a qualified Motorola service representative.
 6. Do not disassemble the charger; it is not repairable and replacement parts are not available. Disassembly of the charger may result in risk of electrical shock or fire.
 7. To reduce risk of electric shock, unplug the charger from the AC outlet before attempting any maintenance or cleaning

OPERATIONAL SAFETY GUIDELINES

- Turn the radio OFF when charging battery.
- The charger is not suitable for outdoor use. Use only in dry locations/conditions.
- Connect charger only to an appropriately fused and wired supply of the correct voltage (as specified on the product).
- Disconnect charger from line voltage by removing main plug.
- The outlet to which this equipment is connected should be nearby and easily accessible.
- In equipment using fuses, replacements must comply with the type and rating specified in the equipment instructions.
- Maximum ambient temperature around the power supply equipment must not exceed 40°C (104°F).
- Power output from the power supply unit must not exceed the ratings stated on the product label located at the bottom of the charger.
- Make sure that the cord is located where it will not be stepped on, tripped over, or subjected to water, damage, or stress.

RADIO OVERVIEW

PARTS OF THE RADIO

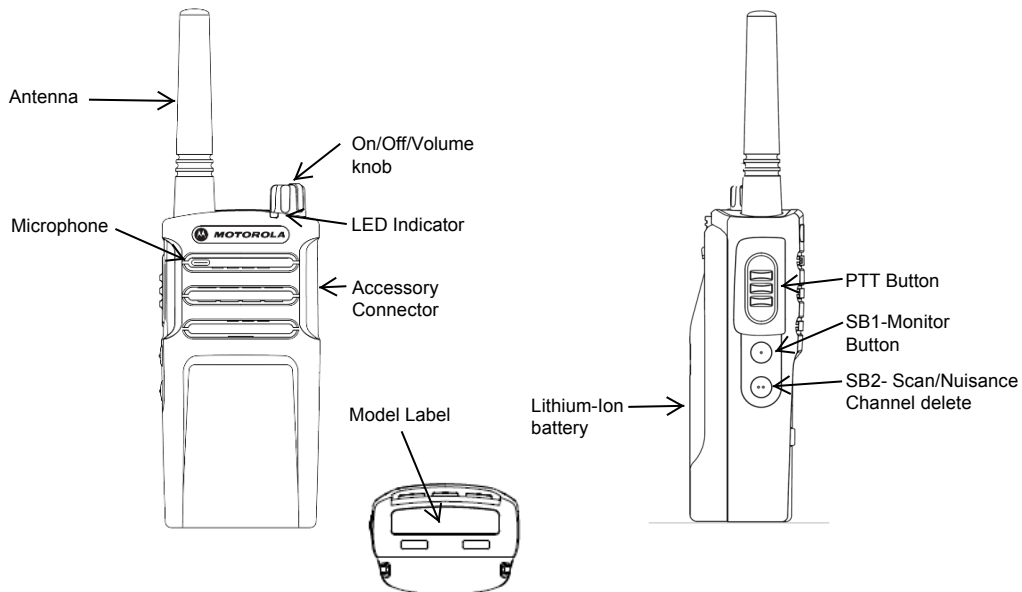

On/Off/Volume Knob

Used to turn the radio ON or OFF and to adjust the radio's volume.

Accessory Connector

Used to connect compatible audio accessories.

Model Label

Indicates the model of the radio.

Microphone

Speak clearly into the microphone when sending a message.

Antenna On all RM Series radios, the antenna is non-removable

LED Indicator

Used to give battery status, power-up status, radio call information and scan status.

Side Buttons

Push-to-Talk (PTT) Button

- Press and hold down this button to talk, release to listen it

Side Button 1 (SB1)

- The Side Button 1 is a general button that can be configured by the Computer Programming Software - CPS. The default setting of SB1 is 'Monitor'.

Side Button 2 (SB2)

- The Side Button 2 is a general button that can be configured by the CPS. The SB2 default setting is set to scroll until the desired channel is selected.

RM Series provides a Li-Ion battery. For more information, see "Battery Feature on Pg.13.

This User Guide covers multiple RM Series models, and may detail some features your radio does not have. The radio's model is shown on the bottom of the radio and provides you the following information:

Model	Frequency Band	Transmit Power (Watts)	Number of Channels	Antenna
RMU2043	UHF	2	4	Non-Removable
RMM2050	VHF- MURS	2	5	Non-Removable
RMU2043	UHF	2	4	Non-Removable

BATTERY FEATURES

About the Li-Ion Battery

The RM Series radio comes equipped with a rechargeable Li-Ion battery. This battery should be charged before initial use to ensure optimum capacity and performance.

Battery life is determined by several factors. Among the more critical are the regular overcharge of batteries and the average depth of discharge with each cycle. Typically, the greater the overcharge and the deeper the average discharge, the fewer cycles a battery will last. For example, a battery which is overcharged and discharged 100% several times a day, lasts fewer cycles than a battery that receives less of an overcharge and is discharged to 50% per day. Further, a battery

which receives minimal overcharging and averages only 25% discharge, lasts even longer.

Motorola batteries are designed specifically to be used with a Motorola charger and vice versa. Charging in non-Motorola equipment may lead to battery damage and void the battery warranty. The battery should be at about 77°F (25°C) (room temperature), whenever possible. Charging a cold battery (below 50° F [10°C]) may result in leakage of electrolyte and ultimately in failure of the battery. Charging a hot battery (above 95°F [35°C]) results in reduced discharge capacity, affecting the performance of the radio. Motorola rapid-rate battery chargers contain a temperature-sensing circuit to ensure that batteries are charged within the temperature limits stated above.

Battery Recycling and Disposal

Li-Ion rechargeable batteries can be recycled. However, recycling facilities may not be available in all areas. Under various U.S. state laws and the laws of several other countries, batteries must be recycled and cannot be disposed of in landfills or incinerators. Contact your local waste management agency for specific requirements and information in your area. Motorola fully endorses and encourages the recycling of Li-Ion batteries. In the U.S. and Canada, Motorola participates in the nationwide Rechargeable Battery Recycling Corporation (RBRC) program for Li-Ion battery collection and recycling.

Many retailers and dealers participate in this program. For the location of the drop-off facility closest to you, access RBRC's Internet web site at:

www.rbrc.com

or call:

1-800-8-BATTERY

This internet site and telephone number also provides other useful information concerning recycling options for consumers, businesses and governmental agencies.

Installing the Lithium-Ion (Li-Ion) Battery

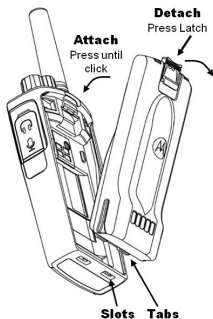

1. Turn OFF the radio.
2. With the Motorola logo side up on the battery pack, fit the tabs at the bottom of the battery into the slots at the bottom of the radio's body.
3. Press the top part of the battery towards the radio until a click is heard.

Note: To learn about the Li-Ion Battery Life features, refer to "About the Li-Ion Battery" on page 13

Removing the Lithium-Ion (Li-Ion) Battery

1. Turn OFF the radio.
2. Push down the battery latch and hold it depressed while removing the battery.
3. Pull the battery away from the radio.

Holster

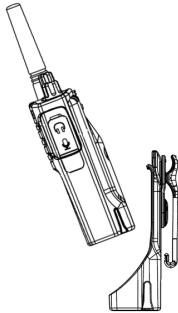

1. Slide the radio into the base of the holster and then press the radio against the back of the holster until the top clips are inserted in the top latches of the battery.
2. To remove, detach the top clips of the holster from the top latches of the battery and then slide the radio up from the holster pocket.

Power Supply and Drop-in Tray Charger

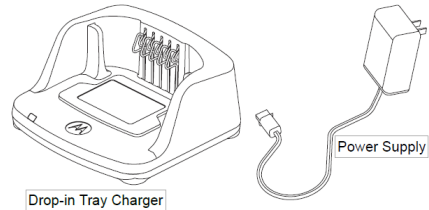

The radio is equipped with one Drop-in Tray Charger and one Power Supply with Adaptor. For details, see “Chargers” on page 72.

Battery Life Information

When the Battery Save feature is ON (enabled by default) the battery life will be longer. The following chart summarizes battery life estimations:

Li-Ion battery Life with Tx Power 2 Watts		
Battery Type	Battery Safe Off	Battery Safe On
Standard	12 hrs.	15 hrs.

Note: Battery life is estimated based on 5% transmit/ 5% receive/ 90% standby standard duty cycle

Charging the Battery

The RM series radios offers two types of power supplies:

- Standard Power Supply and,
- Rapid Power Supply.

Note: The radio comes equipped with a Standard Power Supply

To charge the battery (with the radio attached), place it in a Motorola-approved Drop-in Tray Single Unit Charger or Drop-in Tray Multi Unit Charger.

Note: When acquiring additional chargers or power supplies, make sure you have similar drop-in tray chargers and power supplies sets (all “rapid” or all “standard”). For part number details, refer to “Chargers” on page 72

Charging with the Drop-in Tray Single Unit Charger (SUC)

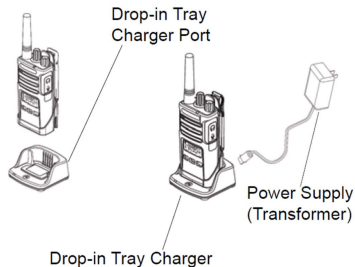

1. Place the drop-in tray charger on a flat surface.
2. Insert the connector of the power supply into the port on the side of the drop-in tray charger.
3. Plug the AC adaptor into a power outlet.
4. Insert the radio into the tray with the front of the radio facing the front of the charger, as shown.

Note: When charging a battery attached to a radio, turn the radio OFF to ensure a full charge. See “Operational Safety Guidelines” on page 9 for more information



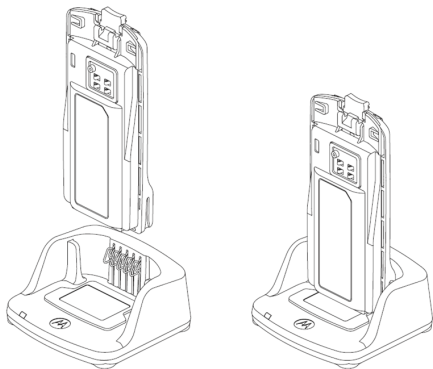





CHARGING A STAND-ALONE BATTERY



To charge only the battery - at step 4, insert the battery into the tray, with the inside surface of the battery facing the front of the charger, as shown. Ensure the slots in the battery correctly engage in the charger

Drop-in Tray Charger LED Indicators

Table 2: Charger LED Indicator

Status	LED Status	Comments
Power On	Green for approx. 1 sec 	
Charging	Steady red 	
Charge Complete	Steady green 	
Battery Fault (*)	Red fast flash 	
Waiting to charge (**)	Amber slow flash 	
Battery Level Status	NA	Battery empty
	Flash red 1 time 	Battery low
	Flash amber 2 times 	Battery medium
	Flash green 3 times 	Battery high

(*) Normally, re-positioning the battery pack will correct this issue.

(**) Battery temperature is too warm or too cold or wrong power voltage is being used.

If there is NO LED indication:

1. Check if the radio with battery, or the battery alone, is inserted correctly (refer to step 3 of "Charging Procedure").
2. Make sure the power cord is securely plugged into the charger and an appropriate AC outlet and that there is power to the outlet.
3. Confirm that the battery being used with the radio is listed in Table 1.

Estimated Charging Time

The following table provides the estimated charging time of the battery. For further details, see “Battery” on page 71.

Charging solutions	Estimated Charging time - Hours	
	Standard Battery	High Cap. Battery
Standard	≤ 4.5	N/A yet
Rapid	≤ 2.5	N/A yet

Charging a Radio and Battery using a Multi Unit Charger- MUC (Optional Accessory)

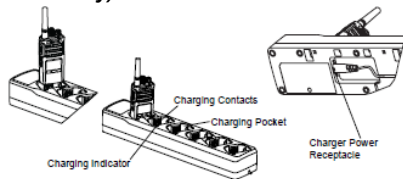

Figure 1: Multi-Unit Charger

The Multi Unit Charger (MUC) allows drop-in charging of up to 6 radios or batteries. Batteries can be charged with the radios or removed and placed in the MUC separately. Each of the 6 charging pockets can hold a radio (with or without holster) or battery, but not both.

1. Insert the power cord plug into the MUC's jack.
2. Place the charger on a flat surface.
3. Plug the cord into an AC outlet.
4. Turn the radio OFF.
5. Insert the radio or battery into the charging pocket.

Notes:

- This Multi Unit Charger also allows you to clone up to 2 radios (2 Source radios and 2 Target radios). Refer to page 51 for details.
- Further details on MUC's operation are explained in the Instructions Sheet provided with the MUC. For part number details, refer to the Accessories section.

Table 2: Charger LED Indicator

Status	LED Status	Comments
Power On	Green for approx. 1 sec	●
Charging	Steady red	●
Charge Complete	Steady green	●
Battery Fault (*)	Red fast flash	⚡
Waiting to charge (**)	Amber slow flash	⚡
Battery Level Status	NA	Battery empty
	Flash red 1 time	⚡ Battery low
	Flash amber 2 times	⚡ Battery medium
	Flash green 3 times	⚡ Battery high

(*) Normally, re-positioning the battery pack will correct this issue.

(**) Battery temperature is too warm or too cold or wrong power voltage is being used.

If there is NO LED indication:

1. Check if the radio with battery, or the battery alone, is inserted correctly (refer to step 3 of "Charging Procedure").
2. Make sure the power cord is securely plugged into the charger and an appropriate AC outlet and that there is power to the outlet.
3. Confirm that the battery being used with the radio is listed in Table 1.

GETTING STARTED

For the following explanations, refer to “Parts of the Radio” on page 10.

TURNING RADIO ON/OFF

To turn ON the radio, rotate the On/Off/Volume Knob clockwise. The radio will chirp and the LED Indicator will briefly blink red.

To turn the radio OFF, rotate the On/Off/Volume Knob counterclockwise until you hear a ‘click’ and the radio LED Indicator turns OFF.

ADJUSTING VOLUME

Turn the On/Off/Volume Knob clockwise to increase the volume, or counterclockwise to decrease the volume.

Note: Do not hold the radio too close to the ear when the volume is high or when adjusting the volume.

SELECTING A CHANNEL

To select a channel, press SB2 side button until you reach the desired channel. Voice announcement will indicate the channel selected.

2 channels are active with factory default setting. Refer to "Advanced Radio Configuration" on Page 34 to active more channels. The radio can operate up to 4 channels.

Each channel has its own Frequency, Interference Eliminator Code and Scan Settings.

TALKING AND MONITORING

It is important to monitor for traffic before transmitting to avoid ‘talking over’ someone who is already transmitting.

To monitor, long press and hold the SB1(*) button to access channel traffic. If no activity is present, you will hear ‘static’. To release, press SB1 again. Once channel traffic has cleared, proceed with your call by pressing the PTT button. When transmitting, the LED Indicator will be On solid red during transmission.

Notes:

- To listen to all activity on a current channel, short press the SB1 to set the CTCSS/DPL code to 0. This feature is called 'CTCSS/DPL Defeat (Squelch set to SILENT)'.
- (*) This assumes SB1 is not being programmed for a different mode.

RECEIVING A CALL

1. To select a channel, press SB2 side button until you reach the desired channel, Voice announcement will indicate the channel selected
2. Make sure the PTT button is released and listen for voice activity.
3. The LED Indicator will be solid red while the radio is receiving a call.
4. To respond, hold the radio vertically 1 to 2 inches (2.5 to 5cm) from mouth. Press the PTT button to talk; release it to listen.

TALK RANGE

Talk Range		
Model	Industrial	Multi-Level
		Inside steel/concrete industrial buildings
RMU/ RMM	Up to 250,000 Sq. Ft.	Up to 20 Floors

To establish a proper two-way communication, the channel, frequency, and interference eliminator codes must be the same on both radios. This depends on the stored profile that has been preprogrammed on the radio:

1. **Channel:** Current channel that the radio is using, depending on radio model.
2. **Frequency:** The frequency the radio uses to transmit/receive.
3. **Interference Eliminator Code:** These codes help minimize interference by providing a choice of code combinations.

4. **Scramble Code:** Codes that make the transmissions sound garbled to anyone listening who is not set to that specific code.
5. **Bandwidth:** Some frequencies have selectable channel spacing, which must match other radios for optimum audio quality (only available for RMU2043).

For details on how to set up frequencies and CTCSS/DPL codes in the channels, refer to “Programming Selection Mode” in page 36.

RADIO LED INDICATORS

RADIO STATUS	LED INDICATION
Channel Alias Edit	Red heartbeat
Channel Busy	Solid orange
Cloning Mode	Two orange heartbeats
Cloning In Progress	Solid orange
Fatal Error at Power up	One green blink, one orange blink, one green blink, then repeat for 4 seconds
Low Battery	Orange blink
Low Battery Shutdown	Orange heartbeat
Monitor	LED is OFF
Power-Up	Solid red for 2 seconds
'Idle' Programming Mode / Channel Mode	Green heartbeat
Scan Mode	Red Blink
Transmit (Tx)/Receive (RX)	Solid red
Transmit in Low Power Select	Solid Orange

Note: Channel Alias Edit only applies to Display Models

HANDS-FREE USE/VOX

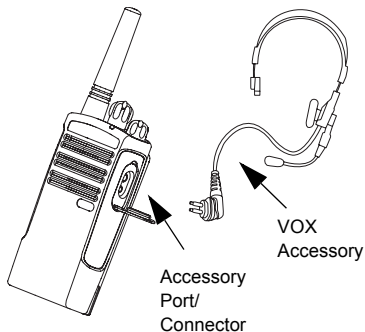

Motorola RM Series radios can operate hands-free (VOX) when used with compatible VOX accessories.

With Compatible VOX Accessories

The default factory setting for VOX sensitivity level is OFF. Before using VOX, set VOX level to a setting different from 'OFF' via the CPS (Customer Programming Software). Then, perform the following steps:

1. Turn the radio OFF.
2. Open accessory cover.
3. Insert the audio accessory's plug firmly into accessory port.
4. Turn radio ON. The LED Indicator will blink double red.
5. Lower radio volume BEFORE placing accessory near ear.
6. To transmit, speak into accessory microphone and to receive, stop talking.
7. VOX can be temporarily disabled by pressing the PTT button or by removing the audio accessory.

Note: To order accessories, refer to:
www.motorolasolutions.com/RMseries or
 call **1 (800) 448-6686**, or contact your
 Motorola point of purchase

Setting VOX Sensitivity

The sensitivity of the radio's accessory or microphone can be adjusted to suit different operating environments. VOX sensitivity can be programmed via the CPS.

Default value is OFF. If you want to use the VOX feature, VOX level should be set at a value different from OFF.

- 1 = Low audio input levels will trigger the Tx
- 2 = Medium sensitivity
- 3 = High audio input levels will trigger the Tx

Microphone Gain

The sensitivity of the microphone can be adjusted to fit different users or operating environments.

This feature can be adjusted only through the CPS. Microphone default setting is set to 2 = Medium Gain.

Battery Save

Battery Save feature extends battery life as your radio goes into 'Idle' state. To enable/disable press SB1 and SB2 buttons simultaneously for 2 or 3 seconds while powering up the radio until you hear a quick series of beeps. To have a slightly better attack time, set Battery Save feature to OFF so that the radio is always ready to transmit or receive without any delays.

Note: Battery Save feature is set to ON by default

Reset to Factory Defaults

Reset to Factory Defaults will set back all radio features to the original factory default settings. To do so, press PTT, SB2 and SB1 simultaneously while turning ON the radio until you hear a high tone chirp.

End of Transmission Tone (Roger Beep Tone)

Short press the SB1 button while turning ON the radio to enable/disable End of Transmission Tone.

Note: This setting is set to OFF by default

PROGRAMMING FEATURES

To easily program all the features in your radio, it is recommended to use the Costumer Programming Software (CPS) and programming cable.

CPS software download is available for free at www.motorolasolutions.com/RMseries

Advanced Configuration

Advanced Configuration is a configuration mode that allows the customization of additional features via the front panel.

The non-display models don't have a display to show programmed values, then navigation is guided via voice prompt.

When the radio is set to Advanced Configuration, you are able to read and modify four features:

- Frequency Selection
- CTCSS/DPL Codes
- Auto-Scan.
- Active Channels

The Frequency Select feature allows you to choose frequencies from a pre-defined list.

The Interference Eliminator Code (CTCSS/ DPL) helps minimize interference by providing you with a choice of code combinations that filter out static, noise, and unwanted messages.

The Auto-Scan feature allows you to set a particular channel to automatically enable Scan each time you switch to that channel.

The Active Channels feature allows you to increase or decrease the amount of channels active (In the range of maximum channels).

Entering Advanced Configuration Mode

Note: Before programming the features, make sure your radio is set to the channel you wish to program. You can do so before entering Advanced Configuration Mode or at any time during the Advanced Configuration Mode by pressing SB2 until reaching the desired channel.

To read or modify Frequencies, Codes, Auto-Scan or Active Channels, set the radio to 'Advanced Configuration Mode' by pressing and holding the PTT and SB1 buttons simultaneously for 3 to 5 seconds while powering up the radio and until you hear a voice prompt saying "Programming Mode" and "Channel #".

Note: 'Idle' Programming Mode is the stage of the Programming Mode in which the radio is waiting for the user to start the radio programming cycle.

Once you are in the 'Idle' Programming Mode, you will be able to hear the Frequencies, Codes, Auto-Scan and active channels settings by short pressing the PTT button to move along the different programmable features.

Entering Frequencies Values

RM Series radios have 89 frequencies for UHF.

Once in 'Idle' Programming Mode, the first value available to change is Channel number, you can change the channel by pressing SB2 button until you reach desired Channel, voice announcement will indicate channel selected. Using SB1 and SB2 you can change values. The value selected is announced by voice prompt.

Reading CTCSS/DPL Values

If you continue short pressing the PTT button the radio will move forward to programming CTCSS/PL Codes.

After hearing the current value for CTCSS/PL Code you can scroll to a new code value using the SB1 or SB2 button.

RM Series have up to 122 codes available (refer to "Frequencies and Codes Charts" Section).

Reading Auto-Scan Values

After hearing the CTCSS/DPL codes, short press the PTT button and the radio will move forward to programming Auto-Scan.

Auto-Scan only has two values:

- Enabled
- Disabled

Note: While in Auto-Scan Mode, if you short press PTT button, the radio will move forward to programming the "Active Channels" feature, so you can modify the amount of channels available for your unit using the SB1 or SB2 button.

Saving Settings

If you are satisfied with the setting, you can either:

- short press PTT to continue programming,
- long press PTT to save and return to 'Idle' Programming Mode, or
- long press the PTT button twice to exit 'Idle' Programming Mode and return to the normal radio operation.

Note:

- If you do not wish to save the value you just programmed, turn the radio OFF.
- If you 'roll-over' to the beginning of 'Idle' Programming Mode you will hear "Channel #" and the LED Indicator will start blinking green again. All values that were changed will be automatically saved.

Programming Mode FAQ

1. *I got distracted while programming and forgot which feature I was programming. What should I do?*

Return to 'Idle' Programming Mode and start over.

- Long press the PTT button. The radio will return to the 'Idle' Programming Mode or,
- Turn OFF the radio and enter Programming Mode again (see instructions in the beginning of this section)

2. *I am trying to program a frequency (or code) value but the radio would not do it. It rolled over and took me back to value '0'.*

The radio will not allow you to program any values that are not available in the frequencies and codes pool. For example, if you try to program code 128, the radio would not accept it, as the maximum value allowed is 122. Same thing will happen with frequencies. Check the Frequencies and Codes Charts section to make sure you are programming a valid number.

3. *I am trying to enter the Programming Mode but the radio would not do it.*

The radio might be locked using the CPS to not allow Front Panel Programming. To re-enable, use the CPS.

4. *When I was programming I made a mistake and programmed the wrong value. How can I erase it or re-program it?*

If you make a mistake while programming a value you have two choices:

- The radio settings will roll-over each time they reach a maximum or minimum value. Keep increasing (short press SB1) or decreasing (short pressing SB2) until you get the desired value or,
 - Turn OFF the radio and start-over.
5. *I just programmed the value I wanted. How do I exit Programming Mode?*
- If you are in Programming Mode you can exit by long pressing the PTT button twice.
 - If you are already in the 'Idle' Programming Mode, long press the PTT button once.

6. *I am done programming the features in this channel and want to program another channel.*

Press short PTT several times until you hear "Channel #", then switch channel using Channel Selector Knob. If you wish to save the changes, make sure you are in the 'Idle' Programming Mode before switching the channel as otherwise you will lose the changes made.

PROGRAMMING VALUES EXAMPLE

Example of Programming a Frequency

Assuming current frequency value is set to Channel 1, with the UHF default frequency '02' (equivalent to 464.5500 MHz), and you want to change it to Frequency Number = '13' (which is mapped to 461.1375 MHz), follow this sequence:

- Enter Programming Mode

- Short press the PTT button to enter Frequency Programming Selection Mode. Radio will announce current value '2'
- Press SB1 button eleven times to scroll up the frequency list and you will hear frequency "13"
- Long press the PTT button. LED Indicator will show a green heartbeat to indicate 'Idle' state.
- Long press the PTT button to exit Programming Mode or turn radio OFF.

Example of Programming a Code

Assuming current code value is set to factory default '001', and you want to change it to CTCSS/DPL Code = 103 follow the sequence below:

- Enter into Advanced Configuration Mode
- Short press the PTT button twice and you will hear "Code #" (Entering CTCSS/DPL Programming Selection Mode).
- Press and hold SB1 or SB2, selections shall fast forward/rewind starting at the nearest 10's, when released the radio starts playing the first, second and third digit in full, keep pressing SB1/SB2 several times until you hear "103"
- Long press the PTT button. LED Indicator will show a green heartbeat to indicate 'Idle' state.
- Long press the PTT button to exit Programming Mode or turn radio OFF.

Example of Programming Auto-Scan

Auto-Scan is the third Programming Mode and can be set to either ON or OFF on a particular channel.

To set Auto-Scan to ON:

- Enter into advanced Configuration Mode and select the desired channel.
- Short press the PTT button three times to enter Auto-Scan Programming Selection Mode. The radio will announce "Auto-Scan" and current setting (Enabled or Disabled).
- Short press the SB1 or SB2 buttons to toggle Enabled/Disabled for the Auto-Scan feature on the selected channel.
- Long press the PTT button. LED Indicator will show a green heartbeat to indicate "Idle" state.
- Long press the PTT button to exit Programming Mode or turn radio OFF.

Example of Programming Active Channels

Active Channels is the last Programming Mode and It allows you to modify the number of active channels the radio will be programmed to support.

To set Active Channels:

- Enter Programming Mode and select the desired channel
- Short press the PTT button Four times to enter Active Channels Programming Selection Mode.
- The radio will announce "Active Channels" and current value.
- Short press the SB1 or SB2 buttons until you hear the number of channels desired.
- Long press the PTT button. LED Indicator will show a green heartbeat to indicate "Idle" state.
- Long press the PTT button to exit Programming Mode or turn radio OFF.

OTHER PROGRAMMING FEATURES

Scan

Scan allows you to monitor other channels to detect conversations. When the radio detects a transmission, it will stop scanning and will receive on the active channel. This will allow you to listen and talk to people on that channel without having to change channel. If there are transmissions on another channel once the radio has stopped scanning then you will not hear that activity. After activity has ceased on the channel which the radio has stopped, scanning will resume again after 5 seconds of no activity on that channel.

- To start scanning, press the SBx (x=1 or 2) button (Scan has to be programmed to either SB1 or SB2 via CPS). SB2 default is Scan/ Nuisance delete,

- To stop scanning, short press the SBx button again.
- By pressing the PTT button while the radio is scanning, the radio will transmit on the channel which was selected before Scan was activated. If no transmission occurs within five seconds, scanning will resume.
- If you want to scan a channel without Interference Eliminator Codes (CTCSS/DPL), set the code settings for the channels to '0' in the CTCSS/DPL Programming Selection Mode.

Whenever the radio is set up in Scan, the LED Indicator will signal a Red blink.

Editing Scan List

Scan Lists can be edited by using the CPS (refer to CPS section on page 46)

Nuisance Channel Delete

Nuisance Channel Delete allows you to temporarily remove channels from the Scan List. This feature is useful when frequent, irrelevant conversations on a channel tie up the scanning feature, becoming a nuisance to the user.

To delete a channel from the Scan List:

- To start scanning, press the SBx (x=1 or 2) button (Scan has to be programmed to either SB1 or SB2 via CPS). SB2 default is Scan/Nuisance delete,

Wait until the radio stops on the channel you wish to eliminate, then long press the SBx button to delete it.

- The channel will not be scanned again until you exit Scan by short pressing the SBx button again or by turning the radio OFF and back ON.

CPS (COMPUTER PROGRAMMING SOFTWARE)

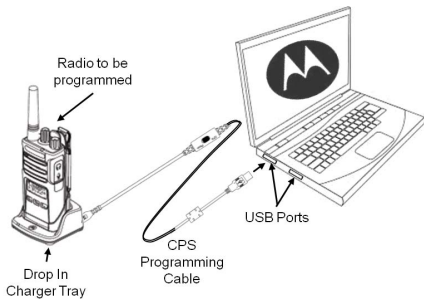

The easiest way to program or change features in your radio is by using the Computer Programming Software (CPS) and the CPS Programming Cable(*). CPS Software is available for free as web based downloadable software at:

www.motorolasolutions.com/RMseries

To program, connect the RM Series radio via the Drop-in Charger Tray and CPS Programming Cable as shown in the picture above.

CPS allows the user to program frequencies, PL/DPL codes, as well as other features such as: Bandwidth Select, Time-out Timer, Power Select, Scan List, Call Tones, Scramble, Reverse Burst, etc. CPS is a very useful tool as it can also lock the Front-Panel Radio Programming to avoid accidentally erasing the current radio settings. It also provides security by giving the option to set up a password for radio profile management. Please refer to Features Summary Chart Section at the end of the user guide for more details.

Note: (*) CPS Programming Cable P/N HKKN4027A is an accessory sold separately. Please contact your Motorola point of purchase for more information.

Bandwidth Select (Only Canada models)

All US models are compliant with the narrowbandwidth FCC regulation.

Default setting for Bandwidth Select depends on the specific frequency and channel. Some frequencies have selectable channel spacing, which must match with other radios for optimum audio quality.

For details, refer to Frequency and Code Charts section.

Time-Out Timer

When pressing the PTT button, transmissions will be terminated after a preset time of continuous transmitting. The default setting is 60 sec and can be changed using the CPS.

Scramble

The Scramble feature makes transmissions sound garbled to anyone listening without the same code. Scramble default value is OFF. The Scramble feature must be programmed to SB1 or SB2.

Power Select

Power Select allows you to select between high and low transmission power per channel. The power levels for RM Series toggle between 2W and 1W.

Call Tones

Call Tones feature allows you to transmit an audible tone to other radios on the same channel and alerting them that you are about to talk or alerting them without speaking. The call tones feature must be programmed to SB1 or SB2 and 1 of 3 pre-recorded tones selected

Reverse Burst

Reverse Burst eliminates unwanted noise (squelch tail) during loss of carrier detection. You can select values of either 180 or 240 to be compatible with other radios. Default is 180.

Notes: Some of the features available with the CPS software may vary depending on the radio model.

CLONING RADIOS

You can clone RM Series radio profiles from one Source radio to a Target radio by using any one of these 3 methods:

- Using a Multi Unit Charger (MUC - optional accessory),
- Two Single Unit Chargers (SUC) and a Radio-to-Radio cloning cable (optional accessory),
- the CPS (free software download) and CPS programming cable ((optional accessory).

Cloning with a Multi Unit Charger (MUC)

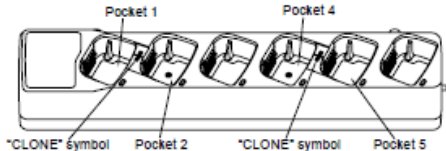

To clone radios using the MUC, there must be at least two radios:

- a Source radio (radio which profiles will be cloned

or copied from) and

- a Target radio (the radio which profile will be cloned from the source radio.)

The Source radio has to be in Pocket 1 or 4 while the Target radio has to be in Pocket 2 or 5, matching in the MUCs pockets by pairs as follows:

- 1 and 2 or,
- 4 and 5

When cloning, the MUC does not need to be plugged into a power source, but ALL radios require charged batteries.

1. Turn ON the Target radio and place it into one of the MUC Target Pockets
2. Power the Source radio following the sequence below:
 - Long press the PTT button and SB2 simultaneously while turning the radio ON.

- Wait for 3 seconds before releasing the buttons until a distinctive audible tone is heard and 'Cloning' is announced.
3. Place the Source radio in the source pocket that pairs with the target pocket you chose in step 1. Press and release SB1 on Source radio.
 4. After cloning is completed, the Source radio will announce either 'Successful' (cloning was successful) or 'failed' (cloning process has failed).
 5. Once you have completed the cloning process, turn the radios OFF and ON to exit the 'cloning' mode.
- If cloning fails please refer to "What To Do if Cloning Fails" on page 54.

When ordering the MUC, please refer to P/N PMLN6384A.

Notes:

- Paired Target radios and Source radios must be of the same band type in order for the cloning to run successfully.
- MUC pocket numbers should be read from left to right with the Motorola logo facing front.

CPS and Cloning Cables (Optionals)

- Both **CPS** and **Cloning** cables are made to work either with RM Series radios or RDX series. Cloning cable also can work with a mix of RDX and RM radios.
- The CPS cable is made to program RM series radio when the switch is in "Flash" position. If you want to use the CPS cable to program an RDX radio, make sure the switch is in "CPS" position and attach a USB convertor provided as part of the CPS cable kit.
- Cloning** cable allows you to clone:
 - RM Series, make sure the switch is in "Cloning" position.
 - RDX radios, make sure the switch is in "Legacy" position there is one USB convertor attached on each side.
 - RM and RDX radios, make sure the switch is in "Legacy" position and use a USB convertor to connect to the RDX SUC.
 Cloning cable kit provides 1 USB convertor.

CPS Cable

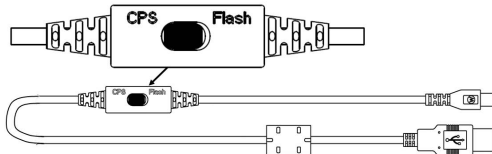

Cloning Cable

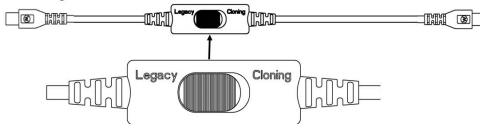

USB Converter



Cloning Radio using the Radio to Radio (R2R) Cloning Cable (Optional Accessory)

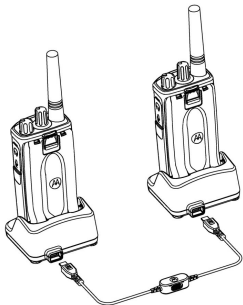

Operating Instructions

1. Before beginning the cloning process, make sure you have:
 - A fully charged battery on each one of the radios.
 - Two Single Unit Chargers (SUC). Either 2 SUC for RM Series or 1 SUC for RM Series and 1 SUC for RDX Series
 - Turn OFF the radios and,
 2. Unplug any cables (power supply or USB cables) from the SUCs.
 3. Plug one side of the cloning cable mini connector to one SUC. Plug the other end to the second SUC.
- Note:** During the cloning process no power is being applied to the SUC. The batteries will not be charged. A data communication is being established between the two radios.
4. Turn ON the Target radio and place it into one of the SUCs.
 5. On the Source radio, power the radio following the sequence below:
 - Long press the PTT button and SB2 simultaneously while turning the radio ON.
 - Wait for 3 seconds before releasing the buttons until you hear a distinctive audible tone and the word "Cloning"
 6. Place the Source radio in its SUC, press and release SB1.

7. After cloning is completed, the Source radio will announce either 'pass' (cloning was successful) or 'fail' (cloning process has failed). If the Source radio is a display model, it will either show 'Pass' or 'Fail' on the display (a tone will be heard within 5 seconds).
8. Once you have completed the cloning process, turn the radios OFF and ON to exit 'clone' mode.
3. Ensure that the battery is engaged properly on to the radio.
4. Ensure that there is no debris in the charging tray or on the radio contacts.
5. Ensure that the Target radio is turned ON.
6. Ensure that the Source radio is in cloning mode.
7. Ensure that radios are both from the same frequency band, same region and same transmission power.

What To Do if Cloning Fails

The radio will emit "Fail" indicating that the cloning process has failed. In the event that cloning fails, try performing each of the following before trying to start the cloning process again:

1. Ensure that the batteries on both radios are fully charged.
2. Check the cloning cable connection on both SUCs.

Note: This cloning cable is designed to operate only with compatible Motorola SUC RLN6175 and PMLN6394A

When ordering Cloning Cable please refer to P/N HKKN4028A. For details about accessories refer to Accessories section.

Cloning using the CPS (Computer Programming Software)

When cloning using this method, you will need to have the CPS software, a Drop-in Tray Charger and the CPS Programming Cable.

To order the CPS Programming Cable, please refer to HKKN4028A

Information on how to clone using the CPS is available either in:

- the CPS Help File --> Content and Index --> Cloning Radios, or
- in the CPS Programming Cable Accessory Leaflet.

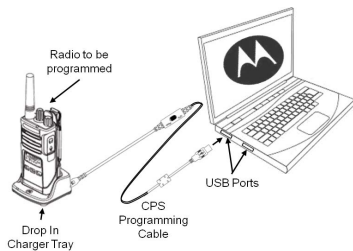

TROUBLESHOOTING

<i>Symptom</i>	<i>Try This...</i>
No Power	<p>or replace the Li-Ion battery.</p> <p>Extreme operating temperatures may affect battery life.</p> <p>Refer to See “About the Li-Ion Battery” on page 14.</p>
Hearing other noises or conversation on a channel	<p>Confirm Interference Eliminator Code is set.</p> <p>Frequency or Interference Eliminator Code may be in use.</p> <p>Change settings: either change frequencies or codes on all radios.</p> <p>Make sure radio is at the right frequency and code when transmitting.</p> <p>Refer to “Talking and Monitoring” on page 27</p>
Message Scrambled	<p>Scramble Code might be ON, and/or setting does not match the other radios' settings.</p>
Audio quality not good enough	<p>Radio settings might not be matching up correctly. Double check frequencies, codes and bandwidths to make sure they are identical in all radios</p>

Symptom

Limited talk range	<p>Steel and/or concrete structures, heavy foliage, buildings or vehicles decrease range. Check for clear line of sight to improve transmission.</p> <p>Wearing radio close to body such as in a pocket or on a belt decreases range. Change location of radio. To increase range and coverage, you can reduce obstructions, increase power. UHF radios provides greater coverage in industrial and commercial buildings. Increasing power provides greater signal range and increased penetration through obstructions.</p> <p>Refer to See “Talking and Monitoring” on page 27.</p>
Message not transmitted or received	<p>Make sure the PTT button is completely pressed when transmitting.</p> <p>Confirm that the radios have the same Channel, Frequency, Interference Eliminator Code and Scramble Code settings. Refer to “Talking and Monitoring” section on page 27 for further information.</p> <p>Recharge, replace and/or reposition batteries. Refer to “About your Li-Ion Battery” section on page 14.</p> <p>Obstructions and operating indoors, or in vehicles, may interfere. Change location. Refer to “Talking and Monitoring” Section on page 27.</p> <p>Verify that the radio is not in Scan. Refer to “Scan” on page 44 and “Nuisance Channel Delete” on page 45.</p>

<i>Symptom</i>	<i>Try This...</i>
Heavy static or interference	Radios are too close; they must be at least five feet apart. Radios are too far apart or obstacles are interfering with transmission. Refer to “Talking and Monitoring” on page 27.
Low batteries	Recharge or replace Li-Ion battery. Extreme operating temperatures affect battery life. Refer to “About the Li-Ion Battery” on page 14.
Drop-in Charger LED light does not blink	Check that the radio/battery is properly inserted and check the battery/charger contacts to ensure that they are clean and charging pin is inserted correctly. Refer to “Charging the Battery” section on page 21, “Drop-in Tray Charger LED Indicators” section on page 24 and “Installing the Lithium-Ion Battery” section on page 16.
Low battery indicator is blinking although new batteries are inserted	Refer to “Installing the Li-Ion Battery” section on page 16 and “About your Li-Ion Battery” section on page 14.

<i>Symptom</i>	<i>Try This...</i>
Cannot activate VOX	<p>VOX feature might be set to OFF.</p> <p>Use the CPS to ensure that the VOX Sensitivity level is not set to '0'.</p> <p>Accessory not working or not compatible.</p> <p>Refer to "Hands-Free Use/VOX" section on page 31.</p>
Battery does not charge although it has been placed in the drop-in charger for a while	<p>Check drop-in tray charger is properly connected and correspond to a compatible power supply.</p> <p>Ensure that you have the drop-in tray charger adjustable piece placed on the right position.</p> <p>Refer to "Charging with the Drop-In Tray Single Unit Charger" section on page 21 and "Charging a Standalone Battery" section on page 22.</p> <p>Check the charger's LEDs indicators to see if the battery has a problem. Refer to "Drop-in Tray Charger LED Indicators" section on page 24.</p>

Note: Whenever a feature in the radio seems to not correspond to the default or preprogrammed values, check to see if the radio has been programmed using the CPS with a customized profile.

USE AND CARE



Use a soft damp cloth
to clean the exterior



Do not immerse
in water



Do not use alcohol or
cleaning solutions

If the radio is submerged in water...



Turn radio OFF and
remove batteries

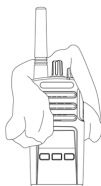

Dry with soft cloth



Do not use radio until
completely dry

FREQUENCY AND CODE CHARTS

RMU2043 - UHF DEFAULT FREQUENCIES CHART

RM UHF 4CH Radios Default Frequencies - RMU2043

Channel	Frequency #	Frequency (MHz)	Code #	Code	Bandwidth
1	1	458.6625	1	67.0 Hz	12.5 kHz
2	2	469.2625	1	67.0 Hz	12.5 kHz

RMU2040 - UHF DEFAULT FREQUENCIES CHART

RM UHF 4 CH Radios Default Frequencies - RMU2040

4 CH -RADIO UHF Defaults				
Chan	Freq #	Frequency	Code	Bandwidth
1	2	464.55	67.0 Hz	12.5kHz
2	8	467.925	67.0 Hz	12.5kHz
3				
4				

RMM2050 - MURS DEFAULT FREQUENCIES CHART

MURS 5CH RMM2050 - BRUS							
Channel	Frequency #	Frequency (MHz)	Code #	Code Value	Channel Name / Alias	Bandwidth	Bandwidth Selectable
1	1	154.5700	1	67.0 Hz	Channel 1	20.0 kHz	N
2	2	154.6000	1	67.0 Hz	Channel 2	20.0 kHz	N
3	3	151.8200	1	67.0 Hz	Channel 3	11.25 kHz	N
4	4	151.8800	1	67.0 Hz	Channel 4	11.25 kHz	N
5	5	151.9400	1	67.0 Hz	Channel 5	11.25 kHz	N

Especial Features Requirements

- Non repeater capable
- Non-Bandwidth selectable (the FCC defines the specific bandwidth requirement for each of the MURS frequencies)
- No power select feature
- No direct frequency input (does not support programming of part 90 frequencies)
- No standard frequency pull down MENU (should only have the 5 MURS frequencies)

Cloning should follow standard BL Solomons platform rules: no cloning between radios of different channel distribution (ie.CP110 and RDX) or models from different regions.

CTCSS AND PL/DPL CODES

CTCSS Codes

CTCSS	Hz		CTCSS	Hz		CTCSS	Hz
1	67.0		14	107.2		27	167.9
2	71.9		15	110.9		28	173.8
3	74.4		16	114.8		29	179.9
4	77.0		17	118.8		30	186.2
5	79.7		18	123		31	192.8
6	82.5		19	127.3		32	203.5
7	85.4		20	131.8		33	210.7
8	88.5		21	136.5		34	218.1
9	91.5		22	141.3		35	225.7
10	94.8		23	146.2		36	233.6
11	97.4		24	151.4		37	241.8
12	100.0		25	156.7		38	250.3
13	103.5		26	162.2		122 (*)	69.3

Note: (*) New CTCSS code.

PL/DPL Codes

DPL	Code		DPL	Code		DPL	Code
39	23		55	116		71	243
40	25		56	125		72	244
41	26		57	131		73	245
42	31		58	132		74	251
43	32		59	134		75	261
44	43		60	143		76	263
45	47		61	152		77	265
46	51		62	155		78	271
47	54		63	156		79	306
48	65		64	162		80	311
49	71		65	165		81	315
50	72		66	172		82	331
51	73		67	174		83	343
52	74		68	205		84	346
53	114		69	223		85	351
54	115		70	226		86	364

PL/DPL Codes (Continued)

DPL	Code		DPL	Code		DPL	Code
87	365		104	565		121	754
88	371		105	606		123	645
89	411		106	612		124	Customized PL
90	412		107	624		125	Customized PL
91	413		108	627		126	Customized PL
92	423		109	631		127	Customized PL
93	431		110	632		128	Customized PL
94	432		111	654		129	Customized PL
95	445		112	662		130	Inverted DPL 39
96	464		113	664		131	Inverted DPL 40
97	465		114	703		132	Inverted DPL 41
98	466		115	712		133	Inverted DPL 42
99	503		116	723		134	Inverted DPL 43
100	506		117	731		135	Inverted DPL 44
101	516		118	732		136	Inverted DPL 45
102	532		119	734		137	Inverted DPL 46
103	546		120	743		138	Inverted DPL 47

PL/DPL Codes (Continued)

DPL	Code		DPL	Code		DPL	Code
139	Inverted DPL 48		156	Inverted DPL 65		173	Inverted DPL 82
140	Inverted DPL 49		157	Inverted DPL 66		174	Inverted DPL 83
141	Inverted DPL 50		158	Inverted DPL 67		175	Inverted DPL 84
142	Inverted DPL 51		159	Inverted DPL 68		176	Inverted DPL 85
143	Inverted DPL 52		160	Inverted DPL 69		177	Inverted DPL 86
144	Inverted DPL 53		161	Inverted DPL 70		178	Inverted DPL 87
145	Inverted DPL 54		162	Inverted DPL 71		179	Inverted DPL 88
146	Inverted DPL 55		163	Inverted DPL 72		180	Inverted DPL 89
147	Inverted DPL 56		164	Inverted DPL 73		181	Inverted DPL 90
148	Inverted DPL 57		165	Inverted DPL 74		182	Inverted DPL 91
149	Inverted DPL 58		166	Inverted DPL 75		183	Inverted DPL 92
150	Inverted DPL 59		167	Inverted DPL 76		184	Inverted DPL 93
151	Inverted DPL 60		168	Inverted DPL 77		185	Inverted DPL 94
152	Inverted DPL 61		169	Inverted DPL 78		186	Inverted DPL 95
153	Inverted DPL 62		170	Inverted DPL 79		187	Inverted DPL 96
154	Inverted DPL 63		171	Inverted DPL 80		188	Inverted DPL 97
155	Inverted DPL 64		172	Inverted DPL 81		189	Inverted DPL 98

PL/DPL Codes (Continued)

DPL	Code		DPL	Code		DPL	Code
190	Inverted DPL 99		200	Inverted DPL 109		210	Inverted DPL 119
191	Inverted DPL 100		201	Inverted DPL 110		211	Inverted DPL 120
192	Inverted DPL 101		202	Inverted DPL 111		212	Inverted DPL 121
193	Inverted DPL 102		203	Inverted DPL 112		213	Inverted DPL 123
194	Inverted DPL 103		204	Inverted DPL 113		214	Customized DPL
195	Inverted DPL 104		205	Inverted DPL 114		215	Customized DPL
196	Inverted DPL 105		206	Inverted DPL 115		216	Customized DPL
197	Inverted DPL 106		207	Inverted DPL 116		217	Customized DPL
198	Inverted DPL 107		208	Inverted DPL 117		218	Customized DPL
199	Inverted DPL 108		209	Inverted DPL 118		219	Customized DPL

MOTOROLA LIMITED WARRANTY FOR THE UNITED STATES AND CANADA

What Does this Warranty Cover?

Subject to the exclusions contained below, Motorola, Inc. warrants its telephones, pagers, and consumer and business two-way radios (excluding commercial, government or industrial radios) that operate via Family Radio Service or General Mobile Radio Service, Motorola-branded or certified accessories sold for use with these Products (“Accessories”) and Motorola software contained on CD-ROMs or other tangible media and sold for use with these Products (“Software”) to be free from defects in materials and workmanship under normal consumer usage for the period(s) outlined below.

This limited warranty is a consumer’s exclusive remedy, and applies as follows to new Motorola Products, Accessories and Software purchased by consumers in the United States, which are accompanied by this written warranty.

Products and Accessories

Products Covered	Length of Coverage
Products and Accessories as defined above, unless otherwise provided for below.	One (1) year from the date of purchase by the first consumer purchaser of the product unless otherwise provided for below.
Decorative Accessories and Cases. Decorative covers, bezels, PhoneWrap™ covers and cases.	Limited lifetime warranty for the lifetime of ownership by the first consumer purchaser of the product.
Business Two-way Radio Accessories	One (1) year from the date of purchase by the first consumer purchaser of the product.
Products and Accessories that are Repaired or Replaced.	The balance of the original warranty or for ninety (90) days from the date returned to the consumer, whichever is longer.

Exclusions

Normal Wear and Tear. Periodic maintenance, repair and replacement of parts due to normal wear and tear are excluded from coverage.

Batteries. Only batteries whose fully charged capacity falls below 80% of their rated capacity and batteries that leak are covered by this limited warranty.

Abuse & Misuse. Defects or damage that result from: (a) improper operation, storage, misuse or abuse, accident or neglect, such as physical damage (cracks, scratches, etc.) to the surface of the product resulting from misuse; (b) contact with liquid, water, rain, extreme humidity or heavy perspiration, sand, dirt or the like, extreme heat, or food; (c) use of the Products or Accessories for commercial purposes or subjecting the Product or Accessory to abnormal usage or conditions; or (d) other acts which are not the fault of Motorola, are excluded from coverage.

Use of Non-Motorola Products and

Accessories. Defects or damage that result from the use of Non-Motorola branded or certified Products, Accessories, Software or other peripheral equipment are excluded from coverage.

Unauthorized Service or Modification. Defects or damages resulting from service, testing, adjustment, installation, maintenance, alteration, or modification in any way by someone other than Motorola, or its authorized service centers, are excluded from coverage.

Altered Products. Products or Accessories with (a) serial numbers or date tags that have been removed, altered or obliterated; (b) broken seals or that show evidence of tampering; (c) mismatched board serial numbers; or (d) nonconforming or non-Motorola housings, or parts, are excluded from coverage.

Communication Services. Defects, damages, or the failure of Products, Accessories or Software due to any communication service or signal you may subscribe to or use with the Products Accessories or Software is excluded from coverage.

Software

Products Covered	Length of Coverage
Software. Applies only to physical defects in the media that embodies the copy of the software (e.g. CD-ROM, or floppy disk).	Ninety (90) days from the date of purchase.

Exclusions

Software Embodied in Physical Media. No warranty is made that the software will meet your requirements or will work in combination with any hardware or software applications provided by third parties, that the operation of the software products will be uninterrupted or error free, or that all defects in the software products will be corrected.

Software NOT Embodied in Physical Media.

Software that is not embodied in physical media (e.g. software that is downloaded from the internet), is provided “as is” and without warranty.

WHO IS COVERED?

This warranty extends only to the first consumer purchaser, and is not transferable.

HOW TO OBTAIN WARRANTY SERVICE OR OTHER INFORMATION?

Contact your Motorola point of purchase.

SOFTWARE COPYRIGHT NOTICE

The Motorola products described in this manual may include copyrighted Motorola and third party software stored in semiconductor memories or other media. Laws in the United States and other countries preserve for Motorola and third party software providers certain exclusive rights for copyrighted software, such as the exclusive rights to distribute or reproduce the copyrighted software. Accordingly, any copyrighted software contained in the Motorola products may not be modified, reverse-engineered, distributed, or reproduced in any manner to the extent allowed by law.

Furthermore, the purchase of the Motorola products shall not be deemed to grant either directly or by implication, estoppel, or otherwise, any license under the copyrights, patents, or patent applications of Motorola or any third party software provider, except for the normal, non-exclusive, royalty-free license to use that arises by operation of law in the sale of a product.

PATENT NOTICE

This product is covered by one or more of the following United States patents.

5896277 5894292 5864752 5699006 5742484
D408396 D399821 D387758 D389158 5894592
5893027 5789098 5734975 5861850 D395882
D383745 D389827 D389139 5929825 5926514
5953640 6071640 D413022 D416252 D416893
D433001

EXPORT LAW ASSURANCES

This product is controlled under the export regulations of the United States of America. The Governments of the United States of America may restrict the exportation or re-exportation of this product to certain destinations. For further information contact the U.S. Department of Commerce.

ACCESSORIES

AUDIO ACCESSORIES

Part No.	Description
53815	Headset w/Boom Mic BR
HMN9026ER	Remote Speaker Mic BR
HKLN4477	Surveillance Earpiece BR

Part No.	Description
53865	Headset w/Swivel Boom Mic
53866	Earbud w/Clip PTT Mic BR
56517	Earpiece w/Inline Mic
RLN6423	Swivel Earpiece BR

BATTERY

Part No.	Description
PMNN4434AR	Standard Li-Ion Battery

CABLES

Part No.	Description
HKKN4028A	Radio to Radio Cloning Cable
HKKN4027A	CPS Programming Cable

CHARGERS

Part No.	Description
PMLN6394A	Standard Charging Solution
PMLN6392A	Rapid Charging Solution

Carrying

Part No.	Description
HKLN4510A	RM Swivel Holster



MOTOROLA, MOTO, MOTOROLA SOLUTIONS and the Stylized M Logo are trademarks or registered trademarks of Motorola Trademark Holdings, LLC and are used under license. All other trademarks are the property of their respective owners. ©2013 Motorola, Inc. All rights reserved. Printed in Malaysia.

Motorola Solutions, Inc. 1301 East Algonquin Road Schaumburg, Illinois 60196,
U.S.A. 800-367-2346 motorolasolutions.com



68012009071