

User's Guide



**MOTOROLA**  
**XTN** SERIES  
TWO-WAY RADIO



6864110R04-O

Models XU1100, XU2100, and XU2600  
Models XV1100, XV2100, and XV2600

010449-O



6881038B80.book Page 2 Thursday, August 30, 2001 5:33 PM

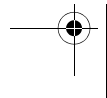
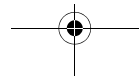
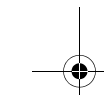
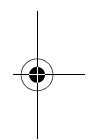
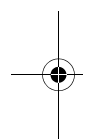
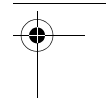
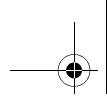
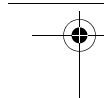

## **Safety and General Information**

### **Important Information on Safe and Efficient Operation Read This Information Before Using Your Radio**

The information provided in this document supersedes the general safety information contained in user guides published prior to July 2000. For information regarding radio use in a hazardous atmosphere please refer to the Factory Mutual (FM) Approval Manual Supplement or Instruction Card, which is included with radio models that offer this capability.

#### **RF Operational Characteristics**

Your radio contains a transmitter and a receiver. When it is ON, it receives and transmits radio frequency (RF) energy. The XTN Series VHF radios operate in the frequency range of 151-161 MHz, the XTN Series UHF radios operate in the frequency range of 461-469 MHz. When you communicate with XU1100 or XV1100 radios the output power level is 1.0 watt, with other XTN Series radios, the output power level is 2.0 watts

#### **Exposure to Radio Frequency Energy**

Your Motorola radio is designed to comply with the following national and international standards and guidelines regarding exposure of human beings to radio frequency electromagnetic energy:

- United States Federal Communications Commission, Code of Federal Regulations; 47 CFR part 2 sub-part J
- American National Standards Institute (ANSI) / Institute of Electrical and Electronic Engineers (IEEE) C95. 1-1992
- Institute of Electrical and Electronic Engineers (IEEE) C95.1-1999 Edition

- National Council on Radiation Protection and Measurements (NCRP) of the United States, Report 86, 1986
- International Commission on Non-Ionizing Radiation Protection (ICNIRP) 1998
- Ministry of Health (Canada) Safety Code 6. Limits of Human Exposure to Radio Frequency Electromagnetic Fields in the Frequency Range from 3 kHz to 300 GHz, 1999
- Australian Communications Authority Radiocommunications (Electromagnetic Radiation - Human Exposure) Standard 1999 (applicable to wireless phones only)

To assure optimal radio performance and make sure human exposure to radio frequency electromagnetic energy is within the guidelines set forth in the above standards, always adhere to the following procedures:

#### **Portable Radio Operation and EME Exposure**

##### ***Antenna Care***

**Use only the supplied or an approved replacement antenna.** Unauthorized antennas, modifications, or attachments could damage the radio and may violate FCC regulations.

**DO NOT hold the antenna when the radio is "IN USE."** Holding the antenna affects the effective range.

##### **Two-Way Radio Operation**

When using your radio as a traditional two-way radio, **hold the radio in** a vertical position with the microphone two to three inches (5.0 to 7.5 cm) away from the lips.

### Body-Worn Operation

To maintain compliance with FCC/Health Canada RF exposure guidelines, if you wear a radio on your body when transmitting, always place the radio in a **Motorola supplied or approved clip, holder, holster, case, or body harness for this product**. Use of non-Motorola-approved accessories may exceed FCC RF exposure guidelines. **If you do not use a body-worn accessory, ensure the radio and its antenna is at least one inch (2.5 cm) from your body when transmitting.**

### Data Operation

When using any data feature of a device, with or without an accessory cable, position the device and its antenna at least one inch (2.5 cm) from the body.

### Approved Accessories

For a list of approved Motorola accessories refer to the Two-Way Radio section of [www.motorola.com/store](http://www.motorola.com/store).

### Electromagnetic Interference/Compatibility

**Note:** Nearly every electronic device is susceptible to electromagnetic interference (EMI) if inadequately shielded, designed or otherwise configured for electromagnetic compatibility.

### Facilities

To avoid electromagnetic interference and/or compatibility conflicts, turn off your radio in any facility where posted notices instruct you to do so. Hospitals or health care facilities may be using equipment that is sensitive to external RF energy.

### Aircraft

When instructed to do so, turn off your radio when on board an aircraft. Any use of a radio must be in accordance with applicable regulations per airline crew instructions.

## **Medical Devices**

### ***Pacemakers***

The Advanced Medical Technology Association recommends that a minimum separation of 6 inches (15 centimeters) be maintained between a handheld wireless radio and a pacemaker. These recommendations are consistent with the independent research by, and recommendations of the U.S. Food and Drug Administration.

Persons with pacemakers should:

- ALWAYS keep the radio more than six inches (15 centimeters) from their pacemaker when the radio is turned ON.
- not carry the radio in the breast pocket.
- use the ear opposite the pacemaker to minimize the potential for interference.
- turn the radio OFF immediately if you have any reason to suspect that interference is taking place.

### ***Hearing Aids***

Some wireless radios may interfere with some hearing aids. In the event of such interference, you may want to consult your hearing aid manufacturer to discuss alternatives.

### ***Other Medical Devices***

If you use any other personal medical device, consult the manufacturer of your device to determine if it is adequately shielded from RF energy. Your physician may be able to assist you in obtaining this information.

### **Safety and General Use While Driving**

Check the laws and regulations on the use of radios in the area where you drive. Always obey them. When using your radio while driving, please:

- Give full attention to driving and to the road.
- Use hands-free operation, if available.
- Pull off the road and park before making or answering a call if driving conditions so require.

### **Operational Warnings**

#### ***For Vehicles with an Air Bag***

Do not place a portable radio in the area over an air bag or in the air bag deployment area. Air bags inflate with great force. If a portable radio is placed in the air bag deployment area and the air bag inflates, the radio may be propelled with great force and cause serious injury to occupants of the vehicle.

#### ***Potentially Explosive Atmospheres***

Turn off your radio prior to entering any area with a potentially explosive atmosphere, unless it is a radio type especially qualified for use in such areas as "Intrinsically Safe."

Do not remove, install, or charge batteries in such areas. Sparks in a potentially explosive atmosphere can cause an explosion or fire resulting in bodily injury or even death.

**Note:** The areas with potentially explosive atmospheres referred to above include fueling areas such as below decks on boats, fuel or chemical transfer or storage facilities, areas where the air contains chemicals or particles, such as grain, dust or metal powders, and any other area where you would normally be advised to turn off your vehicle engine. Areas with potentially explosive atmospheres are often but not always posted.

### ***Blasting Caps and Areas***

To avoid possible interference with blasting operations, turn off your radio when you are near electrical blasting caps, in a blasting area, or in areas posted: "Turn off two-way radio." Obey all signs and instructions.

### **Operational Cautions**

#### ***Antennas***

**Do not use any portable radio that has a damaged antenna.** If a damaged antenna comes into contact with your skin, a minor burn can result.

#### ***Batteries***

All batteries can cause property damage and/or bodily injury such as burns if a conductive material such as jewelry, keys, or beaded chains touch exposed terminals. The conductive material may complete an electrical circuit (short circuit) and become quite hot. Exercise care in handling any charged battery, particularly when placing it inside a pocket, purse, or other container with metal objects.

#### ***Charging Safety Instructions***

Before using the battery charger, read all instructions and cautionary markings on:

1. the battery
2. the battery charger, and
3. the radio using the battery.

**Caution:** To reduce the risk of injury, charge only the rechargeable battery. Other types of batteries may burst, causing personal injury and damage.



**Save these Instructions**

1. Do not expose the charger to rain or snow.
2. Do not operate the charger if it has received a sharp blow, or has been dropped or damaged in any way.
3. Do not disassemble the charger if it has received a sharp blow, or has been dropped or damaged in any way.
4. Never alter the AC cord or plug provided with the unit. If plug will not fit the outlet, have proper outlet installed by a qualified electrician. An improper condition can result in a risk of electric shock.
5. To reduce risk of damage to cord or plug, pull the plug rather than the cord when disconnecting charger from AC receptacle.
6. To reduce the risk of electric shock, unplug the charger from the outlet before attempting any maintenance or cleaning.
7. Use of an attachment not recommended or sold by Motorola may result in a risk of fire, electric shock, or personal injury.
8. Make sure that the cord is located so that it will not be stepped on, tripped over, or subjected to damage or stress.

PRELIMINARY

Safety and General Information

vii

PRELIMINARY

9. An extension cord should not be used unless absolutely necessary. Use of an improper extension cord could result in a risk of fire and/or electric shock. If an extension cord must be used, make sure:
  - That the pins on the plug of the extension cord are the same number, size and shape as those on the plug of the charger.
  - That the extension cord is properly wired and in good electrical condition, and
  - That the cord size is 18 AWG for lengths up to 100 feet, and 16 AWG for lengths up to 150 feet.
10. The supply cord of this charger cannot be replaced. If the cord is damaged, call Motorola Product Services at:

**1-800-353-2729 (U.S.A.)**

**1-800-461-4575 (Canada)**

**1-888-390-6456 TTY (Text Telephone)**

**1-888-390-6456 TTY (Text Telephone)**

## Introduction

Thank you for purchasing a Motorola® XTN Series Radio. Your radio is a product of Motorola's 70 plus years of experience as a world leader in the designing and manufacturing of communications equipment. The revised industrial design reflects the heritage and ruggedness of the XTN Series. The XTN Series radios provide cost-effective communications for businesses such as retail stores, restaurants, schools, construction sites and more. Motorola professional two-way radios are the perfect communications solution for all of today's fast-paced industries.

**Note:** Please read this manual carefully to ensure you know how to properly operate the radio before use.

**Motorola**  
**Consumer Products Division**  
**1705 Belle Meade Court**  
**Lawrenceville, GA 30043**

## Package Contents

- Radio
- Swivel Belt Holster
- NiMH Battery NTN8971
- 10-Hour Charger NNTN4021
- User's Guide
- Accessory Brochure
- Warranty Card

Motorola, the Stylized M Logo, and all other trademarks indicated as such herein are Trademarks of Motorola, Inc.

®Reg. U.S. Pat. & Tm. Off.  
© 2001 Motorola, Inc. All rights reserved.  
Printed in the U.S.A. 08/01

For a copy of a large-print version of this guide, or for product-related questions, please contact:

**1-800-353-2729 U.S.A.**  
**1-800-461-4575 Canada**  
**1-888-390-6456 TTY (Text Telephone)**

On the web, please refer to:  
[www.motorola.com/radios/professional](http://www.motorola.com/radios/professional)

**Introduction**

## Contents

<b>Getting Started</b> .....	<b>3</b>
Turning On/Off Your Radio .....	3
Installing Batteries .....	4
Charging .....	7
<b>Programming Mode</b> .....	<b>9</b>
Setting the	
Channel .....	10
Frequency .....	10
Interference Eliminator Code .....	11
Eavesdrop Reducer .....	11
Bandwidth .....	12
Manager Lockout .....	12
Assigning Channels to Presets .....	12
Cloning .....	13
Resetting Factory Defaults .....	13
<b>Settings and Functions Display</b> .....	<b>14</b>
<b>Operating Radio</b> .....	<b>15</b>
Signal Strength Indicator .....	15
Monitor Signal Strength Indicator .....	15

<b>User Menu Features</b> .....	<b>16</b>
Setting Call Tone .....	16
Setting Microphone Gain .....	16
Hands-Free Use/VOX .....	17
Setting Preferences for Scanning .....	19
Setting the Battery Type* .....	20
End-of-Transmission Tone .....	20
Keypad Tones .....	21
<b>Use and Care</b> .....	<b>22</b>
<b>Frequency and Code Charts</b> .....	<b>23</b>
VHF Frequency Chart .....	23
UHF Frequency Chart .....	24
Interference Eliminator Codes .....	25
Digital Private Line/DPL Codes .....	26
<b>Troubleshooting</b> .....	<b>27</b>
<b>Motorola Limited Warranty</b> .....	<b>30</b>

Contents

PREMIUM

## FCC Licensing Information

XTN Series professional two-way radios operate on radio frequencies that are regulated by the Federal Communications Commission (FCC). In order to transmit on these frequencies, you are required to have a license issued by the FCC. Application is made on FCC Form 601 and Schedules D, E and G.

To have the FCC forms please request document **000601** which includes all forms and instructions. If you wish to have the document faxed, mailed or have questions, please use the following contact information.

Faxed contact the Fax-On- Demand system at:	Mailed call the FCC forms hotline at:	Questions regarding FCC license contact the FCC at:
1-202-418-0177	1-800-418-FORM 1-800-418-3676	1-888-CALL-FCC 1-888-225-5322 Or: <a href="http://www.fcc.gov">http://www.fcc.gov</a>

Before filling out your application, you must decide which frequency(ies) you can operate on. See the Frequency and Code Charts on page 23.

For questions on determining your radio frequency, please call Motorola Product Services at:

**1-800-448-6686**

FCC

FCC Licensing Information

FCC

FCC Licensing Information

N





PRELIMINARY

Changes or modifications not expressly approved by Motorola may void the user's authority granted by the FCC to operate this radio and should not be made. To comply with FCC requirements, transmitter adjustments should be made only by or under the supervision of a person certified as technically qualified to perform transmitter maintenance and repairs in the private land mobile and fixed services as certified by an organization representative of the user of those services. Replacement of any transmitter component (crystal, semiconductor, etc.) not authorized by the FCC equipment authorization for this radio could violate FCC rules.

**Note:** Use of this radio outside the country where it was intended to be distributed is subject to government regulations and may be prohibited.

## Getting Started

### Turning On/Off Your Radio

Turn knob	Display	Normal Menu Mode
		Turn knob on the top of the radio clockwise to turn the radio On. Turn the Knob counterclockwise to turn the radio Off. The radio chirps and the display will briefly show all features and display segments of your radio.
		Then, the code area will briefly display the current Channel (larger number located in the center of the display) and the Frequency assigned to that Channel.
		The Interference Eliminator Code shows briefly. Current Channel will be left on display.

A Diagram of your New XTN Series Radio and its Functions can be found on page 8.

#### **Volume**

You can set the volume by adjusting the knob on the top of the radio; .

**Note:** Do not hold the radio too close to your ear when the volume is at a high setting.

Getting Started

**XTN**

3

## Installing Batteries

### The Nickel-Metal Hydride Battery

- Push the Ribbed Latch on the bottom of the radio away from the battery door, or toward the contacts.
- Slide and lift the battery door off.
- Place the battery so that the charge contacts are facing out toward the battery door. Insert the top of the battery into the radio and push the battery up and into the battery compartment. The battery fits tightly into place.
- Slide and snap the battery door into place.

**Note:** \*Based upon 5/5/90 duty cycle.

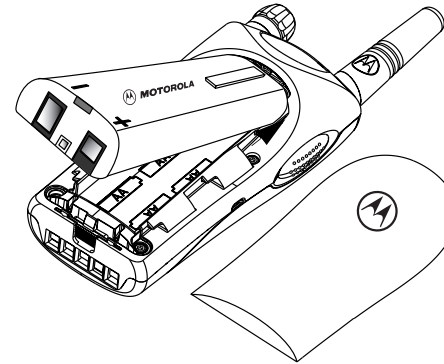
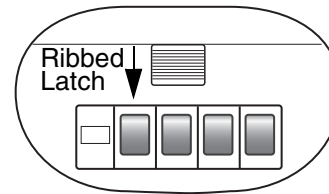



### **AA Alkaline Batteries**

Your radio can also use 4 AA batteries; alkaline cells provide 24 hours\* of radio use.

- Push the ribbed latch on the bottom of the radio away from the battery door.
- Slide and lift the battery door off.
- Place AA batteries matching the markings in the compartment.
- Slide and snap the battery door into place.

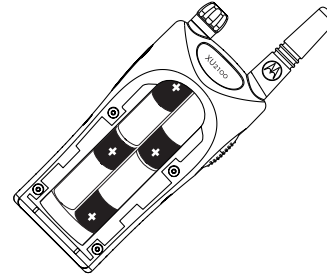

### **Battery Meter**

The battery meter located in the upper left hand corner of the display indicates how much battery power you have remaining.

Full	Two-thirds Full	One-third Full	Battery Meter flashes when almost empty.

When the battery meter Flashes; , the radio chirps after releasing (P/T) and every 10 minutes.

**Note:** \*Based upon 5/5/90 duty cycle.

Getting Started

XTN

5

## Diagram of your New XTN Series Radio and its Functions

Getting Started

XTN

6

PRELIMINARY

**Indicator Light:**

Use  to:  
Transmit call tone

Use  to:  
Talk  
Exit a menu

Use  button to:  
Scroll through menus  
Lock the keypad

Use  /  buttons to:  
Access Presets  
(XU2600, XV2600)

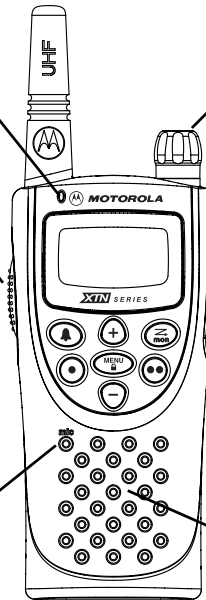

**Microphone:**



Use  (Power) to:  
Turn power On/Off  
Adjust radio volume

**Accessory Jack**  
Audio Accessories  
Radio Plug-in Charging

Use  button to:  
Turn Scan On/Off  
(XU2600, XV2600)  
Monitor the Frequency

Use  and  to:  
Change Channels  
(XU2600, XV2600)  
Scroll through  
menu settings

**Speaker:**

## Charging

### *The NiMH Battery with 10-Hour Charger*

- Make sure the radio is Off.
- Lift Accessory Cover and plug the 10-Hour Charger (NNTN4021) firmly into the lower jack (small hole). Please see figure.
- Plug the charger into an electric outlet.

The light on the charger will glow red if charging properly.

**Note:** Charge the battery (NTN8971) overnight (16 hours) before using it for the first time, it will only need up to ten hours of charging thereafter.

For optimum battery life, the battery must not be left charging for prolonged periods after reaching full charge. Charging the battery over the weekend is acceptable.

If radio is On while charging, additional time is required to charge the battery.

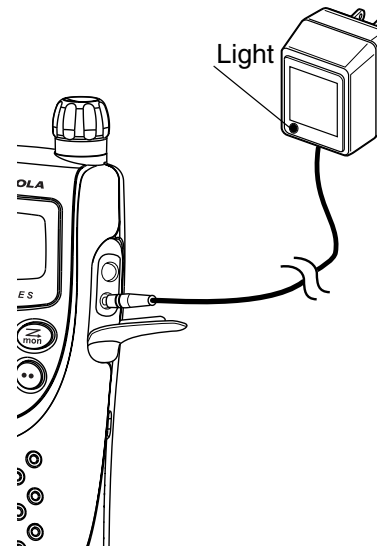

Getting Started

XTN

7

**With Drop-in Charging Tray ( Not included with all models)**

The Drop-in Charging Tray can be placed on any flat surface and provides drop-in charging convenience.

- Connect 10-Hour Charger (NNTN4021) and Drop-in Charging Tray\* (NNTN4019) by inserting plug into the rear of Drop-in Charging Tray.
- To charge the radio, place into the Drop-in Charging Tray with the radio facing toward you.

**Note:** The battery can be charged while inside the radio or removed from the radio and placed in Drop-in Charging Tray separately. The battery's contacts must face down and the Motorola Logo must face the front of Charger.

The light on the 10-Hour Charger will glow continuously when radio/battery is inserted.

**Note:** Allow 10 hours for the battery to reach full charge.

\* Accessory Number for Drop-in Charger is 53872.

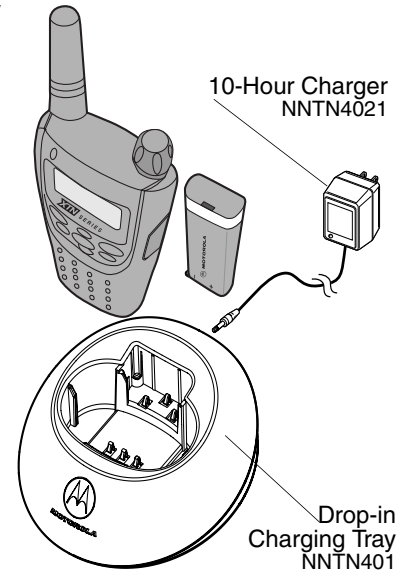



## Programming Mode

To talk with someone on your two-way radios, the following features need to be set exactly alike:

1. **Channel** (Current channel that the radio is using.)
2. **Frequency** (The frequency wave your radio uses to transmit/receive.)
3. **Interference Eliminator Code** (These codes help minimize interference by providing you with a choice of code combinations.) Please refer to the Frequency and Code Charts on page 23.
4. **Eavesdrop Reducer/Scrambling Code** (Codes that make your transmissions sound garbled to anyone listening who is not set to that specific code). Please refer to Setting Eavesdrop Reducer (2 watt models only) can be found on page 11.

**Note:** The **Cloning Feature** used with the **Multi-unit Charger/MUC** (Optional Accessory) can help to duplicate radio settings easily for multiple radio use. Please refer to Cloning on page 13.

Channel Frequency, Interference Eliminator Code, Eavesdrop Reducer/Scrambling Code, and Manager Lock can all be selected in Programming Mode: **PROG**.

- Access **PROG** by turning the radio on while holding the  and  buttons for three seconds.
- The Programming icon; **PROG** illuminates and radio chirps to indicate access.
- Exit **PROG** by holding the  for three seconds.

**Note:** **PROG** does not timeout.





**PROG**

Programming Mode

9

**PROG**



Now, you may use your radio's  and  or  to select features.

Press	Display	Then Press
	the icon representing the feature you want	 or  to select the feature. Press  for three seconds to exit programming mode.

Programming Mode





10

**Setting the Channel (X2600 and XV2600 only)**

- Make sure **PROG** is accessed. Please refer to Programming Mode on page 9.
- The channel number flashes. **FREQ** and Code will display alternately.
- Press  or  until the desired channel is selected.



**Setting the Frequency**



- Press  once, **FREQ** indicator illuminates and the Frequency flashes.
- Press  or  to choose desired Frequency.
- Exit the Programming Mode by holding down .



### Setting the Interference Eliminator Code

The Interference Eliminator Code helps minimize interference by providing you with a choice of code combinations.

Make sure **PROG** is accessed. Please refer to Programming Mode on page 9.

- To set the code, press  until the code number display begins to flash.
- Then press  or  to choose the code.











**Note:** To hear everyone on your frequency, select Interference Eliminator Code .

### Setting Eavesdrop Reducer (2 watt models only)

 Your radio has the Eavesdrop Reducer feature, a scramble code that makes your transmissions sound garbled to anyone listening without the same code. It doesn't guarantee confidentiality, but it adds an extra layer of privacy.

**Note:** All the radios have to be set to the same Eavesdrop Reducer for transmission to be clear.

- Make sure **PROG** is accessed. Please refer to Programming Mode on page 9.
- Press  as needed until  is displayed, then
- Press  or  to choose the scramble code.
- Select code , , or . Factory Default is set at  (Off).

When you exit **PROG**, radio displays .





**PROG**

Programming Mode

11



### **PROG** Setting Bandwidth (when FCC allowable)





Make sure **PROG** is accessed. Please refer to Programming Mode on page 9.

- Change the setting by pushing the  until 'b' displays.
- Press  or  to select setting:  
Bandwidth is only selectable when flashing.  
Either "HI" (high: 25.0 kHz) or "Lo" (low: 12.5 kHz) will display.







### **Setting Manager Lockout**

This feature aids in preventing changing of radio settings. All buttons except  and , will be unaccessible when 'U' is chosen.

- Make sure **PROG** is accessed. Please refer to Programming Mode on page 9.
- To turn lock on, press  until  displays.
- Press  or  to select setting, 'U' or 'n'.
- Once turned on,  icon displays after exiting **PROG**.



### **Assigning Channels to Presets**



- Make sure **PROG** is accessed. Please refer to Programming Mode on page 9.
- Press  or  to choose desired Channel.
- Press and hold  or  to assign a Channel to that preset button, radio beeps to confirm.

**Note:** All of the Channel settings are assigned to that preset button.





### Cloning

The XTN Series radios have cloning capability when connected via the Multi Unit Charger (MUC). Cloning enables rapid fleet reconfiguration because all selectable settings are sent to the target unit. The target radios must be placed behind the source radio, please refer to the MUC instructions included with this accessory.

- Make sure **PROG** is accessed. Please refer to Programming Mode on page 9.
- The source radio enters Cloning Mode through an extended press of . Pressing  again, will clone additional radios.
- Either p for pass or f for fail shall appear on the display.
- Only the source radio needs to be in Clone Mode, and both radios will indicate if cloning was successful.



### Resetting Factory Defaults

All selectable features can be reset to factory defaults by turning the radio on while holding  and  buttons simultaneously for five seconds.

**Note:** The radio cannot be reset if Manager Lockout is enabled.

**PROG**

**Programming Mode**

**13**

## PROG Settings and Functions Display

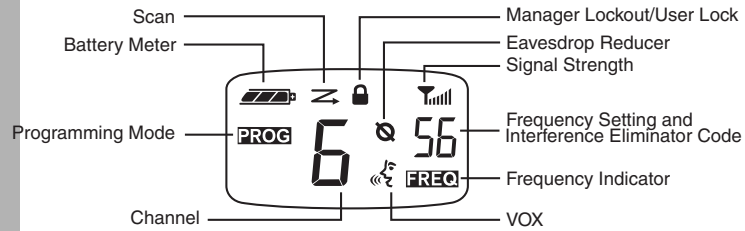

The following table lists the functions you can set by pressing and holding a button while you are turning on your radio.

Key(s) Pressed.	Function
= <b>PROG</b>	Access <b>PROG</b> Programming Mode: Five second delay. You can change the channel here.
	Reset factory settings: Five second delay. Will not work if Manager Lock is enabled.
	Enable  VOX.
	Turns "End-of-Transmission Tone On/Off. Radio default setting is "Off."
	Turns Keypad Tones On/Off. Radio default setting is "On."

## Operating Radio

Check channel activity by pressing monitor button. You will hear static if the channel is clear to use. Do not transmit if someone is speaking on the channel.



- Press and hold  and speak into radio.

**Note:** To maximize clarity hold radio two-to-three inches away from mouth.)

- To listen for messages, release .



**Note:** The transmit light on the front left of the radio flashes every three seconds when radio is On and is steady red when transmitting.

## Signal Strength Indicator

The radio will display  when there is activity on the frequency. When receiving the display will show  and a signal strength of 1 (weakest) through 5 (strongest) . This can help to determine when a radio is moving out of range.



## Monitor Signal Strength Indicator

To check for channel activity, press and hold the  button. You'll hear static if the channel is clear and  will display. Press  to release. To avoid interrupted conversation, wait until the channel is clear or switch to another channel.

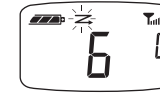





**Note:** Obstacles that block the signal path may affect the strength of the incoming signal.

## User Menu Features

### Setting Call Tone

Your radio can transmit call tones to other radios in your group so you can alert the group that you want to talk to them. There are three distinct individual call tones to choose or you can choose to turn Call Tones off: 0. Once selected, just press  to transmit the Call Tone to others.





- To set your call tone, press  as needed to display .
- You can press  or  to scroll through the available call tones. The radio plays each individual Call tone as you scroll through.



**Note:** The default is set on 0, or you may choose 1, 2, or 3.

### Setting Microphone Gain

Microphone Gain allows compensation for background noise and enhances the ability to pick up quiet voices.

- To set sensitivity level, press  as needed, until  and  are visible.
- Select 1, 2 or 3 by using  or .

-  = High Sensitivity
-  = Medium Sensitivity
-  = Low Sensitivity







### Hands-Free Use/VOX

VOX allows “hands-free” transmission when used with compatible VOX accessories.

- Turn radio Off.
- Open Accessory Cover.
- Insert plug of audio accessory firmly into Accessory Jack.
- Turn radio On and lower volume before placing accessory on head or in ear.
- To transmit, speak into Accessory Microphone and to receive, stop talking.

### Setting VOX Sensitivity Level

The default VOX sensitivity level must be changed for initial use. The  will flash if sensitivity is set to 0.

- Press  as needed to display  and E.
- Select Sensitivity Level of 1, 2, or 3 by using  or .

- 3 = High Sensitivity
- 2 = Medium Sensitivity
- 1 = Low Sensitivity

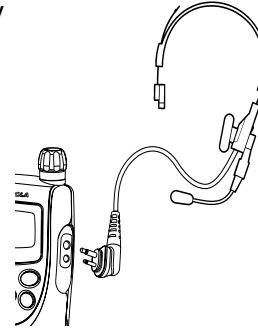

**Note:** To order accessories, please refer to: [www.motorola.com/radios/professional](http://www.motorola.com/radios/professional).

- VOX operation can be disabled by pressing (P/T).
- A short press (P/T) of will enable VOX.

XU2600 and XV2600 radios are capable of hands-free use without accessories.

- Enable VOX by pressing (P/T) while turning the radio On.
- Press (MENU) as needed to display «E» and 1.

**Setting VOX Sensitivity Level**

- Select Sensitivity Level of 1, 2, or 3 by using (-) or (+):
  - 3 = High Sensitivity
  - 2 = Medium Sensitivity
  - 1 = Low Sensitivity

To turn VOX Off, simply turn the radio Off and then On again. The «E» will not be visible. Press (P/T) to turn off VOX and return to normal operation, «E» will flash. A short press of (P/T) will enable VOX.



**Note:** There is a short delay between when you start talking and the radio transmits.





### Setting Preferences for Scanning/Scan List

By using , you can monitor channels and codes for transmissions and lock in on a specific channel.



- To start scanning, briefly press .

Your channel/code screen displays  and begins to scroll through channels. When the radio detects channel activity, it stops on that channel and displays its channel and code. You can talk to the person(s) transmitting without having to switch channels by pressing .



- To stop scanning, briefly press .

If you press  while the radio is scanning, the radio will transmit on the channel which was selected before you activated Scan.

If no transmission occurs within five seconds, scanning will resume.











If you want to scan channels without interference eliminator codes, change the code for your set channel to  before you briefly press .

### ***Nuisance Delete/ Manual Advance While Scanning***

**Note:** While scanning you can quickly delete a channel that the radio has loaded for an indefinite period of time by pressing  once, i.e. shortcut to Scan List Editing. You can also advance to the next channel with activity by manually pressing .





### Editing Scan List





Scan List Setting is changed by pressing the  button three times.

- The flashing channel will appear on the display with a solid  or  in the code section.
- Press  or  button to increase or decrease the channel.
- Pressing the  button toggles between the channel number and Scan List setting.
- The scroll buttons,  or  will change the Scan List to include/ or exclude/ that particular channel.
- Once you have selected your Scan List options, press  to exit.

### Setting the Battery Type\*

This feature allows the battery meter to recognize and properly display the power remaining of single cell batteries.

Press  until  displays. Either  (Alkaline) or  (NiCad, NiMH, Li-Ion rechargeable AA cells) is flashing.

- Press  or  until your choice of  or  displays.

**Note:** \*This menu will not appear if the NiMH Battery is in use.

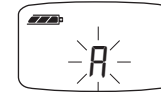

### End-of-Transmission Tone

When you turn this feature On, your two-way radio transmits a tone when you finish transmitting. It's like saying "Roger" or "Over."



- If you don't hear the talk confirmation tone, you can enable it by pressing and holding **(+)** as you turn on your radio.
- To disable the End-of-Transmission Tone feature, turn your radio Off and then back On while pressing and holding **(+)**.

### Keypad Tones

Every time you press a button on your radio, it beeps unless you turn this feature off.

- Turn your radio On while you press and hold **(-)**.
- To turn Keypad Tones back on, turn the radio Off and then back On again while you press and hold **(-)**.

### Talking Range

	Industrial	Multi-Level	Outdoor
<b>Model</b>	Inside steel/concrete industrial buildings	Inside multi-level buildings	Flat ground with no obstructions
<b>UHF 2W</b>	Up to 250, 000 Sq. Ft.	Up to 20 Floors	Up to 6 Miles
<b>UHF 1W</b>	Up to 200, 000 Sq. Ft.	Up to 15 Floors	Up to 5 Miles
<b>VHF 2W</b>	Up to 180, 000 Sq. Ft.	Up to 10 Floors	Up to 6 Miles
<b>VHF 1W</b>	Up to 150,000 Sq. Ft.	Up to 8 Floors	Up to 5 Miles

## Use and Care



Use a soft damp cloth to clean the exterior.

### If the radio gets wet...



Turn radio Off and remove batteries.



Do not immerse in water.



Do not use alcohol or cleaning solutions.



Dry with soft cloth.



Do not use radio until completely dry.

**XTN**

**22**

PRELIMINARY

## Frequency and Code Charts

The charts on these pages provide frequency and code information. These charts are useful when using Motorola XTN Series two-way radios with other business radios.

### VHF Frequency Chart

Position	MHz	Bandwidth
1	151.6250	25.00
2	151.9550	25.00
3	154.5700	25.00
4	154.6000	25.00
5	151.7000	12.5/25.0
6	151.7600	12.5/25.0
7	151.8200*	12.5/25.0
8	151.8800*	12.5/25.0
9	151.9400*	12.5/25.0
10	151.5125	25.00
11	151.6550	25.00
12	151.6850	25.00
13	151.7150	25.00
14	151.7450	25.00
15	151.7750	25.00

Position	MHz	Bandwidth
16	151.8650	25.00
17	151.8950	25.00
18	151.9250	25.00
19	152.7000	25.00
20	154.4900	25.00
21	154.5150	25.00
22	154.5275	25.00
23	154.5400	25.00
24	154.6000	25.00
25	154.6550	25.00
26	158.4000	25.00
27	158.4075	25.00

**Note:** Due to FCC regulations, these frequencies transmit at 1 watt only.

UHF Frequency Chart

Position	MHz	Bandwidth	Position	MHz	Bandwidth
1	464.5000	12.5/25.0	29	462.9125	12.5
2	464.5500	12.5/25.0	30	464.4875	12.5
3	467.7625	12.5	31	464.5125	12.5
4	467.8125	12.5	32	464.5375	12.5
5	467.8500	12.5/25.0	33	464.5625	12.5
6	467.8750	12.5/25.0	34	466.0375	12.5
7	467.9000	12.5/25.0	35	466.0625	12.5
8	467.9250	12.5/25.0	36	466.0875	12.5
9	461.0375	12.5	37	466.1125	12.5
10	461.0625	12.5	38	466.1375	12.5
11	461.0875	12.5	39	466.1625	12.5
12	461.1125	12.5	40	466.1875	12.5
13	461.1375	12.5	41	466.2125	12.5
14	461.1625	12.5	42	466.2375	12.5
15	461.1875	12.5	43	466.2625	12.5
16	461.2125	12.5	44	466.2875	12.5
17	461.2375	12.5	45	466.3125	12.5
18	461.2625	12.5	46	466.3375	12.5
19	461.2875	12.5	47	466.3625	12.5
20	461.3125	12.5	48	467.7875	12.5
21	461.3375	12.5	49	467.8375	12.5
22	461.3625	12.5	50	467.8625	12.5
23	462.7625	12.5	51	467.8875	12.5
24	462.7875	12.5	52	467.9125	12.5
25	462.8125	12.5	53	469.4875	12.5
26	462.8375	12.5	54	469.5125	12.5
27	462.8625	12.5	55	469.5375	12.5
28	462.8875	12.5	56	469.5625	12.5

### Interference Eliminator Codes

This allows you to monitor all activity on the channel you are using. Interference Eliminator codes help minimize interference by providing you with a choice of code combinations.

Code	Hz	Code	Hz	Code	Hz
1	67.0	14	107.2	27	167.9
2	71.9	15	110.9	28	173.8
3	74.4	16	114.8	29	179.9
4	77.0	17	118.8	30	186.2
5	79.7	18	123.0	31	192.8
6	82.5	19	127.3	32	203.5
7	85.4	20	131.8	33	210.7
8	88.5	21	136.5	34	218.1
9	91.5	22	141.3	35	225.7
10	94.8	23	146.2	36	233.6
11	97.4	24	151.4	37	241.8
12	100.0	25	156.7	38	250.3
13	103.5	26	162.2		

Carrier Squelch (0) disables Interference Eliminator Codes.

PRELIMINARY

Frequency and Code Charts

**XTN**

**25**



PRELIMINARY

Digital Private Line/DPL Codes

Position	Code Word	Position	Code Word	Position	Code Word
39	023	67	174	95	445
40	025	68	205	96	464
41	026	69	223	97	465
42	031	70	226	98	466
43	032	71	243	99	503
44	043	72	244	100	506
45	047	73	245	101	516
46	051	74	251	102	532
47	054	75	261	103	546
48	065	76	263	104	565
49	071	77	265	105	606
50	072	78	271	106	612
51	073	79	306	107	624
52	074	80	311	108	627
53	114	81	315	109	631
54	115	82	331	110	632
55	116	83	343	111	654
56	125	84	346	112	662
57	131	85	351	113	664
58	132	86	364	114	703
59	134	87	365	115	712
60	143	88	371	116	723
61	152	89	411	117	731
62	155	90	412	118	732
63	156	91	413	119	734
64	162	92	423	120	743
65	165	93	431	121	754
66	172	94	432		

## Troubleshooting

Symptom	Try This:
No Power	Recharge or replace battery (NTN8971). Reposition or replace AA batteries.
Message not transmitted	Make sure  is completely pressed as you transmit. Replace, recharge and/or reposition batteries.
Hearing other noises or conversation on a channel	Confirm Interference Eliminator Code is set. Frequency or Interference Eliminator Code may be in use, change code on all radios if possible.
Message scrambled	Eavesdrop Reducer is on, and/or setting does not match other radios' settings.
Limited talk range	Steel and/or concrete structures, heavy foliage, buildings or vehicles decrease range. Check for clear line of sight to improve transmission. Wearing radio close to body such as in a pocket or on a belt decreases range. Change location of radio.



**Symptom**

**Try This:**

**Message not received**

Confirm radios have the same channel, frequency, interference eliminator code and \*eavesdrop reducer code settings. (\*XV2600, XU2600)

Make sure  is **NOT** being pressed while trying to listen. Replace, recharge and/or reposition batteries. Obstructions and operating indoors, or in vehicles, may interfere -- change location. Verify that the radio is not in Scan mode.

**Heavy static or interference**

Radios are too close, they must be at least five feet apart. Radios are too far apart or obstacles are interfering with transmission.

**Keypad locked**

Make sure menu is unlocked. Unlock by holding  for three seconds. Make sure Manager Lockout is disabled. Please refer to Setting Manager Lockout on page 12.

**Low batteries**

Recharge or replace NiMH battery. Replace AA batteries. Extreme operating temperatures affect battery life.



Symptom	Try This:
Charger light does not come on.	Check radio/battery is properly inserted and check battery/charger contacts to be sure they are clean.
Low battery meter reading although new batteries are installed	Verify that the radio is set to the correct battery type. (Single cell batteries only.)
Cannot activate VOX	Feature not set and on. Sensitivity set to $\square$ . Please refer to Hands-Free Use/VOX on page 17.

PRELIMINARY

Troubleshooting

**XTR**

## Motorola Limited Warranty Personal Communications Products Purchased in the United States and Canada

### V. What This Warranty Covers

- Products. Defects in materials and workmanship in wireless cellular telephones, pagers, and/or two-way radios, and certain accessories that are sold with them, such as the battery, battery charger and holster manufactured and/or sold by Motorola (Products).
- Batteries. Defects in materials and workmanship in batteries that are manufactured by Motorola and/or sold with Products are covered by this warranty only if the fully-charged capacity falls below 80% of rated capacity or they leak.
- Software. Physical defects in the media that tangibly embodies each copy of any software supplied with the Products.

### VI. What the Period of Coverage Is

From the date the Products are purchased by the first end-user:

- Products. The warranty is for one year. Exception: The warranty for Spirit GT series and Talkabout series two-way radio accessories is for 90 days.
- Software. The warranty is for 90 days.
- Repairs / Replacements. The warranty is for the balance of the original warranty or for 90 days from the date you receive it, whichever is longer.

### VII. Who is Covered

This warranty extends to the first end-user purchaser, only.

XTN

30

PRE

### VIII. What We Will Do to Correct Warranty Problems

At no charge to you, we have the option to repair or replace the Products or software that do not conform to the warranty, or to refund the Products' purchase price. We may use functionally equivalent reconditioned/refurbished/pre-owned or new Products or parts. No software updates are provided.

### IX. How to Get Warranty Service

Please call:

USA		Canada
<b>Cellular</b>	<b>1-800-331-6456</b>	<b>All Products 1-800-461-4575</b>
<b>Paging</b>	<b>1-800-548-9954</b>	<b>TTY 1-888-390-6456 (Text Telephone)</b>
<b>Two-Way</b>	<b>1-800-353-2729</b>	

#### **TTY 1-888-390-6456 (Text Telephone)**

You will receive instructions on how to ship the Products to Motorola. You must ship the Products to us with freight, duties and insurance prepaid. Along with the Products you must include: (a) a copy of your receipt, bill of sale or other comparable proof of purchase; (b) a written description of the problem; (c) the name of your service provider (if this Product requires subscription service); (d) the name and location of the installation facility (if applicable) and, most importantly; (e) your address and telephone number. If requested, you must also return all detachable parts such as antennas, batteries and chargers. **RETAIN YOUR ORIGINAL PROOF OF PURCHASE.**

We will ship repaired or replacement Products at our expense for the freight and insurance, but at your expense for any duties. If additional information is needed, please contact us at the telephone number listed above.

Motorola Limited Warranty

**XTN**

31

#### **X. What This Warranty Does Not Cover**

- Products that are operated in combination with ancillary or peripheral equipment or software not furnished by Motorola for use with the Products (“ancillary equipment”), or any damage to the Products or ancillary equipment as a result of such use. Among other things, “ancillary equipment” includes batteries, chargers, adaptors, and power supplies not manufactured or supplied by Motorola. Any of these voids the warranty.
- Someone other than Motorola (or its authorized service centers) tests, adjusts, installs, maintains, alters, modifies or services the Products in any way. Any of these voids the warranty.
- Rechargeable batteries that: (a) are charged by other than the Motorola-approved battery charger specified for charging such batteries; (b) have any broken seals or show evidence of tampering; (c) are used in equipment other than the Product for which they are specified; or (d) are charged and stored at temperatures greater than 60 degrees centigrade. Any of these voids the warranty.
- Products that have: (a) serial numbers or date tags that have been removed, altered or obliterated; (b) board serial numbers that do not match each other, or board serial numbers that do not match the housing; or (c) nonconforming or non-Motorola housings or parts. Any of these voids the warranty.
- Defects or damage that result from: (a) use of the Products in a manner that is not normal or customary; (b) improper operation or misuse; (c) accident or neglect such as dropping the Products onto hard surfaces; (d) contact with water, rain, extreme humidity or heavy perspiration; (e) contact with sand, dirt or the like; or (f) contact with extreme heat, or spills of food or liquid.
- Physical damage to the surface of the Products, including scratches, cracks or other damage to a display screen, lens or other externally exposed parts.
- Failure of Products that is due primarily to any communication service or signal you may subscribe to or use with the Products.
- Coil cords that are stretched or that have any broken modular tabs.
- Products that are leased.

Flat-rate repair rates may apply to Products not covered by this warranty. To obtain information about Products needing repairs that are not covered by this warranty, please call the telephone number previously listed. We will provide information on repair availability, rates, methods of payment, where to send the Products, etc.

**XI. Some Other Limitations**

This is Motorola's complete warranty for the Products, and states your exclusive remedies. This warranty is given in lieu of all other express warranties. Implied warranties, including without limitation, the implied warranties of merchantability and fitness for a particular purpose, are given only if specifically required by applicable law. Otherwise, they are specifically excluded.

No warranty is made as to coverage, availability, or grade of service provided by the Products, whether through a service provider or otherwise.

No warranty is made that the software will meet your requirements or will work in combination with any hardware or applications software products provided by third parties, that the operation of the software products will be uninterrupted or error free, or that all defects in the software products will be corrected.

In no event shall Motorola be liable, whether in contract or tort (including negligence) for damages in excess of the purchase price of the Product, or for any indirect, incidental, special or consequential damages of any kind, or loss of revenue or profits, loss of business, loss of information or data, or other financial loss arising out of or in connection with the ability or inability to use the Products, to the full extent these damages may be disclaimed by law.

Motorola Limited Warranty

**XTN**

33

## **XII. Patent and Software Provisions**

At Motorola's expense, we will defend you, and pay costs and damages that may be finally awarded against you, to the extent that a lawsuit is based on a claim that the Products directly infringe a United States patent. Our obligation is conditioned on: (a) you notifying us promptly in writing when you receive notice of the claim; (b) you giving us sole control of the defense of the suit and all negotiations for its settlement or compromise; and (c) should the Products become, or in Motorola's opinion be likely to become, the subject of a claim of infringement of a United States patent, you permit us, at our option and expense, either to: procure for you the right to continue using the Products; replace or modify them so that they become non-infringing; or grant you a credit for such Products, as depreciated, and accept their return. The depreciation will be an equal amount per year over the lifetime of the Products, as established by Motorola.

Motorola will have no liability to you with respect to any claim of patent infringement that is based upon the combination of the Products or parts furnished under this limited warranty with ancillary equipment, as defined in VI., above.

This is Motorola's entire liability with respect to infringement of patents by the Products.

Laws in the United States and other countries preserve for Motorola and other third party software providers certain exclusive rights for copyrighted software, such as the exclusive rights to reproduce in copies and distribute copies of such software. The software may be copied into, used in and redistributed with only those Products that are associated with such software. No other use, including without limitation, disassembly or reverse engineering of such software or exercise of exclusive rights in such software is permitted.



### **XIII. State Law and Other Jurisdiction Rights**

Some states and other jurisdictions do not allow the exclusion or limitation of incidental or consequential damages, or limitation on the length of an implied warranty, so the above limitations or exclusions may not apply to you.

This warranty gives you specific legal rights, and you may also have other rights, which vary from jurisdiction to jurisdiction.

To obtain information on Motorola Personal Communications Products, including warranty service, accessories and optional Extended Warranties on selected Products, please call:

USA

**Cellular 1-800-331-6456**

**Paging 1-800-548-9954**

**Two-Way 1-800-353-2729**

**TTY 1-888-390-6456 (Text Telephone)**

Canada

**All Products 1-800-461-4575**

**TTY 1-888-390-6456 (Text Telephone)**



To correspond with Motorola about the Products, please write us at <http://www.motorola.com> or at:

In the USA:

Motorola, Inc.  
600 North U.S. Highway 45  
Libertyville, IL 60048

In Canada:

Motorola Canada Limited  
5875 Whittle Road  
Mississauga, ON L4Z 2H4

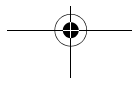



### **Software Copyright Notice**

The Motorola products described in this manual may include copyrighted Motorola and third party software stored in semiconductor memories or other media. Laws in the United States and other countries preserve for Motorola and third party software providers certain exclusive rights for copyrighted software, such as the exclusive rights to distribute or reproduce the copyrighted software. Accordingly, any copyrighted software contained in the Motorola products may not be modified, reverse-engineered, distributed, or reproduced in any manner to the extent allowed by law. Furthermore, the purchase of the Motorola products shall not be deemed to grant either directly or by implication, estoppel, or otherwise, any license under the copyrights, patents, or patent applications of Motorola or any third party software provider, except for the normal, non-exclusive, royalty-free license to use that arises by operation of law in the sale of a product.

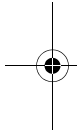

### **Patent Notice**

This product is covered by one or more of the following United States patents.

5896277 5894292 5864752 5699006 5742484 D408396 D399821 D387758  
D389158 5894592 5893027 5789098 5734975 5861850 D395882 D383745  
D389827 D389139 5929825 5926514 5953640 6071640 D413022 D416252  
D416893 D433001

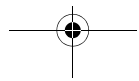
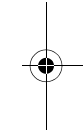





## Export Law Assurances

This product is controlled under the export regulations of the United States of America and Canada. The Governments of the United States of America and Canada may restrict the exportation or re-exportation of this product to certain destinations. For further information contact the U.S. Department of Commerce or the Canadian Department of Foreign Affairs and International Trade.

Replacement of any transmitter component (crystal, semiconductor, etc.) not authorized by the FCC equipment authorization for this radio could violate FCC rules.

More specifically, changes or modifications not expressly approved by Motorola may void the user's authority granted by the FCC to operate this radio and should not be made. To comply with FCC requirements, transmitter adjustments should be made only by or under the supervision of a person certified as technically qualified to perform transmitter maintenance and repairs in the private land mobile and fixed services as certified by an organization representative of the user of those services.

Replacement of any transmitter component (crystal, semiconductor, etc.) not authorized by the FCC equipment authorization for this radio could violate FCC rules.

**Note:** Use of this radio outside the country where it was intended to be distributed is subject to government regulations and may be prohibited.

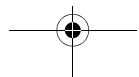
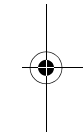
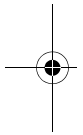

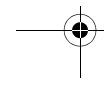
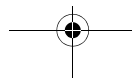
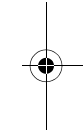
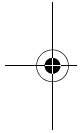
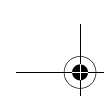

**Index****A**

Accessory .....	18
Cover .....	6
Adjust volume .....	6
Alkaline batteries .....	5

**B**

Back cover .....	4
Bandwidth .....	12
Battery .....	

Alkaline .....	5
Install .....	5

Charge .....	
NTN8971NiMH .....	7

Meter .....	5
NTN8971NiMH .....	

Charge .....	7
Install .....	4

Optimum life .....	7
Setting .....	20

Button Beeps .....	14
--------------------	----

**C**

Call display .....	16
Call tone .....	6,16
Channel .....	3,9,14
Activity .....	15
Change .....	6
Monitor .....	19
Setting .....	10

Charger .....	7
Desktop Drop-in .....	8
Multi-unit .....	9
Plug-in .....	8
Charging .....	7
Clean radio .....	22
Cloning .....	9,13
Code .....	
Interference Eliminator .....	9,11
Scrambling .....	9

**D**

Default .....	
Settings .....	13

**Diagram**

Function .....	6
Drop-in Charger .....	8

**E**

Eavesdrop Reducer .....	11
Exit a menu .....	6

**F****FCC****FAX**

1-202-418-0177 .....	1
----------------------	---

**FORMS**

1-800-418-3676 .....	1
1-800-418-FORM .....	1









**QUESTIONS**

1-888-225-5322 .....	1
1-888-CALL-FCC .....	1

UHF Bandwidth .....	12	Battery .....	5
FCC Licensing Information .....	1	Mic Gain .....	16
Frequency .....	3	Microphone .....	6
Setting .....	10	Monitor Signal Strength .....	15
Functions .....	6	MOTOROLA SERVICES	
<b>G</b>		1-800-448-6686 .....	1
Gain .....	16	<b>N</b>	
<b>H</b>		noise .....	16
Hands-Free Use .....	17	NTN8971NiMH battery.....	4
<b>I</b>		<b>O</b>	
Icon Programming .....	9	Obstacle .....	15
Indicator Light		Operating radio .....	15
.....	6	Optional Accessory	
Install		www.motorola.com/spirit.....	9
AA Battery .....	5	<b>P</b>	
NTN8971NiMH Battery.....	4	Plug	
Interference Eliminator Code .....	9,11	Audio.....	17
Internal VOX .....	18	Plug-in Charger.....	7
<b>L</b>		Programming Mode .....	10,11,12,13,14
Licensing Information		<b>R</b>	
FCC .....	1	Radio	
Light		Back cover .....	5
Charger.....	7	Bottom .....	4
Desktop Charger .....	8	Clean .....	22
Radio indicator.....	15	Diagram .....	6
Lock		Display .....	5
keypad .....	6	Factory default settings.....	13
<b>M</b>		Features.....	16
Meter		Frequency wave/Channel .....	9

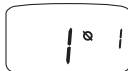
Functions and Settings .....	14	Talking range .....	21
Latch .....	4	To talk .....	6
Off .....	3	Transmit .....	18
On .....	14	<b>U</b>	
Operating .....	21	Use and Care .....	22
Out of range .....	15	<b>V</b>	
Radio Display .....	3	Volume	
Range		Adjust .....	6
Talking .....	21	VOX .....	14, 17
Roger Beeps .....	14	External .....	17
<b>S</b>		Off .....	18
Scan .....	28	<b>W</b>	
Turn On/Off .....	6	Website	
Scan List .....	19	Motorola	
Scrambling Code .....	11	<a href="http://www.motorola.com">www.motorola.com</a>	
Sensitivity level .....	17	Accessories	
Setting		<a href="http://www.motorola.com/radios/professional">www.motorola.com/radios/professional</a>	
Battery Type .....	20	FCC	
Call tone .....	16	<a href="http://www.fcc.gov">www.fcc.gov</a> .....	1
Channel .....	10		
Factory Defaults .....	13		
Interference Eliminator Code .....	11		
Scrambling Code .....	11		
Volume .....	3		
Setting VOX Sensitivity Level .....	17, 18		
Signal Strength Indicator .....	15		
Speaker .....	6		
<b>T</b>			
Talk Confirmation Tone .....	20		

### XTN-Series Quick Reference

Function	Appearance	
<b>Channel</b>		Use  or  for 1 through 6* <b>XU2600, XV2600</b>
<b>Frequency</b>		
<b>Interference Eliminator Code</b>		
-----		
<b>Eavesdrop Reducer</b>		Visible if Feature is On.
<b>Battery Meter</b>		Visible except when changing features.
<b>Channel Scan</b> <b>XU2600, XV2600</b>		Press  to access.
<b>Receiving</b>		Others speaking on the same frequency and code. Signal strength 1-6

## XTN Series User Programming

**Radio On**    **Visual**     as needed, then  or 

**Call Tone**     Choose 1, 2, 3 or Off = 0









**Mic Gain/  
Sensitivity  
Level**     Choose 1 low, 2 medium, or 3 high sensitivity.

**Scan List**     Choose Y (yes) or n (no) for each individual channel.  
**\*XU2600, XV2600 only**

**\*Battery Type**     B (alkaline)  
n (other rechargeable single cells)  
Does not appear if using NiMH.

**Lock Keypad**     Hold  for 3 seconds  
no flashing

### XTN Series Buttons

-  • Turn power on/off
-  • Access Preset Channel
-  • Transmit call tone
-  • Talk on the radio
-  • Exit a menu
-  • Scroll through menus
-  • Lock Keypad 3 seconds
-  or  • Scroll through settings.



6881038B80.book Page 1 Thursday, August 30, 2001 5:33 PM

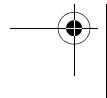
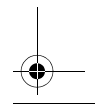
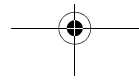
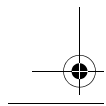
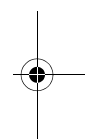
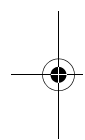
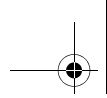
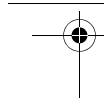



- **Extend Your Productivity**  
Provides a cost-effective solution to onsite communication needs. Designed for heavy duty, everyday industrial use. Well suited for construction, manufacturing, security, property management, retail, etc.
- **Rugged MOTOROLA QUALITY**  
Shock/drop/temperature tested to meet Motorola's High standards.
- **Weather/Dust Resistant**  
IP-54 rating
- **Built to Military Specifications**  
810 C, D, E & F
- **Dependable Indoor/Outdoor Coverage**  
Will provide a communication range\* of up to 250,000 sq. ft. or 20 floors indoors and up to 6 miles outdoors.  
\*Range will vary based on terrain and conditions and model selected.

- **Simple and Easy to Operate**  
Allows one-to-one or group communication at the push of a button. With no phone numbers to dial, plus the manager lock feature, there's little to no training needed for your staff to be fully up to speed.
- **Cost Efficient**  
No monthly fees to pay and no service contracts. Compatible with older Motorola Spirit® radios and audio accessories.
- **User Guide Included**

- **Business Exclusive Frequencies**  
Frequencies set aside exclusively for business-only use (FCC License required).
- **38 PL Codes, 83 Digital PL Codes.**
- **Talk Hands-Free Mode (VOX)**  
Advanced voice activation (VOX) let's you talk hands-free; XV2600, XU2600 models do not require accessories.
- **Voice Compression Technology**  
Helps provide better sound even at longer distances.
- **Cloning Capability**

**Radio Specification Chart**

Transmit Power	1 or 2 Watts
Receiver Sensitivity	-120 dBm for 12 dB SINAD
Audio Output	90 dB SPL
Receiver Technology	Direct Conversion

- **Accessories for XTN Series - Brochure included**  
Convenient headphones, multi-chargers, drop-in chargers, carry cases, and rechargeable battery packs available from your retailer or [www.motorola.com/sradios/professional](http://www.motorola.com/sradios/professional)

MOTOROLA, the Stylized M Logo, XTN Series and all other trademarks indicated as such herein are trademarks of Motorola, Inc. © Reg. U.S. Pat. & Tm. Off. All other product or service names are the property of their respective owners. © 2001 Motorola, Inc. All rights reserved. Printed in the U.S.A.

Motorola® XTN Series  
@xtnseries@  
Proof of Purchase

FCC GMRS  
License required.

**WARNING CHOKING HAZARD**  
**SMALL PARTS**  
Not for children under 3 years.  
This product is not intended to be used  
as a toy or plaything.

