



**MOTOROLA**  
*intelligence everywhere™*



**ASTRO® XTS™ 5000**  
**Digital Portable Radio**  
**Model III**  
**User Guide**



# ASTRO® XTS™ 5000 Digital Portable Radio, Model III Quick Reference Card

## Product Safety and RF Exposure Compliance



Before using this product, read the operating instructions for safe usage contained in the Product Safety and RF Exposure booklet enclosed with your radio.

### ATTENTION!

This radio is restricted to occupational use only to satisfy FCC RF energy exposure requirements. Before using this product, read the RF energy awareness information and operating instructions in the Product Safety and RF Exposure booklet enclosed with your radio (Motorola Publication part number 68P81095C98) to ensure compliance with RF energy exposure limits.

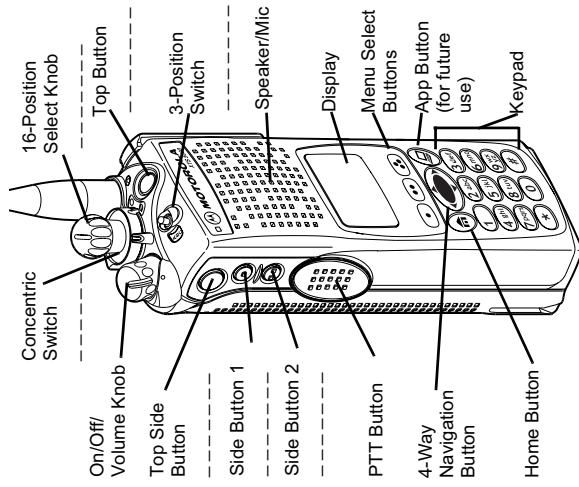

Write your radio's programmed features on the dashed lines.

## Radio On/Off

- 1 On - On/Off/Volume knob clockwise.
- 2 Off - On/Off/Volume knob counterclockwise.

## Zones/Channels

- 1 Zone - Zone switch to desired zone.
- 2 Channel - Channel switch to desired channel.

## Receive/Transmit

- 1 Radio on and select zone/channel.
- 2 Listen for a transmission.  
- Or -  
Press and hold **Volume Set** button.  
- Or -  
Press **Monitor** button and listen for activity.
- 3 Adjust volume, if necessary.
- 4 Press **PTT** to transmit; release to receive.

## Send Emergency Alarm

Radio on and press **Emergency** button. Display shows current zone/channel, and **EMERGENCY**. Red LED lights; you hear short, medium-pitched tone.

Note: To exit emergency at any time, press and hold **Emergency** button.

When acknowledgment is received, you hear four beeps; alarm ends; radio exits emergency.











## Send Emergency Call

- 1 Radio on and press **Emergency** button.  
Note: To exit emergency at any time, press and hold **Emergency** button.
- 2 Press and hold **PTT**. Announce your emergency into the microphone.
- 3 Release **PTT** to end call.
- 4 Press and hold **Emergency** button to exit emergency.

## Send Silent Emergency Alarm

- 1 Radio on and press **Emergency** button. Display does not change; you see no LED; you hear no tone.  
Note: To exit emergency at any time, press and hold **Emergency** button.
- 2 Silent emergency continues until you:
  - Press and hold **Emergency** button to exit emergency state.  
- Or -
  - Press and release **PTT** to exit silent emergency and enter regular emergency (alarm, call, or alarm with call).

### Display Status Symbols

	Receiving an individual call
	The radio is in the view or program mode; <b>On Steady</b> = view mode; <b>Flashing</b> = program mode
	Received signal strength for the current site (trunking only). The more stripes in the symbol, the stronger the signal.
	Flashes when the battery is low.
	You are talking directly to another radio or through a repeater; <b>On</b> = direct; <b>Off</b> = repeater
	This channel is being monitored.
	Your radio is in secure operation; <b>On</b> = secure operation; <b>Off</b> = clear operation; <b>Flashing</b> = receiving an encrypted voice call
	The radio is scanning a scan list
	Priority 1 Channel during scan
	Priority 2 Channel during scan

### Menu Entries (Use With Menu Navigation)

Entry	Menu Selection	Page
BATT	Smart Battery	16
CALL	Private Call/Selective Call	59/63
CHAN	Select a Channel	22
CLCK	Set the Time and Date	95
DIR	Repeater/Direct	74
ERAS	Key Zeroization	82
KEY	Key Selection	79
KSET	Keyset Selection	80
LOGF	Radio Lock	31
MUTE	Keypad Mute	32
NAME	Text Select	42
NUM	Number Select	41

Entry	Menu Selection	Page
PAGE	Call Alert Page	67
PHON	Phone	55
PROG	Editing	41
PSWD	Password	30
PWR	TX Power Level	27
REKY	Rekey Request	85
RPGM	Reprogram Request	88
SCAN	Scan On/Off	51
SITE	Site Lock/Unlock	92
STS	Status Call	72
TGRP	Talkgroup Call	70
VIEW	View a List	40
ZONE	Select a Zone	21

### Menu Navigation

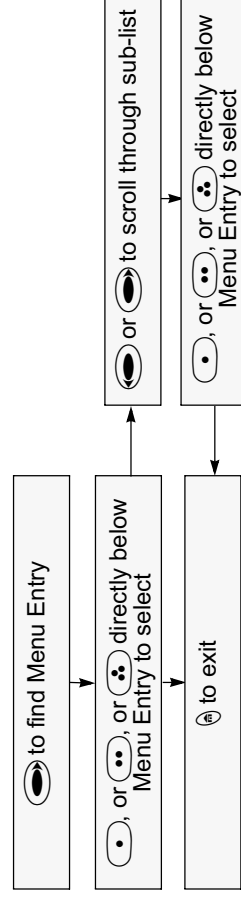



***ASTRO® XTS™ 5000***  
***Digital Portable Radio***  
***Model III***  
***User Guide***

Motorola, Inc.  
8000 West Sunrise Blvd.  
Ft. Lauderdale, FL 33322

6881094C27-E

## Product Safety and RF Exposure Compliance



Caution

Before using this product, read the operating instructions for safe usage contained in the Product Safety and RF Exposure booklet enclosed with your radio.

### ATTENTION!

This radio is restricted to occupational use only to satisfy FCC RF energy exposure requirements. Before using this product, read the RF energy awareness information and operating instructions in the Product Safety and RF Exposure booklet enclosed with your radio (Motorola Publication part number 68P81095C98) to ensure compliance with RF energy exposure limits.

### Computer Software Copyrights

The Motorola products described in this manual may include copyrighted Motorola computer programs stored in semiconductor memories or other media. Laws in the United States and other countries preserve for Motorola certain exclusive rights for copyrighted computer programs, including, but not limited to, the exclusive right to copy or reproduce in any form the copyrighted computer program. Accordingly, any copyrighted Motorola computer programs contained in the Motorola products described in this manual may not be copied, reproduced, modified, reverse-engineered, or distributed in any manner without the express written permission of Motorola. Furthermore, the purchase of Motorola products shall not be deemed to grant either directly or by implication, estoppel, or otherwise, any license under the copyrights, patents or patent applications of Motorola, except for the normal non-exclusive license to use that arises by operation of law in the sale of a product.

### Documentation Copyrights

No duplication or distribution of this document or any portion thereof shall take place without the express written permission of Motorola. No part of this manual may be reproduced, distributed, or transmitted in any form or by any means, electronic or mechanical, for any purpose without the express written permission of Motorola.

### Disclaimer

The information in this document is carefully examined, and is believed to be entirely reliable. However, no responsibility is assumed for inaccuracies. Furthermore, Motorola reserves the right to make changes to any products herein to improve readability, function, or design. Motorola does not assume any liability arising out of the applications or use of any product or circuit described herein; nor does it cover any license under its patent rights, nor the rights of others.

MOTOROLA, the Stylized M Logo and ASTRO are registered in the U.S. Patent & Trademark Office. All other product or service names are the property of their respective owners.

P25 radios contain technology patented by Digital Voice Systems, Inc.  
© Motorola, Inc. 2003. All Rights Reserved. Printed in the U.S.A. 3/04.

# Contents

---

Product Safety and RF Exposure Compliance .....	ii
Computer Software Copyrights .....	ii
Documentation Copyrights .....	ii
Disclaimer .....	ii
<b>General Radio Operation .....</b>	<b>1</b>
Notations Used in This Manual .....	1
Your XTS 5000 Model III Radio .....	2
Physical Features of the XTS 5000 Model III Radio .....	3
Programmable Controls .....	3
Display .....	4
Backlight .....	5
Status Symbols .....	5
Menu Entry (Softkey) .....	7
Menu Select Buttons .....	7
Menu Entry Features .....	8
Home Button .....	8
App Button .....	8
4-Way Navigation Button .....	9
Keypad .....	9
LED Indicators .....	10
Alert Tones .....	11
Standard Accessories .....	14
Battery .....	14
Smart Battery Status .....	16
Antenna .....	17
Belt Clip .....	18
Universal Connector Cover .....	19
Radio On and Off .....	20
Turn the Radio On .....	20
Turn the Radio Off .....	20
Zones and Channels .....	21
Select a Zone .....	21
Select a Channel .....	22
Receive / Transmit .....	24
Without Using the Volume Set and Monitor Buttons .....	24
Use the Preprogrammed Volume Set Button .....	24
Use the Preprogrammed Monitor Button .....	25
Conventional Mode Operation .....	26

<b>Common Radio Features</b> . . . . .	<b>27</b>
Selectable Power Level . . . . .	27
Use the Menu . . . . .	27
Use the Preprogrammed Transmit Power Level Switch . . . . .	28
Radio Lock . . . . .	29
Unlock Your Radio . . . . .	29
Change Your Password . . . . .	30
Enable or Disable the Radio Lock Feature (Secure Radios Only) . . . . .	31
Mute or Unmute Keypad Tones . . . . .	32
Use the Menu . . . . .	32
Use the Preprogrammed Keypad Mute Button . . . . .	32
Conventional Squelch Operation . . . . .	33
Analog Options . . . . .	33
Digital Options . . . . .	33
PL Defeat . . . . .	34
Time-out Timer . . . . .	35
Emergency . . . . .	36
Send an Emergency Alarm . . . . .	36
Send an Emergency Call . . . . .	37
Send a Silent Emergency Alarm . . . . .	38
Emergency Keep-Alive . . . . .	39
Lists . . . . .	40
View a List . . . . .	40
Scan List Empty . . . . .	40
Edit a Call, Page, or Phone List Number . . . . .	41
Edit a Call, Page, or Phone List Name . . . . .	42
Edit a Scan List . . . . .	43
Scan . . . . .	51
Turn Scan On or Off . . . . .	51
Delete a Nuisance Channel . . . . .	52
Conventional Scan Only . . . . .	53
Telephone Calls (Trunking Only) . . . . .	54
Quick Access (One-Touch) . . . . .	54
Answer a Phone Call . . . . .	55
Initiate a Phone Call . . . . .	55
Select a Phone Number . . . . .	56
Make a Phone Call . . . . .	56
Private Calls (Trunking Only) . . . . .	58
Quick Access (One-Touch) . . . . .	58



---

Answer a Private Call .....	59
Initiate a Private Call .....	59
Select an ID Number .....	60
Make a Private Call .....	61
Selective Calls (ASTRO Conventional Only) .....	62
Quick Access (One-Touch) .....	62
Answer a Selective Call .....	62
Initiate a Selective Call .....	63
Select an ID Number .....	63
Make a Selective Call .....	64
Call Alert Paging .....	65
Quick Access (One-Touch) .....	65
Answer a Call Alert Page .....	66
Initiate a Call Alert Page .....	67
Select an ID Number .....	68
Send a Call Alert Page .....	68
Conventional Talkgroup Calls (Conventional Operation Only) .....	70
Select a Talkgroup .....	70
Status Calls (ASTRO 25 Trunking Only) .....	72
Send a Status Call .....	72
Repeater or Direct Operation .....	74
Select Repeater or Direct Operation .....	74
Smart PTT (Conventional Only) .....	76
<b>Special Radio Features . . . . .</b>	<b>77</b>
Secure Operations .....	77
Select Secure Transmissions .....	77
Select Clear Transmissions .....	77
Managing Encryption .....	78
Digital PTT ID .....	86
Receive .....	86
Transmit .....	86
View Your Radio's ID Number .....	87
Dynamic Regrouping (Trunking Only) .....	88
Reprogram Request (ASTRO 25 Trunking Only) .....	88
Select Enable / Disable .....	90
Trunking System Controls .....	91
Failsoft .....	91
Out-of-Range .....	91
Site Lock .....	92

## Contents

---

Site Trunking .....	93
Site View and Change .....	94
Time and Date .....	95
<b>Helpful Tips .....</b>	<b>97</b>
Radio Care .....	97
Cleaning .....	98
Handling .....	99
Service .....	99
Battery .....	100
Battery Life .....	100
Charging the Battery .....	100
Battery Recycling and Disposal .....	101
Antenna .....	103
Radio Operating Frequencies .....	103
<b>Accessories .....</b>	<b>105</b>
Antennas .....	105
Batteries and Battery Accessories .....	105
Carry Accessories .....	106
Belt Clips .....	106
Belt Loops .....	106
Carry Cases .....	107
Chargers .....	107
Surveillance Accessories .....	108
Earpieces .....	108
Headsets and Headset Accessories .....	109
Radio Interface Modules for Ear Microphones .....	109
Speaker, Remote Speaker and Public Safety Microphones .....	110
CommPort Integrated Microphone/Receivers .....	110
Switches .....	111
Vehicular Adapters .....	111
Accessories .....	111
<b>Glossary .....</b>	<b>113</b>
<b>Commercial Warranty .....</b>	<b>119</b>
<b>Index .....</b>	<b>125</b>

**Table 1: Channel Map**

Use the chart below to map the channels (Cx) and zones (Zx) for your radio.

	Z1	Z2	Z3	Z4	Z5	Z6
C1						
C2						
C3						
C4						
C5						
C6						
C7						
C8						
C9						
C10						
C11						
C12						
C13						
C14						
C15						
C16						

Contents

---

## Notes

# General Radio Operation

---

## Notations Used in This Manual

Throughout the text in this publication, you will notice the use of **WARNINGS**, **Cautions**, and **Notes**. These notations are used to emphasize that safety hazards exist, and the care that must be taken or observed.

  
**WARNING**



**An operational procedure, practice, or condition, etc., which may result in injury or death if not carefully observed.**

  
**Caution**

An operational procedure, practice, or condition, etc., which may result in damage to the equipment if not carefully observed.

**Note:** An operational procedure, practice, or condition, etc., which is essential to emphasize.

The following special notations identify certain items:

<i>Example</i>	<i>Description</i>
<b>Light</b> button or 	Buttons and keys are shown in bold print or as a key symbol.
	Information appearing on the radio's display is shown using the special display font.
PHONE	Menu entries are shown similar to the way they appear on the radio's display.
Press 	This means "Press the right side of the <b>4-way Navigation</b> button."

## Your XTS 5000 Model III Radio

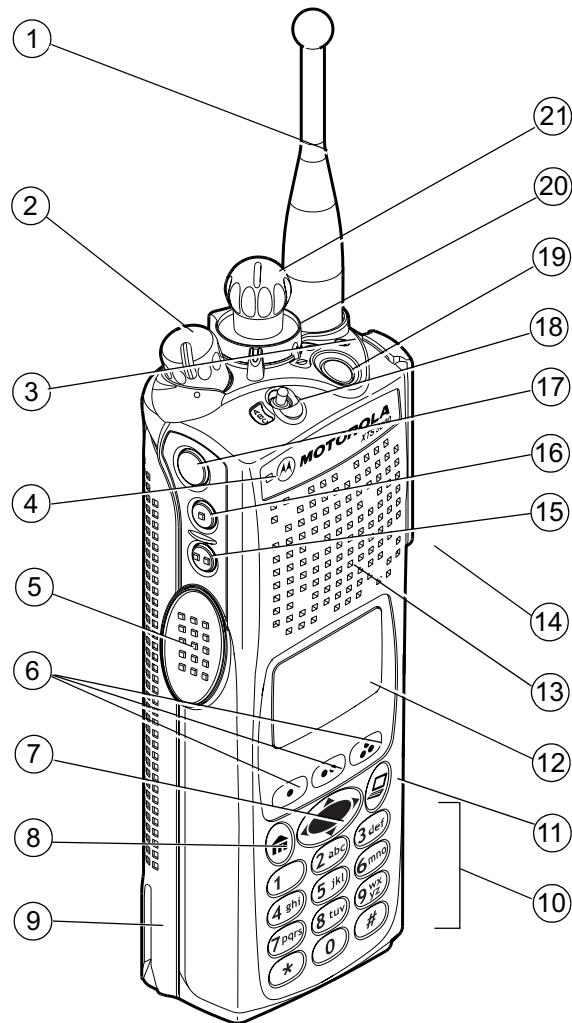

## Physical Features of the XTS 5000 Model III Radio

Table 2: Physical Features

<b>No.</b>	<b>Feature</b>	<b>Page</b>	<b>No.</b>	<b>Feature</b>	<b>Page</b>
1	Antenna	17	8	Home Button	8
2	On/Off/Volume Control Knob	20	9	Battery	14
3	LED	10	10	Keypad	9
4	Microphone		11	App Button	8
5	PTT (Push-to-Talk) Button		12	Display	4
6	Menu Select Buttons	7	13	Speaker	
7	4-Way Navigation Button	9	14	Universal Connector	19

## Programmable Controls

The following radio controls can be programmed to operate certain software-activated features.

<b>No.</b>	<b>Feature</b>	<b>No.</b>	<b>Feature</b>
15	Side Button 2	19	Top Button
16	Side Button 1	20	2-Position Concentric Switch
17	Top Side (Select) Button	21	16-Position Select Knob
18	3-Position A/B/C Switch		

The features that can be assigned to these controls by a qualified radio technician, and the pages where these features can be found are listed in Table 3 on page 4.

**Any references in this manual to controls that are “preprogrammed” mean that a qualified radio technician must use the radio’s programming software to assign a feature to a control.**

**Table 3: Programmable Features**

<i>Feature</i>	<i>Page</i>	<i>Feature</i>	<i>Page</i>	<i>Feature</i>	<i>Page</i>
Call Alert	65	Phone	54	Selective Call	62
Call Response	59	PL Defeat	34	Site Lock/ Unlock	92
Channel	22	Private Call	58	Site Search	94
Dynamic Priority	53	Repeater/Direct	75	Smart Battery	16
Emergency	36	Reprogram Request	89	Status	73
Keypad Mute	32	Scan List Programming	47	TX Power Level	28
Light	5	Scan On/Off	51	Volume Set	24
Monitor	25	Secure/Clear	77	Zone	21
Nuisance Delete	52	Select	45		

## Display

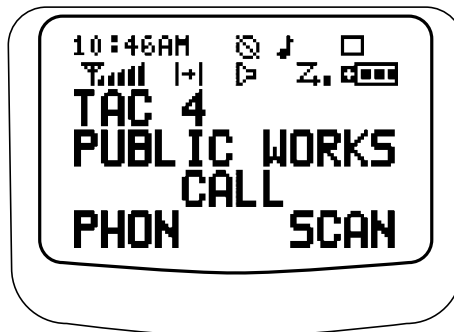

The above screen is typical of what you will see on your radio. The 64 x 96 pixel liquid crystal display (LCD) shows radio status, text, and menu entries.



## Backlight



If poor light conditions make the display, keypad, or channel numbers (around the **16-Position Select** knob) difficult to read, turn on the radio's backlights by pressing the preprogrammed **Light** button.

These lights will remain on for a preprogrammed time before they turn off automatically, or you can turn them off immediately by pressing the **Light** button again.



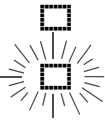

## Status Symbols

The top two display rows contain symbols that indicate radio operating conditions.

**Table 4: Status Symbols**

<b>Symbol</b>	<b>Indication</b>	<b>Page No.</b>
	<b>Call Received</b> Flashes when an Individual Call is received.	55, 59, 62, 66
	<b>View/Program Mode</b> The radio is in the view or program mode. <ul style="list-style-type: none"> <li>• On steady = view mode</li> <li>• Flashing = program mode</li> </ul>	40-45, 47, 48
	<b>Received Signal Strength Indication (RSSI)</b> The received signal strength for the current site, for trunking only. The more stripes in the symbol, the stronger the signal.	94
	<b>Battery</b> <ul style="list-style-type: none"> <li>• Conventional = flashes when battery is low</li> <li>• Smart = the number of bars (0-3) shown indicates the charge remaining in your battery; flashes when battery is low</li> </ul>	101

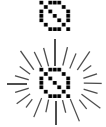
**Table 4: Status Symbols (Continued)**

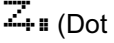
<b>Symbol</b>	<b>Indication</b>	<b>Page No.</b>
	<p><b>Talkaround</b></p> <ul style="list-style-type: none"> <li>• On = you are talking directly to another radio, not through a repeater, during conventional operation only</li> <li>• Off = you are talking through a repeater</li> </ul>	74
	<p><b>Monitor (Carrier Squelch)</b> The selected channel is being monitored during conventional operation only.</p>	26, 33, 34
	<p><b>Secure Operation</b></p> <ul style="list-style-type: none"> <li>• On = secure operation</li> <li>• Off = clear operation</li> <li>• Flashing = receiving an encrypted voice call</li> </ul>	77
	<p><b>Scan</b> The radio is scanning a scan list.</p>	44, 46-51
 (Dot Flashing)	<p><b>Priority-One Channel Scan</b> One channel is assigned as the priority channel during scan operation.</p>	44, 46-50
 (Dot Steady)	<p><b>Priority-Two Channel Scan</b> Two channels are assigned as the priority channels during scan operation.</p>	44, 46-50

### Menu Entry (Softkey)

The bottom row of the display contains one to three menu entries (also known as softkeys). The menu entries allow you to select one of several menus to access the radio's features. The menu entries are accessed through the **Menu Select** buttons.

### Menu Select Buttons

The **Menu Select** buttons access the menu entries of features that have been activated by a qualified radio technician. Your radio may be programmed differently from the following example, but the display for turning Scan on or off might look like the example below. For instance, to turn Scan on, press  directly below ON.

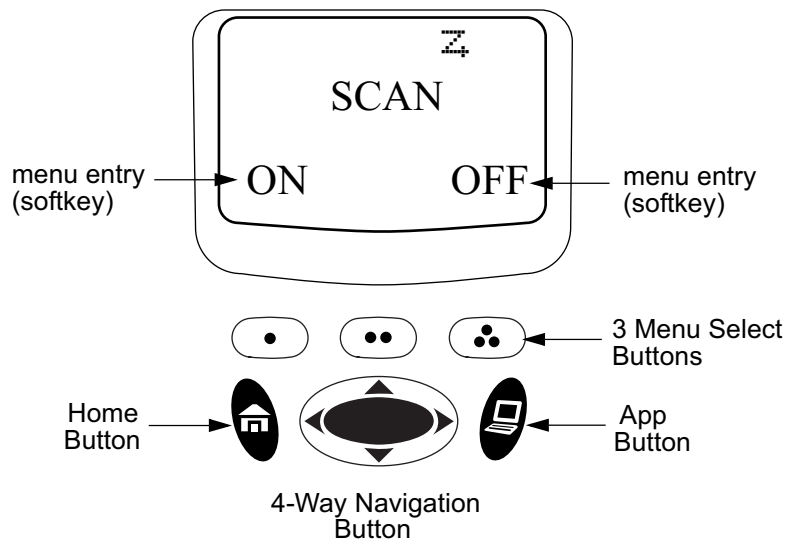

## Menu Entry Features

**Table 5: Menu Entries**

<i>Feature</i>	<i>Menu Entry</i>	<i>Page</i>	<i>Feature</i>	<i>Menu Entry</i>	<i>Page</i>
Smart Battery	BATT	16	Phone	PHON	55
Private Call / Selective Call	CALL	59/63	Editing	PROG	41
Channel Selection	CHAN	22	Password	PSWD	30
Time/Date	CLCK	95	TX Power Level	PWR	27
Repeater/Direct	DIR	74	Rekey Request	REKY	85
Key Zeroization	ERAS	82	Reprogram Request	RPGM	88
Key Selection	KEY	79	Scan On/Off	SCAN	51
Keypad Selection	KSET	80	Site Lock/Unlock	SITE	92
Radio Lock	LOGF	31	Status Call	STS	72
Keypad Mute	MUTE	32	Talkgroup Call	TGRP	70
Text Select	NAME	42	View a List	VIEW	40
Number Select	NUM	41	Zone Selection	ZONE	21
Call Alert Page	PAGE	67			

### Home Button

The **Home** button always returns you to the home (default) display. In most cases, this is the current mode.

Some radio features that you can edit require saving information in memory. Pressing the **Home** button after editing those features causes information to be saved before going to the home display.

Some features do not require you to press the **Home** button to go to the home display. This reduces the required number of key presses.

### App Button

Reserved for future use.

### 4-Way Navigation Button

This button is used to scroll through the radio's lists or items in the display, or both.

### Keypad



The 3 x 4-key alphanumeric keypad provides an interface to your radio's features.



The keypad functions in a manner similar to a standard telephone keypad when entering numeric digits.

When the keypad is used to edit a list, each key can generate different characters of the alphabet. Refer to Table 6, below, for a complete list of characters.

**Table 6: Keypad Characters**

Key	Number of times the key is pressed								
	1	2	3	4	5	6	7	8	9
0	0	(	)	<	>				
1	1	&	%						
2 abc	A	B	C	2	a	b	c		
3 def	D	E	F	3	d	e	f		
4 ghi	G	H	I	4	g	h	i		
5 jkl	J	K	L	5	j	k	l		
6 mno	M	N	O	6	m	n	o		
7 pqrs	P	Q	R	S	7	p	q	r	s
8 tuv	T	U	V	8	t	u	v		

**Table 6: Keypad Characters (Continued)**

Key	Number of times the key is pressed								
	1	2	3	4	5	6	7	8	9
	W	X	Y	Z	9	w	x	y	z
	*	/	+	-	=				
	#	.	!	?	,	;			

## LED Indicators

The LED on top of the radio indicates the radio's operating status:

**Table 7: LED Indicators**

LED Indicator	What it Means
Red	Radio transmitting
Flashing red	<ul style="list-style-type: none"> <li>• Channel busy, or</li> <li>• Low battery (while transmitting)</li> </ul>
Double flashing red	Receiving encrypted audio
Flashing green	Receiving an individual call

## Alert Tones

An alert tone is a sound or group of sounds. Your radio uses alert tones to inform you of your radio's conditions. The following table lists these tones and when they occur.

**Table 8: Alert Tones**

<i>You Hear</i>	<i>Tone Name</i>	<i>Heard</i>
<b>Short, Low-Pitched Tone</b>	Invalid Key-Press	when wrong key is pressed
	Radio Self-Test Fail	when radio fails its power-up self test
	Reject	when unauthorized request is made
	Time-Out Timer Warning	four seconds before time out
<b>Long, Low-Pitched Tone</b>	No ACK Received	when radio fails to receive an acknowledgment
	Time-Out Timer Timed Out	after time out
	Talk Prohibit/PTT Inhibit	(when <b>PTT</b> button is pressed) transmissions are not allowed
	Out-of-Range	(when <b>PTT</b> button is pressed) the radio is out of range of the system
	Invalid Mode	when radio is on an unprogrammed channel
	Individual Call Warning Tone	when radio is in an individual call for greater than 6 seconds without any activity
<b>A Group of Low-Pitched Tones</b>	Busy	when system is busy

**Table 8: Alert Tones (Continued)**

<i><b>You Hear</b></i>	<i><b>Tone Name</b></i>	<i><b>Heard</b></i>
<b>Short, Medium-Pitched Tone</b>	Valid Key-Press	when correct key is pressed
	Radio Self-Test Pass	when radio passes its power-up self test
	Clear Voice	at beginning of a non-coded communication
	Priority Channel Received	when activity on a priority channel is received
	Emergency Alarm Entry	when entering the emergency state
	Central Echo	when central controller has received a request from a radio
<b>Long, Medium-Pitched Tone</b>	Volume Set	when volume is changed on a quiet channel
	Emergency Exit	when exiting the emergency state
<b>A Group of Medium-Pitched Tones</b>	Failsoft	when the trunking system fails
	Automatic Call Back	when voice channel is available from previous request
	Talk Permit	(when <b>PTT</b> button is pressed) verifying system accepting transmissions
	Keyfail	when encryption key has been lost
	Console Acknowledge	when status, emergency alarm, or reprogram request ACK is received
	Received Individual Call	when Call Alert or Private Call is received
	Call Alert Sent	when Call Alert is received by the target radio
<b>Short, High-Pitched Tone (Chirp)</b>	Low-Battery Chirp	when battery is below preset threshold value



**Table 8: Alert Tones (Continued)**

<b><i>You Hear</i></b>	<b><i>Tone Name</i></b>	<b><i>Heard</i></b>
<b>Ring</b>	Fast Ringing	when system is searching for target of Private Call
	Enhanced Call Sent	when waiting for target of Private Call to answer the call
	Phone Call Received	when a land-to-mobile phone call is received
<b>Gurgle</b>	Dynamic Regrouping	(when the <b>PTT</b> button is pressed) a dynamic ID has been received

## Standard Accessories

### Battery



To avoid a possible explosion:

- **DO NOT** replace the battery in any area labeled “hazardous atmosphere”.
- **DO NOT** discard batteries in a fire.

### Charging the Battery

The Motorola-approved battery shipped with your radio is uncharged. Prior to using a new battery, charge it for a minimum of 16 hours to ensure optimum capacity and performance.

For a list of Motorola-authorized batteries available for use with your XTS 5000 radio, see “Batteries and Battery Accessories” on page 105.

**Note:** When charging a battery attached to a radio, turn the radio off to ensure a full charge.

### **Battery Charger**

To charge the battery, place the battery, with or without the radio, in a Motorola-approved charger. The charger’s LED indicates the charging progress; see your charger’s user guide. For a list of chargers, see “Chargers” on page 107.

### Attach the Battery

- 1 With the radio turned off, insert the top edge of the battery into the radio's frame as shown.

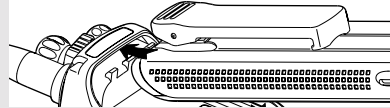

- 2 Rotate the battery toward the radio and press down until the battery clicks into place.

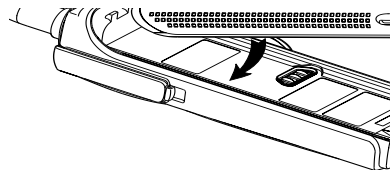

---

### Remove the Battery

- 1 With the radio turned off, press the release button on the bottom of the battery until the battery releases from the radio.



- 2 Remove the battery from the radio.

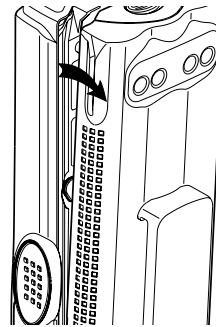

**Note:** If your radio is programmed with volatile-key retention, encryption keys will be retained for approximately 30 seconds after battery removal. Consult a qualified radio technician for details.

---



## Smart Battery Status

This feature lets you view the status of your Smart Battery.

### Use the Menu

- 1 Press  to find BATT.

BATT

- 2 Press , , or  directly below BATT.

CAPACITY 70%  
INIT 10/01  
EST CHGS 11

**Note:** If a Smart Battery is not powering your radio:

SMART BATT  
DATA NOT  
AVAILABLE.

- 3 Press  to exit.

### Use the Preprogrammed Smart Battery Button

- 1 Press the **Smart Battery** button.

CAPACITY 70%  
INIT 10/01  
EST CHGS 11

**Note:** If a Smart Battery is not powering your radio:

SMART BATT  
DATA NOT  
AVAILABLE.

- 2 Press  to exit.

## Antenna

For information regarding available antennas, see page 103.

### Attach the Antenna

With the radio turned off, turn the antenna clockwise to attach it to the radio.

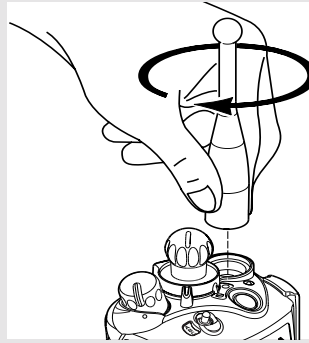

### Remove the Antenna

With the radio turned off, turn the antenna counter-clockwise to remove it from the radio.

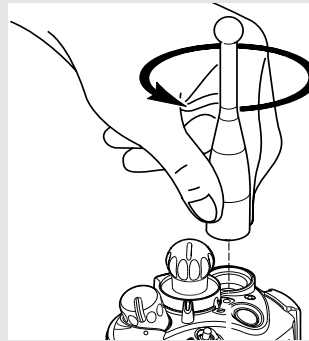

## Belt Clip

### Attach the Belt Clip

- 1 Align the grooves of the belt clip with those of the battery.

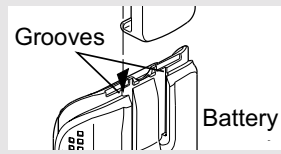

- 2 Press the belt clip downward until you clear a click.

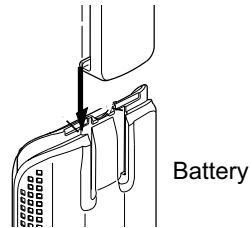

---

### Remove the Belt Clip

- 1 Use a flat-bladed object to press the belt clip tab away from the battery.

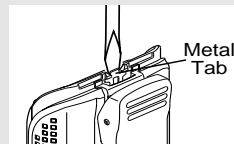

- 2 Slide the belt clip upward to remove it.

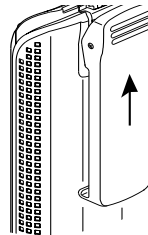

## Universal Connector Cover

The universal connector is located on the antenna side of the radio. It is used to connect accessories to the radio.

**Note:** To prevent damage to the connector, shield it with the connector cover when not in use.

### Remove the Universal Connector Cover

- 1 Insert a flat-bladed screwdriver into the area between the bottom of the cover and the slot below the connector.
- 2 Hold the top of the cover with your thumb while you pry the bottom of the cover away from the radio with the screwdriver.

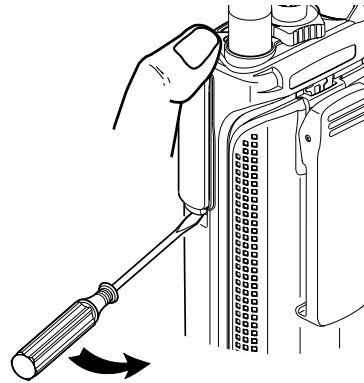

---

### Attach the Universal Connector Cover

- 1 Insert the hooked end of the cover into the slot above the connector. Press downward on the cover's top to seat it in the slot.
- 2 Rub the ball of your thumb from the top to the bottom of the cover while applying pressure towards the radio. This should flex the cover and snap it into place.

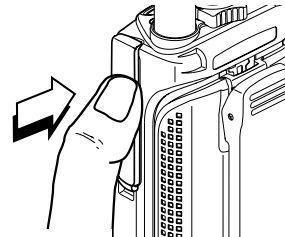
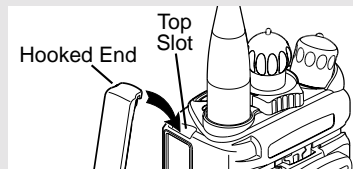

## Radio On and Off

### Turn the Radio On

Turn the **On/Off/Volume Control** knob clockwise.

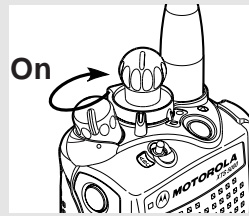

**Note:** If the power-up test is successful, you briefly see SELF TEST, then the home display.

SELF TEST

If the power-up test is unsuccessful, you see ERROR XX/YY. (XX/YY is an alphanumeric code.)

ERROR XX/YY

Turn off the radio, check the battery, and turn the radio on. If the radio fails the power-up test again, record the ERROR XX/YY code and contact a qualified radio technician.

### Turn the Radio Off

Turn the **On/Off/Volume Control** knob counterclockwise until it clicks.

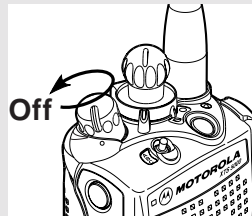







## Zones and Channels





A zone is a grouping of channels. A channel is a group of radio characteristics, such as transmit/receive frequency pairs.

Before you use your radio to receive or send messages, you should select the zone and channel.

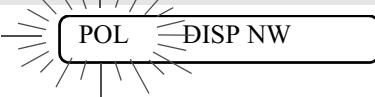
### Select a Zone

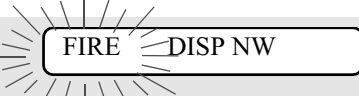
#### Use the Menu

- 1 Press  to find ZONE. 
  - 2 Press , , or  directly below ZONE. 

The current zone (in this case, POL) flashes and the channel name (DISP NW), does not flash.
  - 3 Press  to find the zone you want. For example, FIRE. 
  - 4 Press  to confirm the displayed zone and channel. 
- OR**
- Press the **PTT** button to transmit on the displayed zone/channel. 

#### Use the Preprogrammed Zone Switch

- 1 If a control on your radio has been preprogrammed as the **Zone** switch, move the **Zone** switch to the position for the zone you want. 

**Note:** If the zone you selected is unprogrammed, repeat step 1.

UNPROGRAMMED

2 Press  to confirm the displayed zone and channel.

FIRE DISP NW

### Select a Channel

Consult a qualified radio technician for the right choice between the following methods:

#### Method 1: Use the Preprogrammed 16-Position Select Knob

After the zone you want is displayed, turn the **16-Position Select** knob to the desired channel.

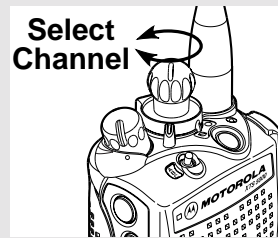

#### Method 2: Use the Menu

1 Press  to find CHAN.

CHAN

2 Press , , or  directly below CHAN.

POL DISP NW

The display shows the current channel name (in this case, DISP NW) flashing and the zone (POL), not flashing.

3 Press  to find the channel name you want.

POL DISP SE

**OR**

Use the keypad to enter the channel number.

**Note:** If the channel you selected is unprogrammed, repeat step 3.

UNPROGRAMMED

4 Press  to confirm the displayed zone and channel.

POL DISP SE

**OR**

Press the **PTT** button to transmit on the displayed zone/channel.

---

## Receive / Transmit

Radio users who switch from analog to digital radios often assume that the lack of static on a digital channel is an indication that the radio is not working properly. This is not the case. Digital technology quiets the transmission by removing the “noise” from the signal and allowing only the clear voice or data information to be heard.

This section emphasizes the importance of knowing how to monitor a channel for traffic before keying up to send a transmission.

### Without Using the Volume Set and Monitor Buttons

- 1 Turn the radio on and select the desired zone and channel.
- 2 Listen for a transmission.
- 3 Adjust the **Volume Control** knob if necessary.

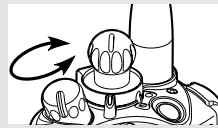

- 4 Press and hold the **PTT** button to transmit. The LED lights RED while transmitting.
- 5 Release the **PTT** button to receive (listen).

### Use the Preprogrammed Volume Set Button

- 1 Turn the radio on and select the desired zone and channel.
- 2 Press and hold the **Volume Set** button to hear the volume set tone.

- 3 Adjust the **Volume Control** knob if necessary.

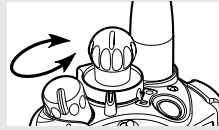

- 4 Release the **Volume Set** button.

- 5 Press and hold the **PTT** button to transmit. The LED lights RED while transmitting.

- 6 Release the **PTT** button to receive (listen).

### Use the Preprogrammed Monitor Button

- 1 Turn the radio on and select the desired zone and channel.

- 2 Press the **Monitor** button and listen for activity. The Carrier Squelch indicator is displayed. (See the following **Conventional Mode Operation**.)



- 3 Adjust the **Volume Control** knob if necessary.

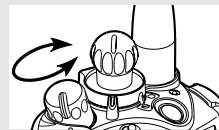

- 4 Press and hold the **PTT** button to transmit. The LED lights RED while transmitting.

- 5 Release the **PTT** button to receive (listen).

## Conventional Mode Operation

Your radio may be programmed to receive Private-Line® (PL) calls.

- 1 Momentarily press the **Monitor** button to listen for activity. The Carrier Squelch indicator is displayed.



- 2 Press and hold the **Monitor** button to set continuous monitor operation. (The duration of the button press is programmable.)

- 3 Press the **Monitor** button again, or the **PTT** button, to return to the original squelch setting.

**Note:** If you try to transmit on a receive-only channel, you will hear an invalid tone until you release the **PTT** button.

## Common Radio Features









---

### Selectable Power Level

This feature lets you select the power level at which your radio will transmit. The radio will always turn on to the default setting. This feature must be preprogrammed by a qualified radio technician.

- Select LOW for a shorter transmitting distance and to conserve power.
- Select HIGH for a longer transmitting distance.

### Use the Menu

<b>1</b> Press  to find PWR.	PWR
<b>2</b> Press  ,  , or  directly below PWR. The display shows the current power level, along with LOW and HIGH.	HIGH POWER LOW
<b>OR</b>	
	LOW POWER LOW
<b>3</b> Press  ,  , or  directly below the desired power level (LOW or HIGH).	<ul style="list-style-type: none"><li>• The new transmit power level is saved.</li><li>• The radio returns to the home display.</li></ul>
<b>Note:</b> To exit without changing the setting, press  or the <b>PTT</b> button.	

## Use the Preprogrammed Transmit Power Level Switch

- 1** Move the **TX Power Level** switch to the **Low Power** position. The power level is set to Low.
  - 2** Move the **TX Power Level** switch to the **High Power** position. The power level is set to High.
-



## Radio Lock

This feature changes your radio to a more robust security system that protects the use of the secure encryption keys. If this feature is enabled in your radio by a qualified radio technician, when you turn the radio on, you see RADIO LOCKED.

### Unlock Your Radio

- 1 Enter your numeric password.

**Note:**

- *Secure-equipped radios* — **6 to 8** characters.
- *Clear radios* — **0 to 8** characters.

If you make a mistake, press  to backspace.

- 2 Press the preprogrammed **Select** button after you enter your password. If the password is *correct*, the radio unlocks.

**Note:** If the password is *incorrect*, the radio remains locked.

RADIO LOCKED













- If you enter three incorrect passwords in a row, you see DEADLOCK. Turn the radio off and then on, and begin again at step 1.

DEADLOCK

- *Secure Radios Only* — If you enter a total of **17** consecutive incorrect passwords (turning the radio off and on does not reset this number), the radio erases all of its encryption keys and shows “DEADLOCK.” See a qualified radio technician.

DEADLOCK

## Change Your Password



- 1 Press  to find PSWD.
  - 2 Press , , or  directly below PSWD.
  - 3 Enter the old password.
  - 4 Press , , or  directly below SEL.
  - 5 Enter the new password.
  - 6 Press , , or  directly below SEL.
  - 7 Re-enter the new password.
  - 8 Press , , or  directly below SEL. The password is updated.
- Note:** If the two passwords do not match, repeat steps 5 through 8.
- Note:** If you enter three incorrect old passwords, the radio exits the password feature. You cannot access this feature again until you turn the radio off and on.
-

## Enable or Disable the Radio Lock Feature (Secure Radios Only)

This feature (programmable by a qualified radio technician) allows you to enable or disable the radio lock feature.

- 1 Press  to find LOGF.



LOGF

- 2 Press , , or  directly below LOGF. You see the current state.



PSWD ENABLD  
ENAB      DSAB

**OR**

PSWD DISBLD  
ENAB      DSAB

- 3 To enable the radio lock feature, press , , or  directly below ENAB.

**OR**

To disable the radio lock feature, press , , or  directly below DSAB.



## Mute or Unmute Keypad Tones

You can turn the keypad tones on or off.

### Use the Menu

- 1 Press  to find MUTE.



MUTE

- 2 Press , , or  directly below MUTE. The current state is shown.

TONES OFF  
OFF

OR

TONES ON  
OFF

- 3 Press , , or  directly below OFF or ON.

**Note:** Press  or the **PTT** button to exit without changing the setting.

### Use the Preprogrammed Keypad Mute Button

Press the **Keypad Mute** button to turn the tones off or on.

## Conventional Squelch Operation

### Analog Options

Tone Private Line (PL), Digital Private-Line (DPL), and carrier squelch can be available (preprogrammed) per channel.

<i>When in</i>	<i>This condition occurs</i>
Carrier squelch ([-])	You hear all traffic on a channel.
PL or DPL	The radio responds only to your messages.

### Digital Options

One or more of the following options may be programmed in your radio. Consult your service technician for more information.

<i>This option</i>	<i>Will allow you to hear</i>
Digital Carrier-Operated Squelch (COS)	any digital traffic.
Normal Squelch	any digital traffic having the correct network access code.
Selective Switch	any digital traffic having the correct network access code and correct talkgroup.

## PL Defeat

With this feature, you can override any coded squelch (DPL or PL) that might be preprogrammed to a channel.

Place the preprogrammed **PL Defeat** switch in the **PL Defeat** position. You can now hear any activity on the channel. The radio is muted if no activity is present.

When this feature is active, the Carrier Squelch status indicator (🔇) will be displayed.

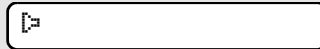

## Time-out Timer

The time-out timer turns off your radio's transmitter. The timer is set for 60 seconds at the factory, but it can be programmed from 0 to 7.75 minutes (465 seconds) by a qualified radio technician.

- |          |   |   |
|----------|---|---|
| <b>1</b> | Hold down the <b>PTT</b> button longer than the programmed time. You will hear a short, low-pitched warning tone, the transmission will cut-off, and the LED will go out until you release the <b>PTT</b> . | <ul style="list-style-type: none"><li>• Short warning tone</li><li>• Transmission is cut-off</li><li>• LED goes out</li></ul> |
| <b>2</b> | Release the <b>PTT</b> button.  | <ul style="list-style-type: none"><li>• LED re-lights</li><li>• Timer resets</li></ul>  |
| <b>3</b> | Press the <b>PTT</b> to re-transmit. The time-out timer restarts.   | <ul style="list-style-type: none"><li>• Timer restarts</li><li>• LED is red</li></ul>   |

## Emergency

If the top (orange) button is programmed to send an emergency signal, then this signal overrides any other communication over the selected channel.

Your radio can be programmed for the following:

- Emergency Alarm
- Emergency Call
- Emergency Alarm with Emergency Call
- Silent Emergency Alarm

Consult a qualified radio technician for emergency programming of your radio.

### Send an Emergency Alarm

An emergency alarm will send a data transmission to the dispatcher, identifying the radio sending the emergency.

**1** With your radio turned on, press the **Emergency** button. The current zone/channel is displayed alternately with EMERGENCY, the red LED lights, and a short, medium-pitched tone sounds.

If the selected channel does not support emergency, the display shows NO EMERGENCY. Select a channel that does show EMERGENCY.

**Note:** To exit emergency at any time, press and hold the **Emergency** button for about a second.

EMERGENCY

- Red LED
- Short tone

NO EMERGENCY



- 2** When you receive the dispatcher's acknowledgment, you see **ACK RECEIVED**, four tones sound, the alarm ends, and the radio exits the emergency mode.
- ACK RECEIVED**
- Four tones
  - Alarm ends
  - Radio exits emergency
- If no acknowledgement is received, you see **NO ACKNOWLEDG**, the alarm ends, and the radio exits the emergency mode.
- NO ACKNOWLEDG**
- Alarm ends
  - Radio exits emergency

**Note: For Emergency Alarm with Emergency Call:** The radio enters the Emergency Call state either after it receives the dispatcher's acknowledgment, or if you press the **PTT** button while in Emergency Alarm. Go to step 2 of "Send an Emergency Call", below.

---

### Send an Emergency Call

This type of dispatch gives your radio priority access on a channel.

The radio operates in the normal dispatch manner while in Emergency Call, except, if enabled, it will return to one of the following:

- Tactical/Non-Revert — You talk on the channel you selected before you entered the emergency state.
- Non-Tactical/Revert — You talk on a preprogrammed emergency channel. The emergency alarm is sent on this same channel.

- 1 With your radio turned on, press the **Emergency** button. The current zone/channel is displayed alternately with EMERGENCY, and a short, medium-pitched tone sounds.

EMERGENCY

- Short tone

**Note:** To exit emergency at any time, press and hold the **Emergency** button for about a second.

- 2 Press and hold the **PTT** button and announce your emergency into the microphone.

- 3 Release the **PTT** button to end the transmission and wait for a response from the dispatcher.

- 4 Press and hold the **Emergency** button for about a second to exit emergency.

---

### Send a Silent Emergency Alarm

- 1 With your radio turned on, press the **Emergency** button. The display does not change, the LED does not light, and you hear no tones.
  - Display does not change
  - LED does not light
  - No tones

**Note:** To exit emergency at any time, press and hold the **Emergency** button for about a second.

- 2 The silent emergency state continues until you:
- Press and hold **Emergency** button
- Press and hold the **Emergency** button for about a second to exit the emergency state.
- OR**
- Press and release the **PTT** button
- OR**
- Press and release the **PTT** button to exit silent emergency and enter regular dispatch or emergency call.
- 

**Note:** For ALL Emergency signals, when changing channels:

- If the new channel is also programmed for Emergency, you can change channels while in Emergency operation. The emergency alarm or call continues on the new channel.
- If the new channel is NOT programmed for Emergency, you see NO EMERGENCY, and hear an invalid tone until you exit the Emergency state or change to a channel programmed for emergency.

### **Emergency Keep-Alive**

If the radio is in the Emergency state, with Emergency Keep-Alive enabled, you cannot turn off the radio by using the **On/Off Control** knob.

With Keep-Alive, the radio will only exit the Emergency state using one of the ways mentioned in the previous sections (Emergency Alarm, Silent Emergency Alarm, or Emergency Call).

## Lists

You can use lists to store frequently used numbers and associate them with names. There are four list types:

- Call
- Page
- Phone
- Scan

### View a List



1 Press  to find VIEW.

VIEW

2 Press , , or  directly below VIEW.

3 Press  or  to see the names of available lists.

CALL  
PAGE PHON

4 Press , , or  directly below the name of the list you wish to view. You see the first list member.  
□ indicates the view mode.

FIRE CHIEF □  
701234

5 Press  or  to view other list members.

6 Press  to exit.

---

### Scan List Empty













If you wish to view a scan list and the list has no entries, you see EMPTY LIST.

EMPTY LIST









To end this display, turn scan off or edit the list.



## Edit a Call, Page, or Phone List Number

### Use the Menu

- 1 Press  to find PROG. 
- 2 Press , , or  directly below PROG. You see the lists that can be changed. 
- 3 Press , , or  directly below the name of the list you wish to change. You see the first list member.  (flashing) indicates the programming mode.
- 4 Press  or  to select the list member to be changed. 

**OR**

You can use the keypad to enter the corresponding location number of the name in the list.
- 5 Press , , or  directly below NUM. The blinking cursor shows the location of the number to be added. 
- 6 Press  to erase digits. (If you erase the entire number and then press  or , you exit editing without saving your changes.) Press a keypad button to add a digit (see “Keypad” on page 9). 

7 Press , , or  directly below SAVE to save your change. Return to step 4 to make more changes.

**OR**



Press  to return to the home display.

## Edit a Call, Page, or Phone List Name





### Use the Menu

1 Press  to find PROG.



PROG

2 Press , , or  directly below PROG. You see the lists that can be changed.

PAGE CALL  
PHON

3 Press , , or  directly below the name of the list you wish to change. You see the first list member.  (flashing) indicates the programming mode.

FIRE CHIEF   
701234  
NUM NAME

4 Press  or  to select the list member to be changed.

SECURITY   
704321  
NUM NAME

**OR**

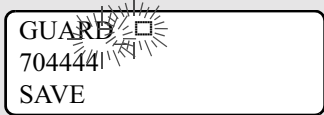
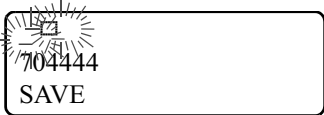

You can use the keypad to enter the corresponding location number of the name in the list.

- 5** Press , , or directly below NAME. The blinking cursor shows the location of the character to be added.
- 
- 6** Press to erase characters. (If you erase the entire name and press or , you exit editing without saving your changes.) Press a keypad button to add a character (see “Keypad” on page 9).
- 
- 7** Press , , or directly below SAVE to save your change. Return to step 4 to make more changes.
- OR**
- Press to return to the home display.



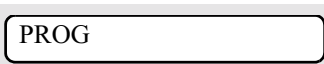

### Edit a Scan List

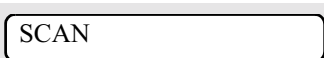
This feature lets you change scan list members and priorities.



#### Use the Menu



- 1** Press to find PROG.
- 
- 2** Press , , or directly below PROG. You see the lists that can be changed.
- 
- 3** Press to find SCAN.
- 

Common Radio Features

- 4 Press , , or  directly below SCAN. You see the first list member.  
 (flashing) indicates the programming mode.









- 5 Press  or  to find the member you want to change.

- 6 Press , , or  directly below SEL or DEL or RCL.





SEL = add and/or change the priority of the currently displayed channel in the scan list.  
 DEL = delete the currently displayed channel from the scan list  
 RCL = view the next member of the scan list.

**Note:** The maximum number of members for a trunking priority monitor scan list is 15; for a conventional scan list, 15; and for a talkgroup scan list, 10.

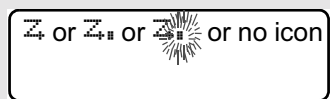

- 7 To change the priority of the currently displayed channel, press , , or  below SEL additional times to see , , or  or no icon.



 = this channel is in the scan list as a non-priority channel.  
 = this channel is in the scan list as the *priority 2* channel.  
 (dot flashing) = this channel is in the scan list as the *priority 1* channel. You will hear all traffic on the priority 1 channel, regardless of traffic on non-priority channels.  
 no icon = this channel is deleted from the scan list.

**Note:** You cannot delete a priority channel from a scan list. In a talkgroup scan list, priority cannot be assigned.



- 8 Press  or  to select more channels to be added or deleted.

**OR**











Use the keypad to go directly to additional channels to be added or deleted.

**OR**

Use the **16-Position Select** knob to select additional channels to be added or deleted.

- 9 Press  to exit scan list programming and return to the home display.

**Use the Menu and the Preprogrammed Select (Top Side) Button**

- |   |  |  |
|---|--|--|
| 1 | Press  to find PROG.  | PROG   |
| 2 | Press  ,  , or  directly below PROG. You see the lists that can be changed.   | CALL<br>PAGE                      PHON   |
| 3 | Press  to find SCAN.  | SCAN   |
| 4 | Press  ,  , or  directly below SCAN. You see the first list member.<br>□ (flashing) indicates the programming mode. | FIRE DISP NW  |
| 5 | Press  or  to find the member you want to change.  |  |



- 6 Press the **Select** button once to add the currently displayed channel to the scan list.

 or  or  or no icon



**AND/OR**

Press the **Select** button one or more times to change the scan list status symbol of the currently displayed channel.

**Note:** The maximum number of members for a trunking priority monitor scan list is 15; for a conventional scan list, 15; and for a talkgroup scan list, 10.

 = this channel is in the scan list as a non-priority channel.  
 = this channel is in the scan list as the *priority 2* channel.  
 (dot flashing) = this channel is in the scan list as the *priority 1* channel. You will hear all traffic on the priority 1 channel, regardless of traffic on non-priority channels.  
no icon = this channel is deleted from the scan list.

**Note:** You cannot delete a priority channel from a scan list. In a talkgroup scan list, priority cannot be assigned.

- 7 Press  or  to select more scan list members whose scan status you want to change.

**OR**

Use the keypad to go directly to that scan list member.

**OR**



Use the **16-Position Select** knob to select another scan list member.



- 8 Press  to exit scan list programming and return to the home display.

**Use the Preprogrammed Scan List Programming Switch and the Menu**

- 1 Move the **Scan List Programming** switch to the **Programming** position. You see the first list member.  (flashing) indicates the programming mode.









- 2 Press  or  to find the member you want to change.

- 3 Press , , or  directly below SEL or DEL or RCL.





SEL = add and/or change the priority of the currently displayed channel in the scan list.  
 DEL = delete the currently displayed channel from the scan list  
 RCL = view the next member of the scan list.

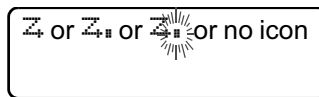

**Note:** The maximum number of members for a trunking priority monitor scan list is 15; for a conventional scan list, 15; and for a talkgroup scan list, 10.

- 4 To change the priority of the currently displayed channel, press , , or  below SEL additional times to see  or  or  or no icon.



 = this channel is in the scan list as a non-priority channel.  
 = this channel is in the scan list as the *priority 2* channel.  
 (dot flashing) = this channel is in the scan list as the *priority 1* channel. You will hear all traffic on the priority 1 channel, regardless of traffic on non-priority channels.  
no icon = this channel is deleted from the scan list.

**Note:** You cannot delete a priority channel from a scan list. In a talkgroup scan list, priority cannot be assigned.

5 Press  or  to select more channels to be added or deleted.

**OR**

Use the keypad to go directly to additional channels to be added or deleted.

**OR**

Use the **16-Position Select** knob to select additional channels to be added or deleted.



6 Move the **Scan List Programming** switch out of the **Programming** position.

---

### Change the Scan List Status Only

1 Move the **Scan List Programming** switch to the **Programming** position. You see the first list member.  
 (flashing) indicates the programming mode.



2 Press  or  to find the member you want to change.



3 Press the **Select** button once to add the currently displayed channel to the scan list.

 or  or  or no icon



**AND/OR**

Press the **Select** button one or more times to change the scan list status symbol of the currently displayed channel.

**Note:** The maximum number of members for a trunking priority monitor scan list is 15; for a conventional scan list, 15; and for a talkgroup scan list, 10.

 = this channel is in the scan list as a non-priority channel.  
 = this channel is in the scan list as the *priority 2* channel.  
 (dot flashing) = this channel is in the scan list as the *priority 1* channel. You will hear all traffic on the priority 1 channel, regardless of traffic on non-priority channels.  
 no icon = this channel is deleted from the scan list.

**Note:** You cannot delete a priority channel from a scan list. In a talkgroup scan list, priority cannot be assigned.

4 Press  or  to select more list members whose scan status you want to change.

**OR**

You can use the keypad to go directly to that scan list member.

**OR**

You can use the **16-Position Select** knob to select another scan list member.

- 5** Move the **Scan List Programming** switch out of the **Programming** position.











## Scan

The scan feature allows you to monitor traffic on different channels by scanning a preprogrammed list of channels. Your radio can have up to 32 different scan lists. These lists must be preprogrammed by a qualified radio technician.

- To view your radio's scan lists, see "View a List" on page 40.
- To change your radio's scan lists, see "Edit a Scan List" on page 43.

### Turn Scan On or Off

#### Use the Menu

<p><b>1</b> Press  to find SCAN.</p>	SCAN
<p><b>2</b> Press , , or  directly below SCAN. You see the current scan state.</p> <p>The scan status symbol is displayed when scan is on.</p>	SCAN ON  ON OFF
<b>OR</b>	
<p>The scan status symbol is displayed when scan is on.</p>	SCAN OFF  ON OFF
<p><b>3</b> Press , , or  directly below ON or OFF.</p> <p><b>OR</b></p> <p>You can press  or the <b>PTT</b> button to exit scan and return to the home display without changing the scan state.</p>	SCAN

#### Use the Preprogrammed Scan On/Off Switch

Place the **Scan** switch in the **Scan On** or **Scan Off** position. The scan status symbol is displayed when scan is on.



## Delete a Nuisance Channel

When the radio scans to a channel that you do not wish to hear (nuisance channel), you can temporarily delete the channel from the scan list.

- 1** When the radio is locked onto the channel to be deleted, press the preprogrammed **Nuisance Delete** button.

Repeat this step to delete more channels.

**Note:** You cannot delete priority channels or the designated transmit channel.

- 2** The radio continues scanning the remaining channels in the list. To resume scanning the deleted channel, change channels or turn scan off and then back on again.
-



## Conventional Scan Only

### Make a Dynamic Priority Change

While the radio is scanning, the dynamic priority change feature lets you *temporarily* change any channel in a scan list (except the priority-one channel) to the priority-two channel. The replaced priority-two channel becomes a non-priority channel. This change remains in effect until scan is turned off, then scanning reverts back to the preprogrammed state.

- 1 When the radio is locked onto the channel to be designated as priority-two, press the preprogrammed **Dynamic Priority** button.

**Note:** The priority-one channel cannot be changed to priority-two.

- 2 The radio continues scanning the remaining channels in the list. To resume scanning the preprogrammed priority-two channel, you must leave and re-enter scan operation.
-

## Telephone Calls (Trunking Only)

Use your radio to make calls similar to standard phone calls. A landline phone can be used to call a radio, or a radio can be used to call a landline phone.



### Quick Access (One-Touch)

If your radio is preprogrammed for Quick Access (One-Touch) Phone Call, you can make a call to *one* preprogrammed phone number without having to select the feature or a phone number.





- 1 Press the **Quick Access Phone** button to dial the phone number.
- 2 If your call is answered, press the **PTT** button to talk; release the **PTT** to listen.  
  
**OR**  
If your call is not answered, go to “Phone Call Display and Alert Prompts” on page 57.
- 3 When your call is completed, press **Ⓜ** to hang up. The radio returns to the home display.

## Answer a Phone Call

Use the preprogrammed **Call Response** button to answer a call.

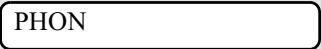
- 1 When a phone call is received, you hear a telephone-type ringing, the LED flashes GREEN, the call received symbol (#) flashes, and PHONE CALL is displayed.
  - Telephone-type ringing
  - Flashing GREEN LED
- 2 Press the **Call Response** button within 20 seconds after the call indicators begin.
- 3 Press and hold the **PTT** button to talk; release it to listen.
- 4 Press  to hang up and return to the home display.

## Initiate a Phone Call

- 1 Press  to find PHON.
 
- 2 Press , , or  directly below PHON. You see the last transmitted phone number.
 
- 3 Go to “Select a Phone Number” on page 56.
  - Use the Menu
  - Use the Keypad

**OR**

Go to “Make a Phone Call” on page 56.

## Select a Phone Number

### Use the Menu

- 1 Press  to find the phone number you want.

POLICE  
555-8523  
LNUM

**Note:** Press LNUM to go to the last number dialed.

- 2 Go to “Make a Phone Call”, below.
- 

### Use the Keypad

- 1 Use the keypad to enter the phone number you want.

POLICE  
555-8523  
LNUM

**Note:** Press LNUM to go to the last number dialed.

- 2 Go to “Make a Phone Call”, below.
- 

## Make a Phone Call



- 1 Press and release the **PTT** button to dial the phone number.
- 2 If your call is answered, press the **PTT** button to talk; release the **PTT** to listen.

### OR

If your call is not answered, go to “Phone Call Display and Alert Prompts” on page 57.

- 3 When your call is completed, press  to hang up. The radio returns to the home display.
-

**Table 9: Phone Call Display and Alert Prompts**

<p>When you press the <b>PTT</b> button and the phone system is not available, you hear a long tone. Press  to hang up. The radio returns to the home display.</p>	<div style="border: 1px solid black; border-radius: 10px; padding: 5px; text-align: center; margin-bottom: 10px;">NO PHONE</div> <ul style="list-style-type: none"> <li>• A long tone</li> </ul>
<p>When a channel is not available, you hear a busy tone. The radio automatically connects when a channel opens.</p>	<div style="border: 1px solid black; border-radius: 10px; padding: 5px; text-align: center; margin-bottom: 10px;">PHONE BUSY</div> <ul style="list-style-type: none"> <li>• A busy tone</li> </ul>
<p>When the phone system is busy, you hear a long tone. Press  to exit the phone mode and try your call later.</p>	<div style="border: 1px solid black; border-radius: 10px; padding: 5px; text-align: center; margin-bottom: 10px;">PHONE BUSY</div> <ul style="list-style-type: none"> <li>• A long tone</li> </ul>
<p>The call is not acknowledged. Press  to hang up. The radio returns to the home display.</p>	<div style="border: 1px solid black; border-radius: 10px; padding: 5px; text-align: center; margin-bottom: 10px;">NO ACKNOWLEDG</div>
<p><b>Notes:</b></p> <ul style="list-style-type: none"> <li>• A high-pitched tone, generated when you release the <b>PTT</b> button, indicates to the landline party that he or she may begin talking.</li> <li>• You have the option of sending additional digits (overdial), such as an extension number, or credit card or PIN numbers, to the phone system. If the radio is programmed for live overdial, every digit entered after the call is connected is sent to the phone system.</li> <li>• If the radio is programmed for buffered overdial, the digits pressed are entered into memory and then sent when the <b>PTT</b> button is pressed. Press the <b>PTT</b> to send either digits or voice, but not both at the same time.</li> </ul>	

## Private Calls (Trunking Only)

These one-to-one calls between two radios are not heard by others in the current talkgroup. The calling radio automatically verifies that the receiving radio is active on the system and can display the caller's ID.

### Quick Access (One-Touch)

If your radio is preprogrammed for Quick Access (One-Touch) Private Call, you can make a call to *one* preprogrammed ID number without having to select the feature or an ID number.

- 1 Press the **Quick Access Private Call** button to start the Private Call.

The called ID is momentarily displayed, then you see PLEASE WAIT.

FIRE CHIEF  
ID: 701234

PLEASE WAIT

- 2 When you are connected, you see the called ID. Press and hold the **PTT** button to talk; release the **PTT** to listen.

FIRE CHIEF  
ID: 701234

**OR**

If no acknowledgment is received, you see NO ACKNOWLEDG.

NO ACKNOWLEDG

**OR**

If the target radio does not respond before the time out, you see NO ANSWER.

NO ANSWER

- 3 Press  to hang up and return to the home display.

## Answer a Private Call

Use the preprogrammed **Call Response** button to answer a call.

<p><b>1</b> When a Private Call is received, you hear two alert tones, the LED flashes GREEN, the call received symbol (☎) flashes, and CALL RECEIVD is displayed.</p>	<ul style="list-style-type: none"> <li>• Two tones</li> <li>• Flashing GREEN LED</li> </ul>
--	---



**2** Press the **Call Response** button within 20 seconds.  
If the caller's name is in the call list, it will be displayed during the call.





**OR**

If the caller's name is not in the call list, the caller's ID number is displayed.

**3** Press and hold the **PTT** button to talk; release it to listen.

**4** Press  or the **Call Response** button to hang up and return to the home display.

## Initiate a Private Call

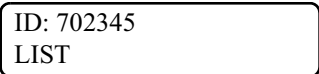
<p><b>1</b> Press  to find CALL.</p>	
<p><b>2</b> Press , , or  directly below CALL. You see the last transmitted or received ID number.</p>	

## Common Radio Features

---

- 3** Go to “Select an ID Number”, below.
- Use the Menu
  - Use the Keypad

**OR**

Go to “Make a Private Call” on page 61.

---

### Select an ID Number

#### Use the Menu

- 1** Press  to find the ID number you want.

FIRE CHIEF  
ID: 701234  
LNUM

**Note:** Press LNUM to go to the last number dialed.

- 2** Go to “Make a Private Call” on page 61.
- 

#### Use the Keypad

- 1** Use the keypad to enter the ID number you want.

FIRE CHIEF  
ID: 701234  
LNUM

**Note:** Press LNUM to go to the last number dialed.

- 2** Go to “Make a Private Call” on page 61.
-



## Make a Private Call

- 1 Press the **PTT** button to start the Private Call.

The called ID is momentarily displayed, then you see PLEASE WAIT.

FIRE CHIEF  
ID: 701234

PLEASE WAIT

- 2 When you are connected, you see the called ID. Press and hold the **PTT** button to talk; release the **PTT** to listen.

FIRE CHIEF  
ID: 701234

**OR**

If no acknowledgment is received, you see NO ACKNOWLEDG.

NO ACKNOWLEDG

**OR**

If the target radio does not respond before the time out, you see NO ANSWER.

NO ANSWER

- 3 When your call is completed, press  to hang up. The radio returns to the home display.

## Selective Calls (ASTRO Conventional Only)

A Selective Call is used to call a select individual. It is intended to provide privacy and to eliminate the annoyance of having to listen to conversations that are of no interest to you.

### Quick Access (One-Touch)

If your radio is preprogrammed for Quick Access (One-Touch) Selective Call, you can make a call to *one* preprogrammed ID number without having to select the feature or an ID number.

**1** Press the **Quick Access Selective Call** button to start the Selective Call.

**2** When you are connected, you see the called ID. Press and hold the **PTT** button to talk; release the **PTT** to listen.



FIRE CHIEF  
ID: 701234

**3** Press  to hang up and return to the home display.

### Answer a Selective Call

**1** When a Selective Call is received, you hear two alert tones, the LED flashes GREEN, the call received symbol () flashes, and CALL RECEIVD is displayed.

- Two tones
- Flashing GREEN LED







CALL RECEIVD 

**2** The display will remain active for two seconds, and then the speaker will unmute.

**3** Press and hold the **PTT** button to talk; release it to listen.

- 4 Press  to hang up and return to the home display.

### Initiate a Selective Call

- 1 Press  to find CALL. CALL
- 2 Press , , or  directly below CALL. You see the last transmitted or received ID number. ID: 702345  
LIST
- 3 Go to “Select an ID Number”, below.
  - Use the Menu
  - Use the Keypad

**OR**

Go to “Make a Selective Call” on page 64.

### Select an ID Number

#### Use the Menu

- 1 Press  to find the ID number you want. FIRE CHIEF  
ID: 701234  
LNUM
- Note:** Press LNUM to go to the last number dialed.
- 2 Go to “Make a Selective Call” on page 64.

### Use the Keypad

- 1 Use the keypad to enter the ID number you want.

FIRE CHIEF  
ID: 701234  
LNUM

**Note:** Press LNUM to go to the last number dialed.

- 2 Go to “Make a Selective Call”, below.
- 

### Make a Selective Call

- 1 Press the **PTT** button to start the Selective Call.

- 2 When you are connected, you see the called ID. Press and hold the **PTT** button to talk; release the **PTT** to listen.

FIRE CHIEF  
ID: 701234

- 3 When your call is completed, press  to hang up. The radio returns to the home display.
-

## Call Alert Paging

Call Alert allows your radio to work like a pager. Even if other users are away from their radios, or if they are unable to hear their radios, you can still send them a Call Alert page. You can also verify if a radio is active on the system.

In conventional operation, you can send either an individual Call Alert page or a group Call Alert page. ID numbers for individuals are preceded by ID: and for groups by GR:.

### Quick Access (One-Touch)

If your radio is preprogrammed for Quick Access (One-Touch) Call Alert Paging, you can send a page to *one* preprogrammed ID number without having to select the feature or an ID number.

- 1 Press the **Quick Access Call Alert** button to send the Call Alert. You see PLEASE WAIT.

PLEASE WAIT

- 2 When you are connected, you see the home display. Press and hold the **PTT** button to talk; release the **PTT** to listen.

**OR**

If an individual Call Alert page is not acknowledged, you see NO ACKNOWLEDG.



NO ACKNOWLEDG

If a group Call Alert page is not acknowledged, you do not see NO ACKNOWLEDG. The radio will merely exit Call Alert and return to normal operation.





- 3** Press  or the **Call Response** button to hang up and return to the home display.

---

### Answer a Call Alert Page

- 1** When a Call Alert page is received, you hear four repeating alert tones, the LED flashes GREEN, the call received symbol () flashes, and PAGE RECEIVD is displayed.
- Four repeating alert tones
  - Flashing GREEN LED
- 
- 2** Press and hold the **PTT** button to talk; release it to listen.
-

## Initiate a Call Alert Page

- |   |  |
|---|--|
| <p><b>1</b> Press  to find PAGE.</p>   | <p>PAGE</p>  |
| <p><b>2</b> Press , , or  directly below PAGE.</p> <p>If an individual Call Alert page was last transmitted or received, you see the individual ID number.</p> <p>If a group Call Alert page was last transmitted, you see blanks in the individual ID scratchpad and the group ID transmitted to in the group ID scratchpad (accessed by pressing  once).</p> <p>If a group Call Alert page was last received, you see the ID of the sending radio in the individual ID scratchpad and the group ID transmitted to in the group ID scratchpad.</p> | <p>FIRE CHIEF<br/>ID: 701234<br/>LIST</p>  |
|   | <p>FIRE CHIEF<br/>ID: _____<br/>LIST</p>   |
|   | <p>FIRE DEPT<br/>GR: 704440<br/>LIST</p>   |
| <p><b>3</b> Go to “Select an ID Number” on page 68.</p> <p><b>OR</b></p> <p>Go to “Send a Call Alert Page” on page 68.</p>  | <ul style="list-style-type: none"> <li>• Use the Menu</li> <li>• Use the Keypad</li> </ul> |

## Select an ID Number

### Use the Menu

- 1 Press  to find the ID number you want.

**Note:** Press LNUM to go to the last number dialed.



FIRE CHIEF  
ID: 701234  
LNUM

- 2 Go to “Send a Call Alert Page”, below.
- 

### Use the Keypad

- 1 Use the keypad to enter the ID number you want.

**Note:** Press LNUM to go to the last number dialed.



FIRE CHIEF  
ID: 701234  
LNUM

- 2 Go to “Send a Call Alert Page”, below.
- 

## Send a Call Alert Page

- 1 Press the **PTT** button to send the Call Alert to the displayed number. You see PLEASE WAIT.



PLEASE WAIT

- 2 When you are connected, you see the home display. Press and hold the **PTT** button to talk; release the **PTT** to listen.

**OR**



If an individual Call Alert page is not acknowledged, you see NO ACKNOWLEDG.

NO ACKNOWLEDG

If a group Call Alert page is not acknowledged, you do not see NO ACKNOWLEDG. The radio will merely exit Call Alert and return to normal operation.













- 3** Press  to hang up and return to the home display.

## Conventional Talkgroup Calls (Conventional Operation Only)

Talkgroup Call lets you define a group of conventional system users so that they can share the use of a conventional channel.

Encryption keys are slaved to talkgroups. When talkgroups are enabled, encryption keys are changed by changing the active talkgroup. See “Secure Operations” on page 77.

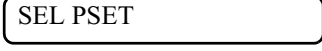
### Select a Talkgroup

- 1 Press  to find TGRP. 
- 2 Press , , or  directly below TGRP. You see the last talkgroup that was selected and stored, and SEL and PSET. 
- 3 Press  or  to find the talkgroup you want.  
**OR**  
Use the keypad to enter the number of the corresponding talkgroup in the list.
- 4 Press , , or  directly below SEL or PSET.   
**SEL (SELECT)** — Saves the currently displayed talkgroup and returns to the home display.  
**PSET (PRESET)** — Selects the preset preprogrammed talkgroup.  
If the encryption key slaved to the new talkgroup is erased, you see KEY FAIL and hear a momentary key fail tone. 
  - Momentary key fail tone

If the encryption key that is slaved to the new talkgroup is not allowed, you see ILLEGAL KEY and hear a momentary key fail tone.

ILLEGAL KEY

- Momentary key fail tone

**5** Press  or the **PTT** button, or turn the **16-Position Select** knob to exit.

## Status Calls (ASTRO 25 Trunking Only)



You can send data calls to the dispatcher about a predefined status. Each status can have up to a 12-character name. A maximum of eight status conditions is possible.



### Send a Status Call

#### Use the Menu

- 1 Press  to find STS.

STS

- 2 Press , , or  directly below STS. The last acknowledged status call, or the first status in the list, is displayed.

- 3 Press  or  to find the status you wish to send.

#### OR

Use the keypad to enter a number corresponding to the location in the status list.

- 4 Press the **PTT** button to send the status.

When the dispatcher acknowledges, four tones sound, ACK RECEIVED is displayed, and the radio returns to normal dispatch operation.

ACK RECEIVED

- Four tones

#### OR

If no acknowledgment is received, you will see NO ACKNOWLEDG and hear a low-pitched tone.

NO ACKNOWLEDG



- Single tone

- 5 Press  to go to the home display

**Note:** No traffic is heard on trunked channels while Status Calls is selected.  
If the radio detects no Status Call activity for six seconds, an alert tone sounds until  or the **PTT** button is pressed.

### Use the Preprogrammed Status Button

- 1 Press the **Status** button. The last acknowledged status call, or the first status in the list, is displayed.

- 2 Press  or  to find the status you wish to send.

**OR**

Use the keypad to enter a number corresponding to the location in the status list.

- 3 Press the **PTT** button to send the status.

When the dispatcher acknowledges, four tones sound, ACK RECEIVED is displayed, and the radio returns to normal dispatch operation.

ACK RECEIVED

- Four tones

**OR**

If no acknowledgment is received, you will see NO ACKNOWLEDG and hear a low-pitched tone.

NO ACKNOWLEDG

- Single tone

- 4 Press  to go to the home display

## Common Radio Features

---

**Note:** No traffic is heard on trunked channels while Status Calls is selected.  
If the radio detects no Status Call activity for six seconds, an alert tone sounds until the **PTT** button is pressed.

---

## Repeater or Direct Operation

Also known as “talkaround operation,” DIRECT lets you bypass the repeater and connect directly to another radio. The transmit and receive frequencies are the same.



REPEATER operation increases radio’s range by connecting with other radios through a repeater. The transmit and receive frequencies are different.

### Select Repeater or Direct Operation

#### Use the Menu

- 1 Press  to find DIR.

DIR

- 2 Press , , or  directly below DIR. You momentarily see the current operation.

- For Direct mode

DIRECT MODE  
DIR RPTR

OR

- For Repeater mode

RPTR MODE  
DIR RPTR

- 3 Press , , or  directly below DIR or RPTR.

If DIR is selected, the display shows  and DIRECT MODE.

  
DIRECT MODE

OR

Press  to exit without changing the current operation.

### Use the Preprogrammed Repeater/Direct Switch

Place the **Repeater/Direct** switch in either the **Repeater** or the **Direct** position. If DIR is selected, the display shows |+|.





## Smart PTT (Conventional Only)

Smart PTT is a per-channel, programmable feature used in conventional radio systems to keep radio users from talking over other radio conversations.

When smart PTT is enabled in your radio, you will not be able to transmit on an active channel. If you try to transmit on an active smart-PTT channel, you will hear an alert tone, and the transmission will be inhibited. The LED will also blink red to indicate that the channel is busy.

Three radio-wide variations of smart PTT are available:

Transmit Inhibit on Busy Channel with Carrier	You cannot transmit if any traffic is detected on the channel.
Transmit Inhibit on Busy Channel with Wrong Squelch Code	You cannot transmit on an active channel with a squelch code or (if secure-equipped) encryption key other than your own. If the PL code is the same as yours, the transmission will not be prevented.
Quick-Key Override	This feature can work in conjunction with either of the two above variations. You can override the transmit-inhibit state by quick-keying the radio. In other words, two <b>PTT</b> Button presses within the preprogrammed time limit.

## Common Radio Features

---

## Special Radio Features

---

### Secure Operations

Secure radio operation provides the highest commercially available level of voice security on both trunked and conventional channels. Unlike other forms of security, Motorola digital encryption provides signaling that makes it virtually impossible for others to decode any part of an encrypted message.

**Note:** Secure operation is not available in trunked analog modes.

### Select Secure Transmissions

Turn the preprogrammed **Secure/Clear** switch to the secure position (Ⓢ).



**Note:** *If the selected channel is programmed for clear-only operation* — when you press the **PTT** button, you see CLR TX ONLY, and you hear an invalid mode tone.

CLR TX ONLY

- Invalid mode tone

The radio will not transmit until you set the **Secure/Clear** switch to the clear position (○).

### Select Clear Transmissions

Turn the preprogrammed **Secure/Clear** switch to the clear position (○).

**Note:** *If the selected channel is programmed for secure-only operation* — when you press the **PTT** button, you see SEC TX ONLY, and you hear an invalid mode tone.

SEC TX ONLY

- Invalid mode tone

The radio will not transmit until you set the **Secure/Clear** switch to the secure position (Ⓢ).

## Managing Encryption

### Key Loading

Refer to the key-variable loader (KVL) manual for equipment connections and setup.

- 1 Attach the KVL to your radio. When it is attached, the display will show KEYLOADING, and all other radio functions, except for power down, backlight, and volume, will be locked out.



KEYLOADING

- 2 Press the PTT button on the KVL. This will load the encryption keys into your radio. When the key has been loaded successfully, the radio will sound a short tone for single-key radios; for multikey radios, an alternating tone will be heard.

---

### Multikey

The multikey feature allows your radio to be equipped with as many as 48 different encryption keys and supports the DES-OFB algorithm.



- **Conventional Multikey** — The encryption keys can be tied (strapped), on a one-per-channel basis, through radio service software. In addition, you can have operator-selectable keys, operator-selectable keysets, and operator-selectable key erasure. If talkgroups are enabled in conventional, then the encryption keys are strapped to the talkgroups.
- **Trunked Multikey** — If you use your radio for both conventional and trunked applications, you will have to strap your encryption keys for trunking on a per-talkgroup or announcement-group basis. In addition, you may strap a different key to other features,

such as dynamic regrouping, failsoft, or emergency talkgroup. You can have operator-selectable key erasure.



**Key Selection**

1 Press  until KEY appears on the display.

KEY

2 Press , , or  directly below KEY. The display changes to show the last user-selected and stored encryption key and the available menu selections.



HW KEY 1  
                   PSET  
 SEL                  ABRT

3 Press  or  to scroll through the encryption keys.



**OR**

Enter the number of the desired key using the keypad.

**Note:** If an erased key is selected, the key name will be alternated with ERASED KEY.

4 Press , , or  directly below the desired menu selection.

**OR**

If you selected the key via the keypad, press  or  to scroll through the menu selections:

PSET or PRESET = selects the preset or default encryption key.

SEL = saves the newly selected key and returns to the home display.

- 5** Press , the **PTT** button, the **ABRT** menu selection, or turn the **16-Position Select** knob to exit this menu.

**Note:** If the selected key is erased, **KEY FAIL** will be displayed and a momentary keyfail tone will be generated. If the selected key is not allowed, **ILLEGAL KEY** will be displayed and a momentary illegal key tone, similar to the key fail tone, will be generated.

KEY FAIL



ILLEGAL KEY

### Keyset Selection



This feature allows you to select one or more groups of several encryption keys from among the available keys stored in the radio. For example, you could have a group of three keys structured to one keyset, and another group of three different keys structured to another keyset; by changing keysets, you would automatically switch from one set of keys to the other. Every channel to which one of the original keys was tied will now have the equivalent new key instead.

- 1** Press  until **KSET** appears on the display.

KSET

- 2** Press , , or  directly below **KSET**. The display changes to show the last user-selected and stored keyset and the available keyset menu selections.

KEYSET 1  
SEL  
KS1 KS2

**3** Press , , or  directly below the desired keyset.

**OR**

Enter the number of the desired keyset using the keypad.

**4** To save the newly selected keyset, press the button directly below SEL. The radio will then exit keyset selection and return to the home display.

**Note:** Press , the **PTT** button, the ABRT menu selection, or turn the **16-Position Select** knob to exit this menu at any time without changing the keyset selection.

---



### Key Zeroization

This enables the user to erase all or selected encryption keys.

#### Use the Menu

1 Press  until the display shows ERAS.

ERAS

2 Press , , or  directly below ERAS. The display shows the last user-selected and stored encryption key, and the available menu selections:

ALL  
SNGL ABRT

ALL = erases all the encryption keys in the radio. The display shows ERS ALL KEYS and YES and NO.

ERS ALL KEYS  
YES NO



SNGL = selects the displayed encryption key to be erased. The display shows ERS SNGL KEY and YES and NO.

ERS SNGL KEY  
YES NO



ABRT = exits this menu and returns to the home display.



**Note:** Press , the PTT button, the ABRT menu selection, or turn the **16-Position Select** knob to exit this menu at any time without erasing any keys.





3 Press , , or  directly below the desired menu selection.

**OR**

Press  or  to find the desired encryption key. The display shows the selected key, and the available menu selections shown in step 2.

Press , , or  directly below the desired menu selection.

**OR**

Enter the location number of the desired key, using the keypad. The display shows the selected key, and the available menu selections shown in step 2. Press , , or  directly below the desired menu selection.

4 Press , the **PTT** button, the **ABRT** menu selection, or turn the **16-Position Select** knob to exit this menu.

**Use the Buttons**

**Note:** This is the method used for erasing the single key in radios with the single-key option, and for erasing all keys in radios with the multikey option.

- 1 With the radio on, press and hold the **Top Side** button; while holding this button down, press the **Top** button.

**Note:** **DO NOT** press the **Top** button before pressing the **Top Side** button, unless you are in an emergency situation; this would send an emergency alarm.

- 2 Before the keys are erased, the display shows PLEASE WAIT.

PLEASE WAIT

- 3 When all the encryption keys have been erased, the display shows ERASED.









ERASED

---

### Over-the-Air Rekeying (Rekey Request) (ASTRO Conventional Only)

The over-the-air rekeying (OTAR) feature allows the dispatcher to reprogram the encryption keys in the radio remotely. The dispatcher performs the rekey operation upon receiving a rekey request from the user.

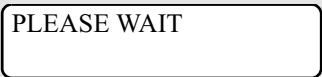
#### Use the Menu

- 1 Press  to find REKY. 
- 2 Press , , or  directly below REKY. 
- 3 Press the PTT to send the rekey request.   
**Note:** Pressing the PTT again, or the Home or Emergency button, will exit the feature and allow the user to transmit in the normal manner.
- 4 If the display shows REKEY FAIL and a bad-key tone sounds, the rekey operation has failed. 

**Note:** If this occurs, your radio does not contain the Unique Shadow Key (USK). This key must be loaded into the radio with the key-variable loader (KVL) before the rekey request can be sent. Refer to your local key management supervisor for more information.

---

## **Digital PTT ID**

### **Receive**







This feature allows you to see the radio ID number of the radio you are currently receiving. This ID can be a maximum of eight characters and can be viewed by both the receiving radio and the dispatcher.

### **Transmit**



Your radio's ID number is automatically sent every time the **PTT** button is pressed. This is a per-channel feature. For digital voice transmissions, your radio's ID is sent continuously during the voice message.

## View Your Radio's ID Number

### Use the Menu

- 1 Press  to find CALL or PAGE. 
- 2 Press , , or  directly below CALL or PAGE.
- 3 Press . 

### Use the Preprogrammed Call or Page Button

- 1 Press the **Call** or **Page** button.
  - 2 Press . 
-

## Dynamic Regrouping (Trunking Only)

The dynamic regrouping feature lets the dispatcher temporarily reassign selected radios to a single special channel so they can communicate with each other. This feature is typically used during special operations and is enabled by a qualified radio technician. You will not notice whether your radio has this feature enabled until a dynamic regrouping command is sent by the dispatcher.

**Note:** If you try to access a zone or channel that has been reserved by the dispatcher as a dynamically regrouped mode for other users, you will hear an invalid tone.

When your radio is dynamically regrouped, it automatically switches to the dynamically regrouped channel. You see the dynamically regrouped channel's name, and hear a "gurgle" tone.

Press the **PTT** button to talk; release it to listen.

When the dispatcher cancels dynamic regrouping, the radio automatically returns to the zone and channel that you were using before the radio was dynamically regrouped.



## Reprogram Request (ASTRO 25 Trunking Only)

This feature lets you notify the dispatcher that you want a new dynamic regrouping assignment.

### Use the Menu

1 Press  to find RPGM.

RPGM

2 Press , , or  directly below RPGM.

REPRGRM RQST

The reprogram request is sent to the dispatcher.

**3** If you hear *one beep*

- Press the **PTT** button to send the reprogram request again.

**OR**

- Press  to cancel and return to the home display.

**OR**

If you hear *five beeps*, the reprogram request was acknowledged by the dispatcher. Your radio returns to the home display.

**OR**

If the dispatcher does not acknowledge the reprogram request within six seconds, you see **NO ACKNOWLDG** and hear a low-pitched alert tone.

NO ACKNOWLDG

- An alert tone

Try again or press .

**Use the Preprogrammed Reprogram Request Button**

**1** Press the **Reprogram Request** button. You see **REPRGRM RQST**.

REPRGRM RQST

The reprogram request is sent to the dispatcher.

**2** If you hear *one beep* • One beep

- Press the **PTT** button to send the reprogram request again

**OR**

- Press  to hang up and return to the home display.

**OR**

If you hear *five beeps*, the reprogram request was acknowledged by the dispatcher. Your radio returns to the home display. • Five beeps

**OR**

If the dispatcher does not acknowledge the reprogram request within six seconds, you see **NO ACKNOWLEDG** and hear a low-pitched alert tone.

**NO ACKNOWLEDG**

- An alert tone

Try again or press .

---

## Select Enable / Disable

The dispatcher can classify regrouped radios into either of two categories: Select Enabled or Select Disabled.

- Select-enabled radios are free to change to any available channel, including the dynamic-regrouping channel, once the user has selected the dynamic-regrouping position.
- Select-disabled radios cannot change channels while dynamically regrouped. The dispatcher has forced the radio to remain on the dynamic-regrouping channel.

The Scan or Private Call feature cannot be selected while your radio is Select Disabled.



## Trunking System Controls

### Failsoft

The failsoft system ensures continuous radio communications during a trunked system failure. If a trunking system fails completely, the radio goes into failsoft operation and automatically switches to its failsoft channel.

During failsoft operation:

<p>Your radio transmits and receives in conventional operation on a predetermined frequency.</p>	<div style="border: 1px solid black; border-radius: 10px; padding: 5px; display: inline-block;">FAILSOFT</div>
<p>You hear a medium-pitched tone every 10 seconds.</p>	<ul style="list-style-type: none"> <li>• A medium-pitched tone</li> </ul>

When the trunking system returns to normal operation, your radio automatically leaves failsoft operation and returns to trunked operation.

### Out-of-Range

If you go out of the range of the system and can no longer lock onto a control channel:

<p>You see the currently selected zone/channel combination and OUT OF RANGE.</p>	<div style="border: 1px solid black; border-radius: 10px; padding: 5px; display: inline-block;">OUT OF RANGE</div>
<p><b>AND/OR</b></p> <p>You hear a low-pitched tone.</p>	<p><b>AND/OR</b></p> <ul style="list-style-type: none"> <li>• A tone</li> </ul>
<p>Your radio remains in this out-of-range condition until it locks onto a control channel, or it locks onto a failsoft channel, or it is turned off.</p>	<ul style="list-style-type: none"> <li>• Locks onto a control channel, or</li> <li>• Locks onto a failsoft channel, or</li> <li>• Turned off.</li> </ul>

## Site Lock



This feature allows your radio to lock onto a specific site and not roam among wide-area talkgroup sites. This feature should be used with caution, since it inhibits roaming to another site in a wide-area system.

### Lock or Unlock a Site

#### Use the Menu

- 1 Press  to find SITE.



SITE

- 2 Press , , or  directly below SITE. The current lock state is displayed.

SITE UNLOCKD  
LOCK

OR

SITE LOCKED  
LOCK

- 3 Press , , or  directly below the desired lock state, LOCK or UNLK.

- The new site lock state is saved.
- Your radio returns to the home display.

#### Use the Preprogrammed Site Lock/Unlock Button

- 1 Press the **Site Lock/Unlock** button. The current lock state is momentarily displayed.

SITE UNLOCKD  
LOCK

OR

SITE LOCKED  
LOCK

- 2 Press and hold the **Site Lock/Unlock** button to find the desired lock state, SITE UNLOCKD or SITE LOCKED.
- 

### Site Trunking

If the zone controller loses communication with any site, that site reverts to site trunking.

You see the currently selected zone/channel combination and SITE TRUNKNG.



SITE TRUNKNG

When this occurs, you can communicate only with other radios within your trunking site.

## Site View and Change

You can view the number of the current site or force your radio to change to a new one.

### View the Current Site

Press the preprogrammed **Site Search** button.



The display momentarily shows the name of the current site and its corresponding received signal strength indicator (RSSI). (See Table 4 on page 5.)

**OR**

If the radio is scanning for a new site, you momentarily see SCANING SITE.



### Change the Current Site

Press and hold down the preprogrammed **Site Search** button. You momentarily see SCANING SITE and hear a tone.



- A tone









When the radio finds a new site, it returns to the home display.

## Time and Date

Using this special feature, you can program the time and date as you might with other electronic devices. The clock display is enabled by a qualified radio technician.

- The default time setting is a 12-hour clock. 12HR 00:00AM
- If a 24-hour clock is selected, AM/PM selection is not available.
- The default setting for the domestic date shows MDY. MDY 00/00/00

### Edit the Time and Date

- 1 Press  to find CLCK. CLCK
- 2 Press , , or  directly below CLCK. The current setting is displayed. 12HR 03:54AM  
MDY 03/07/02  
EDIT
- 3 Press , , or  directly below EDIT. The first item flashes. ~~12HR 03:54AM~~  
MDY 03/07/02  
SAVE
- 4 Press  or  to change the selected item. ~~12HR 03:54AM~~  
MDY 03/07/02  
SAVE

**Note:** Press  at any time to return to the home display without saving your changes.



**OR**

## Special Radio Features

---

Press  one or more times to move to an item you wish to change.



24HR 03:54AM  
MDY 03/07/02  
SAVE

5 Press  or  to change the selected item.



24HR 03:58AM  
MDY 03/07/02  
SAVE

6 Press  one or more times to move to an item in the date field.

24HR 03:58AM  
MDY 03/07/02  
SAVE

7 Press  or  to change the selected item.

24HR 03:58AM  
MDY 03/08/02  
SAVE

8 When you have made all your changes, press , , or  directly below SAVE to save your changes and return to the home display.

**Note:** If a call arrives while the radio is in the clock-setting menu, the radio exits clock setting, your changes are lost, and the call information is displayed.

---

## Helpful Tips

---

### Radio Care



#### Caution

- The XTS 5000 radio casing has two vent ports that allow for pressure equalization in the radio. Never poke these vents with any objects, such as needles, tweezers, or screwdrivers. This could create leak paths into the radio and the radio's submergibility will be lost.
- **(For XTS 5000 R Radios Only)** The XTS 5000 R radio is designed to be submerged to a maximum depth of 6 feet, with a maximum submersion time of 4 hours. Exceeding either maximum limit may result in damage to the radio.
- **(For XTS 5000 R Radios Only)** Elastomer technology materials used for seals in rugged portable radios can age with time and environmental exposure. Therefore, Motorola recommends that rugged radios be checked annually as a preventive measure in order to assure the watertight integrity of the radio. Motorola details the disassembly, test, and reassembly procedures along with necessary test equipment needed to inspect, maintain and troubleshoot radio seals in the radio's service manual.
- If the radio battery contact area has been submerged in water, dry and clean the radio battery contacts before attaching a battery to the radio. Otherwise, the water could short-circuit the radio.



Caution

- If the radio has been submerged in water, shake the radio well so that any water that may be trapped inside the speaker grille and microphone port can be removed. Otherwise, the water will decrease the audio quality of the radio.
- Do not disassemble the radio. This could damage radio seals and result in leak paths into the radio. Any radio maintenance should be performed only by a qualified radio technician.

## Cleaning

To clean the external surfaces of your radio:

- 1 Combine one teaspoon of mild dishwashing detergent to one gallon of water (0.5% solution).
- 2 Apply the solution sparingly with a stiff, non-metallic, short-bristled brush, making sure excess detergent does not get entrapped near the connectors, controls or crevices. Dry the radio thoroughly with a soft, lint-free cloth.
- 3 Clean battery contacts with a lint-free cloth to remove dirt or grease.



Caution

**Do not use solvents to clean your radio. Spirits may permanently damage the radio housing.**

**Do not submerge the radio in the detergent solution.**



## Handling

- Do not pound, drop, or throw the radio unnecessarily. Never carry the radio by the antenna.
- Avoid subjecting the radio to an excess of liquids. Do not submerge the radio unless it is a ruggedized, XTS 5000 R model.
- Avoid subjecting the radio to corrosives, solvents or spirits.
- Do not disassemble the radio.
- Keep the accessory-connector cover in place until ready to use the connector. Replace the cover immediately once the accessory has been disconnected.

## Service

Proper repair and maintenance procedures will assure efficient operation and long life for this product. A Motorola maintenance agreement will provide expert service to keep this and all other communication equipment in perfect operating condition. A nationwide service organization is provided by Motorola to support maintenance services. Through its maintenance and installation program, Motorola makes available the finest service to those desiring reliable, continuous communications on a contract basis. For a contract service agreement, please contact your nearest Motorola service or sales representative, or an authorized Motorola dealer.

Express Service Plus (ESP) is an optional extended service coverage plan, which provides for the repair of this product for an additional period of either one or two years beyond the normal expiration date of the standard warranty. For more information about ESP, contact the Motorola Radio Support Center at 3761 South Central Avenue, Rockford, IL 61102 (800) 227-6772 / (847)725-4200.

## **Battery**

### **Battery Life**

Battery life is determined by several factors. Among the more critical are the regular overcharge of batteries and the average depth of discharge with each cycle. Typically, the greater the overcharge and the deeper the average discharge, the fewer cycles a battery will last. For example, a battery which is overcharged and discharged 100% several times a day, will last fewer cycles than a battery that receives less of an overcharge and is discharged to 50% per day. Further, a battery which receives minimal overcharging and averages only 25% discharge, will last even longer.

### **Charging the Battery**

Motorola batteries are designed specifically to be used with a Motorola charger and vice-versa. Charging in non-Motorola equipment may lead to battery damage and void the battery warranty. Motorola-authorized battery chargers may not charge batteries other than the ones listed on page 105.

The battery should be at about 77°F (25°C) (room temperature), whenever possible. Charging a cold battery (below 50° F [10°C]) may result in leakage of electrolyte and ultimately in failure of the battery. Charging a hot battery (above 95°F [35°C]) results in reduced discharge capacity, affecting the performance of the radio. Motorola rapid-rate battery chargers contain a temperature-sensing circuit to ensure that batteries are charged within the temperature limits stated above.

### **Battery Charge Status**

Your radio can indicate your battery's charge status through:

- LED and sounds
- conventional fuel gauge symbol on the display
- smart fuel gauge symbol on the display

**LED and Sounds**

When your battery is low:





- you see the LED flash red when the **PTT** button is pressed
- you hear a low-battery “chirp” (short, high-pitched tone)

**Conventional Fuel Gauge Symbol**

A flashing fuel gauge symbol () is displayed only when the battery voltage drops to low level. In this case, replace the battery with a fully charged one.

**Smart Fuel Gauge Symbol**

Consult the Smart Battery manual. All conditions must be met for a battery to be classified as a “Smart Battery.” When your radio has a Smart Battery installed, the fuel gauge symbol is always displayed.

<b>Gauge shows</b>	<b>if the battery's charge is</b>
	71% to 100% full
	41% to 70%
	11% to 40%
	10% or less (at 10%, the gauge begins flashing)

Replace the battery with a fully charged one when the fuel gauge shows the lowest level.

**Battery Recycling and Disposal**

Nickel-cadmium (NiCd) rechargeable batteries can be recycled. However, recycling facilities may not be available in all areas. Under various U.S. state laws and the laws of several other countries, NiCd batteries must be recycled and cannot be disposed of in landfills or incinerators. Contact your local waste management agency for specific requirements and information in your area.

Motorola fully endorses and encourages the recycling of NiCd batteries. In the U.S. and Canada, Motorola participates in the

#### Helpful Tips

---

nationwide Rechargeable Battery Recycling Corporation (RBRC) program for NiCd battery collection and recycling. Many retailers and dealers participate in this program.

For the location of the drop-off facility closest to you, access RBRC's Internet web site at [www.rbrc.com](http://www.rbrc.com) or call 1-800-8-BATTERY. This internet site and telephone number also provide other useful information concerning recycling options for consumers, businesses, and governmental agencies.

## Antenna

### Radio Operating Frequencies

Before installing the antenna, make sure it matches your radio's operating frequency. Antennas are frequency sensitive and are color coded according to their frequency range. The color code indicator is located in the center of the antenna's base.



Color Code

The following antenna types are compatible with your radio:

<i>Antenna Type</i>	<i>Approx. Length</i>		<i>Insulator Color Code</i>	<i>Frequency Range</i>	<i>Antenna Kit No.</i>
	<i>in.</i>	<i>mm</i>			
VHF Helical	8	203	RED	136-174 MHz	NAD6563
VHF Helical	7.6	193	YELLOW	136-150.8 MHz	NAD6566
VHF Helical	7	178	BLACK	150.8-162 MHz	NAD6567
VHF Helical	6.5	165	BLUE	162-174 MHz	NAD6568
UHF Helical	3.4	88	RED	380-435 MHz	NAE6546
UHF Helical	3.2	80	GREEN	435-470 MHz	NAE6547
UHF Helical	3.1	79	BLACK	470-512 MHz	NAE6548
UHF Whip, Wideband	5.2	130	GRAY	380-520 MHz	NAE6549
800MHz Whip, Halfwave	7	178	RED	806-870 MHz	NAF5037

Helpful Tips

---

<b>Antenna Type</b>	<b>Approx. Length</b>		<b>Insulator Color Code</b>	<b>Frequency Range</b>	<b>Antenna Kit No.</b>
	<b>in.</b>	<b>mm</b>			
800MHz Stubby, Quarterwave	3.4	86	WHITE	806-870 MHz	NAF5042
700/800MHz Whip	7	178	GREEN	764-870 MHz	NAF5080

## Accessories

---

Motorola provides the following approved accessories to improve the productivity of your XTS 5000 portable two-way radio.

### Antennas

NAD6563	136-174 MHz helical
NAD6566	136-150.8 MHz helical
NAD6567	150.8-162 MHz helical
NAD6568	162-174 MHz helical
NAE6546	380-435 MHz helical
NAE6547	435-470 MHz helical
NAE6548	470-512 MHz helical
NAE6549	380-520 MHz wideband whip
NAF5037	800 MHz whip, halfwave (806-870 MHz)
NAF5042	800 MHz stubby, quarterwave (806-870 MHz)
NAF5080	700/800 MHz whip (764-870 MHz)

### Batteries and Battery Accessories

HNN9031	1525 mAh NiCd impres™ (non-FM)
HNN9032	1525 mAh NiCd impres™ Intrinsically Safe (FM)
NNTN4435	1800 mAh NiMH impres™ (non-FM)
NNTN4436	1750 mAh NiMH impres™ Intrinsically Safe (FM)
NNTN4437	1750 mAh NiMH impres™ Intrinsically Safe (FM) Ruggedized
NTN9862	2000 mAh impres™ Li Ion
NTN8294	1525 mAh NiCd (non FM)
NTN8295	1525 mAh NiCd Intrinsically Safe (FM)

## Accessories

NTN8297	1525 mAh NiCd Intrinsically Safe (FM) Ruggedized
NTN8299	1700 mAh NiMH Intrinsically Safe (FM)
NTN8610	1650 mAh Li Ion
NTN8923	1800 mAh NiMH ultra-capacity (non FM)
RNN4006	3000 mAh NiMH (non FM)
RNN4007	3000 mAh NiMH Intrinsically Safe (FM)
NTN9177	Battery holder, clamshell, black (requires 12AA alkaline batteries)
NTN9183	Battery holder, clamshell, orange (requires 12AA alkaline batteries)

## Carry Accessories

### Belt Clips

NTN8266	Belt clip kit, 2.25", plastic (compatible with clamshell batteries)
NTN8460	Public Safety belt clip, 3.0", metal (VHF use only)
NTN9179	Combo, high-activity D clip (NTN9212) and high-activity belt loop (NTN9213)
NTN9212	D clip, high-activity, swivel (for use with NTN9213)

### Belt Loops

NTN8039	Swivel belt loop, 2.5" (for use only with the high-activity leather swivel snap carry cases)
NTN8040	Belt loop, swivel, leather, 3.0", high-activity (for use only with the high-activity leather swivel snap carry cases)
NTN8383	T-strap, plain, action snaps
NTN9213	Belt loop, 2.5", high-activity, D clip



## Carry Cases

NTN8380	Case, hard leather high-activity (includes swivel belt loop and T-strap), 2.5" belt loop, for Model II and III radios
NTN8381	Case, hard leather high-activity (includes swivel belt loop and T-strap), 3.0" belt loop, for Model II and III radios
NTN8382	Case (includes belt loop and T-strap), for Model II and III radios
NTN8385	Case, hard leather high-activity (includes swivel belt loop and T-strap), 2.5" belt loop, for Model I radio
NTN8386	Case, hard leather high-activity (includes swivel belt loop and T-strap), 3.0" belt loop, for Model I radio
NTN8387	Leather case (includes belt loop and T-strap), for Model I radio
NTN8725	Nylon carry case with belt loop and T-strap
NTN9184	Leather case (includes belt loop), for clamshell battery

## Chargers

NTN1667	Single-unit, tri-chemistry, rapid rate, 110 V
NTN1668	Single-unit, tri-chemistry, rapid rate, 230 V (2-prong Euro plug)
NTN1669	Single-unit, tri-chemistry, rapid rate, 230 V (3-prong UK plug)
WPLN4108	impres™ multi-unit, tri-chemistry, 110 V (US, NA plug)
WPLN4111	impres™ single-unit, tri-chemistry, 110 V
WPLN4130	impres™ multi-unit, tri-chemistry, with display (US, NA plug)

---

## Surveillance Accessories

### Earpieces

BDN6664	Earpiece with standard earphone, beige
BDN6665	Earpiece with extra-loud earphone (exceeds OSHA limits), beige
BDN6666	Earpiece with volume control, beige
BDN6667	Earpiece, mic and PTT combined, beige
BDN6668	Earpiece, mic and PTT separate, beige
BDN6669	Earpiece, mic and PTT combined, with extra-loud earphone (exceeds OSHA limits), beige
BDN6670	Earpiece, mic and PTT separate with extra-loud earphone (exceeds OSHA limits), beige
BDN6726	Earpiece with standard earphone, black
BDN6727	Earpiece with extra-loud earphone (exceeds OSHA limits), black
BDN6728	Earpiece with volume control, black
BDN6729	Earpiece, mic and PTT combined, black
BDN6730	Earpiece, mic and PTT separate, black
BDN6731	Earpiece, mic and PTT combined, with extra-loud earphone (exceeds OSHA limits), black
BDN6732	Earpiece, mic and PTT separate, with extra-loud earphone (exceeds OSHA limits), black
BDN6780	Earbud, single with mic and PTT combined, beige
BDN6781	Earbud, single, receive only, black

## Headsets and Headset Accessories

BDN6635	Heavy-duty VOX headset with noise-canceling boom mic (requires BDN6673 adapter)
BDN6636	Heavy-duty VOX headset with throat mic (requires BDN6673 adapter cable)
BDN6645	Noise-canceling boom mic headset with PTT on earcup
BDN6673	Headset adapter cable (for use with BDN6635, BDN6636, and BDN6645)
BDN6676	3.0 mm threaded adapter jack
NMN1020	Safety helmet headset (requires BDN6676 adapter cable)
NMN6245	Light-weight headset
NMN6246	Ultralite headset with boom mic
NMN6258	Over-the-head headset with in-line PTT
NMN6259	Medium-weight, dual headset with NC mic
NTN8613	Keyload adapter
RMN4049	Temple Transducer

## Radio Interface Modules for Ear Microphones

BDN6641	Ear mic, high noise level up to 105 dB, grey (must order interface module separately)
BDN6677	Ear mic, standard, noise up to 95 dB (must order interface module separately), black
BDN6678	Ear mic, standard, noise up to 95 dB (must order interface module separately), beige
BDN6671	Push-to-talk (PTT) and voice-activated (VOX) interface module (for use with BDN6641, BDN6677, and BDN6678)

## Accessories

---

BDN6708	PTT interface module (for use with BDN6641, BDN6677, and BDN6678)
---------	---

## Speaker, Remote Speaker and Public Safety Microphones

NMN6191	RSM noise-canceling (includes 6.0' coiled cord assembly, 3.5mm earjack, swivel clip, quick disconnect)
NMN6193	Remote speaker mic
NMN6247*	Public safety mic with straight cord, 30"
NMN6250*	Public safety mic with straight cord, 24"
NMN6251*	Public safety mic with straight cord, 18"
RMN5021	Commander, smart remote speaker mic
RMN5023	Commander, submersible smart remote speaker mic

*\* For XTS 5000 UHF Range 1 radio models. Use only approved antennas NAE6547 or NAE6549 with these microphones.*

## CommPort Integrated Microphone/Receivers

NTN1624	CommPort with palm PTT
NTN1625	CommPort ear mic with PTT for noise levels up to 100 dB (requires BDN6676 adapter)
NTN1663	CommPort ear mic with ring PTT for noise levels up to 100 dB (requires BDN6676 adapter)
NTN1736	CommPort ear mic with snap-on side PTT for noise levels up to 100 dB (requires BDN6676 adapter)
NNTN4186	CommPort ear mic receiver w/ body PTT

## Switches

0180300E83	Remote PTT body switch for EMS
NTN7660	Tilt / man down switch
NTN8327	External RF switch

## Vehicular Adapters

### Accessories

HMN4069	Next-generation mobile mic
HSN1006	Speaker, 6-watt
NKN6455	Cable, 6-watt speaker
NTN1606	Vehicular adapter, BNC, open face
NTN1607	Vehicular adapter, BNC, closed face
NTN8560	Vehicular adapter, mini-U, open face
NTN8561	Vehicular adapter, mini-U, closed face
NTN8940	Vehicular adapter, trunnion mount
NTN9176	Vehicular charger, XTS, tri-chemistry, compatible with PAC•RT
PLN7737	Handheld control head
RLN4884	XTS travel charger (uses cigarette lighter adapter)

Accessories

---

## Notes

## Glossary

---

This glossary is a list of specialized terms used in this manual.



<b>ACK</b>	Acknowledgment of communication.
<b>Active Channel</b>	A channel that has traffic on it.
<b>Analog Signal</b>	An RF signal that has a continuous nature rather than a pulsed or discrete nature.
<b>ASTRO 25 Trunking</b>	Motorola standard for wireless digital trunked communications.
<b>ASTRO Conventional</b>	Motorola standard for wireless analog or digital conventional communications.
<b>Autoscan</b>	A feature that allows the radio to automatically scan the members of a scan list.
<b>Call Alert</b>	Privately page an individual by sending an audible tone.
<b>Carrier Squelch</b>	Feature that responds to the presence of an RF carrier by opening or unmuting (turning on) a receiver's audio circuit. A squelch circuit silences the radio when no signal is being received so that the user does not have to listen to "noise."
<b>Central Controller</b>	A software-controlled, computer-driven device that receives and generates data for the trunked radios assigned to it. It monitors and directs the operations of the trunked repeaters.
<b>Channel</b>	A group of characteristics such as transmit/receive frequency pairs, radio parameters, and encryption encoding.
<b>Control Channel</b>	In a trunking system, one of the channels that is used to provide a continuous, two-way/data communications path between the central controller and all radios on the system.

## Glossary

---

<b>Conventional</b>	Typically refers to radio-to-radio communications, sometimes through a repeater (see Trunking).
<b>Conventional Scan List</b>	A scan list that includes only conventional channels.
<b>Cursor</b>	A visual tracking marker (a blinking line) that indicates a location on the display.
<b>Deadlock</b>	Displayed by the radio after three failed attempts to unlock the radio. The radio must be powered off and on prior to another attempt.
<b>Digital Private Line (DPL)</b>	A type of coded squelch using data bursts. Similar to PL except a digital code is used instead of a tone.
<b>Digital Signal</b>	An RF signal that has a pulsed, or discrete, nature, rather than a continuous nature.
<b>Dispatcher</b>	An individual who has radio system management duties.
<b>Dynamic Regrouping</b>	A feature that allows the dispatcher to temporarily reassign selected radios to a single special channel so they can communicate with each other.
<b>Failsoft</b>	A feature that allows communications to take place even though the central controller has failed. Each trunked repeater in the system will transmit a data word informing every radio that the system has gone into failsoft.
<b>FCC</b>	Federal Communications Commission.
<b>Hang Up</b>	Disconnect.
<b>Home Display</b>	The first display information after the radio completes its self test.



<b>KVL</b>	Key-variable loader: A device for loading encryption keys into the radio.
<b>LCD</b>	Liquid crystal display.
<b>LED</b>	Light-emitting diode.
<b>Menu Entry</b>	A software-activated feature shown at the bottom of the display — selection of these features is controlled by the  ,  , and  buttons.
<b>Monitor</b>	Check channel activity by pressing the Monitor button. If the channel is clear, you will hear static. If the channel is in use, you will hear conversation. It also serves as a way to check the volume level of the radio, since the radio will “open the squelch” when pressing the monitor button.
<b>Network Access Code</b>	Network Access Code (NAC) operates on digital channels to reduce voice channel interference between adjacent systems and sites.
<b>NiCd</b>	Nickel-cadmium
<b>NiMH</b>	Nickel-metal-hydride.
<b>Non-tactical/Revert</b>	The user will talk on a preprogrammed emergency channel. The emergency alarm is sent out on this same channel.
<b>OTAR</b>	Over-the-air rekeying.
<b>Page</b>	A one-way alert, with audio and/or display messages.
<b>Personality</b>	A set of unique features specific to a radio.
<b>Preprogrammed</b>	Refers to a software feature that has been activated by a qualified radio technician.

## Glossary

---

<b>Private (Conversation) Call</b>	A feature that lets you have a private conversation with another radio user in the group.
<b>Private Line (PL)</b>	A sub-audible tone that is transmitted such that only receivers decoding the tone will receive it.
<b>Programmable</b>	Refers to a radio control that can have a radio feature assigned to it.
<b>PTT</b>	Push-To-Talk — the <b>PTT button</b> engages the transmitter and puts the radio in transmit (send) operation when pressed.
<b>Radio Frequency (RF)</b>	The part of the general frequency spectrum between the audio and infrared light regions (about 10 kHz to 10,000,000 MHz).
<b>Repeater</b>	A conventional radio feature, where you talk through a receive/transmit facility that re-transmits received signals, in order to improve communications range and coverage.
<b>Selective Call</b>	A feature that allows you to call a select individual, intended to provide privacy and to eliminate the annoyance of having to listen to conversations of no interest to you.
<b>Selective Switch</b>	Any digital P25 traffic having the correct Network Access Code and the correct talkgroup.
<b>Squelch</b>	Special electronic circuitry, added to the receiver of a radio, that reduces, or cuts off, unwanted signals before they are heard in the speaker.
<b>Standby</b>	An operating condition whereby the radio's speaker is muted but still continues to receive data.

---

<b>Status Calls</b>	Pre-defined text messages that allow the user to send a conditional message without talking.
<b>Tactical/Non-revert</b>	The user will talk on the channel that was selected before the radio entered the emergency state.
<b>Talkaround</b>	Bypass a repeater and talk directly to another unit for easy local unit-to-unit communications.
<b>Talkgroup</b>	An organization or group of radio users who communicate with each other using the same communication path.
<b>Talkgroup Scan List</b>	A scan list that can include both talkgroups (trunked) and channels (conventional).
<b>Trunking</b>	The automatic sharing of communications paths between a large number of users (see Conventional).
<b>Trunking Priority Monitor Scan List</b>	A scan list that includes talkgroups that are all from the same trunking system.
<b>USK</b>	Unique Shadow Key.
<b>Zone</b>	A grouping of channels.

Glossary

---

## Notes

# Commercial Warranty

---

## Limited Warranty

### MOTOROLA COMMUNICATION PRODUCTS

#### I. WHAT THIS WARRANTY COVERS AND FOR HOW LONG:

MOTOROLA INC. ("MOTOROLA") warrants the MOTOROLA manufactured Communication Products listed below ("Product") against defects in material and workmanship under normal use and service for a period of time from the date of purchase as scheduled below:

ASTRO XTS 5000 Portable Units	One (1) Year
Product Accessories	One (1) Year

Motorola, at its option, will at no charge either repair the Product (with new or reconditioned parts), replace it (with a new or reconditioned Product), or refund the purchase price of the Product during the warranty period provided it is returned in accordance with the terms of this warranty. Replaced parts or boards are warranted for the balance of the original applicable warranty period. All replaced parts of Product shall become the property of MOTOROLA.

This express limited warranty is extended by MOTOROLA to the original end user purchaser only and is not assignable or transferable to any other party. This is the complete warranty for the Product manufactured by MOTOROLA. MOTOROLA assumes no obligations or liability for additions or modifications to this warranty unless made in writing and signed by an officer of MOTOROLA. Unless made in a separate agreement between MOTOROLA and the original end user purchaser, MOTOROLA does not warrant the installation, maintenance or service of the Product.

MOTOROLA cannot be responsible in any way for any ancillary equipment not furnished by MOTOROLA which is attached to or used in connection with the Product, or for operation of the Product with any ancillary equipment, and all such equipment is expressly excluded from this warranty. Because each system which may use

the Product is unique, MOTOROLA disclaims liability for range, coverage, or operation of the system as a whole under this warranty.

**II. GENERAL PROVISIONS:**

This warranty sets forth the full extent of MOTOROLA'S responsibilities regarding the Product. Repair, replacement or refund of the purchase price, at MOTOROLA's option, is the exclusive remedy. THIS WARRANTY IS GIVEN IN LIEU OF ALL OTHER EXPRESS WARRANTIES. IMPLIED WARRANTIES, INCLUDING WITHOUT LIMITATION, IMPLIED WARRANTIES OF MERCHANTABILITY AND FITNESS FOR A PARTICULAR PURPOSE, ARE LIMITED TO THE DURATION OF THIS LIMITED WARRANTY. IN NO EVENT SHALL MOTOROLA BE LIABLE FOR DAMAGES IN EXCESS OF THE PURCHASE PRICE OF THE PRODUCT, FOR ANY LOSS OF USE, LOSS OF TIME, INCONVENIENCE, COMMERCIAL LOSS, LOST PROFITS OR SAVINGS OR OTHER INCIDENTAL, SPECIAL OR CONSEQUENTIAL DAMAGES ARISING OUT OF THE USE OR INABILITY TO USE SUCH PRODUCT, TO THE FULL EXTENT SUCH MAY BE DISCLAIMED BY LAW.

**III. STATE LAW RIGHTS:**

SOME STATES DO NOT ALLOW THE EXCLUSION OR LIMITATION OF INCIDENTAL OR CONSEQUENTIAL DAMAGES OR LIMITATION ON HOW LONG AN IMPLIED WARRANTY LASTS, SO THE ABOVE LIMITATION OR EXCLUSIONS MAY NOT APPLY.

This warranty gives specific legal rights, and there may be other rights which may vary from state to state.

**IV. HOW TO GET WARRANTY SERVICE:**

You must provide proof of purchase (bearing the date of purchase and Product item serial number) in order to receive warranty service and, also, deliver or send the Product item, transportation and insurance prepaid, to an authorized warranty service location. Warranty service will be provided by Motorola through one of its authorized warranty service locations. If you first contact the company

which sold you the Product, it can facilitate your obtaining warranty service. You can also call Motorola at 1-888-567-7347 US/Canada.

**V. WHAT THIS WARRANTY DOES NOT COVER:**

- A) Defects or damage resulting from use of the Product in other than its normal and customary manner.
- B) Defects or damage from misuse, accident, water, or neglect.
- C) Defects or damage from improper testing, operation, maintenance, installation, alteration, modification, or adjustment.
- D) Breakage or damage to antennas unless caused directly by defects in material workmanship.
- E) A Product subjected to unauthorized Product modifications, disassemblies or repairs (including, without limitation, the addition to the Product of non-Motorola supplied equipment) which adversely affect performance of the Product or interfere with Motorola's normal warranty inspection and testing of the Product to verify any warranty claim.
- F) Product which has had the serial number removed or made illegible.
- G) Rechargeable batteries if:
  - any of the seals on the battery enclosure of cells are broken or show evidence of tampering.
  - the damage or defect is caused by charging or using the battery in equipment or service other than the Product for which it is specified.
- H) Freight costs to the repair depot.
- I) A Product which, due to illegal or unauthorized alteration of the software/firmware in the Product, does not function in accordance with MOTOROLA's published specifications or the FCC type acceptance labeling in effect for the Product at

the time the Product was initially distributed from  
MOTOROLA.

- J) Scratches or other cosmetic damage to Product surfaces that does not affect the operation of the Product.
- K) Normal and customary wear and tear.

**VI. PATENT AND SOFTWARE PROVISIONS:**

MOTOROLA will defend, at its own expense, any suit brought against the end user purchaser to the extent that it is based on a claim that the Product or parts infringe a United States patent, and MOTOROLA will pay those costs and damages finally awarded against the end user purchaser in any such suit which are attributable to any such claim, but such defense and payments are conditioned on the following:

- A) that MOTOROLA will be notified promptly in writing by such purchaser of any notice of such claim;
- B) that MOTOROLA will have sole control of the defense of such suit and all negotiations for its settlement or compromise; and
- C) should the Product or parts become, or in MOTOROLA's opinion be likely to become, the subject of a claim of infringement of a United States patent, that such purchaser will permit MOTOROLA, at its option and expense, either to procure for such purchaser the right to continue using the Product or parts or to replace or modify the same so that it becomes non-infringing or to grant such purchaser a credit for the Product or parts as depreciated and accept its return. The depreciation will be an equal amount per year over the lifetime of the Product or parts as established by MOTOROLA.

MOTOROLA will have no liability with respect to any claim of patent infringement which is based upon the combination of the Product or parts furnished hereunder with software, apparatus or devices not furnished by MOTOROLA, nor will MOTOROLA have any liability for



the use of ancillary equipment or software not furnished by MOTOROLA which is attached to or used in connection with the Product. The foregoing states the entire liability of MOTOROLA with respect to infringement of patents by the Product or any parts thereof.

Laws in the United States and other countries preserve for MOTOROLA certain exclusive rights for copyrighted MOTOROLA software such as the exclusive rights to reproduce in copies and distribute copies of such Motorola software. MOTOROLA software may be used in only the Product in which the software was originally embodied and such software in such Product may not be replaced, copied, distributed, modified in any way, or used to produce any derivative thereof. No other use including, without limitation, alteration, modification, reproduction, distribution, or reverse engineering of such MOTOROLA software or exercise of rights in such MOTOROLA software is permitted. No license is granted by implication, estoppel or otherwise under MOTOROLA patent rights or copyrights.

**VII. GOVERNING LAW:**

This Warranty is governed by the laws of the State of Illinois, USA.

Commercial Warranty

---

## Notes

# Index

---

## Numerics

4-way navigation button ..... 9

## A

accessories ..... 105  
alert tones ..... 11  
antenna ..... 17  
    radio operating frequencies ... 103  
antennas ..... 105  
App button ..... 8  
attach  
    antenna ..... 17  
    battery ..... 15  
    belt clip ..... 18  
    universal connector cover ..... 19

## B

backlight ..... 5  
batteries and battery  
    accessories ..... 105  
battery ..... 14  
    charge status  
        conventional fuel gauge  
            symbol ..... 101  
        LED and sounds ..... 101  
        smart fuel gauge symbol ... 101  
    charger ..... 14  
    charging the battery ..... 100  
    life ..... 100  
    recycling and disposal ..... 101  
belt clip ..... 18

## C

call alert paging  
    answer a call alert page ..... 66  
    initiate a call alert page ..... 67  
    quick access (one-touch) ..... 65  
    select an ID number  
        use the keypad ..... 68  
        use the menu ..... 68  
    send a call alert page ..... 68  
carry accessories

    belt clips ..... 106  
    belt loops ..... 106  
    carry cases ..... 107  
charging the battery ..... 14  
common radio features ..... 27  
conventional  
    mode operation ..... 26  
    squelch operation  
        analog options ..... 33  
        digital options ..... 33  
talkgroup calls  
    select a talkgroup ..... 70

## D

digital PTT ID  
    receive ..... 86  
    transmit ..... 86  
display ..... 4  
dynamic regrouping ..... 88

## E

edit  
    call, page, or phone list name . 42  
    call, page, or phone list number 41  
scan list  
    change the scan list status  
        only ..... 48  
    use the menu ..... 43  
    use the menu and the  
        preprogrammed select  
        button ..... 45  
    use the preprogrammed scan list  
        programming switch and the  
        menu ..... 47  
edit the date and time ..... 95  
emergency  
    keep alive ..... 39  
    send a silent emergency alarm 38  
    send an emergency alarm ..... 36  
    send an emergency call ..... 37  
enable or disable the radio lock  
    feature (secure radios only) ..... 31  
encryption

## Index

---

- key loading .....78
- key selection .....79
- key zeroization .....82
  - use the buttons .....84
  - use the menu .....82
- keyset selection .....80
- managing .....78
- multikey .....78
- OTAR .....85
  - use the menu .....85
  
- F**
- failsoft .....91
  
- G**
- general radio operation .....1
- glossary .....113
  
- H**
- helpful tips .....97
- home button .....8
  
- L**
- LED indicators .....10
- lists .....40
  - scan list empty .....40
  - view a list .....40
- lock or unlock a site
  - use the menu .....92
  - use the preprogrammed site lock/  
unlock button .....92
  
- M**
- menu
  - entry (softkey) .....7
  - entry features .....8
  - select buttons .....7
- mute or unmute keypad tones
  - use the menu .....32
  - use the preprogrammed keypad  
mute button .....32
  
- N**
- notations used in this manual ..... 1
  
- O**
- out-of-range ..... 91
  
- P**
- phone call display and alert
  - prompts ..... 57
- physical features of the XTS 5000
  - model III radio ..... 3
- PL defeat ..... 34
- private calls ..... 58
  - answer a private call ..... 59
  - initiate ..... 59
  - make a private call ..... 61
  - quick access (one-touch) ..... 58
  - select an ID number
    - use the keypad ..... 60
    - use the menu ..... 60
- programmable controls ..... 3
  
- R**
- radio
  - care
    - cleaning ..... 98
    - handling ..... 99
    - things to avoid ..... 97
  - lock
    - change your password ..... 30
    - unlock your radio ..... 29
  - on and off ..... 20
  - receive / transmit
    - use preprogrammed monitor  
button ..... 25
    - use preprogrammed volume set  
button ..... 24
    - without using volume set and  
monitor buttons ..... 24
  - remove
    - antenna ..... 17
    - battery ..... 15

- 
- belt clip ..... 18
  - universal connector cover ..... 19
  - repeater or direct operation ..... 74
  - reprogram request ..... 88
    - use the preprogrammed reprogram request button ..... 89
  - request a new dynamic regrouping using the menu ..... 88
- S**
- scan
    - delete a nuisance channel ..... 52
  - scan (conventional only)
    - make a dynamic priority change ..... 53
  - secure operations ..... 77
  - secure or clear transmissions ..... 77
  - select
    - a channel
      - method 1: use the 16-position select knob ..... 22
      - method 2: use the menu ..... 22
    - a zone
      - use the menu ..... 21
      - use the preprogrammed zone switch ..... 21
    - clear transmissions ..... 77
    - enable / disable ..... 90
    - repeater or direct operation
      - use the menu ..... 74
      - use the preprogrammed repeater/direct switch ..... 75
    - secure transmissions ..... 77
  - selectable power level
    - use the menu ..... 27
    - use the preprogrammed transmit power level switch ..... 28
  - selective calls
    - answer a private call ..... 62
    - initiate ..... 63
    - make a selective call ..... 64
    - quick access (one-touch) ..... 62
    - select an ID number
      - use the keypad ..... 64
      - use the menu ..... 63
- send
- a status call
    - use the menu ..... 72
    - use the preprogrammed status button ..... 73
- service ..... 99
- site
- lock ..... 92
  - trunking ..... 93
  - view and change
    - change the current site ..... 94
    - view the current site ..... 94
- smart
- battery condition
    - use the menu ..... 16
    - use the preprogrammed smart battery button ..... 16
  - PTT (conventional only) ..... 76
- special radio features ..... 77
- standard accessories ..... 14
- status
- calls ..... 72
  - symbols ..... 5
- surveillance accessories ..... 108
- CommPort integrated microphone/receivers ..... 110
  - earpieces ..... 108
  - headsets and headset accessories ..... 109
  - radio interface modules for ear microphones ..... 109
  - speaker, remote speaker and public safety microphones ... 110
- switches ..... 111
- T**
- telephone calls
    - answer a phone call ..... 55
    - initiate ..... 55
    - make a phone call ..... 56
    - quick access (one-touch) ..... 54

## Index

---

- select a phone number
  - use the keypad .....56
  - use the menu .....56
- time-out timer .....35
- trunking system controls .....91
- turn
  - scan on or off
    - use the menu .....51
    - use the preprogrammed scan on/off switch .....51
  - the radio off .....20
  - the radio on .....20
- U**
  - universal connector cover .....19
- V**
  - vehicular adaptors
    - accessories ..... 111
  - view your radio's ID number
    - use the menu ..... 87
    - use the preprogrammed call or page button ..... 87
- W**
  - warranty ..... 119
- Y**
  - your XTS 5000 model III radio .....2
- Z**
  - zones and channels .....21





Motorola, Inc.  
8000 West Sunrise Boulevard  
Ft. Lauderdale, FL 33322

MOTOROLA, the Stylized M Logo, and ASTRO are registered  
in the U.S. Patent and Trademark Office. All other product or  
service names are the property of their respective owners.  
© Motorola, Inc. 2001, 2002, and 2003.  
All rights reserved. Printed in U.S.A.



**6881094C25-E**