

ASTRO Digital XTS 2500 Model III User Guide

68P81095C05-0

Document Creation Date: 5/2/01
Document Modification Date: 8/23/01

Preface

Before operating your radio, please review the “Safety and General Information” section in the front of this user guide. Also, be sure to retain this publication for future reference.

Computer Software Copyrights

The Motorola products described in this manual may include copyrighted Motorola computer programs stored in semiconductor memories or other media. Laws in the United States and other countries preserve for Motorola certain exclusive rights for copyrighted computer programs, including, but not limited to, the exclusive right to copy or reproduce in any form the copyrighted computer program. Accordingly, any copyrighted Motorola computer programs contained in the Motorola products described in this manual may not be copied, reproduced, modified, reverse-engineered, or distributed in any manner without the express written permission of Motorola. Furthermore, the purchase of Motorola products shall not be deemed to grant either directly or by implication, estoppel, or otherwise, any license under the copyrights, patents or patent applications of Motorola, except for the normal non-exclusive license to use that arises by operation of law in the sale of a product.

ASTRO Digital XTS 2500 Model III Radio

Quick Reference Card

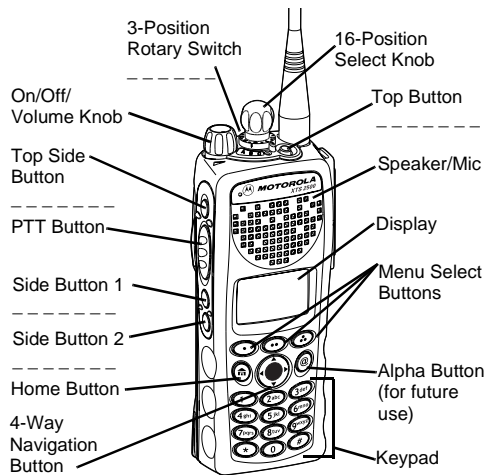

Write your radio's programmed features on the dotted lines.

Select a Zone Using the Menu

- 1 Press until
- 2 Press , , or directly below ZONE.
- 3 Press until the zone you desire is shown.
- 4 Press to confirm, or press PTT to transmit.

Select a Channel

Method 1: Using the Select Knob

After selecting the desired zone, turn the 16-position Select Knob to the desired channel.

Method 2: Using the Menu

- 1 Press until
- 2 Press , , or directly below CHAN.
- 3 Press until channel you desire is shown.
- 4 Press to confirm, or press PTT to transmit.

Send an Emergency Alarm

- 1 Radio on and press **Emergency** button. You see red LED; you hear short, medium-pitched tone.
- 2 Display shows
- 3 When acknowledgment is received, you hear four beeps; alarm ends; radio exits emergency.

Send Silent Emergency Alarm

- 1 Radio on and press **Emergency** button. You see no LED; you hear no tone.
- 2 Press **PTT**.

- 3 Alarm continues until you exit by:
 - Press and hold **Emergency** button**OR**
 - Press **PTT** again.

Send an Emergency Call

- 1 Radio on and press preprogrammed Emergency button.
- 2 Press and hold PTT button. Announce your emergency into the microphone.
- 3 Release PTT to end the call.





Answer a Phone Call

- 1 Phone-like ringing, LED flashes GREEN, PHONE CALL and are displayed
- 2 Press Call Response button.
- 3 Press PTT button to talk; release to listen
- 4 Press to hang up.

Send a Phone Call

- 1 Press until
- 2 Press , , or directly below PHON.
- 3 Press or to scroll to phone number.
- 4 Press PTT (or Quick Access button, if programmed) to talk, release to listen.

Display Status Symbols

H L	Power Level. Power Level. H = high power; L = low power
	Call Received. Receiving an individual call
	View/Program Mode. The radio is in the view or program mode; On Steady = view mode; Flashing = program mode
	Received Signal Strength Indication (RSSI). Received signal strength for the current site (trunking only). The more stripes in the symbol, the stronger the signal.
	Battery <ul style="list-style-type: none"> Conventional = Flashes when the battery is low. Smart = The number of bars (0-3) shown indicates the charge remaining in your battery.
→	Talkaround. You are talking directly to another radio or through a repeater; On = direct; Off = repeater
▷	Monitor (Carrier Squelch). This channel is being monitored.
↻	Scan. The radio is scanning a scan list
⚠	The radio is in Emergency state

Menu Entries (Use With Menu Navigation)

Entry	Menu Selection	Page
BATT	Smart Battery	26
CALL	Private Call	69
RADIO LOCK	Radio Lock	43
MUTE	Keypad Mute	45
CHAN	Select a Channel	34
DIR	Repeater/Direct	77
PAGE	Call Alert Page	71
PHON	Phone	65

Entry	Menu Selection	Page
PWR	TX Power Level	41
SCAN	Scan On/Off	62
SITE	Site Lock	81
STS	Status Call	75
VIEW	Viewing a List	54
ZONE	Select a Zone	33

Menu Navigation

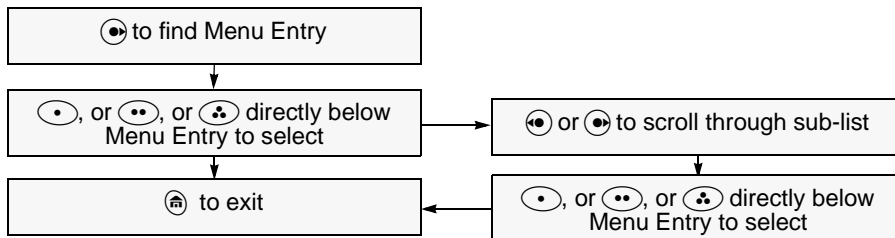

Contents

Safety and General Information

Transmit and Receive Procedure	1
Exposure to Radio Frequency Energy	1
Two-Way Radio Operation	2
Body-Worn Operation	2
Antenna Care	3
Approved Accessories	3
Electromagnetic Interference/Compatibility	3
Facilities	3
Aircraft	3
Medical Devices	3
Pacemakers	3
Hearing Aids.....	4
Other Medical Devices	4
Use While Driving	4
Operational Warnings	5
For Vehicles With an Air Bag	5
Potentially Explosive Atmospheres	5
Blasting Caps and Blasting Areas	5
Operational Cautions	6
Antennas	6
Batteries	6
Intrinsically Safe Radio Information	7
FMRC Approved Equipment	7
Repair of FMRC Approved Products	9
Repair.....	9
Relabeling	10
Do Not Substitute Options or Accessories	10

Ⓜ, Motorola, ASTRO, XTS 2500 and Private Conversation are trademarks of Motorola, Inc.

P25 radios contain technology patented by Digital Voice Systems, Inc.

© 2001 by Motorola, Inc.

Commercial, Government and Industrial
Solutions Sector

8000 W. Sunrise Blvd., Ft. Lauderdale, FL 33322

Printed in U.S.A. 9/01. All Rights Reserved.

User Guide
68P81095C05-O

General Radio Operation

Notations Used in This Manual	11
XTS 2500 Model III Radio	12
Physical Features of the Radio	13
Programmable Features	14
Display	14
Backlight	15
Status Symbols	15
Menu Entry (Softkey)	16
Menu Select Buttons	17
Menu Selection Features	18
Home Button (⌂)	19
W@P™ Button	19
4-Way Navigation Button (⬅️➡️)	19
Keypad	20
LED Indicators	21
Alert Tones	21
Standard Accessories	24
Battery	24
Charge the Battery	24
Battery Charge Status	24
Attach the Battery	25
Smart Battery Condition	26
Use the Menu	26
Use the Preprogrammed Smart Battery Button (Smart Battery Only)	26
Antenna	27
Attach the Antenna	27
Remove the Antenna	27
Belt Clip	28
Attach the Belt Clip	28
Remove the Belt Clip	28
Universal Connector Cover	29
Remove the Connector Cover	29
Attach the Connector Cover	29
Remote Speaker Microphone Adapter	30
Remove the Adapter	30
Attach the Adapter	30
Radio On and Off	32
Turn the Radio On	32

Turn the Radio Off	32
Zones and Channels	33
Select a Zone	33
Use the Menu.....	33
Use the Preprogrammed Zone Switch	34
Select a Channel	34
Method 1: Use the Preprogrammed Channel Selector	34
Method 2: Use the Menu.....	35
Receive / Transmit	36
Without Using the Volume Set and Monitor Buttons	36
Use Preprogrammed Volume Set Button	37
Use the Preprogrammed Monitor Button	38
Conventional Mode Operation	39

Common Radio Features

Selectable Power Level	41
Use the Menu	41
Use the Preprogrammed Transmit Power Level Switch	42
Radio Lock	43
Unlock Your Radio	43
Change Your Password	44
Mute or Unmute Keypad Tones	45
Use the Menu	45
Using the Preprogrammed Side Button	45
Conventional Squelch Options	46
Analog Squelch	46
Digital Squelch	46
PL Defeat	47
Time-out Timer	48
Emergency	49
Send an Emergency Alarm	50
Send a Silent Emergency Alarm	51
Send an Emergency Call	51
Emergency Keep-Alive	53
Lists	54
View a List	54
Scan List Empty	55
Edit a Call, Page, or Phone List Number	55
Use the Menu	55
Use the Preprogrammed Number Select Button	57

Contents

- Edit a Call, Page, or Phone List Name59
 - Use the Menu 59
 - Use the Preprogrammed Text Select Button 60
- Scan62
 - Turn Scan On and Off62
 - Using the Menu 62
 - Use the Preprogrammed Scan On/Off Switch 63
- Individual Calls64
 - Telephone Calls64
 - Answer a Phone Call64
 - Use the Preprogrammed Call Response Button 64
 - Use the Menu 65
 - Use the Keypad 66
 - Phone Call Display and Alert Prompts67
 - Enhanced Private-Conversation Calls
(Trunked Channels Only)68
 - Answer a Private Call 68
 - Use the Menu 69
 - Use the Keypad 70
 - Call Alert Paging71
 - Answer a Call Alert Page 71
 - Make a Call Alert72
 - Use the Menu 72
 - Use the Keypad 73
- Conventional Talkgroup Calls (Conventional Operation Only)74
 - Select Talkgroup74
- Status Calls (Trunked Radios Only)75
 - Send a Status Call75
 - Use the Menu 75
 - Send a Status Call76
 - Use the Preprogrammed Status Button 76
- Repeater or Direct Operation77
 - Select Repeater or Direct Operation77
 - Use the Menu 77
 - Use the Preprogrammed Repeater/Direct Switch 78
- Special Radio Features**
- PTT ID79
 - Receive79
 - Transmit79

View Your Radio's ID Number	79
Use the Menu.....	79
Use the Preprogrammed Call or Page Button.....	79
Trunking System Controls	80
Failsoft	80
Out-of-Range	80
Site Lock	81
Lock or Unlock a Site	81
Site Trunking	82
Site View and Change	82
View the Current Site	82
Change the Current Site	82
Real Time Clock	84
Program Time and Date	84

Helpful Tips

Radio Care	87
Cleaning	87
Handling	87
Service	88
Battery	89
Battery Life	89
Charging the Battery	89
Battery Charge Status.....	89
Battery Recycling and Disposal	90
Antenna	91
Radio Operating Frequencies	91

Accessories

Antennas	93
Audio	93
Headsets	93
Remote Speaker Microphones	93
Batteries	94
Belt Clips	95
Body-Worn	95
Chargers	95
Enhanced and Multi-Unit Line Cords	96

Contents

Glossary

Commercial Warranty

Index

Safety and General Information

IMPORTANT INFORMATION ON SAFE AND EFFICIENT OPERATION

READ THIS INFORMATION BEFORE USING YOUR MOTOROLA TWO-WAY RADIO

The information provided in this document supersedes the general safety information contained in user guides published prior to June 2001. For information regarding radio use in a hazardous atmosphere please refer to the Factory Mutual (FM) Approval Manual Supplement or Instruction Card, which is included with radio models that offer this capability.

Transmit and Receive Procedure

Your two-way radio contains a transmitter and a receiver. To transmit (talk) you must push the Push-To-Talk button; to receive (listen) you must release the Push-To-Talk button.

Exposure to Radio Frequency Energy

Your Motorola radio is designed to comply with the following national and international standards and guidelines regarding exposure of human beings to radio frequency electromagnetic energy (EME):

- United States Federal Communications Commission, Code of Federal Regulations; 47 CFR part 2 sub-part J
- American National Standards Institute (ANSI) / Institute of Electrical and Electronic Engineers (IEEE) C95. 1-1992
- Institute of Electrical and Electronic Engineers (IEEE) C95.1-1999 Edition
- National Council on Radiation Protection and Measurements (NCRP) of the United States, Report 86, 1986
- International Commission on Non-Ionizing Radiation Protection (ICNIRP) 1998
- Ministry of Health (Canada) Safety Code 6. Limits of Human Exposure to Radiofrequency Electromagnetic Fields in the Frequency Range from 3 kHz to 300 GHz, 1999

- Australian Communications Authority Radiocommunications (Electromagnetic Radiation - Human Exposure) Standard 1999 (applicable to wireless phones only)
- ANATEL, Brasil Regulatory Authority, Resolution 256 (April 11, 2001) “additional requirements for SMR, cellular and PCS product certification.”

To assure optimal radio performance and make sure human exposure to radio frequency electromagnetic energy (EME) is within the guidelines set forth in the above standards, always adhere to the following procedures:

Two-Way Radio Operation



When using your radio as a traditional two-way radio, **hold the radio in a vertical position with the microphone 1 to 2 inches (2.5 to 5.0 cm) away from your lips.**

Body-Worn Operation

To maintain compliance with FCC RF exposure guidelines, if you wear a radio on your body when transmitting, always place the radio in a **Motorola approved clip, holder, holster, case, or body harness for this product.** Use of non-Motorola-approved accessories may exceed FCC RF exposure guidelines. **If you do not use a Motorola approved body-worn accessory and are not using the radio in the intended use positions along side of the head in the phone mode or in front of the face in the two-way radio mode, then ensure the antenna and radio is kept the following minimum distances from the body when transmitting:**

- Phone or Two-way radio mode: one inch (2.5 centimeters)
- Data operation using any data feature with or without an accessory cable: one inch (2.5 centimeters)

Antenna Care

Use only the supplied or an approved replacement antenna.

Unauthorized antennas, modifications, or attachments could damage the radio and may violate FCC regulations.

DO NOT hold the antenna when the radio is “IN USE.” Holding the antenna affects call quality and may cause the radio to operate at a higher power level than needed.

Approved Accessories

For a list of approved Motorola accessories look in the appendix or accessory section of this manual.

Electromagnetic Interference/Compatibility

Note: Nearly every electronic device is susceptible to electromagnetic interference (EMI) if inadequately shielded, designed, or otherwise configured for electromagnetic compatibility.

Facilities

To avoid electromagnetic interference and/or compatibility conflicts, turn off your radio in any facility where posted notices instruct you to do so. Hospitals or health care facilities may be using equipment that is sensitive to external RF energy.

Aircraft

When instructed to do so, turn off your radio when on board an aircraft. Any use of a radio must be in accordance with applicable regulations per airline crew instructions.

Medical Devices

Pacemakers

The Health Industry Manufacturers Association recommends that a minimum separation of 6 inches (15 centimeters) be maintained between a handheld wireless radio and a pacemaker. These

recommendations are consistent with those of the U.S. Food and Drug Administration.

Persons with pacemakers should:

- ALWAYS keep the radio more than 6 inches (15 centimeters) from their pacemaker when the radio is turned ON.
- not carry the radio in the breast pocket.
- use the ear opposite the pacemaker to minimize the potential for interference.
- turn the radio OFF immediately if you have any reason to suspect that interference is taking place.

Hearing Aids

Some digital wireless radios may interfere with some hearing aids. In the event of such interference, you may want to consult your hearing aid manufacturer to discuss alternatives.

Other Medical Devices

If you use any other personal medical device, consult the manufacturer of your device to determine if it is adequately shielded from RF energy. Your physician may be able to assist you in obtaining this information.

Use While Driving

Check the laws and regulations on the use of radios in the area where you drive. Always obey them.

When using your radio while driving, please:

- Give full attention to driving and to the road.
- Use hands-free operation, if available.
- Pull off the road and park before making or answering a call if driving conditions so require.

Operational Warnings



For Vehicles With an Air Bag

Do not place a portable radio in the area over an air bag or in the air bag deployment area. Air bags inflate with great force. If a portable radio is placed in the air bag deployment area and the air bag inflates, the radio may be propelled with great force and cause serious injury to occupants of the vehicle.

Potentially Explosive Atmospheres

Turn off your radio prior to entering any area with a potentially explosive atmosphere, unless it is a radio type especially qualified for use in such areas as “Intrinsically Safe” (for example, Factory Mutual, CSA, UL, or CENELEC). Do not remove, install, or charge batteries in such areas. Sparks in a potentially explosive atmosphere can cause an explosion or fire resulting in bodily injury or even death.

Note: The areas with potentially explosive atmospheres referred to above include fueling areas such as below decks on boats, fuel or chemical transfer or storage facilities, areas where the air contains chemicals or particles, such as grain, dust or metal powders, and any other area where you would normally be advised to turn off your vehicle engine. Areas with potentially explosive atmospheres are often but not always posted.

Blasting Caps and Blasting Areas

To avoid possible interference with blasting operations, turn off your radio when you are near electrical blasting caps, in a blasting area, or in areas posted: “Turn off two-way radio.” Obey all signs and instructions.

Operational Cautions



Caution

Antennas

Do not use any portable radio that has a damaged antenna. If a damaged antenna comes into contact with your skin, a minor burn can result.

Batteries

All batteries can cause property damage and/or bodily injury such as burns if a conductive material such as jewelry, keys, or beaded chains touches exposed terminals. The conductive material may complete an electrical circuit (short circuit) and become quite hot. Exercise care in handling any charged battery, particularly when placing it inside a pocket, purse, or other container with metal objects.

Intrinsically Safe Radio Information

FMRC Approved Equipment

Anyone intending to use a radio in a location where hazardous concentrations of flammable materials exist (hazardous atmosphere) is advised to become familiar with the subject of intrinsic safety and with the National Electric Code NFPA 70 (National Fire Protection Association) Article 500 (hazardous [classified] locations).

An Approval Guide, issued by Factory Mutual Research Corporation (FMRC), lists manufacturers and the products approved by FMRC for use in such locations. FMRC has also issued a voluntary approval standard for repair service (“Class Number 3605”).



FMRC Approval labels are attached to the radio to identify the unit as being FM Approved for specified hazardous atmospheres. This label specifies the hazardous Class/Division/Group along with the part number of the battery that must be used. Depending on the design of the portable unit, this FM label can be found on the back or the bottom of the radio housing. The FM Approval mark is shown here.



WARNING

- **Do not operate radio communications equipment in a hazardous atmosphere unless it is a type especially qualified (for example, FMRC Approved) for such use. An explosion or fire may result.**
- **Do not operate an FMRC Approved Product in a hazardous atmosphere if it has been physically damaged (for example, cracked housing). An explosion or fire may result.**
- **Do not replace or charge batteries in a hazardous atmosphere. Contact sparking may occur while installing or removing batteries and cause an explosion or fire.**
- **Do not replace or change accessories in a hazardous atmosphere. Contact sparking may occur while installing or removing accessories and cause an explosion or fire.**
- **Do not operate an FMRC Approved Product unit in a hazardous location with the accessory contacts exposed. Keep the connector cover in place when accessories are not used.**
- **Turn a radio off before removing or installing a battery or accessory.**
- **Do not disassemble an FMRC Approved Product unit in any way that exposes the internal electrical circuits of the unit.**

Radios must ship from the Motorola manufacturing facility with the hazardous atmosphere capability and FM Approval labeling. Radios will not be “upgraded” to this capability and labeled in the field.

A modification changes the unit’s hardware from its original design configuration. Modifications can only be made by the original product manufacturer at one of its FMRC-audited manufacturing facilities.



- **Failure to use an FMRC Approved Product unit with an FMRC Approved battery or FMRC Approved accessories specifically approved for that product may result in the dangerously unsafe condition of an unapproved radio combination being used in a hazardous location.**
- **Unauthorized or incorrect modification of an FMRC Approved Product unit will negate the Approval rating of the product.**

Repair of FMRC Approved Products

REPAIRS FOR MOTOROLA PRODUCTS WITH FMRC APPROVAL ARE THE RESPONSIBILITY OF THE USER.

You should not repair or relabel any Motorola- manufactured communication equipment bearing the FMRC Approval label (“FMRC Approved Product”) unless you are familiar with the current FMRC Approval standard for repairs and service (“Class Number 3605”).

You may want to consider using a repair facility that operates under 3605 repair service approval.



- **Incorrect repair or relabeling of any FMRC Approved Product unit could adversely affect the Approval rating of the unit.**
- **Use of a radio that is not intrinsically safe in a hazardous atmosphere could result in serious injury or death.**

FMRC’s Approval Standard Class Number 3605 is subject to change at any time without notice to you, so you may want to obtain a current copy of 3605 from FMRC. Per the December 1994 publication of 3605, some key definitions and service requirements are as follows:

Repair

A repair constitutes something done internally to the unit that would bring it back to its original condition—Approved by FMRC. A repair should be done in an FMRC Approved facility.

Items not considered as repairs are those in which an action is performed on a unit which does not require the outer casing of the unit to be opened in a manner which exposes the internal electrical circuits of the unit. You do not have to be an FMRC Approved Repair Facility to perform these actions.

Relabeling

The repair facility shall have a method by which the replacement of FMRC Approval labels are controlled to ensure that any relabeling is limited to units that were originally shipped from the Manufacturer with an FM Approval label in place. FMRC Approval labels shall not be stocked by the repair facility. An FMRC Approval label shall be ordered from the original manufacturer, as needed, to repair a specific unit. Replacement labels may be obtained and applied by the repair facility, provided there is satisfactory evidence that the unit being relabeled was originally an FMRC Approved unit. Verification may include, but is not limited to: a unit with a damaged Approval label, a unit with a defective housing displaying an Approval label, or a customer invoice indicating the serial number of the unit and purchase of an FMRC Approved model.

Do Not Substitute Options or Accessories

The Motorola communications equipment certified by Factory Mutual is tested as a system and consists of the FM Approved portable, FM Approved battery, and FM Approved accessories or options, or both. This FM Approved portable and battery combination must be strictly observed. There must be no substitution of items, even if the substitute has been previously Approved with a different Motorola communications equipment unit. Approved configurations are listed in the FM Approval Guide published by FMRC, or in the product FM Supplement. This FM Supplement is shipped from the manufacturer with the FM Approved radio and battery combination. The Approval Guide, or the Approval Standard Class Number 3605 document for repairs and service, can be ordered directly from Factory Mutual Research Corporation located in Norwood, Massachusetts.

General Radio Operation

Notations Used in This Manual

You will notice the use of **WARNINGS**, **CAUTIONS**, and **Notes** throughout this manual. These notations are used to emphasize that safety hazards exist and that care must be taken or observed.



WARNING

WARNING: An operational procedure, practice, condition, etc. exists which may result in injury or death if not carefully observed.



Caution

CAUTION: An operational procedure, practice, condition, etc. exists which may result in damage to the equipment if not carefully observed.

Note: A **Note** is an operational procedure, practice, or condition, etc. which is essential to emphasize.

The following special notations identify certain items:

Example

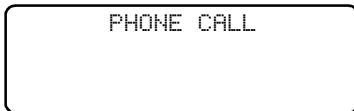

PHONE

Description

Buttons are shown as representative symbols.

Information appearing in the radio's display is shown using the special display font.

Menu entries are shown similar to the way they appear in the radio's display.

XTS 2500 Model III Radio

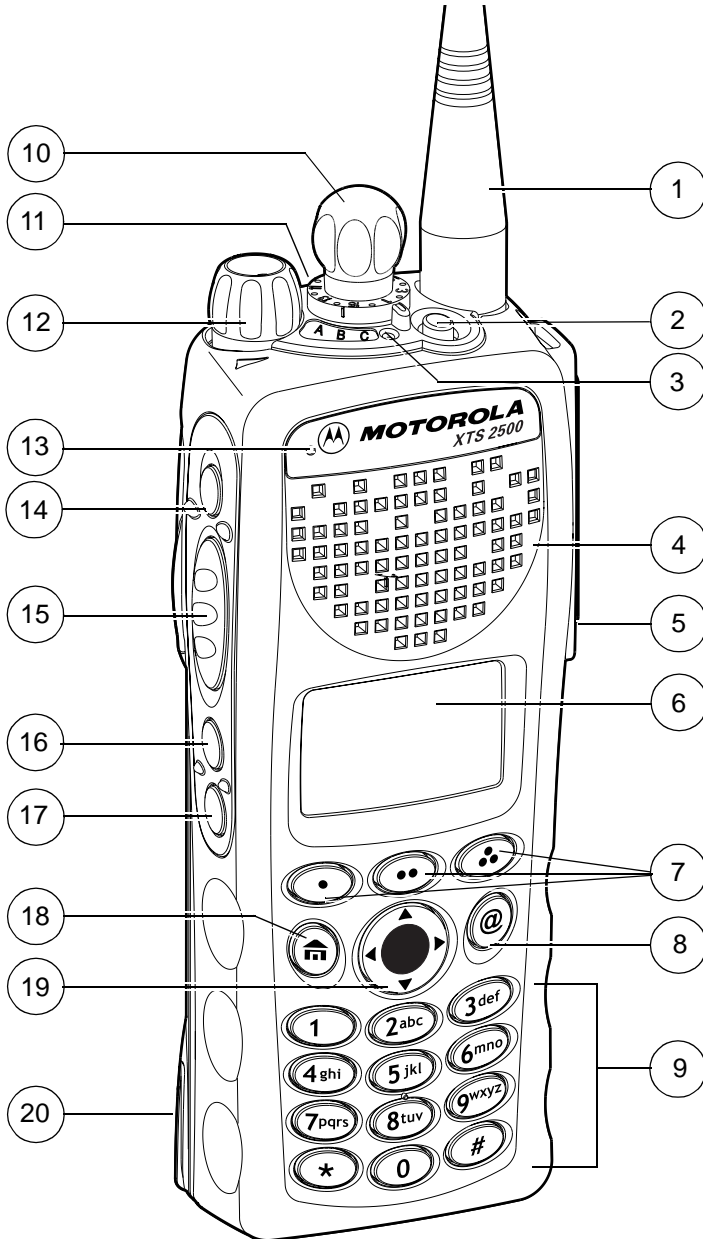

Physical Features of the Radio

<i>Item</i>	<i>Page</i>	<i>Item</i>	<i>Page</i>
1 Antenna	27	11 3-Position Rotary Switch (programmable)	
2 Top Button (programmable)		12 On/Off/Volume Control Knob	32
3 LED	21	13 Microphone	
4 Speaker		14 Top Side Button (programmable)	
5 Universal Connector	29	15 Push-to-Talk (PTT) Button	
6 Display	14	16 Side Button 1 (programmable)	
7 Menu Select Buttons (programmable)	17	17 Side Button 2 (programmable)	
8 Alpha Button (for future use)		18 Home Button	19
9 Keypad	20	19 4-Way Navigation Button	19
10 16-Position Select Knob (programmable)		20 Battery	24

Programmable Features

These features are programmable by a qualified technician:

<i>Feature</i>	<i>Page</i>	<i>Feature</i>	<i>Page</i>
Call Alert Page	71	Repeater/Direct	77
Call Response	64	Scan On/Off	62
Channel Selection	34	Site Lock/Unlock	81
Emergency	49	Site Search	82
Keypad Mute	45	Status Call	75
Monitor	38	Text Select	60
Number Select	57	Transmit Power Level	41
Phone	64	Volume Set	37
PL Defeat	47	Zone Selection	33
Private Call	68		

Display



The above screen example may not be identical to the display symbol arrangement in your radio. The top two screen rows display menu and radio status information.

Backlight

If poor light conditions make the display or channel numbers (around the **16-Position Select** knob) difficult to read, turn on the radio's backlights by pressing the **Light** button.

These lights will remain on for a preprogrammed time before they turn off automatically, or you can turn them off immediately by pressing the **Light** button again.

Status Symbols

The top two rows in the display contain symbols indicating the radio's status.

Table 1: Status Symbols









<i>Symbol</i>	<i>Indication</i>	<i>Page</i>
H L	Power Level. High Power "H" or Low Power "L" is activated.	41
	Call Received. Flashes when an Individual Call is received.	64
	View/Program Mode. <ul style="list-style-type: none"> View a list (steady) Program a list (flashing) 	54
	Received Signal Strength Indication (RSSI). The received signal strength for the current site. Trunked only. The more stripes in the symbol, the stronger the received signal.	82
	Battery <ul style="list-style-type: none"> Conventional = Flashes when the battery is low. Smart = The number of bars (0-3) shown indicates the charge remaining in your battery. Flashes when battery level reaches 10% or less. 	24

Table 1: Status Symbols

<i>Symbol</i>	<i>Indication</i>	<i>Page</i>
	<p>Talkaround.</p> <ul style="list-style-type: none"> • On = Talking directly to another radio, not through a repeater. Conventional operation only. • Off = Talking through a repeater. 	77
	<p>Monitor (Carrier Squelch). The selected channel is being monitored. Conventional operation only.</p>	38
	<p>Scan. The radio is scanning a scan list.</p>	62
	<p>Emergency. The radio enters the Emergency State.</p>	49

Menu Entry (Softkey)

The bottom row of the display contains one to three menu entries (also known as softkeys). The menu entries allow you to select from one of several menus to access the radio's features. The menu entries are accessed using the Menu Select buttons.

Menu Select Buttons

The Menu Select buttons access the menu entries of features that have been activated by a qualified radio technician. Your radio may be programmed differently from the following example, but the display for selecting Scan on or off might look like this:

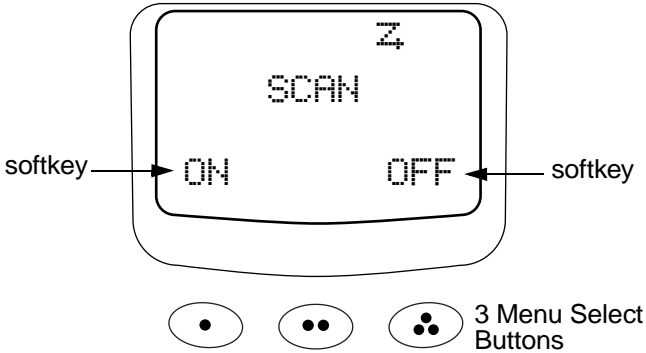

Example: To turn scan on

Press .

The display shows the selected state.

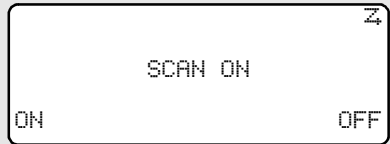

Menu Selection Features

In most cases, press  to display the following feature selections.

<i>Feature</i>	<i>Menu Selection</i>	<i>Page</i>	<i>Feature</i>	<i>Menu Selection</i>	<i>Page</i>
Call Alert Page	PAGE	72	Repeater/ Direct	DIR	77
Call Response	PHONE CALL RECEIVED	64	Scan On/ Off	SCAN	62
	or PRIVATE CALL RECEIVED	68			
	or PAGE RECEIVED	71			
Channel Selection	CHAN	34	Site Lock/ Unlock	SITE	81
Emergency	EMERGENCY	49	Site Search	SCANNING SITE	82
Keypad Mute	MUTE	45	Status Call	STS	75
Number Select	NUM	57	Text Select	PROG	60
Phone	PHON	65	Transmit Power Level	PWR	82
Private Call	CALL	69	Zone Selection	ZONE	33

Home Button (🏠)

The **Home** button will always return you to the home (default) display. In most cases, this is the current mode.

Some radio features require saving information in memory. Pressing the **Home** button while using those features will cause information to be saved before going to the home display.

Some features do not require you to press the **Home** button to go to the home display. This reduces the required number of button presses.

W@P™ Button

Reserved for future use.

4-Way Navigation Button (⬅️➡️)

This button is used to scroll through the radio's lists or items in the display.

Keypad

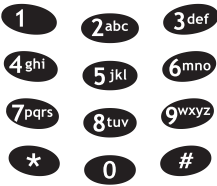

The 3 x 4 alphanumeric keypad provides an interface to your radio's features.

The keypad functions in a manner similar to a standard telephone keypad when entering numeric digits.

When the keypad is used to edit a list, each key can generate different characters of the alphabet. Refer to the following table for a complete list of characters.

Key	Number of times the key is pressed								
	1	2	3	4	5	6	7	8	9
0	0	()	<	>				
1	1	&	%						
2 abc	A	B	C	2	a	b	c		
3 def	D	E	F	3	d	e	f		
4 ghi	G	H	I	4	g	h	i		
5 jkl	J	K	L	5	j	k	l		
6 mno	M	N	O	6	m	n	o		
7 pqrs	P	Q	R	S	7	p	q	r	s
8 tuv	T	U	V	8	t	u	v		
9 wxyz	W	X	Y	Z	9	w	x	y	z
*	*	/	+	-	=				
#	#	.	!	?	,	;			

LED Indicators

<i>This LED Color:</i>	<i>indicates:</i>
RED (Non-flashing)	Transmitting
RED (Flashing)	<ul style="list-style-type: none"> • Channel Busy or • Low Battery (lights while transmitting)
GREEN	Receiving Individual Call

Alert Tones

Your radio uses alert tones to inform you of radio conditions.

Table 2: Alert Tones

<i>You hear:</i>	<i>Tone Name</i>	<i>Heard :</i>
<i>Short, Low-Pitched Tone</i>	Invalid Key-Press	when the wrong key is pressed.
	Radio Self-Test Failed	when the radio fails the power-up self test.
	No ACK Received	when the radio does not receive an acknowledgment.
	Reject	when an unauthorized request is made.
	Time-Out Timer Warning	four seconds before time out.

Table 2: Alert Tones (Continued)

You hear:	Tone Name	Heard :
<i>Long, Low-Pitched Tone</i>	Time-Out Timer Timed Out	after time out.
	Talk Prohibit/ PTT Inhibit	when the PTT button is pressed, and transmissions are prevented.
	Out-of-Range	when the PTT button is pressed, but the radio is out of range of the system.
	Invalid Mode	when the radio is set to an unprogrammed channel.
	Individual Call Warning Tone	when the radio is in Individual Call without any activity for more than 6 seconds.
<i>A Group of Low-Pitched Tones (Busy Tone)</i>	Busy	when the system is busy.
<i>Long, Medium- Pitched Tone</i>	Volume Set	when volume changed on a quiet channel.
	Emergency Exit	upon exiting the emergency state.

Table 2: Alert Tones (Continued)

You hear:	Tone Name	Heard :
<i>A Group of Medium-Pitched Tones</i>	Failsoft	when the system fails.
	Automatic Call Back	when the voice channel is available from the previous request.
	Talk Permit	upon pressing the PTT button, it verifies the system is accepting transmissions.
	Console Acknowledge	when a status, emergency alarm, or reprogram request acknowledgment is received.
	Received Individual Call	when a Call Alert, or Private Conversation Call is received.
	Call Alert Sent	when a Call Alert is received by the target radio.
<i>Short, High-Pitched Tone (Chirp)</i>	Low-Battery Chirp	when the battery is below the preset threshold value.
<i>Ringling</i>	Fast Ringing	when the system is searching for the Private Conversation Call target radio.
	Enhanced Call Sent	when waiting for the Private Conversation Call target radio to respond to the call.
	Phone Call Received	when a landline phone call is received.

Standard Accessories

Battery



To avoid a possible explosion:

- **DO NOT** replace the battery in any area labeled “hazardous atmosphere”.
- **DO NOT** discard batteries in a fire.

Charge the Battery

The Motorola-approved battery shipped with your radio is uncharged. Prior to using a new battery, charge it for a minimum of 16 hours to ensure optimum capacity and performance.

For a list of Motorola-authorized batteries available for use with your XTS 2500 radio, see “Batteries” on page 54.

Note: When charging a battery attached to a radio, turn the radio off to ensure a full charge.

Battery Charger

To charge the battery, place the battery, with or without the radio, in a Motorola-approved charger. The charger’s LED indicates the charging progress; see your charger’s user guide. For a list of chargers, see “Chargers” on page 55.

Battery Charge Status

If programmed by a qualified technician, you can check your battery’s charge status by holding down the preprogrammed **Battery Gauge** button. The charge status is shown by the color of the radio’s LED indicator.

Battery Level	LED Indicator
High	Green
Sufficient	Yellow
Low	Flashing Red
Very low	None

Attach the Battery

- 1 With the radio off, fit the three extensions at the bottom of the battery into the bottom slots on the radio.

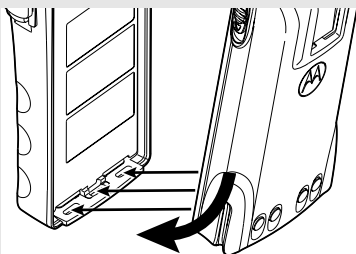

- 2 Press the top of the battery against the radio until it clicks into place.

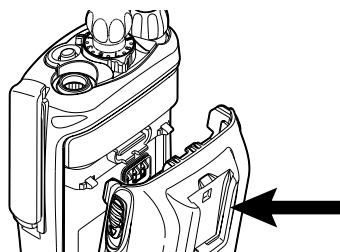

Remove the Battery

- 1 With the radio off, slide down the latches on the sides of the battery.

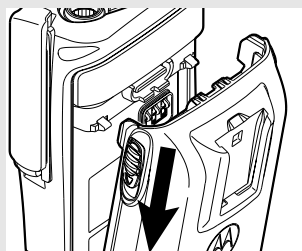

- 2 Pull the top of the battery away from the radio.

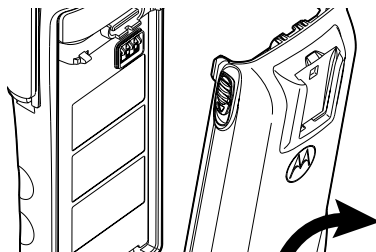

Smart Battery Condition

This feature lets you view the condition of your Smart Battery.

Use the Menu

- 1 Press  to find BATT.

BATT

- 2 Press , , or  directly below BATT.

```
CAPACITY      70%
INIT          10/01
EST CHGS      11
```

Note: If a Smart Battery is not powering your radio

```
SMART BATT
DATA NOT
AVAILABLE
```

- 3 Press  to exit.
-

Use the Preprogrammed Smart Battery Button (Smart Battery Only)

- 1 Press the **Smart Battery** button.

```
CAPACITY      70%
INIT          10/01
EST CHGS      11
```

Note: If a Smart Battery is not powering your radio

```
SMART BATT
DATA NOT
AVAILABLE
```

- 2 Press  to exit.
-

Antenna

Your radio's operating frequency is **806 to 870 MHz**. For information regarding other available antennas, see page 91.

Attach the Antenna

With the radio off, turn the antenna clockwise to attach it.



Remove the Antenna

With the radio off, turn the antenna counter-clockwise to remove it.

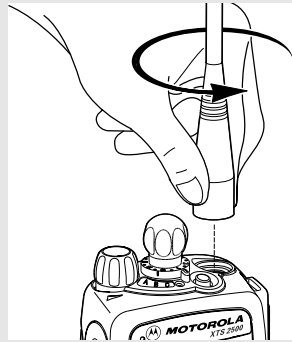

Belt Clip

Attach the Belt Clip

- 1 Align the grooves of the belt clip with those of the battery.

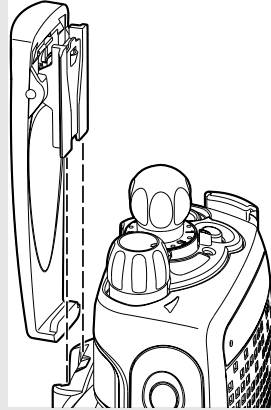

- 2 Press the belt clip downward until you clear a “click.”

Remove the Belt Clip

- 1 Use a flat-bladed object to press the belt clip tab away from the battery.

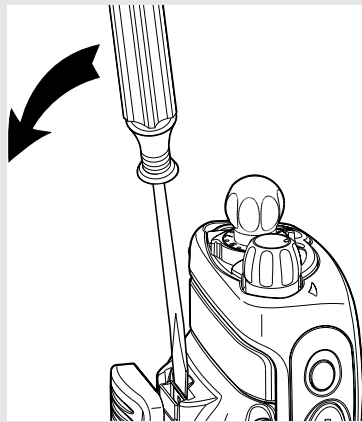

- 2 Slide the belt clip upward to remove it.
-

Universal Connector Cover

The universal connector cover is located on the antenna side of the radio. It is used to connect certain accessories to the radio.

To prevent damage to the connector, shield it with the connector cover when not in use.

Remove the Connector Cover

- 1 Insert a flat-blade screwdriver into the area between the bottom of the cover and the slot below the connector.
- 2 Hold the top of the cover with your thumb while you pry the bottom of the cover away from the radio with the screwdriver.

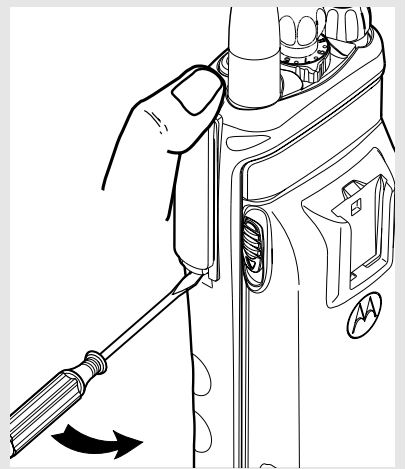

Attach the Connector Cover

- 1 Insert the hooked end of the cover into the top of the connector. Press downward on the cover's top to seat it into the slot.
- 2 Press the cover's lower tab below the connector until it snaps in place.

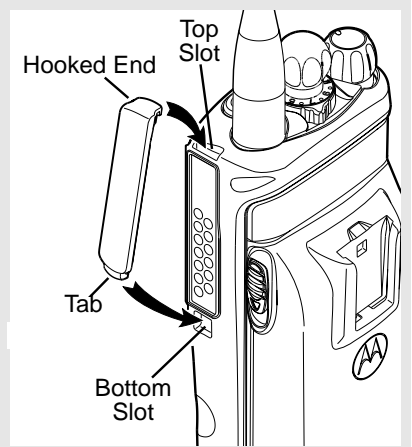

Remote Speaker Microphone Adapter

The Remote Speaker Microphone (RSM) adapter is located on the back of the radio, just above the battery. It must be used to connect the RSM accessories (see page 53) to the radio.

Remove the Adapter

Lift the larger side (below the antenna port) of the adapter away from the radio using your finger.

If you cannot easily remove the adapter with your finger, use a small, flat blade screwdriver to pry the larger end side of the adapter away from the radio.

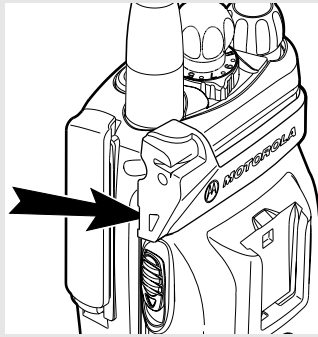

Attach the Adapter

- 1 With the Motorola side of the adapter facing out, snap the smaller end of the adapter into place in the shroud indent, below the On/Off Volume Control Knob.

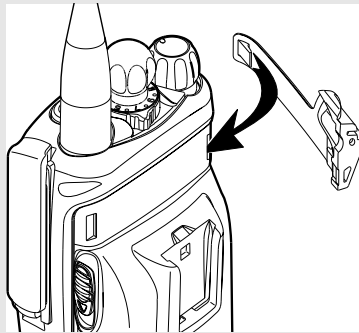

- 2 Snap the larger end of the adapter into place in the shroud indent, below the antenna port.

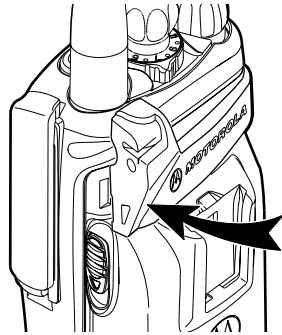

Radio On and Off

Turn the Radio On

- 1 Turn the **On/Off/Volume Control** knob clockwise.

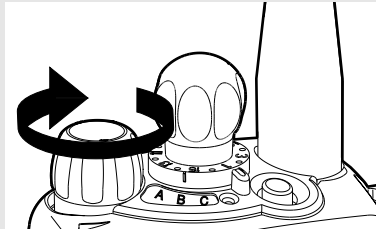

- If the power-up test is successful, you will see `Self Test`.
- If the power-up test is unsuccessful, you will see `ERROR XX/YY`. (XX/YY is an alphanumeric code.) Turn off the radio, check the battery, and turn the radio on again. If the radio continues to fail the power-up test, record the `ERROR XX/YY` code and contact a qualified service technician.

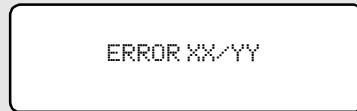
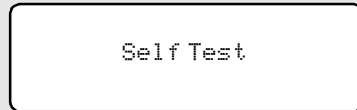

Turn the Radio Off

Turn the **On/Off/Volume Control** knob counterclockwise until it clicks.

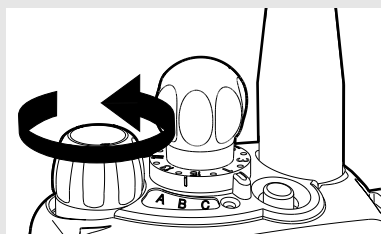

Zones and Channels

A zone is a grouping of channels. A channel is a group of radio characteristics, such as transmit/receive frequency pairs.



Before you use your radio to receive or send messages, you should select the zone and channel.

Select a Zone

Use the Menu

- 1 Press  to find ZONE.



- 2 Press , , or  directly below ZONE. The current zone (in this case, POL) flashes and the channel name (DISP NW), does not flash.



- 3 Press  to find the zone you want. For example, FIRE.

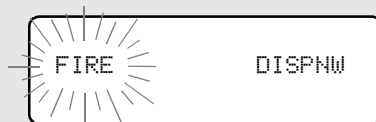

- 4 Press  to confirm the displayed zone and channel.

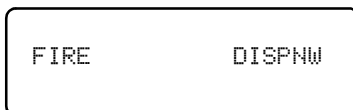

OR

Press the **PTT** button to transmit on the displayed zone/channel.)

Use the Preprogrammed Zone Switch

- 1 If a control on your radio has been preprogrammed as the **Zone** Switch, move the **Zone** Switch to the position for the zone you want.



- Note:** If the zone you selected is unprogrammed, repeat step 1.

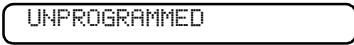

- 2 Press  to confirm the displayed zone and channel.

Select a Channel

Consult an authorized service technician for the right choice between the following methods.

Method 1: Use the Preprogrammed Channel Selector

After the zone you want is displayed, turn the preprogrammed **Channel Selector** switch to the desired channel.





Method 2: Use the Menu

- 1 Press  to find CHAN.



CHAN

- 2 Press , , or  directly below CHAN.

The display shows the current channel name (in this case, DISP NW) flashing and the zone (POL), not flashing.



POL DISP NW

- 3 Press  to find the channel name you want.

OR

Use the keypad to enter the channel number.

If the channel you selected is unprogrammed, repeat step 3.



UNPROGRAMMED

- 4 Press  to confirm the displayed zone and channel.

OR

press the **PTT** button to transmit on the displayed zone/channel.



POL DISP SE

Receive / Transmit

Without Using the Volume Set and Monitor Buttons

- 1 Turn the radio on and select the desired zone and channel.
- 2 Listen for a transmission.
- 3 Adjust the **Volume Control** knob if necessary.

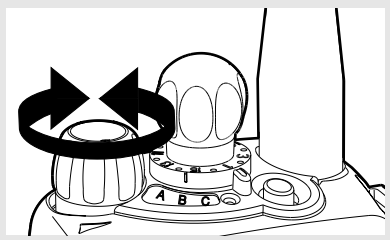

- 4 Release the **Volume Set** button.
 - 5 Press and hold the **PTT** button to transmit. The LED lights RED while transmitting.
 - 6 Release the **PTT** button to receive (listen).
-

Use Preprogrammed Volume Set Button

- 1 Turn the radio on and select the desired zone and channel. See **Turn the Radio On**, page 32 and **Zones and Channels**, page 33.
- 2 Press and hold the Volume Set button to hear the volume set tone.
- 3 Release the Volume Set button.
- 4 Adjust the Volume Control Knob if necessary.

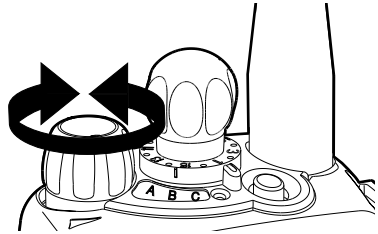

- 5 Press and hold the PTT button to transmit. LED lights RED while transmitting.
 - 6 Release PTT button to receive (listen).
-

Use the Preprogrammed Monitor Button

- 1 Turn the radio on and select the desired zone and channel.
- 2 Press the Monitor button and listen for activity. (See the following **Conventional Mode Operation.**)

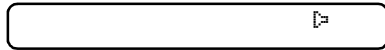

- 3 Adjust the **Volume Control** Knob if necessary.

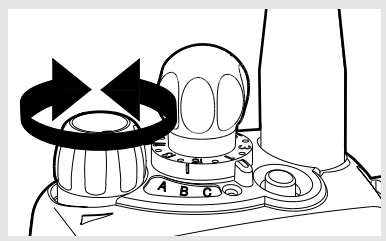

- 4 Press and hold the **PTT** button to transmit. The LED lights RED while transmitting.
- 5 Release the **PTT** button to receive (listen).

Conventional Mode Operation

Your radio may be programmed to receive Private-Line® (PL) calls.

- 1 Momentarily press the **Monitor** button to listen for activity. The Carrier Squelch indicator is displayed.

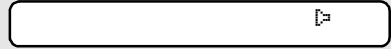

- 2 Press and hold the **Monitor** button to set continuous monitor operation. (The duration of the button press is programmable.)

- 3 Press the **Monitor** button again, or the **PTT** button, to return to the original squelch setting.

Note: If you try to transmit on a receive-only channel, you will hear an invalid tone until you release the **PTT** button.

Common Radio Features

Selectable Power Level

This feature lets you select the power level at which your radio will transmit. The radio will always turn on to the preprogrammed default setting.

Select **LOW** for a shorter transmitting distance and to conserve power.



Select **HIGH** for a longer transmitting distance.

Use the Menu

- 1 Press  to find PWR.





PWR

- 2 Press , , or  directly below PWR.

The display shows the current power level (L or H) along with LOW and HIGH.



L or H
LOW HIGH

- 3 Press , , or  directly below the desired power level (LOW or HIGH).

- The new transmit power level is saved.
- The radio returns to the Home display.

Note: To exit at anytime, press  or the **PTT** button.

Note: The default setting returns when you turn the radio off and on.

Use the Preprogrammed Transmit Power Level Switch

- 1 Press  to find PWR.



- 2 Press , , or  directly below PWR.

The current power level is displayed along with LOW and HIGH.

- 3 Press the preprogrammed Transmit Power Level switch to select LOW. Press it again to select HIGH.

The new transmit power level is saved. Radio returns to home display.

Note: The default setting returns when you turn the radio off and on.

Radio Lock

This feature provides stronger radio security.

If this feature is enabled by a qualified technician, you will see RADIO LOCK when you turn the radio on.

Unlock Your Radio

- 1 Enter your numeric password of up to 8 characters. To hide your password, an asterisk appears in place of each digit. (Use  to backspace if you make a mistake.)



- 2 Press the preprogrammed **Select** button after you enter your password.

- 3 Press the preprogrammed side button to verify the password. Radio unlocks if password is correct.

Note: DEADLOCK is displayed after three incorrect password attempts.



Turn the radio off and on, and begin again at step 1.

Change Your Password

1 Press  to find PSWD.

2 Press , , or  directly below PSWD.

3 Enter the old password.



4 Press , , or  directly below SEL.

5 Press the side button.

6 Enter new password.

7 Press , , or  directly below SEL.

8 Re-enter password.

9 Press , , or  directly below SEL.

Repeat steps 6 thru 9.

Note: You cannot access this feature again after three failed attempts until you turn the radio off and on.



Mute or Unmute Keypad Tones

You can turn the keypad tones off and on.

Use the Menu

- 1 Press  to find MUTE.



MUTE

- 2 Press , , or  directly below MUTE. The current state is shown.

TONES OFF

or

TONES ON

- 3 Press , , or  directly below

ON

or

OFF

Note: Press the  or the PTT button to exit without saving changes.

Using the Preprogrammed Side Button

Press the preprogrammed side button to turn the tones off or on.

Note: Press the  or the PTT button to exit without saving changes.

Conventional Squelch Options

Analog Squelch

Tone Private Line (PL), Digital Private-Line (DPL), network ID, and carrier squelch can be available (programmed) per channel.

Network ID is available only on ASTRO “digital” channels.

When in...	this condition occurs:
Carrier squelch (t=)	You hear all traffic on a channel.
PL, DPL, or network ID	The radio responds only to your messages.

Digital Squelch

One or more of the following options may be programmed in your radio. Consult your service technician for more information.

This option...	will allow you to hear:
Digital Carrier-Operated Squelch (COS)	any digital traffic.
Normal Squelch	any digital traffic having the correct Network access code.
Selective Switch	any digital traffic having the correct Network access code and correct talkgroup.

PL Defeat

With this feature, you can override any coded squelch (DPL, PL, or network ID) that might be programmed to a channel.

- 1 Place the preprogrammed **PL Defeat** switch in the **PL Defeat** position. You can now hear any activity on the channel. The radio is muted if no activity is present.

When this feature is active, the Carrier Squelch status indicator (🔇) will be displayed.

Time-out Timer

The time-out timer turns off your radio's transmitter. The timer is set for 60 seconds at the factory, but it can be programmed from 0 to 7.75 minutes (465 seconds) by a qualified radio technician.

- 1** Hold down the **PTT** longer than the programmed time. You will hear a short, low-pitched warning tone, the transmission is cut-off, and the LED will go out until you release the **PTT**.
 - Short warning tone
 - Transmission is cut-off
 - LED goes out
- 2** Release the **PTT** button.
 - LED relights
 - Timer resets
- 3** Press the **PTT** to re-transmit. Time-out timer restarts.
 - Timer restarts

Emergency

If the top (orange) button is programmed to send an emergency signal, then this signal overrides any other communications over the selected channel.

Your radio may be programmed for

- Emergency Alarm
- Emergency Alarm with Emergency Call
- Silent Emergency Alarm, or
- Emergency Call.

Send an Emergency Alarm

An Emergency Alarm will send a data transmission to the dispatcher, identifying the radio sending the emergency

- 1 With your radio turned on, press the **Emergency** button. The current zone/channel is displayed alternately with **EMERGENCY**, the LED lights **RED**, and a short, medium-pitched tone sounds. When you receive the dispatcher's acknowledgment, four beeps sound and the alarm ends. If no acknowledgment is received, the radio exits after the alarm end.



EMERGENCY

- RED LED
- Short Tone

If you press the **PTT** button while in Emergency Alarm, the alarm is cancelled without an exit tone, and you can begin transmitting voice calls.

While in Emergency Alarm with Emergency Call, the radio enters the Emergency Call state after it receives the dispatcher's acknowledgment, or if you press the **PTT** button.

- 2 Exit the Emergency state by pressing the **Emergency** button again for about one second (the time may be changed by a qualified technician). A medium-pitched tone sounds until you release the button. The radio returns to normal operation.
-

Send a Silent Emergency Alarm

- 1 Press the **Emergency** button if your radio is programmed for this use.
LED does not light and no tones sound.
- 2 Press the **PTT** button to enable the audio and exit Silent Emergency Alarm. The silent alarm is cancelled without an exit tone, and you can begin transmitting voice calls.

Note: While in Silent Emergency Alarm with Emergency Call, press the **PTT** button to enter Emergency Call operation.

Exit the Emergency State by pressing the **Emergency** button again for about one second (the time may be changed by a qualified technician). A medium-pitched tone sounds until you release the button. The radio returns to normal operation.

Send an Emergency Call

An Emergency Call will send a type of dispatch giving your radio priority access to channels.

- 1 Press the **Emergency** button if your radio is programmed for this use.
 - 2 Press and hold the **PTT** button and announce the emergency into the microphone to send the Emergency call.
 - 3 Release the **PTT** button to end the call.
-

- 4 Exit the Emergency State by pressing the **Emergency** button again for about one second (the time may be changed by a qualified technician). A medium-pitched tone sounds until you release the button. The radio returns to normal operation.
-

The radio operates in the normal dispatch manner while in Emergency Call, except, if enabled, it will return to one of the following:

Using this operation:	means you will talk...
1. Tactical/Non-Revert	on the channel you selected before you entered the emergency state.
2. Non-Tactical/Revert	on a preprogrammed emergency channel. The emergency alarm is sent to this same channel.

- Note:**
- For ALL Emergency signals: You can change channels while in Emergency operation if the new channel is also programmed for Emergency. The emergency alarm or call continues on the new channel.
 - If the new channel is NOT programmed for Emergency, an invalid tone sounds until you exit the Emergency state or change to a channel programmed for emergency.

Emergency Keep-Alive

If the radio is in the Emergency state, with Emergency Keep-Alive enabled, you cannot turn off the radio by using the **On/Off Control** knob.

With Keep-Alive, the radio will only exit the Emergency state using one of the ways mentioned in the previous sections (Emergency Alarm, Silent Emergency Alarm, or Emergency Call).

Lists

You can use lists to store frequently used numbers and associate them with names.

There are four list types:



- Call
- Page
- Phone
- Scan



View a List

1 Press  to find VIEW.



VIEW

2 Press , , or  directly below VIEW.

3 Press  or  to see the names of the available lists.

4 Press , , or  directly below the desired list to view it.

The first list member is displayed. □ indicates the view mode.

5 Press  or  to view other list members.

6 Press  to exit.

Scan List Empty

If the scan list has no members, EMPTY LIST is displayed.

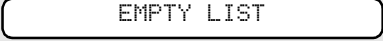

EMPTY LIST can be changed by turning scan off, or a qualified technician adds members to the scan list.

Edit a Call, Page, or Phone List Number

Use the Menu



- 1 Press  to find PROG.



- 2 Press , , or  directly below PROG.





The changeable lists are displayed.

- 3 Press , , or  directly below the list you wish to change.

First list member is displayed. Flashing  indicates programming mode.



- 4 Press  or  to view other list members.

- 5 Stop on a list member to display name and ID number.



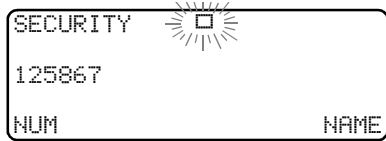

- 6 Press , , or  directly below NUM.

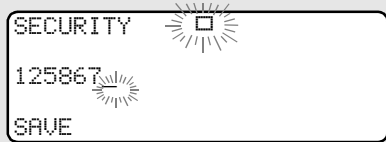

- 7 Blinking cursor shows location of number to be added. Press a keypad button to add a digit.



Press  to erase digits. If you erase the entire number and press  or , you exit the edit mode without saving your changes.

- 8 Press , , or  directly below SAVE to save your change.

Return to step 4 to make more changes.



OR

Press  to cancel a change and return to home display.



Use the Preprogrammed Number Select Button

- 1 Press  to find PROG.



- 2 Press , , or  directly below PROG.

The changeable lists are displayed.

- 3 Press , , or  directly below the list you wish to change.

First list member is displayed. Flashing  indicates programming mode.

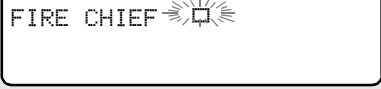



- 4 Use keypad to enter a list member number of up to 12 characters.



- 5 Stop on a list member to display name and ID number.

- 6 Press the **Number Select** preprogrammed button to enter “programming—number-edit” mode.

- 7 Blinking cursor shows location of number to be added. Press a keypad button to add a digit.

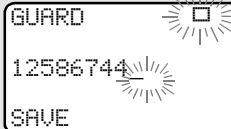
Press  to erase digits. (If you erase the entire number and press  or , you exit the edit mode without saving your changes.)



- 8 Press , , or  directly below **SAVE** to save your change.

Return to step 4 to make more changes.

OR

Press  to cancel a change and return to home display.



- 9 Press **Number Select** button again to make more changes.

Edit a Call, Page, or Phone List Name

Use the Menu



- 1 Press  to find PROG.

PROG

- 2 Press , , or  directly below PROG.

The changeable lists are displayed.

PAGE CALL PHON

- 3 Press , , or  directly below the list you wish to change.

First list member is displayed. Flashing  indicates programming mode.

FIRE CHIEF 
007722588
NUM NAME

- 4 Press  or  to scroll to view other list members.

- 5 Stop on a list member to display name and ID number.

SECURITY 
12586744
NUM NAME

- 6 Press , , or  directly below NAME.

SECURITY 
12586744
SAVE

- 7 Blinking cursor shows location of character to be added. Press a keypad button to add a character. See “Keypad” on page 20.

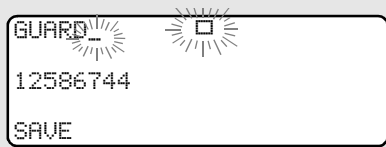

Press to erase the last digits. (If you erase the entire name and press , you exit the edit mode without saving your changes.)

Press to cancel a change and return to home display.

- 8 Press , , or directly below **SAVE** to save your change.

Return to step 4 to make more changes.

OR

Press to cancel a change and return to home display.



Use the Preprogrammed Text Select Button





- 1 Press to find **PROG.**







- 2 Press , , or directly below **PROG.**

The changeable lists are displayed.

-
- 3** Press , , or  directly below the list you wish to change.

First list member is displayed. Flashing status  indicates programming mode.
 - 4** Press  or  to view other list members.
 - 5** Stop on a list member to display name and ID number.
 - 6** Press the **Text Select** preprogrammed button to enter “programming—text-edit” mode.
 - 7** Blinking cursor shows location of character to be added. Press a keypad button to add a character. See “Keypad” on page 20. Press  or  twice to move two positions.

Press  to erase characters. If you erase the entire line and press  or , you exit the edit mode without saving your changes.

Press  to cancel a change and return to home display.
 - 8** Press **Text Select** button again to make more changes.
-

Scan

The scan feature allows you to monitor traffic on different channels by scanning a preprogrammed list of channels. There is one list per radio. The list must be preprogrammed by a qualified technician.

There are two types of available scan lists:

- **Conventional** includes only conventional channels. A maximum of 10 different channels is possible.
- **Talkgroup Scan** includes conventional and trunked channels on one trunking system. A maximum of ten different channels is possible. Priority operation is not available in this type of list.
- You can view the scan list assigned to the currently selected channel the same way you would view other lists. See “Viewing a List” on page 54.

Turn Scan On and Off

Using the Menu





- 1 Press  to find SCAN.

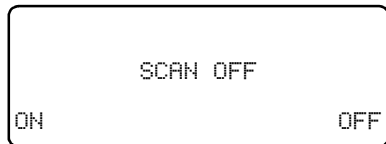

- 2 Press , , or  directly below SCAN.

The current scan state is displayed.



- 3 Press , , or  directly below ON or OFF. When scan is on, the scan status symbol () is displayed.

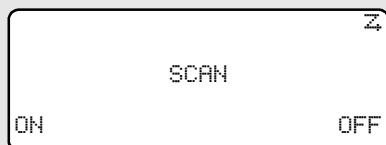

OR

To exit the display menu without changing the scan state, press  or PTT.

Use the Preprogrammed Scan On/Off Switch

- 1 Place the **Scan On/Off** switch in the Scan On or Scan Off position.

The current scan state is displayed. When scan is on, the scan status symbol () is displayed.



Note: To exit the display menu without changing the scan state, press  or **PTT**.

Note: When an ID-based call is answered, the alias appears in the display.

Individual Calls

Telephone Calls

Use your radio to make and receive standard phone calls. A landline phone can be used to call a radio, or a radio can be used to call a landline phone.

Answer a Phone Call

Use the Preprogrammed Call Response Button

- 1 When a phone call is received, you hear a telephone-type ringing, the LED flashes GREEN, the call-received symbol (☎) flashes, and PHONE CALL is displayed.

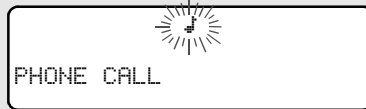

- Telephone ringing
- Flashing GREEN LED



- 2 Press the **Call Response** button within 20 seconds after the call indicators begin.
- 3 Press and hold the **PTT** button to talk; release it to listen.
- 4 Press  to hang up.

Make a Phone Call

Use the Menu



- 1 Press  to find PHON.

PHON

- 2 Press , , or  directly below PHON.

The last transmitted phone number is displayed.

555-1234

- 3 Press  or  to scroll to the phone number you want in the list.

- 4 Press the **PTT** button to start the phone call to the displayed number.

OR

Press the preprogrammed **Quick Access** button to start the phone call to the displayed number.

- 5 Hold the **PTT** button to talk, release it to listen.

Use the Keypad

- 1 Press  to find PHON.

PHON

- 2 Press , , or  directly below PHON.

The last transmitted phone number is displayed.

555-1234

- 3 Enter the phone number you want using the keypad.



- 4 Press the **PTT** button to start the phone call to the displayed number.

OR

Or press the preprogrammed **Quick Access** button to start the phone call to the displayed number.

- 5 Hold the **PTT** button to talk, release it to listen.

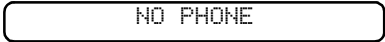
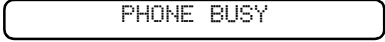
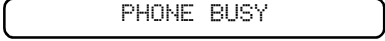
Phone Call Display and Alert Prompts

<ul style="list-style-type: none"> When you press the PTT button and the phone system is not available, a long tone sounds. 	
<ul style="list-style-type: none"> When a channel is not available, a busy tone sounds. The radio will automatically connect when a channel opens. 	
<ul style="list-style-type: none"> When the phone system is busy, a long tone sounds. Exit the phone mode and try your call later. 	
<ul style="list-style-type: none"> The system does not acknowledge your call. 	
<ul style="list-style-type: none"> If NO PHONE or NO ACKNOWLEDG is displayed, or after you finish your call, press  or the PTT button, to hang up. Radio returns to the home display. 	
<p>Notes:</p> <ul style="list-style-type: none"> You might need to dial an extension number after you reach the number you called. A high-pitched tone, generated when you release the PTT button, indicates to the landline party that he or she can begin talking. You have the option of sending additional digits (overdial), such as credit card or PIN numbers, to the phone system. If the radio is programmed for live overdial, every digit entered after the call is connected is sent to the phone system. If the radio is programmed for buffered overdial, the digits pressed are entered into memory and then sent when the PTT button is pressed. Press the PTT to send either digits or voice, but not both at the same time. 	

Enhanced Private-Conversation Calls (Trunked Channels Only)

These one-to-one calls between two radios are not heard by others in the current talkgroup. The calling radio automatically verifies the receiving radio is active on the system and can display the caller's ID.

Answer a Private Call

Use the Preprogrammed Call Response Button.

- 1 When a private call is received, you hear two alert tones, the LED flashes GREEN, the call-received symbol (📞) flashes, and CALL RECEIVED is displayed.



- Two tones
- Flashing GREEN LED

- 2 Press the **Call Response** button within 20 seconds.

If the caller's name is in the call list, it will be displayed.

OR

If the name is not in the call list, the caller's ID number is displayed.

- 3 Press and hold the **PTT** button to talk; release it to listen.



- 4 Press  or the **Call Response** button to hang up.

Make a Private Call

Use the Menu



- 1 Press  to find CALL.

CALL

- 2 Press , , or  directly below CALL.

ID: 00722588

The last private call sent or received is displayed.

- 3 Press  or  to scroll to the ID number you want in the list.

OR

Type the ID number using the keypad.

- 4 Press the **PTT** button to start the Private Call to the displayed number.

OR

Press the preprogrammed **Quick Access** button to start the phone call to the displayed number.

- 5 The called ID is momentarily displayed, followed by PLEASE WAIT. The called ID is displayed once connected.

If the system does not acknowledge the call, NO ACKNOWLEDG is displayed.

NO ACKNOWLEDG



If the target radio does not respond before the time out, NO ANSWER is displayed.

NO ANSWER

Use the Keypad

- 1 Press  to find CALL.

CALL

- 2 Press , , or  directly below CALL.

ID: 00722588

The last private call sent or received is displayed.

- 3 Use the keypad to enter the ID number you want to call.

- 4 Press the **PTT** button to start the Private Call to the displayed number.

OR

Press the preprogrammed **Quick Access** button to start the phone call to the displayed number.

- 5 The called ID is momentarily displayed, followed by PLEASE WAIT. The called ID is displayed once connected.

If the system does not acknowledge the call, NO ACKNOWLEDG is displayed.

NO ACKNOWLEDG

If the target radio does not respond before the time out, NO ANSWER is displayed.

NO ANSWER

Call Alert Paging

(Trunked Channels Only)

Call Alert allows your radio to work like a pager. Even if other users are away from their radios, or if they are unable to hear their radios, you can still send them a Call Alert page. With Call Alert paging, you can also verify if a radio is active on the system.

Answer a Call Alert Page

- 1 When a Call Alert Page is received, you hear two alert tones, the LED flashes GREEN, the call-received symbol (📡) flashes, and PAGE RECEIVED is displayed.



- Two tones
- Flashing GREEN LED

- 2 Press the **Top Side** button to stop the Alert Tone.
- 3 If the call is acknowledged, press and hold the **PTT** button to talk, release it to listen.

Make a Call Alert

Use the Menu



- 1 Press  to find PAGE.

PAGE

- 2 Press , , or  directly below PAGE.

ID: 00722588

The page sent or received is displayed.

- 3 Press  or  to scroll to the ID number you want in the list.

- 4 Press the **PTT** button to start the Call Alert Page to the displayed number.

OR

Press the preprogrammed **Quick Access** button to start the page to the displayed number.

PLEASE WAIT is displayed.
The home display appears once you are connected.



If the system does not acknowledge the call, NO ACKNOWLEDG is displayed.

NO ACKNOWLEDG

Use the Keypad



- 1 Press  to find PAGE.

PAGE

- 2 Press , , or  directly below PAGE.

ID: 00722588

The last page sent or received is displayed.

- 3 Press  or  to scroll to the ID number you want in the list.

- 4 Enter the ID number you want using the keypad.

OR

Press the preprogrammed **Quick Access** button to start the page to the displayed number.

PLEASE WAIT is displayed. The home display appears once you are connected.

If the system does not acknowledge the call, NO ACKNOWLEDG is displayed.

NO ACKNOWLEDG



Conventional Talkgroup Calls (Conventional Operation Only)

Talkgroup Call lets you define a group of conventional system users so that they can share the use of a conventional channel.



Select Talkgroup



- 1 Press  to find TGRP.



- 2 Press , , or  directly below TGRP.

The last user-selected-and-stored talkgroup, and its available softkeys, are displayed.

- 3 Press  or  to scroll through the status list, or use the keypad to enter the number of the desired index.

- 4 Press , , or  directly below PSET (to select the preset or programmed talkgroup), or below SEL (to save the talkgroup and return to the home display).



- 5 To exit, press  or the **PTT** button, or turn the **16-Position Select** knob.

Status Calls (Trunked Radios Only)

You can send data calls to the dispatcher about a predefined status. Each status can have up to a 12-character alias. A maximum of eight aliases is possible.

Send a Status Call



Use the Menu

- 1 Press  to find STS.

STS

- 2 Press , , or  directly below STS.

The last acknowledged status call or the first status in the list is displayed.

- 3 Press  or  to scroll through the status list

OR

Use the keypad to enter a number corresponding to the location in the status list.

- 4 Press the **PTT** button to send the status.

When the dispatcher acknowledges, four beeps sound and **ACK RECEIVED** is displayed.

ACK RECEIVED

If no acknowledgment is received, you will see **NO ACKNOWLEDG.**

NO ACKNOWLEDG

- 5 Press  to go to the home display.



Note: No traffic is heard on trunked channels while Status Calls is selected.
If the radio detects no Status Call activity for six seconds, an alert tone sounds until the  or **PTT** button is pressed.

Send a Status Call

Use the Preprogrammed Status Button

- 1 Press the preprogrammed **Status** Button.

The last acknowledged status call or the first status in the list is displayed.

- 2 Press  or  to scroll through the status list.

OR

Use the keypad to enter a number corresponding to the location in the status list.

- 3 Press the **PTT** button to send the status.

When the dispatcher acknowledges, four beeps sound and `ACK RECEIVED` is displayed.

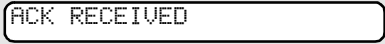

ACK RECEIVED

If no acknowledgment is received, you will see `NO ACKNOWLEDG`.



NO ACKNOWLEDG

- 4 Press  to go to the home display.
-

Note: No traffic is heard on trunked channels while Status Calls is selected.

If the radio detects no Status Call activity for six seconds, an alert tone sounds until the  or **PTT** button is pressed.

Repeater or Direct Operation

Also known as TALKAROUND operation, DIRECT lets you bypass the repeater and connect directly to another radio. The transmit and receive frequencies are the same.



REPEATER operation increases the radio's range by connecting with other radios through a repeater. Transmit and receive frequencies are different.

Select Repeater or Direct Operation

Use the Menu

- 1 Press  to find DIR.



- 2 Press , , or  directly below DIR. The current operation is momentarily displayed.

For Direct mode:

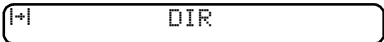

For Repeater mode:





- 3 Press , , or  directly below DIR or RPTR.

- 4 Press  to exit display menu without changing the current operation.

Use the Preprogrammed Repeater/Direct Switch

- 1 Place the **Repeater/Direct** Switch in Repeater or Direct position.





- 2 Press , , or  directly below **DIR**. The current operation is momentarily displayed.

For Direct mode:



For Repeater mode:



- 3 Press , , or  directly below **DIR** or **RPTR**.

- 4 Press  to exit display menu without changing the current operation.
-

Special Radio Features

PTT ID

Receive









This feature allows you to see the radio ID number of the radio you are currently receiving. This ID can be a maximum of eight characters and can be viewed by both the receiving radio and the dispatcher.

Transmit

Your radio's ID number is automatically sent every time the **PTT** button is pressed. This is a per-channel feature. For digital voice transmissions, your radio's ID is sent continuously during the voice message.

View Your Radio's ID Number

Use the Menu

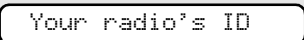
- 1 Press  or  to find CALL or PAGE.  or 
- 2 Press , , or  directly below CALL or PAGE.
- 3 Press . 

Use the Preprogrammed Call or Page Button

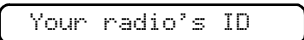
- 1 Press the **Call** or **Page** button.
 - 2 Press . 
-

Trunking System Controls

Failsoft

The failsoft system ensures continuous radio communications during a trunked system failure. If a trunking system fails completely, the radio goes into failsoft operation and automatically switches to its failsoft channel.

During failsoft operation:

Your radio transmits and receives in conventional operation on a predetermined frequency.

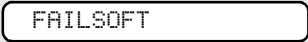

FAILSOFT

You hear a medium-pitched tone every 10 seconds.

When the trunking system returns to normal operation, your radio automatically leaves failsoft operation and returns to trunked operation.

Out-of-Range

If you go out of the range of the system, and can no longer lock onto a control channel:

The display shows **OUT OF RANGE** and the currently selected zone/channel combination, and/or you hear a low-pitched tone.

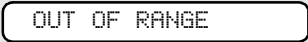

OUT OF RANGE

- Low-pitched tone

Your radio remains in this out-of-range condition until:

- It locks onto a control channel,
- It locks onto a failsoft channel, or
- It is turned off.

Site Lock

This feature allows your radio to lock onto a specific site and not roam among wide-area talkgroup sites. This feature should be used with caution, since it inhibits roaming to another site in a wide-area system.

Lock or Unlock a Site

Use the Menu

- 1 Press  or  to find SITE.

SITE



- 2 Press , , or  directly below SITE.

The current lock state is displayed.

LOCK

or

UNLK

- 3 Press , , or  directly below LOCK or UNLK.

- The new site-lock state is saved.
- Your radio returns to the home display.

Use the Preprogrammed Site Lock/Unlock Button

- 1 Press the **Site Lock/Unlock** button.

The current lock state is momentarily displayed.

LOCK

or

UNLK

- 2 Press and hold the **Site Lock/Unlock** button until you see the desired lock state.

Site Trunking

If the zone dispatcher loses communication with any site, that site reverts to what is known as “site trunking.” The display shows “SITE TRUNKING” and the currently selected zone/channel combination.

When this occurs, you can communicate only with other radios within your trunking site.

Site View and Change

View the Current Site

Momentarily press the preprogrammed **Site Search** button.

The display shows either the number of the current site and its corresponding Received Signal Strength Indicator (RSSI) symbol (📶)

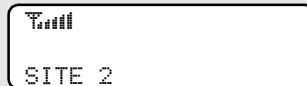

OR

If the radio is scanning for a new site, the display momentarily shows SCANNING SITE.



Change the Current Site

Press and hold down the preprogrammed **Site Search** button to manually force the change to a new site.

You hear a tone, and the display shows SCANNING SITE while the radio scans for a new site.

The radio returns to the home display when it finds a new site.



SCANNING SITE

Real Time Clock

Using this special feature, you may program the time and date as you might with other electronic devices. The clock display is enabled by a qualified radio technician.

- The default time setting is a 12-hour clock.

12HR 00:00AM



- If a 24-hour clock is selected, AM/PM selection is not available.
- The default setting for the domestic date shows MDY.

MDY 00/00/00



Program Time and Date

- 1 Press  to find **CLK**.

CLK

- 2 Press , , or  directly below **CLK**. The current setting is displayed.

12HR 03:54AM
MDY 03/07/01
EDIT

- 3 Press , , or  directly below **EDIT**. The first item flashes.

 12HR 03:54AM
MDY 03/07/01
SAVE

- 4 Press  or  to change the selected item.



24HR 03:54
MDY 03/07/01
SAVE

Note: Press  at any time to return to the home display without saving your changes.

OR

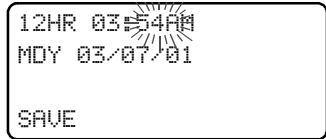
Press  one or more times to move to an item you wish to change.



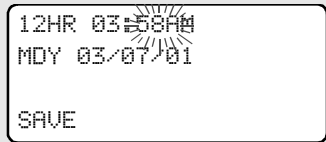

5 Press  or  to change the selected item.



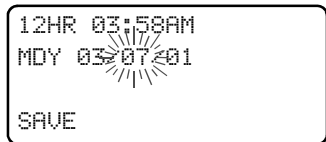

6 Press  one or more times to move to an in the date field.



7 Press  or  to change the selected item.



8 When you have made all your changes, press , , or  directly below SAVE to save your changes and return to the Home display.

Note: If a call arrives while the radio is in the clock-setting menu, the radio exits clock setting, your changes are lost, and the call information is displayed.

Notes

Helpful Tips

Radio Care

Cleaning

To clean the external surfaces of your radio:

- 1 Combine one teaspoon of mild dishwashing detergent to one gallon of water (0.5% solution).
- 2 Apply the solution sparingly with a stiff, non-metallic, short-bristled brush, making sure excess detergent does not get entrapped near the connectors, controls or crevices. Dry the radio thoroughly with a soft, lint-free cloth.
- 3 Clean battery contacts with a lint-free cloth to remove dirt or grease.



Caution

Do not use solvents to clean your radio. Spirits may permanently damage the radio housing.

Do not submerge the radio in the detergent solution.

Handling

- Do not pound, drop, or throw the radio unnecessarily. Never carry the radio by the antenna.
- Avoid subjecting the radio to an excess of liquids.
- Avoid subjecting the radio to corrosives, solvents or spirits.
- Do not disassemble the radio.
- Keep the accessory-connector cover in place until ready to use the connector. Replace the cover immediately once the accessory has been disconnected.

Service

Proper repair and maintenance procedures will assure efficient operation and long life for this product. A Motorola maintenance agreement will provide expert service to keep this and all other communication equipment in perfect operating condition. A nationwide service organization is provided by Motorola to support maintenance services. Through its maintenance and installation program, Motorola makes available the finest service to those desiring reliable, continuous communications on a contract basis. For a contract service agreement, please contact your nearest Motorola service or sales representative, or an authorized Motorola dealer.

Express Service Plus (ESP) is an optional extended service coverage plan, which provides for the repair of this product for a period of three years from the date of shipment from the factory, or the date of delivery if purchased from an authorized Motorola two-way radio dealer. For more information about ESP, contact the Motorola Radio Support Center at 3761 South Central Avenue, Rockford, IL 61102 (800) 227-6772 / (847)725-4200.

Battery

Battery Life

Battery life is determined by several factors. Among the more critical are the regular overcharge of batteries and the average depth of discharge with each cycle. Typically, the greater the overcharge and the deeper the average discharge, the fewer cycles a battery will last. For example, a battery which is overcharged and discharges 100% several times a day, will last fewer cycles than a battery that receives less of an overcharge and is discharged to 50% per day. Further, a battery which receives minimal overcharging and averages only 25% discharge, will last even longer.

Charging the Battery

Motorola batteries are designed specifically to be used with a Motorola charger and vice-versa. Charging in non-Motorola equipment may lead to battery damage and void the battery warranty. Motorola-authorized battery chargers may not charge batteries other than the ones listed on page 55.

The battery should be at about 77°F (25°C) (room temperature), whenever possible. Charging a cold battery (below 50° F [10°C]) may result in leakage of electrolyte and ultimately in failure of the battery. Charging a hot battery (above 95°F [35°C]) results in reduced discharge capacity, affecting the performance of the radio. Motorola rapid-rate battery chargers contain a temperature-sensing circuit to ensure that batteries are charged within the temperature limits stated above.

Battery Charge Status

Your radio can indicate your battery's charge status by the following:

LED and Sounds

- you see the LED flash red when the PTT Button is pressed indicating low battery
- you hear a low-battery “chirp” (short, high-pitched tone)

Battery Recycling and Disposal

Nickel-cadmium (NiCd) rechargeable batteries can be recycled. However, recycling facilities may not be available in all areas. Under various U.S. state laws and the laws of several other countries, NiCd batteries must be recycled and cannot be disposed of in landfills or incinerators. Contact your local waste management agency for specific requirements and information in your area.

Motorola fully endorses and encourages the recycling of NiCd batteries. In the U.S. and Canada, Motorola participates in the nationwide Rechargeable Battery Recycling Corporation (RBRC) program for NiCd battery collection and recycling. Many retailers and dealers participate in this program.

For the location of the drop-off facility closest to you, access RBRC's Internet web site at www.rbrc.com or call 1-800-8-BATTERY. This internet site and telephone number also provide other useful information concerning recycling options for consumers, businesses, and governmental agencies.

Antenna

Radio Operating Frequencies

Before installing the antenna, make sure it matches your radio's operating frequency. Antennas are frequency sensitive and are color coded according to their frequency range. The color code indicator is located in the center of the antenna's base.

Your radio's operating frequency is 806 to 870 MHz.

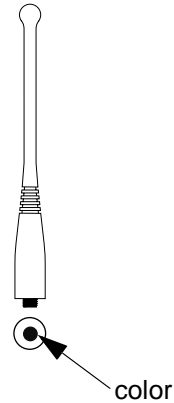

The following antenna types are compatible with your radio:

Antenna type	Approx. length		Insulator color code	Frequency range	Antenna kit no.
	in.	mm			
800 MHz Whip, Halfwave	7	175	RED	806-870 MHz	NAF5037
800MHz Stubby, Quarterwave	3.3	83	WHITE	806-870 MHz	NAF5042

Accessories

Motorola provides the following approved accessories to improve the productivity of your XTS 2500 portable two-way radio.

Antennas

NAF5037	806-870 MHz Whip, Half-wave, 7 inch
NAF5042	806-870 MHz Quarter Wave, 3 inch, Stubby

Audio

Headsets

BDN6635	Boom Mic Headset with VOX (Adapter BDN6673)
BDN6636	Throat Mic Headset with VOX (Adapter BDN6673)
BDN6673	Headset Adapter Cable for use with BDN6645, BDN6635, and BDN6636
NMN6245	Light Weight Headset
NMN6259	Medium Weight Dual Headset with NC Mic
NMN1020	Safety Helmet Headset (adapter BDN6676) NKN6498 and NKN6050
RMN4049	Jedi "TEMCO" Temple Transducer

Remote Speaker Microphones

NMN6193	Remote Speaker Microphone
---------	---------------------------

Surveillance

BDN6665	Earpiece with Extra-Loud Earphone (exceeds OSHA limits)
BDN6666	Earpiece with Volume Control
BDN6667	Earpiece, Mic and PTT Combined
BDN6668	Earpiece, Mic and PTT Separate
BDN6671	PTT and VOX Interface Module for use with BDN6677, BDN6678, and BDN6641
BDN6676	Adapter, 3.5 mm with PTT switch
BDN6677	Ear Microphone, Standard 95 dB (Black)
BDN6678	Ear Microphone, Standard 95 dB (Beige)
BDN6708	PTT Interface Module for use with BDN6677, BDN6678, and BDN6641
BDN6780	Earbud, Single with Mic and PTT Combined
NTN1624	CommPort™ w/ Palm PTT NTN8819 and NKN6510

Batteries

NTN9815	NiCd High Capacity
NTN9816	NiCd High Capacity, Factory Mutual Intrinsically Safe
NTN9857	NiMH Ultra-High Capacity, Factory Mutual Intrinsically Safe
NTN9858	NiMH Ultra-High Capacity

Belt Clips

HLN6853	Belt Clip, 2 1/4 inch
HLN9844	Belt Clip, 2 inch

Body-Worn

NTN8036	Carry case, 2.5 inch loop with swivel
NTN8038	Carry case, 3.0 inch loop with swivel

Chargers

NTN1168	Single-Unit, Dual Rate, Rapid; 110 V
NTN1169	Single-Unit, Dual Rate, Rapid; 220 V (2-prong Euro plug)
NTN1170	Single-Unit, Dual Rate, Rapid; 240 V (3-prong UK plug)
NTN1177	Multi-Unit, Dual Rate, Rapid: 110 V
NTN1178	Multi-Unit, Dual Rate, Rapid: 240 V (3-prong UK plug)
NTN1179	Multi-Unit, Rapid: 240V (UK 13 MAP Plug)
NTN1667	Tri-Chemistry; 110 V
NTN1669	Tri-Chemistry; 230 V
NTN7209	Single-Unit Dual Rate, Rapid w/o Cord
NTN8726	Multi-Unit, Universal; 220 V
NTN8727	Multi-Unit, Universal; 240 V
NTN9176	Vehicular, Tri-Chemistry, XTS3000, XTS 3500, and compatible with PAC•RT
WPLN4111_R	IMPRES™ Single-Unit Smart Charger, 110V

Note: Charge only the battery, not the radio with the battery attached, with NTN1177, NTN1178, and NTN1179.

Enhanced and Multi-Unit Line Cords

NTN7373	110 V Interchangeable Line
NTN7374	220 V Interchangeable Line (2 prong Euro plug)
NTN7375	240 V Interchangeable Line (3 prong Euro plug)

Glossary

This is a list of specialized terms used in this manual.

ACK	Acknowledgment of communication.
Active Channel	A channel that has traffic on it.
Analog Signal	An RF signal that has a continuous nature rather than a pulsed or discrete nature.
Call Alert	Privately page an individual by sending an audible tone.
Carrier Squelch	Feature that responds to the presence of an RF carrier by opening or unmuting (turning on) a receiver's audio circuit. A squelch circuit silences the radio when no signal is being received so that the user does not have to listen to "noise."
Central Controller	A software controlled, computer-driven device that receives and generates data for the trunked radios assigned to it. It monitors and directs the operations of the trunked repeaters.
Channel	A group of characteristics such as transmit/receive frequency pairs, radio parameters, and encryption encoding.
Control Channel	In a trunking system, one of the channels that is used to provide a continuous, two-way/data communications path between the central controller and all radios on the system.
Conventional	Typically refers to radio-to-radio communications, sometimes through a repeater. (See Trunking.)
Cursor	A visual tracking marker (a blinking line) that indicates a location on the display.

Deadlock	Displayed by the radio after three failed attempts to unlock the radio. The radio must be powered off and on prior to another attempt.
Digital Private Line (DPL)	A type of coded squelch using data bursts. Similar to PL except a digital code is used instead of a tone.
Digital Signal	An RF signal that has a pulsed, or discrete nature, rather than a continuous nature.
Dispatcher	An individual who has radio system management duties.
Failsoft	The failsoft system allows communications to take place even though the central controller has failed. Each trunked repeater in the system will key, and transmit a data word informing every radio that the system has gone into failsoft.
FCC	Federal Communications Commission.
Hang Up	Disconnect.
Home Display	The first display information after the radio completes its self test.
LCD	Liquid Crystal Display.
LED	Light-emitting diode.
Monitor	Check channel activity by pressing the Monitor button. If the channel is clear, you will hear static. If the channel is in use, you will hear conversation. It also serves as a way to check the volume level of the radio, as the radio will “open the squelch” when pressing the monitor button.
Network Access Code	Network Access Code (NAC) operates on digital channels to reduce voice channel interference between adjacent systems and sites.

NiCd	Nickel Cadmium.
NiMH	Nickel Metal Hydride.
Non-tactical/Revert	The user will talk on a preprogrammed emergency channel. The emergency alarm is sent on this same channel.
Page	A one-way alert, with audio and/or display messages.
Personality	A set of unique features specific to a radio.
Preprogrammed	A feature that has been assigned in advance by a qualified technician.
Private (Conversation) Call	Allows you to have a private conversation with another radio user in the group.
Private Line (PL)	A sub-audible tone that is transmitted such that only receivers decoding this tone will hear the message.
Programmable	A radio control that can have a radio feature assigned to it.
PTT	Push-To-Talk — the PTT button engages the transmitter and puts the radio in transmit (send) operation when pressed.
Radio Frequency (RF)	The part of the general frequency spectrum between the audio and infrared light regions (about 10 kHz to 10,000,000 MHz).
Repeater	A conventional radio feature, where you talk through a receive/transmit facility (repeater), that re-transmits received signals in order to improve communications range and coverage.
Selective Switch	See Network Access Code (NAC). Any digital traffic having the correct Network Access Code and the correct talkgroup.

Squelch	Special electronic circuitry added to the receiver of a radio which reduces, or squelches, unwanted signals before they are heard in the speaker.
Standby	An operating condition whereby the radio's speaker is muted but still continues to receive data.
Status Calls	Pre-defined text messages which allow the user to send conditional messages without talking.
Tactical/Non-revert	The user will talk on the channel that was selected before the radio entered the emergency state.
Talkaround	Bypass a repeater and talk directly to another unit for easy local unit-to-unit communications.
Talkgroup	An organization of radio users who communicate with each other.
Trunking	The automatic sharing of communications paths between a large number of users. (See Conventional.)
Zone	A grouping of channels.

Commercial Warranty

Limited Warranty

MOTOROLA COMMUNICATION PRODUCTS

I. WHAT THIS WARRANTY COVERS AND FOR HOW LONG:

MOTOROLA INC. (“MOTOROLA”) warrants the MOTOROLA manufactured Communication Products listed below (“Product”) against defects in material and workmanship under normal use and service for a period of time from the date of purchase as scheduled below:

ASTRO XTS 2500 Portable Units	One (1) Year
Product Accessories	One (1) Year

Motorola, at its option, will at no charge either repair the Product (with new or reconditioned parts), replace it (with a new or reconditioned Product), or refund the purchase price of the Product during the warranty period provided it is returned in accordance with the terms of this warranty. Replaced parts or boards are warranted for the balance of the original applicable warranty period. All replaced parts of Product shall become the property of MOTOROLA.

This express limited warranty is extended by MOTOROLA to the original end user purchaser only and is not assignable or transferable to any other party. This is the complete warranty for the Product manufactured by MOTOROLA. MOTOROLA assumes no obligations or liability for additions or modifications to this warranty unless made in writing and signed by an officer of MOTOROLA. Unless made in a separate agreement between MOTOROLA and the original end user purchaser, MOTOROLA does not warrant the installation, maintenance or service of the Product.

MOTOROLA cannot be responsible in any way for any ancillary equipment not furnished by MOTOROLA which is attached to or used in connection with the Product, or for operation of the Product with any ancillary equipment, and all such equipment is expressly excluded from this warranty. Because each system which may use

the Product is unique, MOTOROLA disclaims liability for range, coverage, or operation of the system as a whole under this warranty.

II. GENERAL PROVISIONS:

This warranty sets forth the full extent of MOTOROLA'S responsibilities regarding the Product. Repair, replacement or refund of the purchase price, at MOTOROLA's option, is the exclusive remedy. THIS WARRANTY IS GIVEN IN LIEU OF ALL OTHER EXPRESS WARRANTIES. IMPLIED WARRANTIES, INCLUDING WITHOUT LIMITATION, IMPLIED WARRANTIES OF MERCHANTABILITY AND FITNESS FOR A PARTICULAR PURPOSE, ARE LIMITED TO THE DURATION OF THIS LIMITED WARRANTY. IN NO EVENT SHALL MOTOROLA BE LIABLE FOR DAMAGES IN EXCESS OF THE PURCHASE PRICE OF THE PRODUCT, FOR ANY LOSS OF USE, LOSS OF TIME, INCONVENIENCE, COMMERCIAL LOSS, LOST PROFITS OR SAVINGS OR OTHER INCIDENTAL, SPECIAL OR CONSEQUENTIAL DAMAGES ARISING OUT OF THE USE OR INABILITY TO USE SUCH PRODUCT, TO THE FULL EXTENT SUCH MAY BE DISCLAIMED BY LAW.

III. STATE LAW RIGHTS:

SOME STATES DO NOT ALLOW THE EXCLUSION OR LIMITATION OF INCIDENTAL OR CONSEQUENTIAL DAMAGES OR LIMITATION ON HOW LONG AN IMPLIED WARRANTY LASTS, SO THE ABOVE LIMITATION OR EXCLUSIONS MAY NOT APPLY.

This warranty gives specific legal rights, and there may be other rights which may vary from state to state.

IV. HOW TO GET WARRANTY SERVICE:

You must provide proof of purchase (bearing the date of purchase and Product item serial number) in order to receive warranty service and, also, deliver or send the Product item, transportation and insurance prepaid, to an authorized warranty service location. Warranty service will be provided by Motorola through one of its authorized warranty service locations. If you first contact the company which sold you the Product (e.g., dealer or communication service

provider), it can facilitate your obtaining warranty service. You can also call Motorola at 1-800-927-2744 US/Canada.

V. WHAT THIS WARRANTY DOES NOT COVER:

- A) Defects or damage resulting from use of the Product in other than its normal and customary manner.
- B) Defects or damage from misuse, accident, water, or neglect.
- C) Defects or damage from improper testing, operation, maintenance, installation, alteration, modification, or adjustment.
- D) Breakage or damage to antennas unless caused directly by defects in material workmanship.
- E) A Product subjected to unauthorized Product modifications, disassemblies or repairs (including, without limitation, the addition to the Product of non-Motorola supplied equipment) which adversely affect performance of the Product or interfere with Motorola's normal warranty inspection and testing of the Product to verify any warranty claim.
- F) Product which has had the serial number removed or made illegible.
- G) Rechargeable batteries if:
 - any of the seals on the battery enclosure of cells are broken or show evidence of tampering.
 - the damage or defect is caused by charging or using the battery in equipment or service other than the Product for which it is specified.
- H) Freight costs to the repair depot.
- I) A Product which, due to illegal or unauthorized alteration of the software/firmware in the Product, does not function in accordance with MOTOROLA's published specifications or the FCC type acceptance labeling in effect for the Product at

the time the Product was initially distributed from MOTOROLA.

- J) Scratches or other cosmetic damage to Product surfaces that does not affect the operation of the Product.
- K) Normal and customary wear and tear.

VI. PATENT AND SOFTWARE PROVISIONS:

MOTOROLA will defend, at its own expense, any suit brought against the end user purchaser to the extent that it is based on a claim that the Product or parts infringe a United States patent, and MOTOROLA will pay those costs and damages finally awarded against the end user purchaser in any such suit which are attributable to any such claim, but such defense and payments are conditioned on the following:

- A) that MOTOROLA will be notified promptly in writing by such purchaser of any notice of such claim;
- B) that MOTOROLA will have sole control of the defense of such suit and all negotiations for its settlement or compromise; and
- C) should the Product or parts become, or in MOTOROLA's opinion be likely to become, the subject of a claim of infringement of a United States patent, that such purchaser will permit MOTOROLA, at its option and expense, either to procure for such purchaser the right to continue using the Product or parts or to replace or modify the same so that it becomes non-infringing or to grant such purchaser a credit for the Product or parts as depreciated and accept its return. The depreciation will be an equal amount per year over the lifetime of the Product or parts as established by MOTOROLA.

MOTOROLA will have no liability with respect to any claim of patent infringement which is based upon the combination of the Product or parts furnished hereunder with software, apparatus or devices not furnished by MOTOROLA, nor will MOTOROLA have any liability for

the use of ancillary equipment or software not furnished by MOTOROLA which is attached to or used in connection with the Product. The foregoing states the entire liability of MOTOROLA with respect to infringement of patents by the Product or any parts thereof.

Laws in the United States and other countries preserve for MOTOROLA certain exclusive rights for copyrighted MOTOROLA software such as the exclusive rights to reproduce in copies and distribute copies of such Motorola software. MOTOROLA software may be used in only the Product in which the software was originally embodied and such software in such Product may not be replaced, copied, distributed, modified in any way, or used to produce any derivative thereof. No other use including, without limitation, alteration, modification, reproduction, distribution, or reverse engineering of such MOTOROLA software or exercise of rights in such MOTOROLA software is permitted. No license is granted by implication, estoppel or otherwise under MOTOROLA patent rights or copyrights.

VII. GOVERNING LAW:

This Warranty is governed by the laws of the State of Illinois, USA.

Index

A

accessories	
antennas	93
batteries	94
belt clips	95
carry cases	95
chargers	95
multi-unit line cords	96
remote speaker microphones	93
alert tones	21
analog squelch	46
answer a phone call	64
answer a private call	68
Antenna	27
Attach the antenna	27
antenna	
radio operating frequencies	91
attach the adapter	30
attach the battery	25
attach the belt clip	28

B

battery	24
battery charge status	89
charging the battery	24
recycling and disposal	90
battery charge status	24
belt clip	28
Busy Override	80

C

change passwords	44
common radio features	41
conventional mode operation	39
conventional squelch options	46
conventional talkgroup calls	74

D

digital squelch	46
display	14

E

edit a list name	59
------------------	----

edit a list number	55
electromagnetic interference/ compatibility	3
emergency	49
emergency keep-alive	53
exposure to radio frequency energy	1

F

Failsoft	80
failsoft	80
four-way navigation button	19

G

glossary	97
----------	----

H

home button	19
-------------	----

I

individual calls	64
intrinsically safe radio information	7

K

keypad	20
--------	----

L

LED indicators	21
list	
scan list empty	55
view a list	54
lists	54

M

make a call alert	72
make a phone call	65
make a private call	69
menu entry (softkey)	16
menu selection features	18
menu slect buttons	17
mute or unmute keypad tones	45
use the menu	45

N

notations used in this manual11

O

operational warnings5
out-of-range80

P

phone call display and alert
 prompts67
physical features of the radio13
PL defeat47
power level
 transmit power level switch42
programmable features14
PTT ID79

R

radio care
 cleaning87
 handling87
radio lock43
real time clock
 program date and time84
receive and transmit36
remote speaker microphone
 adapter30
remove the adapter30
remove the antenna27
remove the battery25
repeater or direct operation77
 select repeater or direct77

S

safety and general information1
scan62
 conventional62
 talkgroup scan62
 turn scan on and off62
scan list empty55
select a channel34
select a zone33
select talkgroup74

send a silent emergency alarm ...51
send an emergency alarm50
send an emergency call51
service88
site lock81
site trunking82
site view and change82
smart battery condition26
standard accessories24
status calls75
 send a status call75
status symbols15

T

time-out timer48
trunking system controls80
turn the radio off32
turn the radio on32

U

universal connector
 attach the cover29
 remove the cover29
universal connector cover29
use while driving4

V

view a list54

W

warranty101

Z

zones and channels33