

# Two-Way Radios

## *User Guide*



DLR1020, DLR1060 models

**Open Source Software Legal Notices:**

This Motorola product contains Open Source Software. For more information regarding licenses, acknowledgements, required copyright notices and other usage terms, refer to the documentation for this Motorola product at:

[www.motorolasolutions.com/DLR](http://www.motorolasolutions.com/DLR)

# CONTENTS

<b>Contents</b> . . . . .	<b>1</b>
<b>Product Safety</b> . . . . .	<b>3</b>
Acoustic Safety . . . . .	3
<b>Introduction</b> . . . . .	<b>4</b>
Package Contents . . . . .	4
<b>FCC Licensing Information</b> . . . . .	<b>6</b>
<b>Batteries and Chargers Safety Information</b> . . . . .	<b>7</b>
Operational Safety Guidelines . . . . .	8
<b>Radio Overview</b> . . . . .	<b>9</b>
Parts Of The Radio . . . . .	9
Power Button . . . . .	10
Top Button . . . . .	10
Volume Control (+/-) Button . . . . .	10
Audio Accessory Connector . . . . .	10
Microphone . . . . .	10
Antenna . . . . .	10
Tx/Rx Indicator LED . . . . .	10
Push-to-Talk (PTT) Button . . . . .	10
Channel / Menu Button . . . . .	10
The Lithium-Ion (Li-Ion) Battery . . . . .	11
DLR Series Radio Specifications . . . . .	11

Battery Features . . . . .	12
About the Li-Ion Battery . . . . .	12
Battery Recycling and Disposal . . . . .	13
Installing the Lithium-Ion (Li-Ion) Battery . . . . .	14
Removing the Lithium-Ion (Li-Ion) Battery . . . . .	15
Holster . . . . .	16
Power Supply, Adaptor and DLR Single Unit Charger (SUC) Tray . . . . .	16
Battery Life Information . . . . .	17
Battery Status Information . . . . .	17
Estimated Charging Time . . . . .	19
DLR Series Charger LED Indicators . . . . .	21
DLR Radios and Charger Compatibility . . . . .	23
<b>Getting Started</b> . . . . .	<b>25</b>
Turning radio ON/OFF . . . . .	26
Adjusting Volume . . . . .	26
Checking Battery Status . . . . .	27
Transmitting and Receiving . . . . .	27
Talk Permit Tone (TPT) . . . . .	27
Talking to a Group in a Channel . . . . .	28
Browsing / Selecting a Channel . . . . .	28
Private Reply . . . . .	28
Top Button Options . . . . .	28

Talk Range . . . . .	29	Page All Available Status Indicator . . . .	82
DLR and DTR Radios Compatibility . . . . .	29	<b>Customer Programming Software</b>	
Radio Status . . . . .	31	<b>(CPS) . . . . .</b>	<b>83</b>
<b>Advanced Configuration Mode . . . . .</b>	<b>33</b>	CPS Basic Menu Instructions. . . . .	84
Entering Advanced Configuration Mode . . . .	34	<b>Cloning . . . . .</b>	<b>95</b>
Browsing Advanced Configuration Options. .	35	Cloning Radios. . . . .	95
PROFILE ID Number . . . . .	36	Cloning Mode. . . . .	96
Maximum Channels . . . . .	40	Cloning with a Multi-Unit Charger	
Top Button . . . . .	41	(MUC) (Optional Accessory) . . . . .	97
MIC Gain. . . . .	43	Cloning Radio using the Radio to	
Home Channel . . . . .	44	Radio (R2R) Cloning Cable	
Resetting To Factory Defaults. . . . .	45	(Optional Accessory) . . . . .	98
Radio Factory Default Settings . . . . .	46	Wireless PROFILE ID Number	
<b>Special Radio Call Features . . . . .</b>	<b>49</b>	Cloning. . . . .	100
Private Reply . . . . .	49	Cloning Mode Status Indicator. . . . .	102
How Private Reply Works . . . . .	50	<b>Troubleshooting . . . . .</b>	<b>103</b>
Private Reply Status Indicator. . . . .	55	<b>Use and Care . . . . .</b>	<b>108</b>
Direct Call . . . . .	56	<b>Motorola Limited Warranty for</b>	
How Direct Call Works . . . . .	56	<b>the United States and Canada . . . . .</b>	<b>109</b>
Direct Call Status Indicator . . . . .	60	<b>Accessories . . . . .</b>	<b>113</b>
Call All Available . . . . .	64	Audio Accessories . . . . .	113
How Call All Available Works . . . . .	66	Battery . . . . .	113
Call All Available Status Indicator . . . .	72	Cables . . . . .	113
Page All Available . . . . .	73	Chargers . . . . .	113
How Page All Available works . . . . .	75	Carry Accessories . . . . .	114

## PRODUCT SAFETY

### PRODUCT SAFETY AND RF EXPOSURE COMPLIANCE



Caution

Before using this product, read the operating instructions and RF energy awareness information contained in the Product Safety and RF Exposure booklet enclosed with your radio.

#### ATTENTION!

This radio is restricted to occupational use only to satisfy FCC RF energy exposure requirements. For a list of Motorola-approved batteries and other accessories, visit the following website which lists approved accessories:

[www.motorolasolutions.com/DLR](http://www.motorolasolutions.com/DLR)

#### ACOUSTIC SAFETY

Exposure to loud noises from any source for extended periods of time may temporarily or permanently affect your hearing. The louder the

radio's volume, the less time is required before your hearing can be affected. Hearing damage from loud noises is sometimes undetectable at first and can have a cumulative effect.

To protect your hearing :

- Use the lowest volume necessary to do your job.
- Increase the volume only if you are in noisy surroundings.
- Reduce the volume before connecting headset or earpiece.
- Limit the amount of time you use headsets or earpieces at high volume.
- When using the radio without a headset or earpiece, do not place the radio's speaker directly against your ear.
- If you experience hearing discomfort, ringing in your ears, or speeches that are muffled, you should stop listening to your radio through your headset or earpiece, and have your hearing checked by your doctor.

## INTRODUCTION

Thank you for purchasing the Motorola® DLR Series Radio. This radio is a product of Motorola's 80 plus years of experience as a world leader in the designing and manufacturing of communications equipment. The DLR Series radios provide cost-effective communications for businesses such as retail stores, restaurants, schools, construction sites, manufacturing, property and hotel management and more. Motorola professional two-way radios are the perfect communications solution for all of today's fast-paced industries.

**Note:** Read this user guide carefully to ensure you know how to properly operate the radio before use

**Business Radios,  
Mailstop 1C15, Motorola  
8000 West Sunrise Boulevard  
Plantation, Florida 33322**

### PACKAGE CONTENTS

- Radio
- Holster
- Lithium-Ion Battery
- Power Supply
- Quick Reference Guide
- Drop-in Tray Charger with Power Adapter
- Product Safety & RF Exposure Booklet

For product-related questions, contact:

**1-800-448-6686** or visit us at:

**[www.motorolasolutions.com/DLR](http://www.motorolasolutions.com/DLR)**

## FCC LICENSING INFORMATION

DLR Series business two-way radios operate in the license-free 900 MHz ISM Band (902 – 928 MHz) and are subject to the Rules and Regulations of the Federal Communications Commission (FCC).

This device complies with part 15 of the FCC Rules and RSS license-exempt of the Industry Canada. Operation is subject to the following two conditions: (1) This device may not cause harmful interference, and (2) this device must accept any interference received, including interference that may cause undesired operation.

Changes or modifications not expressly approved by Motorola may void the user's authority granted by the FCC/IC to operate this radio and should not be made. To comply with FCC/IC requirements, transmitter adjustments should be made only by or under the supervision of a person certified as technically qualified to perform transmitter maintenance and repairs. Replacement of any transmitter component (crystal, semiconductor, etc.) not authorized by the FCC/IC equipment

authorization for this radio could violate FCC/IC rules.

**Note:** Use of this radio outside the country where it was intended to be distributed is subject to government regulations and may be prohibited.



## BATTERIES AND CHARGERS SAFETY INFORMATION

This document contains important safety and operating instructions. Read these instructions carefully and save them for future reference.

Before using the battery charger, read all the instructions and cautionary markings on

- the charger,
  - the battery, and
  - the radio using the battery
1. To reduce risk of injury, charge only the rechargeable Motorola-authorized batteries. Other batteries may explode, causing personal injury and damage.
  2. Use of accessories not recommended by Motorola may result in risk of fire, electric shock, or injury.
  3. To reduce risk of damage to the electric plug and cord, pull by the plug rather than the cord when disconnecting the charger.
  4. An extension cord should not be used unless absolutely necessary. Use of an improper extension cord could result in risk of fire and electric shock. If an extension cord must be used, make sure that the cord size is 18AWG for lengths up to 100 feet (30.48 m), and 16AWG for lengths up to 150 feet (45.72 m).
  5. To reduce risk of fire, electric shock, or injury, do not operate the charger if it has been broken or damaged in any way. Take it to a qualified Motorola service representative.
  6. Do not disassemble the charger; it is not repairable and replacement parts are not available. Disassembly of the charger may result in risk of electrical shock or fire.
  7. To reduce risk of electric shock, unplug the charger from the AC outlet before attempting any maintenance or cleaning

## **OPERATIONAL SAFETY GUIDELINES**

- Turn the radio OFF when charging battery.
- The charger is not suitable for outdoor use. Use only in dry locations/conditions.
- Connect charger only to an appropriately fused and wired supply of the correct voltage (as specified on the product).
- Disconnect charger from line voltage by removing main plug.
- The outlet to which this equipment is connected should be nearby and easily accessible.
- In equipment using fuses, replacements must comply with the type and rating specified in the equipment instructions.
- Maximum ambient temperature around the power supply equipment must not exceed 40°C (104°F).
- Power output from the power supply unit must not exceed the ratings stated on the product label

located at the bottom of the charger.

- Make sure that the cord is located where it will not be stepped on, tripped over, or subjected to water, damage, or stress.

# RADIO OVERVIEW

## PARTS OF THE RADIO

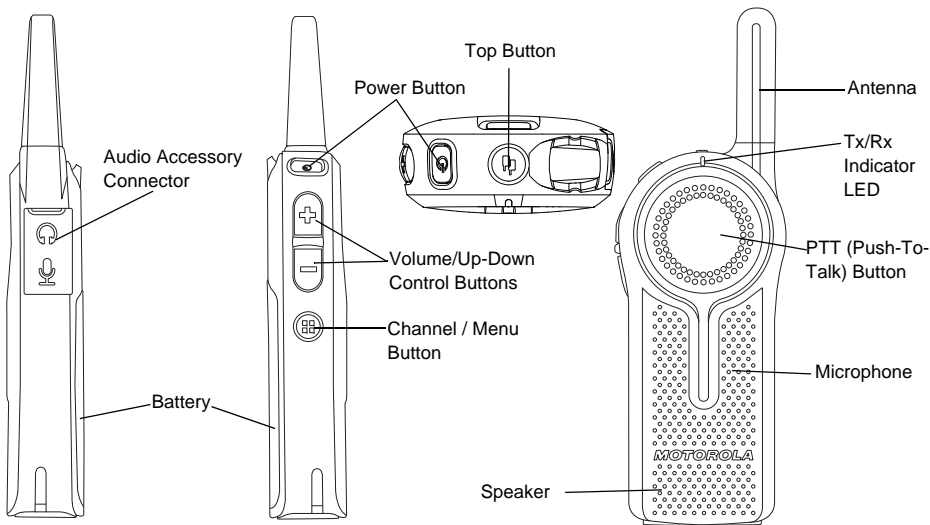

### Power Button

Long press to turn the radio ON or OFF. Short press to check battery status.

### Top Button

The radio Top Button comes defaulted to “Private Reply” feature.

**Note:** For more information regarding programming the Top Button to other features, refer to “Special Radio Call Features” on page 49.

### Volume Control (+/-) Button

Used to increase (+), decrease (-) or mute the volume.

### Audio Accessory Connector

Used to connect compatible audio accessories.

### Microphone

Speak clearly into the microphone when sending a message.

### Antenna

For models **DLR1020** and **DLR1060** the antennas are non-removable.

### Tx/Rx Indicator LED

Used to indicate whether the radio is on standby, receiving or transmitting.

### Push-to-Talk (PTT) Button

To talk, press the PTT (Push to Talk) and **WAIT** to hear the Talk Permit Tone (a quick double beep) **BEFORE** you start speaking. Hold the radio vertically 1 to 2 inches (2.5cm to 5cm) from mouth when talking. Release the PTT to listen.

### Channel / Menu Button

In standard radio operation mode, the Channel/ Menu button comes defaulted to channel function. To change channel, press the Channel / Menu button and then Press the (+) or (-) button to browse channels. Short press the PTT button to exit.

When in Advanced Configuration Mode, Channel / Menu button gives access and allows navigation to set up special features.

## The Lithium-Ion (Li-Ion) Battery

DLR Series comes with a Standard Capacity

Li-Ion battery. Other batteries may be available. For more information, see “Battery Features” on page 12.

## DLR Series Radio Specifications

The radio’s model is shown on the back of the radio and provides the following information:

**Table 1: DLR Series Radio Specifications**

Model	Frequency Band	Transmit Power (Watts)	Number of Channels	Antenna
DLR1020	ISM 900 MHz	1	2	Non-removable
DLR1060	ISM 900 MHz	1	6	Non-removable

## BATTERY FEATURES

DLR Series radios provide standard Lithium-Ion batteries.

**Note:** Batteries with different capacities and operational life may be available in future.

### About the Li-Ion Battery

The DLR Series radio comes equipped with a rechargeable Li-Ion battery. This battery should be fully charged before initial use to ensure optimum capacity and performance.

Battery life is determined by several factors. Among the more critical are the regular overcharge of batteries and the average depth of discharge with each cycle. Typically, the greater the overcharge and the deeper the average discharge, the fewer cycles a battery will last. For example, a battery which is overcharged and discharged 100% several times a day, lasts fewer cycles than a battery that receives less of an overcharge and is discharged to 50% per day. Further, a battery

which receives minimal overcharging and averages only 25% discharge, lasts even longer.

Motorola batteries are designed specifically to be used with a Motorola charger and vice versa. Charging in non-Motorola equipment may lead to battery damage and void the battery warranty. The battery should be at about 77°F (25°C) (room temperature), whenever possible. Charging a cold battery (below 50° F [10°C]) may result in leakage of electrolyte and ultimately in failure of the battery. Charging a hot battery (above 95°F [35°C]) results in reduced discharge capacity, affecting the performance of the radio. Motorola rapid-rate battery chargers contain a temperature-sensing circuit to ensure that batteries are charged within the temperature limits stated above.

## **Battery Recycling and Disposal**

Li-Ion rechargeable batteries can be recycled. However, recycling facilities may not be available in all areas. Under various U.S. state laws and the laws of several other countries, batteries must be recycled and cannot be disposed of in landfills or incinerators. Contact your local waste management agency for specific requirements and information in your area. Motorola fully endorses and encourages the recycling of Li-Ion batteries. In the U.S. and Canada, Motorola participates in the nationwide Rechargeable Battery Recycling Corporation (RBRC) program for Li-Ion battery collection and recycling.

Many retailers and dealers participate in this program. For the location of the drop-off facility closest to you, access RBRC's Internet web site at:

**[www.rbrc.com](http://www.rbrc.com)**



or call:

**1-800-8-BATTERY**

This internet site and telephone number also provides other useful information concerning recycling options for consumers, businesses and governmental agencies.

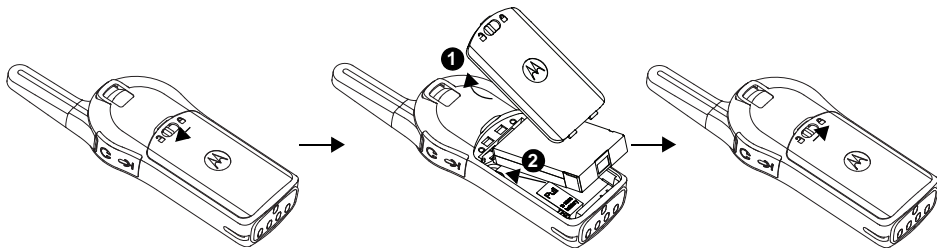
## Installing the Lithium-Ion (Li-Ion) Battery



1. Slide the latch at the top of the battery door to the unlock position  and lift up the battery door at the center recess.
2. Align the battery contacts with the tabs in the battery compartment. Insert the contact side of the battery first, then press the battery down to secure in place.
3. Put the battery door back on the radio. Slide the latch to the lock position .



## Removing the Lithium-Ion (Li-Ion) Battery

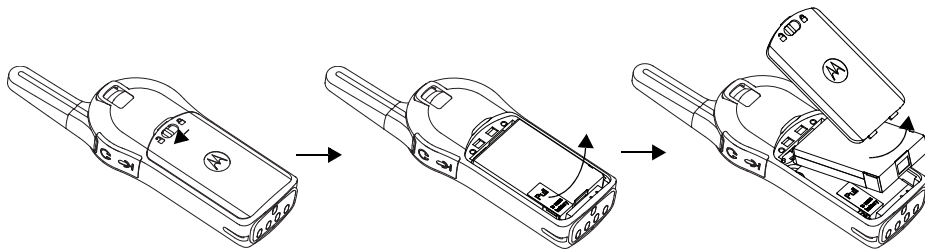

1. Turn OFF the radio.
2. Slide the latch at the top of battery door to the unlock position  and lift up the battery door at the center recess.
3. Pull on the battery removal tab until battery is disengaged from battery compartment.
4. Pull the battery away from radio.

## Holster

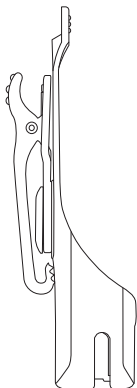

1. Insert the radio into the base of the holster at an angle. Press the radio against the back of the holster until the hooks on the holster are inserted in the top recesses of the battery.
2. To remove, using the top tab on the holster, detach the hooks of the holster from the top recesses of the battery. Slide the radio at an angle and remove from the holster.

## Power Supply, Adaptor and DLR Single Unit Charger (SUC) Tray

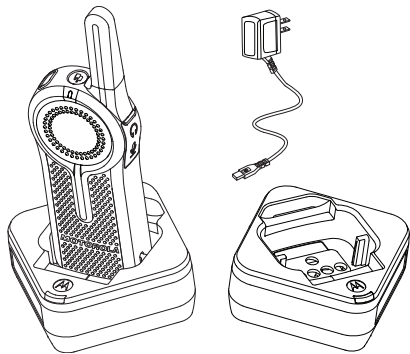

The radio is equipped with one DLR Single Unit Charger (SUC) Tray and one Power Supply with Adaptor. See "Chargers" on page 113 for more information.

## Battery Life Information

When the Battery Save feature is set to ON (enabled by default), the battery life lasts longer. The following table summarizes battery life estimations:

**Table 2: Li-Ion Battery Life for DLR1020 and DLR1060**

Battery Type	Battery Save OFF	Battery Save ON
Standard	10.0 – 12.0 Hours	Up to 14 Hours

**Note:** Battery life is estimated based on 5% transmit / 5% receive / 90% standby standard duty cycle.

## Battery Status Information

To check battery status, short press the Power button. DLR radio also announces battery level every time it powers up.

**Table 3: Battery Status Information**

Battery Status	Battery Level	Voice Prompt or Tone
Battery High	100% – 71%	<i>"Battery level high"</i>
Battery Medium	70% – 41%	<i>"Battery level medium"</i>
Battery Low	40% – 11%	<i>"Battery level low"</i>
Battery Critical	10% – 0%	<i>"Battery level critical"</i>
Battery Shutdown	0%	Shutdown beeps

**Note:** Battery save is ON by default.

**ATTENTION!**

Always turn off the radios prior to charging.  
Radios charge the best of room temperature.

### ***Charging with the Drop-in Tray Single Unit Charger (SUC)***

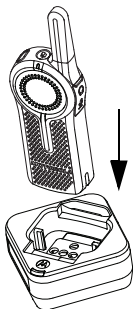

The DLR Series radio comes with a Standard Power Supply and DLR SUC tray.

1. Place the DLR SUC tray on a flat surface.
2. Insert the connector of the power supply into the port on the side of the DLR SUC tray.

3. Plug the AC adaptor into a power outlet.
4. Turn the radio "OFF".
5. Insert the radio into the tray with the front of the radio facing the front of the charger, as shown. Make sure the radio is securely inserted all the way into the charger and the RED LED illuminates to indicate that the battery is charging. See "DLR Series Charger LED Indicators" on page 21 for more information.

**Note:** When charging a battery attached to the radio, turn the radio OFF to ensure a full charge. See "Operational Safety Guidelines" on page 8 for more information.

### ***Charging A Stand-Alone Battery***

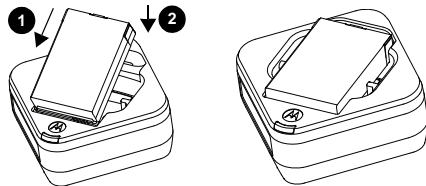

To charge a battery, insert the battery into the charger's pocket by:

1. Aligning the raised tab on each side of the battery with the corresponding groove on each side of the charger pocket.
2. Pressing the battery toward the rear of the pocket.
3. Sliding the battery into the charger pocket, ensuring complete contact between the charger and battery contacts.
4. When the battery is properly seated in the pocket, the charger indicates the Battery Level status as shown in Table 6. The **RED** LED illuminates to indicate that the battery is charging rapidly.
5. The LED changes to a **STEADY GREEN** light to indicate that the battery is **nearly** or fully charged.

**Table 4: Motorola Authorized Batteries**

Part Number	Description
HKNN4013_	Li-Ion Battery 1800mAh

### Estimated Charging Time

The following table provides the estimated charging time of the battery. For more information, see "Battery" on page 113.

**Table 5: Battery Estimated Charging Time**

Charging Solutions	Estimated Charging Time
	Standard Battery
Standard	≤ 3.50 Hours

### Charging a Radio and Battery using a DLR 12-Pocket Multi Unit-Charger - MUC (Optional Accessory)

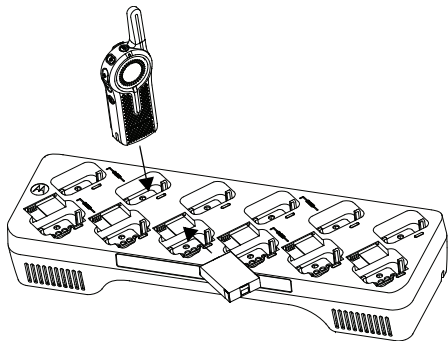

The DLR 12-Pocket Multi-Unit Charger (MUC) allows drop-in charging of up to 12 radios or up to 6 radios and 6 stand-alone batteries. Batteries can be charged with the radios or removed and placed in the MUC separately. Each of the 12 charging pockets can hold a

radio (with or without the Holster) or battery, but not both.









1. Place the Multi-Unit Charger on a flat surface.
2. Insert the power cord plug into the MUC's dual pin connector at the bottom of the MUC.
3. Plug the power cord into an AC outlet.
4. Turn the radio OFF.
5. Insert the radio or battery into the charging pocket with the radio or battery facing away from the contacts.

#### Note:

- This Multi-Unit Charger clones up to 2 radios (2 Source radios and 2 Target radios). Refer to "Cloning with a Multi-Unit Charger (MUC) (Optional Accessory)" on page 97 for more information.
- More information on the Multi-Unit Charger operation is available in the Instruction Sheets provided with the MUC. For more information on the parts and their part numbers, refer to Chapter "Accessories" on page 113.

## DLR Series Charger LED Indicators

Table 6: Charger LED Indicator

Status	LED Status	Comments
Power On	Green for approx. 1 sec 	
Charging	Steady red 	
Charged	Steady green 	
Error (*)	Red fast flash 	
Standby (**)	Amber slow flash 	
Battery Level Status	Flash red 1 time 	Battery low
	Flash amber 2 times 	Battery medium
	Flash green 3 times 	Battery high

(\*) Normally, re-positioning the battery pack will correct this issue.

(\*\*) Battery temperature is too warm or too cold or wrong power voltage is being used.

If there is NO LED indication:

1. Check that the radio, or stand-alone battery, is inserted correctly.
2. Ensure the power supply is plugged into an appropriate AC outlet. (for DLR Single Unit Charger (SUC) Tray only).
3. Ensure the cable is plugged securely into the charger socket (for DLR Single Unit Charger (SUC) Tray only).
4. Ensure the power cord is plugged securely into the charger socket with an appropriate AC outlet and there is power to the outlet (for DLR 12-Pocket Multi Unit Charger Tray only)
5. Confirm that the battery used with the radio is Motorola Solutions authorized batteries listed in Table 4.



Table 7: DLR and CLS Chargers Compatibility

Chargers	Charging Compatibility			
	DLR radio with inserted battery	DLR standalone batteries	CLS radio with inserted battery	CLS standalone batteries
DLR SUC	✓	✓	✓	x
DLR MUC	✓	✓	✓	x
CLS SUC	✓	x	✓	✓
CLS MUC	✓	x	✓	✓

**Note:** Although DLR Series and CLS Series *chargers* are compatible, DLR and CLS radios operate in different frequency bands and will not communicate with each other.

# Notes

# GETTING STARTED

For the following explanations, refer to “Parts Of The Radio” on page 9.

## RADIO BASIC OPERATION

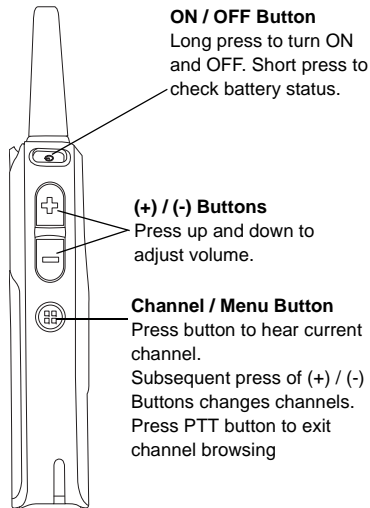
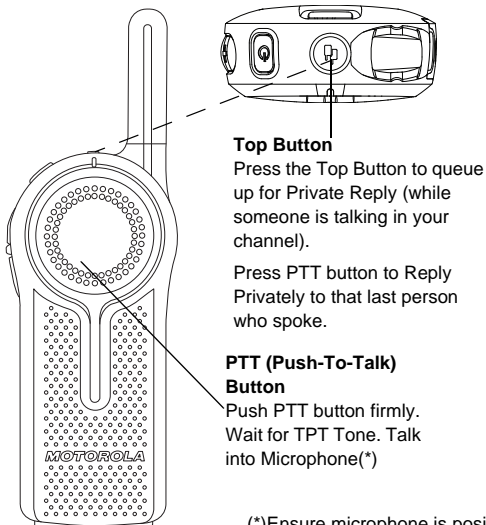

(\*)Ensure microphone is positioned 1 to 2 inches (2.5 to 5 cm) away from mouth

## TURNING RADIO ON/OFF

To turn ON the radio, press and hold the Power button until the radio plays the power up tone and the standby light begins to blink.

**Note:** By default, when radio is turned ON, it announces the current channel name and battery status.

To turn the radio OFF, press and hold the Power button (~3 seconds) until the radio Tx/Rx Indicator LED turns OFF and power down tone is heard.

## ADJUSTING VOLUME

Press the (+) button to increase the volume, or the (-) button to decrease the volume.

To mute, press and hold the (-) button (~2 seconds) until you hear the voice announcement “Mute”.

**Note:** Radio mute means setting the volume to the lowest level. (This is to prevent the user from forgetting to unmute the radio.)

To maximize volume, press and hold the (+) button (~2 seconds). The volume will fast scroll

up to maximum volume. You will hear the volume beeps increment as the volume increases.

**Notes:** Do not hold the radio too close to the ear when the volume is high or when adjusting the volume.

There are 16 increments of volume.

As the (+) / (-) buttons are pressed, you will hear a beep at the current volume level. If device is receiving during volume interaction, received audio will be heard at the new volume instead of beeps.

When using radio with earpiece, make sure to adjust the radio volume to the lowest volume before putting on the earpiece. Refer to “Acoustic Safety” on page 3. Use only Motorola approved accessories. Refer to “Audio Accessories” on page 113 for more information.

## CHECKING BATTERY STATUS

To check the battery status, short press the power button. Refer to “Battery Status Information” on page 17 for more information.

**Note:** The four levels available for battery status are : High, Medium, Low and Critical.

## TRANSMITTING AND RECEIVING

- To receive, listen through the speaker.
- To respond or to talk, press the PTT (Push to Talk) and **WAIT** to hear the Talk Permit Tone (TPT) **BEFORE** you start speaking. Hold the radio vertically 1 to 2 inches (2.5cm to 5cm) from mouth when talking. Release the PTT to listen.
- The Tx/Rx Indicator blinks slowly RED when on standby. When the radio is transmitting, the Tx/Rx Indicator is solid RED.
- When the radio is receiving, the Tx/Rx Indicator LED blinks RED quickly.

**IMPORTANT:**When talking on the radio, make sure not to release the PTT button at any given time. Whether you are transmitting using the PTT button or

using an in-line PTT on the earpiece accessory, always ensure the PTT button is pressed firmly until the transmission is finished. Releasing the PTT button while transmitting and trying to immediately press the PTT button again causes the radio to give a loud denial tone. Wait for 2 seconds and press PTT again to continue speaking. If you press the PTT button to transmit and a busy tone is received instead of a TPT, this means the channel is either not available, busy or there are no users reachable within transmission range.

### Talk Permit Tone (TPT)

TPT is a quick distinctive double beep tone that sounds after the user presses the PTT button, indicating the channel is free to talk. TPT is useful in ensuring orderly communications by preventing radios from transmitting over ongoing conversations.

Always wait to hear the TPT before starting to speak to ensure your words are not cut off.

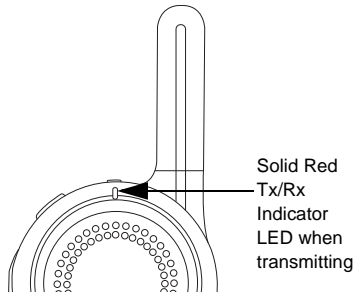

### Talking to a Group in a Channel

To transmit, press the PTT (Push to Talk) and **WAIT** to hear the TPT (Talk Permit Tone) **BEFORE** you start speaking.

### BROWSING / SELECTING A CHANNEL

To select a channel, press the Channel / Menu button until the voice announcement "*Channel <Number>, to change press + or -*" is heard.

Press (+) or (-) buttons to select the desired channel. An audible voice indicates the selected channel.

To exit Channel Change, press the PTT button or wait for the radio Channel / Menu timer to expire.

### PRIVATE REPLY

DLR radio comes with the Top Button configured to Private Reply Feature i.e. when you hear someone talking on the radio, push the Top Button to queue for Private Reply function (Top Button LED indicator blinks orange). Once the person finishes talking, press the PTT button to Reply Privately to that person (Top Button LED illuminates **solid orange**). Voice prompts and tones will guide you on Private call status. For more details on how to use this feature, refer to "Special Radio Call Features" on page 49.

### TOP BUTTON OPTIONS

The Top Button comes pre-programmed with the Private Reply Feature. Top Button can be configured also to allow other different call features such as: Page All Available, Call

Available, Direct Call and Mute. It can also be disabled. For more details on how to configure the Top Button refer to “Advanced Configuration Mode” on page 33.

## TALK RANGE

TALK RANGE		
Model	Industrial	Multi-Level
	Inside steel/ concrete Industrial buildings	Inside multi- level buildings
ISM 900 MHz	Up to 300,000 Sq. Ft.	Up to 20 Floors

For a group of DLR radios to be able to communicate, they need to be on the same channel and have the same radio PROFILE ID number. All radios come by default programmed to PROFILE ID number “0000”

1. **Channel:** Current channel that the radio is using, depending on radio model.
2. **PROFILE ID Number:** ALL the radios in your fleet (independent of the channels that users are assigned to) should use the **SAME PROFILE ID**. It is also **VERY IMPORTANT TO CUSTOMIZE THE PROFILE ID** number in order to avoid interference from other users using the default “0000” number.  
In order to customize your radio fleet PROFILE ID, choose a 4 digit number and enter it using the radio Advanced Configuration Mode (Turn off the radio, Press the PTT, (+) and Power buttons simultaneously and hold until radio announces “*Programming Mode*”. Follow voice prompts). For more information, refer to the “Advanced Configuration Mode” on page 33.

## DLR AND DTR RADIOS COMPATIBILITY

DLR and DTR radios are based on the same digital radio technology and can be used in mixed fleets of DLR and DTR radios. Out of the box, DLR and DTR radios will communicate using the factory default settings.

If you have DTR radios with customized settings and/or private groups, and need to add DLR radios, make sure to use the DLR CPS software(\*) in order to create a compatible configuration in the DLR radios. The same applies if DTR radios are to be added to an existing DLR radio fleet. For more details on DTR and DLR compatibility please contact your Motorola point of sale.

For questions or comments related to this product, please contact Motorola:  
1-800-448-6866

**Note:** (\*) DLR CPS software is available for free download at  
[www.motorolasolutions.com/DLR](http://www.motorolasolutions.com/DLR)



## RADIO STATUS

Radio Status	Front LED Indicator	Top Button LED Indicator	Voice Prompt or Tone
Power Up	Solid Red for 2 seconds	OFF	"Battery Level <Level>, Channel <Number>"
Power Off	Solid Red for 2 seconds	OFF	Power Off chirps
Fatal Error at Power up	Double Blink Red	Single Blink Orange	Not Available
Channel Busy	Not Available	OFF	Busy tone
'Idle' Mode	Heartbeat Red	OFF	Not Available
Transmit (Tx) (standard group call)	Solid Red	OFF	Not Available
Receive (RX) (standard group call)	Fast Red Heartbeat	OFF	Not Available

## Notes

## ADVANCED CONFIGURATION MODE

The DLR Advanced Configuration Mode allows you to configure special settings in your radio without the need of programming cables or additional software.

Advanced Configuration Mode gives access to customize the following features:

- PROFILE ID Number,
- Maximum Channels,
- Top Button,
- Microphone (MIC) Gain, and
- Home Channel.

**Table 1: Advanced Configuration Mode Features**

Feature	Description
PROFILE ID Number	Choose a 4 digit number (0000 – 9999) as your radio PROFILE ID Number. Customize the PROFILE ID Number to ensure interference free / private communications.
Maximum Channels	Choose the maximum number of channels you want to allow for your radio.
Top Button	Set the Top Button with one of the following feature: Private Reply, Direct Call(*), Call All Available, Page All Available, Mute, Disabled.
MIC Gain	Choose between High, Medium or Low MIC Gain to adjust the radio microphone sensitivity level to fit different users or noise environments.
Home Channel	Choose the channel you want to designate as your main channel. Everytime you change to a different channel and no activity is detected from the channel, the radio reverts back to your home channel.

(\*) Only if enabled via CPS

**ENTERING ADVANCED CONFIGURATION MODE**

To enter the Advanced Configuration Mode, power UP using the ON / OFF button while pressing the PTT and (+) buttons simultaneously.

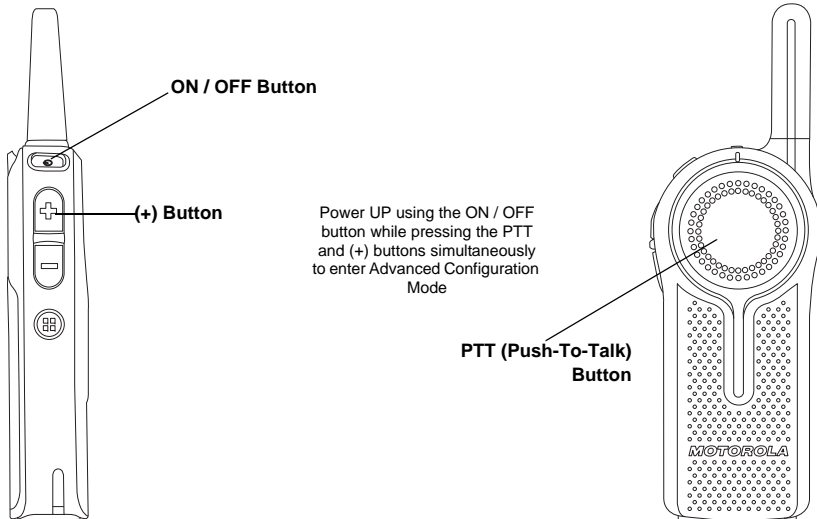

## BROWSING ADVANCED CONFIGURATION OPTIONS

Upon entering Advanced Configuration Mode, radio plays voice prompt *“Programming Mode. Press Menu to continue”*. Press Channel / Menu button to cycle through the Advanced Configuration options.

**Note:** Long press the PTT button at any time to exit the Advanced Configuration Mode altogether.

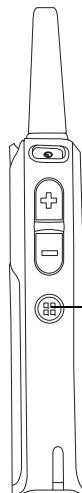
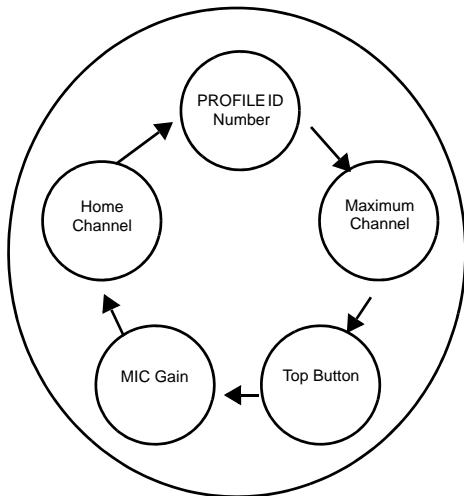

*“Programming Mode.  
Press Menu to continue”.*

**Channel / Menu Button**  
Press to cycle through the Advanced Configuration options.

## PROFILE ID Number

### PROFILE ID Number – Current Value

Once you press the Channel / Menu button, the radio announces the current PROFILE ID Number(\*) and prompts you to change it. Press (+) or (-) button to enter the PROFILE ID Number sub-menu. Alternatively, press the Channel / Menu button to continue to the next Advanced Configuration option.

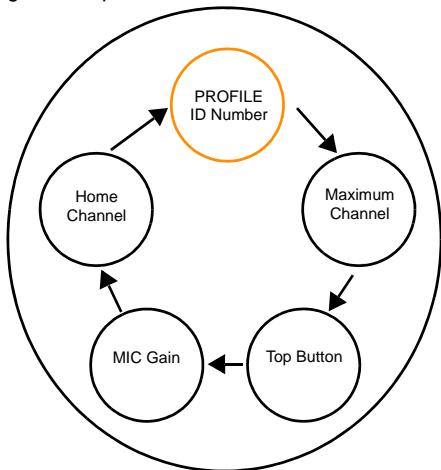

*"Current Profile ID  
<Digit 1, Digit 2, Digit 3,  
Digit 4> to change,  
press plus or minus".*

**(+) / (-) Buttons**

Press to enter the PROFILE ID Number sub-menu

**Channel / Menu Button**

Press to continue to the next Advanced Configuration option

(\*) PROFILE ID Number default is "0000". Change it to avoid interferences and improve privacy.

## PROFILE ID Number – Changing values

Once you press either the (+) or (-) to enter the PROFILE ID Number sub-menu, the radio announces the first digit number value and prompts you to change it(\*). Press (+) or (-) button again to change the first digit number. Press Channel / Menu button to continue to the next digit.

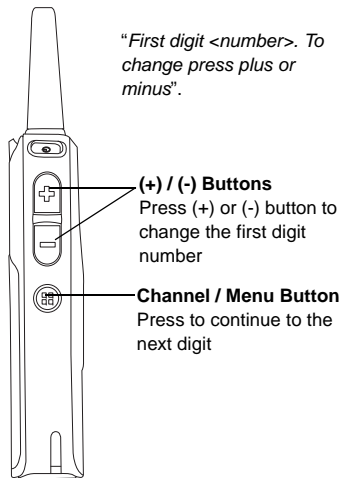
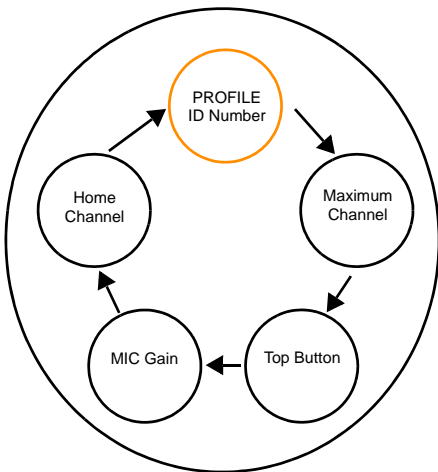

(\* ) There is 10,000 options of PROFILE ID Number to choose from (0000 – 9999).

## PROFILE ID Number – Sub-menu

When you press (+) or (-) button to change the current digit, radio announces the value. Press Channel / Menu to continue to the next digit. Once in Digit 4, press Channel / Menu button again to continue to the next Advanced Configuration option.

**Note:** DLR radio gives you the option to move forward through the 4 digits with the Channel / Menu button. There is no option to move backward through the 4 digits of PROFILE ID Number.

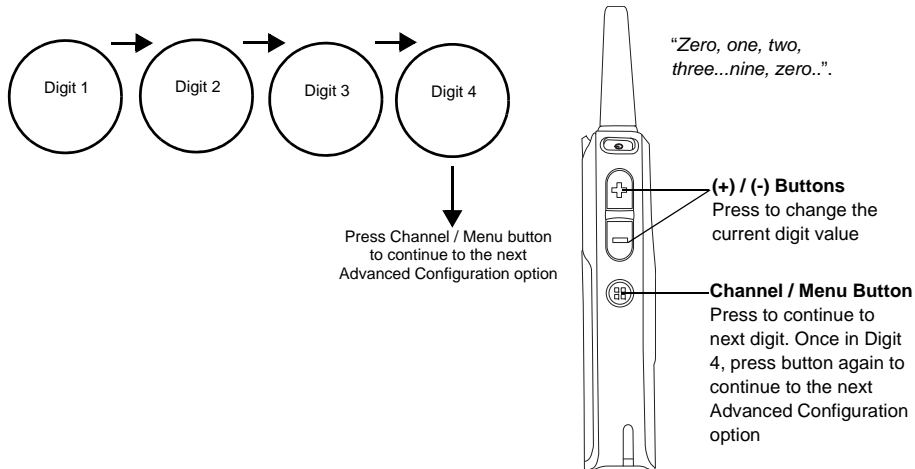



## PROFILE ID Number – Value Modification Confirmation

Once you have set the 4 digit PROFILE ID Number, the radio announces the entire new PROFILE ID Number value. Press Channel / Menu button to continue to the next Advanced Configuration option or hold down the PTT button to exit the Advanced Configuration Mode.

**Note:** If the 4 digit PROFILE ID number set is not the numbers wanted upon moving to the next Advanced Configuration option, press the Channel / Menu button and cycle through the Advanced Configuration options until you are back at the PROFILE ID Number option to change the value.

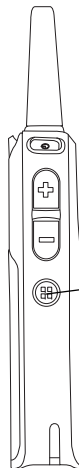
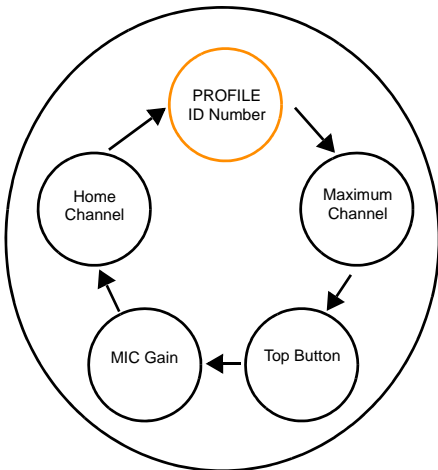

*"Profile ID saved as <Digit 1, Digit 2, Digit 3, Digit 4>. Press Menu to continue".*

**Channel / Menu Button**  
Press to continue to the next Advanced Configuration option

## Maximum Channels

Press the Channel / Menu button until the radio announces the current maximum number of channels and prompts you to change it. Press (+) or (-) button to change the number of channels(\*). Press Channel / Menu button to continue to the next Advanced Configuration option.

**Note:** The maximum number of channels you can set up in your radio is limited by the radio model. DLR1060 has maximum 6 channels and DLR1020 has maximum 2 channels.

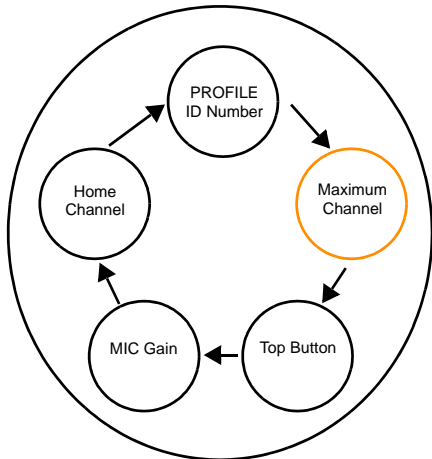

*"Maximum channels <number>. To change, press plus or minus".*

**(+) / (-) Buttons**  
Press to change the number of channels

**Channel / Menu Button**  
Press to continue to the next Advanced Configuration option

(\*) Maximum number channels allowed by default is the maximum number of channels your radio model has.

## Top Button

### Top Button – Current Feature

Press the Channel / Menu button until the radio announces the current Top Button feature and prompts you to change. Press (+) or (-) button to enter the Top Button sub-menu. Alternatively, press Channel / Menu button to continue to the next Advanced Configuration option.

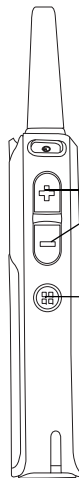
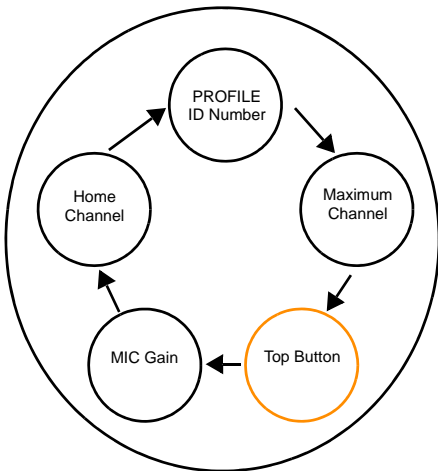

*"Programmable Button <Top Button Feature>. To change, press plus or minus".*

#### **(+) / (-) Buttons**

Press to enter the Top Button sub-menu

#### **Channel / Menu Button**

Press to continue to the next Advanced Configuration

### Top Button – Sub-menu options

Once you press the (+) or (-) button to enter the Top Button sub-menu, you can browse back and forward the different Top Button options using the (+) or (-) button. Radio will guide with voice prompts as you navigate through the features. Press Channel / Menu button to continue to the next Advanced Configuration option.

**Note:** In order to use the Direct Call option, it must be enabled via CPS beforehand. Otherwise Top Button sounds an error tone even if you choose the option in the this menu.

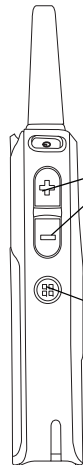
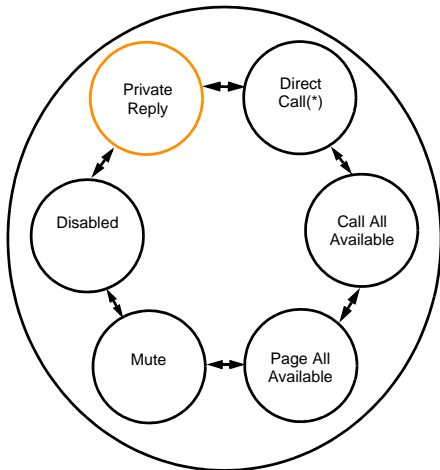

"<Top Button feature>".

**(+) / (-) Buttons**

Browse back and forward the different Top Button options using the (+) or (-) button

**Channel / Menu Button**

Press to continue to the next Advanced Configuration option

(\*) Direct Call feature is only available if it has been previously enabled via CPS.

## MIC Gain

Press the Channel / Menu button until the radio announces the MIC Gain setting and prompts you to change it. There is three MIC Gain settings to choose from – Low, Medium, High. The default MIC Gain value is “Medium”. Press the (+) or (-) button to change MIC Gain settings. Press Channel / Menu button to continue to the next Advanced Configuration option. MIC Gain should only be changed if other users complain that the volume from this radio is too low or too high. The default Medium setting should be appropriate for most users, so it can be left unchanged.

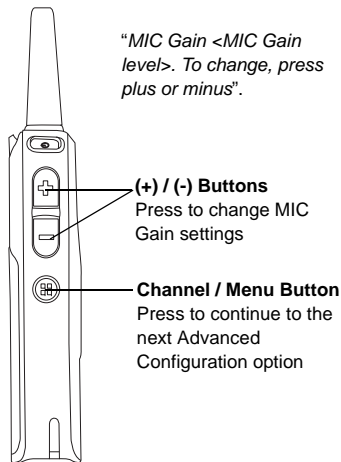
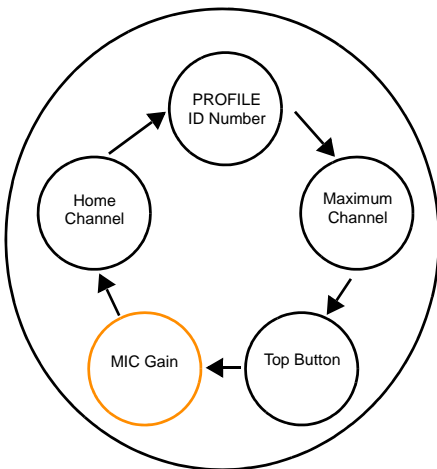

## Home Channel

Press the Channel / Menu button until the radio announces the Home Channel setting and prompts you to change it. There is two Home Channel settings to choose from – Disabled or Channel number (or channel name if alias was set up via CPS). The default setting of Home Channel is “Disabled”. Press Channel / Menu button to cycle back to the first Advanced Configuration option – PROFILE ID Number.

**Note:** When Home Channel is enabled, if no activity is detected from a channel for 7 seconds (CPS programmable), the radio reverts back to the Home Channel, so this feature may not be appropriate for users who need to frequently change channels throughout the day

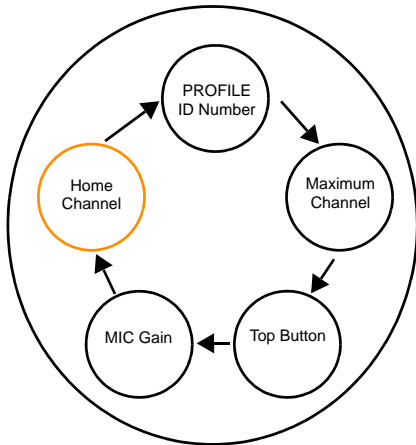

*“Home Channel <Home Channel setting>. To change, press plus or minus”.*

**(+) / (-) Buttons**

Press to change Home Channel settings

**Channel / Menu Button**

Press to cycle back to the first Advanced Configuration option

## RESETTING TO FACTORY DEFAULTS

In order to reset your radios to the original factory defaults, power UP using the ON / OFF button while pressing PTT, (-) and (+) buttons simultaneously. Radio sounds resetting beeps and the voice prompt announces “*Battery Level <battery level>, Channel <channel name>*”.

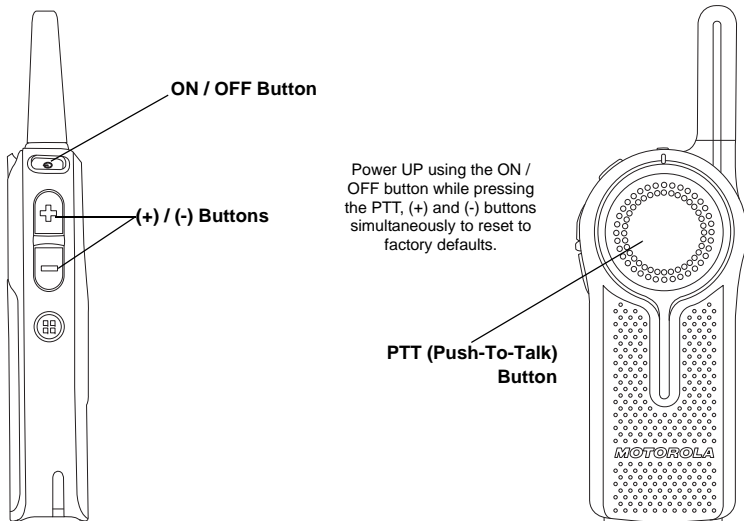

## Radio Factory Default Settings

**Table 2: Radio Basic Feature Defaults**

Radio Basic Feature	Default
Power up announcement	Battery Status and Channel Name
Quick press ON / OFF button	Battery Status
Number of channels	Set to maximum number of channels supported by the radio model
Channel / Menu button	Channel change only
Top Button feature	Private Reply

**Table 3: Radio Advanced Configuration Mode Defaults**

Radio Advanced Configuration Mode	Default
PROFILE ID Number lock	OFF
Radio PROFILE ID Number	0000
Maximum Channels	Set to maximum number of channels supported by the radio model
Direct Call	OFF
MIC Gain	Medium
Home Channel	Disabled



**Table 4: Radio Special Mode Defaults**

<b>Radio Special Mode</b>	<b>Default</b>
Enable restore Factory Default reset	ON
Enable Advanced Configuration Mode	ON
Enable Cloning Mode	ON

For all other radio defaults, please refer to the CPS.

## Notes

## SPECIAL RADIO CALL FEATURES

### PRIVATE REPLY

The DLR radio Top Button is programmed by default as “Private Reply”. Push the Top Button to capture the radio ID of the person currently talking to your group and right after the transmission is over, push the PTT button to talk privately to that person.

Private Reply helps users free the radio channel from unnecessary back and forward chatter by allowing two people to instantly connect privately after a group transmission is over.

### *Application Example*

The use of this feature reduces the need for phone extensions or cell phone calls to talk privately. Simply call on the radio the name of the person you want to talk to privately. When he or she responds to you, push the Private Reply button (Top Button) and then press the PTT button to initiate the one to one private conversation.

## How Private Reply Works

1. User B is talking to a group of radios

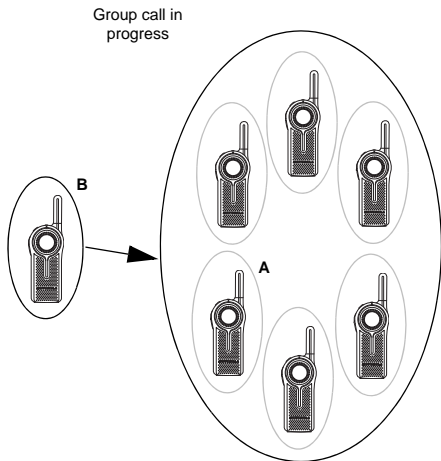

2. User A wants to talk to User B privately and presses the Top Button to queue up.

**Note:** Long pressing the Top Button a second time cancels the Private Reply queue.

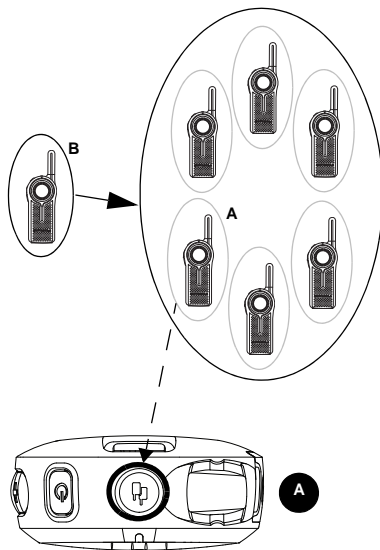

3. User A radio plays voice prompt "*Private Reply*" and the Top Button starts blinking orange, showing user A is in queue waiting to talk privately to User B.

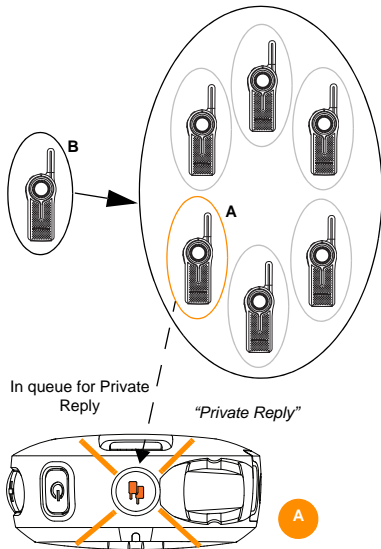

4. User B finishes talking to the Group while User A radio is still blinking orange indicating it is in queue for Private Reply call.

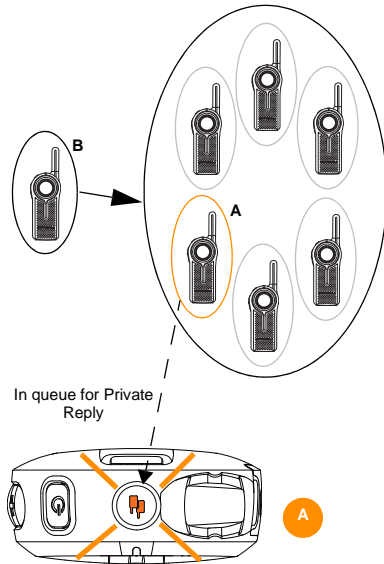

5. User A presses PTT button to talk privately to User B. The Top button LED indicator for both radio A and radio B illuminate **solid orange**. User B hears radio voice prompt "*Private*" and radio plays a **distinctive Private TPT**.

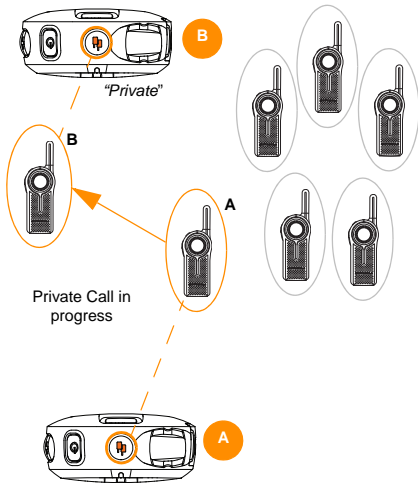

6. Whenever user A or B presses the PTT button to reply back, they are talking privately to each other. Nobody else hears them. **Radio plays a distinctive Private TPT**.

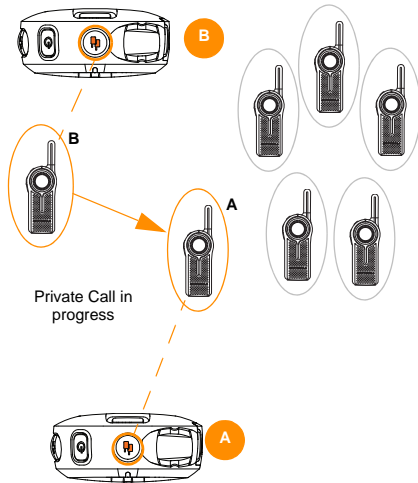

- 7a.** If either one of the radio users takes too long to push the PTT button and reply back, (the default "Private Hang Time" is 7 seconds), the radio times out and ends the private communication with voice prompt "*Private Over*" on both radios A and B. The TOP Button LED indicator goes OFF.

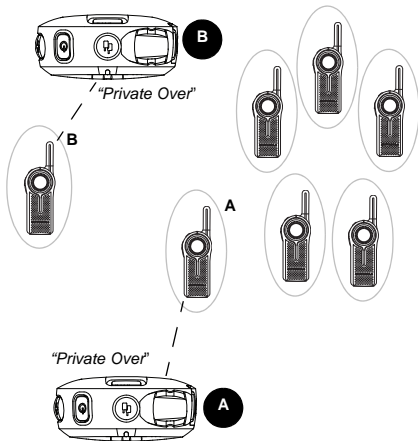

- 7b.** Radio user A (who initiated the Private Call), can also end the call at any time by Long pressing the Top Button. The radio plays voice prompt "*Private Over*" on both radio A and B to indicate that the private call is over. The TOP Button LED indicator turns OFF.

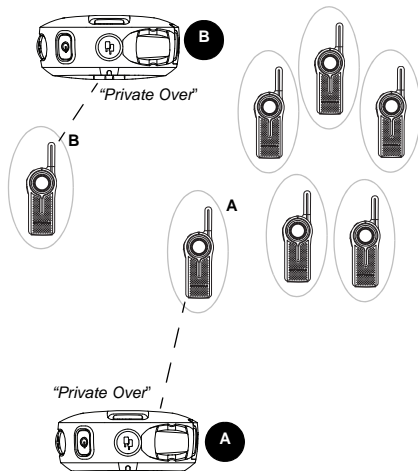

8. Radio user A and B join back the group transmission in their channel once the private call ends.

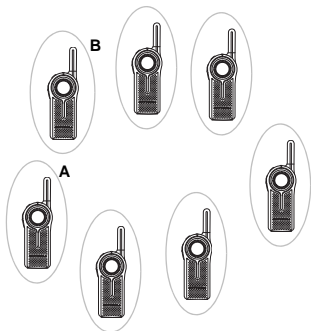

**Note:** You can set the “Private Hang Time” and “Group Hang Time” to different values using the CPS.



## Private Reply Status Indicator

Table 1: Private Reply Status Indicator

Private Reply Status	Top Button LED Indicator	Voice Prompt or Tone
Private Reply request in queue (initiated using Top Button press) – <b>Initiator</b> party	Blink Orange	<i>“Private Reply”</i>
Private conversation initiated (using the PTT button) – <b>Receiver</b> party	Solid Orange	Private TPT
Private Call notification(*) – <b>Receiver</b> party	Solid Orange	<i>“Private”</i>
Private conversation in progress – Both parties	Solid Orange	Private TPT
End of private conversation – Both parties	Off	<i>“Private Over”</i>

**Notes:** Private Reply times out after 7 seconds of inactivity (no transmissions detected). Voice prompt *“Private Over”* will be heard by both users involved in the private call.

(\*) This notification occurs only once in the beginning of the call.

## DIRECT CALL

The Direct Call Feature allows a user to call another pre-determined user that has been mapped into the radio Top Button one-on-one privately (this feature needs to be pre-programmed via CPS\*). Users also have the option to assign the Direct Call feature to any radio channel instead of the Top Button. This allows the radio Top Button to be available for other radio features (e.g.: Private Reply or Mute) and Direct Call to be set up in a special channel. (You can set up different direct calls in different channels).

**Note:** In order to set up the Direct Call function for the first time in your radio, (either Top Button or to a specific channel ) you need to use the CPS (Customer Programming Software) which is available for free download at [www.motorolasolutions.com/DLR](http://www.motorolasolutions.com/DLR). Once in the CPS, you must read and upload the radio IDs (identified in CPS as “privates”) into the CPS in order to enable Direct Call and assign direct calls to specific radios.

Refer to “Customer Programming Software (CPS)” on page 83 for more information.

### ***Application Example***

Set up your employees to be able to contact directly and privately their supervisor, the Manager on Duty or to reach a designated person for special requests by simply pressing the Direct Call button (Top Button) and then pushing the PTT button to talk.

**Note:** If the Direct Call is set up in a specific channel, change to that channel and press the PTT button to talk privately.

### **How Direct Call Works**

1. User A presses the radio Top Button in order to talk directly to User B. User A radio plays voice prompt “*Private <Name>*” as programmed in CPS (if enabled) and the Top Button LED indicator starts blinking orange, indicating that User A is in queue waiting to talk privately to User B.

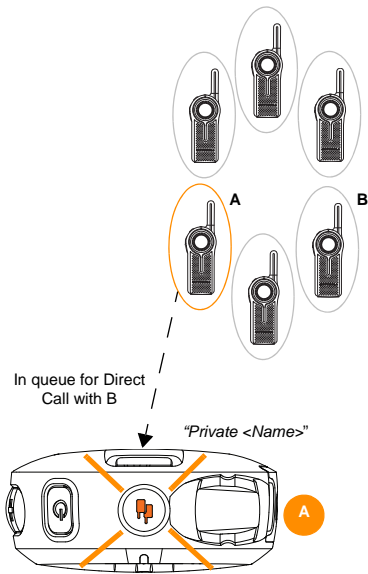

2. User A presses the PTT button to talk privately to User B (who is NOT in a radio conversation), the TOP Button LED indicators of both A & B radios will illuminate **solid orange**. Radio B plays voice prompt "*Private*" indicating that the incoming call is a Direct Private Call. Radio A plays a **distinctive Private TPT**.

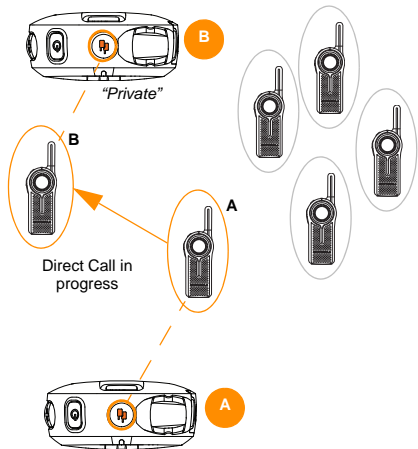

3. Whenever either user A or B presses the PTT button to reply back, they are talking privately to each other. (Radio plays a **distinctive Private TPT**). Nobody else can hear them.

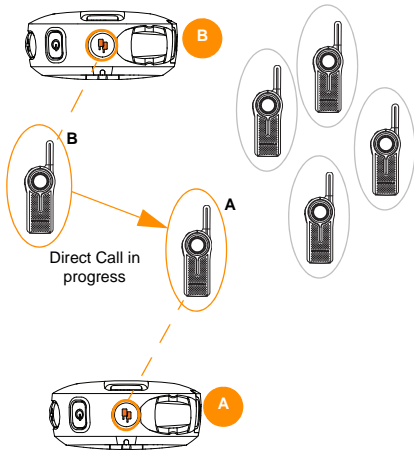

- 4a. If any of the radio users takes too long to push the PTT button and reply back, (the default "Private Hang Time" is 7 seconds), the radio times out and ends the private communication with voice prompt "*Private Over*" on both radio A and B. The TOP Button LED indicator goes OFF.

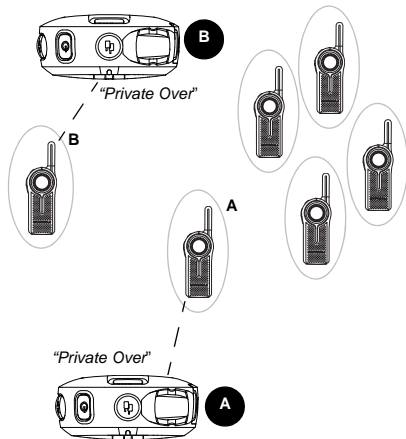

- 4b. Radio user A (who initiated the Direct Call), can also end the call by Long pressing the Top Button. The radio plays voice prompt "*Private Over*" on both radio A and B to indicate that the private call is over. The TOP button LED indicator goes OFF.

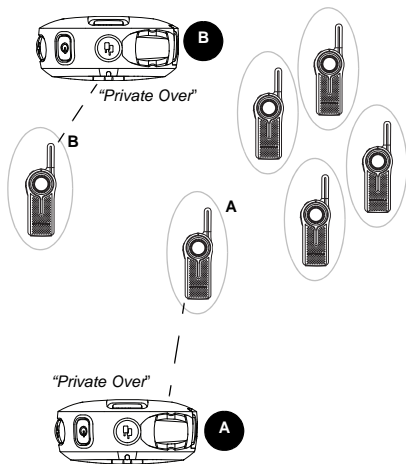

## Direct Call Status Indicator

**Note:** To initiate Direct Call, press the Top Button followed by the PTT button to talk directly and privately to the pre-set user.

**Table 2: Direct Call Status Indicator**

Direct Call Status	Top Button LED Indicator	Voice Prompt or Tone
Direct Call initiated (using Top Button press) – <b>Initiator</b> party	Blink Orange	"<Name of Direct Call user>"(*)
Private conversation initiated (using the PTT button) – <b>Initiator</b> party	Solid Orange	Private TPT
Private Call notification – <b>Receiver</b> party	Solid Orange	"Private"
Private conversation in progress – Both parties	Solid Orange	Private TPT
End of private conversation – Both parties	Off	"Private Over"

**Notes:** Direct Call times out after 7 seconds of inactivity (no transmissions detected). Voice prompt "Private Over" will be heard by both users involved in the private call.

Top Button must be pre-programmed to Direct Call Feature. For Direct Call feature to be enabled in the radio Advanced Configuration, a radio ID must have been uploaded into the radio via CPS. Radio will play voice prompt of Direct Call Name. If no name is programmed, radio announces radio private ID number. Refer to "Customer Programming Software (CPS)" on page 83 for more information.

(\*) According to the private user name that has been set up via CPS.

## **Private Reply and Direct Call Frequently Asked Questions (FAQ)**

- 1. If I change my mind and want to exit the request for Private Call (or I pressed the top button by mistake), how do I get out of the “private queue” status (Radio Top Button LED indicator is blinking orange)?*

Long press the Top Button. The radio exits the private queue request and the Top Button LED indicator turns off, returning you to radio normal status.

- 2. What happens if two people (for example user A and C) press their Top Button at the same time to Private Reply or Direct Call User B?*

Pressing the top button only queues the radio B ID; therefore, there is no issue if two people press the Top Button at the same time. The issue occurs when these two people press the PTT button at the same time to talk privately to B. Then, whoever presses the PTT button

faster gets to talk privately to B. The other user hears a “busy” or rejection tone.

- 3. What happens if a person Private Reply or Direct Call User B, but User B does not want to engage in the Private conversation?*

The nature of the radio communication is to allow instant communication without the option to decline radio calls. Therefore, if you are concerned about users disrupting group communications or misusing the Private Reply or Direct Call features, make sure these features are enabled only on authorized radio users.

- 4. I pressed the Private Reply button but nothing happened (e.g. Top Button LED indicator did not start blinking) and instead the radio gives out a busy tone.*

It can be due to different causes such as the Top Button is disabled or the radio could not store the radio ID you wanted to reply to (this is

if the Top Button was pressed outside the 4 seconds Group Hang Time).

5. *What happens if I want to Private Reply to a person that just finished talking?*

The radios allows for “Group Hang Time” (around 4 seconds) for you to be able to Private Reply to someone who had just finished talking. Just push the Top Button within the hang time window and the radio Top Button LED indicator starts blinking orange. You can then press the PTT button to talk privately.

6. *How exactly does Private Reply work?*

When you press the radio Top button while User B is talking, your radio “captures” the ID of radio B. Once user B finished talking and you press the PTT button, your radio calls radio B privately.

7. *What happens if I want to end the call during a Private Call or Direct Call conversation?*

If you are the user who initiated the Private Reply or Direct Call, you can end the call by

long pressing the Top Button. However, if you are the call receiver, you will have to wait for the radio to time out (i.e. no communications detected for more than 7 seconds) OR change the channel.

8. *I pressed the Top Button to queue to talk privately to the last person transmitting, but when the user finished talking and I push the PTT button to talk, the radio gave me a busy tone or other strange tones and I could not initiate my conversation.*

It is very likely there are other users who were waiting as well to talk to the last person transmitting and someone else pressed the PTT button before you, giving you a busy or error tone. Another reason is that the last person transmitting has gone out of transmission range.

9. *If I press the Top Button (either for Private Reply or Direct Call) and I forgot that I wanted to talk privately and I did not push the PTT button:*



- *Would I be still able hear the group conversations in my channel if I don't press the PTT button?*

Yes, you should be able to still hear conversations in your channel.

- *How long do I have to talk privately to User B?*

There is no time restriction on how long you can take to press the PTT button to talk privately to user A, as long as your Top Button LED indicator is blinking.

- *Does the radio gives me any alert to know that I am in still in the private queue mode?*

Yes. While waiting in queue to talk privately, you will receive a call reminder tone after 1 minute of being in queue, followed by another reminder tone 4 minutes after that. No other reminder will be heard afterwards, but you will remain in queue until Private Reply mode is exited.

- *How do I respond to group conversation if I have already pushed the Top Button (for either Private Reply or Direct Call) and my Top button LED indicator is blinking?*

Long Press the Top Button to exit the private queue mode (Top Button LED indicator should turn off) and press the PTT button to reply back to the group call.

10. *What happens if I am in queue to talk privately (LED indicator blinking orange), then the person that was transmitting finished talking and I press the PTT button to talk but the Top Button LED indicator does not change to solid orange?*

The radio lets you know you are ready for a private communication by turning the Top Button LED indicator to solid orange and playing the voice prompt “private” in the beginning. During the private conversation it also plays a distinctive Talk Permit Tone. All these different prompts from the radio need to happen to ensure there is a private communication established. If you do not have these prompts, it means you do not have private communication established and you need to try again.

11. *How do I know when the radio is no longer in Private Mode conversation?*

You are no longer in a private conversation if the Top Button LED indicator is not illuminating solid orange and is either blinking or switched off instead. Furthermore, the radio plays the voice prompt: “*Private Over*”.

**Note:** Remember that the Private Reply and the Direct Call time out after 7 seconds of inactivity in which both users are sent back to the group call mode (Radio plays the voice prompt “*Private Over*” and the Top Button LED indicator goes off).

## CALL ALL AVAILABLE

**Note:** This feature is useful for users with more than 1 or 2 channels.

Call All Available feature allows the ability to communicate a message to all available radio users at once in a temporary “**super channel group**”, without having to change through each channel individually. Call All Available is a group call to **ALL** users available in different channels and users who are not currently tied up in an ongoing radio conversation(\*).

Any user who wants to respond to a Call All Available transmission can do so the same way they do when talking on a standard group conversation (by pressing the PTT button before talking).

If someone initiates a Call All Available transmission, all users engaged in the Call All Available will have their Top Button disabled (no Private Reply or Direct Call allowed during this period)

The DLR radio times out a Call All Available communication after 4 seconds of inactivity. This is to avoid all users being tied up indefinitely in an unnecessary group conversation.

Call All Available option can be assigned either to the Top Button or to an extra channel(\*\*).

(\*) This feature does NOT interrupt ongoing communications.

(\*\*) Use CPS to assign Call All Available to a specific channel.

### ***Application Example***

An employee in a retail shop uses a DLR1060 (6 channel radio) with the Top Button programmed to Call All Available. This employee is trying to check if anyone took the backroom scanner. The employee presses the Top Button followed by the PTT button and asks "Does anybody know who has the backroom scanner?". Anyone, irrespective of their channel, who is not already part of another conversation, will hear this call and can talk back to the whole group of users (who are tied up in the super channel group call) and provide the needed information.

## How Call All Available Works

1. All users in Channel 3 and 4 are available (nobody is transmitting).

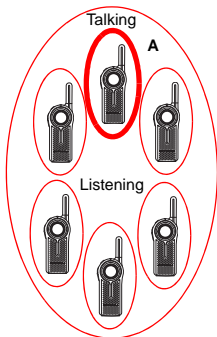
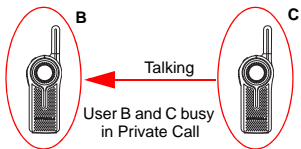

**CHANNEL 2  
BUSY**

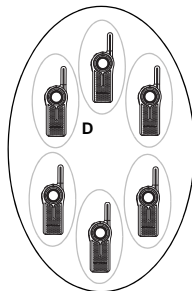

**CHANNEL 3  
AVAILABLE**

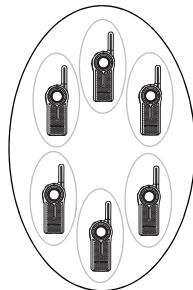

**CHANNEL 4  
AVAILABLE**

2. User D in Channel 3 initiates Call All Available by pressing the radio Top Button(\*).

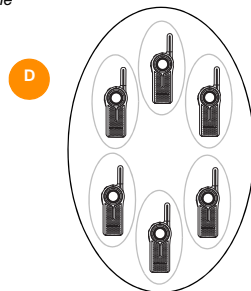
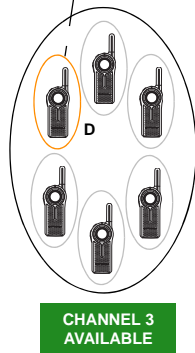
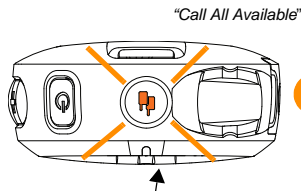
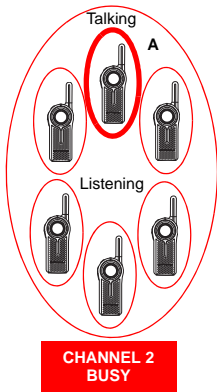
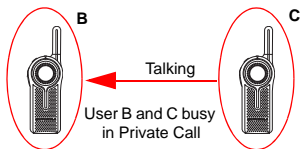

All users in Channel 3 and 4 are AVAILABLE (Nobody is transmitting).

(\*) Top Button must be pre-programmed to Call All Available before using this feature

3. All users from Channel 3 and 4 are brought into a temporary "super channel" group. User D then presses the PTT button and start talking to all available users in both channels.

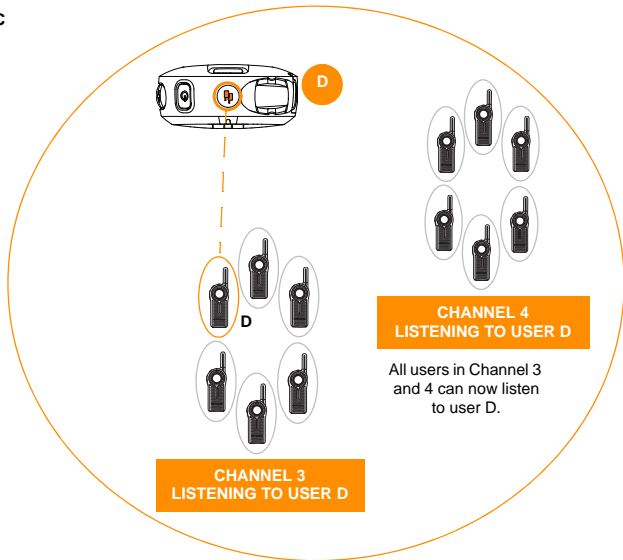
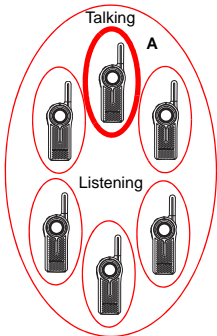
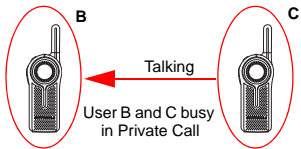

4. All radios Top Buttons in Channel 3 and 4 are **solid orange** indicating that Call All Available is in progress.

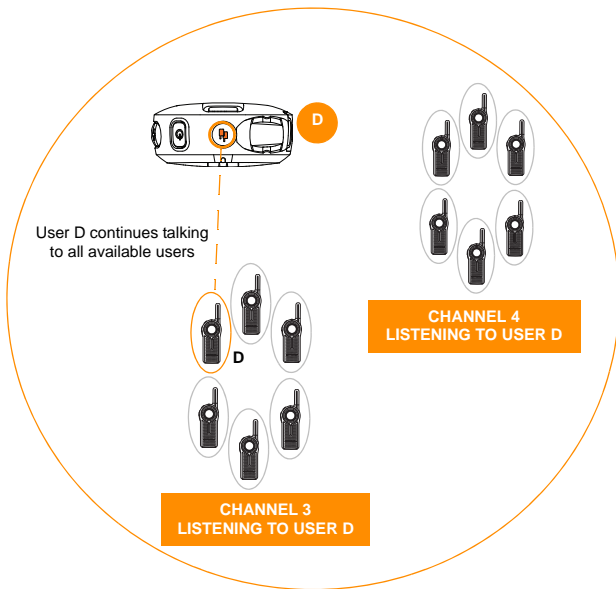
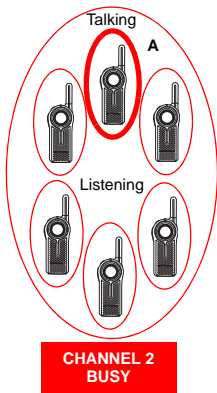
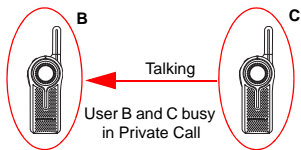

5. User D finished talking [Top Button LED indicator still **solid orange**(\*)]. User E presses the PTT button and starts talking to all available users. All users in Channel 3 and 4 now hear User E. All radios Top Buttons are **solid orange** indicating that Call All Available is in progress.

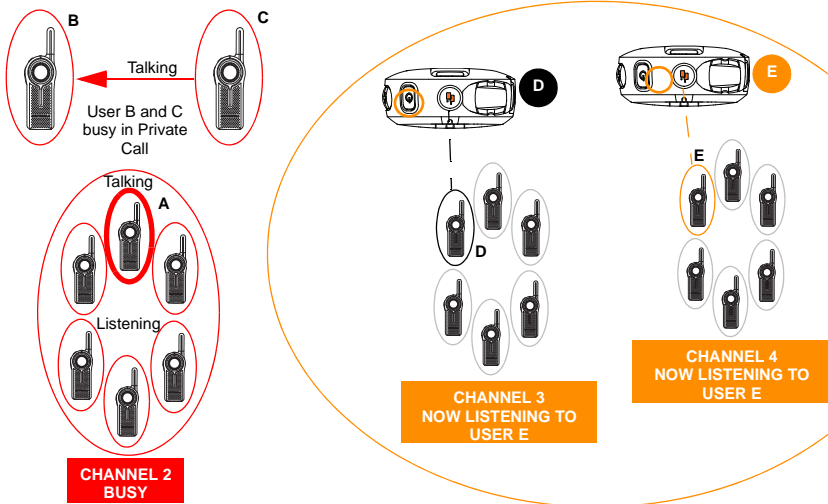

(\*) Users in the Call All Available group must respond back within the 4 second hang time or the Call All Available mode will be terminated.



6. Once all users finished communicating (no transmissions for more than 4 seconds), the radios time out and end the Call All Available “super channel” group. All users in channel 3 and 4 return to their original talk channels.

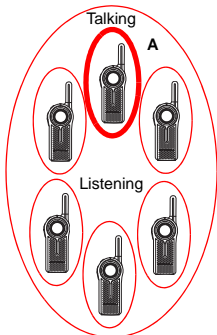
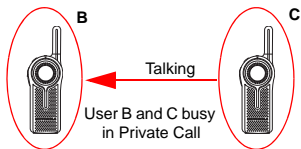

**CHANNEL 2  
BUSY**

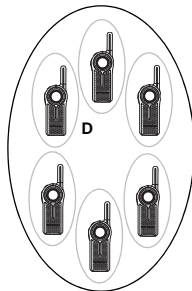

**CHANNEL 3  
AVAILABLE**

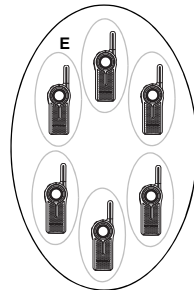

**CHANNEL 4  
AVAILABLE**

## Call All Available Status Indicator

**Note:** To initiate Call All Available, press the Top Button followed by the PTT button to talk to all available users in different channels.

**Table 3: Call All Available Status Indicator**

Call All Available Status	Top Button LED Indicator	Voice Prompt or Tone
Call All Available initiated (using Top Button press) – <b>Initiator</b> party	Blink Orange	"Call All Available"
Call All Available conversation initiated (using the PTT button) – <b>Initiator</b> party	Solid Orange	Standard TPT
Call All Available Call notification – <b>Receiver</b> party	Solid Orange	Standard TPT
Call All Available conversation in progress – Both parties	Solid Orange	Standard TPT
End of Call All Available – Both parties	Off	None

**Note:** Top Button must be pre-programmed to Call All Available via Advanced Configuration or CPS. Call All Available times out after 4 seconds of inactivity (no transmission detected). This table applies only to cases in which Call All Available is programmed to the Top Button. Call All Available can also be programmed to a radio channel. Refer to "Customer Programming Software (CPS)" on page 83 for more information.

## PAGE ALL AVAILABLE

**Note:** This feature is useful for users with more than 1 or 2 channels.

Page All Available allows the ability to communicate a message to all available radio users at once without having to change through each channel individually. Page All Available is a **one way group voice announcement** to all users in different channels who are not currently tied up in an ongoing radio conversation(\*).

Any user who wants to respond to a Page All Available transmission can do so by replying privately (by pressing the Top Button before talking). The Page All Available feature is set up this way to avoid all users getting tied up in an unwanted ongoing group conversation.

Once the user transmitting in Page All Available mode stops transmitting by releasing the PTT button, the Page All Available mode is terminated.

Page All Available option can be assigned either to the Top Button or to an extra channel(\*\*).

(\*) This feature does NOT interrupt ongoing communications.

(\*\*) Use CPS to assign Page All Available to a specific channel.

**Application Example 1**

An employee in a retail shop uses a DLR1060 (6 channel radio) with the Top Button programmed to Private Reply and Channel 6 programmed to Page All Available feature. This employee is looking for anyone (in any of the group radio channels) who can come over to help out in the back room. The employee changes to the Page All Available channel before pressing the PTT button and asks “Can someone come over to the back room to help out?”. Whoever is available in any of the radio channels can privately reply to the employee to ask for more details or to confirm that they are available to help.

**Application Example 2**

Anna needs to talk privately to another user (John) and she is not sure in which channel to find him. It is cumbersome to browse all channels to search for John. Anna uses a DLR1060 (6 channel radio) with the Top Button programmed to Private Reply and Channel 6 programmed to Page All Available feature. She switches to Channel 6 and asks “John Smith, are you available?”

If John is available, he can reply privately (by pressing the Top Button). If no response is heard, it means he is busy in another radio call or is not within the communication range.

## How Page All Available works

1. All users in Channel 3 and 4 are available (nobody is transmitting).

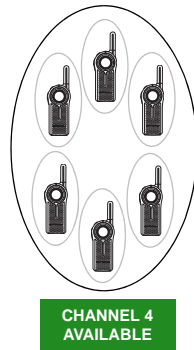
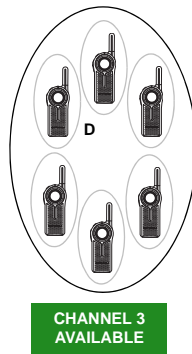
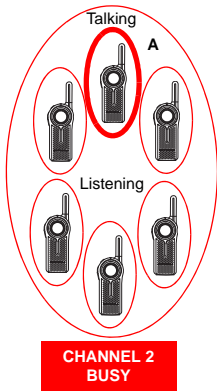
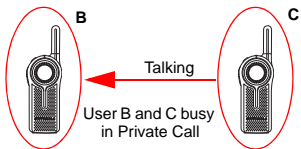

2. User D in Channel 3 initiates Page All Available by switching to Channel 6(\*).

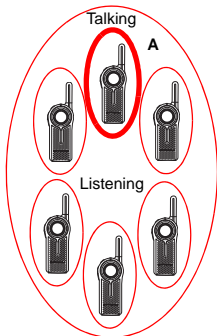
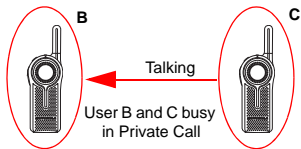

**CHANNEL 2  
BUSY**

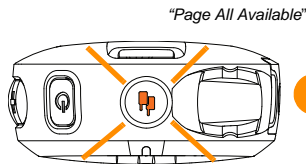

**D**

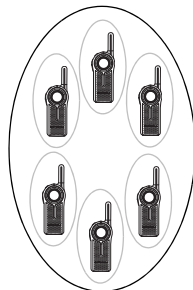

**CHANNEL 4  
AVAILABLE**

All users in Channel 3 and 4 are AVAILABLE (Nobody is transmitting).

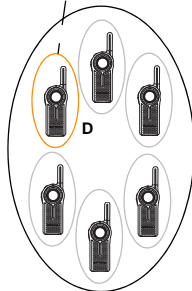

**CHANNEL 3  
AVAILABLE**

(\*) Channel 6 must be pre-programmed to Page All Available before using this feature

3. All users from Channel 3 and 4 are brought into a temporary “super group”. User D then presses the PTT button and starts talking to all available users in both channels.

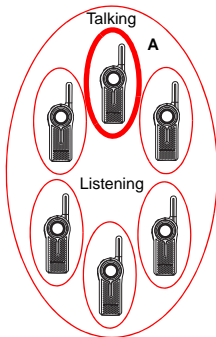
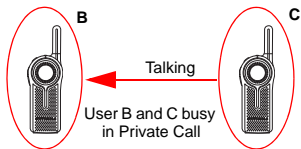

**CHANNEL 2  
BUSY**

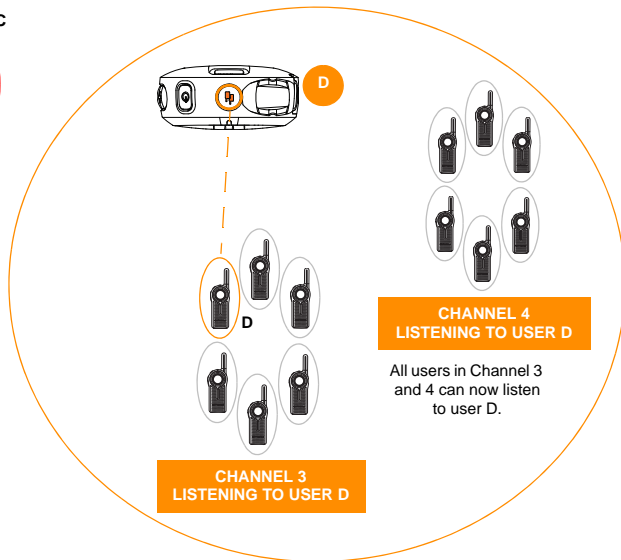

4. User D continues talking to all available users. User E wants to reply to user D and presses the Top button(\*). User E goes **in queue** for Private Reply.

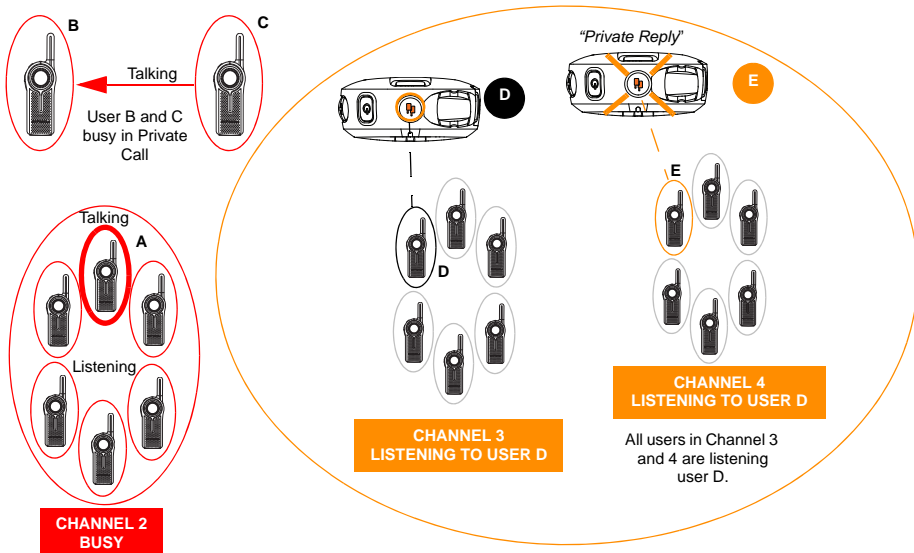

(\*) Top Button of Radio E must be pre-programmed to Private Reply feature



5. Once user D stops transmitting by releasing the PTT button, the Page All Available is over. All users in Channel 3 and 4 are back to their original channel groups. User E remains in queue for Private Reply.

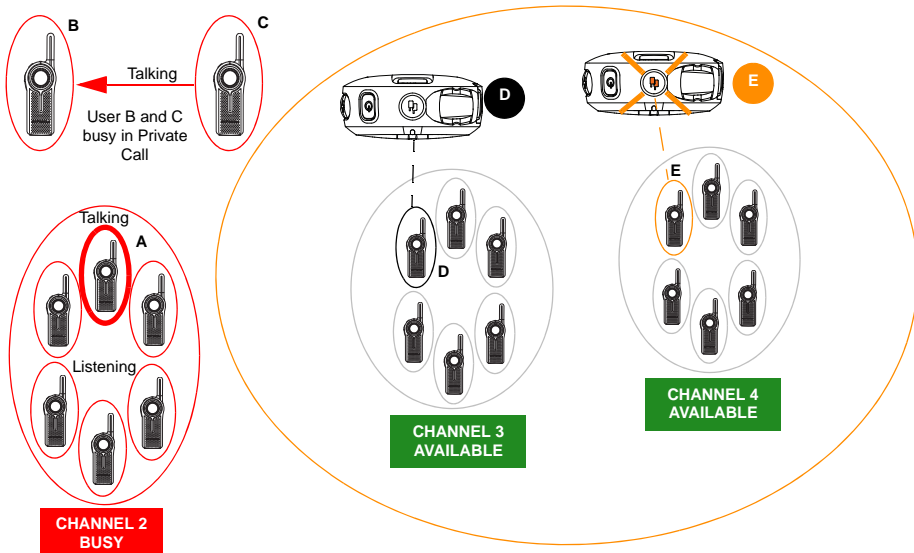

6. User E presses PTT to talk to user D. They are now engaged in a Private Conversation. Nobody else can hear them. The Top Button LED indicator for radio D and E illuminates **solid orange**.

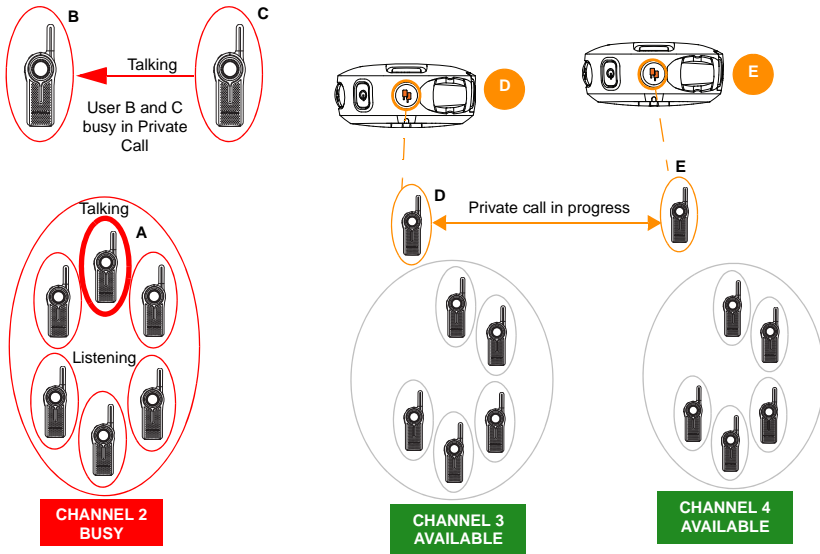

7. Once User D and E finish the private conversation, they are returned to their respective group channel. The Top Button LED indicator both radios switched off.

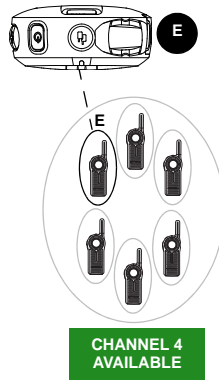
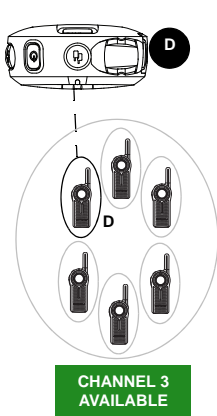
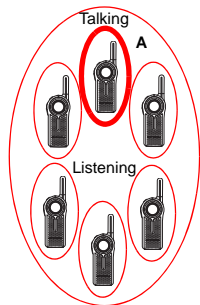
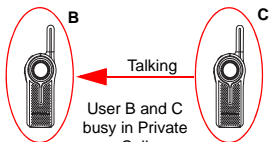

## Page All Available Status Indicator

**Note:** To initiate Page All Available, press the Top Button or change to a channel that is preset to Page All Available followed by the PTT button to talk to all available users in different channels.

**Table 4: Page All Available Status Indicator**

Page All Available Status	Top Button LED Indicator	Voice Prompt or Tone
Page All Available initiated (using Top Button press) – <b>Initiator</b> party	Blink Orange	<i>“Page All Available”</i>
Page All Available conversation initiated (using the PTT button) – <b>Initiator</b> party	Solid Orange	Standard TPT
Page All Available Call notification – <b>Receiver</b> party	Solid Orange	Standard TPT
Page All Available conversation in progress – Both parties	Solid Orange	Standard TPT
End of Page All Available – Both parties	Off	None

**Note:** Top Button must be pre-programmed to Page All Available via Advanced Configuration or CPS. The only way to respond to someone doing a Page All Available call is by Private Reply. This table applies only to cases in which Page All Available is programmed to the Top Button. Page All Available can also be programmed to a radio channel. Refer to “Customer Programming Software (CPS)” on page 83 for more information.

## CUSTOMER PROGRAMMING SOFTWARE (CPS)

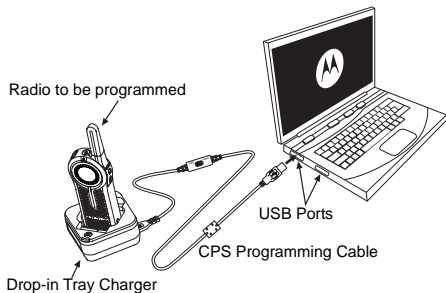

**Figure 1:** Setting up the radio to the CPS

The easiest way to program or change features in your radio is by using the Customer Programming Software (CPS) and the CPS Programming Cable(\*). CPS Software is available for free as web based downloadable software at:

[www.motorolasolutions.com/DLR](http://www.motorolasolutions.com/DLR)

To program, connect the DLR Series radio via the Drop-in Charger Tray and CPS Programming Cable to your computer as shown in the picture above. Prior to programming, verify that the switch in the Programming Cable is in the 'Digital(\*\*)' position.

CPS allows you to easily program features such as Direct Call, Radio Menu Options, Private Groups, Direct Contacts, Channel announcements, etc. It also gives you the flexibility to prevent radio features to be accidentally modified by users, by providing the option to disable functionalities like Factory Reset, Advanced Configuration Mode, etc. It also provides security by giving the option to set up a password for profile radio's management. For more information, refer to Features Summary Chart Section at the end of the User Guide.

**Notes:** (\*) CPS Programming Cable P/N# is HKKN4027\_.

(\*\*) If your CPS Programming Cable is showing "CPS / Flash", make sure to position it to "Flash".

## CPS BASIC MENU INSTRUCTIONS

1. Open the CPS software and click on the "RADIO" top tab.
- 2a. Click on the "READ" tab to read the radio(\*), or
- 2b. On the drop down menu "Radio Type", select "DLR" if you want to open a new profile or an existing one.

(\* You only need to select the Radio Type, if you want to open a new or pre-determined profile. The CPS is smart enough to determine what model it is reading.

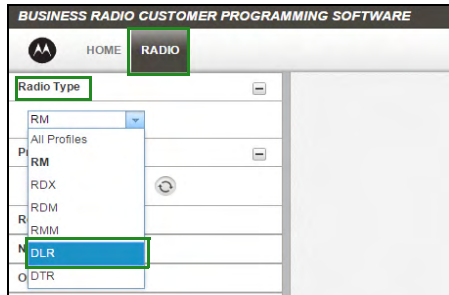

- 3a. Click "Read Radio". Radio sounds a series of beeps to indicate reading is in progress and will upload your radio profile settings, or

- 3b. Click "New Profile" to create customized profile based on the default profile.

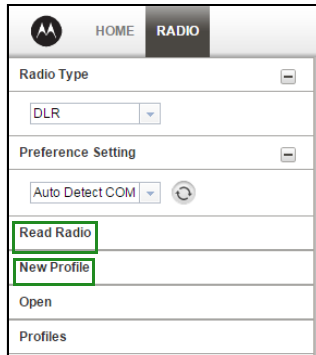

4. Scroll down to see more feature options. Customize as necessary.

Model - DLR1060

Save to profile Write to radio Save As Close Delete Customer Handout Detailed Report **Switch to ADVANCED**

Audio Settings (Basic)

Microphone Gain Medium

Accessory Microphone Gain Medium

Silent Mode OFF

Power Up Audio Battery Level + Channel

Voice Prompt Language English

Voice Prompt Volume Level -2

Talk Permit Tone Volume Level -6

Tone Volume Level -4

Accessory Tone Volume Level -4

Beeps

Begin of Receive Tone

End of Receive Tone (Roger Beep)

Begin of Private Receive Tone

End of Private Receive Tone (Roger Beep)

Enable Internal PTT with Accessory

Programming Menu Settings (Basic)

Menu Item 1 Profile ID Menu

Menu Item 2 Max Channel

Menu Item 3 Programmable Button

Menu Item 4 Microphone Gain

Menu Item 5 Home Channel

User Menu Settings (Basic)

Click **ONLY** if you are going to upload radios IDs for Direct Call, Private Groups or interoperability with DTR radios.

Scroll down for more feature options

5. You can choose which options you want to be available in the Advanced Configuration Mode. You can add any of the features shown to be accessed by the radio Channel / Menu button in the radio basic operation mode. You can also choose which function you want to have for ON / OFF button short press.

The screenshot displays a configuration window with the following sections and options:

- Buttons:** Save to profile, Write to radio, Save As, Close, Delete, Customer Handout, Detailed Report, Switch to ADVANCED.
- Programming Menu Settings (Basic):**
  - Menu Item 1: Profile ID Menu
  - Menu Item 2: Max Channel
  - Menu Item 3: Programmable Button
  - Menu Item 4: Microphone Gain
  - Menu Item 5: Home Channel
- User Menu Settings (Basic):**
  - Menu Item 1: Channel Selection
  - Menu Item 2: Empty
  - Menu Item 3: Empty
  - Menu Item 4: Empty
- Buttons (Basic):**
  - Programmable Button: Private Reply
  - Quick Press On/Off Button Mode: Battery Status (dropdown menu is open showing: Battery Status, Radio Name, No Operation)
  - Direct Call: (empty)
  - Radio Name Based on Private Name: (empty)

Callout 1: Selection of options to be available in the Advanced Configuration mode.

Callout 2: Programmable features to the radio basic menu (Channel / Menu button).

Callout 3: Choose which function to have for ON/OFF button short press.



6. You can modify the radio Top Button feature by changing the default option.

Save to profile	Write to radio	Save As	Close	Delete	Customer Handout	Detailed Report	Switch to ADVANCED
Menu Item 1	Channel Selection						
Menu Item 2	Battery Status						
Menu Item 3	Radio Name						
Menu Item 4	Empty						
<b>Buttons (Basic)</b>							
Programmable Button	Private Reply						
Quick Press On/Off Button Mode	Private Reply						
Direct Call	Call All Available						
Radio Name Based on Private Name	Page All Available						
	Mute						
	Disabled						
Radio Name							
<b>Profile ID Number information (Basic)</b>							
Profile ID	0000						

Programmable features to the radio basic menu (Channel / Menu button).

List of programmable features for the Top Button.

7. In order to enable Direct Call feature in your Basic Menu options, you need to first upload the radio(s) unique “private” identification (12 digit) number. Click on the “Switch to ADVANCED” button. Under “Privates (Advanced)” tab, click “Add” for CPS to upload radio ID. You can customize the radio ID name under the Name column. Once a radio ID is uploaded the CPS will give the option to enable Direct Call.

<input type="button" value="Save to profile"/> <input type="button" value="Write to radio"/> <input type="button" value="Save As"/> <input type="button" value="Close"/> <input type="button" value="Delete"/> <input type="button" value="Customer Handout"/> <input type="button" value="Detailed Report"/> <input type="button" value="Switch to ADVANCED"/>	
Menu Item 1	Channel Selection
Menu Item 2	Battery Status
Menu Item 3	Radio Name
Menu Item 4	Empty
<input type="checkbox"/> <b>Buttons (Basic)</b>	
Programmable Button	<div style="border: 1px solid black; padding: 2px;">             Private Reply  <b>Private Reply</b>              Call All Available              Page All Available              Mute              Disabled           </div>
Quick Press On/Off Button Mode	
Direct Call	
Radio Name Based on Private Name	
Radio Name	
<input type="checkbox"/> <b>Profile ID Number information (Basic)</b>	
Profile ID	0000

Direct Call will be listed in this drop down menu of Top Button programmable features once it is enabled.

8. Customize your PROFILE ID Number for any 4 digit number different from “0000” to differentiate your radios in a radio fleet.

Radio Name

**Profile ID Number information (Basic)**

Profile ID

**Channels (Basic)**

Home Channel

- 9a. Home Channel is OFF by default. If you want to assign a specific channel as your Home Channel, select the channel using the drop down menu under “Home Channel”. CPS will enable the option to choose any channel(\*) you want as your designated Home Channel for the radio you are programming.

**Profile ID Number information (Basic)**

Profile ID

**Channels (Basic)**

Home Channel

Home Channel Mode

(\*)Number of channel shown in the drop down menu varies according to the radio model

Select channel(\*) to assign the Home Channel to.

<input type="checkbox"/>	Index	Chan 01	Chan 02	Chan 03	Chan 04	Chan 05	Chan 06	User Customized VP
<input type="checkbox"/>	1	01						
<input type="checkbox"/>	2	02						
<input type="checkbox"/>	3	03						
<input type="checkbox"/>	4	04						
<input type="checkbox"/>	5	05						

- 9b. Upon setting your Home Channel, CPS will enable the option to set the Home Channel Mode. Select the mode using the drop down menu under "Home Channel Mode".

**Channels (Basic)**

Home Channel: Chan 01

Home Channel Mode: Return on all channels

<input type="checkbox"/>	Index		VP
<input type="checkbox"/>	1		01
<input type="checkbox"/>	2		02
<input type="checkbox"/>	3		Chan 03

List of available modes for Home Channel

10. Customize the name of your channel (alias) by typing in each one of the channel boxes.

**Channels (Basic)**

Home Channel: Stock Room

Home Channel Mode: Return on all channels

<input type="checkbox"/>	Index	Edit More	Name	User Customized VP
<input type="checkbox"/>	1	<a href="#">Edit More</a>	Stock Room	
<input type="checkbox"/>	2	<a href="#">Edit More</a>	Front Desk	
<input type="checkbox"/>	3	<a href="#">Edit More</a>	Warehouse	
<input type="checkbox"/>	4	<a href="#">Edit More</a>	Chan 04	
<input type="checkbox"/>	5	<a href="#">Edit More</a>	Chan 05	
<input type="checkbox"/>	6	<a href="#">Edit More</a>	Chan 06	

- 11a. You can also set your own customized Channels Voice Prompt (VP) in order to enable your channel name to be announced by the radio. Click on “Edit More” to edit the voice prompt.

**Channels (Basic)**

Home Channel:

Home Channel Mode:

<input type="checkbox"/>	Index	Edit More	Name	User Customized VP
<input type="checkbox"/>	1	<a href="#">Edit More</a>	Stock Room	
<input type="checkbox"/>	2	<a href="#">Edit More</a>	Front Desk	
<input type="checkbox"/>	3	<a href="#">Edit More</a>	Warehouse	
<input type="checkbox"/>	4	<a href="#">Edit More</a>	Chan 04	
<input type="checkbox"/>	5	<a href="#">Edit More</a>	Chan 05	
<input type="checkbox"/>	6	<a href="#">Edit More</a>	Chan 06	

- 11b.** After clicking “Edit More”, you will be brought into a different menu to customize your channel name. Select the checkbox “Enable User Customized VP” to enable the standard Voice Prompt. When there is a speaker icon in the menu, then that channel has customized voice prompt enabled. Click on the speaker icon to preview the User Customized VP. If you want to include your own voice recording, click on “Import Voice File”(\*).

(\*) .wav audio files supported

Channels - 1				
Name	Stock Room	 <a href="#">Import Voice File</a>		
Enable User Customized VP	<input checked="" type="checkbox"/>			
Disable Channel	<input type="checkbox"/>			
Mode	Profile ID	Channel Mapping	1	

12. Once you have changed all the settings, click “Write to radio” in order to program your radio with the new settings. The CPS will display a window confirming the writing (programming of your radio) is successful. You can also save your profile at any time in order to use the same settings when programming other radios by clicking on “Save to profile”. This will save the profile to current default path in your computer. To specify a different path to save the profile, click on the “Save As” button.

\* Profile1 Model - DLR1060

✔ Data successfully updated.

Save to profile
Write to radio
Save As
Close
Delete
Customer Handout
Detailed Report
Switch to ADVANCED

Menu Item 1	Channel Selection
Menu Item 2	Battery Status
Menu Item 3	Radio Name
Menu Item 4	Empty

**Buttons (Basic)**

Programmable Button	Private Reply
Quick Press On/Off Button Mode	Battery Status
Direct Call	OFF
Radio Name Based on Private Name	<input type="checkbox"/>
Radio Name	<input type="text"/>

**Profile ID Number information (Basic)**

Profile ID	0000
------------	------

# Notes



# CLONING

## CLONING RADIOS

You can clone DLR Series radio profiles from one Source radio to a Target radio by using any one of these 4 methods:

- Using a Multi Unit Charger (MUC- optional accessory),
- Using two Single Unit Chargers (SUC) and a Radio-to-Radio cloning cable (optional accessory),
- the CPS (free software download), and
- Wireless PIN cloning.

## Cloning Mode

In order to set your radios into Cloning Mode, power UP using the ON / OFF button while pressing the PTT and (-) buttons simultaneously. Radio sounds cloning mode beeps followed by the voice prompt "*Cloning Mode, Serial*".

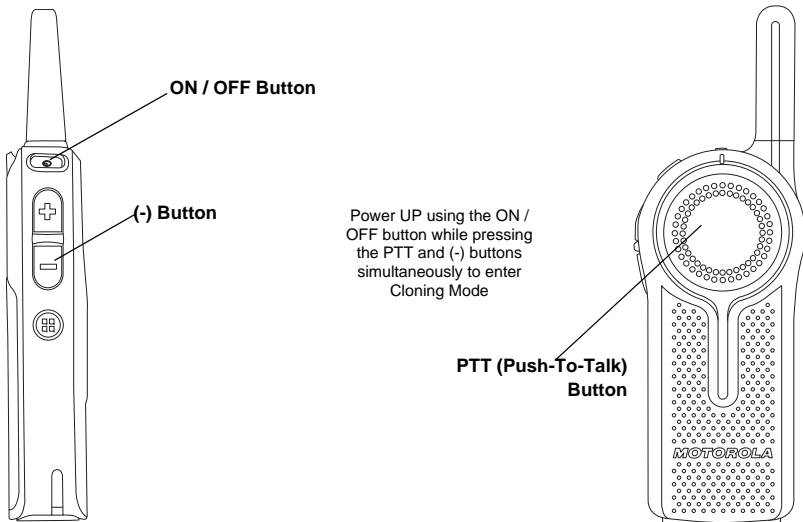

## Cloning with a Multi-Unit Charger (MUC) (Optional Accessory)

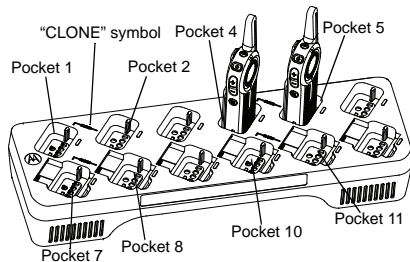

To clone radios using the MUC, there must be at least two radios:

- a Source radio (radio from which the profiles will be cloned or copied) and
- a Target radio (radio to which the profiles will be cloned from the source radio)

The Source radio has to be in Pocket 1, 4, 7 or 10 while the Target radio has to be in Pocket 2, 5, 8 or 11, matching in the MUCs pockets by pairs as follows:

- 1 and 2,
- 4 and 5,
- 7 and 8, or
- 10 and 11.

When cloning, the MUC does not need to be plugged into a power source, but ALL radios require charged batteries.

1. Turn ON the Target radio and place it into one of the MUC Target Pockets
2. Power the Source radio following the sequence below:
  - Press the PTT button and the (-) button simultaneously while turning the radio ON.
  - Wait for 3 seconds before releasing the buttons until the audible tone and voice announcement "Clone Mode Serial" are heard.
3. Place the Source radio in the source pocket that pairs with the target pocket you chose in step 1. Press and release the (+) button.

4. After cloning is completed, the Source radio will announce either “*pass*” (cloning is successful) or “*fail*” (cloning has failed).
5. Once you have completed the cloning process, turn the radios OFF and ON or, long press the PTT button to exit the ‘cloning’ mode.

When ordering the MUC, refer to P/N# PMLN7136\_.

**Notes:**

- If cloning fails, refer to “What To Do If Cloning Fails” on page 99.
- Paired Target radios and Source radios must be of the same band type in order for the cloning to run successfully.
- MUC pockets numbers should be read from left to right with the Motorola logo facing front.

## Cloning Radio using the Radio to Radio (R2R) Cloning Cable (Optional Accessory)

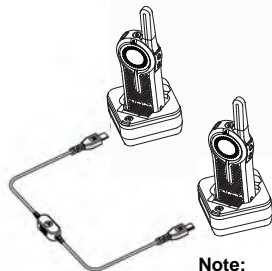

**Note:** Uses Cloning Cable P/N# HKKN4028\_

### Operating Instructions

1. Before starting the cloning process, make sure you have:
  - A Cloning Cable (P/N# HKKN4028\_)
  - A fully charged battery in each of the radios.
  - Two Single-Unit Chargers (SUC) for cloning DLR Series radios.
  - Turn OFF the radios and,
2. Unplug any cables (power supply or USB

cables) from the SUCs.

3. Plug one side of the cloning cable mini USB connector to the first SUC and the other end to the second SUC.

**Note:** During the cloning process, no power is being applied to the SUC. The batteries will not be charged. Only data communication is being established between the two radios.

4. Turn ON the Target Radio and place it into one of the SUCs.
5. For the Source Radio, power ON the radio with the following sequence:
  - Press the PTT button and the (-) button simultaneously while turning the radio ON. Wait 3 seconds before releasing the buttons and you hear a distinctive audible tone saying the word "*Clone Mode Serial*".
  - Place the Source Radio in its SUC. Press and release the (+) button.
6. When the cloning is completed, the Source Radio audible voice will announce either "*pass*" (cloning is successful) or "*fail*" (cloning process has failed).

7. Once the cloning process is completed, turn the Radios OFF and ON or, long press the PTT button to exit the 'cloning' mode

### ***What To Do If Cloning Fails***

The radio audible voice will announce "*Fail*" indicating that the cloning process has failed. In the event that the cloning fails, perform each of the following steps before attempting to start cloning process again:

1. Ensure that the batteries on both radios are fully charged.
2. Check the cloning cable connection on both SUCs and the cable is switched to "Cloning".
3. Ensure that the battery is engaged properly on the radio.

4. Ensure that there is no debris in the charging tray or on the radio contacts.
5. Ensure that the Target radio is turned ON.
6. Ensure that the Source radio is in cloning mode.
7. Ensure that the two radios are both from the same type (i.e.:DLR series), same region and have the same transmission power.

**Note:** This cloning cable is designed to operate only with compatible Motorola SUC PMLN7140\_.

When ordering Cloning Cable Kit, please refer to P/N# HKKN4028\_. For more information about the accessories, refer to “Accessories” on page 113.

## Wireless PROFILE ID Number Cloning

The PROFILE ID Number Wireless Cloning feature is useful when you want to clone the PROFILE ID Number for all the radios in your fleet **but** you do not want to clone particular radio settings that may be unique for each radio (like top button configuration, Microphone Gain, Radio Name etc) across. Wireless PROFILE ID helps to preserve each user radio set up but still make sure all radios are under the same PROFILE ID Number. It is also useful if you do not have a programming Cable, Cloning Cable or PC easily available.

To wirelessly clone the PROFILE ID Number:

1. Power the Source radio following the sequence below:
  - Press the PTT button and the (-) button simultaneously while turning the radio ON.
  - Wait for 3 seconds before releasing the buttons until the audible tone and voice announcement “*Clone Mode Serial*” are heard.

- Press and release the (-) button and the Source Radio will announce “*Wireless*”.
2. Power the Target radio following the sequence below:
    - Press the PTT button and the (-) button simultaneously while turning the radio ON.
    - Wait for 3 seconds before releasing the buttons until the audible tone and voice announcement “Clone Mode Serial” are heard.
- Note:** Avoid putting powered ON radios (more than 7 radios) in a container, other than the MUC, bunched together, touching each other.
3. On the Source radio, press and release the (+) button to start the wireless PROFILE ID Number cloning. The radio generates an audible tone.
  4. After cloning is completed, the Source radio will announce either “*pass*” (cloning is successful) or “*fail*” (cloning has failed).
  5. On the Target radio, the radio receives the PROFILE ID Number information. The Target radio will announce either “*pass*” (cloning is successful) or “*fail*” (cloning has failed).

## CLONING MODE STATUS INDICATOR

To enter cloning mode, press and hold both the PTT button and (-) button at the same time, while turning ON the radio.

**Table 1: Cloning Mode Status Indicator**

Cloning Mode Status	LED Indicator	Voice Prompt or Tone
Cloning Mode (by default is Serial)	Double Blink Red	"Clone Mode, Serial"
Switch to Wireless Cloning [initiated by (-) button]	Double Blink Red	"Wireless"
Switch to Serial Cloning [initiated by (-) button]	Double Blink Red	"Serial"
Clone [initiated by (+) button] – Cloning in progress	Solid Red	Cloning beeps
Cloning Successful	Not Available	"Pass"
Cloning Fail	Not Available	"Fail"



# TROUBLESHOOTING

<i>Symptom</i>	<i>Try This...</i>
No Power	Recharge or replace the Li-Ion battery. Extreme operating temperatures may affect battery life. Refer to "About the Li-Ion Battery" on page 12
Unable to read the radio (using the CPS)	Make sure that one side of the programming cable is connected to the radio and the other side of the programming cable is connected to the USB port. Verify that the switch on the programming cable is set at " <b>Digital</b> " position (or " <b>Flash</b> " position in older version programming cable). Make sure the radio is positioned correctly inside the SUC (radio making proper contact with the charger).
Radio generates continuous tone when PTT is pressed	Radio does not transmit when it is receiving as receive mode has higher priority than transmit mode. Press the PTT button again when receive mode ends. Refer to "Transmitting and Receiving" on page 27.
Radio does not transmit when pressing the radio PTT button	The radio does not transmit if there are other users who are using the channel. Try again after making sure nobody else is talking. By default, the PTT button is disabled on the radio whenever there is an earpiece connected to it. Make sure to use the earpiece in-line PTT button to transmit instead.

<b>Symptom</b>	<b>Try This...</b>
Hearing conversation from other users that are not within your channel	If you hear conversations from other users that don't belong to your radio fleet, it means your radios are set up with the same Profile ID as your neighbors. Very likely both of you have the radios in the default Profile ID Number "0000". Customize your PROFILE ID with a 4 digit number for all your radios. Refer to "PROFILE ID Number" on page 36 for more information.
Hearing cracking noises when nobody is talking	Sometimes users inadvertently press the radio PTT button against objects while wearing the radio on their belts or pockets. When they do this, the radio starts transmitting and holding the channel therefore generating strange noises. Using earpieces reduce the likelihood of this happening. Make sure everybody in your team is aware of proper operation of the radios.
Audio quality not good enough	Radio settings might not be matching up correctly. Double check to make sure they are identical in all radios. Go into Advanced Configuration Mode and adjust the microphone sensitivity gain (MIC Gain).
Audio sounds garbled / robotic	Digital technology gives you the advantage to experience clear audio up to the edge of the range. However, when maximum transmission range has been reached, audio may sound garbled just before the transmission is lost completely. Make sure you are within transmission range to avoid this problem.
Transmit audio is low	Hold the radio vertically 1 to 2 inches from mouth when talking. For accessory, hold the accessory microphone 2 to 3 inches from mouth when talking.

<b>Symptom</b>	<b>Try This...</b>
While talking on the radio, a loud tone interrupted the conversation	<p>When talking on the radio, make sure not to release the PTT button at any moment. Whether you are using the PTT button on the radio or using an in-line PTT in an earpiece accessory, always press the PTT button firmly until the transmission is finished. Releasing the PTT button while transmitting and trying to immediately to press the PTT button again causes the radio to give you a loud denial tone.</p> <p>If you press the PTT button to transmit and a busy tone is received instead of a TPT, this means the channel is either not available, busy or there are no users reachable within transmission range.</p>
Limited talk range	<p>Steel and/or concrete structures, heavy foliage, buildings or vehicles decrease range. Check for clear line of sight to improve transmission.</p> <p>Wearing radio close to body such as in a pocket or on a belt decreases range.</p> <p>Change location of radio. To increase range and coverage, you can reduce obstructions. Radios provide greater coverage in industrial and commercial buildings.</p> <p>Refer to "Transmitting and Receiving" on page 27</p>

<i>Symptom</i>	<i>Try This...</i>
Radio echo feedback	All radios produce a strong voice / audio feedback if they are too close to each other and their volume is set too high. Lower the volume in your radio. Using earpieces can also help reduce audio feedback if radios are too close.
Message not transmitted or received	Make sure the PTT button is completely pressed when transmitting. Confirm that the radios have the same settings and PROFILE ID. Make sure radios are in the same channel. Make sure you wait to hear for the Talk Permit Tone before talking. Not doing this will cut out the first few words of the transmission. Refer to "Transmitting and Receiving" on page 27 for further information. Recharge, replace and/or reposition batteries. Refer to "About the Li-Ion Battery" on page 12. Obstructions and operating indoors, or in vehicles, may interfere. Change location. Refer to "Transmitting and Receiving" on page 27.
Heavy static or interference	Radios are too close; they must be at least five feet apart. Radios are too far apart or obstacles are interfering with transmission. Refer to "Transmitting and Receiving" on page 27.

<i>Symptom</i>	<i>Try This...</i>
Low batteries	Recharge or replace Li-Ion battery. Extreme operating temperatures affect battery life. Refer to "About the Li-Ion Battery" on page 12.
Drop-in Charger LED light does not blink	Check that the radio/battery is properly inserted and check the battery/charger contacts to ensure that they are clean and charging pin is inserted correctly. Refer to "Charging with the Drop-in Tray Single Unit Charger (SUC)" on page 18, "DLR Series Charger LED Indicators" on page 21 and "Installing the Lithium-Ion (Li-Ion) Battery" on page 14.
Low battery indicator is blinking although new batteries are inserted	Refer to "Installing the Lithium-Ion (Li-Ion) Battery" on page 14, and "About the Li-Ion Battery" on page 12.
Battery does not charge although it has been placed in the drop-in charger for a while	Check drop-in tray charger is properly connected and correspond to a compatible power supply. Refer to "Charging with the Drop-in Tray Single Unit Charger (SUC)" on page 18 and "Charging A Stand-Alone Battery" on page 18. Check the charger's LEDs indicators to see if the battery has a problem. Refer to "DLR Series Charger LED Indicators" on page 21.

**Note:** Whenever a feature in the radio seems to not correspond to the default or preprogrammed values, check to see if the radio has been programmed using the CPS with a customized profile.

For questions or comments related to this product, please contact Motorola 1-800-448-6866 or visit us at [www.motorolasolutions.com/DLR](http://www.motorolasolutions.com/DLR).