

ACCESSORIES

WIRELESS RSM FOR PORTABLES SOLUTIONS USER GUIDE



PMMN4096 WIRELESS REMOTE SPEAKER MICROPHONE
PMLN6714 DUAL-UNIT CHARGER
PMLN6716 VEHICULAR CHARGER
PMNN4461 WIRELESS REMOTE SPEAKER MICROPHONE BATTERY

en-US

fr-CA

es-LA

pt-BR

ko-KR

de-DE

es-ES

fr-FR

it-IT

nl-NL

pt-PT

ru-RU

uk-UA



CHAPTER 1: FOREWORD

Important Safety Information

RF Energy Exposure and Product Safety Guide for Portable Two-Way Radios

ATTENTION!

This radio is restricted to Occupational use only.

Before using the radio, read the RF Energy Exposure and Product Safety Guide for Portable Two-Way Radios which contains important operating instructions for safe usage and RF energy awareness and control for Compliance with applicable standards and Regulations.

For a list of Motorola Solutions-approved antennas, batteries, and other accessories, visit the following website:

<http://www.motorolasolutions.com/APX>

Under Industry Canada regulations, this radio transmitter may only operate using an antenna of a type and maximum (or lesser) gain approved for the transmitter by Industry Canada. To reduce potential radio interference to other users, the antenna type and its gain should be so chosen that the equivalent isotropically radiated power (e.i.r.p.) is not more than that necessary for successful communication.

Notice to Users (FCC and Industry Canada)

This device complies with Part 15 of the FCC rules and Industry Canada's license-exempt RSS's per the following conditions:

- This device may not cause harmful interference.
- This device must accept any interference received, including interference that may cause undesired operation.
- Changes or modifications made to this device, not expressly approved by Motorola, could void the authority of the user to operate this equipment.

Consignes de sécurité importantes

Radios bidirectionnelles portatives : exposition aux radiofréquences et sécurité du produit

ATTENTION!

Cette radio ne doit être utilisée qu'à des fins professionnelles. Avant d'utiliser la radio, lisez le guide Radios bidirectionnelles portatives : exposition aux radiofréquences et sécurité du produit, qui contient d'importantes instructions de fonctionnement pour une utilisation sécuritaire et des informations sur l'exposition aux fréquences radioélectriques, dans le but d'assurer votre conformité aux normes et règlements en vigueur.

Visitez le site Web suivant pour obtenir la liste des antennes, des batteries et des autres accessoires approuvés par Motorola :

<http://www.motorolasolutions.com/APX>

Selon la réglementation d'Industrie Canada, cet émetteur radio ne peut être utilisé qu'avec une antenne dont le type et le gain maximal (ou minimal) sont approuvés par Industrie Canada pour cet émetteur. Afin de limiter les interférences radio pour les autres utilisateurs, le type et le gain de l'antenne doivent être choisis de façon à ce que la puissance isotrope rayonnée équivalente (P.I.R.E.) ne soit pas plus forte qu'il ne le faut pour établir la communication.

Avis aux utilisateurs (FCC et Industrie Canada)

Cet appareil est conforme à la partie 15 des règles de la FCC et d'Industrie Canada permis exemptés RSS de par la conditions suivantes:

- Ce dispositif ne doit pas causer d'interférences nuisibles.
- Cet appareil doit accepter toute interférence reçue, y compris les interférences qui peuvent perturber le fonctionnement.
- Les changements ou les modifications apportées à ce dispositif, non expressément approuvés par Motorola, peuvent annuler le droit de l'utilisateur à utiliser cet équipement.

Battery Information:

Battery is shipped with a nominal charge between 30% and 50%.
Battery should be stored between -10 °C (14 °F) and 30 °C (86 °F) to minimize permanent capacity loss.

CAUTION: Storing your fully charged accessory in high-temperature conditions may permanently reduce the life of the internal battery.

Important Information:

- Hold the microphone in a vertical position with the microphone at least one inch (2.5 centimeters) away from the nose or lips.
- Body Worn Operation. When microphone is worn on the body, always use Motorola-approved clip for this product. Using approved body-worn accessories is important because the use of non-Motorola-approved accessories may result in exposure levels, which exceed the FCC occupational/controlled environment RF exposure limits.
- Use only Motorola-approved supplied or replacement batteries. Use of non-Motorola-approved batteries may exceed the applicable RF exposure guidelines (IEEE, ICNIRP or FCC).
- DO NOT charge your accessory in temperatures below 0 °C (32 °F) or above 45 °C (113 °F). DO NOT store your accessory in direct sunlight or where expected temperatures can exceed this range such as inside a parked car.
- Storing your fully charged accessory in high-temperature conditions may permanently reduce the life of the internal battery.
- Battery life may temporarily shorten in low-temperature conditions.

Acoustic Safety

Exposure to loud noises from any source for extended periods of time may temporarily or permanently affect your hearing. The louder the radio's volume, the less time is required before your hearing could be affected. Hearing damage from loud noise is sometimes undetectable at first and can have a cumulative effect.

To protect your hearing:

- Use the lowest volume necessary to do your job.
- Turn up the volume only if you are in noisy surroundings.
- Turn down the volume before adding headset or earpiece.
- Limit the amount of time you use headsets or earpieces at high volume.
- When using the radio without a headset or earpiece, do not place the radio's speaker directly against your ear.

CHARGERS SAFETY INFORMATION

Important Safety Information

This document contains important safety and operating instructions. Please read these instructions carefully and save them for future reference.

Before using the battery charger, read all the instructions and cautionary markings on (1) the Dual-Unit Charger / Vehicular Charger, (2) the battery, and (3) on the Wireless Remote Speaker Microphone (WRSM).

WARNINGS**WARNING**

1. To reduce risk of injury, charge only the rechargeable Motorola authorized batteries listed in Table 1.1. Other batteries may explode, causing personal injury and damage.
2. Use of accessories not recommended by Motorola may result in risk of fire, electric shock, or injury.
3. To reduce risk of damage to the electric plug and cord of the DUC, pull by the plug rather than the cord when disconnecting the charger.
4. To reduce risk of damage to the CLA and cord of the Vehicular Charger, pull by the CLA rather than the cord when disconnecting the charger.
5. An extension cord should not be used unless absolutely necessary. Use of an improper extension cord could result in risk of fire and electric shock. If an extension cord must be used, make sure that the cord size is 18 AWG for lengths of up to 100 feet (30.48 m), and 16 AWG for lengths up to 150 feet (45.72 m).
6. To reduce risk of fire, electric shock, or injury, DO NOT operate the charger if it has been broken or damaged in any way. Take it to a qualified Motorola service representative.
7. DO NOT disassemble the charger – it is not repairable and replacement parts are not available. Disassembly of the charger may result in risk of electric shock or fire.
8. To reduce risk of electric shock of the DUC, unplug the charger from the AC outlet before attempting any maintenance or cleaning.
9. To reduce risk of electric shock of the Vehicular Charger, unplug the Vehicular Charger from the CLA power source before attempting any maintenance or cleaning.
10. This is a class A product. In a domestic environment this product may cause radio interference in which case the user may be required to take adequate measures.

Table 1.1: Motorola Authorized Battery

Kit (Part) Number	Platform/Description
PMNN4461_	Battery Standard Li-Ion 1750M1880T

NOTE: The Dual-Unit Charger is not designed to accommodate the alkaline battery tray.

OPERATIONAL SAFETY GUIDELINES

Dual-Unit Charger PMLN6714_

- This equipment is not suitable for outdoor use. Use only in dry locations/conditions.
- Ensure the WRSM with attached battery or battery alone is dry before inserting into the Dual-Unit Charger.
- Connect equipment only to an appropriately wired power supply of the correct voltage (as specified on the product). Disconnect from line voltage by removing main plug.
- The socket outlet to which this equipment is connected should be close by and easily accessible.
- Maximum ambient temperature around the Dual-Unit Charger equipment must not exceed 50 °C (122 °F).
- Output voltage from the power supply unit must not exceed the ratings stated on the product label located on the power supply.
- Make sure the cord is located where it will not be stepped on, tripped over, or subjected to water, damage, or stress.

Vehicular Charger PMLN6716_

- Equipment shall be used in vehicle and in dry condition. Keep in mind that rain or snow can reach the equipment i.e. through an open vehicle window.
- Ensure the WRSM with attached battery or battery alone is dry before inserting into the Vehicular Charger.
- Connect equipment only to an appropriately vehicle's cigar lighter socket of the correct voltage (as specified on the product). Disconnect from line voltage by removing the CLA.
- Maximum ambient temperature around the Vehicular Charger equipment must not exceed 60 °C (140 °F).
- Output voltage from the vehicle's cigar lighter socket unit must not exceed the ratings stated on the product label located at the back of the charger.
- Make sure the cord is located where it will not be stepped on, tripped over, or subjected to water, damage, or stress.

RADIO COMPATIBILITY

The Wireless Remote Speaker Microphone (WRSM) is compatible with the radios listed below:

Table 1.2: Radios Compatibility

Kit (Part) Number	Platform/Description
North America	XPR7550, XPR7580, XPR7350, XPR7380, XPR7550e, XPR7580e, XPR7350e, and XPR7380e
Latin America	DGP8550e, DGP5550e, DGP8050e, DGP5050e, and DGP8050e
European	DP4801e, DP4601e, DP4401e, DP4801, DP4601, DP4401, DP3441e, and DP3661e
Asia Pacific and Middle East	DP4801e, DP4601e, DP4401e, DP4801, DP4601, DP4401, DP3441e, and DP3661e

WAVE 5000 MOBILE CLIENT AND RADIO CONFIGURATION

By default, the WRSM is compatible with the radio ONLY. To work with WAVE 5000 Mobile Client, choose WAVE 5000 on Operation Mode at Accessory Programming Software (APS).

WAVE5000 Mobile Client Android Application Package (APK) version TBD and above must be used for compatibility with the WRSM. This can be configured using the APS tool.

The APS tool allows you to select two modes of operation:

- Radio mode – configuring the WRSM to be used with your radio. Refer to Table 1.2 for radios compatible to the WRSM.
- Wave5k mode – configuring the WRSM to be used with the Wave 5000 Mobile Client on a smartphone.

CHAPTER 2: WIRELESS RSM PMMN4096_



PREPARING YOUR WRSM FOR USE

Assemble your WRSM by following these steps:

Assembling the Swivel Clip	page 2
Attaching the Battery	page 2
Detaching the Battery.....	page 3
Charging the Battery	page 3
Language Selection	page 4
Recommended Wearing Positions.....	page 5

Assembling the Swivel Clip

Insert the swivel clip through the battery slot. Rotate the clip to the right position as indicated in Figure 2.1 below.

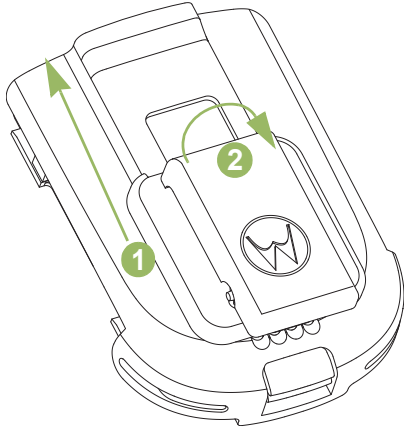

Figure 2.1: Assembling the swivel clip

Attaching the Battery

With the WRSM turned off, align the battery to back chassis and fully slot in until the battery latch is engaged.



Figure 2.2: Attaching the battery into the WRSM

Detaching the Battery

To detach the battery, lift up the battery latch and pull the battery backward until the battery is fully disengaged from the back chassis.

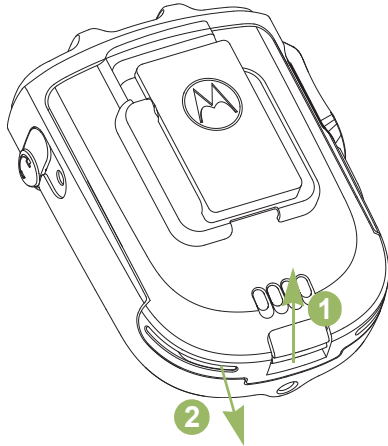

Figure 2.3: Removing the battery from the WRSM

Charging the Battery

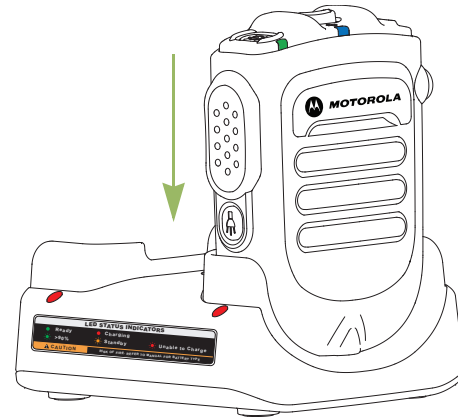

Figure 2.4: Charging position of the WRSM with battery attached



WARNING

To avoid a possible explosion:

- **DO NOT** replace the battery in any area labeled “hazardous atmosphere”.
- **DO NOT** discard batteries in a fire.

The Motorola-approved battery shipped with your WRSM is uncharged. Prior to using a new battery, fully charge the new battery to ensure optimum capacity and performance.

NOTE: When charging a battery attached to a WRSM, turn the WRSM OFF to ensure a full charge.

Battery Charger

To charge the battery, place the battery, with or without the WRSM, in a Motorola-approved charger. When initially inserting the battery into the charger, the charger’s LED will turn red. DO NOT use WRSM until the charger’s LED turn Green,

The charger’s LED indicates the charging progress; see Chapter 3 and Chapter 4 or the label printed on the charger.

Align the slot of the battery with the charger’s rail and slot in. Refer to Figure 2.4.

Language Selection

Follow the procedure below if you want to reset to your desired language. Ensure that the WRSM is powered OFF before starting this procedure.

Procedure:

- 1 Press and hold the PTT button before powering ON the WRSM. **DO NOT** release the PTT button.
- 2 Continue holding the PTT Button after clearing the Bluetooth Information (refer to Pairing Your WRSM) until you hear the language selection prompts to enter the language selection feature.
- 3 Select your desired language by pressing the PTT button. Refer to Table 2.1 below for the Language Selection Indicators.

Table 2.1: Language Selection Indicators

State	Power Indication LED	Voice Prompt
Language Selection	LED illuminated	“For English press PTT now” (Menu selection prompts)

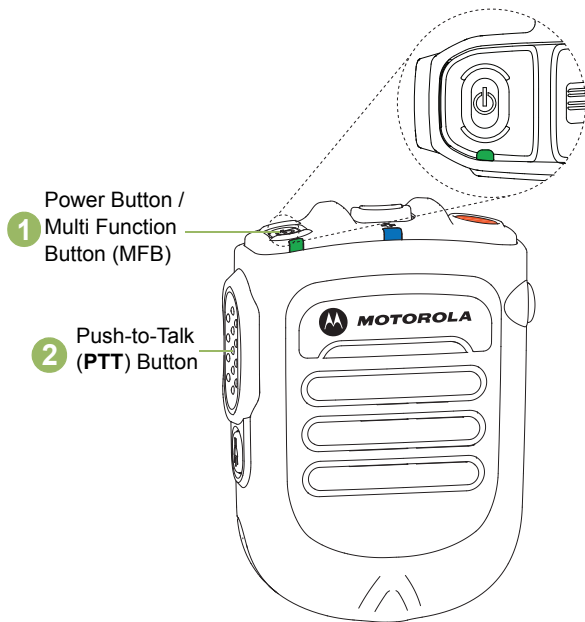

Figure 2.5: Language Selection

Recommended Wearing Positions

For optimum performance, wear the WRSM as highlighted in Figure 2.6 below.



Figure 2.6: Recommended wearing positions

NOTE: When the WRSM is worn on the body, always use Motorola-approved clip. Using approved body-worn accessories is important because the use of non-Motorola-approved accessories may result in exposure levels, which exceed the FCC occupational/controlled environment RF exposure limits.

IDENTIFYING WRSM INDICATORS AND CONTROLS

Take a moment to review the following:

Overview of the WRSM.....	page 6
Power Indicators and Battery Alerts.....	page 7
Audio Indicators.....	page 7

Overview of the WRSM

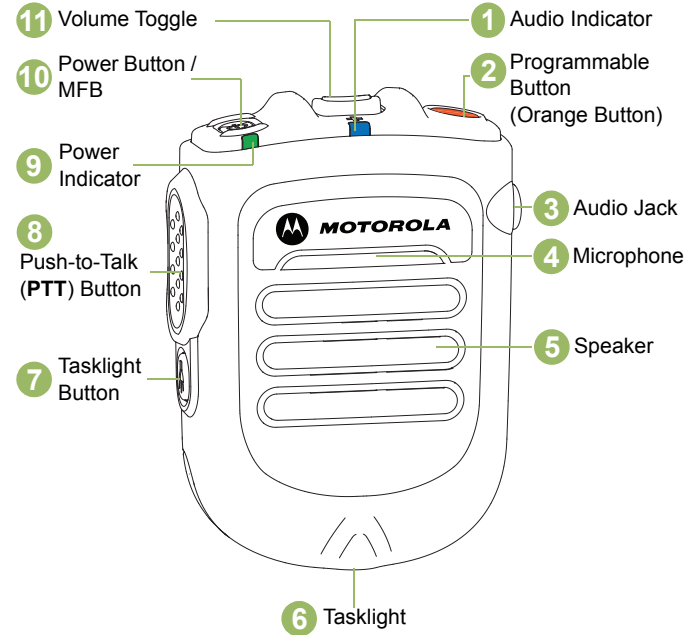





Figure 2.7: Wireless Remote Speaker Microphone Overview

Power Indicators and Battery Alerts

The WRSM is battery powered. It is very important to pay attention to the low battery warning described in Table 2.2 to avoid improper functioning of the WRSM.

Table 2.2: Power Indicators and Battery Alerts

State	Power Indication LED	Tone Indication	Remaining Battery Life
Normal Battery	 Green	No tone	11 hours (full charged) – 30 minutes
Low Battery	 Amber	Low Battery tone every 2 minutes	Less than 30 minutes
Critical Battery	 Red	Low Battery tone every 30 seconds	Less than 10 minutes

Audio Indicators

Table 2.3: Audio Indicators

State	Audio Indication LED
Audio Not Available, Device Not Paired	 OFF
Audio Available, Good Signal	 Blue Blink
Audio Available, Poor Signal / Edge of Range	 Amber Blink
Audio Available, Muted	 Red Blink
Audio Not Available, Disconnected / Reconnecting	 Blue Solid
Audio Not Available, Disconnected / Reconnecting and Muted	 Red Solid

GENERAL WRSM OPERATION

Once you understand how your WRSM is configured, you are ready to use your WRSM. Use this navigation guide to familiarize yourself with the basic features:

Powering ON/OFF the WRSM	page 8
Volume Control	page 9
Pairing Your WRSM.	page 9
Subsequent Connection	page 10
Poor Signal / Out Of Range Warning Indication	page 10
Programmable Button (Orange Button)	page 11
Tasklight Button	page 11
Dark Mode	page 11
Secondary Receiver Audio Accessory.	page 12
Failure Detected Indication and Handling	page 13
Troubleshooting	page 13
Firmware Upgrade	page 13

Powering ON/OFF the WRSM

To power ON the WRSM, press and hold the Power Button until you hear “Motorola Solutions” prompt. To power OFF, press the Power Button until the WRSM turns off.

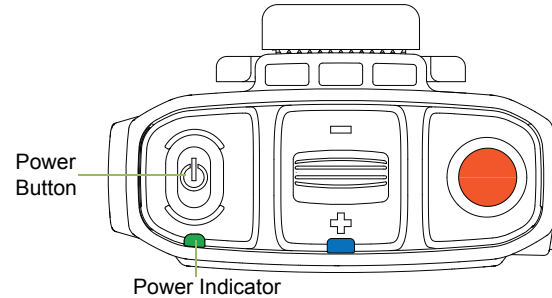

Figure 2.8: Powering on your WRSM

Table 2.4: Power ON/OFF LED and Tone Indicators

Power	Power Indication LED	Tone Indication	Voice Prompt
ON	LED blinks 3 times	“Motorola Solutions”	“Motorola Solutions, Power On”
OFF	LED blinks 3 times then OFF	Power Off tone	“Power Off”

Volume Control

To increase the volume, push volume lever towards the \oplus . To decrease the volume, push lever towards the \ominus .

To mute, hold lever to the \ominus for 2 seconds. To unmute, push lever to the \oplus or press the PTT button. Volume returns to the previous level.

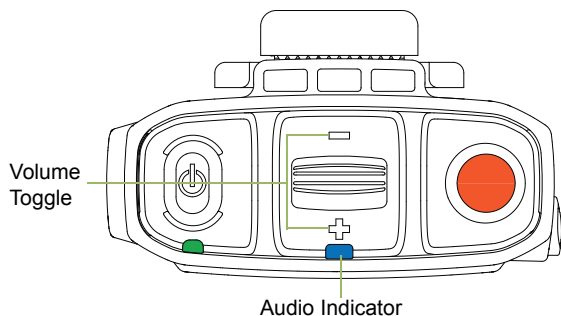

Figure 2.9: Volume Control

The color of the Audio Indicator LED changes according to Table 2.3 on page 7.

Pairing Your WRSM

Procedure:

- 1 Verify that both the host and the WRSM are powered ON (First time only: Once the WRSM is powered ON, if not previously selected, the WRSM will instruct the user to select language or tone, and then it goes into Pairing Mode automatically.).
- 2 Both the WRSM and wireless host must be within pairing range (recommended pairing range is within 1 meter).
- 3 Once the devices are paired successfully, a "Pairing Successful" tone or "Connecting" voice prompt is played on the WRSM.
- 4 Press the MFB button to start the connection process when you hear the "Ring" tone indicating Host is requesting for connection.
- 5 Wireless Link Connected with Host indication is provided upon successful link establishment (refer to Table 2.5 on page 10).
- 6 Your WRSM is now ready to be used.

Subsequent Connection

Same Host:

If the Bluetooth link is lost, connection will be automatically reestablished when the host and device come within 10 meter range (line-of-sight).

New Host:

- 1 Put the wireless device in Pairing Mode by powering ON while pressing the PTT button simultaneously.
- 2 Follow steps from Pairing Your WRSM.

Table 2.5: Wireless Link and Pairing Indicators

State	Indication LED	Tone Indication	Voice Prompt
Not Paired	Blue LED blinking	Pairing Ready tone	"Searching for Host"
Paired Successfully	Blue LED Solid for 2 seconds	Pairing Successful tone	"Connecting"
Wireless Link Connected with Host	Blue LED Heartbeat: Long OFF and Short ON	Connected tone	"Headset Connected"
Wireless Link Disconnected from Host	Blue LED Solid ON	Disconnected tone every 2 minutes for 10 minutes	"Headset Disconnected"

Poor Signal / Out Of Range Warning Indication

You will be prompted with the Poor Signal / Out Of Range Warning Indication if the WRSM is about to lose the wireless link at Bluetooth fringe area.

This warning indication will turn off if the user moves closer or if the signal quality improves.

Refer to Table 2.6 below for the Poor Signal / Out Of Range Indication:

Table 2.6: Poor Signal / Out Of Range Warning Indicator

State	Audio Indication LED	Tone Indication
Poor Signal / Out Of Range	Amber LED illuminated for 2 seconds	"Bad Bonk" Tone

Push-to-Talk (PTT) Button

Press and hold down the PTT button to talk. Release the PTT button to listen. The microphone is activated when the PTT button is pressed.



Figure 2.10: Pressing Push-to-Talk Button

Programmable Button (Orange Button)

This Programmable Button is mapped to the Accessory Orange Button for Portable Radios. Pressing the Programmable Button on the WRSM will trigger the event set in Accessory Orange Button. The Accessory Orange Button is programmable through radio's Customer Programming Software (CPS). Your radio's User Guide contains a full description of the programmable functions that are available through this button.

Tasklight Button

Press the Tasklight Button for 1 second to switch ON/OFF the tasklight. During low/critical battery, the Tasklight blinks for 30 seconds and will be auto switched OFF.

NOTE: The Tasklight is disabled when WRSM is in Dark Mode.

Dark Mode

Dark Mode allows you to turn OFF the LEDs on the WRSM.

IMPORTANT: When the WRSM is in Dark Mode and muted state, all indications will be turned OFF.

To activate the Dark Mode feature, follow the steps below:

Procedure:

- 1 Press and hold the Tasklight Button until Dark Mode is ON. The Tasklight will blink for 1 second upon entering/exiting Dark Mode.
- 2 Refer to Table 2.7 below for the Dark Mode Indicators.

NOTE: To disable the Dark Mode feature, press the Tasklight Button for 3 seconds.

Table 2.7: Dark Mode Indicators

Indication	Power Indication, Audio Indication and Tasklight LED	Tone Indication	Voice Prompt
Dark Mode ON	LED illuminated for 1 second then OFF	"Dark Mode" tone	"Lights OFF, Press and hold Tasklight Button to switch lights ON"
Dark Mode OFF	LED illuminated for 1 second	"Dark Mode" tone	"Lights ON"

NOTE: All three LEDs (Power Indicator, Audio Indicator & Tasklight) blink for 1 second and off at the same time when turning ON/OFF the Dark Mode.

Secondary Receiver Audio Accessory

When a secondary accessory is plugged into the audio jack, audio will be routed through secondary accessory

Attaching Secondary Receiver Audio Accessory

Lift up the dust cover and rotate 90°. Plug the dust cover to the housing slot. Insert the secondary receiver audio accessory to 3.5 mm audio jack.

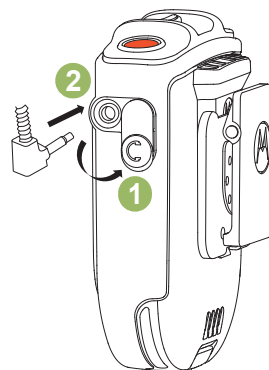

Figure 2.11: Attaching secondary receiver audio accessory

Optional Accessories

Table 2.8: Optional Accessories

Part Number	Description
RLN4941_	Earpiece with Coiled Cord and 3.5 mm RT Angle Plug
RLN4885_	Receiver Earbud for Remote Speaker Microphone

NOTE: Some part numbers may have regional prefix such as AA, MD or AZ.

Failure Detected Indication and Handling

Any product error is indicated by alternating Red and Green blinks and a failure detected indication (tone / voice prompt) will be heard. A few seconds later the WRSM will recover.

Troubleshooting

If at any time the wireless connection cannot be re-established, or the WRSM is operating incorrectly:

Procedure:

- 1 Power cycle the WRSM and the two-way radio.
- 2 Refer to "Pairing Your WRSM" on page 9" to repeat the connection process.

Firmware Upgrade

Firmware upgrade is available for this WRSM and it is only upgradeable by your dealer. Check with your dealer for more information on the latest firmware upgrades.

NOTE: DO NOT charge the WRSM with this micro USB port, it is strictly for firmware upgrade only.

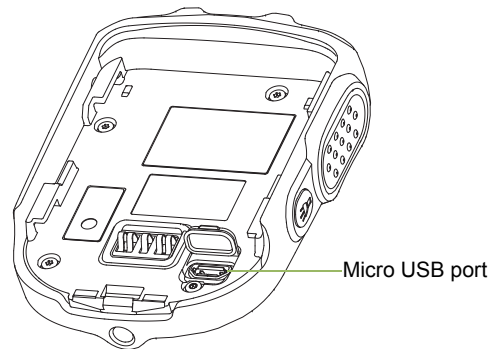

Figure 2.12: Location of the micro USB port

NOTES

CHAPTER 3: DUAL-UNIT CHARGER PMLN6714_



The Dual-Unit Charger is intended for use with the Motorola-approved Lithium-ion rechargeable batteries (listed in Table 3.1). Both pockets are capable in charging Wireless Remote Speaker Microphone (WRSM) with battery or battery alone.

An illuminated LED indicates the state of charge for the first and second pocket.

PREPARING YOUR DUC FOR USE

Take a moment to review the following:

Operational Guidelines	page 24
Motorola Authorized Battery	page 24
Motorola Authorized Power Sources/Power Supplies	page 24
Overview of the DUC	page 25
Operating Instructions	page 26
LED Light Indication	page 27
Troubleshooting	page 28

Operational Guidelines

- Always remember to power ON the Dual-Unit Charger first before inserting the WRSM with the attached battery or battery alone into the pocket.
- The Dual-Unit Charger is designed to provide simultaneous charging for both pockets.

Motorola Authorized Battery

The battery listed in Table 3.1 is approved for use with the Dual-Unit Charger.

Table 3.1: Motorola Authorized Battery

Kit (Part) Number	Platform/Description
PMNN4461_	Battery Standard Li-Ion 1750M1880T

NOTE: The Dual-Unit Charger is not designed to accommodate the alkaline battery tray.

Motorola Authorized Power Sources/Power Supplies

The Power Sources/Power Supplies listed in Table 3.2 are approved for use with the Dual-Unit Charger:

Table 3.2: Motorola Authorized Power Supply

Power Supply Kit Number	Description
25012022001*	Power Supply, Charger Switch Mode, 110 – 240 V US/NA/JPN/TAIWAN
25012022002	Power Supply, Charger Switch Mode, 110 – 240 V EURO
25012022003	Power Supply, Charger Switch Mode, 110 – 240 V UK
25012022004	Power Supply, Charger Switch Mode, 110 – 240 V CHINA
25012022006	Power Supply, Charger Switch Mode, 110 – 240 V AUS/NZ
25012022007	Power Supply, Charger Switch Mode, 110 – 240 V BRZ
25012022008	Power Supply, Charger Switch Mode, 110 – 240 V ARG
25012022009	Power Supply, Charger Switch Mode, 110 – 240 V KOR

* Charger only UL approved when shipped with this power supply. (Applicable for North America region only)

Overview of the DUC

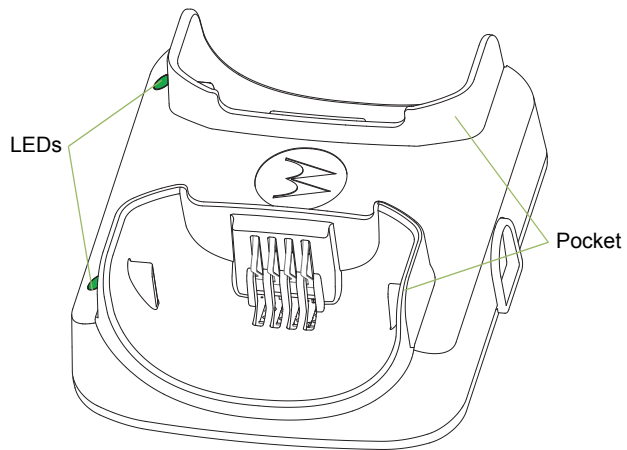

Figure 3.1: Dual-Unit Charger (Front View)

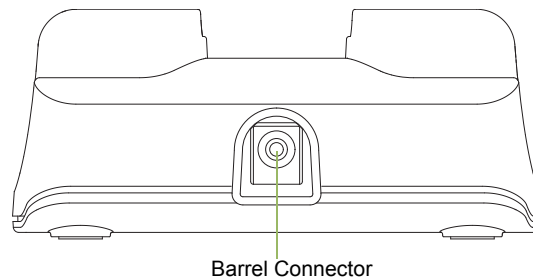

Figure 3.2: Dual-Unit Charger (Side View)

Operating Instructions

Dual-Unit Chargers are intended for use only with the authorized Motorola battery and power supplies listed in Table 3.1 and Table 3.2; usage with unauthorized products may prevent proper operation and may damage the device.

The battery charger will accommodate a WRSM with an attached battery or battery alone in either pocket. To charge a battery, use the following procedure:

- 1 Plug the power supply cord into the barrel connector on the back of the charger.
- 2 Plug the power supply into the appropriate AC outlet. The charger LED will flash single green once to indicate a successful power-up.
- 3 Insert a WRSM with battery into the charger's pocket by:
 - a Aligning the groove on each side of the battery with the corresponding raised rail on each side of the charger pocket.
 - b Sliding the WRSM with battery into the charger pocket, ensuring complete contact between the charger and battery contacts.
- 4 When the WRSM with battery is properly seated in the pocket, the charger LED will light in accordance with Table 3.3.
- 5 Insert a battery into the charger's pocket by:
 - a Aligning the slot on each side of the battery with the corresponding raised rail on each side of the charger pocket.

- b Sliding the battery into the charger pocket, ensuring complete contact between the charger and battery contacts.
- 6 When the battery is properly seated in the pocket, the charger LED will light in accordance with Table 3.3.

NOTE: Charge new batteries overnight to ensure full charge. To minimize charge time, it is recommended to turn the WRSM OFF.
The Dual-Unit Charger is not designed to accommodate the alkaline battery tray.

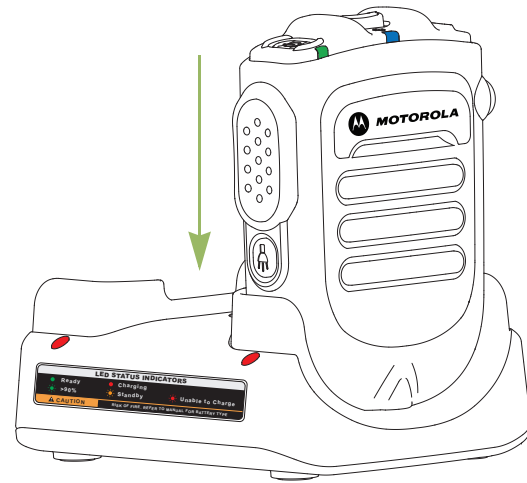

Figure 3.3: Charging position of the WRSM on a Dual-Unit Charger

LED Light Indication

When troubleshooting, always observe the color of the LED.

Table 3.3: Charger Status







LED Indication	Charger State
 Steady Green	Charged at least 95%
 Steady Red	Rapid charge
 Single Flash Green	Charged successfully powered up and is ready for use
 Slow Flash Green	Nearly charged at least 90%
 Slow Flash Amber	Battery under voltage recovery OR Battery temperature is either too hot or too cold – Wait to charge If battery temperature is within operating temperature, there may be a fault connection – DO NOT charge battery

Table 3.3: Charger Status (Continued)

 Fast Flash Red	Battery under voltage recovery time out OR Loss of charge current control OR Excessive power supply voltage OR Fault connection happened – DO NOT charge battery
 Off	If battery is inserted into a successfully powered up charger, battery may have bad contact with charger

Troubleshooting

If There is Fast Flash Red Indication:

- 1 Confirm the battery being used with the WRSM is listed in Table 3.1 and is good in condition.
- 2 Confirm that the power supply being used with the WRSM is listed in Table 3.2 and is good in condition.
- 3 Remove the battery and restart the Dual-Unit Charger.
- 4 If the symptom persist, please send the Dual-Unit Charger to the nearest Service Center for further verification.

If There is No LED Indication:

- 1 Check that the WRSM with battery or the battery is inserted correctly in the pocket.
- 2 Make sure that the power supply is plugged into an appropriate AC outlet and the LED on the power supply is on.
- 3 Ensure that the power supply cable is plugged securely into the charger socket.
- 4 Confirm that the battery being used with the WRSM is listed in Table 3.1.
- 5 If the symptom persist, please send the Dual-Unit Charger to the nearest Service Center for further verification.

CHAPTER 4: VEHICULAR CHARGER PMLN6716_



The Vehicular Charger is intended for use with the Motorola-approved Lithium-ion rechargeable batteries (listed in Table 4.1). The pocket is capable in charging Wireless Remote Speaker Microphone (WRSM) with battery or battery alone. An illuminated LED indicates the state of charging.

PREPARING YOUR VEHICULAR CHARGER FOR USE

Take a moment to review the following:

Operational Guidelines	page 30
Operating Specifications	page 30
Motorola-Authorized Battery	page 30
Overview of Vehicular Charger	page 31
Installation	page 31
Operating Instructions	page 32
LED Light Indication	page 37
Troubleshooting	page 38

Operational Guidelines

- Always remember to plug in the CLA first before inserting the WRSM with the attached battery or battery alone into the pocket.
- The Vehicular Charger is designed to be portable.
- The WRSM is designed to be functional even when charging takes place.

Operating Specifications

Vehicular Charger

Input voltage range: 10.8 Vdc to 33.0 Vdc

Battery Charging Interface

Max Output voltage: 4.20 Vdc

Motorola-Authorized Battery

The battery listed in Table 4.1 is approved for use with the Vehicular Charger.

Table 4.1: Motorola-Authorized Battery

Kit (Part) Number	Platform/Description
PMNN4461_	Battery Standard Li-Ion 1750M1880T

Overview of Vehicular Charger

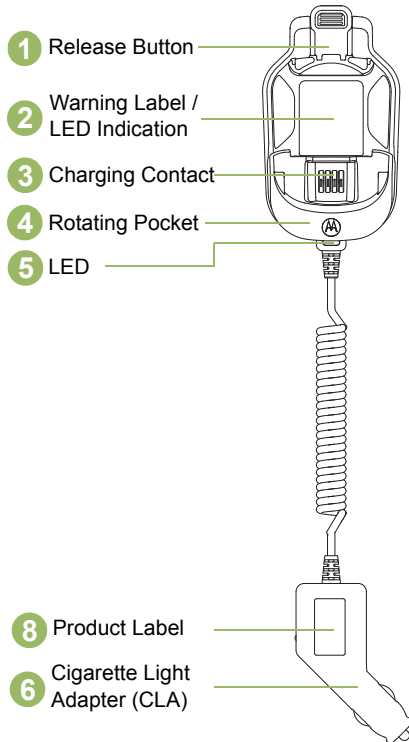

Figure 4.1: Overview of the Vehicular Charger

Installation

Install Mounting Bracket (HLN9073_)

Refer to Figure 4.2 below and attach hang-up clip (1) to vehicle using two sheet metal screws and back-up plate provided. Place back-up plate (4) behind dashboard. Use flat-head screw (2) in top mounting hole and hex-washer screw (3) in bottom mounting hole. Be certain mounting screws fasten into holes in back-up plate.

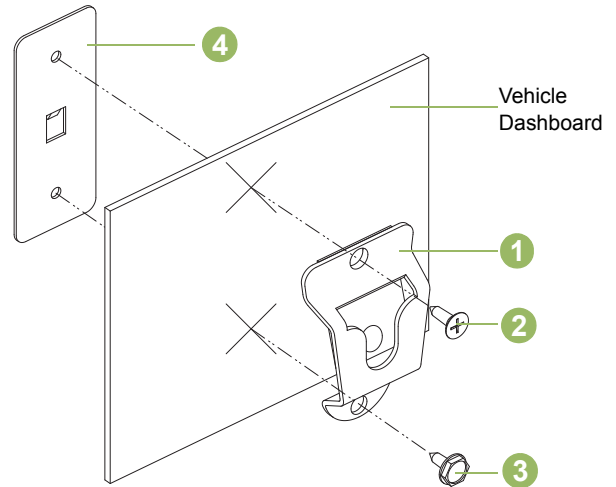

Figure 4.2: Installing the Mounting Bracket

Table 4.2: Mounting Brackets Description

Item	Motorola Part Number	Description
1	0180757T98	Hang-up Clip
2	0312002C01	Flat-Head Screw
3	0312002A01	Hex-Washer Head Screw
4	0780257N01	Back-up Plate

Operating Instructions

Vehicular Chargers are intended for use only with the authorized Motorola battery listed in Table 4.1 ; usage with unauthorized products may prevent proper operation and may damage the device.

Placing and Removing the Vehicular Charger from Mounting Bracket

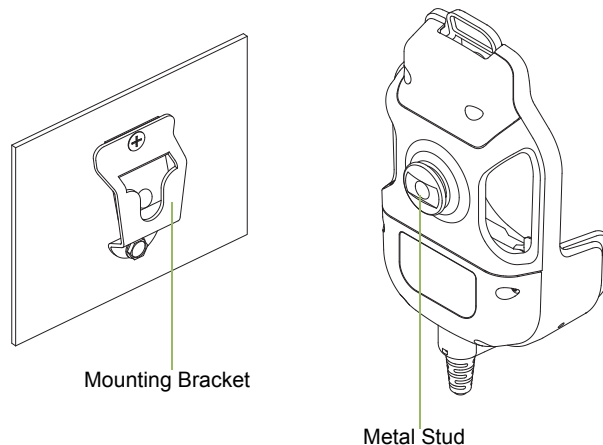

Figure 4.3: Removing Vehicular Charger from Mounting Bracket

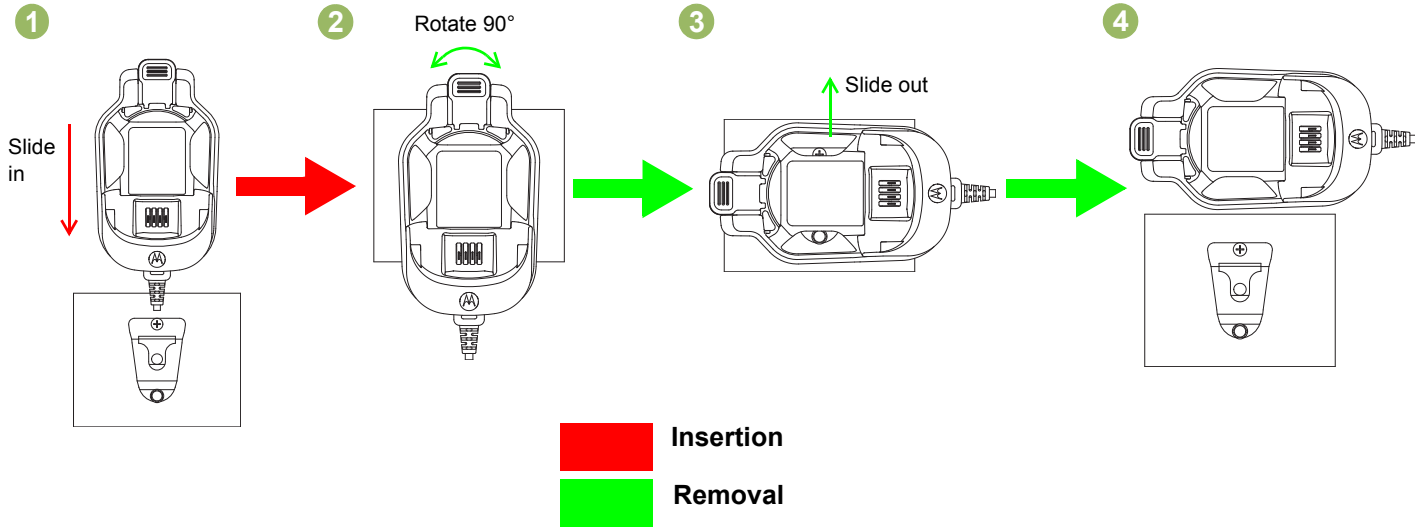

Figure 4.4: Placing and Removing the Vehicular Charger from the Mounting Bracket

2 Slide out the cradle as per step (4).

Mount the Charger

1 Slide in the stud onto the bracket as per step (1).

Remove the Charger

1 Rotate the cradle horizontally (90 °) as per step (2) & (3).

Placing and Removing the WRSM or Battery to and from the Vehicular Charger

Placing the WRSM or Battery to the Vehicular Charger

The Vehicular Charger will accommodate a WRSM with an attached battery or battery alone in pocket. To charge a battery, use the following procedure:

- 1 Plug in the CLA adaptor to CLA power supply. The charger LED will flash single green once to indicate a successful power-up.
- 2 Insert a WRSM with battery into the charger's pocket by:
 - a Aligning the groove on each side of the battery with the corresponding raised rail on each side of the charger pocket per Figure (R1).
 - b Pressing on the front – top surface of the WRSM according to the direction indicated in Figure (R2) to lock the WRSM into Vehicular Charger.
- 3 When the WRSM with battery is properly seated in the pocket, the charger LED will light in accordance with Table 4.3 per Figure (R3).
- 4 Insert a battery into the charger's pocket by:
 - a Aligning the groove on each side of the battery with the corresponding raised rail on each side of the charger pocket per Figure (B1).
 - b Pressing on the front – top surface of the battery according to the direction indicated in Figure (B2) to lock the battery into Vehicular Charger.

- 3 When the battery is properly seated in the pocket, the charger's LED will light in accordance with Table 4.3 per Figure (B3).

Removing the WRSM or Battery from the Vehicular Charger

The Vehicular Charger will accommodate a WRSM with an attached battery or battery alone in pocket. To stop charging a battery, use the following procedure:

- 1 Unplug the CLA from the vehicle's cigar lighter socket.
- 2 Remove a WRSM with battery from the charger's pocket by:
 - a Pressing on the Vehicular Charge's release button to unlatch the battery per Figure (R3).
 - b Remove the WRSM from the pocket by sliding the WRSM upward per Figure (R2).
- 3 Remove a battery from the charger's pocket by:
 - a Pressing on the Vehicular Charge's release button to unlatch the battery per Figure (B3).
 - b Remove the battery from the pocket by sliding the battery upward per Figure (B2).

Attach and Remove WRSM

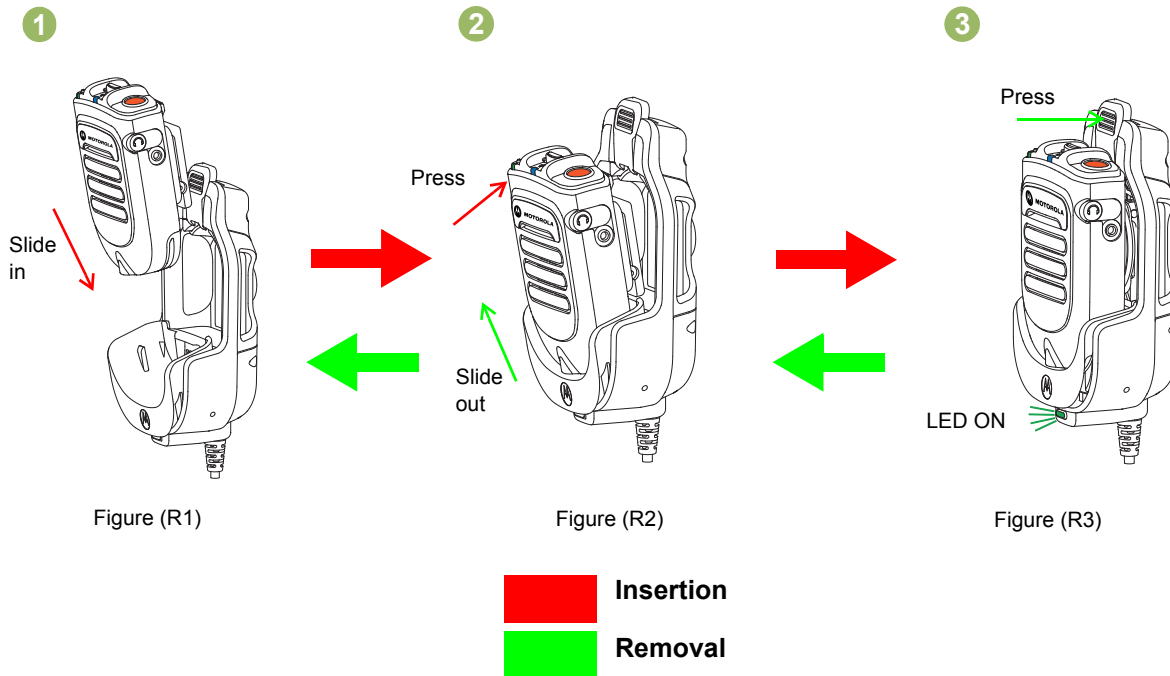

Figure 4.5: Attaching and Removing the WRSM from the Vehicular Charger

Attach and Remove Battery

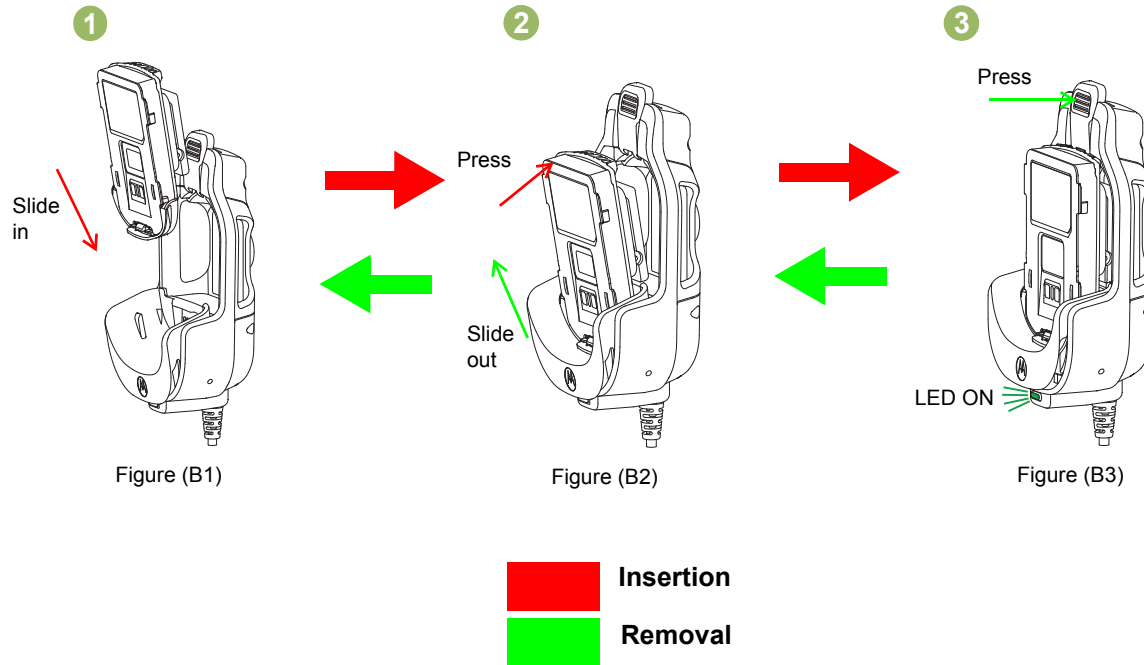

Figure 4.6: Attaching and Removing the Battery from the Vehicular Charger

Swivel Clip Position When Placing Onto Vehicular Charger

The Vehicular Charger will accommodate for both swivel clips:

- Standard swivel clip (PMLN6743_) – Any rotational position
- D-ring swivel clip (42009312001) – Horizontal position

Rotate D-ring swivel clip to horizontal position before inserting the WRSM or battery into the Vehicular Charger.

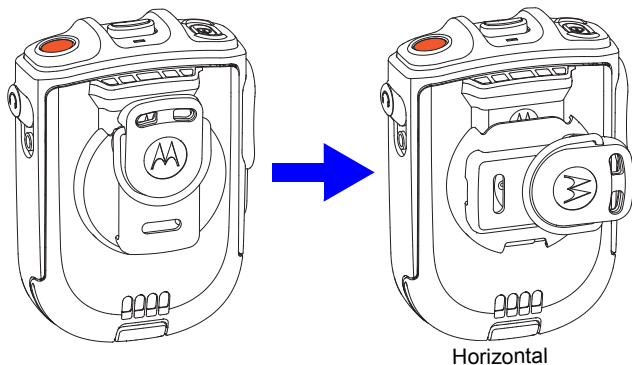

Figure 4.7: Swivel Clip Position

LED Light Indication

When troubleshooting, always observe the color of the LED.

Table 4.3: Charging Status







LED Indication	Charger State
 Steady Green	Charged at least 95%
 Steady Red	Rapid charge
 Single Flash Green	Charged successfully powered up and is ready for use
 Slow Flash Green	Nearly charged at least 90%
 Slow Flash Amber	Battery under voltage recovery OR Battery temperature is either too hot or too cold – Wait to charge If battery temperature is within operating temperature, there may be a fault connection – DO NOT charge battery

Table 4.3: Charging Status (Continued)

 Fast Flash Red	Battery under voltage recovery time out OR Loss of charge current control OR Excessive power supply voltage OR Fault connection happened – DO NOT charge battery
 Off	If battery is inserted into a successfully powered up charger, battery may have bad contact with charger

Troubleshooting

If There is Fast Flash Red Indication:

- 1 Confirm the battery being used with the WRSM is listed in Table 4.1 and is good in condition.
- 2 Remove the battery and restart the Vehicular Charger.
- 3 If the symptom persist, please send the Vehicular Charger to the nearest Service Center for further verification.

If There is No LED Indication:

- 1 Check that the WRSM with battery or the battery is inserted correctly in the pocket.
- 2 Make sure that the CLA adapter is plugged into a CLA power source and the LED on the CLA adapter is on.
- 3 Confirm that the battery being used with the WRSM is listed in Table 4.1 .

CHAPTER 5: REPLACEABLE PARTS

Other than the replaceable parts listed below, the PMMN4096_, PMLN6714_ and PMLN6716_ are not repairable.

The following parts are available:

Table 5.1: Replaceable Parts

Part Number	Description
PMLN6743_	Swivel Clip
42009312001	D-Ring Swivel Clip
PMNN4461_	Battery Standard Li-Ion 1750M1800T
25012022001*	Power Supply, Charger Switch Mode, 110 – 240 V US/NA/JPN/TAIWAN
25012022002	Power Supply, Charger Switch Mode, 110 – 240 V EURO
25012022003	Power Supply, Charger Switch Mode, 110 – 240 V UK
25012022004	Power Supply, Charger Switch Mode, 110 – 240 V CHINA
25012022006	Power Supply, Charger Switch Mode, 110 – 240 V AUS/NZ
25012022007	Power Supply, Charger Switch Mode, 110 – 240 V BRZ
25012022008	Power Supply, Charger Switch Mode, 110 – 240 V ARG

Table 5.1: Replaceable Parts (Continued)

Part Number	Description
25012022009	Power Supply, Charger Switch Mode, 110 – 240 V KOR
HLN9073_	Microphone Hang-up Clip
KT-SB1X-LANYD3	Standard Lanyard with Velcro

* Charger only UL approved when shipped with this power supply.
(Applicable for North America region only)

NOTES

CHAPTER 6: OPEN SOURCE SOFTWARE LEGAL NOTICE

This Motorola Solutions Product contains Open Source Software. For information regarding licenses, acknowledgments, required copyright notices and other usage terms, refer to the documentation for this Motorola Solutions Product at:

<https://businessonline.motorolasolutions.com>

Go to: **Resource Center > Product Information > Manual > Accessories > Remote Speaker Microphone**

NOTES

CHAPTER 7: SERVICE AND SUPPORT

DO NOT disassemble the PMMN4096_, PMLN6714_ and PMLN6716_; they are not repairable. Order replacement parts listed in "REPLACEABLE PARTS" on page 41.

Please contact Motorola Solutions Customer Care as shown in Table 7.1 below for ordering or any technical troubleshooting assistance.

Table 7.1: Motorola Solutions Customer Care Phone Numbers

Regions	Phone Number
US and Canada	1-800-927-2744
Latin America	(5) 257-6700 or (571) 602-1111
European (Repair and Service Centre)	+49-30-6686-1555
Asia	1-800-88-0089 (Contact your Motorola Dealer for Support)

NOTES

CHAPTER 9: WARRANTY

Contact your Motorola Solutions dealer for detailed information on the standard warranty. The workmanship warranty guarantees against defects in workmanship under normal use and service.

NOTE: Warranty is void after customer replacement of any parts other than replacement parts listed.

Table 9.1: Warranty Period

Name	Year
Wireless Remote Speaker Microphone PMMN4096_	One (1) Year
Dual Unit Charger PMLN6714_	One (1) Year
Vehicular Charger PMLN6716_	One (1) Year
Wireless Remote Speaker Microphone Battery PMNN4461_	One (1) Year

Limited Warranty

MOTOROLA COMMUNICATION PRODUCTS

I. WHAT THIS WARRANTY COVERS AND FOR HOW LONG:

MOTOROLA SOLUTIONS, INC. ("MOTOROLA") at its option, will at no charge either repair the Product (with new or reconditioned parts), replace it (with a new or reconditioned Product), or refund the purchase price of the Product during the warranty period provided it is returned in accordance with the terms of this warranty. Replaced parts or boards are warranted for the balance of the original applicable warranty period. All replaced parts of Product shall become the property of MOTOROLA.

This express limited warranty is extended by MOTOROLA to the original end user purchaser only and is not assignable or transferable to any other party. This is the complete warranty for the Product manufactured by MOTOROLA. MOTOROLA assumes no obligations or liability for additions or modifications to this warranty unless made in writing and signed by an officer of MOTOROLA.

Unless made in a separate agreement between MOTOROLA and the original end user purchaser, MOTOROLA does not warrant the installation, maintenance or service of the Product.

MOTOROLA cannot be responsible in any way for any ancillary equipment not furnished by MOTOROLA which is attached to or used in connection with the Product, or for operation of the Product with any ancillary equipment, and all such equipment is expressly excluded from this warranty. Because each system which may use the Product is unique, MOTOROLA disclaims liability for range, coverage, or operation of the system as a whole under this warranty.

II. GENERAL PROVISIONS:

This warranty sets forth the full extent of MOTOROLA'S responsibilities regarding the Product. Repair, replacement or refund of the purchase price, at MOTOROLA's option, is the exclusive remedy. THIS WARRANTY IS GIVEN IN LIEU OF ALL OTHER EXPRESS WARRANTIES. IMPLIED WARRANTIES, INCLUDING WITHOUT LIMITATION, IMPLIED WARRANTIES OF MERCHANTABILITY AND FITNESS FOR A PARTICULAR PURPOSE, ARE LIMITED TO THE DURATION OF THIS LIMITED WARRANTY. IN NO EVENT SHALL MOTOROLA BE LIABLE FOR DAMAGES IN EXCESS OF THE PURCHASE PRICE OF THE PRODUCT, FOR ANY LOSS OF USE, LOSS OF TIME, INCONVENIENCE, COMMERCIAL LOSS, LOST PROFITS OR SAVINGS OR OTHER INCIDENTAL, SPECIAL OR CONSEQUENTIAL DAMAGES ARISING OUT OF THE USER OR INABILITY TO USE SUCH PRODUCT, TO THE FULL EXTENT SUCH MAY BE DISCLAIMED BY LAW.

III. STATE LAW RIGHTS:

SOME STATES DO NOT ALLOW THE EXCLUSION OR LIMITATION OF INCIDENTAL OR CONSEQUENTIAL DAMAGES OR LIMITATION ON HOW LONG AND IMPLIED WARRANTY LASTS, SO THE ABOVE LIMITATION OR EXCLUSIONS MAY NOT APPLY.

This warranty gives specific legal rights, and there may be other rights which may vary from state to state.

IV. HOW TO GET WARRANTY SERVICE:

You must provide proof of purchase (bearing the date of purchase and Product item serial number) in order to receive warranty service and, also, deliver or send the Product item, transportation and insurance prepaid, to an authorized warranty service location. Warranty service will be provided by MOTOROLA through one of its authorized warranty service locations. If you first contact the company which sold you the

Product (e.g., dealer or communication service provider), it can facilitate your obtaining warranty service. You can also call MOTOROLA at 1-800-927-2744 US/Canada.

V. WHAT THIS WARRANTY DOES NOT COVER

- A Defects or damage resulting from use of the Product in other than its normal and customary manner.
- B Defects or damage from misuse, accident, water, or neglect.
- C Defects or damage from improper testing, operation, maintenance, installation, alteration, modification, or adjustment.
- D A Product subjected to unauthorized Product modifications, disassembles or repairs (including, without limitation, the addition to the Product of non-MOTOROLA supplied equipment) which adversely affect performance of the Product or interfere with MOTOROLA's normal warranty inspection and testing of the Product to verify any warranty claim.
- E Product which has had the serial number removed or made illegible.
- F Freight costs to the repair depot.
- G A Product which, due to illegal or unauthorized alteration of the software/firmware in the Product, does not function in accordance with MOTOROLA's published specifications or the FCC certification labeling in effect for the Product at the time the Product was initially distributed from MOTOROLA.
- H Scratches or other cosmetic damage to Product surfaces that does not affect the operation of the Product.
- I Normal and customary wear and tear.

VI. PATENT AND SOFTWARE PROVISIONS:

MOTOROLA will defend, at its own expense, any suit brought against the end user purchaser to the extent that it is based on a claim that the Product or parts infringe a United States patent, and MOTOROLA will pay those costs and damages finally awarded against the end use purchaser in any such suit which are attributable to any such claim, but such defense and payments are conditioned on the following:

- A That MOTOROLA will be notified promptly in writing by such purchaser of any notice of such claim;
- B That MOTOROLA will have sole control of the defense of such suit and all negotiations for its settlement or compromise; and
- C Should the Product or parts become, or in MOTOROLA's opinion be likely to become, the subject of a claim of infringement of a United States patent, that such purchaser will permit MOTOROLA, at its option and expense, either to produce for such purchaser the right to continue using the Product or parts or to replace or modify the same so that it becomes non-infringing or to grant such purchaser a credit for the Product or parts as depreciated and accept its return. The depreciation will be an equal amount per year over the lifetime of the Product or parts as established by MOTOROLA. MOTOROLA will have no liability with respect to any claim of patent infringement which is based upon the combination of the Product or parts furnished hereunder with software, apparatus or devices not furnished by MOTOROLA, nor will MOTOROLA have any liability for the use of ancillary equipment or software for furnished by MOTOROLA which is attached to or used in connection with the Product. The foregoing states the entire liability of MOTOROLA with respect to infringement of patents by the Product or any parts thereof.

Laws in the United States and other countries preserve for MOTOROLA certain exclusive rights for copyrighted MOTOROLA software such as the exclusive rights to reproduce in copies and distribute copies of such MOTOROLA software. MOTOROLA software may be used in only the Product in which the software was originally embodied and such software in such Product may not be replaced, copied, distributed, modified in any way, or used to produce any derivative thereof. No other use including, without limitation, alteration, modification, reproduction, distribution, or reverse engineering of such MOTOROLA software or exercise of rights in such MOTOROLA software permitted. No license is granted by implication, estoppel or otherwise under MOTOROLA patent rights or copyrights.

VII. GOVERNING LAW:

This Warranty is governed by the laws of the State of Illinois, U.S.A.

MOTOROLA, MOTO, MOTOROLA SOLUTIONS and the Stylized M logo are trademarks or registered trademarks of Motorola Trademark Holdings, LLC and are used under license. All other trademarks are the property of their respective owners. © 2016 Motorola Solutions, Inc. All rights reserved.

NOTES



MOTOROLA SOLUTIONS

MOTOROLA, MOTO, MOTOROLA SOLUTIONS and the Stylized M logo are trademarks or registered trademarks of Motorola Trademark Holdings, LLC and are used under license. All other trademarks are the property of their respective owners. © 2016 Motorola Solutions, Inc. All rights reserved.



MN003432A01-AA

