

## **Exhibit VIII**

### **User Information and User Manual**

#### **1) User Card/Booklet**

- 2 pages, contains important information for safe usage and RF energy awareness and control information for compliance with RF energy exposure limits

#### **2) User Service Manual HDT 600 Data Terminal**

- 32 PDF pages total, 20 numbered pages

Please find the information required by Part 15.19, 15.21 & 15.105 in Owners Manual on page V of the manual or page 10 of this PDF file, or click tab to FCC INTERFERENCE WARNING.

**Note:** Items 1 & 2 above follow this cover page



## HANDHELD PORTABLE TERMINAL

HDT600

**BEFORE USING THIS RADIO TERMINAL, READ THIS BOOKLET WHICH CONTAINS IMPORTANT OPERATING INSTRUCTIONS FOR SAFE USAGE AND RF ENERGY AWARENESS AND CONTROL INFORMATION FOR COMPLIANCE WITH RF ENERGY EXPOSURE LIMITS IN APPLICABLE NATIONAL AND INTERNATIONAL STANDARDS.**

The information provided in this document supersedes information contained in user guides published prior to February 2002.

For radio terminals that have been approved as intrinsically safe, read the instructions and information on intrinsic safety in this booklet.

### **Compliance with RF Energy Exposure Standards**

Notice: This radio terminal is intended for use in occupational/controlled applications, where users have been made aware of the potential for exposure and can exercise control over their exposure. This radio terminal device is NOT authorized for general population, consumer or similar use.

### **Federal Communication Commission Regulations:**

The FCC established limits for safe exposure to radio frequency (RF) emissions from portable two-way radios. The FCC requires manufacturers to demonstrate compliance with RF exposure limits before portable two-way radios can be marketed in the U.S. When two-way radios are approved for occupational /controlled environment exposure limits, the FCC requires users to be fully aware of and exercise control over their exposure. Awareness and control of RF exposure can be accomplished by the use of labels, or by education or training through appropriate means, such as information and instructions in user manuals or safety booklets. Your Motorola two-way radio terminal has a RF exposure information label in the battery compartment. This user safety booklet includes useful information about RF exposure and helpful instructions on how to control your RF exposures.

Your Motorola two-way radio terminal is designed and tested to comply with a number of national and international standards and guidelines (listed below) regarding human exposure to radio frequency electromagnetic energy. This radio terminal complies with the IEEE (FCC) and ICNIRP exposure limits for occupational/controlled RF exposure environment at usage factors of up to 50% transmit -50% receive. In terms of measuring RF energy for compliance with the FCC exposure guidelines, your radio terminal radiates measurable RF energy only while it is transmitting, not when it is receiving or in standby mode. Note: that the approved batteries, supplied with this radio terminal are rated for a 5-5-90 duty cycle (5% transmit - 5% receive - 90% standby), even though this radio terminal complies with the FCC occupational exposure limits at usage factors of up to 50% transmit.

### **Your Motorola two-way radio terminal complies with the following RF energy exposure standards and guidelines:**

- United States Federal Communications Commission, Code of Federal Regulations; 47CFR part 2 sub-part J
- American National Standards Institute (ANSI) / Institute of Electrical and Electronic Engineers (IEEE) C95. 1-1992
- Institute of Electrical and Electronic Engineers (IEEE) C95.1-1999 Edition
- International Commission on Non-Ionizing Radiation Protection (ICNIRP) 1998
- Ministry of Health (Canada) Safety Code 6. Limits of Human Exposure to Radio frequency Electromagnetic Fields in the Frequency Range from 3 kHz to 300 GHz, 1999
- Australian Communications Authority Radio communications (Electromagnetic Radiation - Human Exposure) Standard 2001.
- ANATEL, Brasil Regulatory Authority, Resolution 256 (April 11, 2001) "additional requirements for SMR, cellular and PCS product certification."

### **Compliance and Control Guidelines and Operating Instructions for portable two-way radio terminals**

To control your exposure and ensure compliance with the occupational /controlled environment exposure limits always adhere to the following Procedures.

- If you are not using a body-worn accessory and are not using the radio terminal in the intended use position in front of the face, then ensure the antenna and the radio terminal are kept 2.5 cm (one inch) from the body when transmitting. Keeping the radio terminal at a proper distance is important because of RF exposures decrease with distance from the antenna.
- Use only Motorola approved supplied or replacement batteries, and accesso-

68P02963C77-A

Please retain for future use

ries. Use of non-Motorola-approved, batteries and accessories may exceed FCC RF exposure guidelines.

For additional information on RF exposure awareness information, visit the following Motorola website: [www.mot.com/rfhealth](http://www.mot.com/rfhealth).

## Electromagnetic Interference/Compatibility

Note: Nearly every electronic device is susceptible to electromagnetic interference (EMI) if inadequately shielded, designed, or otherwise configured for electromagnetic compatibility.

### Facilities

To avoid electromagnetic interference and/or compatibility conflicts, turn off your radio terminal in any facility where posted notices instruct you to do so. Hospitals or health care facilities may be using equipment that is sensitive to external RF energy.

### Aircraft

When instructed to do so, turn off your radio terminal when on board an aircraft. Any use of a radio terminal must be in accordance with applicable regulations per airline crew instructions.

## Medical Devices

### Pacemakers

The Advanced Medical Technology Association (AdvaMed) recommends that a minimum separation of 6 inches (15 centimeters) be maintained between a handheld wireless radio terminal and a pacemaker. These recommendations are consistent with those of the U.S. Food and Drug Administration.

#### Persons with pacemakers should:

- ALWAYS keep the radio terminal more than 6 inches (15 centimeters) from their pacemaker when the radio terminal is turned ON.
- Do not carry the radio terminal in the breast pocket.
- Turn the radio terminal OFF immediately if you have any reason to suspect that interference is taking place.

### Hearing Aids

Some digital wireless radio terminals may interfere with some hearing aids. In the event of such interference, you may want to consult your hearing aid manufacturer to discuss alternatives.

## Other Medical Devices

If you use any other personal medical device, consult the manufacturer of your device to determine if it is adequately shielded from RF energy. Your physician may be able to assist you in obtaining this information.



## Operational Warnings

### For Vehicles With an Air Bag

Do not place a portable radio in the area over an air bag or in the air bag deployment area. Air bags inflate with great force. If a portable radio terminal is placed in the air bag deployment area and the air bag inflates, the radio terminal may be propelled with great force and cause serious injury to occupants of the vehicle.

### Potentially Explosive Atmospheres

Turn off your radio terminal prior to entering any area with a potentially explosive atmosphere, unless it is a radio terminal type especially qualified for use in such areas as "Intrinsically Safe" (for example, Factory Mutual, CSA, UL, or CENELEC). Do not remove, install, or charge batteries in such areas. Sparks in a potentially explosive atmosphere can cause an explosion or fire resulting in bodily injury or even death. The areas with potentially explosive atmospheres referred to above include fueling areas such as below decks on boats, fuel or chemical transfer or storage facilities, areas where the air contains chemicals or particles, such as grain, dust or metal powders. Areas with potentially explosive atmospheres are often but not always posted.

### Blasting Caps and Blasting Areas

To avoid possible interference with blasting operations, turn off your radio terminal when you are near electrical blasting caps, in a blasting area, or in areas posted: "Turn off two-way radio terminal." Obey all signs and instructions.

**Owner's Manual**

# **HDT 600**

## **Portable Data Terminal**

68P02966C70-O



Draft Feb 18 03

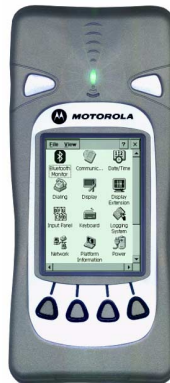

68P02966C70-O





# Contents

<i>COMPUTER SOFTWARE COPYRIGHTS</i>	<i>ii</i>
<i>FCC INTERFERENCE WARNING</i>	<i>v</i>
<i>What is the HDT 600 Terminal</i>	<i>1</i>
<i>HDT 600 Parts</i>	<i>3</i>
<i>Unpacking</i>	<i>4</i>
<i>HDT 600 Cradle Connections</i>	<i>5</i>
<i>Installing the Battery</i>	<i>6</i>
<i>Removing the Battery</i>	<i>6</i>
<i>First Time Battery Charge</i>	<i>7</i>
<i>Charging the Battery</i>	<i>8</i>
<i>Battery Maintenance</i>	<i>9</i>
<i>Turning on the HDT 600</i>	<i>10</i>
<i>Suspend Mode</i>	<i>10</i>
<i>Turning off the HDT 600</i>	<i>10</i>
<i>Using the HDT 600</i>	<i>11</i>
<i>Using the Stylus Pen</i>	<i>11</i>
<i>Scanning With the HDT 600</i>	<i>12</i>
<i>Resetting the HDT 600</i>	<i>13</i>
<i>Cradle Installation</i>	<i>14</i>
<i>Maintaining the HDT 600</i>	<i>16</i>
<i>Accessories</i>	<i>17</i>
<i>What to Do If</i>	<i>18</i>
<i>Battery Warnings and Disposal</i>	<i>20</i>

# COMPUTER SOFTWARE COPYRIGHTS

The Motorola products described in this instruction manual may include copyrighted Motorola computer programs stored in semiconductor memories or other media. Laws in the United States and other countries preserve for Motorola certain exclusive rights for copyrighted computer programs, including the exclusive right to copy or reproduce in any form the copyrighted computer program. Accordingly, any copyrighted Motorola computer programs contained in the Motorola products described in this instruction manual may not be copied or reproduced in any manner without the express written permission of Motorola. Furthermore, the purchase of Motorola products shall not be deemed to grant either directly or by implication, estoppel, or otherwise, any license under the copyrights, patents or patent applications of Motorola, except for the normal non-exclusive, royalty free license to use that arises by operation of law in the sale of a product.

EPS – 34440-B

This warranty applies within the fifty (50) United States, the District of Columbia and Canada.

## LIMITED WARRANTY MOTOROLA COMMUNICATION PRODUCTS

If the affected product is being purchased pursuant to a written Communications System Agreement signed by Motorola, the warranty contained in that written agreement will apply. Otherwise, the following warranty applies.

### I. WHAT THIS WARRANTY COVERS AND FOR HOW LONG:

Motorola Inc. or, if applicable, Motorola Canada Limited ("Motorola") warrants the Motorola manufactured radio communications product, including original equipment crystal devices and channel elements ("Product"), against material defects in material and workmanship under normal use and service for a period of One (1) Year from the date of shipment.

Motorola, at its option, will at no charge either repair the Product (with new or reconditioned parts), replace it with the same or equivalent Product (using new or reconditioned Product), or refund the purchase price of the Product during the warranty period provided purchaser notifies Motorola according to the terms of this warranty. Repaired or replaced Product is warranted for the balance of the original applicable warranty period. All replaced parts of the Product shall become the property of Motorola.

This express limited warranty is extended by Motorola to the original end user purchaser purchasing the Product for purposes of leasing or for commercial, industrial, or governmental use only, and is not assignable or transferable to any other party. This is the complete warranty for the Product manufactured by Motorola. Motorola assumes no obligations or liability for additions or modifications to this warranty unless made in writing and signed by an officer of Motorola. Unless made in a separate written agreement between Motorola and the original end user purchaser, Motorola does not warrant the installation, maintenance or service of the Product.

Motorola cannot be responsible in any way for any ancillary equipment not furnished by Motorola which is attached to or used in connection with the Product, or for operation of the Product with any ancillary equipment, and all such equipment is expressly excluded from this warranty. Because each system which may use the Product is unique, Motorola disclaims liability for range, coverage, or operation of the system as a whole under this warranty.

## II. GENERAL PROVISIONS:

This warranty sets forth the full extent of Motorola's responsibilities regarding the Product. Repair, replacement or refund of the purchase price, at Motorola's option, is the exclusive remedy. THIS WARRANTY IS GIVEN IN LIEU OF ALL OTHER EXPRESS WARRANTIES. MOTOROLA DISCLAIMS ALL OTHER WARRANTIES OR CONDITIONS, EXPRESS OR IMPLIED, INCLUDING THE IMPLIED WARRANTIES OR CONDITIONS OF MERCHANTABILITY AND FITNESS FOR A PARTICULAR PURPOSE. IN NO EVENT SHALL MOTOROLA BE LIABLE FOR DAMAGES IN EXCESS OF THE PURCHASE PRICE OF THE PRODUCT, FOR ANY LOSS OF USE, LOSS OF TIME, INCONVENIENCE, COMMERCIAL LOSS, LOST PROFITS OR SAVINGS OR OTHER INCIDENTAL, SPECIAL, INDIRECT OR CONSEQUENTIAL DAMAGES ARISING OUT OF THE USE OR INABILITY TO USE SUCH PRODUCT, TO THE FULL EXTENT SUCH MAY BE DISCLAIMED BY LAW.

## III. HOW TO GET WARRANTY SERVICE:

Purchaser must notify Motorola's representative or call Motorola's Customer Response Center at 1-800-247-2346 within the applicable warranty period for information regarding warranty service.

## IV. WHAT THIS WARRANTY DOES NOT COVER:

- A) Defects or damage resulting from use of the Product in other than its normal and customary manner.
- B) Defects or damage from misuse, accident, water, or neglect.
- C) Defects or damage from improper testing, operation, maintenance, installation, alteration, modification, or adjustment.
- D) A Product subjected to unauthorized Product modifications, disassemblies or repairs (including, without limitation, the addition to the Product of non-Motorola supplied equipment) which adversely affect performance of the Product or interfere with Motorola's normal warranty inspection and testing of the Product to verify any warranty claim.
- E) Product which has had the serial number removed or made illegible.
- F) Batteries (they carry their own separate limited warranty).
- G) Freight costs to the repair depot.
- H) A Product which, due to illegal or unauthorized alteration of the software/firmware in the Product, does not function in accordance with Motorola's published specifications or with the FCC type acceptance labeling in effect for the Product at the time the Product was initially distributed from Motorola.
- I) Scratches or other cosmetic damage to Product surfaces that does not affect the operation of the Product.
- J) That the software in the Product will meet the purchaser's requirements or that the operation of the software will be uninterrupted or error-free.
- K) Normal and customary wear and tear.
- L) Non-Motorola manufactured equipment unless bearing a Motorola Part Number in the form of an alpha numeric number (i.e., TDE6030B).



## V. GOVERNING LAW

In the case of a Product sold in the United States and Canada, this Warranty is governed by the laws of the State of Illinois and the Province of Ontario, respectively.

## VI. PATENT AND SOFTWARE PROVISIONS:

Motorola will defend, at its own expense, any suit brought against the end user purchaser to the extent that it is based on a claim that the Product or its parts infringe a United States patent, and Motorola will pay those costs and damages finally awarded against the end user purchaser in any such suit which are attributable to any such claim, but such defense and payments are conditioned on the following:

- A) that Motorola will be notified promptly in writing by such purchaser of any notice of such claim;
- B) that Motorola will have sole control of the defense of such suit and all negotiations for its settlement or compromise; and
- C) should the Product or its parts become, or in Motorola's opinion be likely to become, the subject of a claim of infringement of a United States patent, that such purchaser will permit Motorola, at its option and expense, either to procure for such purchaser the right to continue using the Product or its parts or to replace or modify the same so that it becomes non-infringing or to grant such purchaser a credit for the Product or its parts as depreciated and accept its return. The depreciation will be an equal amount per year over the lifetime of the Product or its parts as established by Motorola.

Motorola will have no liability with respect to any claim of patent infringement which is based upon the combination of the Product or its parts furnished hereunder with software, apparatus or devices not furnished by Motorola, nor will Motorola have any liability for the use of ancillary equipment or software not furnished by Motorola which is attached to or used in connection with the Product. The foregoing states the entire liability of Motorola with respect to infringement of patents by the Product or any its parts thereof.

Laws in the United States and other countries preserve for Motorola certain exclusive rights for copyrighted Motorola software such as the exclusive rights to reproduce in copies and distribute copies of such Motorola software. Motorola software may be used in only the Product in which the software was originally embodied and such software in such Product may not be replaced, copied, distributed, modified in any way, or used to produce any derivative thereof. No other use including, without limitation, alteration, modification, reproduction, distribution, or reverse engineering of such Motorola software or exercise of rights in such Motorola software is permitted. No license is granted by implication, estoppel or otherwise under Motorola patent rights or copyrights.

EPS – 48759 – O

# FCC INTERFERENCE WARNING

The FCC requires that manuals pertaining to Class A and Class B computing devices must contain warnings about possible interference with local residential radio and TV reception. This warning reads as follows:

NOTE: This equipment has been tested and found to comply with limits for a Class B digital device, pursuant to Part 90 of the FCC Rules. These limits are designed to provide reasonable protection against harmful interference when the equipment is operated in a commercial or residential environment. This equipment generates, uses, and can radiate radio frequency energy and, if not installed and used in accordance with the instruction manual, may cause harmful interference to radio communications.

This device complies with Part 90 of the FCC Rules. Operation is subject to the following two conditions:

- (1) This device may not cause harmful interference.
- (2) This device must accept any interference received, including interference that may cause undesired operation.

Caution: Changes or modifications made in the radio terminal, not expressly approved by Motorola, will void the user's authority to operate the equipment.

For detailed product safety and RF exposure for portable terminals with two-way radios, refer to Electromagnetic Emission (EME) safety leaflet, Motorola publication number 68P02963C77.

## Trademarks

Motorola and the Motorola logo are registered trademarks of Motorola, Inc.

FlashFile is a trademark of Intel Corporation.

Microsoft, Windows, and Windows CE are registered trademarks of Microsoft Corporation.

## **What is the HDT 600 Terminal**

The HDT 600 is a portable terminal designed for field applications where fast data acquisition is required.

Its ergonomic design is easy to hold and carry. Its unique shape fits the hand, and the back strap provides extra grip. The Windows CE operating system with touch screen and soft-keys provides easy access to various applications.

The HDT 600 is equipped with a 3.6 inch color LCD screen with LED front-light, viewable in all light conditions, including direct sunlight. The touch sensitive screen enables signature capture as well as easy selection from an on-screen menu.

A LASER beam barcode reader (optional) enables one-hand barcode reading on both vertical and horizontal labels. Activation of the barcode is by one of four direct access dedicated trigger keys for right or left handed users.

The unit operates in all weather conditions and is protected against hostile environment factors, such as impact, rain, vibrations and ESD.

An RS232 port serves for uploading and downloading data between the HDT 600 and a PC via the HDT 600 Cradle. Connections for external power supply are also provided. The 1400mA Lithium-Ion battery pack provides at least one shift of normal operation before charging is needed.

The HDT 600 uses the following methods of communication:

- Short distance: Each HDT 600 contains a Bluetooth radio module for short distance communication with peripheral devices such as printers etc.
- Local Area Network (LAN) communication: An optional Spread Spectrum 2.4GHz radio module provides coverage within a local distribution hub.

- Wide Area Network (WAN) communication:
  1. An optional GPRS radio module provides coverage within cellular infrastructure.
  2. An optional DataTAC radio module provides coverage within DataTAC network infrastructure.
  3. An optional iDEN radio module provides coverage within iDEN network infrastructure.

It is also possible to use GPRS and WLAN communication by installing both radios within the HDT 600. In such case the HDT 600 software switches between radios when moving from one coverage area to another.

# HDT 600 Parts

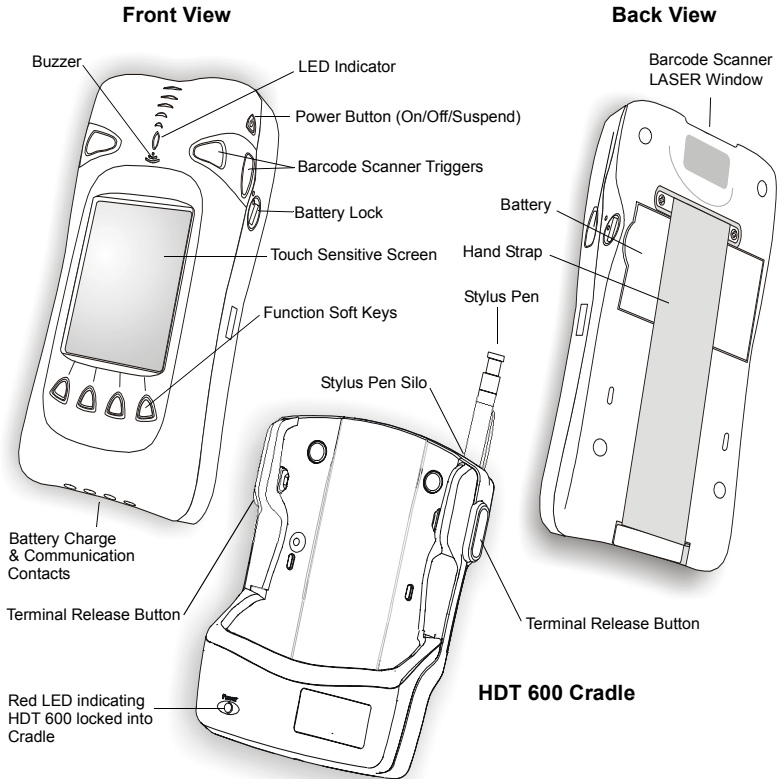

## Unpacking

The HDT 600 Data Terminal and HDT 600 Cradle are shipped in separate packages.

The HDT 600 Data Terminal package includes the following items:

- One HDT 600 Data Terminal unit
- One 7.2V 1400mAH Li-ion battery pack
- One Stylus pen
- This Owner's Manual

The HDT 600 Cradle package includes the following items:

- HDT 600 Cradle
- 12/24 VDC vehicle power cable with 3 Amps fuse or Cigarette lighter adapter
- This Owner's Manual

If ordered, you may also receive optional accessories such as: Cigarette Lighter Cable for Vehicle Cradle or Desktop Adaptor for Vehicle Cradle or Wall Mounting Kit.

Carefully unpack each item from the shipping carton. Check all items for shipping damage, and check that you have received all items ordered. If there is damage or missing items, retain the shipping carton for inspection.

The battery is shipped from factory uncharged and not installed. Charge the battery before using the HDT 600 for the first time. See "First Time Battery Charge" on page 7.

The HDT 600 is shipped with a plastic film protecting the screen. Before using, remove the film and use a soft cloth to buff the display. This ensures smooth gliding of the Stylus pen over the surface.

# HDT 600 Cradle Connections

**Important Note:** *This product should be installed according to local applicable laws and directives.*

The HDT 600 terminal can communicate with a host PC directly through its communications port (COM Port) using an RS232 serial cable

RS232 Cable to PC COM Port

Desktop Adapter

Cigarette Lighter Cable for Vehicle Cradle

3 Amps Fuse inside

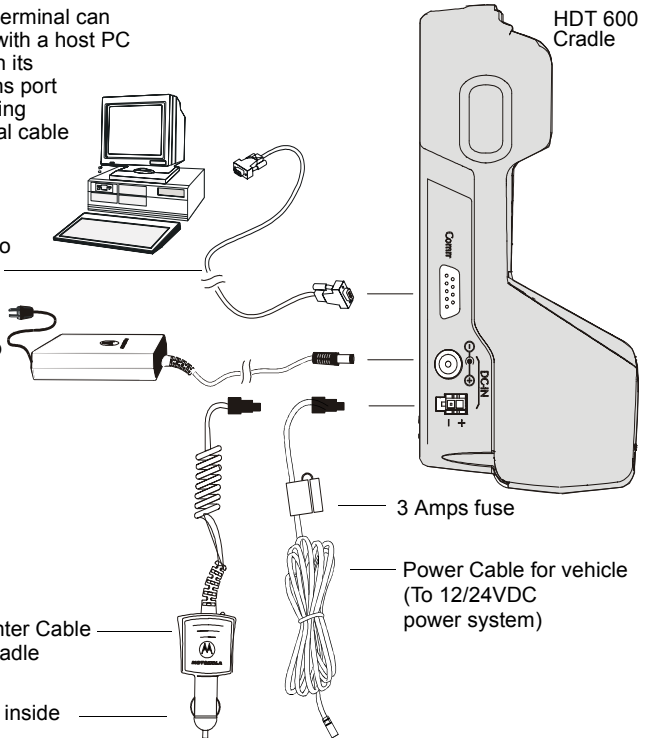

## Installing the Battery

The battery is shipped from the factory uncharged and not installed. Charge the battery before using the HDT 600 for the first time.

1. Before installing the battery, release the terminal hand strap, as shown below.
2. Verify that the battery lock is in Unlock position.
3. To install the battery, position the battery in the right-hand side of the battery compartment and lower it downward to its place.
4. Use a coin to lock the battery by turning the battery lock clockwise to the Lock position. Note that the battery is locked only when the two dots align (see figure below).

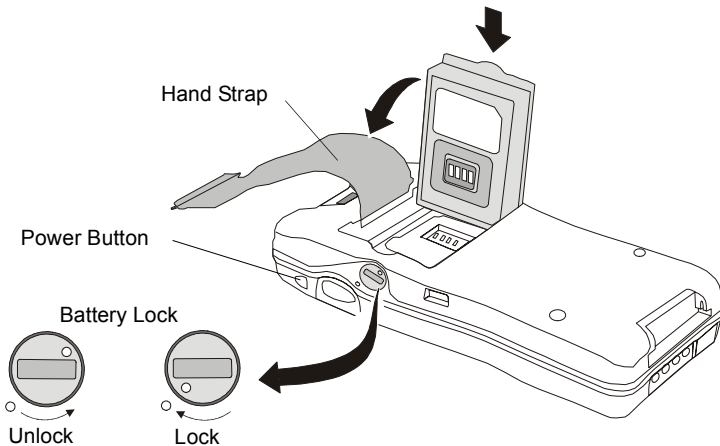

## Removing the Battery

**Important Note:** The HDT 600 enables you to replace batteries without losing information stored in its memory. To avoid losing information stored in the memory, charged battery must be installed within 2 minutes after removing empty battery.



1. Turn the HDT 600 off by holding the Power button pressed for at least two seconds.
2. Release the terminal hand strap as shown in the figure above.
3. Use a coin to unlock the battery by turning the battery lock counter-clockwise.
4. To remove the battery, lift the left-hand side of the battery and pull it out.

## **First Time Battery Charge**

The battery is charged when installed inside the HDT 600. Charge your new battery for at least six continuous hours before using it or until the LED indicator of the HDT 600 turns from red to green.

The first time charge is referred to as initializing and will ensure maximum battery start capacity. The HDT 600 Cradle charges your battery effectively when it is at room temperature (approx. 20° C). Battery charging temperature range is 0°C to 45°C.

## Charging the Battery

The battery remaining capacity indication may show by the LED indicator of your HDT 600 (see figure below). Note that the HDT 600 can either be in On, Off or Suspend mode, while charging.

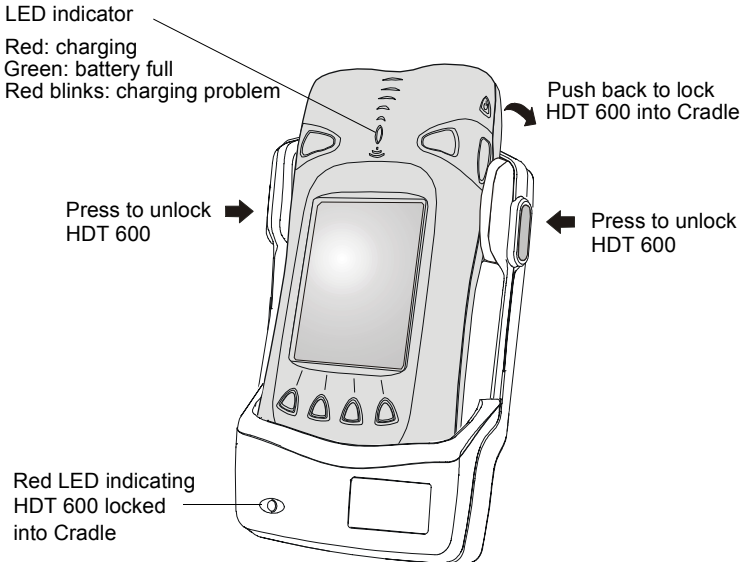

To avoid damage and provide optimal performance of the HDT 600 and Cradle, use only the Power Supply provided by your company.

To charge the battery, perform the following steps:

1. Connect the power cable to the socket at the base of the Cradle.
2. Slide the HDT 600 into the Cradle and lock the HDT 600 inside by pushing it towards the back of the Cradle.



When installed in a vehicle, the HDT 600 must be locked into the Cradle. If not locked, the HDT 600 may be propelled with great force and may cause serious injury to occupants of the vehicle.

**Important Note:** The HDT 600 will not charge if not locked into the Cradle.

Once the HDT 600 is locked, the Cradle red LED will turn on, indicating lock status.

3. To remove the HDT 600 from the Cradle, press one or two unlock buttons until the HDT 600 pops out a bit, and remove the HDT 600 from the Cradle.

## **Battery Maintenance**

The performance of the rechargeable battery delivered with your HDT 600 depends on the way the battery is treated. Therefore, to comply with the Motorola warranty for batteries and to assure high performance and a long life for your Motorola rechargeable battery, please read and follow the maintenance rules stated below.

### ***Battery Storage***

Do not store your battery where the temperatures will exceed 65°C or fall below -20°C.

New Lithium-Ion batteries (i.e. batteries that have never been charged before) may be stored for up to 3 months in well-ventilated, cool and dry areas without significant loss in lifespan.

Batteries which have already been charged and then stored for more than 2 months should be recharged before use.

### ***Extending Battery Life***

A battery is an expendable part and may need replacing during the life of the HDT 600. To ensure maximum service life of your HDT

600, always replace the battery with a genuine Motorola replacement.

Your Cradle will charge your battery effectively when it is at room temperature (approx. 20° C). Battery charging temperature range is 0°C to 45°C.

## **Turning on the HDT 600**

Press the Power button to start the HDT 600. The HDT 600 also powers on immediately when the battery is inserted.

As the HDT 600 initializes its unique flash file system, the Motorola logo displays for about one minute. Note that this screen also appears every time you perform a restart.

## **Suspend Mode**

The Suspend mode is used for saving the HDT 600 battery power by turning off the display and computer sections of the HDT 600, while keeping the radio(s) powered on.

When the HDT 600 is on, press the Power button to toggle between Suspend and Resume modes. During the Suspend mode, the display turns off and the LED indicator blinks.

When the HDT 600 resumes, it returns to the screen displayed prior to the Suspend mode.

Use the Suspend mode as often as possible to save battery power.

## **Turning off the HDT 600**

When the HDT 600 is on or in Suspend mode, hold the Power button pressed for at least two seconds, to turn off the HDT 600.

## Using the HDT 600

When using the HDT 600, the hand strap on the back of the unit provides stability. Insert your left or right hand under the strap while holding the stylus pen in the other hand.

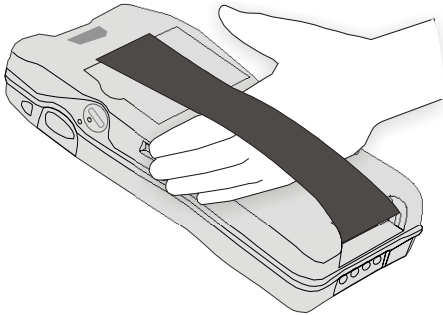

## Using the Stylus Pen

The Stylus pen selects items and enters information. Use the pen as you use your PC mouse.

- To open and select screen items, tap on the item twice with the pen.
- To drag text or image items, hold the pen on the item and drag across the screen.
- To see a list of actions available for specific item, tap-and-hold the pen on an item. When the pop-up menu appears, tap the action you want to perform.

## Scanning With the HDT 600

The HDT 600 is equipped with four scan trigger buttons, designed for left-handed and right-handed users. The buttons are located on the left-hand and right-hand sides of the terminal and on the left-hand and right-hand sides of the upper front panel.

The HDT 600 has an integrated scanner which gathers data by scanning barcodes. To scan barcodes with the HDT 600, aim the scanner at the barcode.

Press one of the four scan trigger buttons. Ensure the red scan beam covers the entire barcode. The green scan LED lights and a beep sounds to indicate a successful decode.

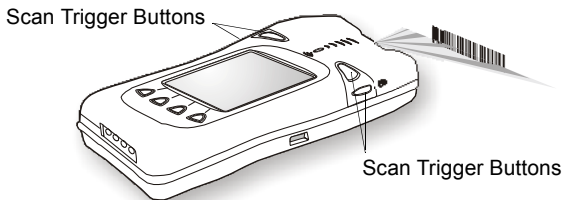
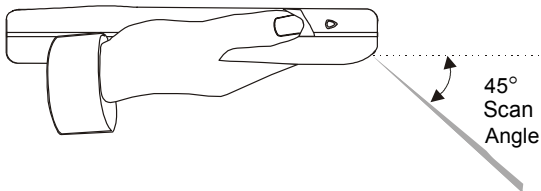
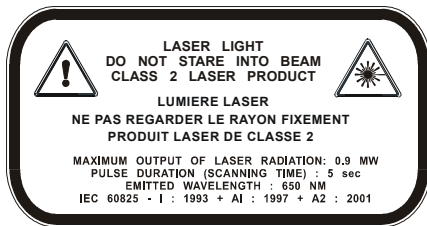

## Resetting the HDT 600

You may need to reset your HDT 600; for example, you may reset due to communication cut-off with your desktop PC or radio network, or when the operating system stops responding.

When your HDT 600 stops responding, do the following actions:

### Warm Boot

**Important Note:** When HDT 600 is warm booted, all information remains stored in memory.

1. Simultaneously press soft keys 1, 2 and the Power button for at least 5 seconds; the HDT 600 will function again.

*If your HDT 600 still does not respond perform:*

### Cold Reset

**Important Note:** When HDT 600 is cold reset, all information stored in its memory will be lost.

2. Simultaneously press soft keys 2, 3 and 4 to restart your HDT 600. The operation system will reboot for about a minute.

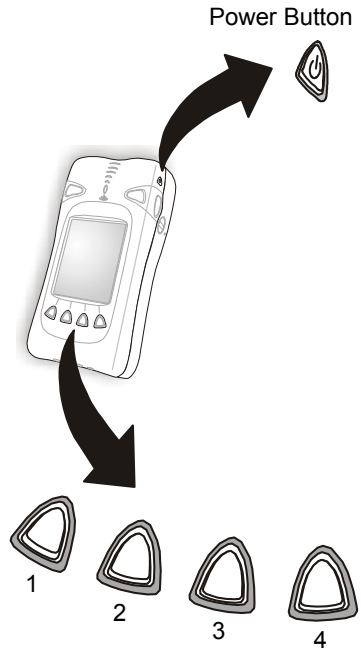

## **Cradle Installation**

The Cradle can be installed by using the four threaded holes on its back side (See figure in page 14). Use the holes to attach the Cradle to any surface, such as: vehicle dashboard, office wall or table.

Planning is the key to fast, easy HDT 600 Cradle installation. Before a hole is drilled or a wire is run, inspect the vehicle and determine how and where you intend to mount the Cradle and accessories. Plan wire and cable runs to provide maximum protection from pinching, crushing, and overheating.

The installation planning should only be undertaken by persons who are competent and able to ensure that the complete installation fulfills its regulatory requirements, such as EMC (ElectroMagnetic Compatibility).

Please note that it is the responsibility of the installing party to ensure that the inclusion of mount accessories and connections to the battery system is according to local standards and is not in violation of applicable safety specifications.

When routing the power cable to the Cradle, it is important to use as much cable as needed and cut off the remainder. Using the exact cable length ensures proper power supply to the Cradle. Make sure that the power cable has a 3 Amps fuse (See “HDT 600 Cradle Connections” on page 5).

The power cable must originate after the vehicle current protection system. In order to prevent continuous consumption from the vehicle's battery, route the power cable after the ignition switch. Note that the input voltage to the Cradle may range from 10.6 to 32 VDC (Max peak current: 2 Amps). The Cradle output voltage is 12 VDC (Max continuous current: 1 Amp at -30 to +50°C, 0.5 Amp at 50 to 60°C).

Classification level 5 for power supplies having output circuit that meet the requirements for SELV circuit.



For continued protection against risk of fire, replace only with same type and rating of fuse.

Back side of HDT 600 Cradle

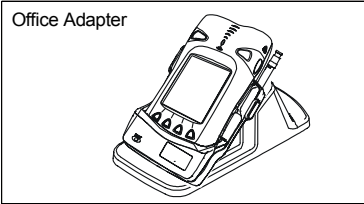
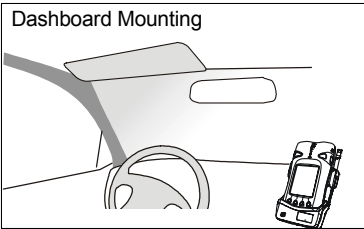
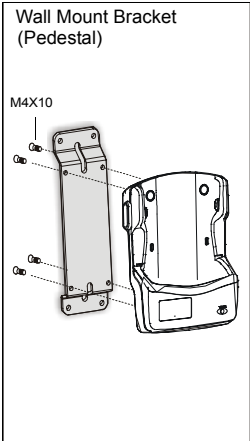
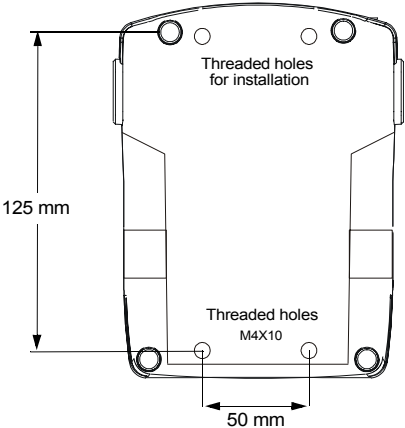

## **Maintaining the HDT 600**

In order to maintain your HDT 600 in good working order:

- Do not scratch the screen. Use only Motorola supplied stylus pen with the touch-sensitive screen.
- Never use a pen or pencil or any sharp object on the screen.
- Although your HDT 600 is water and dust resistant, do not expose it to rain or moisture for long periods of time.
- Protect your HDT 600 from temperature extremes. Do not leave the HDT 600 on the dashboard of a car on a hot day, and keep the HDT 600 away from hot places.
- The touch-sensitive screen of your HDT 600 contains glass. Do not drop your HDT 600 or subject it to strong impact.
- Treat your HDT 600 as you would a cellular phone or other small and sensitive electronic devices.
- Do not store or use your HDT 600 in any location that is extremely dusty, damp or wet.
- If the battery contacts, screen or surface of the HDT 600 becomes dirty, use a soft lint free cloth, moistened with diluted Isopropyl Alcohol (IPA) solution, for removing dirt. The IPA can be diluted with water up to 20%.

## Accessories

Motorola recommends the use of the following accessories with your terminal. Please refer to your company for more information.

Motorola is not responsible for the use of accessories not approved for this product.

The following Motorola approved accessories are for use with your terminal. For information on the availability of these accessories, please call your company supplier.

Table 1: Accessories

<b>Motorola Approved Accessory</b>	<b>Part Number</b>
HDT 600	F4415A
Spare Battery	FNN5105A
Spare Stylus	FLN9805A
Cigarette Lighter Cable for Vehicle Cradle	FKN6009A
Power Cable for Vehicle	FKN8044A
Wall Mounting Kit	FLN9782A
HDT 600 Cradle	F4416A
Desktop Adapter 110V	VA00054AA
Desktop Adapter 220V	VA00055AA
Belt Holster, Leather, HDT 600	FHN6394A
Carrying Case, Leather, HDT 600 (shoulder strap, D-Ring belt loop)	FHN6395A
Carrying Case, Leather, HDT 600 (shoulder strap, fixed belt loop)	FHN6396A

## What to Do If

Table 2: Troubleshooting

<b>Problem</b>	<b>Cause</b>	<b>Solution</b>
HDT 600 does not turn on.	Battery not charged.	Ensure proper battery installation in HDT 600. Charge or replace the battery.
	HDT 600 in Suspend mode.	Press the Power Button.
HDT 600 red LED does not stop blink or battery refuse to charge.	HDT 600 is not locked in Cradle.	Reinstall HDT 600 in Cradle. Lock the HDT 600 properly in Cradle (See that the HDT 600 and Cradle red LEDs are on) and charge for 6 hours.
	Battery temperature is incorrect	Ensure that the battery temperature range is -0 to 45° C
	Bad battery.	Replace battery.
HDT 600 does not detect scan input.	LASER beam does not cover the entire barcode symbol.	Scan again and make sure that the entire barcode symbol is covered.
	Unreadable barcode.	Be sure the barcode symbol is not covered.

Table 2: Troubleshooting

Problem	Cause	Solution
HDT 600 stopped responding.	Problem in HDT 600 operating system or communication network.	<p>Simultaneously press soft keys 1, 2 and the Power button for at least 5 seconds; the HDT 600 should function again.</p> <p>If still does not respond, simultaneously press soft keys 2, 3 and 4 to restart your HDT 600. The operation system will reboot for about a minute.</p>
Incomplete or no data transmission between HDT 600 and PC.	HDT 600 is not locked in Cradle.	Lock the HDT 600 properly in Cradle (See that the red LED is on).
	Cradle contacts are not clean.	Clean contacts and remove dust and objects from within the Cradle.
	Bad RS232 cable.	Replace the RS232 cable.
	Communication software was incorrectly installed or configured.	See your System Administrator.

## **Battery Warnings and Disposal**

### ***HDT 600 On Board Aircraft***

Always remove the battery from the HDT 600 when shipped via air. Any use of the HDT 600 must be in accordance with applicable regulations per airline crew instructions.

### ***Battery Disposal***

Batteries must be recycled or disposed of properly in accordance with local requirements. Recycling facilities may not exist in all areas. Please contact your local environmental agency for more information regarding proper disposal.

### ***To Prevent Injury Or Burns***

- USE ONLY SPECIFIED BATTERIES AND CHARGERS.
- DO NOT DISPOSE OF ANY BATTERIES IN FIRE, AS THEY MAY EXPLODE!
- DO NOT PUNCTURE OR ALLOW METAL TO CONTACT THE BATTERY TERMINALS.
- DO NOT DISPOSE OF IN WATER.
- DO NOT DISASSEMBLE.
- DO NOT STORE ABOVE 60C/140F

***HOW TO REACH US:  
Commercial, Government and  
Industrial Solutions Sector***

1301 E. Algonquin Road,  
Schaumburg, IL 60196

Visit our Web site at  
**[www.motorola.com](http://www.motorola.com)**



**MOTOROLA**  
*intelligence everywhere™*

MOTOROLA and the Stylized M Logo are registered in the U.S. Patent and Trademark Office. All other product or service names are the property of their respective owners.

© Motorola, Inc. 2003.

