



PROFESSIONAL DIGITAL TWO-WAY RADIO

MOTOTRBO™ SL Series PORTABLES USER GUIDE

Contents

Declaration of Conformity..... 14

Important Safety Information..... 16

Software Version.....17

Computer Software Copyrights.... 18

Handling Precautions..... 19

**RF Energy Exposure and
Product Safety Guidelines
and Instructions..... 20**

Getting Started.....21

How to Use This Guide.....21

What Your Dealer/System Administrator
Can Tell You.....21

Preparing Your Radio for Use.....22

Charging the Battery.....22

Attaching the Battery..... 23

Attaching the Earpiece/Audio Accessory.....23

Powering Up the Radio.....24

Adjusting the Volume.....24

Identifying Radio Controls..... 25

Radio Controls.....25

Using the 4-Way Navigation Disc..... 26

Using the Keypad..... 27

Non-Connect Plus Operations.....29

Additional Radio Controls in Non-Connect Plus

| | |
|--|-----------|
| Mode..... | 30 |
| Push-To-Talk (PTT) Button..... | 30 |
| Programmable Buttons..... | 30 |
| Assignable Radio Functions..... | 31 |
| Assignable Settings or Utility Functions..... | 34 |
| Accessing the Programmed Functions..... | 34 |
| Identifying Status Indicators..... | 35 |
| Display Icons..... | 35 |
| Call Icons..... | 39 |
| Utilities Icons..... | 39 |
| Mini Notice Icons..... | 40 |
| Sent Item Icons | 40 |
| Job Tickets Icons..... | 41 |
| LED Indicator..... | 41 |
| Alert Tones..... | 42 |
| Indicator Tones..... | 43 |
| IP Site Connect | 43 |
| Capacity Plus | 44 |
| Linked Capacity Plus | 44 |

Making and Receiving Calls in Non-Connect Plus

| | |
|---|-----------|
| Mode..... | 46 |
| Selecting a Zone..... | 46 |
| Selecting a Channel..... | 47 |
| Receiving and Responding to a Radio Call..... | 47 |
| Receiving and Responding to a Group Call..... | 48 |
| Receiving and Responding to a Private Call | 49 |
| Receiving an All Call | 49 |
| Receiving and Responding to a Phone Call | 50 |
| Making a Radio Call..... | 51 |
| Making a Group Call..... | 52 |
| Making a Private Call  | 53 |
| Making an All Call | 54 |
| Making a Phone Call with the One Touch Access Button..... | 54 |
| Making a Private Call with a One Touch Call Button..... | 56 |

| | | | |
|--|----|--|----|
| Making a Group, Private or All Call with the Programmable Number Key | 57 | Viewing an Entry in the Scan List by Alias Search... 69 | 69 |
| Making a Phone Call with the Programmable Phone Button | 58 | Editing the Scan List..... | 69 |
| Making a Call with the Programmable Manual Dial Button  | 60 | Scan..... | 73 |
| Stopping a Radio Call | 62 | Setting an Active Scan List..... | 73 |
| Talkaround..... | 63 | Starting and Stopping Scan..... | 74 |
| Monitoring Features..... | 63 | Responding to a Transmission During a Scan..... | 74 |
| Monitoring a Channel..... | 63 | Deleting a Nuisance Channel...75 | 75 |
| Permanent Monitor..... | 64 | Restoring a Nuisance Channel..... | 75 |
| | | Contact Settings..... | 75 |
| | | Making a Group Call from Contacts..... | 76 |
| | | Making a Private Call from Contacts | 77 |
| | | Making a Phone Call from Contacts..... | 78 |
| | | Making a Call Alias Search | 80 |
| | | Making a Group, Private, Phone or All Call by Alias Search | 82 |
| | | Assigning an Entry to a Programmable Number Key | 83 |

Advanced Features in Non- Connect Plus Mode..... 65

| | |
|---|----|
| Radio Check..... | 65 |
| Sending a Radio Check..... | 65 |
| Remote Monitor..... | 66 |
| Initiating Remote Monitor..... | 66 |
| Scan Lists..... | 68 |
| Viewing an Entry in the Scan List..... | 68 |

| | | | |
|---|----|---|----|
| Removing the Association between Entry and Programmable Number Key | 84 | Viewing Recent Calls..... | 91 |
| Adding a New Contact..... | 85 | Missed Call Screen..... | 91 |
| Sending a Message to a Contact..... | 85 | Storing an Alias from a Call List..... | 92 |
| Call Indicator Settings..... | 86 | Deleting a Call from a Call List..... | 92 |
| Activating and Deactivating Call Ringers for Call Alert ... | 86 | Viewing Details from a Call List..... | 93 |
| Activating and Deactivating Call Ringers for Private Calls | 86 | Call Alert Operation..... | 93 |
| Activating and Deactivating Call Ringers for Text Message..... | 87 | Receiving and Responding to a Call Alert..... | 93 |
| Activating and Deactivating Call Ringers for Telemetry Status with Text..... | 88 | Making a Call Alert from the Contact List..... | 93 |
| Assigning Ring Styles..... | 88 | Making a Call Alert with the One Touch Access Button..... | 94 |
| All Tones..... | 89 | Emergency Operation..... | 95 |
| Selecting a Ring Alert Type..... | 89 | Receiving an Emergency Alarm..... | 96 |
| Configuring Vibrate Style..... | 90 | Responding to an Emergency Alarm..... | 96 |
| Escalating Alarm Tone Volume..... | 91 | Exiting Emergency Mode After Receiving the Emergency Alarm..... | 97 |
| Call Log Features..... | 91 | Sending an Emergency Alarm..... | 97 |

| | | | |
|--|-----|--|-----|
| Sending an Emergency Alarm with Call..... | 97 | Managing Received Text Messages..... | 113 |
| Sending an Emergency Alarm with Voice to Follow | 98 | Job Tickets..... | 117 |
| Reinitiating an Emergency Mode..... | 100 | Accessing the Job Ticket Folder..... | 117 |
| Exiting Emergency Mode After Sending the Emergency Alarm..... | 100 | Logging In and Out of the Remote Server..... | 118 |
| Man Down..... | 100 | Creating and Sending a Job Ticket..... | 118 |
| Turning the Man Down Feature On or Off..... | 101 | Responding to the Job Ticket..... | 119 |
| Text Message Features | 102 | Deleting a Job Ticket..... | 120 |
| Writing and Sending a Text Message..... | 102 | Privacy | 121 |
| Sending a Quick Text Message..... | 103 | Covert Mode..... | 122 |
| Sending a Quick Text Message with the One Touch Access Button..... | 105 | Entering Covert Mode..... | 122 |
| Accessing the Drafts Folder... .. | 105 | Exiting Covert Mode..... | 122 |
| Managing Fail-to-Send Text Messages..... | 107 | Dual Tone Multi Frequency (DTMF)..... | 123 |
| Managing Sent Text Messages..... | 109 | Multi-Site Controls | 123 |
| Receiving a Text Message..... | 113 | Starting an Automatic Site Search..... | 123 |
| | | Stopping an Automatic Site Search..... | 124 |
| | | Starting a Manual Site Search..... | 125 |
| | | Security..... | 126 |
| | | Radio Disable..... | 126 |
| | | Radio Enable..... | 127 |
| | | Lone Worker..... | 129 |

| | | | |
|-----------------------------|-----|-----------------------------------|-----|
| Password Lock Features..... | 129 | Bluetooth Mic Gain..... | 137 |
| Accessing the Radio from | | Permanent Bluetooth | |
| Password..... | 129 | Discoverable Mode..... | 138 |
| Unlocking the Radio from | | Notification List..... | 138 |
| Locked State..... | 130 | Accessing the Notification | |
| Turning the Password Lock | | List..... | 138 |
| On or Off..... | 130 | Over-the-Air-Programming (OTAP).. | 138 |
| Changing the Password..... | 131 | Wi-Fi Operation..... | 139 |
| Bluetooth Operation..... | 132 | Turning Wi-Fi On or Off..... | 139 |
| Turning Bluetooth On and | | Connecting to a Network | |
| Off..... | 133 | Access Point..... | 140 |
| Finding and Connecting to a | | Refreshing the Network List... | 141 |
| Bluetooth Device..... | 133 | Adding a Network..... | 141 |
| Finding and Connecting | | Viewing Details of Network | |
| from a Bluetooth Device | | Access Points..... | 142 |
| (Discoverable Mode)..... | 134 | Removing Network Access | |
| Connecting to a Paired | | Points..... | 143 |
| Bluetooth Device..... | 135 | Utilities..... | 143 |
| Disconnecting from a | | Locking and Unlocking the | |
| Bluetooth Device..... | 135 | Keypad..... | 143 |
| Switching Audio Route | | Turning Keypad Tones On | |
| between Internal Radio | | or Off..... | 144 |
| Speaker and Bluetooth | | Setting the Power Level..... | 144 |
| Device..... | 136 | Turning the Option Board | |
| Viewing Device Details..... | 136 | Feature(s) On or Off..... | 145 |
| Editing Device Name..... | 136 | Identifying Cable Type..... | 145 |
| Deleting Device Name..... | 137 | | |

| | | | |
|---|-----|--|------------|
| Turning the Voice Operating Transmission (VOX) Feature On or Off..... | 146 | Setting the Text-to-Speech Feature..... | 155 |
| Setting the Display Backlight Timer..... | 147 | Digital Mic AGC (Mic AGC- D)..... | 156 |
| Turning the Backlight Auto On or Off..... | 147 | Switching Audio Route between Internal Radio Speaker and Wired Accessory..... | 157 |
| Turning the Radio Tones/ Alerts On or Off..... | 148 | Intelligent Audio..... | 157 |
| Setting the Tone Alert Volume Offset Level..... | 148 | Turning the Acoustic Feedback Suppressor Feature On or Off | 158 |
| Turning the Talk Permit Tone On or Off..... | 149 | Setting the Audio Ambience... | 159 |
| Setting the Text Message Alert Tone..... | 149 | Setting the Audio Profiles..... | 160 |
| Changing the Display Mode... | 150 | Text Entry Configuration..... | 161 |
| Adjusting the Display Brightness..... | 151 | Flexible Receive List..... | 166 |
| Wallpaper Mode..... | 152 | Accessing General Radio Information..... | 169 |
| Screen Saver Mode..... | 152 | Checking the RSSI Values..... | 172 |
| Audio Accessory..... | 153 | | |
| Auto Keypad Lock..... | 153 | Connect Plus Operations..... | 173 |
| Language..... | 153 | | |
| Turning the LED Indicator On or Off..... | 154 | Additional Radio Controls in Connect Plus Mode..... | 174 |
| Turning the Voice Announcement On or Off.. | 154 | | |

| | |
|---|-----|
| Push-To-Talk (PTT) Button..... | 174 |
| Programmable Buttons..... | 174 |
| Assignable Radio Functions... | 175 |
| Assignable Settings or Utility Functions..... | 176 |
| Identifying Status Indicators in | |
| Connect Plus Mode..... | 176 |
| Display Icons..... | 176 |
| Call Icons..... | 179 |
| Sent Item Icons | 180 |
| LED Indicator..... | 180 |
| Indicator Tones..... | 181 |
| Alert Tones..... | 181 |
| Switching Between Connect Plus and Non-Connect Plus Modes..... | 182 |

Making and Receiving Calls in Connect Plus Mode..... 183

| | |
|------------------------------|-----|
| Selecting a Site..... | 183 |
| Roam Request..... | 183 |
| Site Lock On/Off..... | 183 |
| Site Restriction..... | 183 |
| Selecting a Zone..... | 184 |
| Using Multiple Networks..... | 184 |
| Selecting a Call Type..... | 185 |

| | |
|--|-----|
| Receiving and Responding to a Radio Call..... | 185 |
| Receiving and Responding to a Group Call..... | 186 |
| Receiving and Responding to a Private Call..... | 186 |
| Receiving a Site All Call..... | 187 |
| Receiving an Inbound Private Phone Call..... | 187 |
| Receiving an Inbound Phone Talkgroup Call..... | 188 |
| Inbound Phone Multi-Group Call..... | 189 |
| Making a Radio Call..... | 189 |
| Making a Call | 189 |
| Making a Private Call with a One Touch Call Button..... | 192 |
| Making a Call with the Programmable Manual Dial Button..... | 192 |
| Making an Outbound Private Phone Call with the Programmable Manual Dial Button..... | 193 |
| Making an Outbound Private Phone Call via the Phone Menu..... | 194 |

| | | | |
|--|------------|---|-----|
| Making an Outbound Private Phone Call from Contacts..... | 194 | Initiating Remote Monitor..... | 200 |
| Waiting for the Channel Grant in an Outbound Private Phone Call..... | 195 | Scan..... | 201 |
| Making a Buffered Over-Dial in a Connected Outbound Private Phone Call..... | 196 | Starting and Stopping Scan... .. | 201 |
| Making a Live Over-Dial in a Connected Outbound Private Phone Call..... | 196 | Responding to a Transmission During a Scan..... | 201 |
| | | User Configurable Scan..... | 202 |
| | | Turning Scan On or Off..... | 202 |
| | | Editing the Scan List..... | 203 |
| | | Add or Delete a Group via the Add Members Menu..... | 204 |
| | | Understanding Scan Operation..... | 206 |
| | | Scan Talkback..... | 207 |
| | | Contacts Settings..... | 207 |
| | | Making a Private Call from Contacts..... | 208 |
| | | Making a Call Alias Search.... | 209 |
| | | Adding a New Contact..... | 209 |
| | | Call Indicator Settings..... | 210 |
| | | Activating and Deactivating Call Ringers for Call Alert .. | 210 |
| | | Activating and Deactivating Call Ringers for Private Calls..... | 210 |
| | | Activating and Deactivating Call Ringers for Text Message..... | 211 |
| Advanced Features in Connect Plus Mode..... | 197 | | |
| Auto Fallback..... | 197 | | |
| Indications of Auto Fallback Mode..... | 197 | | |
| Making/Receiving Calls in Fallback Mode..... | 197 | | |
| Returning to Normal Operation..... | 198 | | |
| Radio Check..... | 198 | | |
| Sending a Radio Check..... | 198 | | |
| Remote Monitor..... | 199 | | |

| | | | |
|----------------------------------|-----|---------------------------------|-----|
| Selecting a Ring Alert Type..... | 212 | Responding to an | |
| Configuring Vibrate Style..... | 213 | Emergency Alert..... | 220 |
| Escalating Alarm Tone | | Initiating an Emergency Call.. | 220 |
| Volume..... | 213 | Initiating an Emergency Call | |
| Call Log Features..... | 213 | with Voice to Follow..... | 221 |
| Viewing Recent Calls..... | 213 | Initiating an Emergency Alert.. | 221 |
| Deleting a Call from a Call | | Exiting Emergency Mode..... | 222 |
| List..... | 214 | Text Message Features..... | 222 |
| Viewing Details from a Call | | Writing and Sending a Text | |
| List..... | 214 | Message..... | 223 |
| Call Alert Operation..... | 215 | Sending a Quick Text | |
| Receiving and Responding | | Message..... | 224 |
| to a Call Alert..... | 215 | Sending a Quick Text | |
| Making a Call Alert from the | | Message with the One | |
| Contact List..... | 215 | Touch Access Button..... | 226 |
| Making a Call Alert with the | | Accessing the Drafts Folder... | 226 |
| One Touch Access | | Managing Fail-to-Send Text | |
| Button..... | 216 | Messages..... | 228 |
| Emergency Operation..... | 216 | Managing Sent Text | |
| Receiving an Incoming | | Messages..... | 230 |
| Emergency..... | 218 | Receiving a Text Message..... | 233 |
| Saving the Emergency | | Reading a Text Message..... | 233 |
| Details to the Alarm List.... | 219 | Managing Received Text | |
| Deleting the Emergency | | Messages..... | 234 |
| Details..... | 219 | Privacy..... | 237 |
| Responding to an | | Making a Privacy-Enabled | |
| Emergency Call..... | 219 | (Scrambled) Call..... | 238 |

| | | | |
|-----------------------------|-----|--------------------------------|-----|
| Covert Mode..... | 238 | Speaker and Bluetooth | |
| Entering Covert Mode..... | 238 | Device..... | 247 |
| Exiting Covert Mode..... | 238 | Viewing Device Details..... | 247 |
| Security..... | 239 | Editing Device Name..... | 248 |
| Radio Disable..... | 239 | Deleting Device Name..... | 248 |
| Radio Enable..... | 240 | Bluetooth Mic Gain..... | 249 |
| Password Lock Features..... | 242 | Permanent Bluetooth | |
| Accessing the Radio from | | Discoverable Mode..... | 249 |
| Password..... | 242 | Notification List..... | 249 |
| Turning the Password Lock | | Accessing the Notification | |
| On or Off..... | 242 | List..... | 250 |
| Unlocking the Radio from | | Wi-Fi Operation..... | 250 |
| Locked State..... | 243 | Turning Wi-Fi On or Off..... | 250 |
| Changing the Password..... | 243 | Connecting to a Network | |
| Bluetooth Operation..... | 244 | Access Point..... | 251 |
| Turning Bluetooth On and | | Refreshing the Network List... | 252 |
| Off..... | 245 | Adding a Network..... | 252 |
| Finding and Connecting to a | | Viewing Details of Network | |
| Bluetooth Device..... | 245 | Access Points..... | 253 |
| Finding and Connecting | | Removing Network Access | |
| from a Bluetooth Device | | Points..... | 253 |
| (Discoverable Mode)..... | 246 | Utilities..... | 254 |
| Disconnecting from a | | Turning the Radio Tones/ | |
| Bluetooth Device..... | 247 | Alerts On or Off..... | 254 |
| Switching Audio Route | | Turning Keypad Tones On | |
| between Internal Radio | | or Off..... | 255 |

| | |
|-------------------------------|-----|
| Setting the Tone Alert | |
| Volume Offset Level..... | 255 |
| Turning the Talk Permit | |
| Tone On or Off..... | 256 |
| Setting the Power Level..... | 256 |
| Changing the Display Mode... | 257 |
| Adjusting the Display | |
| Brightness..... | 258 |
| Setting the Display Backlight | |
| Timer..... | 258 |
| Locking and Unlocking the | |
| Keypad..... | 259 |
| Language..... | 259 |
| Turning the LED Indicator | |
| On or Off..... | 260 |
| Identifying Cable Type..... | 260 |
| Voice Announcement..... | 261 |
| Wallpaper Mode..... | 261 |
| Screen Saver Mode..... | 262 |
| Audio Accessory..... | 262 |
| Auto Keypad Lock..... | 262 |
| Digital Mic AGC (Mic AGC- | |
| D)..... | 263 |
| Intelligent Audio..... | 263 |
| Turning the Acoustic | |
| Feedback Suppressor | |
| Feature On or Off..... | 265 |

| | |
|-------------------------------|-----|
| Text Entry Configuration..... | 265 |
| Accessing General Radio | |
| Information..... | 271 |

Accessories.....280

Authorized Accessories

List..... 281

| | |
|--------------------------------|-----|
| Antennas..... | 281 |
| Audio Accessories..... | 281 |
| Batteries..... | 281 |
| Bluetooth..... | 281 |
| Cables..... | 282 |
| Carry Devices..... | 282 |
| Chargers..... | 282 |
| Miscellaneous Accessories..... | 282 |

Batteries and Chargers Warranty..... 283

| | |
|-------------------------------|-----|
| The Workmanship Warranty..... | 283 |
| The Capacity Warranty..... | 283 |

Limited Warranty.....284

| | |
|------------------------------|-----|
| MOTOROLA COMMUNICATION | |
| PRODUCTS..... | 284 |
| I. WHAT THIS WARRANTY COVERS | |
| AND FOR HOW LONG:..... | 284 |

| | |
|---|-----|
| II. GENERAL PROVISIONS:..... | 285 |
| III. STATE LAW RIGHTS:..... | 285 |
| IV. HOW TO GET WARRANTY SERVICE:.. | 285 |
| V. WHAT THIS WARRANTY DOES NOT COVER:..... | 286 |
| VI. PATENT AND SOFTWARE PROVISIONS:..... | 286 |
| VII. GOVERNING LAW:..... | 288 |

Declaration of Conformity

This declaration is applicable to your radio only if your radio is labeled with the FCC logo shown below.

Declaration of Conformity

Per FCC CFR 47 Part 2 Section 2.1077(a)



Responsible Party

Name: Motorola Solutions, Inc.

Address: 1303 East Algonquin Road, Schaumburg, IL 60196-1078, U.S.A.

Phone Number: 1-800-927-2744

Hereby declares that the product:

Model Name: **SL7550/ SL7580/SL7590/SL7550e/ SL7580e/SL7590e**

conforms to the following regulations:

FCC Part 15, subpart B, section 15.107(a), 15.107(d) and section 15.109(a)

Class B Digital Device

As a personal computer peripheral, this device complies with Part 15 of the FCC Rules. This device complies with Industry Canada licence-exempt RSS standard(s). Operation is subject to the following two conditions:

- 1 This device may not cause harmful interference, and
- 2 This device must accept any interference received, including interference that may cause undesired operation.



Note:

This equipment has been tested and found to comply with the limits for a Class B digital device, pursuant to part 15 of the FCC Rules. These limits are designed to provide reasonable protection against harmful interference in a residential installation. This equipment generates, uses and can radiate radio frequency energy and, if not installed and used in accordance with the instructions, may cause harmful interference to radio communications. However, there is no guarantee that interference will not occur in a particular installation.

If this equipment does cause harmful interference to radio or television reception, which can be determined by turning the equipment off and on, the user is encouraged to try to correct the interference by one or more of the following measures:

- Reorient or relocate the receiving antenna.
- Increase the separation between the equipment and receiver.
- Connect the equipment into an outlet on a circuit different from that to which the receiver is connected.
- Consult the dealer or an experienced radio or TV technician for help.

Appareil numérique de Classe B

En tant que périphérique d'ordinateur personnel, cet appareil est conforme aux stipulations de la partie 15 des règlements de la FCC. Cet appareil est conforme aux CNR d'Industrie Canada applicables aux appareils radio exempts de licence. Son utilisation est assujettie aux deux conditions suivantes :

- 1 Cet appareil ne doit pas causer d'interférence nuisible.
- 2 Cet appareil doit accepter toute interférence reçue, y compris les interférences pouvant entraîner un fonctionnement indésirable.



Remarque

Ce matériel a fait l'objet de tests et a été déclaré conforme aux limites établies pour un appareil numérique de classe B, comme il est stipulé à la section 15 des règlements de la FCC. Ces limites sont fixées afin d'offrir une protection suffisante contre des interférences nuisibles dans une installation résidentielle. Ce matériel génère, utilise et peut émettre de l'énergie radiofréquence et, s'il n'est pas installé ni utilisé conformément aux instructions, il peut provoquer un brouillage nuisible aux communications radio. Cependant, on ne peut garantir qu'il n'y aura aucune interférence dans une installation particulière.

Si cet appareil cause une interférence nuisible de la réception de la radio ou de la télévision, ce qui peut être déterminé en éteignant et en allumant l'appareil, vous êtes encouragé à remédier à la situation en prenant une ou plusieurs des mesures suivantes :

- Réorienter ou déplacer l'antenne réceptrice.
- Augmenter la distance entre l'équipement et le récepteur.
- Brancher l'appareil dans une autre prise sur un circuit différent de celui du récepteur.
- Consulter un revendeur ou un technicien radio/télévision chevronné pour obtenir de l'aide.

Important Safety Information

RF Energy Exposure and Product Safety Guide for Portable Two-Way Radios

ATTENTION!

This radio is restricted to Occupational use only.

Before using the radio, read the RF Energy Exposure and Product Safety Guide for Portable Two-Way Radios which contains important operating instructions for safe usage and RF energy awareness and control for Compliance with applicable standards and Regulations.

For a list of Motorola-approved antennas, batteries, and other accessories, visit the following website:

<http://www.motorolasolutions.com>

Any modification to this device, not expressly authorized by Motorola, may void the user's authority to operate this device.

Under Industry Canada regulations, this radio transmitter may only operate using an antenna of a type and maximum (or lesser) gain approved for the transmitter by Industry Canada. To reduce potential radio interference to other users, the antenna type

and its gain should be so chosen that the equivalent isotropically radiated power (e.i.r.p.) is not more than that necessary for successful communication.

This radio transmitter has been approved by Industry Canada to operate with Motorola-approved antenna with the maximum permissible gain and required antenna impedance for each antenna type indicated. Antenna types not included in this list, having a gain greater than the maximum gain indicated for that type, are strictly prohibited for use with this device.

Consignes de sécurité importantes

Radios bidirectionnelles portatives : exposition aux radiofréquences et sécurité du produit

ATTENTION!

Cette radio ne doit être utilisée qu'à des fins professionnelles. Avant d'utiliser la radio, lisez le guide Radios bidirectionnelles portatives : exposition aux radiofréquences et sécurité du produit, qui contient d'importantes instructions de fonctionnement pour une utilisation sécuritaire et des informations sur l'exposition aux fréquences radioélectriques, dans le but d'assurer votre conformité aux normes et règlements en vigueur.

Visitez le site Web suivant pour obtenir la liste des antennes, des batteries et des autres accessoires approuvés par Motorola :

<http://www.motorolasolutions.com>

Toute modification effectuée à cet appareil sans l'autorisation explicite de Motorola peut annuler l'autorisation d'utiliser cet appareil.

Selon la réglementation d'Industrie Canada, cet émetteur radio ne peut être utilisé qu'avec une

antenne dont le type et le gain maximal (ou minimal) sont approuvés par Industrie Canada pour cet émetteur. Afin de limiter les interférences radio pour les autres utilisateurs, le type et le gain de l'antenne doivent être choisis de façon à ce que la puissance isotrope rayonnée équivalente (P.I.R.E.) ne soit pas plus forte qu'il ne le faut pour établir la communication.

Cet émetteur radio a été approuvé par Industrie Canada pour utilisation avec une antenne approuvée par Motorola offrant le gain maximal autorisé et l'impédance requise pour le type d'antenne indiqué. Il est strictement interdit d'utiliser avec cet appareil tout type d'antenne ne figurant pas dans cette liste et présentant un gain supérieur au maximum indiqué pour le type.

Software Version

All the features described in the following sections are supported by the software version **R02.50.00** or later.

See [Checking the Firmware Version and Codeplug Version](#) on page 170 to determine the software version of your radio.

Check with your dealer or system administrator for more details of all the features supported.

Version logicielle

Toutes les fonctions décrites dans les sections suivantes sont prises en charge par la version **R02.50.00** ou les versions ultérieures du logiciel de la radio.

Consultez la section [Checking the Firmware Version and Codeplug Version](#) pour connaître la version logicielle de votre radio.

Pour obtenir davantage de renseignements à propos des fonctions prises en charge, adressez-vous à votre détaillant ou à votre administrateur de système.

Computer Software Copyrights

The Motorola products described in this manual may include copyrighted Motorola computer programs stored in semiconductor memories or other media. Laws in the United States and other countries preserve for Motorola certain exclusive rights for copyrighted computer programs including, but not limited to, the exclusive right to copy or reproduce in any form the copyrighted computer program. Accordingly, any copyrighted Motorola computer programs contained in the Motorola products described in this manual may not be copied, reproduced, modified, reverse-engineered, or distributed in any manner without the express written permission of Motorola. Furthermore, the purchase of Motorola products shall not be deemed to grant either directly or by implication, estoppel, or otherwise, any license under the copyrights, patents or patent applications of Motorola, except for the normal non-exclusive license to use that arises by operation of law in the sale of a product.

The AMBE+2™ voice coding Technology embodied in this product is protected by intellectual property rights

including patent rights, copyrights and trade secrets of Digital Voice Systems, Inc.

This voice coding Technology is licensed solely for use within this Communications Equipment. The user of this Technology is explicitly prohibited from attempting to decompile, reverse engineer, or disassemble the Object Code, or in any other way convert the Object Code into a human-readable form.

U.S. Pat. Nos. #5,870,405, #5,826,222, #5,754,974, #5,701,390, #5,715,365, #5,649,050, #5,630,011, #5,581,656, #5,517,511, #5,491,772, #5,247,579, #5,226,084 and #5,195,166.

Handling Precautions

The MOTOTRBO Series Digital Portable radio meets IP54 specifications, allowing the radio to withstand adverse field conditions such as being exposed to water or dust.

- Keep your radio clean and exposure to water should be avoided to help ensure proper functionality and performance.
- To clean the exterior surfaces of the radio, use a diluted solution of mild dishwashing detergent and fresh water (i.e. one teaspoon of detergent to one gallon of water).
- These surfaces should be cleaned whenever a periodic visual inspection reveals the presence of smudges, grease, and/or grime.

**Caution:**

The effects of certain chemicals and their vapors can have harmful results on certain plastics. Avoid using aerosol sprays, tuner cleaners and other chemicals.

RF Energy Exposure and Product Safety Guidelines and Instructions

For more detailed proper usage instructions, warnings and cautions, refer to the RF Energy Exposure and Product Safety Guide for Portable Two-Way Radios booklet.

- To ensure a comfortable audio level and compliance with RF energy exposure limits, do not hold the radio against the ear or alongside the head.



- Use only in front of the face or with Motorola Solutions approved audio accessories and carry cases to ensure compliance with RF energy exposure limits.



Getting Started

How to Use This Guide

This User Guide covers the basic operation of the MOTOTRBO Portables.

However, your dealer or system administrator may have customized your radio for your specific needs. Check with your dealer or system administrator for more information.

For features that are available in **both** conventional Analog and Digital modes, **no** icon is shown.

Conventional Analog Mode-Only features are not available in Connect Plus mode of operation. See [Connect Plus Operations](#) on page 173 for more information.

For features that are available in a conventional multi-site mode, see [IP Site Connect](#) on page 43 for more information.

Selected features are **also** available on the single-site trunking mode, **Capacity Plus**. See [Capacity Plus](#) on page 44 for more information.

Selected features are **also** available in the multi-site trunking mode, **Linked Capacity Plus**. See [Linked Capacity Plus](#) on page 44 for more information.

What Your Dealer/System Administrator Can Tell You

You can consult your dealer or system administrator about the following:

- Is your radio programmed with any preset conventional channels?
- Which buttons have been programmed to access other features?
- What optional accessories may suit your needs?
- What are the best radio usage practices for effective communication?
- What maintenance procedures will help promote longer radio life?

Preparing Your Radio for Use

Charging the Battery

Your radio is powered by a Lithium-Ion (Li-Ion) battery. To avoid damage and to ensure compliance with warranty terms, charge the battery using a Motorola charger *exactly* as described in the charger user guide. All chargers can charge only Motorola authorized batteries. Other batteries may not charge. It is recommended your radio remains powered off while charging.

Charge a new battery 14 to 16 hours before initial use for best performance. Prior to charging a battery with the radio, it is recommended to turn the radio off. Batteries charge best at room temperature.

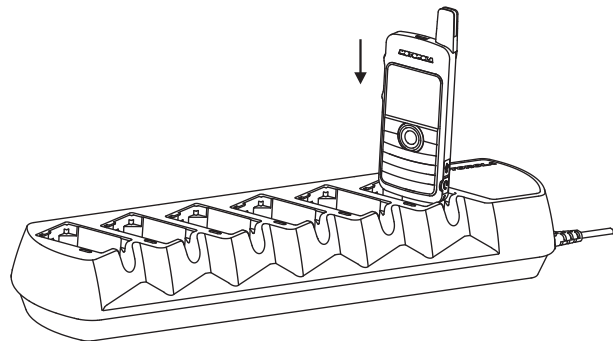
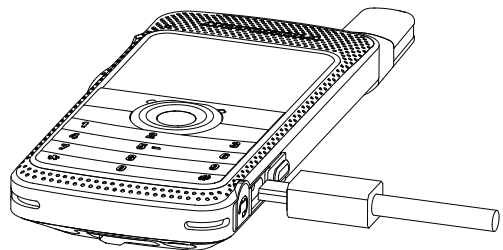

The battery charging icon will be displayed until the user unplugs the USB cable or takes the radio out of the charger.

Attaching the Battery

- 1 Align the battery contacts with the contacts inside the battery compartment. Insert the contact side of the battery first. Gently push the battery into place.

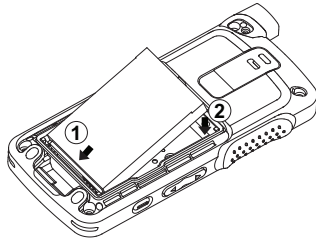

- 2 To attach battery cover, align it in place and slide the battery latch (A) until it snaps into place. Slide battery latch into lock position.

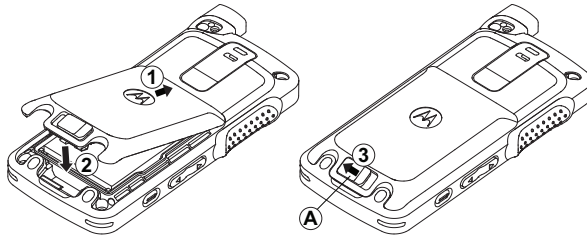

Attaching the Earpiece/Audio Accessory

The audio jack (A) is located on the antenna side of the radio. It is used to connect accessories to the radio.

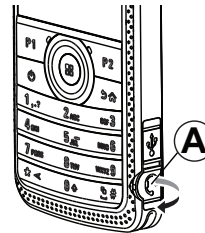

- 1 Lift the flap of the Audio Jack cover. Align the indicators (A) on both the connector and housing, then push until it fits in properly.
- 2 Rotate connector clockwise or counterclockwise to lock.
- 3 To unlock, rotate until the indicators (B) on both the connector and housing are aligned. Pull out the connector gently to disconnect from radio.

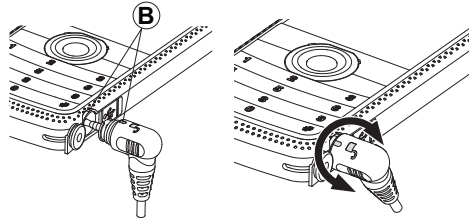

on automatically. The backlight depends on the last brightness setting.

Adjusting the Volume

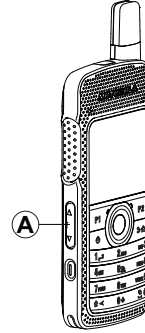

Increase the volume by pushing the **Volume Button** (A) up.

Decrease the volume by pushing the **Volume Button** down.



Note:

Your radio can be programmed to have a minimum volume offset where the volume level cannot be lowered past the programmed minimum volume. Check with your dealer or system administrator for more information.

Powering Up the Radio

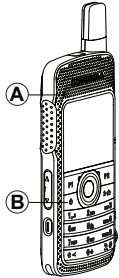

Press the **On/Off** button (B) on the front keypad. You see a welcome message or welcome image.

The LED lights up solid green (A) and the Home screen lights up if the backlight setting is set to turn

Identifying Radio Controls

Radio Controls

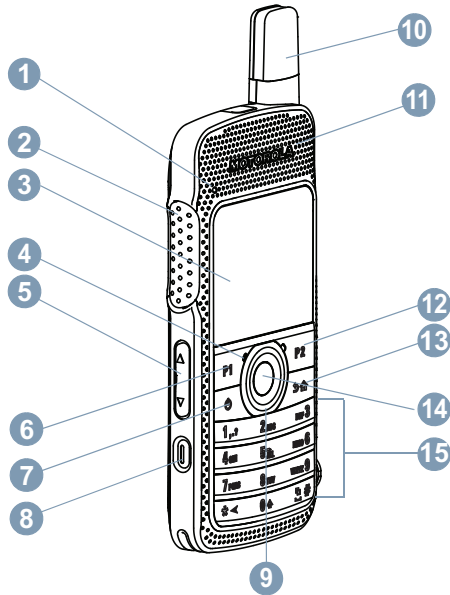

- 1 LED Indicator
- 2 Push-to-Talk (**PTT**) Button
- 3 Display
- 4 Microphone
- 5 Volume Button
- 6 Front Button P1^[1]
- 7 On/Off/Information Button
- 8 Emergency Button^[1]
- 9 4-way Navigation Disc
- 10 Antenna
- 11 Speaker
- 12 Front Button P2^[1]
- 13 Back/Home Button
- 14 Menu/OK Button
- 15 Keypad

¹ These buttons are programmable.

Using the 4-Way Navigation Disc

You can use the 4-way navigation disc,

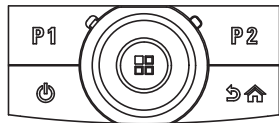

, to scroll through options, increase/decrease values, and navigate vertically.

| Category | Direction | |
|----------------|---------------------|--------------------|
| | ▲ or ▼ | ◀ or ▶ |
| Menu | Vertical Navigation | - |
| Lists | Vertical Navigation | - |
| View Details | Vertical Navigation | Previous/Next Item |
| Numeric Values | Increase/Decrease | - |

You can use the 4-way navigation disc, , as a number, alias, or free form text editor.

The ▶ button can be used to change the channels in the home screen.

Press  to select your desired channel.

| Editor Category | Direction | |
|-----------------|---------------------|---------------------------------------|
| | ▲ or ▼ | ◀ or ▶ |
| Number | - | - |
| Alias | - | Move cursor one character left/right. |
| Free Form Text | Move cursor up/down | Move cursor one character left/right. |

Using the Keypad

You can use the 3 x 4 alphanumeric keypad to access your radio's features. You can use the keypad to enter subscriber aliases or IDs, and text messages. Many characters require that you press a key multiple times. The next table shows the number of times a key needs to be pressed to generate the required character.

| Key | Number of Times Key is Pressed | | | | | | | | | | | | |
|-----|--------------------------------|---|---|---|---|---|---|---|---|----|----|----|----|
| | 1 | 2 | 3 | 4 | 5 | 6 | 7 | 8 | 9 | 10 | 11 | 12 | 13 |
| | 1 | . | , | ? | ! | @ | & | ' | % | — | : | * | # |
| | A | B | C | 2 | | | | | | | | | |
| | D | E | F | 3 | | | | | | | | | |
| | G | H | I | 4 | | | | | | | | | |
| | J | K | L | 5 | | | | | | | | | |
| | M | N | O | 6 | | | | | | | | | |
| | P | Q | R | S | 7 | | | | | | | | |
| | T | U | V | 8 | | | | | | | | | |

| Key | Number of Times Key is Pressed | | | | | | | | | | | | |
|-----|--------------------------------|---|---|---|---|---|---|---|---|----|----|----|----|
| | 1 | 2 | 3 | 4 | 5 | 6 | 7 | 8 | 9 | 10 | 11 | 12 | 13 |
| | W | X | Y | Z | 9 | | | | | | | | |
| | 0 | | Note: Press to enter "0" and long press to activate the CAPS lock. Another long press to turn off the CAPS lock. | | | | | | | | | | |
| | * or del | | Note: Press during text entry to delete the character. Press during numeric entry to enter a "*". | | | | | | | | | | |
| | # or space | | Note: Press during text entry to insert a space. Press during numeric entry to enter a "#". Long press to change text entry method. | | | | | | | | | | |

Non-Connect Plus Operations

Additional Radio Controls in Non-Connect Plus Mode

Push-To-Talk (PTT) Button

The **PTT** button on the side of the radio (A) serves two basic purposes:

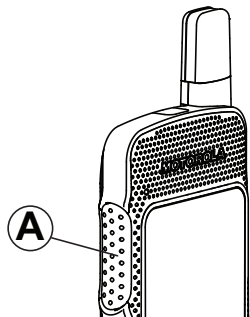

- While a call is in progress, the **PTT** button allows the radio to transmit to other radios in the call.
Press and hold the **PTT** button to talk. Release the **PTT** button to listen.
The microphone is activated when the **PTT** button is pressed.

- While a call is not in progress, the **PTT** button is used to make a new call (see [Making a Radio Call](#) on page 51).

If the Talk Permit Tone (see [Turning the Talk Permit Tone On or Off](#) on page 149) is enabled, wait until the short alert tone ends before talking.

During a call, if the Channel Free Indication feature is enabled on your radio (programmed by your dealer), you will hear a short alert tone the moment the target radio (the radio that is receiving your call) releases the **PTT** button, indicating the channel is free for you to respond.

You will also hear a continuous talk prohibit tone, if your call is interrupted, indicating that you should release the **PTT** button, for example when the radio receives an Emergency Call.

Programmable Buttons

Your dealer can program the programmable buttons as shortcuts to radio functions depending on the duration of a button press:

Short press Pressing and releasing rapidly.

Long press Pressing and holding for the programmed duration.

Press and hold Keeping the button pressed.



Note:

The programmed duration of a button press is applicable for all assignable radio/utility functions or settings. See [Emergency Operation](#) on page 95 for more information on the programmed duration of the **Emergency** button.

Assignable Radio Functions

| | |
|-----------------------|---|
| Actions | A programmable button to access a CPS programmable action list. |
| Audio Ambience | Allows the user to select an environment the radio is operating in. |
| Audio Profiles | Allows the user to select the preferred audio profile. |
| Audio Routing | Toggles audio routing between internal and external speakers. |

Audio Toggle Toggles audio routing between the internal radio speaker and the speaker of wired accessory.

Bluetooth® Audio Switch Toggles audio routing between internal radio speaker and external Bluetooth-enabled accessory.

Contacts Provides direct access to the Contacts list.

Call Alert Provides direct access to the contacts list for you to select a contact to whom a Call Alert can be sent.

Call Log Selects the call log list.

Channel Announcement Plays zone and channel announcement voice messages for the current channel.

Display Radio Alias Shows radio display name.

| | | | |
|---------------------------------------|---|--|---|
| Emergency | Depending on the programming, initiates or cancels an emergency. | Nuisance Channel Delete^[2] | Temporarily removes an unwanted channel, except for the Selected Channel, from the scan list. The Selected Channel refers to the selected zone or channel combination of the user from which scan is initiated. |
| Intelligent Audio | Toggles intelligent audio on or off. | One Touch Access | Directly initiates a predefined Private, Phone or Group Call, a Call Alert or a Quick Text message. |
| Job Tickets | Allows the user to view and act upon job tickets. | Option Board Feature | Toggles option board feature(s) on or off for option board-enabled channels. |
| Manual Dial | Depending on the programming, initiates a Private or Phone Call by keying in any subscriber ID or phone number. | Permanent Monitor^[2] | Monitors a selected channel for all radio traffic until function is disabled. |
| Manual Site Roam^[2] | Starts the manual site search. | Phone | Provides direct access to the Phone Contacts list. |
| Mic AGC On/Off | Toggles the internal microphone automatic gain control (AGC) on or off. | Power Battery Indicator | Displays the current status of the battery level. |
| Monitor | Monitors a selected channel for activity. | Privacy | Toggles privacy on or off. |
| Notifications | Provides direct access to the Notifications list. | | |

| | | | |
|---|---|--|--|
| Radio Alias and ID | Provides radio alias and ID. | | unavailable when Voice Announcement is disabled). |
| Radio Check | Determines if a radio is active in a system. | | |
| Radio Enable | Allows a target radio to be remotely enabled. | | |
| Radio Disable | Allows a target radio to be remotely disabled. | | |
| Remote Monitor | Turns on the microphone of a target radio without it giving any indicators. | | |
| Repeater/ Talkaround^[2] | Toggles between using a repeater and communicating directly with another radio. | | |
| Ring Alert Type | Provides direct access to the Ring Alert Type Setting. | | |
| Scan^[2] | Toggles scan on or off. | | |
| Site Info | Displays current Linked Capacity Plus site name and ID. Plays site announcement voice messages for the current site (this function is | | |
| | | Site Lock On/Off^[2] | When toggled on, the radio searches the current site only. When toggled off, the radio searches other sites in addition to the current site. |
| | | Telemetry Control | Controls the Output Pin on a local or remote radio. |
| | | Text Message | Selects the text message menu. |
| | | Transmit Interrupt Remote Dekey  | Stops an ongoing interruptible call to free the channel. |
| | | Trill Enhancement On/Off | Toggles trill enhancement on or off. |
| | | Unassigned | Unassigned programmable button. |
| | | Voice Announcement On/Off | Toggles voice announcement on or off. |

| | |
|---|--|
| Voice Operating Transmission (VOX) | Toggles VOX on or off. |
| Zone | Allows selection from a list of zones. |





Assignable Settings or Utility Functions

| | |
|--------------------------|---|
| All Tones/ Alerts | Toggles all tones and alerts on or off. |
| Brightness | Allows brightness to be set via the manual brightness mode or auto brightness control via the radio's photo sensor. |
| Display Mode | Toggles the day/night display mode on or off. |
| Wallpaper | Displayed on home screen. |

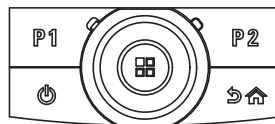
Accessing the Programmed Functions

You can access various radio functions through one of the following ways:



- A short or long press of the relevant programmable buttons.
- Use the 4-Way Navigation Disc as follows:
 - 1 Press  to access the menu. Press the appropriate Menu Scroll button ( or ) to access the menu functions.
 - 2 To select a function or enter a sub-menu, press the  button.
 - 3 To go back one menu level, or to return to the previous screen, press the  button. Long

press the  button to return to the Home screen.



Note:

Your radio automatically exits the menu after a period of inactivity and returns to your Home screen.

Identifying Status Indicators

Display Icons







Your radio has a 2 inch landscape display with QVGA (Quarter Video Graphics Array) 16-bit color resolution.







The following are icons that appear on the display of the radio. Icons are displayed arranged left-most in order of appearance/usage.















Received Signal Strength Indicator (RSSI)







The number of bars displayed represents the radio signal strength. Four bars indicate the strongest signal. This icon is only displayed while receiving.





| | |
|---|---|
|  | Monitor Selected channel is being monitored. |
|  | Bluetooth Not Connected The Bluetooth feature is enabled but there is no remote Bluetooth device connected. |
|  | Bluetooth Connected The Bluetooth feature is enabled. The icon stays lit when a remote Bluetooth device is connected. |
|  | Sign In Radio is signed in to the remote server. |
|  | Sign Out Radio is signed out of the remote server. |
|  | High Volume Data Radio is receiving high volume data and channel is busy. |



| | |
|---|--|
|  | Job Ticket Notification Notification List has items to review. |
|  | Option Board The Option Board is enabled. (Option board enabled models only) |
|  | Option Board Non-Function The Option Board is disabled. |
|  | Over-the-Air Programming Delay Timer Indicates time left before automatic re-start of radio. |
|  | Scan ^{[3][4]} Scan feature is enabled. |
|  | Scan- Priority 1 ^{[3][4]} Radio detects activity on channel/group designated as Priority 1. |

| | |
|---|--|
|  | Scan- Priority 2 ^{[3][4]} Radio detects activity on channel/group designated as Priority 2. |
|  | Flexible Receive List Flexible receive list is enabled. |
|  | Emergency Radio is in Emergency mode. |
|  | Secure The Privacy feature is enabled. |
|  | Unsecure The Privacy feature is disabled. |
|  | Site Roaming ^[3] The site roaming feature is enabled. |
|  | Talkaround ^{[3][4]} |

| | |
|---|---|
| | In the absence of a repeater, radio is currently configured for direct radio to radio communication. |
|  | Battery The number of bars (0 – 4) shown indicates the charge remaining in the battery. Blinks when the battery is low. |
|  | Battery Charging Status Shows battery discharging status. |
|  | All Tones Disabled No ring tones available. |
|  | Call Log Radio call log. |
|  | Contact Radio contact is available. |
|  | Message |

| | |
|---|--|
| | Incoming message. |
|  | Silent Ring Silent ring mode is enabled. |
|  | Ring Only Ringing mode is enabled. |
|  | Vibrate Vibrate mode is enabled. |
|  | Vibrate and Ring Vibrate and Ring mode is enabled. |
|  | Wi-Fi Excellent^[5] Wi-Fi signal is excellent. |
|  | Wi-Fi Good^[5] Wi-Fi signal is good. |
|  | Wi-Fi Average^[5] Wi-Fi signal is average. |

| | |
|---|---|
|  | Wi-Fi Poor^[5] Wi-Fi signal is poor. |
|  | Wi-Fi Unavailable^[5] Wi-Fi signal is unavailable. |
|  | Wi-Fi Excellent Highlighted^[5] Wi-Fi signal is excellent. When you scroll to a network in the network list, the Wi-Fi icon of that network is highlighted. |
|  | Wi-Fi Good Highlighted^[5] Wi-Fi signal is good. When you scroll to a network in the network list, the Wi-Fi icon of that network is highlighted. |
|  | Wi-Fi Average Highlighted^[5] |

| | |
|---|---|
| | Wi-Fi signal is average. When you scroll to a network in the network list, the Wi-Fi icon of that network is highlighted. |
|  | Wi-Fi Poor Highlighted^[5] Wi-Fi signal is poor. When you scroll to a network in the network list, the Wi-Fi icon of that network is highlighted. |
|  | Wi-Fi Unavailable Highlighted^[5] Wi-Fi signal is unavailable. When you scroll to a network in the network list, the Wi-Fi icon of that network is highlighted. |





³ Not applicable in Capacity Plus

⁴ Not applicable in Linked Capacity Plus

⁵ Only applicable for SL7550e/SL7590e/SL7580e

Call Icons

The following icons appear on the radio's display during a call. These icons also appear in the Contacts list to indicate ID type.

| | |
|---|---|
|  | <p>Private Call</p> <p>Indicates a Private Call in progress.</p> |
|  | <p>Group Call/All Call</p> <p>Indicates a Group Call or All Call in progress.</p> |
|  | <p>Phone Call as Private Call</p> <p>Indicates a Phone Call as Private Call in progress. In the Contacts list, it indicates a phone alias (name) or ID (number).</p> |
|  | <p>Phone Call as Group/All Call</p> <p>Indicates a Phone Call as Group/All Call in progress. In the Contacts list, it indicates a group alias (name) or ID (number).</p> |



Bluetooth PC Call

Indicates a Bluetooth PC Call in progress. In the Contacts list, it indicates a Bluetooth PC Call alias (name) or ID (number).





Private Call Alert

In the Contacts list, it indicates a subscriber alias (name) or ID (number).



Utilities Icons

The following icons appear beside menu items on the radio's display that offer the following options.

| | |
|--|---|
|  | <p>Checkbox (Empty)</p> <p>Indicates the option is not selected.</p> |
|  | <p>Checkbox (Checked)</p> <p>Indicates the option is selected.</p> |
|  | <p>Brightness</p> <p>Indicates the brightness level.</p> |











Mini Notice Icons

The following icons appear momentarily on the radio's display after an action to perform task is taken.

| | |
|---|---|
|  | <p>Successful Transmission (Positive)</p> <p>Successful action taken.</p> |
|  | <p>Failed Transmission (Negative)</p> <p>Failed action taken.</p> |
|  | <p>Transmission in Progress (Transitional)</p> <p>Transmitting. This is seen before indication for Successful Transmission or Failed Transmission.</p> |



Sent Item Icons

The following icons appear at the top right corner of the radio's display in the Sent Items folder.

| | |
|---|--|
|  | <p>Sent Successfully</p> |
| OR | <p>The text message is sent successfully.</p> |
|  | |
|  | <p>Individual or Group Message Read</p> |
| OR | <p>The text message has been read.</p> |
|  | |
|  | <p>Individual or Group Message Unread</p> |
| OR | <p>The text message has not been read.</p> |
|  | |
|  | <p>Send Failed</p> |
| OR | <p>The text message has not been sent.</p> |
|  | |
|  | <p>In-Progress</p> |
| OR | <ul style="list-style-type: none"> The text message to a group alias or ID is pending transmission. |
|  | |

- The text message to a subscriber alias or ID is pending transmission, followed by waiting for acknowledgement.

Job Tickets Icons

| | |
|---|---|
|  | All Jobs Indicates all jobs listed. |
|  | New Jobs Indicates new jobs. |

LED Indicator

The LED indicator (A) shows the operational status of your radio.

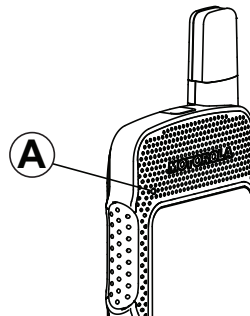

Blinking red

Radio is transmitting at low battery condition, receiving or sending an emergency transmission, has failed the self-test upon powering up, or has moved out of range if radio is configured with Auto-Range Transponder System.

Solid yellow

Radio is monitoring a digital conventional channel or in Bluetooth Discoverable Mode. Also indicates fair battery charge when programmable button is pressed.

Blinking yellow

Radio is scanning for activity or receiving a Call Alert, flexible receive

Double blinking yellow

list is enabled or all local Linked Capacity Plus channels are busy.

Radio is no longer connected to the repeater while in Capacity Plus or Linked Capacity Plus; all Capacity Plus or Linked Capacity Plus channels are currently busy. Auto Roaming is enabled, radio is actively searching for a new site, or radio has yet to respond to a group call alert. Also indicates that radio has yet to respond to a group call alert, or radio is locked.

Solid green

Radio is powering up or transmitting. Also indicates full charge of the battery when the programmable button is pressed.

Blinking green

Radio is powering up, receiving a non-privacy-enabled call or data, or detecting activity, or retrieving Over-the-Air Programming transmissions over the air.

Rapidly blinking green

Radio is receiving a privacy-enabled call or data.



**Note:**

While in conventional mode, when the LED blinks green, it indicates the radio detects activity over the air. Due to the nature of the digital protocol, this activity may or may not affect the radio's programmed channel.

For Capacity Plus and Linked Capacity Plus, there is no LED indication when the radio is detecting activity over the air.

Alert Tones

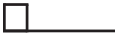

Alert tones provide you with audible indications of the status, or response to data received on the radio.

| | |
|--|---|
| Continuous Tone  | A monotone sound. Sounds continuously until termination. |
| Periodic Tone  | Sounds periodically depending on the duration set by the radio. Tone starts, stops, and repeats itself. |
| Repetitive Tone  | A single tone that repeats itself until it is terminated by the user. |

| | |
|--|---|
| Momentary Tone  | Sounds only once for a short period of time defined by the radio. |
|--|---|

Indicator Tones

| | |
|--|--|
| High pitched tone <input type="checkbox"/> | Low pitched tone <input checked="" type="checkbox"/> |
|--|--|

| | |
|---|-------------------------|
|  | Positive Indicator Tone |
|  | Negative Indicator Tone |

IP Site Connect

This feature allows your radio to extend conventional communication beyond the reach of a single site, by connecting to different available sites which are connected via an Internet Protocol (IP) network.

When the radio moves out of range from one site and into the range of another, it connects to the new site's repeater to send or receive calls/data transmissions. Depending on your settings, this is done automatically or manually.

If the radio is set to do this automatically, it scans through all available sites when the signal from the current site is weak or when the radio is unable to detect any signal from the current site. It then locks on to the repeater with the strongest Received Signal Strength Indicator (RSSI) value.

In a manual site search, the radio searches for the next site in the roam list that is currently in range (but which may not have the strongest signal) and locks on to it.



Note:

Each channel can only have either Scan or Roam enabled, not both at the same time.

Channels with this feature enabled can be added to a particular roam list. The radio searches the channel(s) in the roam list during the automatic roam operation to locate the best site.

A roam list supports a maximum of 16 channels (including the Selected Channel).



Note:

You cannot manually add or delete an entry to the roam list. Check with your dealer or system administrator for more information.

Capacity Plus

Capacity Plus is a single-site trunking configuration of the MOTOTRBO radio system, which uses a pool of channels to support hundreds of users and up to 254 Groups. This feature allows your radio to efficiently utilize the available number of programmed channels while in Repeater Mode.

You hear a negative indicator tone if you try to access a feature not applicable to Capacity Plus via a programmable button press.

Your radio also has features that are available in conventional digital mode, IP Site Connect, Capacity Plus and Linked Capacity Plus. However, the minor differences in the way each feature works does **not** affect the performance of your radio.

Check with your dealer or system administrator for more information on this configuration.

Linked Capacity Plus

Linked Capacity Plus is a multi-site multi-channel trunking configuration of the MOTOTRBO radio system, combining the best of both Capacity Plus and IP Site Connect configurations.

Linked Capacity Plus allows your radio to extend trunking communication beyond the reach of a single site, by connecting to different available sites which are connected via an Internet Protocol (IP) network. It also provides an increase in capacity by efficiently utilizing the combined available number of programmed channels supported by each of the available sites.

When the radio moves out of range from one site and into the range of another, it connects to the new site's repeater to send or receive calls/data transmissions. Depending on your settings, this is done automatically or manually.

If the radio is set to do this automatically, it scans through all available sites when the signal from the current site is weak or when the radio is unable to detect any signal from the current site. It then locks on to the repeater with the strongest Received Signal Strength Indicator (RSSI) value.

In a manual site search, the radio searches for the next site in the roam list that is currently in range (but which may not have the strongest signal) and locks on to it.

Any channel with Linked Capacity Plus enabled can be added to a particular roam list. The radio searches

these channels during the automatic roam operation to locate the best site.



Note:

You cannot manually add or delete an entry to the roam list. Check with your dealer or system administrator for more information.

Similar to Capacity Plus, icons of features not applicable to Linked Capacity Plus are not available in the menu. You hear a negative indicator tone if you try to access a feature not applicable to Linked Capacity Plus via a programmable button press.





Check with your dealer or system administrator for more information on this configuration.

Making and Receiving Calls in Non-Connect Plus Mode

Selecting a Zone

A zone is a group of channels. Your radio supports up to 250 zones, with a maximum of 160 channels per zone.





- 1 Access the Zone feature.

| Radio Controls | Steps |
|------------------------|--|
| Programmed Zone button | Press the programmed Zone button. |
| Radio menu | <ol style="list-style-type: none"> 1  to access the menu. 2  or  to Zone and press  to select. |

The current zone is displayed and indicated by a .

- 2 Select the required zone.

Radio Control Steps



 or  or  or  and scroll to the required zone.

Keypad

- 1 Enter the first character of the required zone.
- 2 A blinking cursor appears allowing you to continue entering the subsequent characters of the required zone.



Note:

Press  to move one space to the left. Press  to move one space to the right. Press the  key to delete any unwanted characters.



Note:



The first line of the display shows the characters you keyed in. The second line shows a zone that matches what you

Radio Steps Control

have already keyed in. The alias search is case-insensitive. If there are two or more with the same name, the radio displays the zone that is listed first in the zone list.

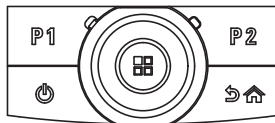
- 3 Press  to select. The display shows <Zone> Selected momentarily and returns to the selected zone screen.



On the navigation disc, press  to access the Channel List (while on the Home Screen). The active channel is displayed and indicated by a .

Receiving and Responding to a Radio Call

Once the channel, subscriber ID, or group ID is displayed, you can proceed to receive and respond to calls.

The LED lights up solid green while the radio is transmitting and blinks green when the radio is receiving.



Note:

The LED lights up solid green while the radio is transmitting and blinks green rapidly when the radio is receiving a privacy-enabled call.

To unscramble a privacy-enabled call, your radio must have the same Privacy Key, OR the same Key Value and Key ID (programmed

Selecting a Channel

Transmissions are sent and received on a channel. Depending on your radio's configuration, each channel may have been programmed differently to support different groups of users or supplied with different features. After selecting the relevant Zone, select the relevant channel you require to transmit or receive on.

by your dealer), as the transmitting radio (the radio you are receiving the call from).

See [Privacy](#) on page 121 for more information.

Receiving and Responding to a Group Call

To receive a call from a group of users, your radio must be configured as part of that group.

When you receive a Group Call (while on the Home screen), the LED blinks green. The first line of the display shows the caller alias, and the RSSI icon. The second line displays the group alias and the Group Call icon (in Digital mode only). Your radio unmutes and the incoming call sounds through the radio's speaker.

- 1 Hold the radio vertically 1 to 2 inches (2.5 to 5.0 cm) from your mouth.
 - If the Channel Free Indication feature is enabled, you hear a short alert tone the moment the transmitting radio releases the **PTT** button, indicating the channel is free for you to respond. Press the **PTT** button to respond.

- If the Voice Interrupt feature is enabled, press the **PTT** button to stop the current call from the transmitting radio and free the channel for you to talk/respond.

The LED lights up solid green.

- 2 Wait for one of the following tones to finish (if enabled), and speak clearly into the microphone.
 - The Talk Permit Tone
 - The **PTT** Sidetone
- 3 Release the **PTT** button to listen.

If there is no voice activity for a predetermined period of time, the call ends.



Note:

See [Making a Group Call](#) on page 52 for details on making a Group Call.

If the radio receives a Group Call while not on the Home screen, it remains on its current screen prior to answering the call.

Long press the  button to go to the Home screen to view the caller alias before replying.

Receiving and Responding to a Private Call

A Private Call is a call from an individual radio to another individual radio.

When you receive a Private Call, the LED blinks green. The first line of the display shows the subscriber alias or ID, and the RSSI icon. The second line displays `Private Call` and the Private Call icon. Your radio unmutes and the incoming call sounds through the speaker of the radio.

- 1 Hold the radio vertically 1 to 2 inches (2.5 to 5.0 cm) from your mouth.
 - If the Channel Free Indication feature is enabled, you hear a short alert tone the moment the transmitting radio releases the **PTT** button, indicating the channel is free for you to respond. Press the **PTT** button to respond.
 - If the Voice Interrupt feature is enabled, press the **PTT** button to stop the current call from the transmitting radio and free the channel for you to talk/respond.

The LED lights up solid green.

- 2 Wait for the Talk Permit Tone to finish (if enabled), and speak clearly into the microphone.
-

- 3 Release the **PTT** button to listen.
-

If there is no voice activity for a predetermined period of time, the call ends.

The display shows `Call Ended`.

See [Making a Private Call](#) on page 53 for details on making a Private Call.

Receiving an All Call

An All Call is a call from an individual radio to every radio on the channel. It is used to make important announcements requiring the user's full attention.

When you receive an All Call, a tone sounds and the LED blinks green.

The first line of the display shows the caller alias, and the RSSI icon. The second line displays `All Call` and the All Call icon. Your radio unmutes and the incoming call sounds through the radio speaker.

Once the All Call ends, the radio returns to the previous screen before receiving the call. An All Call does not wait for a predetermined time before ending.

If the Channel Free Indication feature is enabled, you hear a short alert tone the moment the transmitting radio releases the **PTT** button, indicating the channel is now available for use.

You cannot respond to an All Call.



Note:

See [Making an All Call](#) on page 54 for details on making an All Call.



Note:

The radio stops receiving the All Call if you switch to a different channel while receiving the call. During an All Call, you will **not** be able to use any programmed button functions until the call ends.

Receiving and Responding to a Phone Call

Phone Call as Private Call

When you receive a Phone Call as a Private Call, the Phone Call icon appears in the top right corner; the display shows the caller alias or Phone Call.

If Phone Call capability is not enabled on your radio, the first line of the display shows Unavailable and

your radio mutes the call. Your radio returns to the previous screen when the call ends.

1 Press the **PTT** button to talk and release it to listen.

2 Press  to end the call.

The display shows Ending Phone Call.

If successful, a tone sounds and the display shows All Call and Call Ended.

If successful, a tone sounds and the display shows Call Ended.

If unsuccessful, your radio returns to the Phone Call screen. Repeat this step to end the call.

Phone Call as Group Call

When you receive a Phone Call as a Group Call,

1 Press the **PTT** button to talk and release it to listen.

2 Press  to end the call.

The display shows Ending Phone Call.

If successful, a tone sounds and the display shows All Call and Call Ended.

If unsuccessful, your radio returns to the Phone Call screen. Repeat this step to end the call.

Phone Call as All Call

When you receive a Phone Call as an All Call, the Phone Call icon appears in the top right corner; the display shows All Call and Phone Call.

If Phone Call capability is not enabled on your radio, the first line of the display shows Unavailable and your radio mutes the call.



Note:

When you receive a Phone Call as an All Call, you can respond to the call or end the call, only if an All Call type is assigned to the channel.

1 Press the **PTT** button to talk and release it to listen.

2 Press  to end the call.
The display shows Ending Phone Call.

If successful, a tone sounds and the display shows All Call and Call Ended.

If unsuccessful, your radio returns to the Phone Call screen. Repeat this step to end the call.

Making a Radio Call

After selecting your channel, you can select a subscriber alias or ID, or group alias or ID by using:

- The **PTT** button.
- A programmed **One Touch Access** button – The One Touch Access feature allows you to make a Group or Private Call to a predefined ID easily. This feature can be assigned to a short or long programmable button press. You can **ONLY** have one ID assigned to a **One Touch Access** button. Your radio can have multiple **One Touch Access** buttons programmed.
- The programmed number keys – This method is for Group, Private and All Calls only and is used with the keypad (see [Making a Group, Private or All Call with the Programmable Number Key](#) on page 57).

- A programmable button – This method is for Phone Calls only (see [Making a Phone Call with the Programmable Phone Button](#) on page 58).
- The Contacts list (see [Contact Settings](#) on page 75). 
- Manual Dial – This method is for Private and Phone Calls only and is dialed using the keypad (see [Making a Private Call from Contacts](#) on page 77, and [Making a Call with the Programmable Manual Dial Button](#) on page 60).

**Note:**

Your radio must have the Privacy feature enabled on the channel to send a privacy-enabled transmission. Only target radios with the same Privacy Key OR the same Key Value and Key ID as your radio will be able to unscramble the transmission.

**Note:**

See [Privacy](#) on page 121 for more information.

Making a Group Call

To make a call to a group of users, your radio must be configured as part of that group.

- 1 Do one of the following.
 - Select the channel with the active group alias or ID. See [Selecting a Channel](#) on page 47.
 - Press the programmed **One Touch Access** button.

- 2 Hold the radio vertically 1 to 2 inches (2.5 to 5.0 cm) from your mouth.

- 3 Press the **PTT** button to make the call. The LED lights up solid green. The Group Call icon appears in the top right corner. The first text line shows the group call alias.

- 4 Wait for the Talk Permit Tone to finish (if enabled), and speak clearly into the microphone.

- 5 Release the **PTT** button to listen. When the target radio responds, the LED blinks green, the radio unmutes and the response sounds through the radio's speaker. You see the Group Call icon, the group alias or ID, and transmitting radio alias or ID on your display.

- 6 If the Channel Free Indication feature is enabled, you hear a short alert tone the moment the

transmitting radio releases the **PTT** button, indicating the channel is free for you to respond. Press the **PTT** button to respond.

If there is no voice activity for a predetermined period of time, the call ends. Radio returns to the screen you were on prior to initiating the call.

[Features](#) on page 102 or [Call Alert Operation](#) on page 93 for more information.

- 1 Do one of the following.
 - Select the channel with the active subscriber alias or ID. See [Selecting a Channel](#) on page 47.
 - Press the programmed **One Touch Access** button.

- 2 Hold the radio vertically 1 to 2 inches (2.5 to 5.0 cm) from your mouth.

- 3 Press the **PTT** button to make the call.

If you release the **PTT** button while the radio is setting up the call, it exits without any indication and returns to the previous screen.

The LED lights up solid green., the radio unmutes and the response sounds through the radio's speaker. The Private Call icon appears on the top right corner. The first text line shows the subscriber alias. The second text line displays the call status.

- 4 Wait for the Talk Permit Tone to finish (if enabled), and speak clearly into the microphone.

Making a Private Call

While you can receive and/or respond to a Private Call initiated by an authorized individual radio, your radio must be programmed for you to initiate a Private Call.

There are two types of Private Calls. The first type, where a radio presence check is performed prior to setting up the call, while the other sets up the call immediately.

Only **one** of these call types can be programmed to your radio by your dealer.

You will hear a negative indicator tone, when you make a Private Call via the **One Touch Access** button, the programmed number keys, or the Scroll Up/Down buttons, if this feature is not enabled.

Use the Text Message or Call Alert features to contact an individual radio. See [Text Message](#)

- 5 Release the **PTT** button to listen.

When the target radio responds, the LED blinks green, the radio unmutes and the response sounds through the radio's speaker.

- 6 If the Channel Free Indication feature is enabled, you hear a short alert tone the moment the transmitting radio releases the **PTT** button, indicating the channel is free for you to respond. Press the **PTT** button to respond.

If there is no voice activity for a predetermined period of time, the call ends. You hear a short tone. The display shows `Call Ended`.

Your radio may be programmed to perform a radio presence check prior to setting up the Private Call. If the target radio is not available, you hear a short tone and see negative mini notice on the display.

Making an All Call

This feature allows you to transmit to all users on the channel. Your radio must be programmed to allow you to use this feature.

Users on the channel cannot respond to an All Call.

- 1 Select the channel with the active All Call group alias or ID. See [Selecting a Channel](#) on page 47.

- 2 Hold the radio vertically 1 to 2 inches (2.5 to 5.0 cm) from your mouth.

- 3 Press the **PTT** button to make the call. The LED lights up solid green. The Group Call icon appears in the top right corner. The first text line shows `All Call`.

- 4 Wait for the Talk Permit Tone to finish (if enabled), and speak clearly into the microphone.

Making a Phone Call with the One Touch Access Button

- 1 Press the programmed **One Touch Access** button to make a Phone Call to the predefined alias or ID.

If the entry for the **One Touch Access** button is empty, a negative indicator tone sounds. If the access code was not preconfigured in the Contacts list, the display shows `Access Code?`.

Enter the access code and press  to proceed.

The LED lights up solid green. The Phone Call icon appears in the top right corner. The first text line shows the subscriber alias. The second text line displays the call status.

If the call-setup is successful, the DTMF tone sounds. You hear the dialing tone of the telephone user. The first text line shows the subscriber alias. The Phone Call icon remains in the top right corner.

If the call-setup is unsuccessful, a tone sounds and the display shows *Phone Call Failed*. Your radio returns to the Access Code input screen. If the access code was preconfigured in the Contacts list, the radio returns to the screen you were on prior to initiating the call.

2 Hold the radio vertically 1 to 2 inches (2.5 to 5.0 cm) from your mouth.

3 Press the **PTT** button to talk and release it to listen.

To enter extra digits, if requested by the Phone Call, enter the extra digits using the keypad and press  to proceed.

The DTMF tone sounds with each keypad press, and the radio returns to the previous screen.

4 Press  to end the call.

If de-access code was not preconfigured in the Contacts list, the display shows *De-Access Code:*. Press the **One Touch Access** button, if it is programmed with the de-access code. If the entry for the **One Touch Access** button is empty, a negative indicator tone sounds.

The DTMF tone sounds with each keypad press, and the display shows *Ending Phone Call*.

If the end-call-setup is successful, a tone sounds and the display shows *Call Ended*.

If the end-call-setup is unsuccessful, your radio returns to the Phone Call screen. Repeat Step 4 or wait for the telephone user to end the call.



Note:

When the telephone user ends the call, a tone sounds and the display shows *Call Ended*.

If the call ends while you are entering the extra digits requested by the Phone Call, your radio returns to the screen you were on prior to initiating the call.

During channel access, press  to dismiss the call attempt. A tone sounds to indicate success.

During the call, if you press the **One Touch Access** button with the deaccess code preconfigured or enter the deaccess code as the input for extra digits, your radio attempts to end the call.

The access or deaccess code cannot be more than 10 characters.

Making a Private Call with a One Touch Call Button

**Note:**

Programmable buttons press must be initiated from the Home screen.

The One Touch Call feature allows you to easily make a Private Call to a pre-defined Private Call alias or ID. This feature can be assigned to a short or long programmable button press.

You can **ONLY** have one alias or ID assigned to a One Touch Call button. Your radio can have multiple One Touch Call buttons programmed.

- 1 Press the programmed **One Touch Call** button to make a Private Call to the pre-defined Private Call alias or ID.

- 2 Hold the radio vertically 1 to 2 inches (2.5 to 5.0 cm) from your mouth.

- 3 Press the **PTT** button to make the call.
The LED lights up solid green.
The display shows the Private Call alias or ID.

- 4 Wait for the Talk Permit Tone to finish (if enabled) and speak clearly into the microphone.

- 5 Release the **PTT** button to listen.
When the target radio responds, the LED blinks green.

- 6 If the Channel Free Indication feature is enabled, you will hear a short alert tone the moment the target radio releases the **PTT** button, indicating the

channel is free for you to respond. Press the **PTT** button to respond.

If there is no voice activity for a predetermined period of time, the call ends.

Making a Group, Private or All Call with the Programmable Number Key

The Programmable Number Key feature allows you to make a Group, Private or All Call to a predefined alias or ID easily. This feature can be assigned to all the available number keys on a keypad.

You can **ONLY** have one alias or ID assigned to a number key, but you can have more than one number key associated to an alias or ID.

- 1 Long press the programmed number key, when you are on the Home screen, to make a Group, Private or All Call to the predefined alias or ID.
If the number key is not associated to an entry, a negative indicator tone sounds.

- 2 Hold the radio vertically 1 to 2 inches (2.5 to 5.0 cm) from your mouth.

- 3 Press the **PTT** button to make the call.

The LED lights up solid green, the radio unmutes and the response sounds through the radio's speaker. The Group/Private Call icon appears in the top right corner. The first text line shows the caller alias. The second text line displays either the call status for a Private Call or All Call for All Call.

-
- 4 Wait for the Talk Permit Tone to finish (if enabled), and speak clearly into the microphone.

 - 5 Release the **PTT** button to listen.
When the target radio responds, the LED blinks green, the radio unmutes and the response sounds through the radio's speaker.

 - 6 If the Channel Free Indication feature is enabled, you hear a short alert tone the moment the transmitting radio releases the **PTT** button, indicating the channel is free for you to respond. Press the **PTT** button to respond.

If there is no voice activity for a predetermined period of time, the call ends. Radio returns to the screen you were on prior to initiating the call.

For a Private Call, you hear a short tone when the call ends.

See [Assigning an Entry to a Programmable Number Key](#) on page 83 for details on assigning an entry to a number key on the keypad.

Making a Phone Call with the Programmable Phone Button

1 Press the programmed **Phone** button to enter into the Phone Entry list.

2 ▲ or ▼ to the required subscriber alias or ID, and press  to select.

If the access code was not preconfigured in the Contacts list, the display shows *Access Code:*.

Enter the access code and press the  button to proceed.

The LED lights up solid green. The Phone Call icon appears in the top right corner. The first text line shows the subscriber alias. The second text line displays the call status.

If the call-setup is successful, the DTMF tone sounds. You hear the dialing tone of the telephone user. The first text line shows the subscriber alias. The Phone Call icon remains in the top right

corner. The second text line displays the call status.

If call-setup is unsuccessful, a tone sounds and the display shows *Phone Call Failed*. Your radio returns to the Access Code input screen. If the access code was preconfigured in the Contacts list, the radio returns to the screen you were on prior to initiating the call.

3 Hold the radio vertically 1 to 2 inches (2.5 to 5.0 cm) from your mouth.

4 Press the **PTT** button to talk and release it to listen.

5 To enter extra digits, if requested by the Phone Call, do one of the following.

- Press any keypad key to begin the input of the extra digits. The first line of the display shows *Extra Digits:*. The second line of the display shows a blinking cursor. Enter the extra digits

and press the  button to proceed. The DTMF tone sounds and the radio returns to the previous screen.

- Press **One Touch Access** button. The DTMF tone sounds. If the entry for the **One Touch Access** button is empty, a negative indicator tone sounds.

6 Press  to end the call.

If deaccess code was not preconfigured in the Contacts list, the first line of the display shows De-Access Code: . The second line of the display shows a blinking cursor. Enter the deaccess code

and press the  button to proceed. The radio returns to the previous screen.

The DTMF tone sounds and the display shows Ending Phone Call.

If the end-call-setup is successful, a tone sounds and the display shows Call Ended.

If the end-call-setup is unsuccessful, your radio returns to the Phone Call screen. Repeat Steps 4 and 6 or wait for the telephone user to end the call.

When you press **PTT** button while in the Phone Contacts screen, a tone sounds and the display shows Press OK to Place Phone Call.

When the telephone user ends the call, a tone sounds and the display shows Phone Call Ended.

If the call ends while you are entering the extra digits requested by the Phone Call, your radio returns to the screen you were on prior to initiating the call.



Note:

During channel access, press  to dismiss the call attempt and a tone sounds.

During the call, when you press **One Touch Access** button with the deaccess code preconfigured or enter the deaccess code as the input for extra digits, your radio attempts to end the call.





Note:

The access or deaccess code cannot be more than 10 characters.

Making a Call with the Programmable Manual Dial Button

Making a Private Call

- 1 Press the programmed **Manual Dial** button to enter into the Manual Dial screen.

- 2  or  to **Radio Contact** and press  to select.
The display shows **Number:.**

- 3 Use the keypad to enter a subscriber alias.

- 4 Hold the radio vertically 1 to 2 inches (2.5 to 5.0 cm) from your mouth.

- 5 Press the **PTT** button to make the call.
The LED lights up solid green. The Private Call icon appears in the top right corner. The first text line shows the subscriber alias. The second text line displays the call status.

- 6 Wait for the Talk Permit Tone to finish (if enabled) and speak clearly into the microphone.



- 7 Release the **PTT** button to listen.

When the target radio responds, the LED blinks green.

- 8 If the Channel Free Indication feature is enabled, you will hear a short alert tone the moment the target radio releases the **PTT** button, indicating the channel is free for you to respond. Press the **PTT** button to respond.
If there is no voice activity for a predetermined period of time, the call ends. You hear a short tone. The display shows **Call Ended.**

Making a Phone Call

- 1 Press the programmed **Manual Dial** button to enter into the Manual Dial screen.

- 2  or  to **Phone Contact** and press  to select.
The display shows **Number:.**

- 3 Use the keypad to enter a subscriber alias.
If the access code was not preconfigured in the Contacts list, the display shows **Access Code:.**
Enter the access code and press the  button to proceed.

The LED lights up solid green. The Phone Call icon appears in the top right corner. The first text line shows the subscriber alias. The second text line displays the call status.

If the call-setup is successful, the DTMF tone sounds. You hear the dialing tone of the telephone user. The first text line shows the subscriber alias. The Phone Call icon remains in the top right corner.

If the call-setup is unsuccessful, a tone sounds and the display shows `Phone Call Failed`. Your radio returns to the Access Code input screen. If the access code was preconfigured in the Contacts list, the radio returns to the screen you were on prior to initiating the call.

-
- 4 Hold the radio vertically 1 to 2 inches (2.5 to 5.0 cm) from your mouth.
-
- 5 Press the **PTT** button to talk and release it to listen.
-
- 6 To enter extra digits, if requested by the Phone Call, do one of the following.

- Press any keypad key to begin the input of the extra digits. Enter the extra digits and press the  button to proceed. The DTMF tone sounds and the radio returns to the previous screen.
- Press **One Touch Access** button. The DTMF tone sounds. If the entry for the **One Touch Access** button is empty, a negative indicator tone sounds.

-
- 7 Press  to end the call.

If deaccess code was not preconfigured in the Contacts list, the display shows `De-Access`

`Code:.` Enter the deaccess code and press the  button to proceed. The radio returns to the previous screen.

The DTMF tone sounds and the display shows `Ending Phone Call`.

If the end-call-setup is successful, a tone sounds and the display shows `Call Ended`.

If the end-call-setup is unsuccessful, your radio returns to the Phone Call screen. Repeat Step 7 or wait for the telephone user to end the call.

When you press **PTT** button while in the Phone Contacts screen, a tone sounds and the display shows `Press OK to Place Phone Call`.

When the telephone user ends the call, a tone sounds and the display shows `Phone Call Ended`.

If the call ends while you are entering the extra digits requested by the Phone Call, your radio returns to the screen you were on prior to initiating the call.



Note:

During channel access, press  to dismiss the call attempt and a tone sounds.



Note:

During the call, when you press **One Touch Access** button with the deaccess code preconfigured or enter the deaccess code as the input for extra digits, your radio attempts to end the call.



Note:

The access or deaccess code cannot be more than 10 characters.

Stopping a Radio Call

This feature allows you to stop an ongoing Group or Private Call to free the channel for transmission. For example, when a radio experiences a “stuck microphone” condition where the **PTT** button is inadvertently pressed by the user.

Your radio must be programmed to allow you to use this feature.

- 1 Press the programmed **Transmit Interrupt Remote Dekey** button, while on the relevant channel.

- 2 Wait for acknowledgement.

If successful, the radio sounds a positive indicator tone and the display shows `Remote Dekey Success`, indicating that the channel is now free.

If unsuccessful, the radio sounds a negative indicator tone and the display shows `Remote Dekey Failed`.

On the interrupted radio, the display shows `Call Interrupted`, and the radio sounds a negative indicator tone until the **PTT** button is released, if it is

transmitting an interruptible call that is stopped via this feature.

Talkaround

You can continue to communicate when your repeater is not operating, or when your radio is out of the repeater's range but within talking range of other radios.

This is called "talkaround".



Note:

This feature is not applicable in Capacity Plus and Linked Capacity Plus.

The Talkaround setting is retained even after powering down.

You can toggle between talkaround and repeater modes by pressing the programmed **Repeater/Talkaround** button or using the radio menu as described next.

- 1 to access the menu.

- 2 or to **Utilities** and press to select.

- 3 or to **Radio Settings** and press to select.

- 4 or to **Talkaround** and press to select.

You can also use or to change the selected option.

- 5 Press to enable/disable the Talkaround.

The display shows beside **Enabled**.

The disappears from beside **Enabled**.

Monitoring Features

Monitoring a Channel

Use the Monitor feature to make sure a channel is clear before transmitting.

This feature is not applicable in Capacity Plus and Linked Capacity Plus.

- 1 Press and hold the programmed **Monitor** button and listen for activity.

The Monitor icon appears on the display and the LED lights up solid yellow. You hear radio activity or total silence, depending on how your radio is programmed. This indicates that the channel is in use.

- 2 Press the **PTT** button to talk and release it to listen.
-

Permanent Monitor

Use the Permanent Monitor feature to continuously monitor a selected channel for activity.



Note:

This feature is not applicable in Capacity Plus and Linked Capacity Plus.

- 1 Press the programmed **Permanent Monitor** button to activate permanent monitoring of the channel.
Radio sounds an alert tone, the LED lights up solid yellow, and the display shows `Permanent Monitor On`. The Monitor icon appears on the display.
-
- 2 Press the programmed **Permanent Monitor** button to exit Permanent Monitor mode.

Radio sounds an alert tone, the LED turns off, and the display shows `Permanent Monitor Off`.



Advanced Features in Non-Connect Plus Mode

Radio Check

If enabled, this feature allows you to determine if another radio is active in a system without disturbing the user of that radio. No audible or visual notification is shown on the target radio.





Sending a Radio Check





- 1 Access the Radio Check feature.

| Radio Control | Steps |
|-------------------------------|---|
| Programmed Radio Check button | <ol style="list-style-type: none"> 1 Press the programmed Radio Check button. 2 ▲ or ▼ to the required subscriber alias or ID and press  to select. |
| Menu | <ol style="list-style-type: none"> 1  to access the menu. |

Radio Control

Steps

- 2 ▲ or ▼ to **Contacts** and press  to select.
- 3 Use one of the steps described next to select the required subscriber alias or ID:
 - Select the subscriber alias or ID directly.
 - ▲ or ▼ to the required subscriber alias or ID and press  to select.
 - Use the **Manual Dial** menu.
 - ▲ or ▼ to **Manual Dial** and press  to select.
 - ▲ or ▼ to **Radio Number** and press  to select.

| Radio Control | Steps |
|---------------|---|
| | <ul style="list-style-type: none"> If there was previously dialed ID, the ID appears along with a blinking cursor. Else, the first line of the display shows Radio Number::; the second line of the display shows a blinking cursor. Use the keypad to edit/enter the ID, and press  to select. <p>4  or  to Radio Check and press  to select.</p> |

The display shows transitional mini notice, indicating the request is in progress. The LED lights up solid green.

2 Wait for acknowledgement.

If the  button is pressed when the radio is waiting for acknowledgement, a tone sounds, and the radio terminates all retries and exits Radio Check mode.

If Radio Check is successful, a positive indicator tone sounds and the display shows positive mini notice.

If Radio Check is unsuccessful, a negative indicator tone sounds and the display shows negative mini notice.

Radio returns to the subscriber alias or ID screen.





Remote Monitor





Use the Remote Monitor feature to turn on the microphone of a target radio (subscriber alias or IDs only). The green LED will blink once on the target subscriber. You can use this feature to monitor, remotely, any audible activity surrounding the target radio.

Your radio must be programmed to allow you to use this feature.

Initiating Remote Monitor

- 1 Access the Remote Monitor feature.

| Radio Control | Steps |
|----------------------------------|--|
| Programmed Remote Monitor Button | <ol style="list-style-type: none"> 1 Press the programmed Remote Monitor button. 2 ▲ or ▼ to the required subscriber alias or ID and press  to select. |
| Menu | <ol style="list-style-type: none"> 1  to access the menu 2 ▲ or ▼ to Contacts and press  to select 3 Use one of the steps described next to select the required subscriber alias or ID <ul style="list-style-type: none"> • select the subscriber alias or ID directly • ▲ or ▼ to the required subscriber alias or ID and press  to select. |

| Radio Control | Steps |
|---------------|--|
| | <ul style="list-style-type: none"> • use the Manual Dial menu • ▲ or ▼ to Manual Dial and press  to select. • ▲ or ▼ to Radio Number and press  to select. • If there was previously dialed ID, the ID appears along with a blinking cursor. Else, the first line of the display shows Radio Number:; the second line of the display shows a blinking cursor. Key in the subscriber alias or ID and press  to select. <ol style="list-style-type: none"> 4 ▲ or ▼ to Remote Mon. and press  to select. |

The display shows transitional mini notice, indicating the request is in progress. The LED lights up solid green.

2 Wait for acknowledgement.

If successful, a positive indicator tone sounds and the display shows positive mini notice. Your radio starts playing audio from the monitored radio for a programmed duration and display shows **Rem. Monitor**. Once the timer expires, the radio sounds an alert tone and the LED turns off.

If unsuccessful, the radio sounds a negative indicator tone the display shows negative mini notice.

Scan Lists

Scan lists are created and assigned to individual channels/groups. Your radio cycles through the programmed scan list for the current channel looking for voice activity. At each channel in the cycle the radio also cycles through the group list for that channel.

Your radio can support up to 250 scan lists, with a maximum of 16 members in a list.

You can add, delete, or prioritize channels by editing a scan list.

You can attach a new scan list to your radio via Front Panel Programming.









Note:



This feature is not applicable in Capacity Plus and Linked Capacity Plus.

Viewing an Entry in the Scan List

- 1  to access the menu.

- 2  or  to Scan and press  to select.

- 3  or  to View/Edit List and press  to select.



- 4 Use  or  to view each member on the list.



The Priority icon appears left of the member's alias, if set, to indicate whether the member is on a Priority 1 or Priority 2 channel list. You **cannot** have multiple Priority 1 or Priority 2 channels in a scan list.

There is no Priority icon if priority is set to **None**.

Viewing an Entry in the Scan List by Alias Search



- 1  to access the menu.

- 2  or  to Scan and press  to select.

- 3  or  to View/Edit List and press  to select.

- 4 Key in the first character of the required alias. A blinking cursor appears.

- 5 Use the keypad to type the required alias.

Press  to move one space to the left. Press  to move one space to the right. Press the  key to delete any unwanted characters.



The first line of the display shows the characters you keyed in. The second line of the display shows an alias that matches what you have keyed in.



The alias search is case-insensitive. If there are two or more entries with the same name, the radio displays the entry that is listed first in the scan list.



Editing the Scan List

Adding a New Entry to the Scan List

- 1  to access the menu.





- 2  or  to Scan and press  to select.

- 3  or  to View/Edit List and press  to select.











- 4  or  to Add Member and press  to select.

- 5 Select the required alias or ID by performing one of the following actions:

| Radio Control | Steps |
|---------------|---|
| Radio Naviga- |  or  to the required alias or ID. |

| Radio Control | Steps |
|---------------|---|
| tion Buttons | |
| Keypad | <p>Key in the first character of the required alias.</p> <p>A blinking cursor appears.</p> <p>Press  to move one space to the left.</p> <p>Press  to move one space to the right. Press the  key to delete any unwanted characters. Long press  to change the text entry method.</p> <p>The first line of the display shows the characters you keyed in. The next lines of the display show the short listed search results. The alias search is case-insensitive. If there are two or more aliases with the same name, the</p> |

| Radio Control | Steps |
|---------------|--|
| | radio displays the alias that is listed first in the list. |

- 6 Press  to select.
- 7  or  to the required priority level and press  to select.
The display shows `Entry Saved`, followed immediately by `Add Another?`.
- 8 Do one of the following:
 -  or  to `Yes` and press  to select, and repeat Steps 5 to 7.
 -  or  to `No` and press  to save the current list.



Deleting an Entry from the Scan List

- 1  to access the menu.

2 ▲ or ▼ to Scan and press  to select.

3 ▲ or ▼ to View/Edit List and press  to select.

4 Select the required alias or ID by performing one of the following actions:

| Radio Control | Steps |
|--------------------------|---|
| Radio Navigation Buttons | <p>▲ or ▼ to the required alias or ID.</p> |
| Keypad | <p>Key in the first character of the required alias.</p> <p>A blinking cursor appears.</p> <p>Press  to move one space to the left.</p> <p>Press  to move one space to the right. Press the  key to delete any unwanted characters. Long press</p> |

Radio Control Steps

 to change the text entry method.

The first line of the display shows the characters you keyed in. The next lines of the display show the short listed search results. The alias search is case-insensitive. If there are two or more aliases with the same name, the radio displays the alias that is listed first in the list.

5 Press  to select.

6 ▲ or ▼ to Delete and press  to select.



7 Do one of the following:

- ▲ or ▼ to Yes and press  to delete entry. The display shows Entry Deleted.

- ▲ or ▼ to No and press  to return to the previous screen.

- 8 Repeat Steps 4 to 7 to delete other entries. After deleting all required aliases or IDs, long press  to return to the Home screen.

Setting and Editing Priority for an Entry in the Scan List

- 1  to access the menu.
- 2 ▲ or ▼ to Scan and press  to select.
- 3 ▲ or ▼ to View/Edit List and press  to select.
- 4 Select the required alias or ID by performing one of the following actions:

| Radio Control | Steps |
|---------------|-------|
|---------------|-------|

| | |
|---------------|-------------------------------------|
| Radio Naviga- | ▲ or ▼ to the required alias or ID. |
|---------------|-------------------------------------|



| Radio Control | Steps |
|---------------|-------|
|---------------|-------|

| | |
|--------------|--|
| tion Buttons | |
|--------------|--|

| | |
|--------|---|
| Keypad | Key in the first character of the required alias. |
|--------|---|

A blinking cursor appears.

Press  to move one space to the left.



Press  to move one space to the right. Press the  key to delete any unwanted characters. Long press



 to change the text entry method.

The first line of the display shows the characters you keyed in. The next lines of the display show the short listed search results. The alias search is case-insensitive. If there are two or more aliases with the same name, the

| Radio Control | Steps |
|---------------|--|
| | radio displays the alias that is listed first in the list. |

5 Press  to select.

6  or  to Edit Priority and press  to select.

7  or  to the required priority level and press  to select.
The display shows Entry Saved before returning to the previous screen.

**Note:**

The Priority icon appears left of the name of the member.

There is no Priority icon if priority is set to **None**.

Scan

When you start a scan, your radio cycles through the programmed scan list for the current channel looking for voice activity.

The LED blinks yellow and you see the Scan icon on the display.

There are two ways of initiating scan:

- **Main Channel Scan (Manual):** Your radio scans all the channels/groups in your scan list. On entering scan, your radio may (depending on the settings) automatically start on the last scanned “active” channel/group or on the channel where scan was initiated.
- **Auto Scan (Automatic):** Your radio automatically starts scanning when you select a channel/group that has Auto Scan enabled.

**Note:**

This feature is not applicable in Capacity Plus and Linked Capacity Plus.

Setting an Active Scan List

1  to access the menu.

2 ▲ or ▼ to Scan and press  to select.

3 ▲ or ▼ to Set Active List and press  to select.

4 ▲ or ▼ to the required list and press  to select.

The list selected will be your active scan list.

Starting and Stopping Scan

While scanning, the radio will only accept data (e.g. text message, location, telemetry, or PC data) if received on its Selected Channel.

1  to access the menu.

2 ▲ or ▼ to Scan and press  to select.

- The display shows Turn On if scan is disabled.
 - The display shows Turn Off if scan is enabled.
-

3 Press  to select.

- The LED blinks yellow and the Scan icon is displayed, when Scan is enabled.
 - The LED turns off and the Scan icon is not displayed, when Scan is disabled.
-

Responding to a Transmission During a Scan

During scanning, your radio stops on a channel/group where activity is detected. Your radio unmutes and the incoming call sounds through the radio's speaker. The radio stays on that channel while the activity is present and for a programmed time period known as "hang time".

1 Hold the radio vertically 1 to 2 inches (2.5 to 5.0 cm) from your mouth.

If the Channel Free Indication feature is enabled, you hear a short alert tone the moment the transmitting radio releases the **PTT** button, indicating the channel is free for you to respond.

2 Press the **PTT** button during hang time. The LED lights up solid green.

3 Wait for the Talk Permit Tone to finish (if enabled) and speak clearly into the microphone.

4 Release the **PTT** button to listen.

If you do not respond within the hang time, the radio returns to scanning other channels/groups.

Deleting a Nuisance Channel

If a channel continually generates unwanted calls or noise (termed a “nuisance” channel), you can temporarily remove the unwanted channel from the scan list.

This capability does not apply to the channel designated as the Selected Channel.

Deleting a “nuisance” channel is **only** possible through the programmed **Nuisance Channel Delete** button. This feature is **not** accessible through the menu.

- 1 When your radio “locks on to” an unwanted or nuisance channel, press the programmed **Nuisance Channel Delete** button until you hear a tone.
 - 2 Release the **Nuisance Channel Delete** button. The nuisance channel is deleted.
-

Restoring a Nuisance Channel

To restore the deleted nuisance channel, do one of the following:

- Turn the radio off and then power it on again.
- Stop and restart a scan via the programmed **Scan** button or menu.
- Change channel or zone.

Contact Settings

Contacts provides “address-book” capabilities on your radio. Each entry corresponds to an alias or ID that you use to initiate a call.

Each entry, depending on context, associates with one of five types of calls: Group Call, Private Call, All Call, PC Call or Dispatch Call.

PC Call and Dispatch Call are data-related. They are only available with the applications. Refer to the data applications documentation for more information.



Note:

If the Privacy feature is enabled on a channel, you can make privacy-enabled Group Call, Private Call, and All Call on that channel. Only target radios with the same Privacy Key, or the

same Key Value and Key ID as your radio will be able to unscramble the transmission.

See [Privacy](#) on page 121 for more information.

Additionally, Contacts menu allows you to assign each entry to a programmable number key or more on a keypad. If an entry is assigned to a number key, your radio can perform a quick dial on the entry.

Your radio supports maximum of 1000 Contact list entries.

Each entry within Contacts displays the following information:

- Call Type
- Call Alias
- Call ID



Note:

You can add or edit subscriber IDs for the Digital Contacts list.

Making a Group Call from Contacts

- 1 to access the menu.

- 2 or to **Contacts** and press to select.
The entries are alphabetically sorted.

- 3 or to the required group alias or ID.

- 4 Hold the radio vertically 1 to 2 inches (2.5 to 5.0 cm) from your mouth.

- 5 Press the **PTT** button to make the call.
The LED lights up solid green. The first line displays the subscriber alias or ID. The second line displays **Private Call** and the Private Call icon

- 6 Wait for the Talk Permit Tone to finish (if enabled), and speak clearly into the microphone.

- 7 Release the **PTT** button to listen.
When any user in the group responds, the LED blinks green, the display shows the transmitting user's ID, the radio unmutes and the response sounds through the radio's speaker.

- 8 If the Channel Free Indication feature is enabled, you hear a short alert tone the moment the transmitting radio releases the **PTT** button,



indicating the channel is free for you to respond. Press the **PTT** button to respond.







If there is no voice activity for a predetermined period of time, the call ends.





-
- 9 You hear a short tone. The display shows `Call Ended`.
-

Making a Private Call from Contacts

- 1  to access the menu.

- 2  or  to `Contacts` and press  to select. The entries are alphabetically sorted.

- 3 Use one of the steps described next to select the required subscriber alias or ID:
 - select the subscriber alias or ID directly
 -  or  to the required subscriber alias or ID and press  to select.
 - use the `Manual Dial` menu
 -  or  to `Manual Dial` and press  to select.

-  or  to `Radio Number` and press  to select.
- If there was previously dialed ID, the ID appears along with a blinking cursor. Else, the first line of the display shows `Radio Number:`; the second line of the display shows a blinking cursor. Use the keypad to edit/enter the ID. Press  to select.

-
- 4 Hold the radio vertically 1 to 2 inches (2.5 to 5.0 cm) from your mouth.

 - 5 Press the **PTT** button to make the call. The LED lights up solid green. The first line displays the subscriber alias or ID. The second line displays `Private Call` and the `Private Call` icon.

 - 6 Wait for the Talk Permit Tone to finish (if enabled), and speak clearly into the microphone.

 - 7 Release the **PTT** button to listen. When the target radio responds, the LED blinks green and the display shows the transmitting

user's ID. the radio unmutes and the response sounds through the radio's speaker.



- 8 If the Channel Free Indication feature is enabled, you hear a short alert tone the moment the transmitting radio releases the **PTT** button, indicating the channel is free for you to respond. Press the **PTT** button to respond.

If there is no voice activity for a predetermined period of time, the call ends.











The display shows `Call Ended`.

Making a Phone Call from Contacts

- 1  to access the menu.

- 2  or  to `Contacts` and press  to select.
The entries are alphabetically sorted.

- 3 Use one of the steps described next to select the required subscriber alias or ID:
 - select the subscriber alias or ID directly

-  or  to the required subscriber alias or ID and press  to select.
- use the `Manual Dial` menu
 -  or  to `Manual Dial` and press  to select.
 -  or  to `Phone Number` and press  to select.
 - The first line of the display shows `Phone Number:` , the second line of the display shows a blinking cursor. Use the keypad to enter a telephone number, and press  to select the entered number.

If the entry selected is empty, a negative indicator tone sounds and the display shows `Phone Call Invalid #`.

When you press **PTT** button while in the `Phone Contacts` screen, a negative indicator tone sounds and the display shows `Press OK to Place Phone Call`.

- 4  or  to `Call Phone` and press  to select.

- 5 If the access code was not preconfigured in the Contacts list, the first line of the display shows `Access Code: .` The second line of the display shows a blinking cursor. Enter the access code and press  to proceed.

During channel access, press  to dismiss the call attempt and a negative indicator tone sounds. Your radio returns to the Call Phone screen.

The access code cannot be more than 10 characters.

The first line of the display shows `Calling`. The second line of the display shows the subscriber alias or ID, and the Phone Call icon.

If successful, the DTMF tone sounds. You hear the dialing tone of the telephone user. The first line of the display shows the subscriber alias or ID, and the RSSI icon. The second line of the display shows `Phone Call` and the Phone Call icon.

If unsuccessful, a tone sounds and the display shows `Phone Call Failed`. Your radio returns to the Access Code input screen. If the access code was preconfigured in the Contacts list, the radio

returns to the screen you were on prior to initiating the call.

- 6 Hold the radio vertically 1 to 2 inches (2.5 to 5.0 cm) from your mouth.

- 7 Do one of the following:

- Press the **PTT** button to talk and release it to listen.



Note:

The RSSI icon disappears during transmission.

To enter extra digits, if requested by the Phone Call, press any keypad key to begin the input of extra digits. The first line of the display shows `Extra Digits: .` The second line of the display shows a blinking cursor. Enter

the extra digits and press  to proceed. The DTMF tone sounds and the radio returns to the previous screen.

If the call ends while you are entering the extra digits requested by the Phone

- Call, your radio returns to the screen you were on prior to initiating the call.
- Press **One Touch Access** button.

**Note:**

The DTMF tone sounds.

If the entry for the **One Touch Access** button is empty, a negative indicator tone sounds.

During the call, when you press **One Touch Access** button with the deaccess code preconfigured or enter the deaccess code as the input for extra digits, your radio attempts to end the call.

-
- 8 Press  to end the call.

-
- 9 If deaccess code was not preconfigured in the Contacts list, the first line of the display shows De-Access Code: . The second line of the display shows a blinking cursor. Enter the deaccess code and press  to proceed.
The deaccess code cannot be more than 10 characters.

The DTMF tone sounds and the display shows Ending Phone Call.

If successful, a tone sounds and the display shows Phone Call Ended. Your radio returns to the Call Phone screen.

If unsuccessful, your radio returns to the Phone Call screen. Repeat Steps 8 and 9 or wait for the telephone user to end the call.

When the telephone user ends the call, a tone sounds and the display shows Phone Call Ended.

Making a Call Alias Search

You can also use alias or alphanumeric search to retrieve the required subscriber alias.

This feature is only applicable while in Contacts.



**Note:**

Press  button or  to exit alias search.

If you release the **PTT** button while the radio is setting up the call, it exits without any indication and returns to the previous screen.





Your radio may be programmed to perform a radio presence check prior to setting up the Private Call. If the target radio is not available, you hear a short tone and see negative mini notice on the display.

- 1  to access the menu.

- 2  or  to **Contacts** and press  to select. The entries are alphabetically sorted.

- 3 Key in the first character of the required alias. A blinking cursor appears.

- 4 Use the keypad to type the required alias.

Press  to move one space to the left. Press  to move one space to the right. Press the  key to delete any unwanted characters. Long press  to change text entry method.

The first line of the display shows the characters you keyed in. The next lines of the display show the short listed search results. The alias search is case-insensitive. If there are two or more entries

with the same name, the radio displays the entry that is listed first in the Contacts list.

- 5 Hold the radio vertically 1 to 2 inches (2.5 to 5.0 cm) from your mouth.

- 6 Press the **PTT** button to make the call. The LED lights up solid green. The display shows the destination alias.

- 7 Wait for the Talk Permit Tone to finish (if enabled), and speak clearly into the microphone.

- 8 Release the **PTT** button to listen.

When the target radio responds, the LED blinks green, the radio unmutes and the response sounds through the radio's speaker.

- 9 If the Channel Free Indication feature is enabled, you hear a short alert tone the moment the transmitting radio releases the **PTT** button, indicating the channel is free for you to respond. Press the **PTT** button to respond.

If there is no voice activity for a predetermined period of time, the call ends.

The display shows **Call Ended**.

Making a Group, Private, Phone or All Call by Alias Search

You can also use alias or alphanumeric search to retrieve the required subscriber alias.

This feature is only applicable while in Contacts.







Note:

Press  button or  to exit alias search.

If you release the **PTT** button while the radio is setting up the call, it exits without any indication and returns to the previous screen.



Your radio may be programmed to perform a radio presence check prior to setting up the Private Call. If the target radio is not available, you hear a short tone and see *Party Not Available* on the display; the radio returns to the menu prior to initiating the radio presence check.

- 1  to access the menu.



- 2  or  to *Contacts* and press  to select.
The entries are alphabetically sorted.

- 3 Key in the first character of the required alias.
A blinking cursor appears.

- 4 Use the keypad to type the required alias.

Press  to move one space to the left. Press  to move one space to the right. Press the  key to delete any unwanted characters.

The first line of the display shows the characters you keyed in. The second line of the display shows an alias that matches what you have keyed in. The alias search is case-insensitive. If there are two or more entries with the same name, the radio displays the entry that is listed first in the Contacts list.

- 5  or  to scroll to desired entry, if necessary.

- 6 Hold the radio vertically 1 to 2 inches (2.5 to 5.0 cm) from your mouth.

- 7 Press the **PTT** button to make the call.
The LED lights up solid green. The first line displays the target radio's ID. The second line displays the call type and the Call icon.

8 Wait for the Talk Permit Tone to finish (if enabled) and speak clearly into the microphone.

9 Release the **PTT** button to listen.
When the target radio responds, the LED blinks green.

10 If the Channel Free Indication feature is enabled, you will hear a short alert tone the moment the target radio releases the **PTT** button, indicating the channel is free for you to respond. Press the **PTT** button to respond.

If there is no voice activity for a programmed period of time, the call ends.

You hear a short tone. The display shows `Call Ended`.

Assigning an Entry to a Programmable Number Key



Note:

See *Making a Group, Private or All Call with the Programmable Number Key* on page 57 for details on making a Group, Private or All Call with the programmed number key(s).

1 to access the menu.

2 or to `Contacts` and press to select.
The entries are alphabetically sorted.

3 or to the required alias or ID and press to select.

4 or to `Program Key` and press to select.

5 or to the desired number key and press to select.

If the number key is currently assigned to another entry, the display shows `The Key is Already Assigned` and then, the first line of the display shows `Overwrite?`. Do one of the following.

- or to `Yes` and press to overwrite the number key assignment.
- or to `No` and press to return to the previous step.

Each entry can be associated to different number keys. You see a ✓ before each number key that is assigned to an entry. If the ✓ is before *Empty*, that number key is not assigned.



If a number key is assigned to an entry in a particular mode, this feature is not supported when you long press the number key in another mode.







The radio sounds a positive indicator tone and the display shows *Contact Saved*.









The screen automatically returns to the previous menu.

Removing the Association between Entry and Programmable Number Key

- 1 Access the required alias or ID via:

| Radio Control | Steps |
|-----------------------|--|
| Programmed number key | Long press the programmed number key to the required alias or ID; press  to select. |
| Menu | 1  to access the menu. |

| Radio Control | Steps |
|---------------|---|
| | 2  or  to <i>Contacts</i> and press  to select. The entries are alphabetically sorted. |
| | 3  or  to the required subscriber alias or ID and press  to select. |

- 2  or  to *Program Key* and press  to select.
- 3  or  to *Empty* and press  to select. The first line of the display shows *Clear from all keys? .*
- 4  or  to *Yes* and press  to select.



Note:



When an entry is deleted, the association between the entry and its programmed number key(s) is removed.



The radio sounds a positive indicator tone and the display shows `Contact Saved`.



The screen automatically returns to the previous menu.

Adding a New Contact

- 1  to access the menu.



- 2  or  to `Contacts` and press  to select.

- 3  or  to `New Contact` and press  to select.

- 4  or  to the required contact type, either `Radio Contact` or `Phone Contact`, and press  to select.



- 5 Use the keypad to enter the contact number and press  to confirm.



- 6 Use the keypad to enter the contact name and press  to confirm.



- 7 If adding a Radio Contact,  or  to the required ringer type and press  to select. The radio sounds a positive indicator tone and the display shows positive mini notice.



Sending a Message to a Contact

- 1  to access the menu.

- 2  or  to `Contacts` and press  to select.

- 3  or  to `New Contact` and press  to select.

- 4  or  to the required contact type, either `Radio Contact` or `Phone Contact`, and press  to select.

- 5  or  to the required alias and press  to select.

6 ▲ or ▼ to Send Message and press  to select.

7 Press  to send the message.

Call Indicator Settings

Activating and Deactivating Call Ringers for Call Alert

You can select, or turn on or off ringing tones for a received Call Alert.

1  to access the menu.

2 ▲ or ▼ to Utilities and press  to select.

3 ▲ or ▼ to Radio Settings and press  to select.

4 ▲ or ▼ to Tones/Alert and press  to select.

5 ▲ or ▼ to Call Ringers and press  to select.

6 ▲ or ▼ to Call Alert and press  to select.
The current tone is indicated by a ✓.

7 ▲ or ▼ to the required tone and press  to select.

You can also use ◀ or ▶ to change the selected option.

✓ appears beside selected tone.

Activating and Deactivating Call Ringers for Private Calls

You can turn on or off the ringing tones for a received Private Call.

1  to access the menu.

2 ▲ or ▼ to Utilities and press  to select.

3 ▲ or ▼ to Radio Settings and press  to select.

4 ▲ or ▼ to Tones/Alerts and press  to select.

5 ▲ or ▼ to Call Ringers and press  to select.

6 ▲ or ▼ to Private Call and press  to select.

You can also use ◀ or ▶ to change the selected option.

7 Press  to enable/disable the Private Call ringing tones.

The display shows ✓ beside Enabled, if Private Call ringing tones are enabled.

The ✓ disappears from beside Enabled, if Private Call ringing tones are disabled.

Activating and Deactivating Call Ringers for Text Message

You can turn on or off the ringing tones for a received Text Message.

1  to access the menu.

2 ▲ or ▼ to Utilities and press  to select.

3 ▲ or ▼ to Radio Settings and press  to select.

4 ▲ or ▼ to Tones/Alerts and press  to select.

5 ▲ or ▼ to Call Ringers and press  to select.

6 ▲ or ▼ to Text Message and press  to select.

The current tone is indicated by a ✓.

- 7 ▲ or ▼ to the required tone and press  to select.
✓ appears beside selected tone.

Activating and Deactivating Call Ringers for Telemetry Status with Text

You can turn on or off the ringing tones for a received Telemetry Status with Text.

- 1  to access the menu.

- 2 ▲ or ▼ to `Utilities` and press  to select.



- 3 ▲ or ▼ to `Radio Settings` and press  to select.

- 4 ▲ or ▼ to `Tones/Alerts` and press  to select.

- 5 ▲ or ▼ to `Call Ringers` and press  to select.

- 6 ▲ or ▼ to `Telemetry` and press  to select.

The current tone is indicated by a ✓.

- 7 Do one of the following:
 - ▲ or ▼ to the preferred tone and press  to select. The display shows `Tone <Number> Selected` and a ✓ appears left of the selected tone.
 - ▲ or ▼ to `Turn Off` and press  to select. The display shows `Telemetry Ringer Off` and a ✓ appears left of `Turn Off`.

Assigning Ring Styles

You can program your radio to sound one of ten predefined ringing tones when receiving a Call Alert or a Text Message from a particular contact.

The radio sounds out each ring style as you navigate through the list.

- 1  to access the menu.

- 2 ▲ or ▼ to `Contacts` and press  to select.
The entries are alphabetically sorted.

3 ▲ or ▼ to the required alias or ID and press  to select.

4 ▲ or ▼ to View/Edit and press  to select.

5 ▲ or ▼ to Ringer and press  to select.

6 ▲ or ▼ to required ring style and press  to select.
A ✓ indicates the current selected tone.

7 ▲ or ▼ to the required tone and press  to select. ✓ appears beside selected tone.
The display shows Contact Saved.

All Tones

1  to access the menu.

2 ▲ or ▼ to Utilities and press  to select.

3 Go to Radio Settings. Select Tones/Alerts. Select All Tones. Toggle All Tones to be enabled or disabled.

Selecting a Ring Alert Type



Note:

The programmed **Ring Alert Type** button is assigned via CPS. Check with your dealer or system administrator to determine how your radio has been programmed.







You can program the radio calls to one predetermined vibrate call. If All Tones status is disabled, the radio displays the All Tone Mute icon.

If All Tones status is enabled, the related ring alert type is displayed.

The radio sounds one vibration if it is a momentary ring style. The radio vibrates repetitively if it is a repetitive ring style. When set to Ring and Vibrate, the radio sounds a specific ring tone if there is any incoming radio transaction (for example, Call Alert or Message). It sounds like a good key tone or missed call. If the notification list is not empty, the radio repeats a vibration every 5 minutes.

You can select a Ring Alert Type by performing one of the following actions.

- Press the programmed **Ring Alert Type** button to access the Ring Alert Type menu.
 - a) Press ▲ or ▼ to Ring, Vibrate, Ring & Vibrate or Silent and press  to select.

- Access this feature via the menu.
 - a) Press  to access the menu.
 - b) Press ▲ or ▼ to Utilities and press  to select.
 - c) Press ▲ or ▼ to Radio Settings and press  to select.
 - d) Press ▲ or ▼ to Tones/Alerts and press  to select.
 - e) Press ▲ or ▼ to Ring Alert Type and press  to select.
 - f) Press ▲ or ▼ to Ring, Vibrate, Ring & Vibrate or Silent and press  to select.

Configuring Vibrate Style









Note:

The programmed **Vibrate Style** button is assigned via CPS. Check with your dealer or system administrator to determine how your radio has been programmed.

You can configure the vibrate style by performing one of the following actions.

- Press the programmed **Vibrate Style** button to access the Vibrate Style menu.
 - a) Press ▲ or ▼ to Short, Medium, or Long and press  to select.

- Access this feature via the menu.
 - a) Press  to access the menu.
 - b) Press ▲ or ▼ to Utilities and press  to select.
 - c) Press ▲ or ▼ to Radio Settings and press  to select.
 - d) Press ▲ or ▼ to Tones/Alerts and press  to select.

- e) Press ▲ or ▼ to Vibrate Style and press  to select.
- f) Press ▲ or ▼ to Short, Medium, or Long and press  to select.

Escalating Alarm Tone Volume

You can program your radio to continually alert you when a radio call remains unanswered. This is done by automatically increasing the alarm tone volume over time. This feature is known as Escalart.

Call Log Features



Your radio keeps track of all recent outgoing, answered, and missed Private Calls. Use the call log feature to view and manage recent calls.

You can perform the following tasks in each of your call lists:

- Store ID to Contacts
- Delete
- View Details

Viewing Recent Calls



The lists are Missed, Answered, and Outgoing.

- 1  to access the menu.
- 2 ▲ or ▼ to Call Log and press  to select.
- 3 ▲ or ▼ to preferred list and press  to select. The display shows the most recent entry at the top of the list.
- 4 ▲ or ▼ to view the list.
Press the **PTT** button to start a Private Call with the current selected alias or ID.

Missed Call Screen

Whenever a call is missed, your radio displays a missed call message in the notification list. The display shows Missed Calls.



Do one of the following:



- Press  to view the missed call ID. The missed call log list appears on display.
- Press  to store or delete the entry.





Storing an Alias from a Call List

You can also store an ID without an alias.

- 1  to access the menu.



- 2  or  to Call Log and press  to select.



- 3  or  to the required list and press  to select.

- 4  or  to Store and press  to select.
A blinking cursor appears. If needed, key in the alias for that ID and press . The display shows positive mini notice.



Deleting a Call from a Call List



- 1  to access the menu.

- 2  or  to Call Log and press  to select.





- 3  or  to the required list and press  to select.

When you select a call list and it contains no entries, the display shows *List Empty*, and sounds a low tone if Keypad Tones are turned on (see [Turning Keypad Tones On or Off](#) on page 144).

- 4  or  to the required alias or ID and press  to select.



- 5  or  to Delete Entry? and press  to select.



- 6 Do one of the following:



- Press  to select Yes to delete the entry. The display shows *Entry Deleted*.
-  or  to No, and press the  button to return to the previous screen.



Viewing Details from a Call List

- 1  to access the menu.

- 2  or  to Call Log and press  to select.

- 3  or  to the required list and press  to select.

- 4  or  to the required alias or ID and press  to select.

- 5  or  to View Details and press  to select.
Display shows details.

Call Alert Operation

Call Alert paging enables you to alert a specific radio user to call you back when they are able to do so.

This feature is applicable for subscriber aliases or IDs only and is accessible through the menu via Contacts or manual dial.

Receiving and Responding to a Call Alert

When you receive a Call Alert page, you see the notification list listing a Call Alert with the alias or ID of the calling radio on the display.

When you hear a repetitive tone and the LED blinks yellow, do one of the following:



- Press the **PTT** button while the display still shows the Call Alert in the Notification List to respond with a Private Call.
- Press  to exit the Notification List. The alert is moved to the Missed Call Log.





See [Notification List](#) on page 138 for details about the Notification List.

See [Call Log Features](#) on page 91 for details about the Missed Call List.

Making a Call Alert from the Contact List

- 1  to access the menu.

- 2  or  to Contacts and press  to select.

- 3 Use one of the steps described next to select the required subscriber alias or ID:
- select the subscriber alias or ID directly
 - ▲ or ▼ to the required subscriber alias or ID and press  to select.
 - use the Manual Dial menu
 - ▲ or ▼ to Manual Dial and press  to select.
 - ▲ or ▼ to Radio Contact and press  to select.
 - The first line of the display shows Radio Number: , the second line of the display shows a blinking cursor. Enter the subscriber ID you want to page and press .

- 4 ▲ or ▼ to Call Alert and press  to select.
- The display shows Call Alert and the subscriber alias or ID, indicating that the Call Alert has been sent.

The LED lights up solid green when your radio is sending the Call Alert.

If the Call Alert acknowledgement is received, the display shows positive mini notice.

If the Call Alert acknowledgement is not received, the display shows negative mini notice.

Making a Call Alert with the One Touch Access Button

Press the programmed **One Touch Access** button to make a Call Alert to the predefined alias or ID.

The display shows Call Alert and the subscriber alias or ID, indicating that the Call Alert has been sent.

The LED lights up solid green when your radio is sending the Call Alert.

If the Call Alert acknowledgement is received, the display shows positive mini notice.

If the Call Alert acknowledgement is not received, the display shows negative mini notice.

Emergency Operation

An Emergency Alarm is used to indicate a critical situation. You are able to initiate an Emergency at any time on any screen display even when there is activity on the current channel.

Your dealer can set the duration of a button press for the programmed **Emergency** button, except for long press, which is similar with all other buttons:

Short press Between 0.05 seconds and 0.75 seconds.

Long press Between 1.00 second and 3.75 seconds.

The **Emergency** button is assigned with the Emergency On/Off feature. Check with your dealer for the assigned operation of the **Emergency** button.



Note:

If the short press for the **Emergency** button is assigned to turn on the Emergency mode, then the long press for the **Emergency** button is assigned to exit the Emergency mode.

If the long press for the **Emergency** button is assigned to turn on the Emergency mode,

then the short press for the **Emergency** button is assigned to exit the Emergency mode.

Your radio supports **three** Emergency Alarms:

- Emergency Alarm
- Emergency Alarm with Call
- Emergency Alarm with Voice to Follow



Note:









Only one of the Emergency Alarms above can be assigned to the programmed **Emergency** button.

In addition, each alarm has the following types:



- **Regular** – Radio transmits an alarm signal and shows audio and/or visual indicators.
- **Silent** – Radio transmits an alarm signal without any audio or visual indicators. Radio receives calls without any sound through the radio's speaker, until you press the **PTT** button to initiate the call.
- **Silent with Voice** – Radio transmits an alarm signal without any audio or visual indicators, but allow incoming calls to sound through the radio's speaker.

Receiving an Emergency Alarm

On receiving an emergency alarm the emergency icon appears, a tone sounds, the LED blinks red and the radio displays the emergency caller alias. If more than one alarm has occurred all emergency caller aliases are displayed in an Alarm List.

- 1 When receiving an emergency alarm, do one of the following:
 - If a single emergency call alias is displayed, press  to view more details. Press  again to view your action details.
 - If the multiple emergency caller aliases are displayed in the Alarm List,  or  to the required alias and press  to view more details. Press  again to view your action items.
-
- 2 Press  and select Yes to exit the Alarm List.
To revisit the Alarm List, press  to access the menu and select Alarm List.
-

Responding to an Emergency Alarm

- 1 In the Alarm List,  or  to the required alias.
-
- 2 Hold the radio vertically 1 to 2 inches (2.5 to 5.0 cm) from your mouth.
If the Channel Free Indication feature is enabled, you will hear a short alert tone the moment the transmitting radio releases the **PTT** button, indicating the channel is now available for use.
-
- 3 Press **PTT** button to transmit non-emergency voice to the same group that the Emergency Alarm was targeted to.
Emergency voice can only be transmitted by the emergency initiating radio. All other radios (including the emergency receiving radio) transmit non-emergency voice.
The LED lights up solid green. Your radio remains in the Emergency mode.
-
- 4 Wait for the Talk Permit Tone to finish (if enabled) and speak clearly into the microphone.
-
- 5 Release the **PTT** button to listen.

When the emergency initiating radio responds, the LED blinks green, the LED blinks green, the radio unmutes and the response sounds through the radio's speaker. You see the Group Call icon, the group ID, and transmitting radio ID on your display.

6 Your radio displays the Alarm List.

Exiting Emergency Mode After Receiving the Emergency Alarm

Exit the Emergency mode by performing one of the following actions:

- Delete the alarm items, see [Deleting an Alarm Item from the Alarm List](#) for more information.
- Power down the radio.

Sending an Emergency Alarm

This feature allows you to send an Emergency Alarm, a non-voice signal, which triggers an alert indication on a group of radios.

If your radio is set to Silent, it does not display any audio or visual indicators during Emergency mode.

Press the programmed **Emergency On** button.

The display shows Tx Alarm and the destination alias. The LED lights up solid green and the Emergency icon appears on the Home screen display.

When an Emergency Alarm acknowledgement is received, the Emergency tone sounds and the LED blinks green. The display shows Alarm Sent.

If your radio does not receive an Emergency Alarm acknowledgement, and after all retries have been exhausted, a tone sounds and the display shows Alarm Failed.

Radio exits the Emergency Alarm mode and returns to the Home screen.

Sending an Emergency Alarm with Call

This feature allows you to send an Emergency Alarm to a group of radios. Upon acknowledgement by a radio within the group, the group of radios can communicate over a programmed Emergency channel.

If your radio is set to Silent, it does not display any audio or visual indicators during Emergency mode, or allow any received calls to sound through the speaker

of the radio, until you press the **PTT** button to initiate the call.

If your radio is set to Silent with Voice, it does not display any audio or visual indicators during Emergency mode, but allow incoming calls to sound through the speaker of the radio. The indicators only appear once you press the **PTT** button to initiate, or respond to, the call.

1 Press the programmed **Emergency On** button.

The display shows `Sending Alarm`, which alternates with your radio ID, `Tx Alarm` and the destination alias. The LED lights up solid green and the Emergency icon appears on the Home screen display.

When an Emergency Alarm acknowledgement is received, the Emergency tone sounds and the LED blinks green. The display shows `Alarm Sent`.

2 Hold the radio vertically 1 to 2 inches (2.5 to 5.0 cm) from your mouth.

3 Press **PTT** button to make the call.
The LED lights up solid green and the Group icon appears on the display.

4 Wait for the Talk Permit Tone to finish (if enabled) and speak clearly into the microphone.

5 Release the **PTT** button to listen.
If the Channel Free Indication feature is enabled, you hear a short alert tone the moment the transmitting radio releases the **PTT** button, indicating the channel is free for you to respond.

6 Press the **PTT** button to respond.

7 Once your call ends, press **Emergency Off** button to exit the Emergency mode.

Sending an Emergency Alarm with Voice to Follow

This feature allows you to send an Emergency Alarm to a group of radios. The microphone of your radio is automatically activated, allowing you to communicate with the group of radios without pressing the **PTT** button.

This activated microphone state is also known as “hot mic”.

If your radio has Emergency Cycle Mode enabled, repetitions of hot mic and receiving period are made for a programmed duration. During Emergency Cycle

Mode, received calls sound through the speaker of the radio.

If you press the **PTT** button during the programmed receiving period, you hear a prohibit tone, indicating that you should release the **PTT** button. The radio ignores the **PTT** press and remains in Emergency mode.



Note:

If you press the **PTT** button during hot mic, and continue to press it after the hot mic duration expires, the radio continues to transmit until you release the **PTT** button.

If your radio is set to Silent, it does not display any audio or visual indicators during Emergency mode, or allow any received calls to sound through the speaker of the radio, until the programmed hot mic transmission period is over, and you press the **PTT** button.

If your radio is set to Silent with Voice, it does not display any audio or visual indicators during Emergency mode when you are making the call with hot mic, but allow sound through the speaker of the radio when the target radio responds after the programmed hot mic transmission period is over. The

indicators only appear when you press the **PTT** button.



Note:

If the Emergency Alarm request fails, the radio does not retry to send the request, and enters the hot mic state directly.

- 1 Press the programmed **Emergency On** button. The display shows Tx Alarm and the destination alias. The LED lights up solid green and the Emergency icon is displayed.

- 2 Once the display shows Alarm Sent, speak clearly into the microphone. When hot mic has been enabled, the radio automatically transmits without a **PTT** button press until the hot mic duration expires. While transmitting, the LED lights up solid green and the Emergency icon appears on the display.

- 3 The radio automatically stops transmitting when the cycling duration between hot mic and receiving calls expires, if Emergency Cycle Mode is enabled.

- Once the hot mic duration expires, the radio automatically stops transmitting. To transmit again, press the **PTT** button.

Reinitiating an Emergency Mode

**Note:**

This feature is only applicable to the radio sending the Emergency Alarm.

There are two instances where this can happen:

- You change the channel while the radio is in Emergency mode. This exits the Emergency mode. If Emergency Alarm is enabled on this new channel, the radio reinitiates Emergency.
- You press the programmed **Emergency On** button during an Emergency initiation/transmission state. This causes the radio to exit this state, and to reinitiate Emergency.

Exiting Emergency Mode After Sending the Emergency Alarm

Your radio exits Emergency mode when one of the following occurs:

- Emergency Alarm acknowledgement is received (for **Emergency Alarm** only).

- All retries to send the alarm have been exhausted.
- The **Emergency Off** button is pressed.

**Note:**

If your radio is powered off, it exits the Emergency mode. The radio will not reinitiate the Emergency mode automatically when it is turned on again.

If you change channels when your radio is in Emergency mode to a channel that has no emergency system configured, **No Emergency** is shown on your display.

Man Down

**Note:**

This feature is applicable to SL7550e/SL7590e/SL7580e only.

This feature prompts an emergency to be raised if there is a change in the motion of the radio, such as the tilt of the radio, motion and/or the lack of motion for a predefined time.

Following a change in the motion of the radio for a programmed duration, the radio pre-warns the user via an audio indicator indicating that a change in motion is detected.

If there is still no acknowledgment by the user before the predefined reminder timer expires, the radio initiates an Emergency Alarm or an Emergency Call. You can program the reminder timer via CPS.

Turning the Man Down Feature On or Off



Note:

This feature is applicable to SL7550e/SL7590e/SL7580e only. The programmed **Man Down** button and Man Down settings are assigned via CPS. Check with your dealer or system administrator to determine how your radio has been programmed.

If you disable the Man Down feature, the programmed alert tone sounds repeatedly until the Man Down feature is enabled. A device failure tone sounds when the Man Down feature fails while powering up. The device failure tone continues until the radio resumes normal operation.

If you enable Man Down to maximum sensitivity and set Vibrate Style to high, the radio automatically restricts Vibrate Style to medium. This function prevents high Vibrate

Style from initiating the Man Down emergency feature.

You can enable or disable this feature by performing one of the following actions.

- Press the programmed **Man Down** button to toggle the feature on or off.
-
- Access this feature via the menu.
 - a) Press to access the menu.
 - b) Press or to Utilities and press to select.
 - c) Press or to Radio Settings and press to select.
 - d) Press or to Man Down and press to select.

You can also use or to change the selected option.

- e) Press to enable or disable Man Down. This display shows beside Enabled.

The disappears beside Enabled.

Text Message Features

Your radio is able to receive data, for example a text message, from another radio or an e-mail application.

The **maximum** length of characters for sending a text message, including the subject line (seen when receiving message from an e-mail application), depends on CPS configuration which can be configured up to maximum 280 characters. Your radio can receive a text message with **maximum** length of 280 characters.

If user forwards a text message with characters more than the **maximum** length, the text message will be truncated to the **maximum** length.









Note:



Long press  at any time to return to the Home screen.



Writing and Sending a Text Message









- 1 Access the **Text Message** feature.

| Radio Con- trols | Steps |
|--------------------------------------|--|
| Programmed Text Message button | Press the programmed Text Message button. |
| Menu | <ol style="list-style-type: none"> 1  to access the menu. 2  or  to Messages and press  to select. |

- 2  or  to **Compose** and press  to select. A blinking cursor appears.
- 3 Use the keypad to type your message.

Press  to move one space to the left. Press  or the  key to move one space to the right.

Press the  key to delete any unwanted characters. Long press  to change text entry method.

- 4 Press  once message is composed.
-
- 5 Depending on whether you want to send, save, re-edit, or delete the newly composed message, do one of the following.
-  or  to **Send**, and press  to send the message.
 -  or  to **Save**, and press  to save the message to the Drafts folder.
 -  to edit the message.
 -  again to choose between deleting the message or saving it to the Drafts folder.

The display shows transitional mini notice, confirming your message is being sent.

If the message is sent successfully, a tone sounds and the display shows positive mini notice.

If the message cannot be sent, a low tone sounds and the display shows negative mini notice.





If the text message fails to send, the radio returns you to the **Resend** option screen (see [Managing Fail-to-Send Text Messages](#) on page 107).



Sending a Quick Text Message

Your radio supports a maximum of 50 Quick Text messages as programmed by your dealer.

While Quick Text messages are predefined, you can edit each message before sending it.

- 1 Access the **Text Message** feature.



| Radio Con- trols | Steps |
|--------------------------------|--|
| Programmed Text Message button | Press the programmed Text Message button. |
| Menu | <p>1  to access the menu.</p> <p>2  or  to Messages and press  to select.</p> |

- 2  or  to **Quick Text** and press  to select.

3 ▲ or ▼ to the required Quick Text and press  to select.



4 Use the keypad to edit the message, if required.

Press ◀ to move one space to the left. Press ▶ or the  key to move one space to the right.

Press the  key to delete any unwanted characters. Long press  to change the text entry method.



5 Press  once message is composed.

6 Depending on whether you want to send, save, re-edit, or delete the newly composed message, do one of the following.

- ▲ or ▼ to Send, and press  to send the message.
- ▲ or ▼ to Save, and press  to save the message to the Drafts folder.
-  to edit the message.

-  again to choose between deleting the message or saving it to the Drafts folder.

7 If you are sending the message, select the recipient by

- ▲ or ▼ to the required alias or ID and press  to select.
- ▲ or ▼ to Manual Dial, and press  to select. The first line of the display shows Radio Number: . The second line of the display shows a blinking cursor. Key in the subscriber alias or ID and press .

The display shows , the transitional mini notice, confirming your message is being sent.

If the message is sent successfully, a tone sounds and the display shows the positive mini notice.

If the message cannot be sent, a low tone sounds and the display shows the negative mini notice.

Sending a Quick Text Message with the One Touch Access Button

Press the programmed **One Touch Access** button to send a predefined Quick Text message to a predefined alias or ID.

The display shows the transitional mini notice, confirming your message is being sent.

If the message is sent, a tone sounds and the display shows the positive mini notice.

If the message cannot be sent, a low tone sounds and the display shows the negative mini notice.

If the text message fails to send, the radio returns you to the **Resend** option screen (see [Managing Fail-to-Send Text Messages](#) on page 107).

Accessing the Drafts Folder

You can save a text message to send it at a later time.

If a **PTT** button press or a mode change causes the radio to exit the text message writing/editing screen while you are in the process of writing or editing a text message, your current text message is automatically saved to the Drafts folder.

The most recent saved text message is always added to the top of the Drafts list.

The Drafts folder stores a maximum of ten (10) last saved messages. When the folder is full, the next saved text message automatically replaces the oldest text message in the folder.







Note:

Long press  at any time to return to the Home screen.

Viewing a Saved Text Message

- 1 Access the **Text Message** feature.

| Radio Con- trols | Steps |
|--------------------------------|--|
| Programmed Text Message button | Press the programmed Text Message button. |
| Menu | <ol style="list-style-type: none"> 1  to access the menu. 2  or  to Messages and press  to select. |

2 ▲ or ▼ to Drafts and press  to select.



3 ▲ or ▼ to the required message and press  to select.

Editing and Sending a Saved Text Message

1 Press  again while viewing the message.

2 ▲ or ▼ to Edit and press  to select. A blinking cursor appears.



3 Use the keypad to type your message.

Press  to move one space to the left. Press  or the  key to move one space to the right.

Press the  key to delete any unwanted characters. Long press  to change text entry method.

4 Press  once message is composed.

5 Select the message recipient by

- ▲ or ▼ to the required alias or ID and press  to select.
- ▲ or ▼ to Manual Dial, and press  to select. The first line of the display shows Radio Number#. The second line of the display shows a blinking cursor. Key in the subscriber alias or ID and press .

The display shows transitional mini notice, confirming your message is being sent.





If the message is sent successfully, a tone sounds and the display shows positive mini notice.



If the message cannot be sent, a low tone sounds and the display shows negative mini notice.



If the text message cannot be sent, it is moved to the Sent Items folder and marked with a Send Failed icon.

Deleting a Saved Text Message from Drafts



1 Access the **Text Message** feature.

| Radio Controls | Steps |
|--------------------------------|--|
| Programmed Text Message button | Press the programmed Text Message button. |
| Menu | <ol style="list-style-type: none"> 1  to access the menu. 2  or  to Messages and press  to select. |

2  or  to Drafts and press  to select.

3  or  to the required message and press  to select.

4 Press  again while viewing the message.

5  or  to Delete and press  to delete the text message.

Managing Fail-to-Send Text Messages

You can select one of the following options while at the Resend option screen:

- Resend
- Forward
- Edit



Note:

If the channel type (i.e. conventional digital or Capacity Plus or Linked Capacity Plus) is not a match, you can only edit and forward a Fail-to-Send message.

Resending a Text Message





Press  to resend the same message to the same subscriber/group alias or ID.

If the message is sent successfully, a tone sounds and the display shows the positive mini notice.

If the message cannot be sent, the display shows the negative mini notice.

Forwarding a Text Message

Select **Forward** to send the message to another subscriber/group alias or ID.

- 1 ▲ or ▼ to **Forward** and press  to select.
-
- 2 Select the message recipient by
 - ▲ or ▼ to the required alias or ID and press  to select.
 - ▲ or ▼ to **Manual Dial**, and press  to select. The first line of the display shows **Radio Number:**. The second line of the display shows a blinking cursor. Key in the subscriber alias or ID and press .

The display shows **Text Message:**
 <Subscriber/Group Alias or ID>, confirming your message is being sent.

If the message is sent successfully, a tone sounds and the display shows positive mini notice.

If the message cannot be sent, a low tone sounds and the display shows negative mini notice.

Editing a Text Message

Select **Edit** to edit the message before sending it.









Note:

If a subject line is present (for messages received from an e-mail application), you cannot edit it.



- 1 ▲ or ▼ to **Edit** and press  to select. A blinking cursor appears.
-
- 2 Use the keypad to edit your message.

Press ◀ to move one space to the left. Press ▶ or the  key to move one space to the right.

Press the  key to delete any unwanted characters. Long press  to change text entry method.
-
- 3 Press  once message is composed.
-
- 4 Depending on whether you want to send, save, re-edit, or delete the newly composed message, do one of the following.

- ▲ or ▼ to **Send**, and press  to send the message.
- ▲ or ▼ to **Save**, and press  to save the message to the Drafts folder.
-  to edit the message.
-  again to choose between deleting the message or saving it to the Drafts folder.

5 If you are sending the message, select the recipient by

- ▲ or ▼ to the required alias or ID and press  to select.
- ▲ or ▼ to **Manual Dial**, and press  to select. The first line of the display shows **Radio Number:1**. The second line of the display shows a blinking cursor. Key in the subscriber alias or ID and press .

The display shows **Text Message:**
 <Subscriber/Group Alias or ID>, confirming your message is being sent.

If the message is sent successfully, a tone sounds and the display shows positive mini notice.

If the message cannot be sent, a low tone sounds and the display shows negative mini notice.

Managing Sent Text Messages

Once a message is sent to another radio, it is saved in Sent Items. The most recent sent text message is always added to the top of the Sent Items list.

The Sent Items folder is capable of storing a maximum of thirty (30) last sent messages. When the folder is full, the next sent text message automatically replaces the oldest text message in the folder.







Note:



Long press  at any time to return to the Home screen.

Viewing a Sent Text Message

- 1** Access the **Text Message** feature by performing one of the following actions:

| Radio Controls | Steps |
|--------------------------------|--|
| Programmed Text Message button | Press the programmed Text Message button. |
| Menu | <ol style="list-style-type: none"> 1  to access the menu. 2  or  to Messages and press  to select. |

2  or  to Sent Items and press  to select.

3  or  to the required message and press  to select.

A subject line may be shown if the message is from an e-mail application.

The icon at the top right corner of the screen indicates the status of the message (see [Sent Item Icons](#) on page 40).

Sending a Sent Text Message

You can select one of the following options while viewing a sent text message:



- Resend
- Forward
- Edit
- Delete



Note:





If the channel type (i.e. conventional digital or Capacity Plus or Linked Capacity Plus) is not a match, you can only edit, forward, or delete a Sent message.

1 Press  again while viewing the message.

2  or  to one of the following options and press  to select.

| Option | Steps |
|---------|---|
| Forward | Select Forward to send the selected text message to another subscriber/group alias or ID (see Forwarding a Text Message on page 108). |

| Option | Steps |
|--------|--|
| Edit | Select Edit to edit the selected text message before sending it (see Editing a Text Message on page 108). |
| Delete | Select Delete to delete the text message. |
| Resend | <p>Select Resend to resend the selected text message to the same subscriber/group alias or ID.</p> <p>The display shows transitional mini notice, confirming that the same message is being sent to the same target radio.</p> <p>If the message is sent successfully, a tone sounds and the display shows positive mini notice.</p> <p>If the message cannot be sent, a low tone sounds and the display shows negative mini notice.</p> <p>If the message fails to send, the radio returns you to the Resend option screen.</p> |

| Option | Steps |
|--------|--|
| | <p>Press  to resend the message to the same subscriber/group alias or ID.</p> <p> Note: Changing the volume, and pressing any button, except for , , or , returns you to the message.</p> <p>The radio exits the Resend option screen if you press the PTT button to initiate a Private or Group Call, or to respond to a Group Call. The radio also exits the screen when it receives a text or telemetry message, an emergency call or alarm, or a call alert.</p> <p>The display returns to the Resend option screen if you press the PTT button to respond to a Private Call (except when the radio is displaying the Missed</p> |

| Option | Steps |
|--------|--|
| | Call screen), and at the end of an All Call. |

If you exit the message sending screen while the message is being sent, the radio updates the status of the message in the Sent Items folder without providing any indication in the display or via sound.

If the radio changes mode or powers down before the status of the message in Sent Items is updated, the radio cannot complete any In-Progress messages and automatically marks it with a Send Failed icon.

The radio supports a maximum of five (5) In-Progress messages at one time. During this period, the radio cannot send any new message and automatically marks it with a Send Failed icon.

Deleting All Sent Text Messages from Sent Items

- 1 Access the **Text Message** feature by performing one of the following actions:

| Radio Controls | Steps |
|--------------------------------|--|
| Programmed Text Message button | Press the programmed Text Message button. |
| Menu | <ol style="list-style-type: none"> 1  to access the menu. 2  or  to Messages and press  to select. |

- 2



 or  to Sent Items and press  to select.

When you select Sent Items and it contains no text messages, the display shows List Empty, and sounds a low tone if Keypad Tones are turned on (see [Turning Keypad Tones On or Off](#) on page 144).

- 3

 or  to Delete All and press  to select.

- 4 Choose one of the following.

- ▲ or ▼ to Yes and press  to select. The display shows positive mini notice.
- ▲ or ▼ to No and press  to return to the previous screen.

Receiving a Text Message

When your radio receives a message, the display shows the alias or ID of the sender and the Message icon at the far left of the screen.

You can select Read when receiving a text message.



Note:

The radio exits the Text Message alert screen and sets up a Private or Group Call to the sender of the message if the **PTT** button is pressed when the radio is displaying the alert screen.



Reading a Text Message

- 1 ▲ or ▼ to Read? and press  to select.

Selected message in the Inbox opens.

A subject line may be shown if the message is from an e-mail application.

- 2 Do one of the following:

- Press  to return to the Inbox.
 - Press  a second time to reply, forward, or delete the text message.
-

Managing Received Text Messages

Use the Inbox to manage your text messages. The Inbox is capable of storing a maximum of 30 messages.

Text messages in the Inbox are sorted according to the most recently received.

Your radio supports the following options for text messages:

- Reply
- Forward
- Delete
- Delete All



Note:



If the channel type (i.e. conventional digital or Capacity Plus or Linked Capacity Plus) is not a match, you can only forward, delete, or delete all Received messages.



**Note:**



Long press  at any time to return to the Home screen.



Viewing a Text Message from the Inbox

- 1  to access the menu.

- 2  or  to Messages and press  to select.



- 3  or  to Inbox and press  to select.



- 4  or  to view the messages.
A subject line may be shown if the message is from an e-mail application.



- 5 Do one of the following:
 - Press  to select the current message, and press  again to reply, quick reply, forward, or delete that message.
 - Long press  to return to the Home screen.

Viewing a Telemetry Status Text Message from the Inbox

- 1  to access the menu.

- 2  or  to Messages and press  to select.





- 3  or  to Inbox and press  to select.











- 4  or  to the required message and press  to select.
You cannot reply to a Telemetry Status text message.
The display shows Telemetry: <Status Text Message>.

- 5 Long press  to return to the Home screen.

Replying to a Text Message from the Inbox

- 1 Access the **Text Message** feature.

| Radio Controls | Steps |
|--------------------------------|--|
| Programmed Text Message button | Press the programmed Text Message button. |
| Menu | <ol style="list-style-type: none"> 1  to access the menu. 2  or  to Messages and press  to select. |

- 2  or  to Inbox and press  to select.
- 3  or  to the required message and press  to select.
A subject line may be shown if the message is from an e-mail application.
- 4 Press  once more to access the sub-menu.
- 5 Do one of the following:
 -  or  to Reply and press  to select.





-  or  to Quick Reply and press  to select.



A blinking cursor appears.



- 6 Use your keypad to write/edit your message.
- 7 Press  once message is composed.
The display shows transitional mini notice, confirming your message is being sent.
If the message is sent successfully, a tone sounds and the display shows positive mini notice.
If the message cannot be sent, a low tone sounds and the display shows negative mini notice.
If the message cannot be sent, the radio returns you to the Resend option screen (see [Managing Fail-to-Send Text Messages](#) on page 107).

Deleting a Text Message from the Inbox

- 1 Access the **Text Message** feature by performing one of the following actions:



| Radio Controls | Steps |
|--------------------------------|--|
| Programmed Text Message button | Press the programmed Text Message button. |
| Menu | <ol style="list-style-type: none"> 1  to access the menu. 2  or  to Messages and press  to select. |



2  or  to Inbox and press  to select.

3  or  to the required message and press  to select.

A subject line may be shown if the message is from an e-mail application.





4 Press  once more to access the sub-menu.



5  or  to Delete and press  to select.

6  or  to Yes and press  to select.
The display shows positive mini notice and the screen returns to the Inbox.

Deleting All Text Messages from the Inbox

1 Access the **Text Message** feature by performing one of the following actions:

| Radio Controls | Steps |
|--------------------------------|--|
| Programmed Text Message button | Press the programmed Text Message button. |
| Menu | <ol style="list-style-type: none"> 1  to access the menu. 2  or  to Messages and press  to select. |

2  or  to Inbox and press  to select.

When you select Inbox and it contains no text messages, the display shows *List Empty*, and sounds a low tone if Keypad Tones are turned on

(see [Turning Keypad Tones On or Off](#) on page 144).

3 ▲ or ▼ to Delete All and press  to select.

4 ▲ or ▼ to Yes and press  to select.
The display shows positive mini notice.

Job Tickets

Your radio is able to receive Job Tickets, which are messages from the dispatcher listing out tasks that need to be performed.

You can respond to Job Tickets in order to sort them into Job Ticket Folders. By default, the folders are "All", "New", "Started", and "Completed". Check with your dealer or system administrator for an additional 10 folders.

Your radio supports a maximum of 100 Job Tickets, all of which can be seen in the "All" folder. New Job Tickets and Job Tickets with recent change in state are listed first. Upon reaching the maximum number of Job Tickets, the next Job Ticket automatically replaces the last Job Ticket in your radio.





Note:













Job Tickets are retained even after radio is powered down and powered up again.

Your radio will automatically detect and discard the duplicated Job Tickets with the same subject line.

Accessing the Job Ticket Folder

Access the Job Ticket folder.



| Radio Control | Steps |
|------------------------------|--|
| Programmed Job Ticket button | 1 Press the programmed Job Ticket button. |
| | 2 ▲ or ▼ to the required folder and press  to select. |
| |  Note: You can also press  and the corresponding number key (1–9) to access the required folder. |

| Radio Control | Steps |
|---------------|---|
| Menu | <ol style="list-style-type: none"> 1  to access the menu. 2  or  to Job Tickets and press  to select. 3  or  to the required folder and press  to select. <p> Note: You can also press  and the corresponding number key (1–9) to access the required folder.</p> <ol style="list-style-type: none"> 4  or  to the required Job Ticket and press  to select. |

Logging In and Out of the Remote Server

This feature allows you to log in and log out of the remote server by using your user ID via the menu.

- 1  to access the menu.

- 2  or  to Log In and press  to select.
If you are already logged in, menu displays Log Out.

The display shows a transitional mini notice, confirming that you have been logged in successfully.

If you have failed to log in, the display shows a negative mini notice.

Creating and Sending a Job Ticket

Your radio is able to create Job Tickets, which is based on a Job Ticket template and send out tasks that need to be performed.



Note:





CPS is required to configure the Job Ticket template. Check with your dealer or system administrator to determine how your radio has been programmed.

- 1  to access the menu.

- 2 ▲ or ▼ to Job Tickets and press  to select.

- 3 ▲ or ▼ to Create Ticket and press  to select.

- 4 Depending on how your radio is configured, do one of the following:

| If | Then |
|---|--|
| If your radio is configured with one Job Ticket template, | <ol style="list-style-type: none"> 1 Use the keypad to type the required room number and press  to select. 2 ▲ or ▼ to Room Status and press  to select. 3 ▲ or ▼ to the required option and press  to select. |
| If your radio is configured with more than one | ▲ or ▼ to the required option and press  to select. |

| If | Then |
|----|----------------------|
| | Job Ticket template, |

- 5 ▲ or ▼ to Send and press  to select.

The display shows transitional mini notice, confirming your message is sent.

If the message is not sent, the display shows negative mini notice.

Responding to the Job Ticket

- 1  to access the menu.

- 2 ▲ or ▼ to Job Tickets and press  to select.

- 3 ▲ or ▼ to the required folder and press  to select.

You can also press the corresponding number key (1–9) to access the required folder.

4 ▲ or ▼ to the required Job Ticket and press  to select.

5 Press  once more to access the sub-menu.
You can also press the corresponding number key (1–9) to **Quick Reply**.

6 ▲ or ▼ to the required Job Ticket and press  to select.
You can also press the corresponding number key (1–9) to respond to the job ticket.







The display shows transitional mini notice, confirming your message being sent.







If the message is sent, a tone sounds and the display shows positive mini notice.

If the message is not sent, a low tone sounds and the display shows negative mini notice.

Deleting a Job Ticket

Delete a Job Ticket.

| Radio Control | Steps |
|---|---|
| Programmed Job Ticket button | 1 Press the programmed Job Ticket button. |
| | 2 ▲ or ▼ to All and press  to select. |
| Menu | 1  to access the menu. |
| | 2 ▲ or ▼ to Job Tickets and press  to select. |
| | 3 ▲ or ▼ to All and press  to select. |
| | 4 ▲ or ▼ to the required Job Ticket and press  to select. |
|  | Note: At Step 4, while viewing the Job Ticket, press  to delete. |

| Radio Control | Steps |
|---------------|--|
| | <p>5 Press  again while viewing the Job Ticket.</p> |
| | <p>6  or  to Delete and press  to select.</p> |
| | <p> Note: You can also press  to delete.</p> |

the radio is still able to receive clear (unscrambled) transmissions.

Your radio supports two types of privacy:

- Basic Privacy.
- Enhanced Privacy.

Only one of the privacy types above can be assigned to the radio.

To unscramble a privacy-enabled call or data transmission, your radio must be programmed to have the same Privacy Key (for Basic Privacy), or the same Key Value and Key ID (for Enhanced Privacy) as the transmitting radio.

If your radio receives a scrambled call that is of a different Privacy Key, or a different Key Value and Key ID, you will either hear a garbled transmission (Basic Privacy) or nothing at all (Enhanced Privacy).

If the radio has a privacy type assigned, the Home screen shows the Secure or Unsecure icon, except when the radio is sending or receiving an Emergency call or alarm.

The LED lights up solid green while the radio is transmitting and blinks green rapidly when the radio is receiving an ongoing privacy-enabled transmission.

Privacy

If enabled, this feature helps to prevent eavesdropping by unauthorized users on a channel by the use of a software-based scrambling solution. The signaling and user identification portions of a transmission are not scrambled.

Your radio must have privacy enabled on the channel to send a privacy-enabled transmission, although this is not a necessary requirement for receiving a transmission. While on a privacy-enabled channel,

You can access this feature by performing one of the following actions:

- Pressing the programmed **Privacy** button to toggle privacy on or off.
- Using the Radio Menu as described by the steps described next.









Note:

Some radio models may not offer this Privacy feature. Check with your dealer or system administrator for more information.



1 to access the menu.

2  or  to Utilities and press  to select.

3  or  to Radio Settings and press  to select.

4  or  to Privacy and press  to select.

You can also use   or   to change selected option.

- 5 Press  to enable/disable Privacy.
- The display shows  beside Enabled.
- The  disappears from beside Enabled.
-

Covert Mode

Your radio is capable of Covert Mode. During covert mode, all keypad and programmed button access are blocked. When enabled, all visual indications (display, LED's and backlight) are disabled.

This feature allows audio or tone only via a wired accessory or a Bluetooth accessory.

Entering Covert Mode

Press the  button followed by the 2, 5, and 8 numeric keys in tandem in home screen.

Exiting Covert Mode

To exit Covert Mode, do one of the following:

- Press the  button followed by the 2, 5, and 8 numeric keys in tandem. Radio will go back to normal mode.
- Power cycle the radio via the On/Off button.

See [IP Site Connect](#) on page 43 and [Linked Capacity Plus](#) on page 44 for more details about these configurations.





Starting an Automatic Site Search



Note:

The radio **only** scans for a new site if the current signal is weak or when the radio is unable to detect any signal from the current site. If the RSSI value is strong, the radio remains on the current site.

Start Automatic Site search by

| Radio Controls | Steps |
|--------------------------------|---|
| Site Lock On/Off button | Press the programmed Site Lock On/Off button to toggle the start/stop automatic site search. |
| Radio menu | <ol style="list-style-type: none"> 1  to access the menu. 2  or  to Utilities and press  to select. |

Dual Tone Multi Frequency (DTMF)



The Dual Tone Multi Frequency (DTMF) feature allows the radio to operate in a radio system with an interface to telephone systems.

- 1 Press and hold the **PTT** button to initiate a DTMF call.
- 2 Enter the desired number, * or #.

You can turn off the DTMF tone by disabling all radio tones and alerts (see [Turning the Radio Tones/Alerts On or Off](#) on page 148).

Multi-Site Controls

These features are applicable when your current radio channel is part of an IP Site Connect or Linked Capacity Plus configuration.

| Radio Controls | Steps |
|----------------|---|
| | 3 ▲ or ▼ to Radio Settings and press  to select. |
| | 4 ▲ or ▼ to Site Roaming and press  to select. |
| | 5 ▲ or ▼ to Site Lock and press  to select. |

If the current channel is a multi-site channel with an attached roam list and is out of range, the radio also performs an automatic site search (site is unlocked) during:

- a **PTT** button press.
- data transmission.





A tone sounds and the display shows Site Unlocked.

The radio then returns to the Home screen. The display shows the Site Roaming icon and channel alias.

The LED blinks yellow rapidly when the radio is actively searching for a new site, and turns off once the radio locks on to a site.

Stopping an Automatic Site Search

When your radio is actively searching for a new site, you can stop the search by

| Radio Controls | Steps |
|--------------------------------|---|
| Site Lock On/Off button | Press the programmed Site Lock On/Off button to toggle the start/stop automatic site search. |
| Radio menu | <ol style="list-style-type: none"> 1  to access the menu. 2 ▲ or ▼ to Utilities and press  to select. 3 ▲ or ▼ to Radio Settings and press  to select. 4 ▲ or ▼ to Site Roaming and press  to select. |

| Radio Controls | Steps |
|----------------|--|
| | 5 ▲ or ▼ to Site Lock and press  to select. |





A tone sounds and the display shows Site Locked.

The radio then returns to the Home screen. The LED turns off and the display shows the channel alias.

Starting a Manual Site Search

Start a Manual Site Search by

| Radio Controls | Steps |
|--------------------------------|---|
| Manual Site Roam button | Press the programmed Manual Site Roam button to start the manual site search. |
| Radio menu | 1  to access the menu. |

| Radio Controls | Steps |
|----------------|---|
| | 2 ▲ or ▼ to Utilities and press  to select. |
| | 3 ▲ or ▼ to Radio Settings and press  to select. |
| | 4 ▲ or ▼ to Site Roaming and press  to select. |
| | 5 ▲ or ▼ to Active Search and press  to select. |

A tone sounds, the display shows Finding Site, and the LED blinks green.

If a new site is found, a tone sounds and the LED turns off. The display shows Site <Alias> Found.

If there is no available site within range, a tone sounds and the LED turns off. The display shows Out of Range.

If a new site is within range, but the radio is unable to connect to it, a tone sounds and the LED turns off. The display shows `Channel Busy`.

The radio returns to the Home screen.

Security

You can enable or disable any radio in the system. For example, you might want to disable a stolen radio, to prevent the thief from using it, and enable that radio, when it is recovered.











Note:

Performing Radio Disable and Enable is limited to radios with these functions enabled. Check with your dealer or system administrator for more information.

Radio Disable

- 1 Access this feature by

| Radio Controls | Steps |
|-----------------------------|--|
| Radio Disable button | <ol style="list-style-type: none"> 1 Press the programmed Radio Disable button. 2 ▲ or ▼ to the required alias or ID and press  to select. |
| Radio menu | <ol style="list-style-type: none"> 1  to access the menu. 2 ▲ or ▼ to <code>Contacts</code> and press  to select. The entries are alphabetically sorted. 3 Use one of the steps described next to select the required subscriber alias or ID: <ul style="list-style-type: none"> • Select the required alias or ID directly. • ▲ or ▼ to the required alias or ID and press  to select. |

| Radio Controls | Steps |
|----------------|---|
| | <ul style="list-style-type: none"> Use the Manual Dial menu. <ul style="list-style-type: none"> ▲ or ▼ to Manual Dial and press  to select. ▲ or ▼ to Radio Number and press  to select. The first line of the display shows Radio Number: . The second line of the display shows a blinking cursor. Use the keypad to enter the subscriber alias or ID and press . |
| | <p>4 ▲ or ▼ to Radio Disable and press  to select.</p> |

The display shows Radio Enable: <Subscriber Alias or ID> and the LED lights up solid green.

2 Wait for acknowledgement.

If successful, the radio sounds a positive indicator tone and the display shows positive mini notice.











If not successful, the radio sounds a negative indicator tone and the display shows negative mini notice.







Do not press  during the Radio Disable operation as you will not get an acknowledgement message.

Radio Enable

1 Access this feature by

| Radio Controls | Steps |
|---------------------|---|
| Radio Enable button | 1 Press the programmed Radio Enable button. |
| | 2 ▲ or ▼ to the required alias or ID and press  to select. |

| Radio Controls | Steps |
|----------------|--|
| Radio menu | <ol style="list-style-type: none"> 1  to access the menu. 2  or  to <code>Contacts</code> and press  to select. The entries are alphabetically sorted. 3 Use one of the steps described next to select the required subscriber alias or ID <ul style="list-style-type: none"> • Select the required alias or ID directly. •  or  to the required alias or ID and press  to select. • Use the <code>Manual Dial</code> menu. <ul style="list-style-type: none"> •  or  to <code>Manual Dial</code> and press  to select. |

| Radio Controls | Steps |
|----------------|--|
| | <ul style="list-style-type: none"> •  or  to <code>Radio Number</code> and press  to select. • The first line of the display shows <code>Radio Number:.</code> The second line of the display shows a blinking cursor. Use the keypad to enter the subscriber alias or ID and press . <ol style="list-style-type: none"> 4  or  to <code>Radio Enable</code> and press  to select. |

The display shows `Radio Enable: <Subscriber Alias or ID>` and the LED lights up solid green.

2 Wait for acknowledgement.

If successful, the radio sounds a positive indicator tone and the display shows positive mini notice.

If not successful, the radio sounds a negative indicator tone and the display shows negative mini notice.

Do not press  during the Radio Enable operation as you will not get an acknowledgement message.

The radio remains in the emergency state allowing voice messages to proceed until action is taken. See [Emergency Operation](#) on page 95 on ways to exit Emergency.



Note:

This feature is limited to radios with this function enabled. Check with your dealer or system administrator for more information.

Lone Worker

This feature raises an emergency if there is no user activity, such as any radio button press or activation of the channel selector, for a predefined time.

Before raising the emergency, when the inactivity timer expires, the radio warns the user via an audio indicator.

If there is still no acknowledgement by the user before the predefined reminder timer expires, the radio initiates an Emergency Alarm.

Only one of the following Emergency Alarms can be assigned to this feature:

- Emergency Alarm
- Emergency Alarm with Call
- Emergency Alarm with Voice to Follow

Password Lock Features

If enabled, this feature only allows you access your radio if the correct password is entered upon powering up.

Accessing the Radio from Password

- 1 Power up your radio.
You hear a continuous tone.
-
- 2 Do one of the following:
 - Enter your current four-digit password with the radio's keypad. The second line of the display shows ●●●●. Press  to proceed.

- Enter your current four-digit password. Press ◀ or ▶ to edit each digit's numeric value. Each digit changes to •. Press ▶ to move to next digit. Press Ⓜ to confirm your selection.

You hear a positive indicator tone for every digit entered. Press ◀ to remove the last • on the display. You hear a negative indicator tone, if you press ◀ when the second line of the display is empty, or if you press more than four digits.

If the password is correct, your radio proceeds to power up. See [Powering Up the Radio](#) on page 24.

If the password is incorrect, the display shows *Wrong Password*. Repeat Steps 1 and 2. Password less than four digits is incorrect.

After the third incorrect password, the display shows *Wrong Password* and then, shows *Radio Locked*. A tone sounds and the LED double blinks yellow.

Your radio enters into locked state for 15 minutes, and responds to inputs from **On/Off Button** and programmed **Backlight** button only.



Note:

The radio is unable to receive any call, including emergency calls, in locked state.

Unlocking the Radio from Locked State

- 1 If your radio was powered down after being in the locked state, power up the radio. A tone sounds and the LED double blinks yellow. The display shows *Radio Locked*.
- 2 Wait for 15 minutes. Your radio restarts the 15 minutes timer for locked state when you power up.
- 3 Repeat Steps 1 and in [Accessing the Radio from Password](#) on page 129.

Turning the Password Lock On or Off

- 1 Ⓜ to access the menu.
-

- 2 ▲ or ▼ to Utilities and press  to select.

- 3 ▲ or ▼ to Radio Settings and press  to select.

- 4 ▲ or ▼ to Passwd Lock and press  to select.

- 5 Enter the four-digit password.
See Step 2 in [Accessing the Radio from Password](#) on page 129.

- 6 Press  to proceed.
If the password is incorrect, the display shows Wrong Password, and automatically returns to the previous menu.

- 7 If the password entered in the previous step is correct, press  to enable/disable password lock.
The display shows ✓ beside Enabled.
The ✓ disappears from beside Enabled.

Changing the Password

- 1  to access the menu.



- 2 ▲ or ▼ to Utilities and press  to select.

- 3 ▲ or ▼ to Radio Settings and press  to select.

- 4 ▲ or ▼ to Passwd Lock and press  to select.

- 5 Enter the four-digit password.
See Step 2 in [Accessing the Radio from Password](#) on page 129.

- 6 Press  to proceed.
If the password is incorrect, the display shows Wrong Password, and automatically returns to the previous menu.

- 7 If the password entered in the previous step is correct, ▲ or ▼ to Change Pwd and press  to select.
-
- 8 Enter a new four-digit password.
See Step 2 in [Accessing the Radio from Password](#) on page 129.
-
- 9 Reenter the previously entered four-digit password. See Step 2 in [Accessing the Radio from Password](#) on page 129.
-
- 10 Press  to proceed.
- If the reentered password matches the new password entered earlier, the display shows `Password Changed`.
- If the reentered password does **NOT** match the new password entered earlier, the display shows `Passwords Do Not Match`.
- The screen automatically returns to the previous menu.
-

Bluetooth Operation



Note:

If disabled via the CPS, all Bluetooth-related features are disabled and the Bluetooth device database is erased.

This feature allows you to use your radio with a Bluetooth-enabled device (accessory) via a wireless Bluetooth connection. Your radio supports both Motorola and COTS (Commercially available Off-The-Shelf) Bluetooth-enabled devices.

Bluetooth operates within a range of 10 meters (32 feet) line of sight. This is an unobstructed path between your radio and your Bluetooth-enabled device.

It is not recommended that you leave your radio behind and expect your Bluetooth-enabled device to work with a high degree of reliability when they are separated.

At the fringe areas of reception, both voice and tone quality will start to sound “garbled” or “broken”. To correct this problem, simply position your radio and Bluetooth-enabled device closer to each other (within the 10-meter/32 feet defined range) to re-establish



clear audio reception. Your radio's Bluetooth function has a maximum power of 2.5 mW (4 dBm) at the 10-meter/32 feet range.





Your radio can support up to 3 simultaneous Bluetooth connections with Bluetooth-enabled devices of unique types. For example, a headset, a scanner, and a PTT-Only Device (POD). Multiple connections with Bluetooth-enabled devices of the same type are not supported.

Refer to your respective Bluetooth-enabled device's user manual for more details on your Bluetooth-enabled device's full capabilities.









Turning Bluetooth On and Off

- 1  to access the menu.

- 2  or  to Bluetooth and press  to select.

- 3  or  to My Status and press  to select. The display shows On and Off. The current status is indicated by a .

- 4 Do one of the following:



-  or  to On and press  to select. The display shows On and a  appears left of the selected status.
-  or  to Off and press  to select. The display shows Off and a  appears left of the selected status.



Finding and Connecting to a Bluetooth Device

Do **not** turn off your Bluetooth-enabled device or press  during the finding and connecting operation as this cancels the operation.



- 1 Turn on your Bluetooth-enabled device and place it in pairing mode. Refer to respective Bluetooth-enabled device's user manual.

- 2 On your radio, press  to access the menu.

- 3  or  to Bluetooth and press  to select.

- 4  or  to Devices and press  to select.

- 5 Do one of the following:

- ▲ or ▼ to the required device and press  to select.
- ▲ or ▼ to Find Devices to locate available devices. ▲ or ▼ to the required device and press  to select.

-
- 6 ▲ or ▼ to Connect and press  to select. Display shows Connecting to <Device>. Your Bluetooth-enabled device may require additional steps to complete the pairing. Refer to respective Bluetooth-enabled device's user manual.
-

If successful, the radio display shows <Device> Connected. A tone sounds and ✓ appears besides the connected device. The Bluetooth Connected icon appears on the status bar.

If unsuccessful, the radio display shows Connecting Failed.





Note:

If pin code is required, use the same entry method as Step 2 in [Accessing the Radio from Password](#) on page 129.

Finding and Connecting from a Bluetooth Device (Discoverable Mode)

Do not turn off your Bluetooth or your radio during the finding and connecting operation as this may cancel the operation.

- 1 Turn Bluetooth On.
See [Turning Bluetooth On and Off](#) on page 133.
 - 2  to access the menu.
 - 3 ▲ or ▼ to Bluetooth and press  to select.
 - 4 ▲ or ▼ to Find Me and press  to select. Your radio can now be found by other Bluetooth-enabled devices for a programmed duration. This is called Discoverable Mode.
 - 5 Turn on your Bluetooth-enabled device and pair it with your radio.
Refer to respective Bluetooth-enabled device's user manual.
-



Connecting to a Paired Bluetooth Device

Do **not** turn off your Bluetooth-enabled device or press  during the connecting operation as this cancels the operation.



The radio connects automatically to the paired Bluetooth-enabled device. If unsuccessful, follow the procedure described next.



1 Turn on your Bluetooth-enabled device. Refer to respective Bluetooth-enabled device's user manual.

2 On your radio, press  to access the menu.

3  or  to Bluetooth and press  to select.

4  or  to Device and press  to select.

5  or  to the required device and press  to select.

6  or  to Connect and press  to select.



Display shows Connecting to <Device>.

If successful, the radio display shows <Device>Connected. A tone sounds and  appears besides the connected device. The Bluetooth Connected icon appears on the status bar.



If unsuccessful, the radio display shows Connecting Failed.



Disconnecting from a Bluetooth Device

1 On your radio, press  to access the menu.

2  or  to Bluetooth and press  to select.

3  or  to Devices and press  to select.

4  or  to the required device and press  to select.

5  or  to Disconnect and press  to select. Display shows Disconnecting from <Device>. Your Bluetooth-enabled device may require

additional steps to disconnect. Refer to respective Bluetooth-enabled device's user manual.

The radio display shows <Device> Disconnected. A positive indicator tone sounds and ✓ disappears beside the connected device. The Bluetooth Connected icon disappears on the status bar.

Switching Audio Route between Internal Radio Speaker and Bluetooth Device



You can toggle audio routing between internal radio speaker and external Bluetooth-enabled accessory.



Press the programmed **Bluetooth Audio Switch** button.



- A tone sounds and display shows Route Audio to Radio.
- A tone sounds and display shows Route Audio to Bluetooth.



Viewing Device Details

1  to access the menu.

2  or  to Bluetooth and press  to select.

3  or  to Devices and press  to select.



4  or  to the required device and press  to select.



5  or  to View Details and press  to select.



Editing Device Name

You can edit the name of available Bluetooth-enabled devices.





1  to access the menu.

2  or  to Bluetooth and press  to select.

3  or  to Devices and press  to select.

4  or  to the required device and press  to select.

5  or  to Edit Name and press  to select.



- 6 Press  to move one space to the left. Press  to move one space to the right. Press  to delete any unwanted characters. Long press  to change text entry method. A blinking cursor appears. Use the keypad to type the required zone.



7 The display shows Device Name Saved.



Deleting Device Name



You can remove a disconnected device from the list of Bluetooth-enabled devices.

- 1  to access the menu.

- 2  or  to Bluetooth and press  to select.

- 3  or  to Devices and press  to select.



- 4  or  to the required device and press  to select.



- 5  or  to Delete and press  to select. The display shows Device Deleted.



Bluetooth Mic Gain



Allows control of the connected Bluetooth-enabled device's microphone gain value.

- 1  to access the menu.

- 2  or  to Bluetooth and press  to select.

- 3  or  to BT Mic Gain and press  to select.

- 4  or  to the BT Mic Gain type and the current values. To edit values, press  to select.

- 5  or  to increase or to decrease values and press  to select.

Permanent Bluetooth Discoverable Mode



Note:

The Permanent Bluetooth Discoverable Mode can only be enabled via the MOTOTRBO CPS. If enabled, the Bluetooth item will **not** be displayed in the Menu and you will **not** be able to use any Bluetooth programmable button features.

Other Bluetooth-enabled devices can locate your radio, but the devices cannot connect to the radio. It enables dedicated devices to use your radio position in the process of Bluetooth-based location.

Notification List

Your radio has a Notification List that collects all your “unread” events on the channel, such as unread text messages, telemetry messages and missed calls. Unread Job Tickets are also stored in the notification list.

The Notification icon appears on the status bar when the Notification List has one or more events.

For TMS and missed call/call alert notification events, the maximum number are 30 TMS and 10 missed calls/call alerts. This maximum number depends on

individual feature (job tickets or TMS or missed calls/call alerts) list capability.









Note:

After the events are read, they are removed from the Notification List.

Accessing the Notification List

- 1  to access the menu.

- 2  or  to Notification and press  to select.

- 3  or  to the required event and press  to select.

Long press  to return to the Home Screen.

Over-the-Air-Programming (OTAP)

Your radio can be updated by your dealer remotely, via OTAP, without needing to be physically connected. Additionally, some settings can also be configured via OTAP.

While undergoing OTAP, the LED blinks green.

**Note:**

When the radio is receiving high volume data, the High Volume Data icon appears and channel is busy. A **PTT** button press at this time may cause a negative tone to sound.

Once the programming is complete, depending on your radio's configuration:

- A tone sounds, the display shows `Updating`, `Restarting`, and your radio restarts (powers off and on again).
- Select between `Restart Now` or `Postpone`. Selecting `Postpone` allows your radio to return to the previous display, with an `OTAP Timer` icon visible, for a period of time before the automatic restart occurs.

Upon power up after the automatic restart occurs, the display shows `Sw Update Completed` if the OTAP update is successful or `Sw Update Failed` if the OTAP update is unsuccessful.

See [Software Update](#) on page 171 for your updated software version.

Wi-Fi Operation

Wi-Fi® is a registered trademark of Wi-Fi Alliance®.

**Note:**

This feature is applicable to SL7550e/SL7590e/SL7580e only.

This feature allows you to setup and connect to a Wi-Fi® network. Wi-Fi supports updates for radio firmware, codeplug, and resources such as language packs and voice announcement.

Turning Wi-Fi On or Off



**Note:**

This feature is applicable to SL7550e/SL7590e/SL7580e only.

The programmed **Wi-Fi On or Off** button is assigned via CPS. Check with your dealer or system administrator to determine how your radio has been programmed.

You can turn on or turn off Wi-Fi® by performing one of the following actions.

- Press the programmed **Wi-Fi On or Off** button. Voice Announcement sounds `Turning On Wi-Fi` or `Turning Off Wi-Fi`.
- Access this feature via the menu.
 - a) Press  to access the menu.

- b) Press ▲ or ▼ to WiFi and press  to select.
- c) Press ▲ or ▼ to WiFi Status and press  to select.

Press  to turn on Wi-Fi. The display shows ✓ beside Enabled.

Press  to turn off Wi-Fi. The ✓ disappears from beside Enabled.

If Wi-Fi is enabled and a low capacity battery is used, an alert screen is displayed upon power up with the following notice.

- Low Capacity Battery!
- Tx power restricted to 2W and Wi-Fi disabled.
- Use a compatible battery to lift restriction.
- Press  to continue.

Lift the restriction to enable 3W operation and Wi-Fi by performing the following action. Power off the radio and change to a compatible battery such as Lithium-

Ion 1800 mAh Battery Pack (HKNN4013_) and Lithium-Ion 2200 mAh Battery Pack (PMNN4459_) or Lithium-Ion 2300mAh Battery Pack (PMNN4468_).

If Wi-Fi is disabled and a low capacity battery is used, the transmit power is restricted to 2W.

Connecting to a Network Access Point







Note:

This feature is applicable to SL7550e/SL7590e/SL7580e only.

When you turn on Wi-Fi®, the radio scans and connects to a network access point.

You can also connect to a network access point via the menu.

- 1 Press  to access the menu.
 - 2 Press ▲ or ▼ to WiFi and press  to select.
 - 3 Press ▲ or ▼ to Networks and press  to select.
-

4 Press ▲ or ▼ to a network access point and press  to select.

5 Press ▲ or ▼ to Connect and press  to select.



6 Enter the password and press .
When the connection is successful, the radio displays a notice and the network access point is saved into the profile list.

Refreshing the Network List



Note:

This feature is applicable to SL7550e/SL7590e/SL7580e only.

- Perform the following actions to refresh the network list.
 - a) Press  to access the menu.
 - b) Press ▲ or ▼ to WiFi and press  to select.

c) Press ▲ or ▼ to Networks and press  to select.

When you enter the Networks menu, the radio automatically refreshes the network list.

- If you are already in the Networks menu, perform the following action to refresh the network list.

a) Press ▲ or ▼ to Refresh and press  to select.

The radio refreshes and displays the latest network list.

Adding a Network





Note:

This feature is applicable to SL7550e/SL7590e/SL7580e only.

If a preferred network is not in the available network list, perform the following actions to add a network.

1 Press  to access the menu.



2 Press ▲ or ▼ to WiFi and press  to select.

- 3 Press ▲ or ▼ to **Networks** and press  to select.

 - 4 Press ▲ or ▼ to **Add Network** and press  to select.

 - 5 Enter the Service Set Identifier (SSID) and press .

 - 6 Press ▲ or ▼ to **Open** and press  to select.

 - 7 Enter the password and press .
- The radio displays  to indicate that the network is successfully saved.

Viewing Details of Network Access Points





Note:

This feature is applicable to SL7550e/SL7590e/SL7580e only.

Perform the following actions to view details of network access points.

- 1 Press  to access the menu.

 - 2 Press ▲ or ▼ to **WiFi** and press  to select.

 - 3 Press ▲ or ▼ to **Networks** and press  to select.

 - 4 Press ▲ or ▼ to a network access point and press  to select.

 - 5 Press ▲ or ▼ to **View Details** and press  to select.
- For a connected network access point, the Service Set Identifier (SSID), Security Mode, Media Access Control (MAC) address, and Internet Protocol (IP) address are displayed.
- For a non-connected network access point, the Service Set Identifier (SSID) and Security Mode are displayed.

Removing Network Access Points



Note:

This feature is applicable to SL7550e/SL7590e/SL7580e only. Enterprise network access points that are added via CPS can only be removed via CPS.

Perform the following actions to remove network access points from the profile list.

- 1 Press to access the menu.

- 2 Press or to **WiFi** and press to select.

- 3 Press or to **Networks** and press to select.

- 4 Press or to the selected network access point and press to select.

- 5 Press or to **Remove** and press to select.

- 6 Press or to **Yes** and press to select.



The radio displays to indicate that the selected network access point is successfully removed.



Utilities

Locking and Unlocking the Keypad

You can lock your radio's keypad to avoid inadvertent key entry.

To lock/unlock your radio's keypad.

| Option | Steps |
|--------------------|---|
| Locking the Keypad | <ol style="list-style-type: none"> 1 to access the menu. 2 or to Utilities and press to select. 3 or to Radio Settings and press to select. 4 or to Keypad Lock and press to select. |





| Option | Steps |
|----------------------|---|
| | You can also use ◀ or ▶ to change the selected option. |
| Unlocking the Keypad | Press  followed by  . |



After the keypad is locked, the display shows Keypad Locked and returns to the Home screen.



After the keypad is unlocked, the display shows Keypad Unlocked and returns to the Home screen.



Turning Keypad Tones On or Off

You can enable and disable keypad tones if needed.

- 1  to access the menu.
- 2  or  to Utilities and press  to select.

- 3  or  to Radio Settings and press  to select.

- 4  or  to Tones/Alerts and press  to select.

- 5  or  to Keypad Tones and press  to select.

You can also use ◀ or ▶ to change the selected option.

- 6 Press  to enable/disable keypad tones.
The display shows ✓ beside Enabled.
The ✓ disappears from beside Enabled.

Setting the Power Level



Note:

This feature is not applicable in Citizens Band channels that are in the same frequency.

This feature is applicable to SL7550e/SL7590e/SL7580e only with a frequency band



width of 403MHz–470MHz or 470.000005MHz–527MHz. Select the value of high transmit power in CPS. Check with your dealer or system administrator to determine how your radio has been programmed.



You can customize the power setting of the radio to high or low for each channel.



High enables communication with radios located at a considerable distance from you. Low enables communication with radios in closer proximity.





Press the programmed **Power Level** button to toggle transmit power level between high and low. Follow the procedure described next to access this feature via the radio menu.

- 1 Press  to access the menu.

- 2 Press  or  to *Utilities* and press  to select.

- 3 Press  or  to *Radio Settings* and press  to select.

- 4 Press  or  to *Power* and press  to select.

- 5 Press  or  to the required setting and press  to select.
 appears beside selected setting. At any time, long press  to return to the Home screen. Screen returns to the previous menu.

Turning the Option Board Feature(s) On or Off



A channel can support up to 6 option board features. Refer to your dealer or system administrator for more information.

Press the programmed **Option Board Feature** button to toggle the feature on or off.

Identifying Cable Type

You can select the type of cable your radio uses.

- 1  to access the menu.

- 2  or  to *Utilities* and press  to select.

3 ▲ or ▼ to Radio Settings and press  to select.

4 ▲ or ▼ to Cable Type and press  to select.

You can also use ◀ or ▶ to change the selected option.

5 The current cable type is indicated by a ✓.

Turning the Voice Operating Transmission (VOX) Feature On or Off

This feature allows you to initiate a hands-free voice activated call on a programmed channel. The radio automatically transmits, for a programmed period, whenever the microphone on the VOX-capable accessory detects voice.

Pressing the **PTT** button during radio operation will disable VOX. To re-enable VOX, do one of the following:

- Turn the radio off and power it on again.
- Press the programmed **VOX** button to toggle the feature on or off.

- Follow the steps described next to access this feature via the radio menu.





Note:

Turning this feature on or off is limited to radios with this function enabled. Check with your dealer or system administrator for more information.

1  to access the menu.

2 ▲ or ▼ to Utilities and press  to select.

3 ▲ or ▼ to Radio Settings and press  to select.

4 ▲ or ▼ to VOX and press  to select.

5 Press  to disable/enable VOX.

The display shows ✓ beside Enabled.

The ✓ disappears from beside Enabled.



Setting the Display Backlight Timer



You can set the the radio's display backlight timer as needed. The setting also affects the Menu Navigation Buttons and keypad backlighting accordingly.



Press the programmed **Backlight** button to toggle the backlight settings, or follow the procedure described next to access this feature via the radio menu.



The display backlight and keypad backlighting are automatically turned off if the LED indicator is disabled (see [Turning the LED Indicator On or Off](#) on page 154).



- 1  to access the menu.

- 2  or  to Utilities and press  to select.

- 3  or  to Radio Settings and press  to select.

- 4  or  to Display and press  to select.



- 5  or  to Backlight Timer and press  to select.



You can use  or  to change the selected option.



Turning the Backlight Auto On or Off

You can enable and disable the radio's backlight to turn on automatically if needed. If enabled, the backlight is turned on when the radio receives a call, Notification List event, or Emergency Alarm.

- 1  to access the menu.

- 2  or  to Utilities and press  to select.

- 3  or  to Radio Settings and press  to select.

- 4  or  to Backlight Auto.

- 5 Press  to enable/disable the Backlight Auto.

The display shows  beside Enabled.



The  disappears from beside Enabled.



Turning the Radio Tones/Alerts On or Off



You can enable and disable all radio tones and alerts (except for the incoming Emergency alert tone) if needed.



Press the programmed **All Tones/Alerts** button to toggle all tones on or off, or follow the procedure described next to access this feature via the radio menu.

- 1  to access the menu.

- 2  or  to Utilities and press  to select.

- 3  or  to Radio Settings and press  to select.

- 4  or  to Tones/Alerts and press  to select.

- 5  or  to All Tones and press  to select.

- 6 Press  to enable/disable all tones and alerts.



The display shows  beside Enabled.



The  disappears from beside Enabled.



Setting the Tone Alert Volume Offset Level



You can adjust the Tone Alert Volume Offset level if needed. This feature adjusts the volume of the tones/alerts, allowing it to be higher or lower than the voice volume.



- 1  to access the menu.

- 2  or  to Utilities and press  to select.

- 3  or  to Radio Settings and press  to select.



- 4  or  to Tones/Alerts and press  to select.

- 5  or  to Vol. Offset and press  to select.

- 6  or  to the required volume value.

The radio sounds a feedback tone with each corresponding volume value.

7 Do one of the following:



- Press  to keep the required displayed volume value.
- Press  to exit without changing the current volume offset settings.
- Repeat Step 6 to select another volume value.



Turning the Talk Permit Tone On or Off



You can enable and disable the Talk Permit Tone if needed.



1  to access the menu.



2  or  to Utilities and press  to select.

3  or  to Radio Settings and press  to select.

4  or  to Tones/Alerts and press  to select.

5  or  to Talk Permit and press  to select.



You can also use  or  to change the selected option.

6 Press  to enable/disable the Talk Permit Tone.
The display shows  beside Enabled.
The  disappears from beside Enabled.

Setting the Text Message Alert Tone

You can customize your radio's text message alert tone to Momentary or Repetitive for each entry in the Contacts list.

1  to access the menu.

2  or  to Contacts and press  to select.

3 ▲ or ▼ to the required subscriber alias or ID and press  to select.

4 ▲ or ▼ to Message Alert and press  to select.
The display shows Momentary and Repetitive.





You can also use ◀ or ▶ to change the selected option.



5 ▲ or ▼ to the required setting and press  to enable.
✓ appears besides selected setting.

Changing the Display Mode

You can change radio's display mode between Day or Night, as needed. This affects the color palette of the display.

Change the Display Mode:

| Radio Control | Steps |
|--------------------------------|--|
| Programmed Display Mode Button | Press the programmed Display Mode button. |
| Menu | <ol style="list-style-type: none"> 1  to access the menu. 2 ▲ or ▼ to Utilities and press  to select. 3 ▲ or ▼ to Radio Settings and press  to select. 4 ▲ or ▼ to Display and press  to select. The display shows Day Mode and Night Mode. |

| Radio Control | Steps |
|---------------|---|
| | <p> Note: You can also use ◀ or ▶ to change the selected option.</p> <p>5 ▲ or ▼ to the required setting and press  to enable. ✓ appears besides selected setting.</p> |





Adjusting the Display Brightness

You can adjust the display brightness of the radio as needed.



Note:
Display brightness cannot be adjusted when Auto Brightness is enabled.

Adjust the Display Brightness by performing one of the following actions:



| Radio Control | Steps |
|--------------------------------------|---|
| Programmed Display Brightness Button | <ol style="list-style-type: none"> 1 Press the programmed Brightness button. 2 Decrease display brightness by pressing ◀ or increase the display brightness by pressing ▶. Select from setting of 1 to 8. Press  to confirm your entry. |
| Menu | <ol style="list-style-type: none"> 1  to access the menu. 2 ▲ or ▼ to Utilities and press  to select. 3 ▲ or ▼ to Radio Settings and press  to select. 4 ▲ or ▼ to Brightness and press  to select. The display shows a progress bar. |



| Radio Control | Steps |
|---------------|--|
| | <p>5 Decrease display brightness by pressing ◀ or increase the display brightness by pressing ▶. Select from setting of 1 to 8. Press  to confirm your entry.</p> |



Wallpaper Mode

Your radio displays the Wallpaper background on home screen. The user can select from 5 default wallpapers.



- 1  to access the menu.

- 2  or  to Utilities and press  to select.

- 3  or  to Radio Settings and press  to select.

- 4  or  to Display and press  to select.

- 5  or  to Wallpaper and press  to select.

You can also use  or  to change the selected option.

Screen Saver Mode

The screen saver feature allows the radio to save radio battery time. A Screen Saver Pre Duration is used to track the radio activities before entering screen saver mode.

Radio starts Screen Saver Pre Duration upon power up. Radio enters into screen saver mode when Screen Saver Pre Duration timer expires, the radio exits screen saver mode and responds to related transaction normally upon any user input and over the air transaction.

Radio restarts Screen Saver Pre Duration upon any user input and over the air transaction. After being in Screen Saver mode for 5 seconds, radio enters keypad lock state automatically. When any audio or Bluetooth accessory is connected, battery saver mode is enabled, radio enters screen saver mode.

If there is any user input or over the air transaction, the radio exits screen saver mode and responds to user interaction. The Screen Saver Pre Duration is restarted and the radio goes back to screen saver mode when it expires.



Note:

The screen saver mode is to help improve battery life.

Audio Accessory

The audio accessory has two modes: Normal and Battery Saver mode. When audio accessory is plugged in and the setting is in Battery Saver Mode, the radio restarts the timer and goes into screen saver mode. In this scenario, when there is any user input (including user input on radio and accessory attachment/detachment) or when receiving emergency alarm/call, the radio exits screen saver mode and responds to user event as normal. The Screen Saver timer restarts and the radio goes back to screen saver mode when the time allocated expires.

Auto Keypad Lock

You can enable/disable your radio's auto keypad lock to avoid inadvertent key entry.

- 1 to access the menu.

- 2 or to Utilities and press to select.

- 3 or to Radio Settings and press to select.

- 4 or to Auto Keypad Lock and press to select.

- 5 Do one of the following:
 - Press to enable Auto Keypad Lock. The display shows beside Enabled.
 - Press to disable Auto Keypad Lock. The disappears from beside Enabled.

Language

You can set your radio display to be in your required language.

- 1 to access the menu.

2 ▲ or ▼ to Utilities and press  to select.

3 ▲ or ▼ to Radio Settings and press  to select.

4 ▲ or ▼ to Languages and press  to select.

5 ▲ or ▼ to the required language and press  to enable. ✓ appears beside selected language.

Turning the LED Indicator On or Off

You can enable and disable the LED Indicator if needed.

1  to access the menu.

2 ▲ or ▼ to Utilities and press  to select.

3 ▲ or ▼ to Radio Settings and press  to select.

4 ▲ or ▼ to LED Indicator and press  to select.

You can also use ◀ or ▶ to change the selected option.

5 Press  to enable/disable the LED Indicator.

The display shows ✓ beside Enabled.

The ✓ disappears from beside Enabled.

Turning the Voice Announcement On or Off



















Note:

The Voice Announcement feature can only be enabled via the MOTOTRBO CPS. If enabled, the Text-to-Speech feature is automatically disabled, and vice versa.

This feature enables the radio to audibly indicate the current Zone or Channel the user has assigned, or programmable button press. This audio indicator can be customized per customer requirements. This is typically useful when the user is in a difficult condition to read the content shown on the display.

Toggle Voice Announcement On or Off.

| Radio Control | Steps |
|--------------------------------------|---|
| Programmed Voice Announcement Button | Press the programmed Voice Announcement button. |
| Menu | <ol style="list-style-type: none"> 1  to access the menu. 2  or  to Utilities and press  to select. 3  or  to Radio Settings and press  to select. 4  or  to Voice Announcement and press  to select. <p> Note: You can also use  or  to change the selected option.</p> <ol style="list-style-type: none"> 5 Do one of the following: |

| Radio Control | Steps |
|---------------|---|
| | <ul style="list-style-type: none"> • Press  to enable Voice Announcement. The display shows  beside Enabled. • Press  to disable Voice Announcement. The  disappears from beside Enabled. |

Setting the Text-to-Speech Feature



Note:

The Text-to-Speech feature can only be enabled via the MOTOTRBO Customer Programming Software. If enabled, the Voice Announcement feature is automatically disabled, and vice versa. Check with your dealer or system administrator for more information.



This feature enables the radio to audibly indicate the following features:



- Current Channel
- Current Zone



- Programmed button feature on or off
- Content of received text messages
- Content of received Job Tickets



This audio indicator can be customized per customer requirements. This is typically useful when the user is in a difficult condition to read the content shown on the display.



- 1  to access the menu.

- 2  or  to *Utilities* and press  to select.

- 3  or  to *Radio Settings* and press  to select.

- 4  or  to *Voice Announcement* and press  to select.

- 5  or  to any of the following features and press  to select.

You can also use  or  to change the selected option.



- All
- Messages
- Job Tickets
- Channel
- Zone
- Program Button



✓ appears beside the selected setting.



Digital Mic AGC (Mic AGC-D)

This feature controls the your radio's microphone gain automatically while transmitting on a digital system. It suppresses loud audio or boosts soft audio to a preset value in order to provide a consistent level of audio.

- 1  to access the menu.



- 2  or  to *Utilities* and press  to select.

- 3  or  to *Radio Settings* and press  to select.

You can also use  or  to change the selected option.

4 ▲ or ▼ to Mic AGC-D and press  to select.

5 Do one of the following:

- Press  to enable **Mic AGC-D**. The display shows ✓ beside Enabled.
- Press  to disable **Mic AGC-D**. The ✓ disappears from beside Enabled.

Switching Audio Route between Internal Radio Speaker and Wired Accessory

You can toggle audio routing between the internal radio speaker and the speaker of wired accessory provided that:

- The wired accessory with speaker is attached.
- The audio is not routed to an external Bluetooth-enabled accessory.
- The radio is not in Covert Mode.

Powering down the radio or detaching the accessory resets the audio routing to the internal radio speaker.

Press the programmed **Audio Toggle** button to toggle audio routing between the internal radio speaker and the speaker of wired accessory.

Intelligent Audio

Your radio can automatically adjust its audio volume to overcome background noise in the environment, inclusive of all stationary and non-stationary noise sources. This feature is a Receive-only feature and does not affect Transmit audio.



















Note:

This feature is not applicable during a Bluetooth session.

Toggle Intelligent Audio On or Off.

| Radio Control | Steps |
|-------------------------------------|---|
| Programmed Intelligent Audio Button | Press the programmed Intelligent Audio button. |

| Radio Control | Steps |
|---------------|---|
| Menu | <ol style="list-style-type: none"> 1  to access the menu. 2  or  to Radio Settings and press  to select. 3  or  to Radio Settings and press  to select. 4  or  to Intelligent Audio and press  to select. <p> Note: You can also use  or  to change the selected option.</p> <ol style="list-style-type: none"> 5 Do one of the following: <ul style="list-style-type: none"> • Press  to enable Intelligent Audio. The display shows  beside Enabled. |

| Radio Control | Steps |
|---------------|---|
| | <ul style="list-style-type: none"> • Press  to disable Intelligent Audio. The  disappears from beside Enabled. |













See [Authorized Accessories List](#) on page 281 for recommended Bluetooth-enabled audio accessories with in-built Automatic Volume Control for similar performance.





Turning the Acoustic Feedback Suppressor Feature On or Off

This feature allows you to minimize acoustic feedback in received calls.

Toggle the Acoustic Feedback Suppressor Feature On or Off by performing one of the following actions:

| Radio Control | Steps |
|---------------------|--|
| Programmed Acoustic | Press the programmed Acoustic Feedback Suppressor button. |

| Radio Control | Steps |
|----------------------------|--|
| Feedback Suppressor Button | |
| Menu | <ol style="list-style-type: none"> 1  to access the menu. 2  or  to Utilities and press  to select. 3  or  to Radio Settings and press  to select. 4  or  to AF Suppressor and press  to select. <p> Note: You can also use  or  to change the selected option.</p> <ol style="list-style-type: none"> 5 Do one of the following: |

| Radio Control | Steps |
|---------------|---|
| | <ul style="list-style-type: none"> • Press  to enable Acoustic Feedback Suppressor. The display shows  beside Enabled. • Press  to disable Acoustic Feedback Suppressor. The  disappears from beside Enabled. |

Setting the Audio Ambience



You can customize the audio ambience of the radio according to your environment.



Default enables the default factory settings.



Loud enables Noise Suppressor and increases speaker loudness for use in noisy surroundings.



Work Group enables AF Suppressor and disables AGC for use when a group of radios are near to each other.



- 1  to access the menu.

- 2  or  to Utilities and press  to select.

- 3  or  to Radio Settings and press  to select.

- 4  or  to Audio Ambience and press  to select.

- 5  or  to the required setting and press  to select.

You can also use  or  to change the selected option.

 appears beside the selected setting.

Screen returns to the previous menu.

Setting the Audio Profiles



You can customize the audio profiles of the radio according to your preference.



Default disables the previously selected audio profile and the radio's audio profile returns to normal.



Level 1, Level 2, and Level 3 are audio profiles intended to compensate for noise-induced hearing loss that is typical for adults in their 40's, 50's, and 60's or over.



Treble Boost, Mid Boost, and Bass Boost are for a tinnier sound, a more nasal sound, and a deeper sound.

- 1  to access the menu.

- 2  or  to Utilities and press  to select.

- 3  or  to Radio Settings and press  to select.

- 4  or  to Audio Profiles and press  to select.

- 5  or  to the required setting and press  to select.

You can also use ◀ or ▶ to change the selected option.

✓ appears beside the selected setting.

Screen returns to the previous menu.

Text Entry Configuration

You can configure the following settings for entering text on your radio:



- Word Predict
- Word Correct
- Sentence Cap
- My Words

Your radio supports the following text entry methods:

- Numbers
- Symbols
- Predictive or Multi-Tap
- Language (If programmed)















Note:

Press  at any time to return to the previous screen or long press  to return to the Home Screen. The radio exits the

current screen once the inactivity timer expires.



Word Predict

Your radio can learn common word sequences that you often enter. It then predicts the next word you may want to use after you enter the first word of a common word sequence into the text editor.

- 1  to access the menu.
- 2  or  to Utilities and press  to select.
- 3  or  to Radio Settings and press  to select.
- 4  or  to Text Entry and press  to select.
- 5  or  to Word Predict and press  to select.













You can also use ◀ or ▶ to change the selected option.



- 6 Do one of the following:

- Press  to enable Word Predict. The display shows ✓ beside Enabled.
- Press  to disable Word Predict. The ✓ disappears from beside Enabled.



Word Correct

Supplies alternative word choices when the word entered into the text editor is not recognized by the in-built dictionary.

- 1  to access the menu.
- 2  or  to Utilities and press  to select.
- 3  or  to Radio Settings and press  to select.
- 4  or  to Text Entry and press  to select.
- 5  or  to Word Correct and press  to select.











You can also use  or  to change the selected option.

6 Do one of the following:

- Press  to enable Word Correct. The display shows ✓ beside Enabled.
- Press  to disable Word Correct. The ✓ disappears from beside Enabled.



Sentence Cap

Automatically enables capitalization for the first letter in the first word for every new sentence.

- 1  to access the menu.
- 2  or  to Utilities and press  to select.
- 3  or  to Radio Settings and press  to select.
- 4  or  to Text Entry and press  to select.

5 ▲ or ▼ to **Sentence Cap** and press  to select.

6 Do one of the following:

- Press  to enable **Sentence Cap**. The display shows ✓ beside **Enabled**.
 - Press  to disable **Sentence Cap**. The ✓ disappears from beside **Enabled**.
-

Viewing Custom Words

You can add your own custom words into your radio's in-built dictionary. Your radio maintains a list to contain these words.

1  to access the menu.

2 ▲ or ▼ to **Utilities** and press  to select.

3 ▲ or ▼ to **Radio Settings** and press  to select.

4 ▲ or ▼ to **Text Entry** and press  to select.

5 ▲ or ▼ to **My Words** and press  to select.

6 ▲ or ▼ to **List of Words** and press  to select.
Display shows the list of custom words.

Editing Custom Word

You can edit the custom words saved in your radio.

1  to access the menu.

2 ▲ or ▼ to **Utilities** and press  to select.

3 ▲ or ▼ to **Radio Settings** and press  to select.

4 ▲ or ▼ to **Text Entry** and press  to select.

5 ▲ or ▼ to **My Words** and press  to select.



6 ▲ or ▼ to List of Words and press  to select.
Display shows the list of custom words.

7 ▲ or ▼ to the required word and press  to select.

8 ▲ or ▼ to Edit and press  to select.

9 Use the keypad to edit your custom word.

Press ◀ to move one space to the left. Press ▶ or the  key to move one space to the right.

Press the  key to delete any unwanted characters. Long press  to change text entry method. Press  once your custom word is completed.

The display shows transitional mini notice, confirming your custom word is being saved.

If the custom word is saved, a tone sounds and the display shows positive mini notice.

If the custom word is not saved, a low tone sounds and the display shows negative mini notice.

Adding Custom Word

You can add your own custom words into your radio's in-built dictionary.

1  to access the menu.

2 ▲ or ▼ to Utilities and press  to select.

3 ▲ or ▼ to Radio Settings and press  to select.



4 ▲ or ▼ to Text Entry and press  to select.

5 ▲ or ▼ to My Words and press  to select.

6 ▲ or ▼ to Add New Word and press  to select.
Display shows the list of custom words.

7 Use the keypad to edit your custom word.

Press ◀ to move one space to the left. Press ▶ or the  key to move one space to the right.

Press the  key to delete any unwanted characters. Long press  to change text entry method. Press  once your custom word is completed.

The display shows transitional mini notice, confirming your custom word is being saved.

If the custom word is saved, a tone sounds and the display shows positive mini notice.

If the custom word is not saved, a low tone sounds and the display shows negative mini notice.

Deleting a Custom Word

You can delete the custom words saved in your radio.

1  to access the menu.

2 ▲ or ▼ to Utilities and press  to select.

3 ▲ or ▼ to Radio Settings and press  to select.



4 ▲ or ▼ to Text Entry and press  to select.

5 ▲ or ▼ to My Words and press  to select.

6 ▲ or ▼ to the required word and press  to select.

7 ▲ or ▼ to Delete and press  to select.



8 Choose one of the following.



- At Delete Entry?, press  to select Yes. The display shows Entry Deleted.
- ▲ or ▼ to No and press  to return to the previous screen.



Deleting All Custom Words



You can delete all custom words from your radio's in-built.



- 1  to access the menu.





- 2  or  to Utilities and press  to select.

- 3  or  to Radio Settings and press  to select.

- 4  or  to Text Entry and press  to select.

- 5  or  to My Words and press  to select.

- 6  or  to Delete All and press  to select.

- 7 Choose one of the following.
 - At Delete Entry?, press  to select Yes. The display shows Entry Deleted.
 -  or  to No and press  to return to the previous screen.





Flexible Receive List

Flexible Receive List is a digital-only (currently supported in Capacity Plus and Linked Capacity Plus) feature that allows you to add, delete or edit members on the receive talkgroup list. Your radio can support a maximum of 16 members in the list.

Turning the Flexible Receive List On or Off

You can enable and disable the Flexible Receive List if needed.







Enable the Flexible Receive List by performing one of the following actions:









| Radio Control | Steps |
|---|--|
| Programmed Flexible Receive List Button | Press the programmed Flexible Receive List button. |
| Menu | <ol style="list-style-type: none"> 1  to access the menu. 2  or  to Flexible Rx List and press  to select. |



| Radio Control | Steps |
|---------------|---|
| | 3 Press  to enable or disable the Flexible Receive List feature. |

| Previous display | Current display |
|------------------|----------------------|
| Turn On | Flexible Rx List On |
| Turn Off | Flexible Rx List Off |

Adding a New Entry to the Flexible Receive List



- 1  to access the menu.
- 2  or  to Utilities and press  to select.
- 3  or  to Radio Settings and press  to select.

- 4  or  to Flexible Rx List and press  to select.
- 5  or  to View/Edit List and press  to select.
- 6  or  to Add Member and press  to select.
- 7 Select the required alias or ID by performing one of the following actions:

| Radio Control | Steps |
|--------------------------|---|
| Radio Navigation Buttons |  or  to the required alias or ID. |
| Keypad | Key in the first character of the required alias. A blinking cursor appears. |



| Radio Control | Steps |
|---------------|-------|
|---------------|-------|

Press  to move one space to the left.

Press  to move one space to the right. Press the  key to delete any unwanted characters. Long press  to change the text entry method.

The first line of the display shows the characters you keyed in. The next lines of the display show the short listed search results. The alias search is case-insensitive. If there are two or more aliases with the same name, the radio displays the alias that is listed first in the list.



8 Press  to select.
The display shows Add Another?.



9  or  to No and press  to select



The display shows .



Deleting an Entry from the Flexible Receive List

1  to access the menu.

2  or  to Utilities and press  to select.



3  or  to Radio Settings and press  to select.





4  or  to Flexible Rx List and press  to select.









5  or  to View/Edit List and press  to select.

6 Select the required alias or ID by performing one of the following actions:

| Radio Control | Steps |
|---------------|-------|
|---------------|-------|

| | |
|---------------|---|
| Radio Naviga- |  or  to the required alias or ID. |
|---------------|---|



| Radio Control | Steps |
|---------------|---|
| tion Buttons | |
| Keypad | <p>Key in the first character of the required alias.</p> <p>A blinking cursor appears.</p> <p>Press  to move one space to the left.</p> <p>Press  to move one space to the right. Press the  key to delete any unwanted characters. Long press  to change the text entry method.</p> <p>The first line of the display shows the characters you keyed in. The next lines of the display show the short listed search results. The alias search is case-insensitive. If there are two or more aliases with the same name, the</p> |

| Radio Control | Steps |
|---------------|--|
| | radio displays the alias that is listed first in the list. |
| 7 | Press  to select. |
| 8 |  or  to Delete and press  to select. |
| 9 |  or  to Yes and press  to select. The display shows  . |

Accessing General Radio Information

Your radio contains information on the following:



- Battery
- Radio Alias and ID
- Firmware and Codeplug Versions
- Open-Source Software Information
- Software Update
- Site Information



Press  at any time to return to the previous screen or long press  to return to the Home screen. The radio exits the current screen once the inactivity timer expires.



Accessing the Battery Information

Displays information on your radio battery.

- 1  to access the menu.

- 2  or  to Utilities and press  to select.

- 3  or  to Radio Info and press  to select.

- 4  or  to Battery Info and press  to select.

The display shows the battery information.

For **IMPRES** batteries **ONLY**: The display reads Recondition Battery if the battery requires reconditioning in an IMPRES charger. After the reconditioning process, the display then shows the battery information.



Checking the Radio Alias and ID



This feature displays the ID of your radio.



Press the programmed **Radio Alias and ID** button to check your radio alias and ID. You hear a positive indicator tone.

Follow the procedure described next to access this feature via the radio screen.

- 1  to access the menu.

- 2  or  to Utilities and press  to select.



- 3  or  to Radio Info and press  to select.



- 4  or  to My ID and press  to select.
The first line of the display shows the radio alias.
The second line of the display shows the radio ID.



Checking the Firmware Version and Codeplug Version

Displays the firmware version on your radio.

- 1  to access the menu.

- 2  or  to Utilities and press  to select.



- 3  or  to Radio Info and press  to select.



- 4  or  to Versions and press  to select.
The display shows the current firmware and codeplug versions.



Checking the Open-Source Software Information

Displays the open-source software (OSS) information on your radio.

- 1  to access the menu.

- 2  or  to Utilities and press  to select.

- 3  or  to Radio Info and press  to select.

- 4  or  to Versions and press  to select.

The display shows the Firmware Version information.

Software Update



Displays the date and time of the latest software update carried out via Over-the-Air Programming.









Note:

Software Update menu is only available after at least one successful OTAP session.

- 1  to access the menu.

- 2  or  to Utilities and press  to select.

- 3  or  to Radio Info and press  to select.



- 4  or  to SW Update and press  to select.
The display shows the date and time of the latest software update.



See [Over-the-Air-Programming \(OTAP\)](#) on page 138 for details on OTAP session.



Site Information

Displays the current Linked Capacity Plus site name your radio is on.

- 1  to access the menu.

- 2  or  to Utilities and press  to select.



- 3  or  to Radio Info and press  to select.

- 4  or  to Site Info and press  to select.
The display shows the current Linked Capacity Plus site name.

See [Linked Capacity Plus](#) on page 44 for details on *Linked Capacity Plus*.

Checking the RSSI Values

Your radio shows the Received Signal Strength Indicator (RSSI) icon at the top of your display. This feature allows you to view the RSSI values.

On the home screen, press  three times and immediately press , all within 5 seconds. The display shows current RSSI values. Long press the  to return to the Home Screen.

See [Display Icons](#) on page 35 for details on *RSSI icon*.

Connect Plus Operations

Additional Radio Controls in Connect Plus Mode

Push-To-Talk (PTT) Button

The **PTT** button on the side of the radio (A) serves two basic purposes:

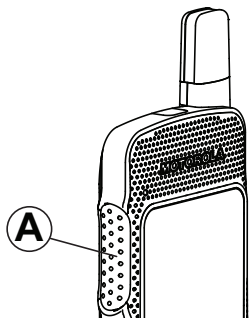

- While a call is in progress, the **PTT** button allows the radio to transmit to other radios in the call.
Press and hold the **PTT** button to talk. Release the **PTT** button to listen.

The microphone is activated when the **PTT** button is pressed.

- While a call is not in progress, the **PTT** button is used to make a new call (see [Making a Radio Call](#) on page 189).

If the Talk Permit Tone (see [Turning the Talk Permit Tone On or Off](#) on page 149) is enabled, wait until the short alert tone ends before talking.

Programmable Buttons

Your dealer can program the programmable buttons as shortcuts to radio functions depending on the duration of a button press:

- Short press** Pressing and releasing rapidly.
- Long press** Pressing and holding for the programmed duration.
- Press and hold** Keeping the button pressed.



Note:

The programmed duration of a button press is applicable for all assignable radio/utility functions or settings. See [Emergency Operation](#) on page 216 for more information

on the programmed duration of the **Emergency** button.

Assignable Radio Functions

| | |
|--------------------------------|---|
| Actions | A programmable button to access a CPS programmable action list. |
| Bluetooth® Audio Switch | Toggles audio routing between internal radio speaker and external Bluetooth-enabled accessory. |
| Busy Queue Cancellation | Exits the busy mode when a non-Emergency call in the Busy Queue was initiated. Emergency calls, once accepted into the Busy Queue, cannot be cancelled. |
| Call Log | Selects the call log list. |
| Contacts | Provides direct access to the Contacts list. |
| Emergency On/Off | Depending on the programming, initiates or cancels an emergency. |

| | |
|--------------------------|---|
| Intelligent Audio | Toggles intelligent audio on or off. |
| Manual Dial | Depending on the programming, initiates a Private or Phone Call by keying in any subscriber ID or phone number. |
| One Touch Access | Directly initiates a predefined Private Call, a Call Alert or a Quick Text message. |
| Privacy | Toggles privacy on or off. |
| Radio Check | Determines if a radio is active in a system. |
| Radio Enable | Allows a target radio to be remotely enabled. |
| Radio Disable | Allows a target radio to be remotely disabled. |
| Remote Monitor | Turns on the microphone of a target radio without it giving any indicators. |
| Roam Request | Requests to search for a different site. |

| | |
|---------------------------------------|---|
| Scan | Toggles scan on or off. |
| Site Lock On/Off | When toggled on, the radio searches the current site only. When toggled off, the radio searches other sites in addition to the current site. |
| Text Message | Selects the text message menu. |
| Voice Announcement for Channel | Plays zone and channel announcement voice messages for the current channel. This function is unavailable when Voice Announcement is disabled. |
| Voice Announcement On/Off | Toggles voice announcement on or off. |
| Zone | Allows selection from a list of zones. |

Assignable Settings or Utility Functions

| | |
|----------------------|---|
| AF Suppressor | Toggles the Acoustic Feedback Suppressor feature on or off. |
|----------------------|---|

| | |
|-------------------------|---|
| All Tones/Alerts | Toggles all tones and alerts on or off. |
| Backlight | Toggles display backlight on or off. |
| Brightness | Allows brightness to be set via the manual brightness mode or auto brightness control via the radio's photo sensor. |
| Display Mode | Toggles the day/night display mode on or off. |
| Keypad Lock | Toggles keypad between locked and unlocked. |
| Unassigned | Indicates that the button function has not yet been assigned. |
| Wallpaper | Displayed on home screen. |

Identifying Status Indicators in Connect Plus Mode







Display Icons







Your radio has a 2 inch landscape display with QVGA (Quarter Video Graphics Array) 16-bit color resolution.





The following are icons that appear on the display of the radio. Icons are displayed arranged left-most in order of appearance/usage.

| | |
|--|---|
| | <p>Received Signal Strength Indicator (RSSI)</p> <p>The number of bars displayed represents the radio signal strength. Four bars indicate the strongest signal. This icon is only displayed while receiving.</p> |
| | <p>Bluetooth Not Connected</p> <p>The Bluetooth feature is enabled but there is no remote Bluetooth device connected.</p> |
| | <p>Bluetooth Connected</p> <p>The Bluetooth feature is enabled. The icon stays lit when a remote Bluetooth device is connected.</p> |
| | <p>Notification List has items to review.</p> |

| | |
|--|---|
| | <p>Option Board</p> <p>The Option Board is enabled. (Option board enabled models only)</p> |
| | <p>Option Board Non-Function</p> <p>The Option Board is disabled.</p> |
| | <p>Scan</p> <p>Scan feature is enabled.</p> |
| | <p>Emergency</p> <p>Radio is in Emergency mode.</p> |
| | <p>Secure</p> <p>The Privacy feature is enabled.</p> |
| | <p>Unsecure</p> <p>The Privacy feature is disabled.</p> |
| | <p>Site Roaming</p> <p>The site roaming feature is enabled.</p> |

| | |
|---|---|
|  | Battery The number of bars (0 – 4) shown indicates the charge remaining in the battery. Blinks when the battery is low. |
|  | Battery Charging Status Shows battery discharging status. |
|  | All Tones Disabled No ring tones available. |
|  | Call Log Radio call log. |
|  | Contact Radio contact is available. |
|  | Message Incoming message. |
|  | Silent Ring Silent ring mode is enabled. |



| | |
|---|--|
|  | Ring Only Ringing mode is enabled. |
|  | Vibrate Vibrate mode is enabled. |
|  | Vibrate and Ring Vibrate and Ring mode is enabled. |
|  | Wi-Fi Excellent^[6] Wi-Fi signal is excellent. |
|  | Wi-Fi Good^[6] Wi-Fi signal is good. |
|  | Wi-Fi Average^[6] Wi-Fi signal is average. |
|  | Wi-Fi Poor^[6] Wi-Fi signal is poor. |

| | |
|---|---|
|  | Wi-Fi Unavailable^[6] Wi-Fi signal is unavailable. |
|  | Wi-Fi Excellent Highlighted^[6] Wi-Fi signal is excellent. When you scroll to a network in the network list, the Wi-Fi icon of that network is highlighted. |
|  | Wi-Fi Good Highlighted^[6] Wi-Fi signal is good. When you scroll to a network in the network list, the Wi-Fi icon of that network is highlighted. |
|  | Wi-Fi Average Highlighted^[6] Wi-Fi signal is average. When you scroll to a network in the network list, the Wi-Fi icon of that network is highlighted. |
|  | Wi-Fi Poor Highlighted^[6] |

| | |
|---|---|
| | Wi-Fi signal is poor. When you scroll to a network in the network list, the Wi-Fi icon of that network is highlighted. |
|  | Wi-Fi Unavailable Highlighted^[6] Wi-Fi signal is unavailable. When you scroll to a network in the network list, the Wi-Fi icon of that network is highlighted. |

Call Icons

The following icons appear on the radio's display during a call. These icons also appear in the Contacts list to indicate ID type.

| | |
|---|---|
|  | Private Call Indicates a Private Call in progress. |
|  | Group Call/Site All Call Indicates a Group Call or Site All Call in progress. |

⁶ Only applicable for SL7550e/SL7590e/SL7580e

**Phone Call as Private Call**

Indicates a Phone Call as Private Call in progress.

**Dispatch Call**

The Dispatch Call contact type is used to send a text message to a dispatcher PC through a third-party Text Message Server.

**Individual or Group Message Unread**

OR



The text message has not been read.

**Send Failed**

OR



The text message has not been sent.

Sent Item Icons

The following icons appear at the top right corner of the radio's display in the Sent Items folder.

**Sent Successfully**

OR



The text message is sent successfully.

**Individual or Group Message Read**

OR



The text message has been read.

LED Indicator

The LED indicator (A) shows the operational status of your radio.

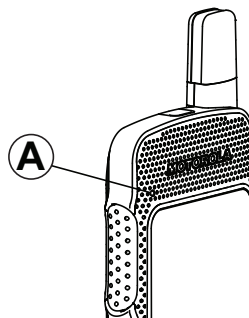



| | |
|----------------------------------|--|
| Blinking red | Radio is transmitting at low battery condition, receiving an emergency transmission or has failed the self-test upon powering up. |
| Rapidly blinking red | Radio is receiving over-the-air file transfer (Option Board firmware file, Network Frequency file or Option Board Codeplug file) or upgrading to a new Option Board firmware file. |
| Blinking green and yellow | Radio is receiving a Call Alert, received a text message or Scan is enabled and is receiving activity. |
| Solid yellow | Radio is in Bluetooth Discoverable Mode. Also indicates fair battery charge when programmable button is pressed. |
| Double blinking yellow | Radio is actively searching for a new site. |
| Blinking yellow | Radio is receiving a Call Alert or Scan is enabled and is idle (radio will remain muted to any activity). |

| | |
|-------------------------------|--|
| Solid green | Radio is powering up or transmitting. Also indicates full charge of the battery when the programmable button is pressed. |
| Blinking green | Radio is powering up, receiving a non-privacy-enabled call or data. |
| Rapidly blinking green | Radio is receiving a privacy-enabled call. |





Indicator Tones

| | | | |
|-------------------|--------------------------|------------------|-------------------------------------|
| High pitched tone | <input type="checkbox"/> | Low pitched tone | <input checked="" type="checkbox"/> |
|-------------------|--------------------------|------------------|-------------------------------------|

| | |
|--|-------------------------|
|  | Positive Indicator Tone |
|  | Negative Indicator Tone |

Alert Tones

Alert tones provide you with audible indications of the status, or response to data received on the radio.

| | |
|---|---|
| Continuous Tone  | A monotone sound. Sounds continuously until termination. |
| Periodic Tone  | Sounds periodically depending on the duration set by the radio. Tone starts, stops, and repeats itself. |
| Repetitive Tone  | A single tone that repeats itself until it is terminated by the user. |
| Momentary Tone  | Sounds only once for a short period of time defined by the radio. |

what features are available while operating in non-Connect Plus zones.

Switching Between Connect Plus and Non-Connect Plus Modes

To switch to a non-Connect Plus mode, you must change to another zone, if programmed by your dealer or system administrator. Check with your dealer or system administrator to see if your radio has been programmed with non-Connect Plus zones, and

Making and Receiving Calls in Connect Plus Mode

Selecting a Site

A site provides coverage for a specific area. A Connect Plus site has a site controller and a maximum of 15 repeaters. In a multi-site network, the Connect Plus radio will automatically search for a new site when the signal level from the current site drops to an unacceptable level.

Roam Request

A Roam Request tells the radio to search for a different site, even if the signal from the current site is acceptable.

If there are no sites available,

- The radio display shows `Searching` and continues to search through the list of sites.
- The radio will return to the previous site, if the previous site is still available.



Note:

This is programmed by your dealer.

Press the programmed **Roam Request** button. You hear a tone, indicating the radio has switched to a new site. The display shows `Site ID <Site Number>`.

Site Lock On/Off

When toggled on, the radio searches the current site only. When toggled off, the radio searches other sites in addition to the current site.

Press the programmed **Site Lock** button.

- You hear a positive indicator tone, indicating the radio has locked to the current site. The display shows `Site Locked`.
- You hear a negative indicator tone, indicating the radio is unlocked. The display shows `Site Unlocked`.

Site Restriction

Your Connect Plus radio system administrator has the ability to decide which network sites your radio is and is not allowed to use. Your radio does not need to be reprogrammed to change the list of allowed and disallowed sites. If your radio attempts to register at a disallowed site, you see a brief message stating:

Site <number given> Not Allowed. The radio then searches for a different network site.

Selecting a Zone



The radio can be programmed with a maximum of 16 Connect Plus Zones and each Connect Plus zone contains a maximum of 16 assignable positions.

Each assignable position can be used to start one of the following voice call types:

- Group Call
- Multigroup Call
- Site All Call
- Private Call





1 Access the Zone feature by performing one of the following actions:

| Radio Controls | Steps |
|------------------------|---|
| Programmed Zone button | Press the programmed Zone button. |
| Radio menu | 1  to access the menu. |

| Radio Controls | Steps |
|----------------|---|
| | 2  or  to Zone and press  to select. |

The current zone is displayed and indicated by a .

2 Select the required zone.

| Radio Control | Steps |
|--|---|
|  or  |  or  and scroll to the required zone. |

3 Press  to select.

The display shows <Zone> Selected momentarily and returns to the selected zone screen.

Using Multiple Networks

If your radio has been programmed to use multiple Connect Plus networks, you can select a different network by switching to the Connect Plus zone that is

assigned to the desired network. These network-to-zone assignments are configured by your dealer through radio programming.

Selecting a Call Type

Use the 4-Way Navigation Disc to select a call type. This can be a Group Call, Multi-group Call, Site All Call or Private Call, depending on how your radio is programmed. If you navigate with the 4-Way Navigation Disc to a different Call Type this causes the radio to re-register with the Connect Plus site. The radio registers with the Registration Group ID that has been programmed for the new call type.

If you select a position that has no call type assigned to it, your radio sounds a continuous tone and the display shows *Unprogrammed*. Your radio does not operate when selected to an unprogrammed channel, use the 4-Way Navigation Disc to select a programmed channel instead.

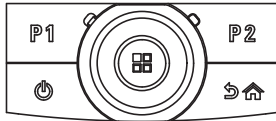

Once the required zone is displayed (if you have multiple zones in your radio), use the 4-Way Navigation Disc to select the call type.

Receiving and Responding to a Radio Call

Once the channel, subscriber ID or call type is displayed, you can proceed to receive and respond to calls.

The LED lights up solid green while the radio is transmitting and blinks green when the radio is receiving.



Note:

The LED lights up solid green while the radio is transmitting and blinks green rapidly when the radio is receiving a privacy-enabled call. To unscramble a privacy-enabled call, your radio must have the same Privacy Key, OR the same Key Value and Key ID (programmed by your dealer), as the transmitting radio (the radio you are receiving the call from).



Note:

See [Privacy](#) on page 237 for more information.

Receiving and Responding to a Group Call

To receive a call from a group of users, your radio must be configured as part of that group.

When you receive a Group Call (while on the Home screen), the LED blinks green. The first line of the display shows the RSSI icon. The second line displays the Group Call icon. The third line displays the Group Alias. The fourth line shows the Caller Alias. Your radio unmutes and the incoming call sounds through the radio's speaker.

- 1 Hold the radio vertically 1 to 2 inches (2.5 to 5.0 cm) from your mouth.
The LED lights up solid green.

- 2 Wait for one of the Talk Permit Tone to finish (if enabled), and speak clearly into the microphone.

- 3 Release the **PTT** button to listen.
If there is no voice activity for a predetermined period of time, the call ends.



Note:

See [Making a Group Call](#) on page 189 for details on making a Group Call.

If the radio receives a Group Call while not on the Home screen, it remains on its current screen prior to answering the call.

Long press the  button to go to the Home screen to view the caller alias before replying.

Receiving and Responding to a Private Call

A Private Call is a call from an individual radio to another individual radio.

When you receive a Private Call, the LED blinks green. The first line of the display shows the RSSI icon. The second line displays the Private Call icon. The third line shows the Caller Alias. Your radio unmutes and the incoming call sounds through the speaker of the radio.

- 1 Hold the radio vertically 1 to 2 inches (2.5 to 5.0 cm) from your mouth.

- 2 Press the **PTT** button to respond to the call.
The LED lights up solid green.

- 3 Wait for the Talk Permit Tone to finish (if enabled), and speak clearly into the microphone.

4 Release the **PTT** button to listen.

If there is no voice activity for a predetermined period of time, the call ends.

The display shows `Call Ended`.

See [Making a Private Call](#) on page 190 for details on making a Private Call.

Receiving a Site All Call

A Site All Call is a call from an individual radio to every radio on the site. It is used to make important announcements requiring the user's full attention.

When you receive an Site All Call, a tone sounds and the LED blinks green.

The first line of the display shows the RSSI icon. The second line displays the Site All Call icon. The third line displays `Site All Call`. The fourth line displays the Caller Alias. Your radio unmutes and the incoming call sounds through the radio speaker.

Once the Site All Call ends, the radio returns to the previous screen before receiving the call. A Site All Call does not wait for a predetermined period of time before ending.

You cannot respond to an Site All Call.



Note:

See [Making a Site All Call](#) on page 191 for details on making a Site All Call.



Note:

The radio stops receiving the Site All Call if you switch to a different channel while receiving the call. During a Site All Call, you will **not** be able to use any programmed button functions until the call ends.

Receiving an Inbound Private Phone Call

When you receive an Inbound Private Phone Call, the Phone Call as Private Call icon appears in the top right corner. The first text line shows `Phone Call`.

- 1 Press and hold the **PTT** button to answer and talk. Release the **PTT** button to listen.
-

- 2 Long press  to end the call. The first line of the display shows `Ending`. The second line of the display shows `Phone Call....`. The display returns to the Phone Call screen.



The display shows `Phone Call Ended`.

Making a Buffered Over-Dial in an Inbound Phone Private Call

During the call, the Phone Call as Private Call icon appears in the top right corner. The first text line of the display shows Phone Call.

- 1 Use the keypad to enter the digits and press the

 button.

Press  followed by  within 2 seconds to insert a pause. The P replaces * and # on the display.

The Phone Call as Private Call icon appears in the top right corner. The first text line of the display shows the entered digits.

- 2 Long press  to end the call.

The first line of the display shows Ending. The second line of the display shows Phone Call.... The display returns to the Phone Call screen.

The display shows Phone Call Ended.

Making a Live Over-Dial in an Inbound Phone Private Call

During the call, the Phone Call as Private Call icon appears in the top right corner. The first text line of the display shows Phone Call.

- 1 Press the **PTT** button and use the keypad to enter the digits.

The Phone Call as Private Call icon appears in the top right corner. The first text line of the display shows the Live Dial digits.

- 2 Long press  to end the call.

The first line of the display shows Ending. The second line of the display shows Phone Call.... The display returns to the Phone Call screen.

The display shows Phone Call Ended.

Receiving an Inbound Phone Talkgroup Call

When you receive an Inbound Phone Talkgroup Call, the Group Call icon appears in the top right corner. The first text line shows Call1.

Press the **PTT** button to talk and release it to listen.

Inbound Phone Multi-Group Call

When you receive an Inbound Phone Multi-Group Call, the Group Call icon appears in the top right corner. The first text line shows `Multigroup Call`. The radio unmutes and the incoming multi-group call sounds through the radio's speaker.

Making a Radio Call

After selecting your channel, you can select a subscriber alias or ID, or group alias or ID by using:

- The **PTT** button.
- A programmed **One Touch Access** button – The One Touch Access feature allows you to make a Private Call to a predefined ID easily. This feature can be assigned to a short or long programmable button press. You can **ONLY** have one ID assigned to a **One Touch Access** button. Your radio can have multiple **One Touch Access** buttons programmed.
- The Contacts list (see [Contacts Settings](#) on page 207).



Note:

Your radio must have the Privacy feature enabled on the channel to send a privacy-enabled transmission. Only target radios with the same Key Value and Key ID as your radio will be able to unscramble the transmission.



Note:

See [Privacy](#) on page 237 for more information.

Making a Call

Making a Group Call

To make a call to a group of users, your radio must be configured as part of that group.

- 1 Select the channel with the active group alias or ID. See [Selecting a Call Type](#) on page 185.
 - 2 Hold the radio vertically 1 to 2 inches (2.5 to 5.0 cm) from your mouth.
 - 3 Press the **PTT** button to make the call. The LED lights up solid green. The Group Call icon appears in the top right corner. The first text line shows the group call alias.
-

4 Wait for the Talk Permit Tone to finish (if enabled), and speak clearly into the microphone.

5 Release the **PTT** button to listen.

When the target radio responds, the LED blinks green, the radio unmutes and the response sounds through the radio's speaker. You see the Group Call icon, the group alias or ID, and transmitting radio alias or ID on your display.

If there is no voice activity for a predetermined period of time, the call ends. Radio returns to the screen you were on prior to initiating the call.

Making a Private Call

While you can receive and/or respond to a Private Call initiated by an authorized individual radio, your radio must be programmed for you to initiate a Private Call.

You will hear a negative indicator tone, when you make a Private Call via the Contacts list, Call Log, **One Touch Access** button, if this feature is not enabled.

Use the Text Message or Call Alert features to contact an individual radio. See [Text Message](#)

[Features](#) on page 222 or [Call Alert Operation](#) on page 93 for more information.

1 Do one of the following.

- Select the channel with the active subscriber alias or ID. See [Selecting a Call Type](#) on page 185.
 - Press the programmed **One Touch Access** button.
-

2 Hold the radio vertically 1 to 2 inches (2.5 to 5.0 cm) from your mouth.

3 Press the **PTT** button to make the call.

If you release the **PTT** button while the radio is setting up the call, it exits without any indication and returns to the previous screen.

The LED lights up solid green, the radio unmutes and the response sounds through the radio's speaker. The Private Call icon appears on the top right corner. The first text line shows the target subscriber alias. The second text line displays the call status.

4 Wait for the Talk Permit Tone to finish (if enabled), and speak clearly into the microphone.

5 Release the **PTT** button to listen.

When the target radio responds, the LED blinks green, the radio unmutes and the response sounds through the radio's speaker.

If there is no voice activity for a predetermined period of time, the call ends. You hear a short tone. The display shows `Call Ended`.

Your radio may be programmed to perform a radio presence check prior to setting up the Private Call. If the target radio is not available, you hear a short tone and see negative mini notice on the display.

Making a Site All Call

This feature allows you to transmit to all users on the site that are currently not engaged in another call. Your radio must be programmed to allow you to use this feature.

Users on the channel/site cannot respond to an Site All Call.

- 1 Select the channel with the active Site All Call group alias. See [Selecting a Call Type](#) on page 185.

- 2 Hold the radio vertically 1 to 2 inches (2.5 to 5.0 cm) from your mouth.

- 3 Press the **PTT** button to make the call. The LED lights up solid green. The Group Call icon appears in the top right corner. The first text line shows `Site All Call`.

- 4 Wait for the Talk Permit Tone to finish (if enabled), and speak clearly into the microphone.

Making a Multi-group Call

This feature allows you to transmit to all users on multiple groups. Your radio must be programmed to allow you to use this feature.



Note:

Users on the groups cannot respond to a Multi-group Call.

- 1 Select the channel with the active Multi-group alias or ID. See [Selecting a Channel](#) on page 47.
- 2 Press the **PTT** button to make the call. The LED lights up solid green. The display shows the Multi-group alias or ID.

Wait for the Talk Permit Tone to finish (if enabled) and speak clearly into the microphone.

Making a Private Call with a One Touch Call Button



Note:

Programmable buttons press must be initiated from the Home screen.

The One Touch Call feature allows you to easily make a Private Call to a pre-defined Private Call alias or ID. This feature can be assigned to a short or long programmable button press.

You can **ONLY** have one alias or ID assigned to a One Touch Call button. Your radio can have multiple One Touch Call buttons programmed.

- 1 Press the programmed **One Touch Call** button to make a Private Call to the pre-defined Private Call alias or ID.

- 2 Hold the radio vertically 1 to 2 inches (2.5 to 5.0 cm) from your mouth.

- 3 Press the **PTT** button to make the call.
The LED lights up solid green.

The display shows the Private Call alias or ID.

- 4 Wait for the Talk Permit Tone to finish (if enabled) and speak clearly into the microphone.

- 5 Release the **PTT** button to listen.
When the target radio responds, the LED blinks green.
If there is no voice activity for a predetermined period of time, the call ends.

Making a Call with the Programmable Manual Dial Button

Making a Private Call

- 1 Press the programmed **Manual Dial** button to enter into the Manual Dial screen.
The display shows **Number: .**

- 2 Use the keypad to enter a subscriber alias or Private ID.

- 3 Hold the radio vertically 1 to 2 inches (2.5 to 5.0 cm) from your mouth.



- 4 Press the **PTT** button to make the call.

The LED lights up solid green. The Private Call icon appears in the top right corner. The first text line shows the subscriber alias. The second text line displays the call status.

-
- 5 Wait for the Talk Permit Tone to finish (if enabled) and speak clearly into the microphone.
-
- 6 Release the **PTT** button to listen.
When the target radio responds, the LED blinks green.
If there is no voice activity for a predetermined period of time, the call ends. You hear a short tone. The display shows `Call Ended`.
-

Making an Outbound Private Phone Call with the Programmable Manual Dial Button

- 1 Press the programmed **Manual Dial** button to enter into the Manual Dial screen.
The display shows `Number:.`
-
- 2 Use the keypad to enter a telephone number, and press  to place a call to the entered number.

Press  to delete any unwanted characters. Press  followed by  within 2 seconds to insert a pause. The P replaces * and # on the display.

If successful, the first line of the display shows `Phone Call`. The second line of the display shows the dialed telephone number.

If an invalid telephone number is selected, the display shows a negative mini notice, `Phone Call Failed, Resource Not Available, or Invalid Permissions`.

If  is pressed with no telephone number entered, the radio sounds a positive indicator tone then a negative indicator tone. The display remains the same.



-
- 3 Long press  to end the call.

The first line of the display shows `Ending`. The second line of the display shows `Phone Call....`

The display shows `Phone Call Ended`.



Making an Outbound Private Phone Call via the Phone Menu

- 1  to access the menu.

- 2  or  to Phone and press  to select.

- 3 Press  to select Manual Dial.
The first line of the display shows Number, the second line of the display shows a blinking cursor.

- 4 Use the keypad to enter a telephone number, and press  to place a call to the entered number.

Press  to delete any unwanted characters. Press  followed by  within 2 seconds to insert a pause. The P replaces * and # on the display.

If successful, the first line of the display shows Phone Call. The second line of the display shows the dialed telephone number.

If an invalid telephone number is selected, the display shows a negative mini notice, Phone Call

Failed, Resource Not Available, or Invalid Permissions.

If  is pressed with no telephone number entered, the radio sounds a positive indicator tone then a negative indicator tone. The display remains the same.

- 5 Long press  to end the call.
The first line of the display shows Ending. The second line of the display shows Phone Call....
The display shows Phone Call Ended.



Making an Outbound Private Phone Call from Contacts









Note:

If the Phone Manual Dial is disabled in MOTOTRBO Connect Plus Option Board CPS, the Phone Number item will **not** be displayed in the Menu.

- 1  to access the menu.

- 2  or  to Contacts and press  to select.

- 3 ▲ or ▼ to Manual Dial and press  to select.
-
- 4 ▲ or ▼ to Phone Number and press  to select.
The first line of the display shows Number, the second line of the display shows a blinking cursor.
-
- 5 Use the keypad to enter a telephone number, and press  to place a call to the entered number.
If the **PTT** button is pressed, the display shows a negative mini notice, Press OK to Send and returns to the previous screen.
Press  to delete any unwanted characters. Press  followed by  within 2 seconds to insert a pause. The P replaces * and # on the display.
If successful, the first line of the display shows Phone Call. The second line of the display shows the dialed telephone number.
If  is pressed with no telephone number entered, the radio sounds a positive indicator tone

then a negative indicator tone. The display remains the same.

-
- 6 Long press  to end the call.
The first line of the display shows Ending. The second line of the display shows Phone Call....
The display shows Phone Call Ended.

Waiting for the Channel Grant in an Outbound Private Phone Call

When you make a Private Phone Call, the first line of the display shows Phone Call. The second line of the display shows the dialed telephone number.

When the call is connected, the Phone Call as Private Call icon appears in the top right corner. The first line of the display shows the telephone number.

If unsuccessful, the display shows a negative mini notice, Phone Call Failed, Resource Not Available, or Invalid Permissions.



Long press  to end the call.

The display returns to the previous screen.

Making a Buffered Over-Dial in a Connected Outbound Private Phone Call

During the call, the Phone Call as Private Call icon appears in the top right corner. The first text line of the display shows the telephone number.

- 1 Use the keypad to enter the digits.

Press  to delete any unwanted characters. Press  followed by  within 2 seconds to insert a pause. The P replaces * and # on the display.



The first text line of the display shows Extra Digits, the second text line of the display shows the entered extra digits.

-
- 2 Press the  button.

If the **PTT** button is pressed, the display shows a negative mini notice, Press OK to Send and returns to the previous screen.

The Phone Call as Private Call icon appears in the top right corner. The first text line of the display shows the telephone number with the over-dial digits appended.

-
- 3 Do one of the following.

- Press  to return to the Phone Call screen.
- Long press  to end the call.

Making a Live Over-Dial in a Connected Outbound Private Phone Call

During the call, the Phone Call as Private Call icon appears in the top right corner. The first text line of the display shows the telephone number.

- 1 Press the **PTT** button and use the keypad to enter the digits.
The Phone Call as Private Call icon appears in the top right corner. The first text line of the display shows the telephone number with the over-dial digits appended.

-
- 2 Long press  to end the call.

The first line of the display shows Ending. The second line of the display shows Phone Call....

The display shows Phone Call Ended.

Advanced Features in Connect Plus Mode

Auto Fallback

Auto Fallback is a system feature that allows you to continue to make and receive non-emergency calls on the selected Group Contact in the event of certain types of Connect Plus system failures.

If one of these failures occurs, your radio attempts to roam to a different Connect Plus site. This search process may result in your radio finding an operable Connect Plus site, or it may result in your radio finding a “Fallback Channel” (if your radio is enabled for Auto Fallback). A Fallback Channel is a repeater that is normally part of an operable Connect Plus site, but is currently unable to communicate with either its site controller or the Connect Plus network. In Fallback mode, the repeater operates as a single digital repeater. Auto Fallback Mode supports non-emergency Group Calls only. No other call types are supported in Fallback Mode.

Indications of Auto Fallback Mode

When your radio is using a Fallback channel, you hear the intermittent “Fallback Tone” approximately once every 15 seconds (except while transmitting). The display periodically shows a brief message, “Fallback Channel”. Your radio only permits PTT on the selected Group Contact (Group Call, Multigroup Call, or Site All Call). It does not allow you to make other types of calls.

Making/Receiving Calls in Fallback Mode

**Note:**

Calls are heard only by radios that are monitoring the same Fallback channel and selected to the same Group. Calls are not networked to other sites or other repeaters.

Emergency voice calls or Emergency Alerts are not available in Fallback mode. If you press the emergency button in Fallback mode, the radio provides an invalid key press tone. Display-equipped radios also show the message, “Feature not available”.

Private (radio to radio) and Phone calls are not available in Fallback mode. If you attempt a

call to a private contact, you will receive a denial tone. At this point you should select a desired group contact. Other non-supported calls include Remote Monitor, Call Alert, Radio Check, Radio Enable, Radio Disable, Text messaging, Location Updates, and packet data calls.

Enhanced Traffic Channel Access (ETCA) is not supported in Auto Fallback mode. If two or more radio users press **PTT** at the same time (or at almost the same time), it is possible that both radios transmit until **PTT** is released. In this event, it is possible that none of the transmissions will be understood by receiving radios.

Making calls in Fallback mode is similar to normal functioning. Simply select the group contact you wish to use (using the radio's normal channel selection method), and then press the **PTT** to start your call. It is possible that the channel may be in use already by another group. If the channel is in use, you receive a busy tone and the display will say "Channel Busy". You may select Group, Multi-group or Site All Call contacts using your radio's normal channel selection method. While the radio is operating on the Fallback Channel, the Multigroup operates just like other

Groups. It is only heard by radios that are currently selected to the same Multi-group.

Returning to Normal Operation





If the site returns to normal trunking operation while you are in range of your Fallback repeater, your radio automatically exits Auto Fallback mode. You hear a registration "beep" when the radio successfully registers. If you are in the range of an operable site (that is not in Fallback mode), you may press the Roam Request button (if programmed for your radio) to force your radio to search for and register on an available site. If no other site is available, your radio returns to Auto Fallback mode after searching is complete. If you drive out of coverage of your Fallback repeater, your radio enters Search mode (display indicates "Searching").

Radio Check

If enabled, this feature allows you to determine if another radio is active in a system without disturbing the user of that radio. No audible or visual notification is shown on the target radio.

Sending a Radio Check

- 1 Access the Radio Check feature.

| Radio Control | Steps |
|-------------------------------|--|
| Programmed Radio Check button | <ol style="list-style-type: none"> 1 Press the programmed Radio Check button. 2 ▲ or ▼ to the required subscriber alias or ID and press  to select. |
| Menu | <ol style="list-style-type: none"> 1  to access the menu. 2 ▲ or ▼ to <code>Contacts</code> and press  to select. 3 ▲ or ▼ to the required subscriber alias or ID and press  to select. 4 ▲ or ▼ to <code>Radio Check</code> and press  to select. |

The display shows the Target Alias, indicating the request is in progress. The LED lights up solid green.

2 Wait for acknowledgement.

If the target radio is active in the system, a tone sounds and the display briefly shows `Target Radio Available`.

If the target radio is not active in the system, a tone sounds and the display briefly shows `Target Radio Not Available`.

Radio returns to the subscriber alias or ID screen when initiated via Menu.

Radio returns to the Home Screen if initiated via the programmable button.

Remote Monitor

Use the Remote Monitor feature to turn on the microphone of a target radio (subscriber alias or IDs only). The green LED will blink once on the target subscriber. You can use this feature to monitor, remotely, any audible activity surrounding the target radio.

Your radio must be programmed to allow you to use this feature.



Initiating Remote Monitor





Note:

Remote Monitor automatically stops after a programmed duration or when there is any attempt to initiate transmission, change channels or power down the radio.

- 1 Access the Remote Monitor feature.

| Radio Control | Steps |
|----------------------------------|---|
| Programmed Remote Monitor Button | <ol style="list-style-type: none"> 1 Press the programmed Remote Monitor button. 2 ▲ or ▼ to the required subscriber alias or ID and press  to select. |
| Menu | <ol style="list-style-type: none"> 1  to access the menu. 2 ▲ or ▼ to Contacts and press  to select. |

| Radio Control | Steps |
|---------------|--|
| | <ol style="list-style-type: none"> 3 ▲ or ▼ to the required subscriber alias or ID and press  to select. 4 ▲ or ▼ to Manual Dial and press  to select. 5 ▲ or ▼ to Remote Mon. and press  to select. |

The first text line shows **Rem. Monitor**. The second text line displays the **Target Alias**, indicating the request is in progress. The LED lights up blinking green.

- 2 Wait for acknowledgement.



If successful, a positive indicator tone sounds and the display momentarily shows **Rem. Monitor Successful**. Your radio starts playing audio from the monitored radio for a programmed duration and display shows **Rem. Monitor**, followed by



target alias. Once the timer expires, the radio sounds an alert tone and the LED turns off.

If unsuccessful, the radio sounds a negative indicator tone the display shows Rem. Monitor Failed.

You can start and stop scanning by pressing the programmed **Scan** button **OR** follow the procedure described next.

1  to access the menu.

2  or  to Scan and press  to select.

3  or  to Turn On or Turn Off and press  to select.

- The display shows Scan On if scan is enabled.
- The Scan menu shows Turn Off if scan is enabled.
- The display shows Scan Off if scan is disabled.
- The Scan menu shows Turn On if scan is disabled.

Scan

This feature allows your radio to monitor and join calls for groups defined in a pre-programmed scan list. When scan is enabled, the scan icon appears on the status bar and the LED blinks yellow when idle.

Starting and Stopping Scan



Note:

This procedure turns the Scan feature On or Off for all Connect Plus zones with the same Network ID as your currently selected zone. It is important to note that even when the Scan feature is turned on via this procedure, scan may still be disabled for some (or all) groups on your scan list. See [Editing the Scan List](#) on page 203 for more information.

Responding to a Transmission During a Scan

During scanning, your radio stops on a group where activity is detected. The radio continuously listens for any member in the scan list when idle on the control channel.

- 1 Hold the radio vertically 1 to 2 inches (2.5 to 5.0 cm) from your mouth.

- 2 Press the **PTT** button during hang time. The LED lights up solid green.

- 3 Wait for the Talk Permit Tone to finish (if enabled), and speak clearly into the microphone.

- 4 Release the **PTT** button to listen.
If you do not respond within the hang time, the radio returns to scanning other groups.

User Configurable Scan

If the Edit List menu is enabled, a user is able to Add and Remove the scan members from the Add Member menu. A Scan List member must be a regular Group Contact (i.e. not Multi-group or Site All Call/Network Wide All Call) that is currently assigned to a Channel Selector position in a Connect Plus Zone with the same Network ID as the currently selected Zone. The Talkgroup alias must not match any Talkgroup that has been included in the current Zone's Scan List.

Scan can be turned on or off from the menu or by pressing a programmed **Scan On/Off** button.

This feature functions only when the radio is not currently involved in a call. If you are presently listening to a call, your radio cannot scan for other group calls, and is therefore unaware they are in progress. Once your call is finished, your radio returns to the control channel time slot and is able to scan for groups that are in the scan list.

Turning Scan On or Off







Note:



This procedure turns the Scan feature On or Off for all zones with the same Network ID as your currently selected zone. It is important to note that even when the Scan feature is turned on via this procedure, scan may still be disabled for some (or all) groups on your scan list. See the next section for more information.

If Scan is turned on, the Scan icon appears on your display. When Scan is on and you are not participating in a call, the LED blinks green and yellow.

The procedure for turning Scan on or off depends on how your radio is programmed. If programmed with a Scan On/Off button, use the button to toggle the feature on or off. If your radio has been programmed so that Scan can be turned on or off via the menu, follow the procedure described next.

- 1  to access the menu.

- 2  or  to Scan and press  to select.

- 3  or  to Turn On or Turn Off and press  to select.
 - The display shows Scan On momentarily if scan is disabled.
 - The display shows Scan Off momentarily if scan is enabled.

Editing the Scan List



Note:

If the scan list entry happens to be the radio's currently selected group, the radio listens for activity on this group regardless of whether the

list entry currently shows a check mark or not. Whenever a radio is not in a call, the radio listens for activity on its Selected Group, Multigroup, the Site All Call, and its Default Emergency Revert Group (if configured for one). This operation cannot be disabled. If Scan is enabled the radio will also listen for activity on enabled Zone Scan List members.

Your scan list determines which groups can be scanned. The list is created when your radio is programmed. If your radio has been programmed to allow you to edit the scan list, you can,

- Enable/disable scan for individual groups on the list.
- Add and Remove the scan members from the Add Member menu. Refer to [Add or Delete a Group via the Add Members Menu](#) on page 204.







Note:

A Scan List member must be a regular Group Contact (i.e. not Multigroup or Site All Call/ Network Wide All Call) that is currently assigned to a Channel Selector position in a Connect Plus Zone with the same Network ID as the currently selected Zone.

The Talkgroup alias must not match any Talkgroup that has been included in the current Zone's Scan List.

1  to access the menu.

2  or  to View/Edit List and press  to select.

3  or  to the desired Group name.

If a check mark precedes the Group name, then scan is currently enabled for this Group.

If there is no check mark preceding the Group name, then scan is currently disabled for this Group.

4  to select the desired Group.

The display shows `Enable` if scan is currently disabled for the Group.

The display shows `Disable` if scan is currently enabled for the Group.

5 Select the displayed option (`Enable` or `Disable`) and press  to select. Depending on which option was selected, the radio momentarily displays `Scan Enabled` or `Scan Disabled` as confirmation.

The radio displays the Zone scan list again. If scan was enabled for the Group, the check mark displays before the Group name. If scan was disabled for the Group, the check mark is removed before the Group name.

Add or Delete a Group via the Add Members Menu



The Connect Plus radio does not allow a duplicate group number or a duplicate group alias to be placed on a zone scan list (or to be shown as a “scan candidate”). Thus, the list of “scan candidates” described in steps 6 and 7 sometimes changes after adding or deleting a group from the zone scan list.

If your radio has been programmed to allow you to edit the scan list, you can use the Add Members menu to add a group to the scan list of the currently

selected zone, or to delete a group from the scan list of the currently selected zone.

1  to access the menu.



2  or  to Scan option and press  to select.

3  or  to <Add Members> and press  to select.

The display shows “Add Members from Zone n” (n = the Connect Plus zone number of the first Connect Plus zone in your radio with the same Network ID as your currently selected zone).

4 Do one of the following.



- If the group you want to add to the scan list is assigned to a channel selector position in that zone, go to step 6.
 - If the group you want to add to the scan list is assigned to a channel selector position in a different Connect Plus zone, go to step 5.
-

5  or  to scroll a list of Connect Plus zones that have the same Network ID as the currently selected zone.

6 After locating the Connect Plus zone where the desired group is assigned to a channel selector position, press  to select.

Your radio displays the first entry in a list of groups assigned to a channel position in that zone. The groups on the list are called “scan candidates”, because they can be added to the scan list of your currently selected zone (or they are already on the zone scan list).

If the zone does not have any groups that can be added to the scan list, the radio displays No Candidates.

7  or  to scroll through the list of candidate groups.

If a plus sign (+) is displayed immediately before the group alias, this indicates the group is currently on the scan list for the selected zone.

If the plus sign (+) is not displayed immediately before the alias, the group is not currently on the scan list, but can be added.

-
- 8 Press  when the desired group alias is displayed.

If this group is not currently on the scan list for the currently selected zone, the **Add (Group Alias)** message is displayed.

If this group is already on the scan list for the currently selected zone, the **Delete (Group Alias)** message is displayed.

-
- 9 Press  to accept the displayed message (**Add** or **Delete**).

If deleting a group from the list, you will know the operation is successful because the plus sign (+) will no longer display immediately before the alias.

If adding a group to the list, you will know the operation is successful because the plus sign (+) will display before the alias.

If you are attempting to add a group, and the list is already full, the radio displays **List Full**. If this

should occur, it will be necessary to delete a group from the scan list prior to adding a new one.

-
- 10 When finished, press  as many times as necessary to return to the desired menu.
-

Understanding Scan Operation



Note:

If the Radio joins a call for a Zone Scan List member from a different Zone and Call Hang Timer expires before you are able to respond, in order to respond, you must navigate to the Zone and Channel of the Scan List Member and start a new call.

There are some circumstances in which you can miss calls for groups that are in your scan list. When you miss a call for one of the following reasons, this does not indicate a problem with your radio. This is a normal scan operation for Connect Plus.

- Scan feature is not turned on (check for the scan icon on the display).
- Scan list member has been disabled via the menu (see [Editing the Scan List](#) on page 203).
- You are participating in a call already.

- No member of the scanned group is registered at your site (Multisite systems only).

Scan Talkback

If your radio scans into a call from the selectable group scan list, and if the **PTT** button is pressed during the scanned call, the operation of the radio depends on whether Scan Talkback was enabled or disabled during radio programming. For more information on how your radio is programmed, contact your radio dealer (or your radio system administrator).

Scan Talkback Disabled The radio leaves the scanned call and attempts to transmit on the contact for the currently selected channel position. After the Call Hang Time on the currently selected contact expires, the radio returns to the home channel and starts the Scan Hang Time Timer. The radio resumes group scan after its Scan Hang Time Timer expires.

Scan Talkback Enabled If the **PTT** button is pressed during the Group Hang Time of the scanned call,

the radio attempts to transmit to the scanned group.



Note:

If you scan into a call for a group that is not assigned to a channel position in the currently selected zone and you miss the Hang Time of the call, switch to the proper zone and then select the channel position of the group to talk back to that group.

Contacts Settings



Note:

You can add, or edit subscriber IDs for Connect Plus Contacts. Deleting subscriber IDs can only be performed by your dealer.

If the Privacy feature is enabled on a channel, you can make a privacy-enabled voice call on that channel. Only target radios with the same Privacy Key, or the same Key Value and Key ID as your radio are able to unscramble the transmission.

Contacts provide “address-book” capabilities on your radio. Each entry corresponds to an alias or ID that you use to initiate a call.



Each zone provides a Contact List with up to 100 contacts. The following contact types are available:

- Private Call
- Group Call
- Multigroup Call
- Site All Call Voice
- Site All Call Text
- Dispatch Call







The Dispatch Call contact type is used to send a text message to a dispatcher PC through a third-party Text Message Server.

Making a Private Call from Contacts

- 1 Press  to access the menu.

- 2 Press  or  to **Contacts** and press  to select. The entries are alphabetically sorted.

- 3 Use one of the steps described next to select the required subscriber alias:
 - Select the subscriber alias directly.

- Press  or  to the required subscriber alias or ID.
- Use the **Manual Dial** menu.
 - Press  or  to **Manual Dial** and press  to select.
 - If there was previously dialed ID, the ID appears along with a blinking cursor. Use the keypad to edit/enter the ID. Press  to select.

4 Hold the radio vertically 1 to 2 inches (2.5 to 5.0 cm) from your mouth.

5 Press the **PTT** button to make the call. The LED lights up solid green.

6 Wait for the Talk Permit Tone to finish (if enabled), and speak clearly into the microphone.

7 Release the **PTT** button to listen.

When the target radio responds, the LED blinks green and the display shows the transmitting user's ID.

If there is no voice activity for a predetermined period of time, the call ends.



You hear a short tone. The display shows `Call Ended`.



Making a Call Alias Search

You can also use alias or alphanumeric search to retrieve the required subscriber alias.

This feature is only applicable while in Contacts.

- 1  to access the menu.

 - 2  or  to `Contacts` and press  to select.
The entries are alphabetically sorted.

 - 3 Key in the first character of the required alias, and then press  or  to locate the required alias.

 - 4 Hold the radio vertically 1 to 2 inches (2.5 to 5.0 cm) from your mouth.

 - 5 Press the **PTT** button to make the call.
The LED lights up solid green. The display shows the destination alias.
-

- 6 Wait for the Talk Permit Tone to finish (if enabled), and speak clearly into the microphone.
-

- 7 Release the **PTT** button to listen.



When the target radio responds, the LED blinks green.



If there is no voice activity for a predetermined period of time, the call ends.

The display shows `Call Ended`.

Adding a New Contact

- 1  to access the menu.

 - 2  or  to `Contacts` and press  to select.

 - 3  or  to `New Contact` and press  to select.

 - 4 Use the keypad to enter the contact number and press  to confirm.
-

5 Use the keypad to enter the contact name and press  to confirm.

6 If adding a Radio Contact, ▲ or ▼ to the required ringer type and press  to select. The radio sounds a positive indicator tone and the display shows `Contact Saved`.

4 ▲ or ▼ to `Tones/Alert` and press  to select.

5 ▲ or ▼ to `Call Ringers` and press  to select.

6 ▲ or ▼ to `Call Alert` and press  to select. The current tone is indicated by a ✓.

7 ▲ or ▼ to the required tone and press  to select.

✓ appears beside selected tone.

Call Indicator Settings

Activating and Deactivating Call Ringers for Call Alert

You can select, or turn on or off ringing tones for a received Call Alert.

1  to access the menu.

2 ▲ or ▼ to `Utilities` and press  to select.

3 ▲ or ▼ to `Radio Settings` and press  to select.

Activating and Deactivating Call Ringers for Private Calls

You can turn on or off the ringing tones for a received Private Call.

1  to access the menu.

2 ▲ or ▼ to `Utilities` and press  to select.

3 ▲ or ▼ to **Radio Settings** and press  to select.

4 ▲ or ▼ to **Tones/Alerts** and press  to select.

5 ▲ or ▼ to **Call Ringers** and press  to select.

6 ▲ or ▼ to **Private Call** and press  to select.

7 Press  to enable/disable the Private Call ringing tones.

The display shows ✓ beside Enabled, if Private Call ringing tones are enabled.

The ✓ is not displayed when Private Call ringing tones are disabled.

Activating and Deactivating Call Ringers for Text Message

You can turn on or off the ringing tones for a received Text Message.

1  to access the menu.

2 ▲ or ▼ to **Utilities** and press  to select.

3 ▲ or ▼ to **Radio Settings** and press  to select.

4 ▲ or ▼ to **Tones/Alerts** and press  to select.

5 ▲ or ▼ to **Call Ringers** and press  to select.

6 ▲ or ▼ to **Text Message** and press  to select.

The current tone is indicated by a ✓.

- 7 ▲ or ▼ to the required tone and press  to select.
✓ appears beside selected tone.

Selecting a Ring Alert Type



Note:







The programmed **Ring Alert Type** button is assigned via CPS. Check with your dealer or system administrator to determine how your radio has been programmed.

You can program the radio calls to one predetermined vibrate call. If All Tones status is disabled, the radio displays the All Tone Mute icon.

If All Tones status is enabled, the related ring alert type is displayed.

The radio sounds one vibration if it is a momentary ring style. The radio vibrates repetitively if it is a repetitive ring style. When set to Ring and Vibrate, the radio sounds a specific ring tone if there is any incoming radio transaction (for example, Call Alert or Message). It sounds like a good key tone or missed call. If the notification list is not empty, the radio repeats a vibration every 5 minutes.

You can select a Ring Alert Type by performing one of the following actions.

- Press the programmed **Ring Alert Type** button to access the Ring Alert Type menu.
 - a) Press ▲ or ▼ to Ring, Vibrate, Ring & Vibrate or Silent and press  to select.
- Access this feature via the menu.
 - a) Press  to access the menu.
 - b) Press ▲ or ▼ to Utilities and press  to select.
 - c) Press ▲ or ▼ to Radio Settings and press  to select.
 - d) Press ▲ or ▼ to Tones/Alerts and press  to select.
 - e) Press ▲ or ▼ to Ring Alert Type and press  to select.
 - f) Press ▲ or ▼ to Ring, Vibrate, Ring & Vibrate or Silent and press  to select.

Configuring Vibrate Style



Note:

The programmed **Vibrate Style** button is assigned via CPS. Check with your dealer or system administrator to determine how your radio has been programmed.

You can configure the vibrate style by performing one of the following actions.

- Press the programmed **Vibrate Style** button to access the Vibrate Style menu.
 - a) Press ▲ or ▼ to Short, Medium, or Long and press to select.

- Access this feature via the menu.
 - a) Press to access the menu.
 - b) Press ▲ or ▼ to Utilities and press to select.
 - c) Press ▲ or ▼ to Radio Settings and press to select.
 - d) Press ▲ or ▼ to Tones/Alerts and press to select.

- e) Press ▲ or ▼ to Vibrate Style and press to select.
- f) Press ▲ or ▼ to Short, Medium, or Long and press to select.

Escalating Alarm Tone Volume

You can program your radio to continually alert you when a radio call remains unanswered. This is done by automatically increasing the alarm tone volume over time. This feature is known as Escalert.

Call Log Features

Your radio keeps track of all recent outgoing, answered, and missed Private Calls. Use the call log feature to view and manage recent calls.



You can perform the following tasks in each of your call lists:



- Delete
- View Details



Viewing Recent Calls

The lists are Missed, Answered, and Outgoing.

- 1  to access the menu.



- 2  or  to Call Log and press  to select.



- 3  or  to preferred list and press  to select. The display shows the most recent entry at the top of the list.

- 4  or  to view the list.
Press the **PTT** button to start a Private Call with the current selected alias or ID.



Deleting a Call from a Call List



- 1  to access the menu.





- 2  or  to Call Log and press  to select.

- 3  or  to the required list and press  to select.
When you select a call list and it contains no entries, the display shows *List Empty*, and sounds a low tone if Keypad Tones are turned on

(see [Turning Keypad Tones On or Off](#) on page 144).



- 4  or  to the required alias or ID and press  to select.



- 5  or  to Delete and press  to select.

- 6 Do one of the following:
 - Press  to select Yes to delete the entry. The display shows *Entry Deleted*.
 -  or  to No, and press the  button to return to the previous screen.

Viewing Details from a Call List

- 1  to access the menu.

- 2  or  to Call Log and press  to select.

- 3  or  to the required list and press  to select.

- 4 ▲ or ▼ to the required alias or ID and press  to select.

- 5 ▲ or ▼ to View Details and press  to select.
Display shows details.

- Press the **PTT** button while the display still shows the Call Alert in the Notification List to respond with a Private Call.
- Press  to exit the Notification List. The alert is moved to the Missed Call Log.

See [Notification List](#) on page 249 for details about the Notification List.

See [Call Log Features](#) on page 213 for details about the Missed Call List.

Call Alert Operation

Call Alert paging enables you to alert a specific radio user to call you back when they are able to do so.



This feature is accessible through the menu via Contacts, manual dial or a programmed **One Touch Access** button.



Receiving and Responding to a Call Alert

When you receive a Call Alert page, you see the notification list listing a Call Alert with the alias or ID of the calling radio on the display.

When you hear a repetitive tone and the LED blinks yellow, do one of the following:

Making a Call Alert from the Contact List

- 1  to access the menu.
- 2 ▲ or ▼ to Contacts and press  to select.
- 3 Use one of the steps described next to select the required subscriber alias or ID:
 - select the subscriber alias directly
 - ▲ or ▼ to the required subscriber alias and press  to select.
 - use the Manual Dial menu

- ▲ or ▼ to Manual Dial and press  to select.
- The Manual Dial text entry screen shall be displayed. Enter the Subscriber ID and press .

4 ▲ or ▼ to Call Alert and press to select.

The display shows `Call Alert: <Subscriber Alias or ID>Call Alert` and the subscriber alias or ID, indicating that the Call Alert has been sent.

The LED lights up solid green when your radio is sending the Call Alert.

If the Call Alert acknowledgement is received, the display shows `Call Alert Successful`.

If the Call Alert acknowledgement is not received, the display shows `Call Alert Failed`.

Making a Call Alert with the One Touch Access Button

Press the programmed **One Touch Access** button to make a Call Alert to the predefined alias.

The display shows `Call Alert` and the subscriber alias or ID, indicating that the Call Alert has been sent.

The LED lights up solid green when your radio is sending the Call Alert.

If the Call Alert acknowledgement is received, the display shows `Call Alert Successful`.

If the Call Alert acknowledgement is not received, the display shows `Call Alert Failed`.

Emergency Operation



Note:

If your radio is programmed for Silent or Silent with Voice emergency initiation, in most cases it automatically exits silent operation after the Emergency Call or Emergency Alert is finished. The exception to this rule is when Emergency Alert is the configured Emergency Mode and Silent is the configured Emergency Type. If your radio is programmed in this manner, the silent operation continues until you cancel silent operation by pressing **PTT** or the button configured for Emergency Off.

Emergency voice calls and Emergency Alerts are not supported when operating in Connect Plus Auto Fallback mode. For more information see the [Auto Fallback](#) on page 197.

An Emergency Alert is used to indicate a critical situation. You can initiate an Emergency at any time on any screen display, even when there is activity on the current channel. Pressing the **Emergency** button initiates the programmed Emergency mode. The programmed Emergency mode may also be initiated by triggering the optional Man Down feature. The Emergency feature may be disabled in your radio.

Your dealer can set the duration of a button press for the programmed **Emergency** button, except for long press, which is similar with all other buttons:

Short press Between 0.05 seconds and 0.75 seconds.

Long press Between 1.00 second and 3.75 seconds.

The **Emergency** button is assigned with the Emergency On/Off feature. Check with your dealer for the assigned operation of the **Emergency** button.

- If the short press for the **Emergency** button is assigned to turn on the Emergency mode, then the long press for the **Emergency** button is assigned to exit the Emergency mode.
- If the long press for the **Emergency** button is assigned to turn on the Emergency mode, then the short press for the **Emergency** button is assigned to exit the Emergency mode.

When your radio is selected to a Connect Plus zone, it supports three Emergency modes:

- | | |
|--|---|
| Emergency Call | You must press the PTT button to talk on the assigned emergency time slot. |
| Emergency Call with Voice to Follow | For the first transmission on the assigned emergency time slot, the microphone is automatically unmuted and you may talk without pressing the PTT button. The microphone stays “hot” in this fashion for a time period programmed into the radio. For subsequent transmissions in the same Emergency call, you must press the PTT button. |

Emergency Alert An Emergency Alert is not a voice call. It is an emergency notification that is sent to radios that are configured to receive these alerts. The radio sends an emergency alert via the control channel of the currently registered site. The Emergency Alert is received by radios in the Connect Plus network that are programmed to receive them (no matter which network site they are registered to).

Only one of the Emergency Modes can be assigned to the Emergency button per zone. In addition, each Emergency mode has the following types:

- Regular** Radio initiates an Emergency and shows audio and/or visual indicators.
- Silent** Radio initiates an Emergency without any audio or visual indicators. The radio suppresses all audio or visual indications of the Emergency until you press the **PTT** button to start a voice transmission.

Silent with Voice The same as Silent operation, except that the radio also unmutes for some voice transmissions.

Receiving an Incoming Emergency

Your radio may be programmed to sound an alert tone and also display information about the incoming Emergency. If so programmed, upon receiving the incoming Emergency, the display shows the Emergency Details screen with the emergency icon, the Alias or ID of the radio that requested the Emergency, the Group Contact being used for the Emergency, and one additional line of information. The additional information is the name of the zone that contains the Group Contact.



At the present time, the radio displays only the most recently decoded Emergency. If a new Emergency is received before the prior Emergency is cleared, the details for the new Emergency replace the details of the previous Emergency.

Depending on how your radio has been programmed, the Emergency Details screen (or Alarm List screen) will stay on your radio's display even after the Emergency ends. You can save the emergency details to the Alarm List, or you can delete the

emergency details as described in the following sections.



Saving the Emergency Details to the Alarm List

Saving the emergency details to the Alarm List allows you to view the details again at a later time by selecting Alarm List from the Main Menu.

- 1 While the Emergency Details (or Alarm List) screen is displayed, press . The **Exit Alarm List** screen displays.
-
- 2 Perform one of the following actions:
 - Select **Yes** and press  to save the emergency details to the Alarm List, and to exit the Emergency Details (or Alarm List) screen.
 - Select **No** and press  to return to the Emergency Details (or Alarm List) screen.

Deleting the Emergency Details

- 1 While the Emergency Details screen is displayed, press . The **Delete** screen displays.

- 2 Perform one of the following actions:
 - Select **Yes** and press  to delete the emergency details.
 - Select **No** and press  to return to the Emergency Details screen.

Responding to an Emergency Call



Note:

If you do not respond to the Emergency Call within the time allotted for the Emergency Call Hang Time, the Emergency call will end. If you want to speak to the group after the Emergency Call Hang Time expires, you must first select the channel position assigned to the group (if not already selected). Then, press **PTT** to start a non-Emergency Call to the group.

- 1 When receiving an Emergency Call, press any button to stop all Emergency Call received indications.
-
- 2 Hold the radio vertically 1 to 2 inches (2.5 to 5.0 cm) from your mouth.

- 3 Press the **PTT** button to initiate a voice transmission on the Emergency group. All radios that are monitoring this group hear your transmission.

- 4 Wait for the Talk Permit Tone to finish (if enabled) and speak clearly into the microphone. The LED lights up green.

- 5 Release the **PTT** button to listen. When the emergency initiating radio responds, the LED blinks green, the LED blinks green, the radio unmutes and the response sounds through the radio's speaker. You see the Group Call icon, the group ID, and transmitting radio ID on your display.

Responding to an Emergency Alert

**Note:**

The Group contact used for the Emergency Alert should not be used for voice communication. This could prevent other radios from sending and receiving Emergency Alerts on the same group.

An Emergency Alert from a radio indicates that the user is in an urgent situation. You may respond to the

alert by initiating a private call to the radio who declared the emergency, initiating a group call to a designated talk group, sending the radio a Call Alert, initiating a Remote Monitor of that radio, etc. The proper response is determined by your organization and the individual situation.

Initiating an Emergency Call

**Note:**

If your radio is set to Silent, it does not display any audio or visual indicators during Emergency mode until you press the **PTT** button to initiate a voice transmission.

If your radio is set to Silent with Voice, it does not initially display any audio or visual indicators that the radio is in Emergency mode. However, your radio unmutes for the transmissions of radios responding to your emergency. The emergency indicators only appear once you press the **PTT** button to initiate a voice transmission from your radio.

For both “Silent” and “Silent with Voice” operation, the radio automatically exits silent operation after the Emergency Call is finished.

- 1 Press the programmed **Emergency** button.

- 2 Hold the radio vertically 1 to 2 inches (2.5 to 5.0 cm) from your mouth.

- 3 Press the **PTT** button to initiate a voice transmission on the Emergency group.

When you release the **PTT** button, the Emergency call continues for the time allotted for the Emergency Call Hang Time.

If you press the **PTT** button during this time, the Emergency call continues.

Initiating an Emergency Call with Voice to Follow

Your radio must be programmed for this type of operation.

When enabled for this operation, when you press the programmed **Emergency** button, and when your radio receives the time slot assignment, the microphone is automatically activated without pressing the **PTT** button. This activated microphone state is also known as “hot mic”. The “hot mic” applies to the first voice transmission from your radio during the Emergency call. For subsequent transmissions in

the same Emergency call, you must press the **PTT** button.

- 1 Press the programmed **Emergency** button.

- 2 Hold the radio vertically 1 to 2 inches (2.5 to 5.0 cm) from your mouth.

- 3 The microphone remains active for the “hot mic” time specified in your radio's codeplug programming. During this time, the LED lights up green.

- 4 Press and hold the **PTT** button to talk longer than the programmed duration.

Initiating an Emergency Alert



Note:

If your radio is programmed for “Silent” or “Silent with Voice”, it will not provide any audio or visual indications that it is sending an Emergency Alert. If programmed for “Silent”, the silent operation continues indefinitely until you press PTT or the button configured for “Emergency Off”. If programmed for “Silent with Voice”, the radio automatically cancels

silent operation when the site controller broadcasts the Emergency Alert.

Press the orange **Emergency** button. Upon transmitting the Emergency Alert to the site controller, the radio's display shows the Emergency icon, the Group contact used for the Emergency Alert, and TX Alarm.

Once the Emergency Alert is successfully sent and is being broadcast for other radios to hear, a positive indicator tone sounds and the radio's display shows Alarm Sent. If the Emergency Alert is unsuccessful, a negative indicator tone sounds and the radio displays Alarm Failed.

Exiting Emergency Mode



Note:

If the Emergency call ends due to the expiration of the Emergency Hang Time, but the emergency condition is not over, press the **Emergency** button again to restart the process.

If you initiate an Emergency Alert by pressing the programmed **Emergency** button, your radio

automatically exits Emergency mode after receiving a response from the Connect Plus system.

If you initiate an Emergency call by pressing the programmed **Emergency** button, your radio will be assigned a channel automatically when one becomes available. Once your radio has transmitted a message indicating the emergency, you cannot cancel your Emergency call. However, if you pressed the button by accident or the emergency no longer exists, you may wish to say this over the assigned channel. When you release the **PTT** button, the Emergency call is discontinued after the Emergency Call Hang Time expires.

If your radio was configured for Emergency with Voice to Follow, use the "hot mic" period to explain your error, then press and release the **PTT** button to discontinue the transmission. The Emergency call is discontinued after the Emergency Call Hang Time expires.

Text Message Features

Your radio is able to receive data, for example a text message, from another radio or a text message application.

The **maximum** length of characters for sending a text message, including the subject line (seen when receiving message from an e-mail application), depends on CPS configuration which can be configured up to maximum 280 characters. Your radio can receive a text message with **maximum** length of 280 characters.

If user forwards a text message with characters more than the **maximum** length, the text message will be truncated to the **maximum** length.

The radio exits the current screen once the inactivity timer expires.







Note:



Long press  at any time to return to the Home screen.



Writing and Sending a Text Message



- 1 Access the **Text Message** feature.



| Radio Controls | Steps |
|-----------------|--|
| Programmed Text | Press the programmed Text Message button. |

| Radio Controls | Steps |
|----------------|--|
| Message button | |
| Menu | <ol style="list-style-type: none"> 1  to access the menu. 2  or  to Messages and press  to select. |

- 2  or  to Compose and press  to select. A blinking cursor appears.
- 3 Use the keypad to type your message.

Press  to move one space to the left. Press  or the  key to move one space to the right.

Press the  key to delete any unwanted characters. Long press  to change text entry method.
- 4 Press  once message is composed.

- 5 If you are sending the message, select the recipient by
- ▲ or ▼ to the required alias and press  to select.
 - ▲ or ▼ to Manual Dial, and press  to select. The first line of the display shows Number:1. The second line of the display shows a blinking cursor. Key in the subscriber alias or ID and press .

The display shows *Sending Message*, confirming your message is being sent.

If the message is sent successfully, a tone sounds and the display shows *Message Sent*.

If the message cannot be sent, a low tone sounds and the display shows *Message Send Failed*.



If the text message fails to send, the radio returns you to the *Resend* option screen (see [Managing Fail-to-Send Text Messages](#) on page 228).



Sending a Quick Text Message

Your radio supports a maximum of 10 Quick Text messages as programmed by your dealer.

While Quick Text messages are predefined, you can edit each message before sending it.



- 1 Access the **Text Message** feature.



| Radio Controls | Steps |
|--------------------------------|--|
| Programmed Text Message button | Press the programmed Text Message button. |
| Menu | <ol style="list-style-type: none"> 1  to access the menu. 2 ▲ or ▼ to Messages and press  to select. |

- 2 ▲ or ▼ to Quick Text and press  to select.
- 3 ▲ or ▼ to the required Quick Text and press  to select.

A blinking cursor appears.







- 4 Use the keypad to edit the message, if required.

Press  to move one space to the left. Press  or the  key to move one space to the right.

Press the  key to delete any unwanted characters. Long press  to change the text entry method.







- 5 Press  once message is composed.

- 6 Depending on whether you want to send, save, re-edit, or delete the newly composed message, do one of the following.

-  or  to **Send**, and press  to send the message.
-  or  to **Save**, and press  to save the message to the Drafts folder.
-  to edit the message.

-  again to choose between deleting the message or saving it to the Drafts folder.

- 7 If you are sending the message, select the recipient by

-  or  to the required alias and press  to select.
-  or  to **Manual Dial**, and press  to select. The first line of the display shows **Number:**. The second line of the display shows a blinking cursor. Key in the subscriber alias or ID and press .

The display shows **Sending Message**, confirming your message is being sent.

If the message is sent successfully, a tone sounds and the display shows **Message Sent**.

If the message cannot be sent, a low tone sounds and the display shows **Message Send Failed**.

If the text message fails to send, the radio returns you to the **Resend** option screen (see [Managing Fail-to-Send Text Messages](#) on page 228).

Sending a Quick Text Message with the One Touch Access Button

Press the programmed **One Touch Access** button to send a predefined Quick Text message to a predefined alias.

The display shows *Sending Message*, confirming your message is being sent.

If the message is sent, a tone sounds and the display shows *Message Sent*.

If the message cannot be sent, a low tone sounds and the display shows *Message Send Failed*.

If the text message fails to send, the radio returns you to the *Resend* option screen (see [Managing Fail-to-Send Text Messages](#) on page 228).

Accessing the Drafts Folder

You can save a text message to send it at a later time.

If a **PTT** button press or a mode change causes the radio to exit the text message writing/editing screen while you are in the process of writing or editing a text message, your current text message is automatically saved to the Drafts folder.

The most recent saved text message is always added to the top of the Drafts list.

The Drafts folder stores a maximum of ten (10) last saved messages. When the folder is full, the next saved text message automatically replaces the oldest text message in the folder.







Note:

Long press  at any time to return to the Home screen.

Viewing a Saved Text Message

1 Access the **Text Message** feature.

| Radio Controls | Steps |
|--------------------------------|---|
| Programmed Text Message button | Press the programmed Text Message button. |
| Menu | <ol style="list-style-type: none"> 1  to access the menu. 2  or  to <i>Messages</i> and press  to select. |

2 ▲ or ▼ to Drafts and press  to select.



3 ▲ or ▼ to the required message and press  to select.



Editing and Sending a Saved Text Message

1 Press  again while viewing the message.

2 ▲ or ▼ to Edit and press  to select. A blinking cursor appears.



3 Use the keypad to type your message.

Press  to move one space to the left. Press  or the  key to move one space to the right.

Press the  key to delete any unwanted characters. Long press  to change text entry method.

4 Press  once message is composed.

5 Select the message recipient by

- ▲ or ▼ to the required alias and press  to select.
- ▲ or ▼ to Manual Dial, and press  to select. The first line of the display shows Number: . The second line of the display shows a blinking cursor. Key in the subscriber alias or ID and press .

The display shows Sending Message, confirming your message is being sent.





If the message is sent successfully, a tone sounds and the display shows Message Sent.



If the message cannot be sent, a low tone sounds and the display shows Message Send Failed.



If the text message cannot be sent, it is moved to the Sent Items folder and marked with a Send Failed icon.

Deleting a Saved Text Message from Drafts



1 Access the **Text Message** feature.

| Radio Controls | Steps |
|--------------------------------|--|
| Programmed Text Message button | Press the programmed Text Message button. |
| Menu | <ol style="list-style-type: none"> 1  to access the menu. 2  or  to Messages and press  to select. |

2  or  to Drafts and press  to select.

3  or  to the required message and press  to select.

4 Press  again while viewing the message.

5  or  to Delete and press  to delete the text message.

Managing Fail-to-Send Text Messages

You can select one of the following options while at the Resend option screen:

- Resend
- Forward
- Edit

Resending a Text Message

Press  to resend the same message to the same subscriber/group alias or ID.

If the message is sent successfully, a tone sounds and the display shows the positive mini notice.



If the message cannot be sent, the display shows the negative mini notice.

Forwarding a Text Message

Select Forward to send the message to another subscriber/group alias or ID.

1  or  to Forward and press  to select.

2 Select the message recipient by

- ▲ or ▼ to the required alias or ID and press  to select.
- ▲ or ▼ to Manual Dial, and press  to select. The first line of the display shows Number: . The second line of the display shows a blinking cursor. Key in the subscriber alias or ID and press .

The display shows *Sending Message*, confirming your message is being sent.



If the message is sent successfully, a tone sounds and the display shows *Message Sent*.

If the message cannot be sent, a low tone sounds and the display shows *Message Send Failed*.





Editing a Text Message



Select *Edit* to edit the message before sending it.

- 1 ▲ or ▼ to *Edit* and press  to select. A blinking cursor appears.
- 2 Use the keypad to edit your message.

Press  to move one space to the left. Press  or the  key to move one space to the right.

Press the  key to delete any unwanted characters. Long press  to change text entry method.

- 3 Press  once message is composed.
- 4 Depending on whether you want to send, save, re-edit, or delete the newly composed message, do one of the following.
 - ▲ or ▼ to *Send*, and press  to send the message.
 - ▲ or ▼ to *Save*, and press  to save the message to the Drafts folder.
 -  to edit the message.
 -  again to choose between deleting the message or saving it to the Drafts folder.
- 5 If you are sending the message, select the recipient by

- ▲ or ▼ to the required alias or ID and press  to select.
- ▲ or ▼ to Manual Dial, and press  to select. The first line of the display shows Number: . The second line of the display shows a blinking cursor. Key in the subscriber alias or ID and press .

The display shows *Sending Message*, confirming your message is being sent.

If the message is sent successfully, a tone sounds and the display shows *Message Sent*.

If the message cannot be sent, a low tone sounds and the display shows *Message Send Failed*.

Managing Sent Text Messages

Once a message is sent to another radio, it is saved in Sent Items. The most recent sent text message is always added to the top of the Sent Items list.

The Sent Items folder is capable of storing a maximum of thirty (30) last sent messages. When the folder is full, the next sent text message automatically replaces the oldest text message in the folder.







Note:

Long press  at any time to return to the Home screen.

Viewing a Sent Text Message

- 1 Access the **Text Message** feature.

| Radio Controls | Steps |
|--------------------------------|--|
| Programmed Text Message button | Press the programmed Text Message button. |
| Menu | <ol style="list-style-type: none"> 1  to access the menu. 2 ▲ or ▼ to Messages and press  to select. |

- 2 ▲ or ▼ to Sent Items and press  to select.
- 3 ▲ or ▼ to the required message and press  to select.



The icon at the top right corner of the screen indicates the status of the message (see [Sent Item Icons](#) on page 180).

Sending a Sent Text Message

You can select one of the following options while viewing a sent text message:



- Resend
- Forward
- Edit
- Delete

1 Press  again while viewing the message.

2  or  to one of the following options and press  to select.

| Option | Steps |
|---------|--|
| Forward | Select Forward to send the selected text message to another subscriber/group alias or ID (see Forwarding a Text Message on page 228). |

| Option | Steps |
|--------|---|
| Edit | Select Edit to edit the selected text message before sending it (see Editing a Text Message on page 229). |
| Delete | Select Delete to delete the text message. |
| Resend | <p>Select Resend to resend the selected text message to the same subscriber/group alias or ID.</p> <p>The display shows Sending Message, confirming that the same message is being sent to the same target radio.</p> <p>If the message is sent successfully, a tone sounds and the display shows Message Sent.</p> <p>If the message cannot be sent, a low tone sounds and the display shows Message Send Failed.</p> <p>If the message fails to send, the radio returns you to the Resend option</p> |

| Option | Steps |
|--------|--|
| | <p>screen. Press  to resend the message to the same subscriber/group alias or ID.</p> <p> Note: If you exit the message sending screen while the message is being sent, the radio updates the status of the message in the Sent Items folder without providing any indication in the display or via sound.</p> <p> Note: If the radio changes mode or powers down before the status of the message in Sent Items is updated, the radio cannot complete any In-Progress messages and automatically marks it with a Send Failed icon.</p> |

| Option | Steps |
|--------|--|
| | <p> Note: The radio supports a maximum of five (5) In-Progress messages at one time. During this period, the radio cannot send any new message and automatically marks it with a Send Failed icon.</p> |

If you exit the message sending screen while the message is being sent, the radio updates the status of the message in the Sent Items folder without providing any indication in the display or via sound.





If the radio changes mode or powers down before the status of the message in Sent Items is updated, the radio cannot complete any In-Progress messages and automatically marks it with a Send Failed icon.



The radio supports a maximum of five (5) In-Progress messages at one time. During this

period, the radio cannot send any new message and automatically marks it with a Send Failed icon.

Deleting All Sent Text Messages from Sent Items

- 1 Access the **Text Message** feature by performing one of the following actions:







| Radio Controls | Steps |
|--------------------------------|--|
| Programmed Text Message button | Press the programmed Text Message button. |
| Menu | <ol style="list-style-type: none"> 1  to access the menu. 2  or  to Messages and press  to select. |

- 2  or  to Sent Items and press  to select.

When you select Sent Items and it contains no text messages, the display shows List Empty, and sounds a low tone if Keypad Tones are turned on (see [Turning Keypad Tones On or Off](#) on page 144).

- 3  or  to Delete All and press  to select.

- 4 Choose one of the following.

-  or  to Yes and press  to select. The display shows positive mini notice.
-  or  to No and press  to return to the previous screen.



Receiving a Text Message

When your radio receives a message, the display shows the Notification List with the alias or ID of the sender and the Message icon.

You can select one of the following options when receiving a text message:



- Read
- Read Later
- Delete

Reading a Text Message

- 1  or  to Read? and press  to select.

Selected message in the Inbox opens.

2 Do one of the following:

- Press  to return to the Inbox.
- Press  a second time to reply, forward, or delete the text message.

Managing Received Text Messages

Use the Inbox to manage your text messages. The Inbox is capable of storing a maximum of 30 messages.

Text messages in the Inbox are sorted according to the most recently received.

Your radio supports the following options for text messages:

- Reply
- Forward
- Delete
- Delete All















Note:

If the channel type is not a match, you can only forward, delete, or delete all Received messages.





Long press  at any time to return to the Home screen.



Viewing a Text Message from the Inbox



- 1  to access the menu.
- 2  or  to Messages and press  to select.
- 3  or  to Inbox and press  to select.
- 4  or  to view the messages.
- 5 Do one of the following:
 - Press  to select the current message, and press  again to reply, quick reply, forward, or delete that message.
 - Long press  to return to the Home screen.

Replying to a Text Message from the Inbox

- 1 Access the **Text Message** feature.



| Radio Controls | Steps |
|--------------------------------|--|
| Programmed Text Message button | Press the programmed Text Message button. |
| Menu | <ol style="list-style-type: none"> 1  to access the menu. 2  or  to Messages and press  to select. |



2  or  to Inbox and press  to select.

3  or  to the required message and press  to select.

4 Press  once more to access the sub-menu.

5 Do one of the following:

-  or  to Reply and press  to select.

-  or  to Quick Reply and press  to select.

A blinking cursor appears.

6 Use your keypad to write/edit your message.

7 Press  once message is composed.

The display shows *Sending Message*, confirming your message is being sent.





If the message is sent successfully, a tone sounds and the display shows *Message Sent*.



If the message cannot be sent, a low tone sounds and the display shows *Message Send Failed*.



If the message cannot be sent, the radio returns you to the *Resend* option screen (see [Managing Fail-to-Send Text Messages](#) on page 228).

Deleting a Text Message from the Inbox



1 Access the **Text Message** feature by performing one of the following actions:



| Radio Con- trols | Steps |
|--------------------------------------|--|
| Programmed Text Message button | Press the programmed Text Message button. |
| Menu | <ol style="list-style-type: none"> 1  to access the menu. 2  or  to Messages and press  to select. |

2  or  to Inbox and press  to select.

3  or  to the required message and press  to select.

4 Press  once more to access the sub-menu.





5  or  to Delete and press  to select.



6  or  to Yes and press  to select.

The display shows *Message Deleted*, and the screen returns to the Inbox.

Deleting All Text Messages from the Inbox

- 1 Access the **Text Message** feature by performing one of the following actions:

| Radio Con- trols | Steps |
|--------------------------------------|--|
| Programmed Text Message button | Press the programmed Text Message button. |
| Menu | <ol style="list-style-type: none"> 1  to access the menu. 2  or  to Messages and press  to select. |

- 2  or  to Inbox and press  to select.

When you select *Inbox* and it contains no text messages, the display shows *List Empty*, and sounds a low tone if Keypad Tones are turned on (see [Turning Keypad Tones On or Off](#) on page 144).

3 ▲ or ▼ to Delete All and press  to select.

4 ▲ or ▼ to Yes and press  to select.
The display shows Inbox Cleared.

Privacy

If enabled, this feature helps to prevent eavesdropping by unauthorized users on a channel by the use of a software-based scrambling solution. The signaling and user identification portions of a transmission are not scrambled.

Your radio must have privacy enabled on the current channel selector position to send a privacy-enabled transmission, although this is not a necessary requirement for receiving a transmission. While on a privacy-enabled channel selector position, the radio is still able to receive clear (unscrambled) transmissions.

Your radio supports Enhanced Privacy.

To unscramble a privacy-enabled call transmission, your radio must be programmed to have the same Key Value and Key ID (for Enhanced Privacy) as the transmitting radio.

If your radio receives a scrambled call that is of a different Key Value and Key ID, you hear nothing at all (Enhanced Privacy).

If the radio has a privacy type assigned, the Home screen shows the Secure or Unsecure icon, except when the radio is sending or receiving an Emergency call or alarm.

The LED lights up solid green while the radio is transmitting and blinks green rapidly when the radio is receiving an ongoing privacy-enabled transmission.

You can access this feature by performing one of the following actions:

- Pressing the programmed **Privacy** button to toggle privacy on or off.
- Using the Radio Menu as described by the steps described next.



Note:

Some radio models may not offer this Privacy feature. Check with your dealer or system administrator for more information.

1  to access the menu.

2 ▲ or ▼ to Utilities and press  to select.

3 ▲ or ▼ to Radio Settings or ▲ or ▼ to Connect Plus and press  to select.

4 ▲ or ▼ to Enhanced Privacy.

If the display shows Turn On, press  to enable Privacy. The radio displays a message confirming your selection.

If the display shows Turn Off, press  to disable Privacy. The radio displays a message confirming your selection.

If the radio has a privacy type assigned, the secure or unsecure icon appears on the status bar, except when the radio is sending or receiving an Emergency Alert.

Making a Privacy-Enabled (Scrambled) Call

Toggle privacy on using the programmed privacy button or by using the menu. Your radio must have the Privacy feature enabled for the currently selected channel position to send a privacy-enabled

transmission. When privacy is enabled for the currently selected channel position, all voice transmissions made by your radio will be scrambled. This includes Group Call, Multigroup Call, talk-back during scanned calls, Site All Call, Emergency Call, and Private Call. Only receiving radios with the same Key Value and Key ID as your radio will be able to unscramble the transmission.

Covert Mode

Your radio is capable of Covert Mode. During covert mode, all keypad and programmed button access are blocked. When enabled, all visual indications (display, LED's and backlight) are disabled.

This feature allows audio or tone only via a wired accessory or a Bluetooth accessory.

Entering Covert Mode

Press the  button followed by the 2, 5, and 8 numeric keys in tandem in home screen.

Exiting Covert Mode

To exit Covert Mode, do one of the following:

- Press the  button followed by the 2, 5, and 8 numeric keys in tandem. Radio will go back to normal mode.
- Power cycle the radio via the On/Off button.

Security

You can enable or disable any radio in the system. For example, you might want to disable a stolen radio, to prevent the thief from using it, and enable that radio, when it is recovered.



Note:

Performing Radio Disable and Enable is limited to radios with these functions enabled. Check with your dealer or system administrator for more information.



Radio Disable

- 1 Access this feature by







| Radio Controls | Steps |
|-----------------------------|---|
| Radio Disable button | 1 Press the programmed Radio Disable button. |





Radio Controls

Steps

- 2  or  to the required alias or ID and press  to select.

Radio menu

- 1  to access the menu.
- 2  or  to **Contacts** and press  to select. The entries are alphabetically sorted.
- 3 Use one of the steps described next to select the required subscriber alias or ID:
 - Select the required alias or ID directly.
 -  or  to the required alias or ID and press  to select.
 - Use the **Manual Dial** menu

| Radio Controls | Steps |
|----------------|--|
| | <ul style="list-style-type: none"> • ▲ or ▼ to Manual Dial and press  to select. • ▲ or ▼ to Radio Number and press  to select. • The first line of the display shows Radio Number: . The second line of the display shows a blinking cursor. Use the keypad to enter the subscriber alias or ID and press . |
| | <p>4 ▲ or ▼ to Radio Disable and press  to select.</p> |

The display shows Radio Disable: <Target Alias or ID> and the LED blinks green.



2 Wait for acknowledgement.



If successful, a positive indicator tone sounds and the display shows Radio Disable Successful.



If not successful, a negative indicator tone sounds and the display shows Radio Disable Failed.

Radio Enable

1 Access this feature by

| Radio Controls | Steps |
|----------------------------|---|
| Radio Enable button | <ol style="list-style-type: none"> 1 Press the programmed Radio Enable button. 2 ▲ or ▼ to the required alias or ID and press  to select. |
| Radio menu | <ol style="list-style-type: none"> 1  to access the menu. 2 ▲ or ▼ to Contacts and press  to select. The entries are alphabetically sorted. |

| Radio Controls | Steps |
|----------------|---|
| | <p>3 Use one of the steps described next to select the required subscriber alias or ID</p> <ul style="list-style-type: none"> • Select the required alias or ID directly. <ul style="list-style-type: none"> • ▲ or ▼ to the required alias or ID and press  to select. • Use the Manual Dial menu <ul style="list-style-type: none"> • ▲ or ▼ to Manual Dial and press  to select. • ▲ or ▼ to Radio Number and press  to select. • The first line of the display shows Radio Number:!. The second line of the display |

| Radio Controls | Steps |
|----------------|---|
| | <p>shows a blinking cursor. Use the keypad to enter the subscriber alias or ID and press .</p> <p>4 ▲ or ▼ to Radio Enable and press  to select.</p> |

The display shows Radio Enable: <Subscriber Alias or ID> and the LED lights up solid green.

2 Wait for acknowledgement.

If successful, a positive indicator tone sounds and the display shows Radio Enable Successful.





If not successful, a negative indicator tone sounds and the display shows Radio Enable Failed.

Password Lock Features

If enabled, this feature only allows you access your radio if the correct password is entered upon powering up.

Accessing the Radio from Password

- 1 Power up the radio.
The radio sounds a continuous tone.

- 2 Do one of the following:
 - Enter your current four-digit password with the radio's keypad. The display shows **••••**. Press  to proceed.
 - Enter your current four-digit password. Press  or  to edit each digit's numeric value. Each digit changes to **•**. Press  to move to next digit. Press  to confirm your selection.

You hear a positive indicator tone for every digit entered. Press  to remove each **•** on the display. The radio sounds a negative indicator

tone, if you press  when the line is empty, or if you press more than four digits.

If the password is correct, the radio proceeds to power up. See [Powering Up the Radio](#) on page 24.

If the password is incorrect, the display shows **Wrong Password**. Repeat Step 2.

After the third incorrect password, the display shows **Wrong Password** and then, shows **Radio Locked**. A tone sounds and the LED double blinks yellow.







Note:

The radio is unable to receive any call, including emergency calls, in locked state.

Turning the Password Lock On or Off

- 1  to access the menu.

- 2  or  to **Utilities** and press  to select.

- 3 ▲ or ▼ to Radio Settings and press  to select.

- 4 ▲ or ▼ to Passwd Lock and press  to select.

- 5 Enter the four-digit password.
See Step 2 in [Accessing the Radio from Password](#) on page 242.

- 6 Press  to proceed.

If the password is incorrect, the display shows Wrong Password, and automatically returns to the previous menu.

- 7 If the password entered in the previous step is correct, press  to enable/disable password lock.

The display shows ✓ beside Enabled.
The ✓ disappears from beside Enabled.

Unlocking the Radio from Locked State

- 1 If your radio was powered down after being in the locked state, power up the radio.
A tone sounds and the LED double blinks yellow.
The display shows Radio Locked.

- 2 Wait for 15 minutes.
Your radio restarts the 15 minutes timer for locked state when you power up.

- 3 Repeat Steps 1 and 2 in [Accessing the Radio from Password](#) on page 242.

Changing the Password

- 1  to access the menu.



- 2 ▲ or ▼ to Utilities and press  to select.

- 3 ▲ or ▼ to Radio Settings and press  to select.

- 4 ▲ or ▼ to Passwd Lock and press  to select.

- 5 Enter the four-digit password.
See Step 2 in [Accessing the Radio from Password](#) on page 242.

- 6 Press  to proceed.
If the password is incorrect, the display shows Wrong Password, and automatically returns to the previous menu.

- 7 If the password entered in the previous step is correct,  or  to Change Pwd and press  to select.

- 8 Enter a new four-digit password.
See Step 2 in [Accessing the Radio from Password](#) on page 242.

- 9 Reenter the previously entered four-digit password. See Step 2 in [Accessing the Radio from Password](#) on page 242.

- 10 Press  to proceed.

If the reentered password matches the new password entered earlier, the display shows Password Changed.

If the reentered password does **NOT** match the new password entered earlier, the display shows Passwords Do Not Match.

The screen automatically returns to the previous menu.

Bluetooth Operation



Note:

If disabled via the CPS, all Bluetooth-related features are disabled and the Bluetooth device database is erased.

This feature allows you to use your radio with a Bluetooth-enabled device (accessory) via a wireless Bluetooth connection. Your radio supports both Motorola and COTS (Commercially available Off-The-Shelf) Bluetooth-enabled devices.

Bluetooth operates within a range of 10 meters (32 feet) line of sight. This is an unobstructed path between your radio and your Bluetooth-enabled device.

It is not recommended that you leave your radio behind and expect your Bluetooth-enabled device to work with a high degree of reliability when they are separated.



At the fringe areas of reception, both voice and tone quality will start to sound “garbled” or “broken”. To correct this problem, simply position your radio and Bluetooth-enabled device closer to each other (within the 10-meter/32 feet defined range) to re-establish clear audio reception. Your radio’s Bluetooth function has a maximum power of 2.5 mW (4 dBm) at the 10-meter/32 feet range.





Your radio can support up to 4 simultaneous Bluetooth connections with Bluetooth-enabled devices of unique types. For example, a headset, and a PTT-Only Device (POD). Multiple connections with Bluetooth-enabled devices of the same type are not supported.

Refer to your respective Bluetooth-enabled device’s user manual for more details on your Bluetooth-enabled device’s full capabilities.









Turning Bluetooth On and Off

1  to access the menu.

2  or  to Bluetooth and press  to select.

3  or  to My Status and press  to select. The display shows On and Off. The current status is indicated by a .

4 Do one of the following:



-  or  to On and press  to select. The display shows On and a  appears left of the selected status.
-  or  to Off and press  to select. The display shows Off and a  appears left of the selected status.



Finding and Connecting to a Bluetooth Device









Do not turn off your Bluetooth-enabled device or press  during the finding and connecting operation as this cancels the operation.



1 Turn on your Bluetooth-enabled device and place it in pairing mode. Refer to respective Bluetooth-enabled device’s user manual.

- 2 On your radio, press  to access the menu.

- 3  or  to Bluetooth and press  to select.

- 4  or  to Devices and press  to select.

- 5 Do one of the following:
 -  or  to the required device and press  to select.
 -  or  to Find Devices to locate available devices.  or  to the required device and press  to select.

- 6  or  to Connect and press  to select. Display shows Connecting to <Device>. Your Bluetooth-enabled device may require additional steps to complete the pairing. Refer to respective Bluetooth-enabled device's user manual.

If successful, the radio display shows <Device>Connected. A tone sounds and  appears

besides the connected device. The Bluetooth Connected icon appears on the status bar.

If unsuccessful, the radio display shows Connecting Failed.



Note:



If pin code is required, use the same entry method as Step 2 in [Accessing the Radio from Password](#) on page 242.



Finding and Connecting from a Bluetooth Device (Discoverable Mode)

Do not turn off your Bluetooth or your radio during the finding and connecting operation as this may cancel the operation.

- 1 Turn Bluetooth On.
See [Turning Bluetooth On and Off](#) on page 133.

- 2  to access the menu.

- 3  or  to Bluetooth and press  to select.













- 4  or  to Find Me and press  to select.

Your radio can now be found by other Bluetooth-enabled devices for a programmed duration. This is called Discoverable Mode.

- Turn on your Bluetooth-enabled device and pair it with your radio.

Refer to respective Bluetooth-enabled device's user manual.

Disconnecting from a Bluetooth Device

- On your radio, press  to access the menu.
-  or  to Bluetooth and press  to select.
-  or  to Devices and press  to select.
-  or  to the required device and press  to select.
-  or  to Disconnect and press  to select. Display shows Disconnecting from <Device>. Your Bluetooth-enabled device may require

additional steps to disconnect. Refer to respective Bluetooth-enabled device's user manual.

The radio display shows <Device> Disconnected. A positive indicator tone sounds and  disappears beside the connected device. The Bluetooth Connected icon disappears on the status bar.





Switching Audio Route between Internal Radio Speaker and Bluetooth Device

You can toggle audio routing between internal radio speaker and external Bluetooth-enabled accessory.

Press the programmed **Bluetooth Audio Switch** button.

- A tone sounds and display shows Route Audio to Radio.
- A tone sounds and display shows Route Audio to Bluetooth.

Viewing Device Details

-  to access the menu.
-  or  to Bluetooth and press  to select.

3 ▲ or ▼ to `Devices` and press  to select.

4 ▲ or ▼ to the required device and press  to select.

5 ▲ or ▼ to `View Details` and press  to select.

Editing Device Name

You can edit the name of available Bluetooth-enabled devices.



1  to access the menu.

2 ▲ or ▼ to `Bluetooth` and press  to select.

3 ▲ or ▼ to `Devices` and press  to select.

4 ▲ or ▼ to the required device and press  to select.

5 ▲ or ▼ to `Edit Name` and press  to select.

6 Press ◀ to move one space to the left. Press ▶ to move one space to the right. Press  to delete any unwanted characters. Long press  to change text entry method.

A blinking cursor appears. Use the keypad to type the required zone.

7 The display shows `Device Name Saved`.

Deleting Device Name

You can remove a disconnected device from the list of Bluetooth-enabled devices.

1  to access the menu.

2 ▲ or ▼ to `Bluetooth` and press  to select.





3 ▲ or ▼ to `Devices` and press  to select.

4 ▲ or ▼ to the required device and press  to select.

- 5 ▲ or ▼ to Delete and press  to select.
The display shows Device Deleted.
-

Bluetooth Mic Gain

Allows control of the connected Bluetooth-enabled device's microphone gain value.

- 1  to access the menu.
-
- 2 ▲ or ▼ to Bluetooth and press  to select.
-
- 3 ▲ or ▼ to BT Mic Gain and press  to select.
-
- 4 ▲ or ▼ to the BT Mic Gain type and the current values.
To edit values, press  to select.
-
- 5 ▲ or ▼ to increase or to decrease values and press  to select.
-

Permanent Bluetooth Discoverable Mode



Note:

The Permanent Bluetooth Discoverable Mode can only be enabled via the MOTOTRBO CPS. If enabled, the Bluetooth item will **not** be displayed in the Menu and you will **not** be able to use any Bluetooth programmable button features.

Other Bluetooth-enabled devices can locate your radio, but the devices cannot connect to the radio. It enables dedicated devices to use your radio position in the process of Bluetooth-based location.

Notification List

Your radio has a Notification List that collects all your “unread” events on the channel, such as unread text messages, missed calls, and call alerts.

The Notification icon appears on the status bar when the Notification List has one or more events.



The list supports a maximum of forty (40) unread events. When it is full, the next event automatically replaces the oldest event.



**Note:**

After the events are read, they are removed from the Notification List.

Accessing the Notification List

- 1  to access the menu.

- 2  or  to Notification and press  to select.

- 3  or  to the required event and press  to select.

Long press  to return to the Home Screen.

Wi-Fi Operation

Wi-Fi® is a registered trademark of Wi-Fi Alliance®.

**Note:**

This feature is applicable to SL7550e/SL7590e/SL7580e only.

This feature allows you to setup and connect to a Wi-Fi® network. Wi-Fi supports updates for radio

firmware, codeplug, and resources such as language packs and voice announcement.





Turning Wi-Fi On or Off**Note:**

This feature is applicable to SL7550e/SL7590e/SL7580e only.

The programmed **Wi-Fi On or Off** button is assigned via CPS. Check with your dealer or system administrator to determine how your radio has been programmed.

You can turn on or turn off Wi-Fi® by performing one of the following actions.

- Press the programmed **Wi-Fi On or Off** button. Voice Announcement sounds Turning On Wi-Fi or Turning Off Wi-Fi.

- Access this feature via the menu.
 - a) Press  to access the menu.
 - b) Press  or  to WiFi and press  to select.

c) Press ▲ or ▼ to WiFi Status and press  to select.

Press  to turn on Wi-Fi. The display shows ✓ beside Enabled.

Press  to turn off Wi-Fi. The ✓ disappears from beside Enabled.

If Wi-Fi is enabled and a low capacity battery is used, an alert screen is displayed upon power up with the following notice.

- Low Capacity Battery!
- Tx power restricted to 2W and Wi-Fi disabled.
- Use a compatible battery to lift restriction.
- Press  to continue.

Lift the restriction to enable 3W operation and Wi-Fi by performing the following action. Power off the radio and change to a compatible battery such as Lithium-Ion 1800 mAh Battery Pack (HKNN4013_) and Lithium-Ion 2200 mAh Battery Pack (PMNN4459_) or Lithium-Ion 2300mAh Battery Pack (PMNN4468_).

If Wi-Fi is disabled and a low capacity battery is used, the transmit power is restricted to 2W.

Connecting to a Network Access Point





Note:

This feature is applicable to SL7550e/SL7590e/SL7580e only.

When you turn on Wi-Fi®, the radio scans and connects to a network access point.

You can also connect to a network access point via the menu.

- 1 Press  to access the menu.

- 2 Press ▲ or ▼ to WiFi and press  to select.

- 3 Press ▲ or ▼ to Networks and press  to select.

- 4 Press ▲ or ▼ to a network access point and press  to select.

- 5 Press ▲ or ▼ to **Connect** and press  to select.
-



- 6 Enter the password and press .
When the connection is successful, the radio displays a notice and the network access point is saved into the profile list.
-

Refreshing the Network List



Note:

This feature is applicable to SL7550e/SL7590e/SL7580e only.

- Perform the following actions to refresh the network list.
 - a) Press  to access the menu.
 - b) Press ▲ or ▼ to **WiFi** and press  to select.
 - c) Press ▲ or ▼ to **Networks** and press  to select.
When you enter the Networks menu, the radio automatically refreshes the network list.
-

- If you are already in the Networks menu, perform the following action to refresh the network list.

- a) Press ▲ or ▼ to **Refresh** and press  to select.

The radio refreshes and displays the latest network list.

Adding a Network





Note:

This feature is applicable to SL7550e/SL7590e/SL7580e only.

If a preferred network is not in the available network list, perform the following actions to add a network.

- 1 Press  to access the menu.

- 2 Press ▲ or ▼ to **WiFi** and press  to select.

- 3 Press ▲ or ▼ to **Networks** and press  to select.

4 Press ▲ or ▼ to **Add Network** and press  to select.

5 Enter the Service Set Identifier (SSID) and press .

6 Press ▲ or ▼ to **Open** and press  to select.

7 Enter the password and press .

The radio displays  to indicate that the network is successfully saved.

Viewing Details of Network Access Points





Note:

This feature is applicable to SL7550e/SL7590e/SL7580e only.

Perform the following actions to view details of network access points.

1 Press  to access the menu.

2 Press ▲ or ▼ to **WiFi** and press  to select.

3 Press ▲ or ▼ to **Networks** and press  to select.

4 Press ▲ or ▼ to a network access point and press  to select.

5 Press ▲ or ▼ to **View Details** and press  to select.

For a connected network access point, the Service Set Identifier (SSID), Security Mode, Media Access Control (MAC) address, and Internet Protocol (IP) address are displayed.

For a non-connected network access point, the Service Set Identifier (SSID) and Security Mode are displayed.

Removing Network Access Points







Note:



This feature is applicable to SL7550e/SL7590e/SL7580e only. Enterprise network



access points that are added via CPS can only be removed via CPS.



Perform the following actions to remove network access points from the profile list.



- 1 Press  to access the menu.

- 2 Press  or  to **WiFi** and press  to select.

- 3 Press  or  to **Networks** and press  to select.

- 4 Press  or  to the selected network access point and press  to select.

- 5 Press  or  to **Remove** and press  to select.

- 6 Press  or  to **Yes** and press  to select.

The radio displays  to indicate that the selected network access point is successfully removed.



Utilities



Turning the Radio Tones/Alerts On or Off



You can enable and disable all radio tones and alerts (except for the incoming Emergency alert tone) if needed.



Press the programmed **All Tones/Alerts** button to toggle all tones on or off, or follow the procedure described next to access this feature via the radio menu.



- 1  to access the menu.



- 2  or  to **Utilities** and press  to select.

- 3  or  to **Radio Settings** and press  to select.

- 4  or  to **Tones/Alerts** and press  to select.

- 5  or  to **All Tones** and press  to select.



- 6 Press  to enable/disable all tones and alerts.
The display shows  beside Enabled.
The  disappears from beside Enabled.
-



- 6 Press  to enable/disable keypad tones.
The display shows  beside Enabled.
The  disappears from beside Enabled.
-



Turning Keypad Tones On or Off



You can enable and disable keypad tones if needed.



- 1  to access the menu.

- 2  or  to Utilities and press  to select.

- 3  or  to Radio Settings and press  to select.

- 4  or  to Tones/Alerts and press  to select.



- 5  or  to Keypad Tones and press  to select.



You can also use  or  to change the selected option.



Setting the Tone Alert Volume Offset Level



You can adjust the Tone Alert Volume Offset level if needed. This feature adjusts the volume of the tones/alerts, allowing it to be higher or lower than the voice volume.

- 1  to access the menu.

 - 2  or  to Utilities and press  to select.



 - 3  or  to Radio Settings and press  to select.

 - 4  or  to Tones/Alerts and press  to select.

 - 5  or  to Vol. Offset and press  to select.
-



- 6 ▲ or ▼ to the required volume value.
The radio sounds a feedback tone with each corresponding volume value.
-

7 Do one of the following:

- Press  to keep the required displayed volume value.
 - Press  to exit without changing the current volume offset settings.
 - Repeat Step 6 to select another volume value.
-

Turning the Talk Permit Tone On or Off

You can enable and disable the Talk Permit Tone if needed.

- 1  to access the menu.
-
- 2 ▲ or ▼ to Utilities and press  to select.
-
- 3 ▲ or ▼ to Radio Settings and press  to select.
-

- 4 ▲ or ▼ to Tones/Alerts and press  to select.
-

- 5 ▲ or ▼ to Talk Permit and press  to select.

You can also use ◀ or ▶ to change the selected option.

- 6 Press  to enable/disable the Talk Permit Tone.
The display shows ✓ beside Enabled.
The ✓ disappears from beside Enabled.
-

Setting the Power Level



Note:



This feature is applicable to SL7550e/SL7590e/SL7580e only with a frequency band width of 403MHz–470MHz or 470.000005MHz–527MHz. Select the value of high transmit power in CPS. Check with your dealer or system administrator to determine how your radio has been programmed.



You can customize your radio's power setting to high or low for each Connect Plus zone.



High enables communication with tower sites in Connect Plus mode located at a considerable distance from you. **Low** enables communication with tower sites in Connect Plus mode in closer proximity.



Press the programmed **Power Level** button to toggle transmit power level between high and low. Follow the procedure described next to access this feature via the radio menu.

- 1 Press  to access the menu.

- 2 Press  or  to **Utilities** and press  to select.

- 3 Press  or  to **Radio Settings** and press  to select.

- 4 Press  or  to **Power** and press  to select.



- 5 Press  or  to the required setting and press  to select.



✓ appears beside selected setting. At any time, long press  to return to the Home screen. Screen returns to the previous menu.



Changing the Display Mode

You can change radio's display mode between Day or Night, as needed. This affects the color palette of the display.

- 1  to access the menu.



- 2  or  to **Utilities** and press  to select.

- 3  or  to **Radio Settings** and press  to select.

- 4  or  to **Display** and press  to select. The display shows **Day Mode** and **Night Mode**.



Note:

 or  to change the selected option.

- 5 ▲ or ▼ to the required setting and press  to enable. ✓ appears besides selected setting.
-





Adjusting the Display Brightness

You can adjust the display brightness of the radio as needed.



Note:

Display brightness cannot be adjusted when Auto Brightness is enabled.

- 1  to access the menu.
-
- 2 ▲ or ▼ to `Utilities` and press  to select.
-
- 3 ▲ or ▼ to `Radio Settings` and press  to select.
-
- 4 ▲ or ▼ to `Display` and press  to select.
-
- 5 ▲ or ▼ to `Brightness` and press  to select. The display shows a progress bar.
-



- 6 Decrease display brightness by pressing ◀ or increase the display brightness by pressing ▶.
- Select from setting of 1 to 8. Press  to confirm your entry.
-

Setting the Display Backlight Timer

You can set the the radio's display backlight timer as needed. The setting also affects the Menu Navigation Buttons and keypad backlighting accordingly.

Press the programmed **Backlight** button to toggle the backlight settings, or follow the procedure described next to access this feature via the radio menu.

The display backlight and keypad backlighting are automatically turned off if the LED indicator is disabled (see [Turning the LED Indicator On or Off](#) on page 154).

- 1  to access the menu.
-
- 2 ▲ or ▼ to `Utilities` and press  to select.
-

3 ▲ or ▼ to Radio Settings and press  to select.

4 ▲ or ▼ to Display and press  to select.



5 ▲ or ▼ to Backlight Timer and press  to select.





You can use ◀ or ▶ to change the selected option.

Locking and Unlocking the Keypad

You can lock your radio's keypad to avoid inadvertent key entry.

To lock/unlock your radio's keypad.

| Option | Steps |
|--------------------|--|
| Locking the Keypad | 1  to access the menu. |
| | 2 ▲ or ▼ to Utilities and press  to select. |

| Option | Steps |
|----------------------|--|
| | <p>3 ▲ or ▼ to Radio Settings and press  to select.</p> <p>4 ▲ or ▼ to Keypad Lock and press  to select.</p> <p>You can also use ◀ or ▶ to change the selected option.</p> |
| Unlocking the Keypad | Press  followed by  . |



After the keypad is locked, the display shows Keypad Locked and returns to the Home screen.



After the keypad is unlocked, the display shows Keypad Unlocked and returns to the Home screen.



Language





You can set your radio display to be in your required language.

- 1  to access the menu.

- 2  or  to Utilities and press  to select.

- 3  or  to Radio Settings and press  to select.



- 4  or  to Languages and press  to select.



- 5  or  to the required language and press  to enable.  appears beside selected language.



Turning the LED Indicator On or Off



You can enable and disable the LED Indicator if needed.



- 1  to access the menu.

- 2  or  to Utilities and press  to select.

- 3  or  to Radio Settings and press  to select.

- 4  or  to LED Indicator and press  to select.



You can also use  or  to change the selected option.



- 5 Press  to enable/disable the LED Indicator.
The display shows  beside Enabled.
The  disappears from beside Enabled.



Identifying Cable Type

You can select the type of cable your radio uses.

- 1  to access the menu.

- 2  or  to Utilities and press  to select.

- 3  or  to Radio Settings and press  to select.

- 4  or  to Cable Type and press  to select.



You can also use ◀ or ▶ to change the selected option.



-
- 5 The current cable type is indicated by a ✓.
-



Voice Announcement

This feature enables the radio to audibly indicate the current Zone or Channel the user has just assigned, or programmable button press. This audio indicator can be customized per customer requirements. This is typically useful when the user is in a difficult condition to read the content shown on the display.

- 1  to access the menu.



- 2  or  to Utilities and press  to select.

- 3  or  to Radio Settings and press  to select.

- 4  or  to Voice Announcement and press  to select.

You can also use ◀ or ▶ to change the selected option.



-
- 5 Do one of the following:



- Press  to enable Voice Announcement. The display shows ✓ beside Enabled.
 - Press  to disable Voice Announcement. The ✓ disappears from beside Enabled.
-



Wallpaper Mode

Your radio displays the Wallpaper background on home screen. The user can select from 5 default wallpapers.

- 1  to access the menu.

 - 2  or  to Utilities and press  to select.

 - 3  or  to Radio Settings and press  to select.

 - 4  or  to Display and press  to select.
-

5 ▲ or ▼ to Wallpaper and press  to select.

You can also use ◀ or ▶ to change the selected option.

Screen Saver Mode

The screen saver feature allows the radio to save radio battery time. A Screen Saver Pre Duration is used to track the radio activities before entering screen saver mode.

Radio starts Screen Saver Pre Duration upon power up. Radio enters into screen saver mode when Screen Saver Pre Duration timer expires, the radio exits screen saver mode and responds to related transaction normally upon any user input and over the air transaction.

Radio restarts Screen Saver Pre Duration upon any user input and over the air transaction. After being in Screen Saver mode for 5 seconds, radio enters keypad lock state automatically. When any audio or Bluetooth accessory is connected, battery saver mode is enabled, radio enters screen saver mode.

If there is any user input or over the air transaction, the radio exits screen saver mode and responds to user interaction. The Screen Saver Pre Duration is restarted and the radio goes back to screen saver mode when it expires.



Note:

The screen saver mode is to help improve battery life.



Audio Accessory



The audio accessory has two modes: Normal and Battery Saver mode. When audio accessory is plugged in and the setting is in Battery Saver Mode, the radio restarts the timer and goes into screen saver mode. In this scenario, when there is any user input (including user input on radio and accessory attachment/detachment) or when receiving emergency alarm/call, the radio exits screen saver mode and responds to user event as normal. The Screen Saver timer restarts and the radio goes back to screen saver mode when the time allocated expires.



Auto Keypad Lock





You can enable/disable your radio's auto keypad lock to avoid inadvertent key entry.

- 1  to access the menu.

- 2  or  to Utilities and press  to select.

- 3  or  to Radio Settings and press  to select.



- 4  or  to Auto Keypad Lock and press  to select.



- 5 Do one of the following:
 - Press  to enable Auto Keypad Lock. The display shows  beside Enabled.
 - Press  to disable Auto Keypad Lock. The  disappears from beside Enabled.



Digital Mic AGC (Mic AGC-D)



This feature controls the your radio's microphone gain automatically while transmitting on a digital system. It suppresses loud audio or boosts soft audio to a preset value in order to provide a consistent level of audio.





- 1  to access the menu.

- 2  or  to Utilities and press  to select.

- 3  or  to Radio Settings and press  to select.

You can also use  or  to change the selected option.

- 4  or  to Mic AGC-D and press  to select.

- 5 Do one of the following:
 - Press  to enable **Mic AGC-D**. The display shows  beside Enabled.
 - Press  to disable **Mic AGC-D**. The  disappears from beside Enabled.

Intelligent Audio

Your radio can automatically adjust its audio volume to overcome background noise in the environment, inclusive of all stationary and non-stationary noise

sources. This feature is a Receive-only feature and does not affect Transmit audio.



Note:

This feature is not applicable during a Bluetooth session.

- 1 to access the menu.

Radio Steps Control

Menu

- 1 to access the menu.
- 2 or to Radio Settings and press to select.
- 3 or to Radio Settings and press to select.
- 4 or to Intelligent Audio and press to select.

Radio Steps Control



Note:

You can also use or to change the selected option.



- 5 Do one of the following:
 - Press to enable Intelligent Audio. The display shows beside Enabled.
 - Press to disable Intelligent Audio. The disappears from beside Enabled.

-
- 2 or to Utilities and press to select.

-
- 3 or to Radio Settings and press to select.

-
- 4 or to Intelligent Audio and press to select.
-

5 Do one of the following:

- Press  to enable Intelligent Audio. The display shows ✓ beside Enabled.
- Press  to disable Intelligent Audio. The ✓ disappears from beside Enabled.



See [Authorized Accessories List](#) on page 281 for recommended Bluetooth-enabled audio accessories with in-built Automatic Volume Control for similar performance.



Turning the Acoustic Feedback Suppressor Feature On or Off



This feature allows you to minimize acoustic feedback in received calls.

1  to access the menu.



2  or  to Utilities and press  to select.

3  or  to Radio Settings and press  to select.

4  or  to AF Suppressor and press  to select.

You can also use  or  to change the selected option.

5 Do one of the following.

- Press  to enable Acoustic Feedback Suppressor. The display shows ✓ beside Enabled.
- Press  to disable Acoustic Feedback Suppressor. The ✓ disappears from beside Enabled.

Text Entry Configuration



You can configure the following settings for entering text on your radio:

- Word Predict
- Word Correct
- Sentence Cap
- My Words

Your radio supports the following text entry methods:

- Numbers
- Symbols
- Predictive or Multi-Tap
- Language (If programmed)



**Note:**



Press  at any time to return to the previous screen or long press  to return to the Home Screen. The radio exits the current screen once the inactivity timer expires.



Word Predict



Your radio can learn common word sequences that you often enter. It then predicts the next word you may want to use after you enter the first word of a common word sequence into the text editor.



- 1  to access the menu.





- 2  or  to Utilities and press  to select.

- 3  or  to Radio Settings and press  to select.

- 4  or  to Text Entry and press  to select.

- 5  or  to Word Predict and press  to select.



You can also use  or  to change the selected option.

- 6 Do one of the following:
 - Press  to enable Word Predict. The display shows  beside Enabled.
 - Press  to disable Word Predict. The  disappears from beside Enabled.

Word Correct

Supplies alternative word choices when the word entered into the text editor is not recognized by the built dictionary.

- 1  to access the menu.

- 2  or  to Utilities and press  to select.



3 ▲ or ▼ to Radio Settings and press  to select.

4 ▲ or ▼ to Text Entry and press  to select.

5 ▲ or ▼ to Word Correct and press  to select.

You can also use ◀ or ▶ to change the selected option.

6 Do one of the following:

- Press  to enable Word Correct. The display shows ✓ beside Enabled.
 - Press  to disable Word Correct. The ✓ disappears from beside Enabled.
-

Sentence Cap

Automatically enables capitalization for the first letter in the first word for every new sentence.

1  to access the menu.



2 ▲ or ▼ to Utilities and press  to select.

3 ▲ or ▼ to Radio Settings and press  to select.

4 ▲ or ▼ to Text Entry and press  to select.

5 ▲ or ▼ to Sentence Cap and press  to select.



6 Do one of the following:



- Press  to enable Sentence Cap. The display shows ✓ beside Enabled.
 - Press  to disable Sentence Cap. The ✓ disappears from beside Enabled.
-



Viewing Custom Words



You can add your own custom words into your radio's in-built dictionary. Your radio maintains a list to contain these words.



- 1  to access the menu.

- 2  or  to Utilities and press  to select.

- 3  or  to Radio Settings and press  to select.

- 4  or  to Text Entry and press  to select.



- 5  or  to My Words and press  to select.



- 6  or  to List of Words and press  to select.
Display shows the list of custom words.



Editing Custom Word



You can edit the custom words saved in your radio.



- 1  to access the menu.



- 2  or  to Utilities and press  to select.



- 3  or  to Radio Settings and press  to select.





- 4  or  to Text Entry and press  to select.

- 5  or  to My Words and press  to select.

- 6  or  to List of Words and press  to select.
Display shows the list of custom words.

- 7  or  to the required word and press  to select.

- 8  or  to Edit and press  to select.

- 9 Use the keypad to edit your custom word.
Press  to move one space to the left. Press  or the  key to move one space to the right.
Press the  key to delete any unwanted characters. Long press  to change text entry

method. Press  once your custom word is completed.

The display shows transitional mini notice, confirming your custom word is being saved.



If the custom word is saved, a tone sounds and the display shows positive mini notice.



If the custom word is not saved, a low tone sounds and the display shows negative mini notice.



Adding Custom Word

You can add your own custom words into your radio's in-built dictionary.



- 1  to access the menu.

- 2  or  to Utilities and press  to select.



- 3  or  to Radio Settings and press  to select.



- 4  or  to Text Entry and press  to select.

- 5  or  to My Words and press  to select.

- 6  or  to Add New Word and press  to select.
Display shows the list of custom words.

- 7 Use the keypad to edit your custom word.

Press  to move one space to the left. Press  or the  key to move one space to the right.

Press the  key to delete any unwanted characters. Long press  to change text entry method. Press  once your custom word is completed.

The display shows transitional mini notice, confirming your custom word is being saved.



If the custom word is saved, a tone sounds and the display shows positive mini notice.



If the custom word is not saved, a low tone sounds and the display shows negative mini notice.



Deleting a Custom Word



You can delete the custom words saved in your radio.



- 1  to access the menu.



- 2  or  to Utilities and press  to select.

- 3  or  to Radio Settings and press  to select.



- 4  or  to Text Entry and press  to select.

- 5  or  to My Words and press  to select.

- 6  or  to the required word and press  to select.

- 7  or  to Delete and press  to select.



- 8 Choose one of the following.
 - At Delete Entry?, press  to select Yes. The display shows Entry Deleted.



-  or  to No and press  to return to the previous screen.



Deleting All Custom Words



You can delete all custom words from your radio's built.



- 1  to access the menu.

- 2  or  to Utilities and press  to select.





- 3  or  to Radio Settings and press  to select.

- 4  or  to Text Entry and press  to select.

- 5  or  to My Words and press  to select.

- 6  or  to Delete All and press  to select.



- 7 Choose one of the following.

- At Delete Entry?, press  to select Yes. The display shows Entry Deleted.
-  or  to No and press  to return to the previous screen.

Accessing General Radio Information











Your radio contains information on the following:

- Battery
- Degree of Tilt (Accelerometer)
- Radio Model Number Index
- Option Board Over-the-Air (OTA) Codeplug CRC
- Site Number
- Site Info
- Radio Alias and ID
- Firmware and Codeplug Versions
- Open-Source Software Information

Press  at any time to return to the previous screen or long press  to return to the Home screen. The radio exits the current screen once the inactivity timer expires.

Accessing the Battery Information

Displays information on your radio battery.

- 1  to access the menu.
- 2  or  to Utilities and press  to select.
- 3  or  to Radio Info and press  to select.
- 4  or  to Battery Info and press  to select.



The display shows the battery information.



For **IMPRES** batteries **ONLY**: The display reads Recondition Battery if the battery requires reconditioning in an IMPRES charger. After the reconditioning process, the display then shows the battery information.



Checking the Radio Model Number Index

This index number identifies your radio's model-specific hardware. Your radio system administrator may ask for this number when preparing a new Option Board codeplug for your radio.

1  to access the menu.

2  or  to Utilities and press  to select.



3  or  to Radio Info and press  to select.



4  or  to Model Index and press  to select.
The display shows the Model Number Index.



Checking the CRC of the Option Board OTA Codeplug File

Follow the instructions below if your radio system administrator asks you to view the Option Board OTA Codeplug File CRC (Cyclic Redundancy Check). This menu option only appears if the Option Board received its last codeplug update OTA.

1  to access the menu.

2  or  to Utilities and press  to select.

3  or  to Radio Info and press  to select.

4  or  to OB OTA CPcrc and press  to select.
The display shows some letters and numbers. Communicate this information to your radio system administrator exactly as shown.

Displaying the Site ID (Site Number)









Note:

If you are not currently registered at a site, the display shows Not Registered.

The radio briefly shows the Site ID as it registers with a Connect Plus site. Following registration, the radio does not generally indicate the Site number. To display the registered Site number, do the following:

1  to access the menu.

2  or  to Utilities and press  to select.

3  or  to Radio Info and press  to select.

- 4 ▲ or ▼ to Site Number and press  to select.
The display shows the Network ID and the Site Number.

Checking the Site Info



Note:

If you are not currently registered at a site, the display shows Not Registered.

The Site Info feature provides information that can be useful to a service technician. It consists of the following information:

- Repeater number of current Control Channel repeater.
- RSSI: Last signal strength value measured from Control Channel repeater.
- Neighbor List sent by Control Channel repeater (five numbers separated by commas).

If you are requested to use this feature, please report the displayed information exactly as it appears on the screen.

- 1  to access the menu.

- 2 ▲ or ▼ to Utilities and press  to select.

- 3 ▲ or ▼ to Radio Info and press  to select.

- 4 ▲ or ▼ to Site Info and press  to select.
The display shows the Site Info.

Checking the Radio ID

This feature displays the ID of your radio.

Follow the procedure described next to access this feature via the radio screen.

- 1  to access the menu.

- 2 ▲ or ▼ to Utilities and press  to select.



- 3 ▲ or ▼ to Radio Info and press  to select.



- 4 ▲ or ▼ to My ID and press  to select.
The display shows the radio ID.



Checking the Firmware Version and Codeplug Version

Displays the firmware version on your radio.

- 1  to access the menu.

- 2  or  to Utilities and press  to select.

- 3  or  to Radio Info and press  to select.

- 4  or  to Versions and press  to select.
The display a list with the following information:
 - (Radio) Firmware Version
 - (Radio) Codeplug Version
 - Option Board Firmware Version
 - Option Board Frequency Version
 - Option Board Hardware Version
 - Option Board Codeplug Version

Checking for Updates

Connect Plus provides the ability to update certain files (Option Board Codeplug, Network Frequency File and Option Board Firmware File) over-the-air.



Note:

Check with the dealer or network administrator to determine whether this feature has been enabled for your radio.

Any display Connect Plus radio has the ability to show its current Option Board OTA Codeplug CRC, Frequency File version or Option Board firmware file version via a menu option. In addition, display radios that have been enabled for over-the-air file transfer can display the version of a "pending file". A "pending file" is a Frequency File or Option Board firmware file that the Connect Plus radio knows about via system messaging, but the radio has not yet collected all of the file's packets. If a display Connect Plus radio has a pending file, the menu provides options to:

- See the version number of the pending file.
- See what percentage of packets has been collected so far.
- Request the Connect Plus radio to resume collecting file packets.

If the radio is enabled for Connect Plus over-the-air file transfer, there may be times when the radio automatically joins a file transfer without first notifying the radio user. While the radio is collecting file packets, the LED rapidly blinks red and the radio

displays the High Volume Data icon on the Home Screen status bar.



Note:

The Connect Plus radio cannot collect file packets and receive calls at the same time. If you wish to cancel the file transfer, press and release the **PTT** button. This causes the radio to request a call on the selected Contact Name, and it will also cancel the file transfer for that radio until the process resumes at a later time.

There are several things that can make the file transfer process start again. The first example applies to all over-the-air file types. The other examples apply only to the Network Frequency File and Option Board Firmware File:

- The radio system administrator re-initiates the over-the-air file transfer.
- The Option Board's pre-defined timer expires, which causes the Option Board to automatically resume the process of collecting packets.
- The timer has not yet expired, but the radio user requests the file transfer to resume via the menu option.

After the Connect Plus radio finishes downloading all file packets, it must upgrade to the newly acquired file. For the Network Frequency File, this is an automatic process and does not require a radio reset. For the Option Board Codeplug File, this is an automatic process that will cause a brief interruption to service as the Option Board loads the new codeplug information and re-acquires a network site. How quickly the radio upgrades to a new Option Board firmware file depends on how the radio has been configured by the dealer or system administrator. The radio will either upgrade immediately after collecting all file packets, or it will wait until the next time that the user turns the radio on.



Note:

Check with your dealer or system administrator to determine how your radio has been programmed.

The process of upgrading to a new Option Board firmware file takes several seconds, and it requires the Connect Plus Option Board to reset the radio. Once the upgrade starts, the radio use will not be able to make or receive calls until the process is completed.

Firmware File

Firmware Up to Date



Note:

If the Option Board firmware file is not Up to Date (and if the radio has partially collected a more recent Option Board firmware file version) the radio displays a list with additional options; Version, %Received, and Download.

- 1 to access the menu.

- 2 or to Utilities and press to select.

- 3 or to Radio Info and press to select.

- 4 or to Updates and press to select.

- 5 or to Firmware and press to select.
The display shows Firmware is Up to Date.

Pending Firmware – Version

- 1 to access the menu.

- 2 or to Utilities and press to select.

- 3 or to Radio Info and press to select.

- 4 or to Updates and press to select.

- 5 or to Firmware and press to select.

- 6 or to Version and press to select.
If there is a pending Option Board firmware file, the display shows the pending firmware version number.
If there is a pending Option Board firmware file, the display shows Firmware is Up to Date.

Pending Firmware – % Received

- 1 to access the menu.

- 2 or to Utilities and press to select.

3 ▲ or ▼ to Radio Info and press  to select.

4 ▲ or ▼ to Updates and press  to select.

5 ▲ or ▼ to Firmware and press  to select.

6 ▲ or ▼ to %Received and press  to select.
The screen displays the percentage of firmware file packets collected so far.



Note:

When at 100%, the radio needs to be power cycled Off and then On to initiate the firmware upgrade.

Pending Firmware – Download

If the Connect Plus radio has previously left an OTA Option Board Firmware File Transfer with a partial file, the unit automatically rejoins the file transfer (if still ongoing) when an internal timer expires. If you want the unit to rejoin an ongoing Option Board Firmware File transfer prior to expiration of this internal timer, use the Download option as described below.

1  to access the menu.

2 ▲ or ▼ to Utilities and press  to select.

3 ▲ or ▼ to Radio Info and press  to select.



4 ▲ or ▼ to Updates and press  to select.

5 ▲ or ▼ to Firmware and press  to select.

6 ▲ or ▼ to Download and press  to select.
The display shows the following:

| | |
|-----------------------|------------------------|
| Download Available | Start Download |
| No Download Available | Download not available |

7 Do one of the following:

- Select Yes and press  to start the download.
- Select No and press  to return to the previous menu.

Frequency File



Frequency File Up to Date









Note:

If the Frequency File is not Up to Date (and if the radio has partially collected a more recent frequency file version) the radio displays a list with additional options; *Version*, *%Received*, and *Download*.

1 to access the menu.



2  or  to *Utilities* and press  to select.



3  or  to *Radio Info* and press  to select.



4  or  to *Frequency* and press  to select.
The display shows *Freq. File is Up to Date*.

Frequency File Pending – Version



1  to access the menu.

2  or  to *Utilities* and press  to select.

3  or  to *Radio Info* and press  to select.



4  or  to *Updates* and press  to select.



5  or  to *Frequency* and press  to select.



6  or  to *Version* and press  to select.
If there is a pending Frequency File, the display shows the pending Frequency File version number.

Frequency File Pending – % Received

1  to access the menu.

2  or  to *Utilities* and press  to select.

3  or  to *Radio Info* and press  to select.

4  or  to *Updates* and press  to select.



5  or  to *%Received* and press  to select.



The screen displays the percentage of frequency file packets collected so far.



Frequency File Pending – Download



If the Connect Plus radio has previously left an OTA Network Frequency File Transfer with a partial file, the unit automatically rejoins the file transfer (if still ongoing) when an internal timer expires. If you want the unit to rejoin an ongoing Network Frequency File transfer prior to expiration of this internal timer, use the Download option as described below.



- 1  to access the menu.

- 2  or  to Utilities and press  to select.

- 3  or  to Radio Info and press  to select.

- 4  or  to Updates and press  to select.

- 5  or  to Frequency and press  to select.

- 6  or  to Download and press  to select.

| | |
|--------------------------------|------------------------|
| Download Currently Unavailable | Download not available |
| Download Currently Available | Start Download |

-
- 7 Do one of the following:
- Select Yes and press to start the download.
 - Select No and press to return to the previous menu.
-



Accessories

Authorized Accessories List

Antennas

- 420 – 445 MHz Stubby Antenna (PMAE4076_)
- 438 – 470 MHz Stubby Antenna (PMAE4077_)
- 403 – 425 MHz Stubby Antenna (PMAE4078_)
- 450 – 490 MHz Stubby Antenna Kit (PMAE4091_)
- 480 – 527 MHz Stubby Antenna Kit (PMAE4092_)
- 806 – 870 MHz Stubby Antenna (PMAF4017_)
- 896 – 941 MHz Stubby Antenna (PMAF4018_)
- Antenna Mounting Kit, pack of ten screws and plugs (PMLN6040_)

Audio Accessories

- Surveillance Earpiece with in-line microphone and PTT (PMLN5957_)
- Swivel Earpiece with in-line microphone and PTT (PMLN5958_)
- Business Wireless Accessory Kit (PMLN6463_)
- Mag One Earbud with In-Line Microphone and Push-to-Talk (PMLN7156_)

- 2-Wire with Trans Tube, Black (PMLN7157_)
- Surveillance Earpiece with In-Line Microphone and Push-to-Talk (PMLN7158_)
- Adjustable D-Style with In-Line Microphone and Push-to-Talk (PMLN7159_)
- Swivel Earpiece with In-Line Microphone and Push-to-Talk (PMLN7189_)

Batteries

- Lithium-Ion 1800 mAh Battery Pack (HKNN4013_).
- Lithium-Ion 1370 mAh Battery Pack (PMNN4425_)^[7]
- Lithium-Ion 2300mAh Battery Pack (PMNN4468_)

Bluetooth

- HK200 Bluetooth Headset (US) (89409_)
- Operations Critical Wireless Earpiece with 12 inch cable (US) (NNTN8125_)
- Operations Critical Wireless Earpiece with 9.5 inch cable (US) (NNTN8126_)

⁷ Not applicable to the 800/900 band.

- Operations Critical Wireless Push-To-Talk POD (US) (NNTN8127_)

Cables

- Micro USB Programming Cable (PMKN4128_)

Carry Devices

- Carry Holder (PMLN5956_)
- Nylon Wrist Strap (PMLN6074_)
- Soft Leather Accessory Carry Case with 1.5-Inch Quick Disconnect Swivel Clip (PMLN7040_)

Chargers

- Multi-Unit Charger, US Plug (PMLN5916_)
- Micro USB Charger, US Plug (PMPN4009_)
- Micro USB Single-Unit Plug-In Charger (SPN5547_)
- SL Series Tri-Unit Charger (PMLN6358_)

Miscellaneous Accessories

- 1370 mAH Battery Cover (PMLN6000_)
- 1800 mAH Battery Cover (PMLN6001_)

Batteries and Chargers Warranty

The Workmanship Warranty

The workmanship warranty guarantees against defects in workmanship under normal use and service.

| | |
|--|-----------|
| SL Series Batteries | 12 Months |
| Chargers (Single-Unit and Multi-Unit, Non-Display) | 12 Months |

The Capacity Warranty

The capacity warranty guarantees 80% of the rated capacity for the warranty duration.

| | |
|--------------------------------|-----------|
| Lithium-Ion (Li-Ion) Batteries | 12 Months |
|--------------------------------|-----------|

Limited Warranty

MOTOROLA COMMUNICATION PRODUCTS

I. WHAT THIS WARRANTY COVERS AND FOR HOW LONG:

MOTOROLA SOLUTIONS, INC. (“MOTOROLA”) warrants the MOTOROLA manufactured Communication Products listed below (“Product”) against defects in material and workmanship under normal use and service for a period of time from the date of purchase as scheduled below:

| | |
|--|-----------|
| SL Series Digital Portable Radios | 36 Months |
| Product Accessories (Excluding Batteries and Chargers) | 12 Months |

MOTOROLA, at its option, will at no charge either repair the Product (with new or reconditioned parts), replace it (with a new or reconditioned Product), or refund the purchase price of the Product during the warranty period provided it is returned in accordance

with the terms of this warranty. Replaced parts or boards are warranted for the balance of the original applicable warranty period. All replaced parts of Product shall become the property of MOTOROLA.

This express limited warranty is extended by MOTOROLA to the original end user purchaser only and is not assignable or transferable to any other party. This is the complete warranty for the Product manufactured by MOTOROLA. MOTOROLA assumes no obligations or liability for additions or modifications to this warranty unless made in writing and signed by an officer of MOTOROLA.

Unless made in a separate agreement between MOTOROLA and the original end user purchaser, MOTOROLA does not warrant the installation, maintenance or service of the Product.

MOTOROLA cannot be responsible in any way for any ancillary equipment not furnished by MOTOROLA which is attached to or used in connection with the Product, or for operation of the Product with any ancillary equipment, and all such equipment is expressly excluded from this warranty. Because each system which may use the Product is unique, MOTOROLA disclaims liability for range, coverage, or

operation of the system as a whole under this warranty.

II. GENERAL PROVISIONS:

This warranty sets forth the full extent of MOTOROLA'S responsibilities regarding the Product. Repair, replacement or refund of the purchase price, at MOTOROLA's option, is the exclusive remedy. THIS WARRANTY IS GIVEN IN LIEU OF ALL OTHER EXPRESS WARRANTIES. IMPLIED WARRANTIES, INCLUDING WITHOUT LIMITATION, IMPLIED WARRANTIES OF MERCHANTABILITY AND FITNESS FOR A PARTICULAR PURPOSE, ARE LIMITED TO THE DURATION OF THIS LIMITED WARRANTY. IN NO EVENT SHALL MOTOROLA BE LIABLE FOR DAMAGES IN EXCESS OF THE PURCHASE PRICE OF THE PRODUCT, FOR ANY LOSS OF USE, LOSS OF TIME, INCONVENIENCE, COMMERCIAL LOSS, LOST PROFITS OR SAVINGS OR OTHER INCIDENTAL, SPECIAL OR CONSEQUENTIAL DAMAGES ARISING OUT OF THE USE OR INABILITY TO USE SUCH PRODUCT, TO THE FULL EXTENT SUCH MAY BE DISCLAIMED BY LAW.

III. STATE LAW RIGHTS:

SOME STATES DO NOT ALLOW THE EXCLUSION OR LIMITATION OF INCIDENTAL OR CONSEQUENTIAL DAMAGES OR LIMITATION ON HOW LONG AN IMPLIED WARRANTY LASTS, SO THE ABOVE LIMITATION OR EXCLUSIONS MAY NOT APPLY.

This warranty gives specific legal rights, and there may be other rights which may vary from state to state.

IV. HOW TO GET WARRANTY SERVICE:

You must provide proof of purchase (bearing the date of purchase and Product item serial number) in order to receive warranty service and, also, deliver or send the Product item, transportation and insurance prepaid, to an authorized warranty service location. Warranty service will be provided by MOTOROLA through one of its authorized warranty service locations. If you first contact the company which sold you the Product (e.g., dealer or communication service provider), it can facilitate your obtaining warranty service. You can also call MOTOROLA at 1-800-927-2744 US/Canada.

V. WHAT THIS WARRANTY DOES NOT COVER:

- 1 Defects or damage resulting from use of the Product in other than its normal and customary manner.
- 2 Defects or damage from misuse, accident, water, or neglect.
- 3 Defects or damage from improper testing, operation, maintenance, installation, alteration, modification, or adjustment.
- 4 Breakage or damage to antennas unless caused directly by defects in material workmanship.
- 5 A Product subjected to unauthorized Product modifications, disassembles or repairs (including, without limitation, the addition to the Product of non-MOTOROLA supplied equipment) which adversely affect performance of the Product or interfere with MOTOROLA's normal warranty inspection and testing of the Product to verify any warranty claim.
- 6 Product which has had the serial number removed or made illegible.
- 7 Rechargeable batteries if:

- any of the seals on the battery enclosure of cells are broken or show evidence of tampering.
 - the damage or defect is caused by charging or using the battery in equipment or service other than the Product for which it is specified.
- 8 Freight costs to the repair depot.
 - 9 A Product which, due to illegal or unauthorized alteration of the software/firmware in the Product, does not function in accordance with MOTOROLA's published specifications or the FCC certification labeling in effect for the Product at the time the Product was initially distributed from MOTOROLA.
 - 10 Scratches or other cosmetic damage to Product surfaces that does not affect the operation of the Product.
 - 11 Normal and customary wear and tear.

VI. PATENT AND SOFTWARE PROVISIONS:

MOTOROLA will defend, at its own expense, any suit brought against the end user purchaser to the extent that it is based on a claim that the Product or parts infringe a United States patent, and MOTOROLA will pay those costs and damages finally awarded against

the end user purchaser in any such suit which are attributable to any such claim, but such defense and payments are conditioned on the following:

- 1 that MOTOROLA will be notified promptly in writing by such purchaser of any notice of such claim,
- 2 that MOTOROLA will have sole control of the defense of such suit and all negotiations for its settlement or compromise, and
- 3 should the Product or parts become, or in MOTOROLA's opinion be likely to become, the subject of a claim of infringement of a United States patent, that such purchaser will permit MOTOROLA, at its option and expense, either to procure for such purchaser the right to continue using the Product or parts or to replace or modify the same so that it becomes non-infringing or to grant such purchaser a credit for the Product or parts as depreciated and accept its return. The depreciation will be an equal amount per year over the lifetime of the Product or parts as established by MOTOROLA.

MOTOROLA will have no liability with respect to any claim of patent infringement which is based upon the combination of the Product or parts furnished

hereunder with software, apparatus or devices not furnished by MOTOROLA, nor will MOTOROLA have any liability for the use of ancillary equipment or software not furnished by MOTOROLA which is attached to or used in connection with the Product. The foregoing states the entire liability of MOTOROLA with respect to infringement of patents by the Product or any parts thereof.

Laws in the United States and other countries preserve for MOTOROLA certain exclusive rights for copyrighted MOTOROLA software such as the exclusive rights to reproduce in copies and distribute copies of such MOTOROLA software. MOTOROLA software may be used in only the Product in which the software was originally embodied and such software in such Product may not be replaced, copied, distributed, modified in any way, or used to produce any derivative thereof. No other use including, without limitation, alteration, modification, reproduction, distribution, or reverse engineering of such MOTOROLA software or exercise of rights in such MOTOROLA software is permitted. No license is granted by implication, estoppel or otherwise under MOTOROLA patent rights or copyrights.

VII. GOVERNING LAW:

This Warranty is governed by the laws of the State of Illinois, U.S.A.



MOTOROLA

MOTOROLA, MOTO, MOTOROLA SOLUTIONS and the Stylized M logo are trademarks or registered trademarks of Motorola Trademark Holdings, LLC and are used under license. All other trademarks are the property of their respective owners. © 2013–2015 Motorola Solutions, Inc. All rights reserved. Wi-Fi® is a registered trademark of Wi-Fi Alliance®. November 2015

www.motorolasolutions.com/mototrbo



68009554001-LC

