



Mobile Laptop 900™

Model L3393, L3394



**Motorola, Inc.
Commercial, Government and
Industrial Solutions Sector
All rights reserved**

***Owner's Manual R02
Part No.: DDN 7415***



TRADEMARKS

All brand and product names are trademarks or registered trademarks of their respective companies.

NOTE

Information in this manual is subject to change without notice.



Regulations Information

Class B Regulations

USA

Federal Communications Commission Radio Frequency Interference Statement

NOTE:

This equipment has been tested and found to comply with the limits for a Class B digital device pursuant to Part 15 of the FCC Rules. These limits are designed to provide reasonable protection against harmful interference in a residential installation. This equipment generates, uses, and can radiate radio frequency energy and, if not installed and used in accordance with the instructions, may cause harmful interference to radio communications. However, there is no guarantee that interference will not occur in a particular installation. If this equipment does cause harmful interference to radio or television reception, which can be determined by turning the equipment off and on, the user is encouraged to try to correct the interference by one or more of the following measures:

- Reorient or relocate the receiving antenna.
- Increase the separation between the equipment and receiver.
- Connect the equipment into an outlet on a circuit different from that to which the receiver is connected.
- Consult the dealer or an experienced radio/TV technician for help.

Any changes or modifications not expressly approved by the manufacturer could void the user's authority to operate the equipment.

Please note:

The use of a non-shielded interface cable with this equipment is prohibited.

Wireless LAN Module Statement

FCC CAUTION:

This device complies with Part 15 of the FCC Rules. Operation is subject to the following two conditions: (1) this device may not cause harmful interference, and (2) this device must accept any interference received, including interference that may cause undesired operation.

FCC RF Radiation Exposure Statement

This equipment complies with FCC RF radiation exposure limits set forth for an uncontrolled environment. This equipment should be installed and operated with a minimum distance of 20 cm between the radiator and your body.

To assure continued compliance (example – use only shielded interface cables when connecting to computer or peripheral devices), any changes or modifications not expressly approved by the party responsible for compliance could void the user's authority to operate this equipment.

Canada

Canadian Department of Communications Radio Interference Regulations Class B Compliance Notice

This digital apparatus does not exceed the Class B limits for radio noise emissions from digital apparatus set out in the Radio Interference Regulations of the Canadian Department of Communications.

Le présent appareil numérique n' émet pas de bruits radioélectriques dépassant les limites applicables aux appareils numériques de la classe B prescrites dans le Règlement sur le brouillage radioélectrique édicté par le ministère des Communications du Canada.

SAFE USAGE NOTIFICATION:

For reason of personal safety and optimal radio performance, Motorola has designed the ML900 with an intended purpose and position of use either in a secured vehicle docking station or on the top of an office desk. Motorola strongly recommends using this product in a vehicle only when it is physically-secured in a lock or assured-stationary location as failure to do so may cause the product to cause harm in accidents or other conditions. Similarly, Motorola strongly recommends that the unit not be situated for a prolonged period in an a position that places the antennas directly against the human body (for example, by “tucking” an operational, radio-equipped unit under one’ s arm). NOTE: The radio modems in the ML900 may continue to transmit and receive signals even while the laptop is in a closed position. Failure to follow any part of this notification could cause degraded radio performance or harm to the user”.

About the Battery

Caution Texts Concerning Lithium Batteries

DANISH

ADVARSEL!

Lithiumbatteri – Eksplosionsfare ved fejlagtig håndtering. Udskiftning må kun ske med batteri af samme fabrikat og type. Levér det brugte batteri tilbage til leverandøren.

NORWEGIAN

ADVARSEL:

Eksplosjonsfare ved feilaktig skifte av batteri. Benytt samme batteritype eller en tilsvarende type anbefalt av apparatfabrikanten. Brukte batterier kasseres i henhold til fabrikantens instruksjoner.

SWEDISH

WARNING:

Explosionsfara vid felaktigt batteribyte. Använd samma batterityp eller en ekvivalent typ som rekommenderas av apparattillverkaren. Kassera använt batteri enligt fabrikantens instruktion.

FINNISH

VAROITUS:

Paristo voi räjähtää, jos se on virheellisesti asennettu. Vaihda paristo ainoastaan valmistajan suosittelemaan tyyppiin. Hävitä käytetty paristo valmistajan ohjeiden mukaisesti.

ENGLISH

CAUTION:

Danger of explosion if battery is incorrectly replaced. Replace only with the same or equivalent type recommended by the equipment manufacturer. Discard used batteries according to manufacturer's instructions.

DEUTSCH

VORSICHT:

Explosionsgefahr bei unsachgemäßem Austausch der Batterie. Ersatz nur durch denselben oder einen vom Hersteller empfohlenen gleich-wertigen Typ. Entsorgung gebrauchter Batterien nach Angaben des Herstellers.

FRENCH

ATTENTION:

Il y a danger d'explosion s'il y a un remplacement incorrect de la batterie. Remplacer uniquement avec une batterie du même type ou d'un type équivalent recommandé par le constructeur. Mettre au rebut les batteries usagées conformément aux instructions du fabricant.

Attention (for USA Users)

The product that you have purchased contains a rechargeable battery. The battery is recyclable. At the end of its useful life, under various state and local laws, it may be illegal to dispose of this battery into the municipal waste stream. Check with your local solid waste officials for details in your area for recycling options or proper disposal.

About the Modem

Caution

1. Never install telephone wiring during a lightning storm.
2. Never install telephone jacks in wet locations unless the jack is specifically designed for wet locations.
3. Never touch uninsulated telephone wires or terminals unless the telephone line has been disconnected at the network interface.
4. Use caution when installing or modifying telephone lines.
5. Avoid using the telephone function (other than a cordless-type) during an electrical storm. There may be a remote risk of electric shock from lightning.
6. Do not use the telephone function to report a gas leak in the vicinity of the leak.

Caution (for USA Users)

To reduce the risk of fire, use only No.26 AWG or larger telecommunication line cord.

Table of Contents

Preface	v
Chapter 1 Getting Started.....	1-1
Getting the Computer Running.....	1-2
Unpacking	1-2
Connecting to AC Power	1-3
Opening the Cover.....	1-4
Turning On and Off the Computer	1-5
Taking a Look at the Computer	1-6
Right-Side Components.....	1-6
Left-Side Components	1-7
Rear Components	1-8
Front Components.....	1-10
Bottom-Side Components.....	1-11
Top-open Components	1-13
Where to Go from Here.....	1-16
Chapter 2 Operating Your Computer.....	2-1
Starting and Stopping the Computer.....	2-2
Starting the Computer	2-2
Stopping the Computer	2-2
Using the Keyboard.....	2-4
Typewriter Keys	2-4
Cursor-Control Keys.....	2-5

Numeric Keypad	2-5
Euro Symbol.....	2-6
Windows Keys.....	2-6
Function Keys.....	2-6
Fn Key.....	2-7
Hot Keys	2-7
Using the Touchpad	2-9
Configuring the Touchpad	2-11
Using the Touchscreen (option)	2-12
Using the Hard Disk Drive.....	2-13
Using the CD/DVD/Combo Drive.....	2-14
Installing the CD/DVD/Combo Drive.....	2-15
Inserting and Removing a CD.....	2-16
Using the Video Features.....	2-17
Configuring the Display Modes.....	2-17
Using the Audio Features	2-19
Connecting Audio Devices.....	2-20
Using the Communication Features	2-21
Using the LAN	2-21
Using the Wireless LAN.....	2-22
Using the Wireless Modem.....	2-23
Using the GPS.....	2-24

Chapter 3 Managing Power 3-1

AC Adapter	3-2
Battery Pack	3-3
Charging the Battery Pack	3-3
Initializing the Battery Pack.....	3-4
Checking the Battery Level	3-4
Replacing the Battery Pack.....	3-5
Battery Low Signals and Actions.....	3-6
Power Management.....	3-7
Hibernation.....	3-8
Power-Saving Tips.....	3-9

Chapter 4 Expanding Your Computer	4-1
Connecting an External Monitor	4-2
Connecting a USB Device	4-3
Connecting a Serial Device.....	4-4
Connecting an IR Device.....	4-5
Connecting a Bluetooth-compliant Device (option)	4-7
Connecting an IEEE 1394 Device	4-9
Connecting a Video Capture Device.....	4-10
System Memory Upgrade	4-10
Chapter 5 Setup Configuration Utility (SCU).....	5-1
When and How to Use the SCU Program	5-2
When to Use	5-2
Starting SCU.....	5-2
Moving Around and Making Selections	5-4
Startup Menu	5-5
Disks Menu.....	5-8
Components Menu.....	5-9
Power Menu.....	5-13
Exit Menu.....	5-14
Chapter 6 Installing Software Drivers	6-1
How to Use the Driver CD.....	6-2
Installing Drivers for Windows 2000.....	6-3
Touchscreen Driver	6-6
Installing Drivers for Windows XP	6-7
Touchscreen Driver	6-10
Touchscreen Utility.....	6-16
Chapter 7 Caring for the Computer	7-1
Protecting the Computer.....	7-2
Using the Password.....	7-2
Using an Anti-Virus Strategy.....	7-2
Taking Care of the Computer	7-3

Location Guidelines	7-3
General Guidelines.....	7-3
Cleaning Guidelines.....	7-4
Battery Pack Guidelines	7-4
When Traveling	7-5
Chapter 8 Troubleshooting	8-1
Preliminary Checklist.....	8-2
Solving Common Problems	8-3
Battery Problems.....	8-4
CD/DVD/Combo Drive Problems	8-4
Display Problems.....	8-5
Fingerprint Recognition Problems	8-7
Hardware Device Problems.....	8-7
Hard Disk Drive Problems	8-7
Infrared Problems.....	8-8
Keyboard, Mouse, and Touchpad Problems.....	8-8
LAN Problems.....	8-9
WLAN Problems	8-9
Modem Problems.....	8-9
Power Management Problems (for Windows).....	8-11
Printer Problems.....	8-12
Software Problems	8-12
Sound Problems	8-13
Startup Problems	8-14
Other Problems.....	8-15
Resetting the Computer	8-16
Appendix A Specifications	A-1
Appendix B Fingerprint Recognition System	B-1
Finger Placement.....	B-2
Using the Fingerprint Recognition System Utility	B-3

Preface

This manual contains information that will help you operate the computer. It is divided into 8 chapters and an appendix.

- Chapter 1, **Getting Started**, takes you through the process of setting up the computer and identifying its external components.
- Chapter 2, **Operating Your Computer**, tells you how to use the computer's components and features.
- Chapter 3, **Managing Power**, provides information on power.
- Chapter 4, **Expanding Your Computer**, provides information on installing and using peripheral devices.
- Chapter 5, **SCU (Setup Configuration Utility)**, describes the SCU program that configures the computer's BIOS settings.
- Chapter 6, **Installing Software Drivers**, describes how to install the drivers and utilities supplied with the computer.
- Chapter 7, **Caring for the Computer**, gives you tips in care and maintenance.
- Chapter 8, **Troubleshooting**, gives solutions to common problems you may encounter when using the computer.
- Appendix A, **Specifications**, gives a brief specification of the computer.

- Appendix B, **Fingerprint Recognition System**, provides information on using the system's fingerprint recognition system.

Notational Conventions

Throughout this manual, the following conventions are used to distinguish elements of text.

| **NOTE:** identifies additional information that requires special attention.

| **CAUTION:** identifies important information which, if not followed, may result in loss of data or damage to the computer.

Keyboard keys are shown in a bold typeset. For example:

Press **Enter** to complete.

When keys are joined by a plus sign (+), press the first key, and, while keeping the first key down, press the remaining keys, finally release all the keys. When necessary, keys are also shown in graphics.

A title, command, setup item, or button that you can see on the screen is shown in boldface. A value or an option that you can select for a setup item is shown in italic. For example:

Select **Power Management**, set it to *Enabled*, and then click the **OK** button.

Getting Started

Congratulations on purchasing this computer.

This high performance notebook computer is especially designed for the practical applications of warehouses, automobiles, vehicles, public security, repairing, assisting the handicapped, and other demanding situations where conventional notebook computers just cannot measure up.

This chapter first tells you step by step how to get the computer up and running. You will find instructions for these procedures:

- Unpacking
- Connecting to AC power
- Opening the cover
- Turning on the computer
- Turning off the computer

Then, you will find a section briefly introducing the external components of the computer. And the last section navigates you to the information you may need after the computer is ready for use.

Getting the Computer Running

This section guides you through the procedures for getting the computer ready for operation.

Unpacking

After unpacking the shipping carton, you should find these standard items:

- Notebook computer
- Accessories:
 - AC adapter (100~240 VAC, 50/60 Hz)
 - AC power cord (US/CE/UK/SA)
 - Driver CD
 - This *Operation Manual*

Inspect all the items. If any item is damaged or missing, notify your dealer immediately.

Keep the shipping carton and packing materials in case you need to ship or store the computer in the future.

Connecting to AC Power

The computer operates either on the external AC power or internal battery power. It is suggested that you use AC power when you start up the computer for the first time.

CAUTION: Use only the AC adapter included with your computer. Using other AC adapters may damage the computer.

NOTE:

Power Supply Cord: (optional) Detachable, minimum 1.5 m long. Listed, rated minimum 125 V, 7 A, having a 2/18 AWG, type SVT flexible cord. One end terminates with a parallel blade, molded-on, attachments plug with a 7 A, 125 V (NEMA 1-15P) configuration; other end terminates with a molded-on appliance coupler.

Alternative: (optional) Detachable, maximum 4.5 m (14.76 ft) long. Listed, rated minimum 250 V, 6 A, having a 3/18 AWG, type SVT flexible cord. One end terminates with a Tandem blade, grounding, listed molded-on, attachments plug with a 6 A, 250 V (NEMA 6-15P) configuration; other end terminates with a molded-on appliance coupler.

1. Make sure the computer is turned off.
2. Plug the DC cord of the AC adapter to the power connector on the rear side of the computer (❶) .
3. Plug the female end of the AC power cord to the AC adapter and the male end to an electrical outlet (❷) .

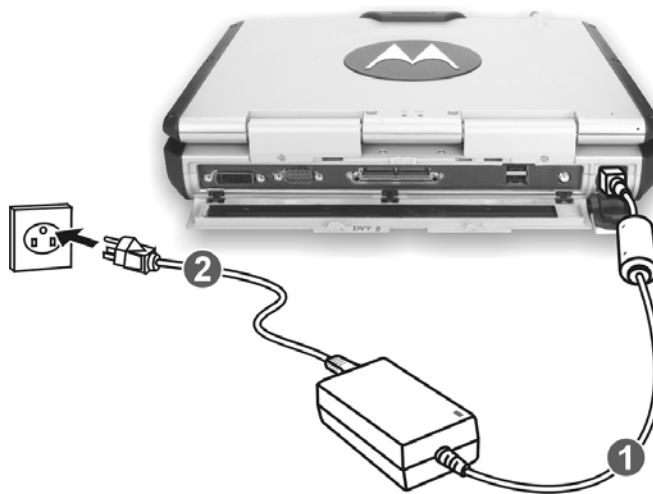

4. When the AC adapter is connected, the indicator on the AC adapter lights up, indicating that power is being supplied from the electrical outlet to the AC adapter and onto your computer. Now, you are ready to turn on the computer.

CAUTION:

- When you disconnect the AC adapter, disconnect from the electrical outlet first and then from the computer. A reverse procedure may damage the AC adapter or the computer.
- When unplugging the connector, always hold the plug head. Never pull on the cord.

NOTE: When the AC adapter is connected, it also charges the battery pack. For information on using battery power, see Chapter 3.

Opening the Cover

CAUTION: Be gentle when opening and closing the cover. Opening it vigorously or slamming it shut could damage the computer.

1. Open the top cover by pulling on the handle, inserting your index finger, and then pulling on the cover latch.



2. Lift up the cover. You can tilt the cover forward or backward for optimal viewing clarity.

Turning On and Off the Computer

Turning On

1. Make sure the computer is connected to AC power.
2. Press the power button.



3. Each time the computer is turned on, it performs a Power-On Self Test (POST), and the operating system such as Windows should start.

Turning Off

To turn off the computer power, use the “Shut Down” command of your operating system.

NOTE: There are other ways you can stop the computer so that you will be back to where you left off when you next turn on the computer. (See “Stopping the Computer” in Chapter 2 for information.)

CAUTION: If you have to turn the computer on again immediately after turning it off, wait for at least five seconds. Turning the computer off and on rapidly can damage it.

Taking a Look at the Computer

This section identifies the external components of the computer and briefly describes the function of each component.

NOTE: Depending on the model you purchased, the appearance of your computer may not exactly be the same as those shown in this manual.

Right-Side Components

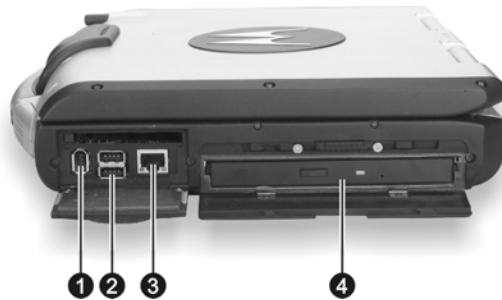

Ref	Component	Description	See Also
①	IEEE 1394 Port	Connects a 1394 device, such as a scanner, printer, digital camera, joystick, and more.	P. 4-7
②	USB Ports	Each of the two ports connects a USB device, such as a USB floppy drive, printer, digital camera, joystick, and more.	P. 4-3
③	RJ-45 Connector	Connects the LAN cable. Includes a Link Indicator and an Active Indicator.	P. 2-21
④	CD/DVD/Combo Drive	Accepts a compact disc (CD) for installing or loading software, accessing data, and playing music/video.	P. 2-14

Left-Side Components



Ref	Component	Description	See Also
①	IR Port	Connects an IrDA-compliant device for wireless data transfer.	P. 4-5
②	Bluetooth Port (option)	Connects a bluetooth-capable device for wireless data transfer.	P. 4-5
③	Microphone Connector	Connects an external microphone.	P. 2-20
④	Keyboard BIOS Reset Switch	Use this to turn off the system when resetting the system using Ctrl+Alt+Del does not work.	P. 8-17
⑤	Audio Output Connector	Connects a set of headphones, external speakers with amplifier, or an audio recording device.	P. 2-20

Rear Components

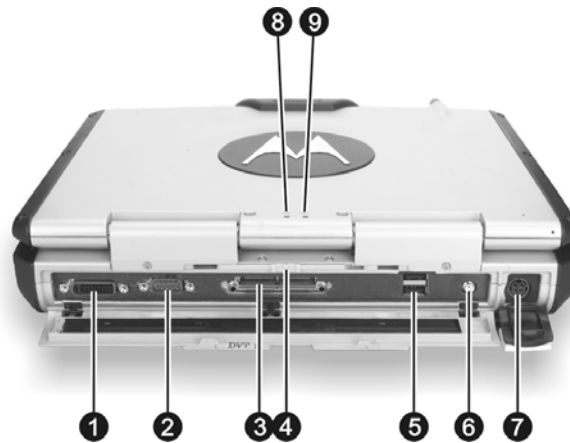

Ref	Component	Description	See Also
❶	DVI-I Port	Connects an external monitor with a DVI interface.	P. 4-2
❷	Serial Port	Connects a serial device, such as an external modem.	P. 4-4
❸	Docking Port	For connecting to a Port Replicator / car mount (both are available as an option).	
❹	Rear Cover Latch	Locks the rear cover.	
❺	USB Ports	Each of the two ports connects a USB device, such as a floppy disk drive, printer, digital camera, joystick, and more.	P. 4-3
❻	AV Input Port	Connects to a video recording device.	P. 4-8
❼	Power Connector	Connects the AC adapter.	P. 1-3
❽	AC Power Indicator 	Glows (green) when the computer, using AC power. Glows (orange) when the computer, using AC power, is in Standby mode.	P. 1-4

Ref	Component	Description	See Also
⑨	Battery Charge Indicator 	Glows green when the battery is fully charged and connected to AC power. <hr/> Glows amber (orange) when the battery is being charged.	P. 3-3

Front Components

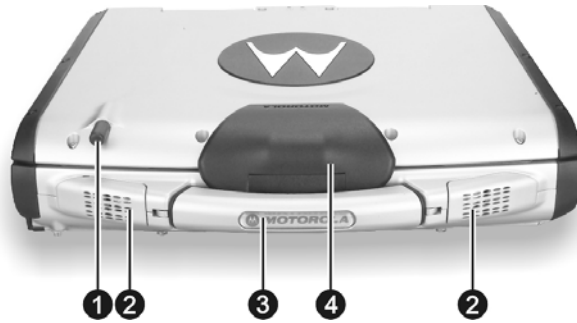

Ref	Component	Description	See Also
①	Wireless Modem Antenna	Serves as the antenna for the optional wireless modem (RDLAP, GPRS and CDMA).	P. 2-23
②	Stereo Speaker Set	Sends out sound and voice from the computer.	P. 2-20
③	Handle	Allows you to carry your computer for an easy grip.	
	Wireless LAN Antenna	Serves as the antenna for the WLAN. It is built-in the handle.	P. 2-22
④	GPS Antenna (option)	Serves as the antenna for the Global Positioning System (GPS). It is built-in the top cover latch.	P. 2-24
	Top Cover Latch	Locks the top cover.	P. 1-4

Bottom-Side Components

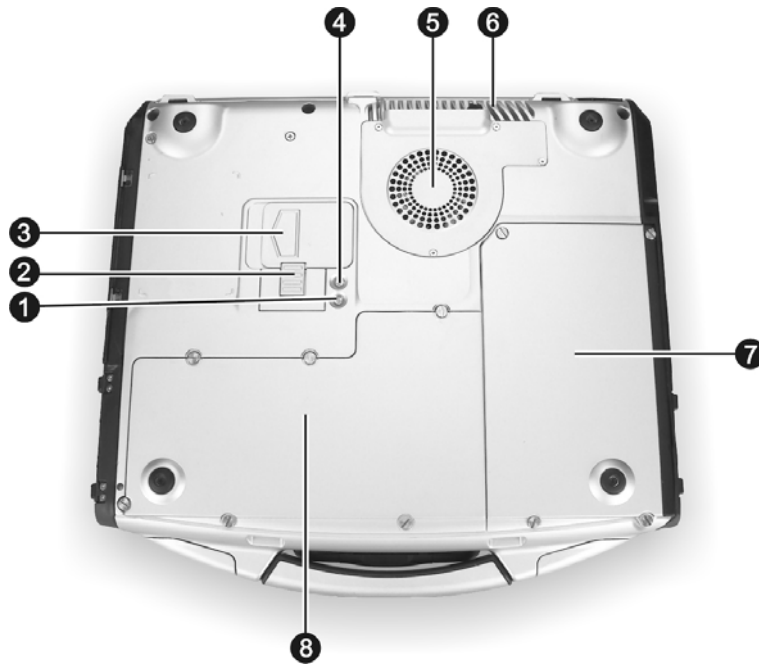









Ref	Component	Description	See Also
①	X-bay Module Antenna Connector	Serves as the interface between the system and external antenna of the optional X-bay module.	
②	CD/DVD Drive Lock/Unlock Switch	Allows you to lock the CD/DVD drive in place.	P. 2-15
③	CD/DVD Drive Eject Latch	Allows you to remove the CD/DVD drive (can also contain the Combo drive).	P. 2-15
④	GPS Antenna Connector	Serves as the interface between the system and external GPS antenna.	P. 2-24
⑤	CPU Socket and Sealed CPU Cooling Fan	Inside is the CPU of your computer and cooling fan to protect it from overheating.	

Ref	Component	Description	See Also
6	Ventilation Openings	Do not cover or block the ventilation openings for air circulation thus preventing overheating.	
7	Battery Pack	Supplies power to your computer when external power is not connected.	P. 3-3
8	X-Bay Interface (top right)	Connects additional wireless modem (GPRS/GSM).	
	Mini PCI Slot (bottom right)	Inside is the Mini PCI slot for using an optional Mini PCI card.	
	Hard Disk Drive Compartment (top left)	Contains the hard disk drive of your computer.	P. 2-13
	Memory Slot (bottom left)	Contains the memory slot for expanding the memory size of your computer.	P. 4-9

Top-open Components



Ref	Component	Description	See Also
①	Fingerprint Scanner	Contains the fingerprint sensor.	P. B-1
②	Keyboard	Serves as the data input device of the computer.	P. 2-4
③	Power Button	Turns the computer power ON and OFF.	P. 1-5

Ref	Component	Description	See Also
④	Device Indicators	Show the current status of the computer's devices.	
		 Power on / Standby mode indicator	P. 1-3
		 Hard disk drive in-use indicator	P. 2-13
		 Num Lock indicator	P. 2-6
		 Caps Lock indicator	P. 2-4
		 Scroll Lock indicator	P. 2-4
⑤	LCD Screen	Displays the output of the computer.	P. 2-17
⑥	Light Sensor	Automatic light sensor for dimming the display's backlight. Will function only if your system comes with the optional sunlight readable transfective LCD display and/or keyboard with optional backlight function.	P. 2-17
⑦	Touchpad	Serves as the pointing device of the computer.	P. 2-9
⑧	Device Indicators	Show the current status of the computer's devices.	
		 CD/DVD drive in-use indicator	P. 2-14
		 Battery Low indicator – Blinks red when the battery is almost completely discharged.	P. 3-3
		 Battery charge indicator – Glows green when the battery is fully charged and connected to AC power. Glows amber (orange) when the battery is being charged.	P. 3-3
		 Touchpad indicator – Glows red when the touchpad is disabled. Can be enabled/disabled using the hot keys Fn+F7 .	P. 2-9

Ref	Component	Description	See Also
		AC in and HDD heater on indicator – Glows green when the computer is connected to AC power. Blinks red when the hard disk heater is on.	P. 1-4 P. 2-13

Where to Go from Here

As your computer is ready for operation, you may want to do any of the following now:

For this purpose ...	Do this ...
To know more about the computer ...	Go on to the next chapter.
To install the operating system if your dealer has not already done so ...	See the operating system manual.
To know more about the operating system ...	Read the operating system manual.
To install the drivers if your dealer has not already done so ...	See Chapter 6.
To set a power-on password ...	See “Startup Menu” in Chapter 5.
To charge the battery pack for the first time ...	See “Charging the Battery Pack” in Chapter 3.

Operating Your Computer

This chapter provides information about the use of the computer.

If you are new to computers, reading this chapter will help you learn the operating basics. If you are already a computer user but are new to notebook computers, you may choose to read only the parts containing information unique to your computer.

Described in this chapter are the operating basics of these components:

- Keyboard
- Touchpad
- Touchscreen
- Floppy disk drive
- Hard disk drive
- CD/DVD drive

And these features:

- Starting and stopping the computer
- Video features
- Audio features
- Communication features

Starting and Stopping the Computer

There are a number of ways to start and stop the computer.

Starting the Computer

You always start the computer using the power button.

A computer starts up with an operating system (OS) existing on the storage device such as the hard disk; or from a floppy disk or CD if you have the respective modules installed. The computer will automatically load the OS after you turn it on. This process is called booting.

NOTE: An operating system is the platform for all your software application programs to run on. The most widely used operating system today is Microsoft Windows.

Stopping the Computer

When you finish a working session, you can stop the computer by turning off the power or leaving the computer in Standby or Hibernation mode:

To stop in this mode ...	Do this ...	To start up or resume again
Off	Follow the shutdown procedure of your operating system. This can prevent loss of unsaved data or damage to your software programs. If the system is locked up because of hardware or software problems, press the power button to turn off the computer.	Press the power button.
Standby	Depending on your settings in Windows, you can place the computer in Standby mode by: <ul style="list-style-type: none">• Closing the display cover• Pressing the power button	Press any key.

To stop in this mode ...	Do this ...	To start up or resume again
Hibernation	Depending on your settings in Windows, you can place the computer in Hibernation mode by: <ul style="list-style-type: none">• Closing the display cover.• Pressing the power button	Press the power button.

If you choose to stop in Standby or Hibernation mode, you can return to where you left off the next time you start up the computer. (See “Power Management” in Chapter 3 for more information.)

Using the Keyboard

Your keyboard has all the standard functions of a full-sized computer keyboard plus a **Fn** key added for specific functions.

The standard functions of the keyboard can be further divided into four major categories:

- Typewriter keys
- Cursor-control keys
- Numeric keys
- Function keys

Typewriter Keys

Typewriter keys are similar to the keys on a typewriter. Several keys are added such as the **Ctrl**, **Alt**, **Esc**, and lock keys for special purposes. When the lock keys (**Caps Lock**, **Num Lk**, and **Scroll Lk**) are pressed, their corresponding indicators light up.

The Control key is normally used in combination with other keys for program-specific functions. The Alternate key is normally used in combination with other keys for program-specific functions. The Escape key is usually used for stopping a process. Examples are exiting a program and canceling a command. The function depends on the program you are using.

Cursor-Control Keys

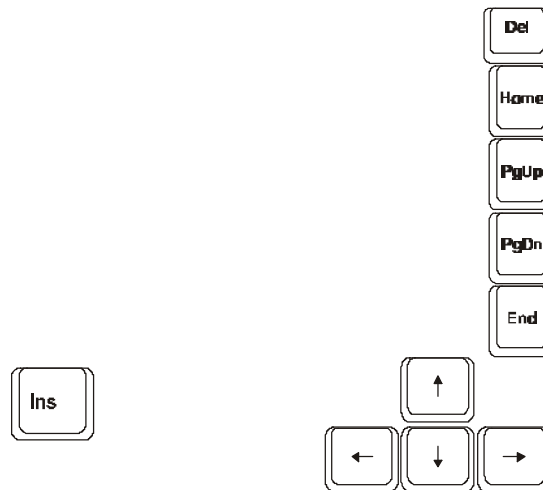

NOTE: The word “cursor” refers to the indicator on the screen that lets you know exactly where on your screen anything you type will appear. It can take the form of a vertical or horizontal line, a block, or one of many other shapes.

Numeric Keypad

A 15-key numeric keypad is embedded in the typewriter keys as shown next:

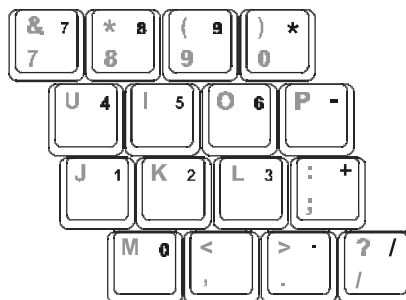

Numeric keys facilitate entering of numbers and calculations. When Num Lock is on, the numeric keys are activated; meaning you can use these keys to enter numerals.

NOTES:



- When the numeric keypad is activated and you need to type the English letter in the keypad area, you can turn Num Lock off or you can press **Fn** and then the letter without turning Num Lock off.
- Some software may not be able to use the numeric keypad on the computer. If so, use the numeric keypad on an external keyboard instead.



Euro Symbol

You can press the Euro dollar sign € on the keyboard.

- To press the Euro sign on the keyboard, hold down either of the **Alt** keys and type **0128** on the numeric keypad of your keyboard.
- To press the Euro sign on an UK keyboard, hold down the **Alt Gr** key and press **4** (which has an Euro sign on it).

Windows Keys

The keyboard has two keys that perform Windows-specific functions:  Windows Logo key and  Application key.

The  Windows Logo key opens the Start menu and performs software-specific functions when used in combination with other keys. The  Application key usually has the same effect as a right mouse click. (See your Windows manual for more information.)

Function Keys

On the top row of the keys are the function keys: **F1** to **F12**. Function keys are multi-purpose keys that perform functions defined by individual programs.















Fn Key









The **Fn** key, at the lower left corner of the keyboard, is used with another key to perform the alternative function of a key. The letter “Fn” and the alternative functions are identified by the color of blue on the keytop. To perform a desired function, first press and hold **Fn**, then press the other key.

Hot Keys

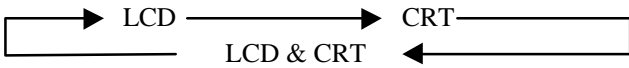
Hot keys refer to a combination of keys that can be pressed any time to activate special functions of the computer. Most hot keys operate in a cyclic way. Each time a hot key combination is pressed, it shifts the corresponding function to the other or next choice.

You can easily identify the hot keys with the icons imprinted on the keytop. The hot keys are described next.

Key	Description
 	Switches the optional keyboard backlight function on/off with 10 levels of brightness in-between.
 	Decreases the sound volume.
 	Increases the sound volume.
 	Decreases the LCD brightness.
 	Increases the LCD brightness.
 	Enabled/Disabled the Touchpad.
 	Switches LCD on and off.

Key	Description
 	<p>Switches the display output to one of the following when an external device is connected.</p> <p>Upon booting the system with CRT:</p>  <p>NOTES:</p> <ul style="list-style-type: none"> • If the display mode is set to 256 colors or lower, or in DOS mode, there will be only two modes for selecting: CRT only and LCD & CRT. • This function only applies to Plug & Play CRT monitors.
 	<p>Serves as the sleep button that you can define with Windows' Power Management. (See the "Power Management" in Chapter 3.)</p>
 	<p>Enabled/Disabled the LCD Backlight On/Off.</p>
 	<p>Switches the optional GPS function on and off.</p>

Using the Touchpad

CAUTION: Do not use a sharp object such as a pen on the touchpad. Doing so may damage the touchpad surface.

NOTES:

- By default, the touchpad is disabled. Use the **Fn+F7** hot keys to enable/disable this function. The touchpad indicator found on the keyboard panel glows red when it is disabled.
- For optimal performance of the touchpad, keep your fingers and the pads clean and dry. When tapping on the pad, tap lightly. Do not use excessive force.

The touchpad is a pointing device that allows you to communicate with the computer by controlling the location of the pointer on the screen and making selection with the buttons.



The touchpad consists of a rectangular pad and four buttons. To use the touchpad, place your forefinger or thumb on the pad. The rectangular pad acts like a miniature duplicate of your display. As you slide your fingertip across the pad, the pointer (also called cursor) on the screen moves accordingly. When your finger reaches the edge of the pad, simply relocate yourself by lifting the finger and placing it on the other side of the pad.

Here are some common terms that you should know when using the touchpad:

Term	Action
Point	Move your finger on the pad until the cursor points to the selection on the screen.
Click	Press and release the left button. –or– Tap gently anywhere on the pad.
Double-click	Press and release the left button twice in quick succession. –or– Tap twice on the pad rapidly.
Drag and drop	Press and hold the left button, then move your finger until you reach your destination (drag). Finally, release the button (drop) when you finish dragging your selection to the destination. The object will drop into the new location. –or– Gently tap twice on the pad and on the second tap, keep your finger in contact with the pad. Then, move your finger across the pad to drag the selected object to your destination. When you lift your finger from the pad, the selected object will drop into place.
Scroll	To scroll is to move up and down or left and right in the working area on the screen. The scroll button located between the two buttons under the touchpad can be used to move vertically in a convenient way. Press the upper part of the scroll button to move up and the lower part of the scroll button to move down. –or– To move vertically, place your finger on the right edge of the pad and slide your finger up and down along the edge. To move horizontally, place your finger on the bottom edge of the pad and slide your finger left and right. This function works only after you install the touchpad driver supplied with the computer and it may not work for all applications.

TABLE NOTE: If you swap the left and right buttons, “tapping” on the touchpad as an alternative method of pressing the left button will no longer be valid.

Configuring the Touchpad

You may want to configure the touchpad to suit your needs. For example, if you are a left-handed user, you can swap the two buttons so that you can use the right button as the left button and vice versa. You can also change the size of the on-screen pointer, the speed of the pointer, and so on.

To configure the touchpad, you can use the standard Microsoft or IBM PS/2 driver if you are using Windows. However, you can install the touchpad driver supplied with your computer to take advantage of more powerful features. (For information on installing the driver, see “How to Use the Driver CD” in Chapter 6.)

Using the Touchscreen (option)

CAUTION: Do not use a sharp object such as a ballpoint pen or pencil on the touchscreen. Doing so may damage the touchscreen surface.

The touchscreen is a touch-sensitive device that allows you to communicate with the computer by controlling the location of the pointer on the screen and making selection with the buttons.

The touchscreen needs a special device driver support that allows you to easily use the computer without a mouse or touchpad. (For information on installing the driver, see Chapter 6.)

Here are some common terms that you should know when using the touchscreen:

Term	Action
Click/Point	Tap gently on the touchscreen.
Double-click	Tap twice on the touchscreen rapidly.
Drag and drop	Press lightly on the touchscreen and move your finger until you reach your destination (drag). Finally, release your finger (drop) when you finish dragging your selection to the destination. The object will drop into the new location.
Scroll	<p>To scroll is to move up and down or left and right in the working area on the screen.</p> <p>To move vertically, place your finger on the right edge of the touchscreen and slide your finger up and down along the edge. To move horizontally, place your finger on the bottom edge of the touchscreen and slide your finger left and right.</p> <p>This function works only after you install the touchscreen driver supplied with the computer and it may not work for all applications.</p>

Using the Hard Disk Drive

Your computer comes with a hard disk drive as drive C. A hard disk drive is a storage device with non-removable, rotating, magnetic storage platters inside it. It is where your operating system and application software programs are stored.

Your hard disk drive is a 2.5-inch IDE (Integrated Drive Electronics) hard disk drive. This type of drive embodies the latest in fast, reliable mass storage by integrating all the control circuitry necessary for operation directly onto the drive itself. This allows the drive manufacturer to carefully optimize drive performance.



The system comes with a built-in heater that automatically turns on for low temperature operation. The AC in / HDD heater on indicator blinks red when heater is on.

CAUTION:

- Make regular backups of your data files from your hard disk drive to floppy disks or other storage media.
- Never try to remove or install the hard disk drive while the computer is powered on. Doing so can result in loss of data, and can damage the computer and the hard disk drive's sensitive circuitry.
- Never turn off or reset the computer while the hard disk drive in-use indicator is on.

Using the CD/DVD/Combo Drive

Depending on the model, your computer comes with a CD, DVD or Combo drive located on the right side of the computer. This drive is usually configured as drive D.

The drive uses removable 5.25-inch silver discs, which look like standard music CDs. It is an ideal medium to use for distributing multimedia because of the huge amount of data that a disc can store.

Depending on the model, your drive is one of the following:

- **CD drive** can read CDs, audio CDs, CD-R, and CD-RW discs.
- **DVD drive** can read DVD (Digital Versatile Disc) discs in addition to the above discs.
- **Combo drive** can work both as a DVD drive and CD-RW drive.

NOTE: If the CD/DVD/Combo drive would be operating for more than half an hour (such as showing a DVD title), use the AC power source instead of the battery. If not, the battery may run out of power before the operation is complete.

CAUTION:

1. When inserting a CD, do not use force.
2. Make sure the CD is correctly inserted into the tray, and then close the tray.
3. Do not leave the CD tray open. Also, avoid touching the lens in the tray with your hand. If the lens becomes dirty, the CD may malfunction.
4. Do not wipe the lens using materials with rough surface (such as paper towel). Instead, use a cotton swab to gently wipe the lens.

FDA regulations require the following statement for all laser-based devices:

“Caution, Use of controls or adjustments or performance of procedures other than those specified herein may result in hazardous radiation exposure.”

NOTE: The CD/DVD/Combo drive is classified as a Class 1 laser product. This label is located on the CD/DVD/Combo drive.

**CLASS 1 LASER PRODUCT
LASER KLASSE 1**

NOTE: For DVD/Combo drive only.

This product incorporates copyright protection technology that is protected by method claims of certain U.S. patents and other intellectual property rights owned by Macrovision Corporation and other rights owners. Use of this copyright protection technology must be authorized by Macrovision Corporation, and is intended for home and other limited viewing uses only unless otherwise authorized by Macrovision Corporation. Reverse engineering or disassembly is prohibited.

Installing the CD/DVD/Combo Drive

To install the CD/DVD/Combo drive:

1. Insert the CD/DVD/Combo drive into the CD drive bay located on the right side of the computer.



2. Slide the CD drive lock/unlock switch to the lock position to secure the CD/DVD/Combo drive in place.

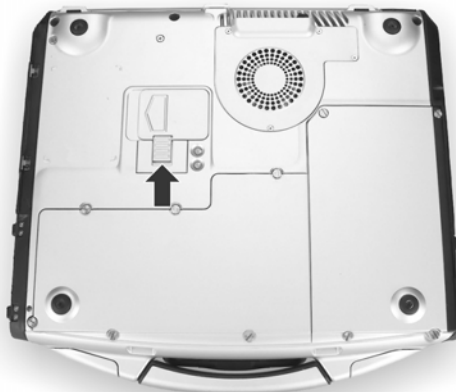

NOTE: For DVD/Combo drive only.

This product incorporates copyright protection technology that is protected by method claims of certain U.S. patents and other intellectual property rights owned by Macrovision Corporation and other rights owners. Use of this copyright protection technology must be authorized by Macrovision Corporation, and is intended for home and other limited viewing uses only unless otherwise authorized by Macrovision Corporation. Reverse engineering or disassembly is prohibited.

Installing the CD/DVD/Combo Drive

To install the CD/DVD/Combo drive:

1. Insert the CD/DVD/Combo drive into the CD drive bay located on the right side of the computer.



2. Slide the CD drive lock/unlock switch to the lock position (2) and secure the two screws (3) to fix the CD/DVD/Combo drive in place.



Removing the CD/DVD/Combo Drive

To remove the CD/DVD/Combo drive:

1. Remove the two screws (❶).
2. Slide the CD drive lock/unlock switch to the unlock position (❷) and pull the CD/DVD/Combo drive out of the CD drive bay (❸).



Inserting and Removing a CD

NOTE: The following procedure applies to inserting or removing a DVD disc as well.

Follow this procedure to insert or remove a CD.

1. Turn on the computer.
2. Press the eject button and the CD tray will slide out partially. Gently pull on it until it is fully extended.
3. To insert a CD, place down the CD in the tray with its label facing up. Slightly press the center of the CD until it clicks into place.

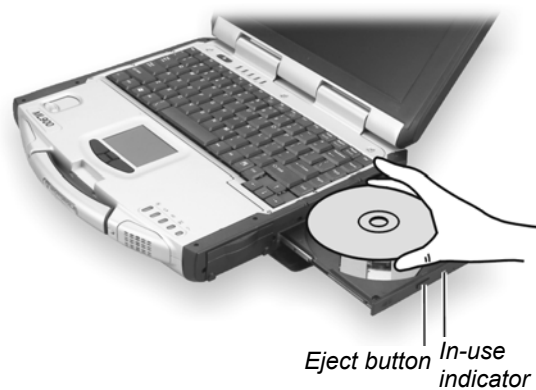

To remove a CD, hold the CD by its outer edge and lift it up from the tray.

4. Gently push the tray back into the drive.

NOTE: In the unlikely event that you are unable to release the CD tray by pressing the eject button, you can manually release the CD. (See “CD/DVD/Combo Drive Problems” in Chapter 8.)

Using the Video Features

The video subsystem of your computer features:

- 12.1/13.3-inch TFT (Thin-Film Transistor) color LCD display with 1024x768 XGA (Extended Video Graphics Array) resolution.
- 64 MB integrated video memory.
- Simultaneous display on LCD and external monitor, which is useful when you have a presentation as you can control the screen from your computer and face the audience at the same time.
- Dual view capability, which allows you to expand your desktop on the screen to another display device so that you have more desktop space to work on.
- Power Management.
- Touchscreen function (option).
- Sunlight readable transfective LCD display (option).

NOTES:

- Before using the dual view capability, the video driver supplied with your computer must be installed.
- The computer enters Standby or Hibernation mode when the LCD is closed. If you want to use the computer with the LCD closed, set *None* to the "When I close the lid of my portable computer" option in the **Power Management** Properties. Thus the computer does not enter Standby or Hibernation mode when the LCD is closed.

Configuring the Display Modes

NOTES:

- To take advantage of the enhanced video capabilities, the video driver supplied with your computer must be installed.
- When using CRT only, the resolution would depend on the supported resolution by the CRT.

Your computer has been set to a default resolution and number of colors before shipment. You can view and change display settings through your operating system. See your operating system documentation or online help for specific information.

For displaying in higher resolutions, you can connect an external CRT monitor that supports higher resolutions. (See “Connecting an External Monitor” in Chapter 4 for more information.)

The following table lists the display modes supported by your computer.

Display Mode		LCD Only	CRT Only	Simultaneous Display
Resolution	Colors			
800x600	16-bit	√	√	√
	32-bit	√	√	√
1024x768	16-bit	√	√	√
	32-bit	√	√	√

TABLE NOTES:

- 16-bit = High Color or 65,536 (64 K) colors; 32-bit = True Color 16,770,000 (16 M) colors.
- When using CRT only, the resolution would depend on the supported resolution by the CRT.

Using the Audio Features

NOTES:

- To take advantage of the enhanced audio capabilities, the audio driver supplied with your computer must be installed (see chapter 6 for details).
- If you experience interference while recording, try lowering the microphone recording volume.

The audio subsystem of your computer features:



- Digital audio and analog mixing functions required for recording and playing sound on your computer
- Microsoft Windows Sound System support
- A set of speakers (❶)
- External audio connectors (❷)



Ways of playing and recording sound vary with the operating system used. See your operating system documentation or online help for specific information.

Connecting Audio Devices

For higher audio quality, you can send or receive sound through external audio devices.

- **Microphone Connector** () can be connected to an external microphone for recording voice or sound.
- **Audio Output Connector** () can be connected to the line-in connector of powered speakers with built-in amplifiers, headphones, or earphone set. This connector is compliant with S/P-DIF (Sony/Philips-Digital InterFace). You can connect audio equipment with S/P-DIF to the computer. S/P-DIF is a new audio transfer file format that ensures a high quality digital audio output through optical fibers.

NOTE: When using external speakers/headphones or microphone, you cannot use the internal one.

Using the Communication Features

Using the LAN

NOTE for Windows 2000: To take advantage of the LAN feature, the LAN driver supplied with your computer must be installed.

The internal 100Base-T LAN (Local Area Network) module allows you to connect your computer to a network. It supports data transfer rate up to 100 Mbps.

To connect the network cable to the LAN module, connect one end of the LAN cable to the RJ-45 connector on the computer and the other end to the network hub.



- | | |
|------------------|---|
| Link Indicator | Glows green when the system has an available connection to LAN. |
| Active Indicator | Blinks green when the system is accessing the LAN. |



Using the Wireless LAN

Depending on your model, an internal Mini PCI wireless LAN (WLAN) card may have been pre-installed by your computer manufacturer at the factory. This card allows you to access corporate networks or the Internet in a wireless environment.

The WLAN features include:

- IEEE 802.11b standard compliance
- 2.4 GHz DSSS (Direct Sequence Spread Spectrum) technology
- Peer-to-Peer (Ad-Hoc) and Access Point (Infrastructure) modes support
- WEP (Wired Equivalent Privacy) 64/128-bit data encryption
- Transmission rate at 11 Mbps, 5.5 Mbps, 2 Mbps, and 1 Mbps with automatic data rating

To take advantage of the WLAN feature, make sure that the WLAN driver is installed correctly. (See Chapter 6 for more information.) If your WLAN card was provided by your dealer instead of the computer manufacturer, contact your dealer for the correct driver to use.

Configuring the WLAN

After driver installation, you can use the WLAN utility to configure and monitor your WLAN connection. If you are using Windows XP, you can also use its built-in WLAN utility. Follow this procedure to launch the WLAN utility in Windows XP:

1. Select **Control Panel** from the **Start** menu.
2. Click **Network and Internet Connections**.
3. Click **Network Connections**, then double-click the **Wireless Network Connection** icon .
4. Click **Properties** in the **Wireless Network Connection Status** dialog box.
5. You can configure your WLAN settings in the **Wireless Network Connection Properties** dialog box.

NOTE: The FAA (Federal Aviation Agency) has deemed it unsafe to operate wireless devices in aircraft as this may interfere with flight safety. Remember to select turn off wireless LAN when using your computer in the airplane.

Replacing the Wireless LAN

To replace the Wireless LAN, follow these steps:

1. Make sure the computer is not turned on or connected AC power.
2. Remove the 6 screws of the HDD cover and lift the Mini PCI Wireless module to take it off the computer.

Using the Wireless Modem

Depending on your model, your computer includes an integrated GSM (Global System for Mobile Communications) / GPRS (General Packet Radio Service) feature.

After you establish a subscription with a GSM/GPRS service provider, you can use the wireless data features of your computer. Check with your service provider for a list of available wireless data services. Your service provider may charge additional fees for use of data services.

There are two methods for wirelessly connecting to an ISP or network:

- **GSM data transmission (circuit-switched data)**
GSM data services enable you to use the GSM component of your computer as a built-in modem. You can use the service to connect to the Internet through an ISP or dial in to a corporate network to browse the Web or send and receive e-mail messages.
- **GPRS data transmission**
GPRS is a high-speed data-on service that enables you to transmit data over a mobile network. Subscribing to a GPRS service allows you to transfer files, browse the Web and receive streaming audio and video on your computer.

Connecting Using the GSM Modem

NOTE: To take advantage of the wireless modem feature, the PCI-952 driver supplied with your computer must be installed (see chapter 6).

Your computer can send and receive data via a mobile network using the GSM protocol.

To send or receive data over a GSM network, you must have an account with a service provider that supports GSM data services, and the service provider must enable the data features on your account.

Configuring a GSM Modem Connection

Before you can use the GSM modem connection, make sure that you have a subscription to the Circuit-Switched Data (CSD) network with your service provider and you have an account with your service provider or corporate network you are connecting to.

To connect to an ISP or dial in to a specific computer, you must configure a connection for that service on your computer.

Connecting Using GPRS

Your computer can receive General Packet Radio Services (GPRS), a high-speed data-only service that transmits data over a mobile telephone network. In addition, GPRS provides permanent on-line connection.

To use GPRS, you must have a subscription to the function with a service provider that supports GPRS.

Configuring a GPRS Connection

To connect to a GPRS network, you must configure a connection for that service on your computer.

Using the GPS

NOTE: To take advantage of the GPS feature, the PCI-952 driver supplied with your computer must be installed (see chapter 6).

Navigation and positioning are crucial to so many activities and yet the process has always been quite cumbersome. To try to figure out where you are and where you are going, you need GPS technology.

The Global Positioning System (GPS) is a worldwide radio-navigation system formed from a constellation of 24 satellites and their ground

stations. GPS uses these "man-made stars" as reference points to calculate positions accurate to a matter of meters. In fact, with advanced forms of GPS you can make measurements to better than a centimeter! In a sense it is like giving every square meter on the planet a unique address.

Here's how GPS works in five logical steps:

- The basis of GPS is "triangulation" from satellites.
- To "triangulate," a GPS receiver measures distance using the travel time of radio signals.
- To measure travel time, GPS needs very accurate timing that it achieves with some tricks.
- Along with distance, you need to know exactly where the satellites are in space. High orbits and careful monitoring are the secret.
- Finally you must correct for any delays the signal experiences as it travels through the atmosphere.

Five broad categories of GPS application:

- Location – determining a basic position
- Navigation – getting from one location to another
- Tracking – monitoring the movement of people and things
- Mapping – creating maps of the world
- Timing – bringing precise timing to the world



Managing Power

Your computer operates either on external AC power or internal battery power.

This chapter tells you how you can effectively manage power. To maintain optimal battery performance, it is important that you use the battery in the proper way.

The topics in this chapter include:

- What is an AC adapter
- How to charge the battery pack
- When and how to initialize the battery pack
- How to check the battery level
- How to replace the battery pack
- What happens when the battery is low and what actions to take
- What is Power Management
- How to save power

AC Adapter

CAUTION:

- The AC adapter is designed for use with your computer only. Connecting the AC adapter to another device can damage the adapter.
- The AC power cord supplied with your computer is for use in the country where you purchased your computer. If you plan to go overseas with the computer, consult your dealer for the appropriate power cord.
- When you disconnect the AC adapter, disconnect from the electrical outlet first and then from the computer. A reverse procedure may damage the AC adapter or computer.
- When unplugging the connector, always hold the plug head. Never pull on the cord.

The AC adapter serves as a converter from AC (Alternating Current) to DC (Direct Current) power because your computer runs on DC power, but an electrical outlet usually provides AC power. It also charges the battery pack when connected to AC power.

The AC adapter operates on any voltage in the range of 100 ~ 240 V AC.

Battery Pack

The battery pack is the internal power source for the computer. It is rechargeable using the AC adapter.

The operating time of a fully charged battery pack depends on how you are using the computer. When your applications often access peripherals, you will experience a shorter operating time.

NOTE: Care and maintenance information for the battery is provided in the “Battery Pack Guidelines” section in Chapter 7.

Charging the Battery Pack

NOTES:

- Charging will not start if the battery's temperature is below 0 °C (32 °F) or above 50 °C (122 °F).
- The charging process will stop and the Battery Charge Indicator flashes amber when the battery's temperature gets above 60 °C (140 °F). If this happens, the battery pack may be damaged. Please contact your dealer.
- During charging, do not disconnect the AC adapter before the battery has been fully charged; otherwise you will get a prematurely charged battery.

To charge the battery pack, connect the AC adapter to the computer and an electrical outlet. The Battery Charge Indicator () on the computer glows amber to indicate that charging is in progress. You are advised to keep the computer power off while the battery is being charged. When the battery is fully charged, the Battery Charge Indicator glows green.

It takes approximately 197 minutes to charge the battery pack to 80% capacity and four or more hours to fully charge the battery pack when the computer is off.

CAUTION: After the computer has been fully recharged, do not immediately disconnect and reconnect the AC adapter to charge it again. Doing so may damage the battery.

NOTE: The battery level may automatically lessen due to the self-discharge process (0.21% per day), even when the battery pack is fully charged (100%). This happens no matter if the battery pack is installed in the computer.

Initializing the Battery Pack



You need to initialize a new battery pack before using it for the first time or when the actual operating time of a battery pack is much less than expected.

Initializing is the process of fully charging, discharging, and then charging. It can take several hours.

1. Make sure the computer power is turned off. Connect the AC adapter to fully charge the battery pack.
2. After the battery pack is fully charged, turn on the computer.
3. Disconnect the AC adapter and leave the computer on until the battery is fully discharged. The computer will shut down automatically.
4. Connect the AC adapter to fully charge the battery pack.

Checking the Battery Level

NOTE: Any battery level indication is an estimated result. The actual operating time can be different from the estimated time, depending on how you are using the computer.

You can check the approximate battery level using the battery meter function of the operating system. To read the battery level in Windows, click the  icon on the taskbar. (Click the  icon if the computer is using AC power.)

Replacing the Battery Pack

CAUTION:

- There is danger of explosion if the battery is incorrectly replaced. Replace the battery only with the computer manufacturer's optional battery packs. Discard used batteries according to the dealer's instructions.
- Do not attempt to disassemble the battery pack.

If you often rely on battery power for a long period of time while traveling, you may consider the purchase of an additional battery pack from your dealer and keep it with you in a fully charged state as a backup.

To replace the battery pack, follow these steps:

1. Make sure the computer is not turned on or connected to AC power.
2. Remove the four screws and lift the battery pack compartment cover to take it off the computer.

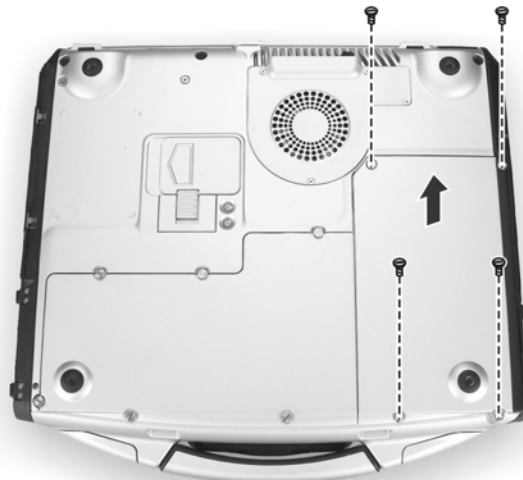

3. Pull on the ribbon and take the battery pack off the computer.
4. Insert the new battery pack into the compartment.

5. Replace the battery pack compartment cover and secure the four screws.

Battery Low Signals and Actions

Battery Low occurs when the battery has approximately 10% (Windows default setting) of its charge remaining. The computer gives warning beeps or messages and the Battery Low Indicator () blinks red to alert you to take actions.

NOTE: You can set up your threshold and signals of Battery Low under Windows.

Immediately save your data upon Battery Low. The remaining operating time depends on how you are using the computer. If you are using the audio subsystem, hard or CD/DVD drives, the battery might run out of charge very quickly.

Always respond to Battery Low by placing your computer on Standby or Hibernation mode, turning off the computer, or connecting the AC adapter.

If you do not take any action, the computer will automatically hibernate and turn off.

CAUTION: If you fail to save your data when the battery completely runs out of charge, then you lose your data.

Power Management

Your computer supports ACPI (Advanced Configuration and Power Interface) for power management. The power management feature allows you to reduce the power consumption for energy saving.

With an ACPI-compliant operating system such as Windows 2000 and Windows XP, power supply to different computer components is controlled on an as-needed basis. This allows maximum power conservation and performance at the same time.

In general, Windows' power management works in this way:

What ...	When ...
Power to the hard disk is turned off	When the hard disk has been idle for a set period.
Power to the display is turned off	When the display has been idle for a set period.
The computer enters Standby mode. The hard disk and display are turned off and the entire system consumes less power.	When the entire system has been idle for a set period.
	When you press Fn+F10 . *
	When you close the cover. *
The computer enters Hibernation mode. (See the next subsection for more information.)	When you press the power button. *
	When you press Fn+F10 . *
	When you close the cover. *

* depends on your settings in Windows.

For detailed information on power management, see Windows' Help.

Hibernation

Hibernation is a very useful feature. People frequently open many applications when they use computers. It takes some time to get all these applications open and running, and normally they all have to be closed before the system can be turned off.

When you use the hibernation feature, you do not have to close the applications. The computer stores the state of your computer to a file on the hard disk and then shut down. The next time you turn on your computer, you return to exactly where you left off.

Power-Saving Tips

In addition to your computer's automatic power management, you can do your part to maximize the battery's operating time by following these suggestions.

- Do not disable Power Management.
- Decrease the LCD brightness to the lowest comfortable level.
- Disable the parallel and serial ports if no devices are connected to these ports. (See "Components Menu" in Chapter 5.)
- If you work with an application that uses the serial port or features wireless connectivity (LAN/modem/GPS), exit the application when you finish using it.
- Turn off the computer when you are not using it.