

ASTRO® XTL™ 1500 Digital Mobile Radio with Control Head

Quick Reference Card

Product Safety and RF Exposure Compliance



Before using this product, read the operating instructions for safe usage contained in the Product Safety and RF Exposure booklet enclosed with your radio.

ATTENTION!

This radio is restricted to occupational use only to satisfy FCC RF energy exposure requirements. Before using this product, read the RF energy awareness information and operating instructions in the Product Safety and RF Exposure booklet enclosed with your radio (Motorola Publication part number 6881095C99) to ensure compliance with RF energy exposure limits.

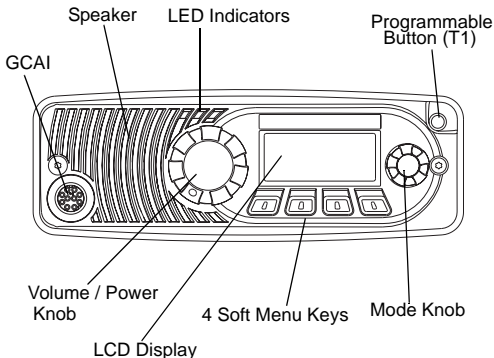

BASIC OPERATION

Turning the Radio On and Off

Rotate the **Volume** knob clockwise to turn it on. When the radio is powered on, the display shows XTL 1500. You will hear a high-pitched (good power-up) tone.

If your radio shows an error on power-up, contact your system manager for assistance.

Selecting the Zone and Mode

- 1 Press the ZHUP softkey or ZNDN softkey to scroll to the desired zone.
- 2 Press CHAN and rotate the **Mode** knob to select the mode.

Monitoring Conventional Modes

Press the preprogrammed Monitor button. The display shows MON ON.

Canceling Monitoring

Press the preprogrammed Monitor button. The display shows MON OFF.

Receiving

- 1 Select the desired zone and mode.
- 2 Turn the **Volume** knob to adjust the volume.

Transmitting (Conventional Modes)

- 1 Select the desired zone and mode.
- 2 Rotate the **Volume** knob to adjust the volume.
- 3 When a mode becomes available, press and hold the **PTT** button to transmit; release the **PTT** button to receive.

Transmitting (Trunked Systems)













- 1 Select the desired zone and mode.
- 2 Rotate the **Volume** knob to adjust the volume.
- 3 Press and hold the **PTT** button to transmit; release the **PTT** button to receive.

LED INDICATIONS

| Action | LED Condition | Meaning |
|-----------------------------------|----------------|--------------------------|
| Press the PTT button to transmit | Steady red | Normal transmission |
| | Unlit | Not transmitting |
| Release the PTT button to receive | Steady yellow | Channel activity present |
| | Blinking green | Call Receive |

STATUS ANNUNCIATORS

These are small symbols that appear on the display indicating the status of certain radio functions.

| | |
|---|---|
| Carrier Squelch () | Indicates carrier squelch is open to monitor all active conventional mode traffic. When not displayed, traffic is not open to monitoring. |
| Secure Operation () (Secure radios only) | When solid, radio is transmitting securely. When blinking, radio is receiving securely. When off, radio is operating in clear mode. |
| Call Received () | Blinks when a Private Call, page, or Phone Call is received. |
| Scan () | When displayed, indicates the radio is scanning. |
| Priority Scan () | Indicates scanning of a priority mode (blinking for Priority 1 mode; solid for Priority 2 mode). |
| RSSI () | Radio Signal Strength. |
| Programming/ View Mode () | When solid, radio is in view mode. When blinking, radio is in programming mode. |
| Direct () | When on, indicates you are talking directly to another radio (talkaround). When off, you are talking through a repeater. |
| Tx Power Level () | Transmission power of the radio is low. |
| PPP Link Establishment () | Indicates that the subscriber is ready to receive data through a data cable. |
| Packet Data activity () | Indicates the subscriber is transmitting and receiving data. |
| Packet Data IP () | Indicates the subscriber is ready to access the FNE ***. |

GENERAL FEATURES

Status (Trunking Systems Only)

- 1 Press **STS**. The display shows the last acknowledged status or first status name.
- 2 Rotate the **Mode** knob to select the desired status.
- 3 Press the **PTT** button to transmit the selected status.
- 4 Press the **EXIT** softkey to exit status and return to the home display.

Selecting Transmit Power Level

- 1 Press **(←)** below **PWR**.
The display shows **HIGH PWR** or **LOW PWR**.
- 2 If **HIGH PWR** was selected previously, pressing the softkey will display **LOW PWR** and the low power indicators are turned on.
- 3 If **LOW PWR** was selected previously, pressing the softkey will display **HIGH PWR** and the low power indicators are turned off.

Sending an Emergency Alarm

Press and hold the preprogrammed emergency button (**T1**). The red LED lights steadily. You hear an emergency tone. The display alternately shows **EMERGENCY** and the current zone and mode names. When the alarm is acknowledged by the dispatcher, you hear four beeps. The radio returns to normal operation.

Sending a Silent Emergency Alarm

Press and hold the preprogrammed emergency button (**T1**). The radio transmits the emergency without any external indication than an alarm is in progress.

Cancelling an Emergency Alarm

Press and hold the preprogrammed emergency button (**T1**) before the alarm is acknowledged. You hear an exit tone and the radio returns to normal operation. If the radio does not return to normal operation, press the **PTT** button. The radio does NOT sound an exit tone.

Sending an Emergency Call

- 1 Press and hold the preprogrammed emergency button (**T1**). The red LED lights steadily. You hear a short, medium-pitched emergency tone. The display alternately shows **EMERGENCY** and the current zone and mode names.
- 2 Press the **PTT** button and announce your emergency.
- 3 To exit emergency call mode, press the emergency button for a little over 1-1/2 seconds (or for the duration specified by your system manager). You hear a medium-pitched exit tone and the radio returns to normal operation.

Failsoft Operation (Trunked Systems Only)

During Failsoft operation, you hear a faint beeping tone every ten seconds. The radio unsquelches. The display alternately shows **FAILSOFT** and the current trunked mode name.

Scanning

Turning Scan On or Off

- 1 Press  below SCAN. Alternatively, press the preprogrammed Scan button.
 - 2 The display shows SCAN ON or SCAN OFF. Activating SCAN ON will turn on the scan indicator.
-

Deleting Nuisance Modes

- 1 When the radio is locked onto the mode you want to delete, press the NUIS softkey. Alternatively, press the preprogrammed Nuisance Delete button. The mode is deleted and you hear a valid key-press chirp.
 - 2 To resume scanning the deleted mode, turn scan off and then back on again.
-

Telephone Operation

Answering a Telephone Call

You hear a telephone-like ringing sound. The display alternately shows PHN CALL and the current mode name. The display shows a blinking .

- 1 Press the preprogrammed phone or call button

OR

press the PHON or CALL softkeys. The  annunciator disappears from the display.

- 2 Press the PTT button to talk; release it to listen.
 - 3 Press EXIT or the preprogrammed phone button to hang up. The radio returns to the home display.
-

TRUNKING FEATURES

Displaying the ID Number

- 1 Press  below CALL. The display shows the ID number (Private Conversation II).
 - 2 Press the left navigation arrow on the keypad microphone (or * if so programmed) to display MY ID: and the ID number.
 - 3 Press EXIT to return to the home display.
-

Private Conversation™ II, Enhanced Private Conversation™, and Call Alert

Calling or Paging the Last ID Number Transmitted or Received

- 1 Press the CALL (or PAGE for Call Alert) softkey.
 - 2 The display shows the last ID transmitted or received. In the case of private call, the display shows the ID number (Private Conversation II).
 - 3 Proceed to step 1 of "Send a Private Conversation Call" or "Send a Call Alert Page."
-

Directly Entering the ID Number to be Called or Paged

- 1 Press the CALL (or PAGE for Call Alert) softkey.
 - 2 The display shows the last ID transmitted or received. In the case of private call, the display shows the ID number (Private Conversation II).
 - 3 Use the numeric keypad (0 to 9 keys) to enter the new ID number.
 - 4 Proceed to step 1 of "Send a Private Conversation Call" or "Send a Call Alert Page."
-

Scrolling to an ID Number in the Call List

- 1 Press the CALL (or PAGE for Call Alert) softkey.
 - 2 The display shows the last ID transmitted or received. In the case of private call, the display shows the ID number (Private Conversation II).
 - 3 Use the navigation keys to enter the call list, or press  below LIST.
 - 4 Rotate Mode knob to scroll to the desired member of the list.
 - 5 Proceed to step 1 of "Send a Private Conversation Call" or "Send a Call Alert Page."
-

Going Directly to an ID Number in the Call List

- 1 Press the CALL (PAGE for Call Alert) softkey.
- 2 The display shows the last ID transmitted or received. In the case of private call, the display shows the ID number (Private Conversation II).
- 3 Use the navigation keys to enter the call list.

OR

Rotate Mode knob to scroll to the desired list entry

- 4 Press the 0 to 9 keys to enter the location number. The display alternately shows the name and ID number associated with the entry. If there are 10 or more list entries, the display shows LOC #X|. Use the numeric keypad again to enter the second digit of the location number.
 - 5 Proceed to step 1 of "Send a Private Conversation Call" or "Send a Call Alert Page."
-

Sending (Enhanced Private) Unit to Unit Conversation Call

- 1 Press the PTT button to transmit the displayed ID number.
If the radio you are calling is not in service, the display shows **NO ACK**. If the other party does not answer within 20 seconds, the display shows **NO ANSR**.
 - 2 Press **EXIT** to exit private call, or press the **PTT** button to speak.
 - 3 Press **EXIT** to hang up.
The radio returns to the home display.
-

Sending a Call Alert Page

- 1 Press the **PTT** button to transmit the displayed ID number.
If the radio you are paging cannot be reached, you hear only one beep.
 - 2 Press the **PTT** button to try again, or press **EXIT** to hang up.
If the radio you called has received your page, you will hear four beeps. The display shows **ACK RCVD**.
The radio returns to the home display.
-

Answering a Private (and Enhanced Private) Conversation Call

When a private call is received, the display alternately shows **CALL RCV** and the current mode name. Then the  annunciator will flash. You hear four alert tones.

- 1 Press the **CALL** softkey, or press the preprogrammed call response button.
 - 2 The display shows the last ID number transmitted or received. In the case of private call, the display shows the ID number (Private Conversation II).
 - 3 Press the **PTT** button to answer the call.
If you hear a busy tone, the system is busy.
 - 4 Press  below **RESP**, or the preprogrammed call response button to hang up.
The radio saves the caller's ID number and returns to the home display.
-

Answering a Call Alert Page

When a call alert page is received, the display alternately shows **PAGE RCV** and the current mode name. The the  annunciator blinks. You hear a four-beep tone.

- 1 Press the PTT button to answer the page.
The display shows the current mode. The alert tone, and  turn off. The ID is saved as the last ID number received.
- 2 Press the PTT button to talk, release to listen.
Everyone who belongs to the talkgroup will hear your transmission.

OR

If you want to respond to the page with a Private Call:



- a. Press  below **CALL**.
 - b. The display shows the ID of the paging radio.
- 3 Proceed to step 1 of "Send a Private Conversation Call."
-

Automatic Multiple Site Selection (AMSS)

Viewing the Current Site and Forcing a Site Change

- 1 Press the **SITE/SEARCH** button momentarily.
The display shows the number of the site if the radio is locked (or **SCANNING** if the radio is scanning).
 - 2 Press and hold down the search button while the radio scans for a new site.
The radio returns to the home display.
-

Locking and Unlocking a Site

- 1 Press **LOCK**, or press the preprogrammed lock button.
 - 2 Press  below **SITE**. The display shows the current lock state, and the **LOCK**, **UNLK** and **EXIT** softkeys.
 - 3 Press  button **LOCK** or **UNLK**. The radio saves the new setting and returns to the home display.
-

ALERT TONES

| <i>Type of Tone</i> | <i>Indication</i> | <i>Action</i> |
|------------------------------|---|--------------------------------------|
| Short, low-pitched tone | Unsuccessful power-up. Radio failed self-test. Radio not ready for use. | Contact your service representative. |
| | Invalid (bad) key press. A key press was rejected. | |
| | Time-out timer warning. Transmission time will expire in four seconds. | |
| Short, medium-pitched tone | Valid (good) key press. A key press was accepted. | |
| | Pressed emergency button to enter emergency. Emergency entered. | |
| Short, high-pitched tone | Successful power-up. Radio passed self-test. | |
| Continuous, low-pitched tone | Transmit on receive-only mode. Pressed PTT button on receive-only mode. | Release PTT button. |
| | Transmit inhibit on busy mode. Pressed PTT button while mode was busy. | |
| | Invalid mode. An invalid or unprogrammed operation. | |
| | Time-out timer timed out. Transmission was terminated. | Release PTT button. |

ALERT TONES (Continued)

| <i>Type of Tone</i> | <i>Indication</i> | <i>Action</i> |
|---|--|-------------------------------------|
| Continuous, medium-pitched tone | Emergency alarm/call exit. Exiting. | |
| Faint beeping tone every 10 seconds | Failsoft (trunked systems only). | |
| "Bah-bah-bah-bah" | Phone busy. All modes busy. Radio is in queue. | Waiting for next available line. |
| | Trunked system busy (trunked systems only). Radio is in queue. | Waiting for next available mode. |
| Single, medium-pitched tones followed by group of four medium-pitched tones | Your page has been received by the target radio. | |
| Group of two medium-pitched tones | Private Conversation call or conventional selective call received. | |
| Group of three medium-pitched (di-di-dit) tones | Call back (trunked systems only). A talkgroup is now available. | Okay to transmit in that talkgroup. |
| Group of four medium-pitched tones every five seconds | Call Alert (page) received. | |

ALERT TONES (SECURE-EQUIPPED RADIOS ONLY)

| <i>Type of Tone</i> | <i>Indication</i> | <i>Action</i> |
|--|--|--|
| One beep immediately after PTT button press | Indicates clear transmission on secure-equipped radio. | |
| Six medium-pitched tones | Keyfail. Encryption key lost or erased. | Reload key. |
| Six medium-pitched tones (continuous) | Keyfail. Radio set in secure position. PTT is being pressed. | Set radio to "clear," or select a clear mode, or reload key. |
| Six medium-pitched tones on radio power-up | Encrypted operation problem. Radio is set to either clear or secure. | Reload key. |
| Six medium-pitched tones every five to ten seconds | Encrypted operation problem. PTT button not being pressed. | Set radio to "clear," or select a clear mode, or reload key. |
| Consecutive, medium-pitched tones | Loss of encryption key during secure operation. | Reload key. |

ASTRO® XTL™ 1500
Digital Mobile Radio
with
Control Head
User's Guide

6815850H01-P

This declaration is applicable to your radio *only* if your radio is labeled with the FCC logo shown below.

DECLARATION OF CONFORMITY

Per FCC CFR 47 Part 2 Section 2.1077(a)



Responsible Party

Name: Motorola, Inc.

Address: 8000 West Sunrise Boulevard

Plantation, FL 33322 USA

Phone Number: 1-888-567-7347

Hereby declares that the product:

Model Name: **XTL 1500**

conforms to the following regulations:

FCC Part 15, subpart B, section 15.107(a), 15.107(d) and section 15.109(a)

Class B Digital Device

As a personal computer peripheral, this device complies with Part 15 of the FCC Rules. Operation is subject to the following two conditions:

1. this device may not cause harmful interference, and
2. this device must accept any interference received, including interference that may cause undesired operation.

Note: This equipment has been tested and found to comply with the limits for a Class B digital device, pursuant to part 15 of the FCC Rules. These limits are designed to provide reasonable protection against harmful interference in a residential installation. This equipment generates, uses and can radiate radio frequency energy and, if not installed and used in accordance with the instructions, may cause harmful interference to radio communications. However, there is no guarantee that interference will not occur in a particular installation.

If this equipment does cause harmful interference to radio or television reception, which can be determined by turning the equipment off and on, the user is encouraged to try to correct the interference by one or more of the following measures:

- Reorient or relocate the receiving antenna.
- Increase the separation between the equipment and receiver.
- Connect the equipment into an outlet on a circuit different from that to which the receiver is connected.
- Consult the dealer or an experienced radio/TV technician for help.

Product Safety and RF Exposure Compliance



Before using this product, read the operating instructions for safe usage contained in the Product Safety and RF Exposure booklet enclosed with your radio.

ATTENTION!

This radio is restricted to occupational use only to satisfy FCC RF energy exposure requirements. Before using this product, read the RF energy awareness information and operating instructions in the Product Safety and RF Exposure booklet enclosed with your radio (Motorola Publication part number 6881095C99) to ensure compliance with RF energy exposure limits.

Computer Software Copyrights

The Motorola products described in this manual may include copyrighted Motorola computer programs stored in semiconductor memories or other media. Laws in the United States and other countries preserve for Motorola certain exclusive rights for copyrighted computer programs, including, but not limited to, the exclusive right to copy or reproduce in any form the copyrighted computer program. Accordingly, any copyrighted Motorola computer programs contained in the Motorola products described in this manual may not be copied, reproduced, modified, reverse-engineered, or distributed in any manner without the express written permission of Motorola. Furthermore, the purchase of Motorola products shall not be deemed to grant either directly or by implication, estoppel, or otherwise, any license under the copyrights, patents or patent applications of Motorola, except for the normal non-exclusive license to use that arises by operation of law in the sale of a product.

Documentation Copyrights

No duplication or distribution of this document or any portion thereof shall take place without the express written permission of Motorola. No part of this manual may be reproduced, distributed, or transmitted in any form or by any means, electronic or mechanical, for any purpose without the express written permission of Motorola.

Disclaimer

The information in this document is carefully examined, and is believed to be entirely reliable. However, no responsibility is assumed for inaccuracies. Furthermore, Motorola reserves the right to make changes to any products herein to improve readability, function, or design. Motorola does not assume any liability arising out of the applications or use of any product or circuit described herein; nor does it cover any license under its patent rights, nor the rights of others.

Patent Disclosure

This product is covered by one or more of the following United States patents:
4,512,035 4,551,856 4,653,117 4,816,774 4,829,594 4,837,853 4,864,2524,885,550
4,914,321 4,918,403 4,959,617 4,975,650 4,994,768 5,006,7305,021,754 5,079,526

MOTOROLA, the Stylized M Logo, ASTRO, SmartZone, and FLASHport are registered in the U.S. Patent & Trademark Office. All other product or service names are the property of their respective owners. P25 radios contain technology patented by Digital Voice Systems, Inc.

© Motorola, Inc. 2007. All Rights Reserved.

Notations Used in This Manual

Throughout the text in this publication, you will notice the use of WARNINGS, CAUTIONS, and Notes. These notations are used to emphasize that safety hazards exist, and care that must be taken or observed.





WARNING: An operational procedure, practice, or other condition, which might result in injury or death if not carefully observed.



CAUTION: An operational procedure, practice, or other condition, which might result in damage to the equipment if not carefully observed.

Note: Note: An operational procedure, practice, or other condition, which is essential to emphasize.

The following special notations identify certain items:

| <i>Example</i> | <i>Description</i> |
|--|--|
| Orange button or  | Buttons and keys are shown in bold print or as a key symbol. |
|  | The special display font is used to show information in the display. |
| PHON | Menu items (softkeys) are similar to the way they appear on the radio's display. |

Contents

| | |
|--|-----------|
| Declaration of Conformity | ii |
| Computer Software Copyrights | iii |
| Documentation Copyrights | iii |
| Disclaimer | iii |
| Patent Disclosure | iii |
| Notations Used in This Manual | iv |
| Getting to Know Your Radio | 1 |
| Important Rebanding Information | 1 |
| Major Radio Components | 3 |
| The XTL 1500 Radio | 3 |
| The Control Head | 3 |
| Using Your Radio: The Basics | 5 |
| Turning Your Radio On or Off | 5 |
| Adjusting the Volume | 6 |
| Turning the Display/Keypad Light On or Off | 6 |
| Entering Menus (Softkeys) | 6 |
| Returning to the HOME Display | 7 |
| Trunked Modes or Conventional Channels | 7 |
| Field Programming | 7 |
| Interpreting Radio Status Indicators | 8 |
| Entering Characters Using the Keypad | 14 |
| Basic Radio Operation | 15 |
| Monitoring Conventional Modes | 16 |
| Selecting a Zone and Mode (Channel) | 17 |
| Receiving on a Conventional Mode | 18 |
| Adjusting the Squelch Setting | 18 |
| Receiving on Trunked Systems | 19 |
| Transmitting on Conventional Modes | 19 |
| Transmitting on Trunked Systems | 20 |
| Time-Out Timer | 21 |
| Common Radio Features | 23 |
| Sending a Status Call (Trunking Only) | 24 |
| Selecting Transmit Power Level | 26 |
| Conventional Squelch Options | 27 |
| Analog Squelch Options | 27 |
| Digital Squelch Options | 27 |
| Sending an Emergency Alarm | 28 |
| Sending an Emergency Call | 29 |

| | |
|--|-----------|
| Special Considerations for Emergencies | 30 |
| Types of Scan | 31 |
| Turning Scan On or Off | 32 |
| Deleting Nuisance Modes | 32 |
| PTT-ID (Optional) | 33 |
| Time-Out Timer | 33 |
| Telephone Operation (Conventional and Trunking) | 34 |
| Answering a Telephone Call | 34 |
| Call Alert (Conventional and Trunking) | 35 |
| Paging the Last ID Number Transmitted or Received | 35 |
| Entering Directly the ID Number to Be Paged | 35 |
| Scrolling to an ID Number in the Page List | 36 |
| Going Directly to an ID Number in the Page List | 37 |
| Sending a Call Alert Page | 38 |
| Answering a Call Alert Page | 39 |
| Optional External Alarms (Horn and/or Lights) | 41 |
| Turning External Alarm(s) On or Off | 41 |
| When a Call Is Received While Alarms Are Turned On | 42 |
| Conventional Features | 43 |
| Repeater/Direct Operation | 43 |
| Status Calls (Digital Modes Only) | 44 |
| Sending a Status Call | 44 |
| Smart PTT | 45 |
| Talkgroup Calls | 46 |
| Selecting a Talkgroup | 46 |
| Selective Calls | 47 |
| Calling the Last ID Number Transmitted or Received | 47 |
| Entering Directly the ID Number to Be Called | 48 |
| Scrolling to an ID Number in the Call List | 49 |
| Going Directly to an ID Number in the Call List | 50 |
| Starting a Selective Call | 51 |
| Trunking Features | 53 |
| Features Used on Trunking Systems | 53 |
| Viewing Your Radio's ID Number | 54 |
| Programming a Page or Call Number | 55 |
| Programming a Page or Call Name | 58 |
| Hang Up Box (HUB) | 60 |
| Enhanced Private Conversation | 60 |

| | |
|--|-----------|
| Calling the Last ID Number Transmitted or Received | 60 |
| Entering Directly the ID Number to Be Called | 61 |
| Scrolling to an ID Number in the Call List | 62 |
| Going Directly to an ID Number in the Call List | 63 |
| Sending a Private Conversation Call | 64 |
| Answering an Enhanced Private Conversation Call | 65 |
| Dynamic Regrouping | 67 |
| Electronic (Menu) Mode Selection | 67 |
| Selecting Enable and Disable | 67 |
| SmartZone Operation | 68 |
| Locking/Unlocking a Site | 68 |
| Searching for a Site | 69 |
| Site Trunking | 70 |
| Failsoft | 70 |
| Out-of-Range Indication | 71 |
| Trunked Announcement | 72 |
| Initiating an Announcement | 72 |
| Secure Features | 73 |
| Features Available on Secure XTL 1500 | 73 |
| Transmitting in Secure and Clear Modes | 74 |
| System Considerations | 75 |
| Loss Indication | 75 |
| Selecting a Key (Conventional Only) | 76 |
| Troubleshooting | 77 |
| Accessories | 79 |
| Antennas | 79 |
| Cables | 80 |
| Microphones | 80 |
| Miscellaneous | 80 |
| Speakers | 81 |
| Trunnion Kits | 81 |
| Appendix: Maritime Radio Use in the VHF Frequency Range | 83 |
| Special Channel Assignments | 83 |
| Emergency Channel | 83 |
| Non-Commercial Call Channel | 84 |
| Operating Frequency Requirements | 84 |

| | |
|--|------------|
| Glossary | 87 |
| Commercial Warranty and Service | 91 |
| Limited Warranty | 91 |
| Service | 95 |
| Index | 97 |
| Control Head Foldout Page | 103 |

Getting to Know Your Radio

Important Rebanding Information

This radio supports the new FCC 800 MHz Public Safety frequency band definition. The FCC has reorganized the 800 MHz band to reduce particular types of interference impacting public safety radio systems by moving the NPSPAC transmit frequencies from 821-824 MHz to 806-809 MHz area. This change consolidates 700 MHz and 800 MHz public safety transmit frequencies into a single contiguous block of spectrum with a greater degree of separation from cellular and Enhanced SMR frequencies. This separation should limit any harmful out-of-band emission and receiver intermodulations.

Note: In accordance with the FCC 800 MHz rebanding Report and Order (Docket 02-55), Motorola has offered rebanding replacement products to allow 800 MHz licensees to comply with the new band plan. These rebanding products are part of Motorola's current ASTRO Digital XTS and XTL product portfolio and are denoted by an RB at the end of the product title. These products offer all of the features of the current products but have the channel capacity and call list sizes equivalent to the MTS 2000 and MCS 2000 products.

Getting to Know Your Radio

Motorola XTL 1500 Digital Mobile Radios are sophisticated, state-of-the-art, communication units, pioneering the latest technology in radio electronics. Intelligent and flexible software increases the radio's capability, and permits many of the radio's features to be customized for your specific needs.

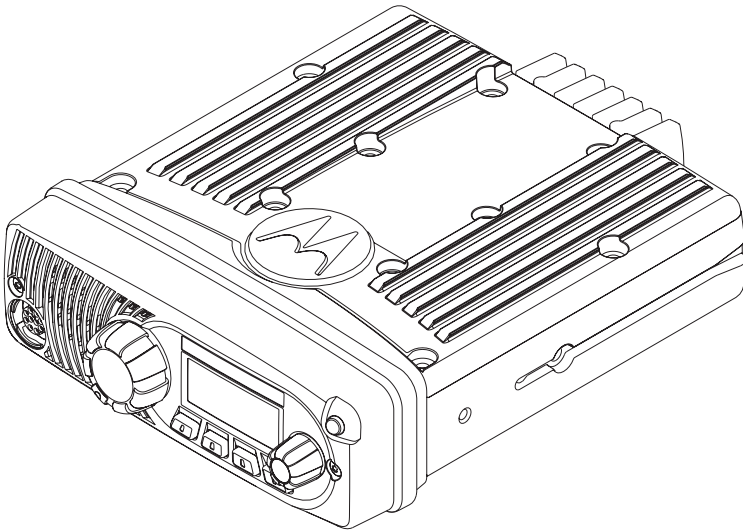

The XTL 1500 Digital Mobile Radio can operate in the following frequency ranges:

| VHF | UHF | 700/800 MHz | 900 MHz |
|-------------|-------------|--------------------|----------------|
| 136-174 MHz | 380-470 MHz | 764-776 MHz | 896-901 MHz |
| | 450-520 MHz | 794-806 MHz | 935-940 MHz |
| | | 806-825 MHz | |
| | | 851-870 MHz | |

Major Radio Components

Your radio has two major components: the radio unit installed in your vehicle and the control head that is used to activate various radio features. You may also have radio accessories installed based on the specific configuration of your radio.

This user guide describes how to use your radio and its control head. The foldout page inside the back cover of this guide contains an illustration of the control head showing all the controls and programmable buttons situated on the control head. Keep this foldout open as a reference as you review the procedures in this user guide.

The XTL 1500 Radio

The XTL 1500 radio unit contains a receiver, a transmitter, and associated internal circuitry. The radio is programmed by your system manager to meet your specific needs and/or those of your workgroup.

The Control Head

The control head that came with your XTL 1500 radio has the following features (refer to the foldout at the back of this user guide):

- **Power On/Volume Knob:** Used to turn the radio on or off and also to adjust the volume (see page 5).
- **One-line, 8-character-per-line, liquid-crystal display (LCD):** Shows alphanumeric messages or feature information as you use your radio. Also displays annunciators above the character lines, indicating the status of certain radio functions (see page 8).



- **Mode Knob:** Used to rotate through the list of available options.

- **Orange Button (T1):** Programmed as the emergency button but can be custom programmed as any other feature.
- **LED indicator:** Green/red/yellow light-emitting diode that indicates radio status as you operate various features (see page 10).
- **Four Programmable Soft Menu Keys:**
Check with your system manager for information on how these buttons have been programmed. Use the foldout at the back of this manual to record the functions that have been programmed to each button.
- **PTT button on keypad mic:** Pressed to transmit on the displayed mode and released to receive.

Using Your Radio: The Basics

This subsection gives you the basic knowledge you need in order to use your radio. The following topics are covered:

- Turning Your Radio On or Off (page 5)
- Adjusting the Volume (page 6)
- Turning the Display/keypad Light On or Off (page 6)
- Browsing Through Menu Options or Softkeys (page 6)
- Entering Softkey Menus (page 6)
- Returning to the HOME Display (page 7)
- Interpreting Radio Status Indicators (page 8)
- Entering Characters Using the Keypad (page 14)

Turning Your Radio On or Off

To turn your radio on or off:

Turn the Volume Knob clockwise.

The display shows XTL 1500. You hear a high-pitched tone indicating the radio has passed a self-check.



If the display shows ERRXX/YY (where XX/YY is an alphanumeric code) and you hear a low-pitched tone, the radio has failed the self-test.



Do the following:

- 1 Turn the Volume Knob counter clockwise to turn the radio off.
- 2 Make sure the power source is not malfunctioning.

- 3 Turn the Volume Knob clockwise to turn the radio on again. If the radio fails the self-test again, contact your system manager.

Adjusting the Volume

To adjust the volume to a comfortable level:

Turn the Volume Knob clockwise (to increase the volume) or counter clockwise (to decrease the volume).

Turning the Display/Keypad Light On or Off

The display light is useful when you need to read the information on the display and locate keys on the keypad in less than optimal lighting conditions (for example, during night time).

To toggle the display and keypad light:

Press the DIM softkey.

The Control Head ships from the factory with the backlight set to HIGH.

Entering Menus (Softkeys)

Softkeys are menu items that appear on the bottom row of the control head's display. These menu items are software-activated and enable you to access many of the radio's features without having to activate dedicated mechanical controls. Each menu item has a four-digit alpha label (for example, MUTE and VIEW).

To access a menu item:

Press the menu-select button (⊙) immediately below the softkey you wish to access.

Returning to the HOME Display

In most cases, the home display is your radio's *dispatch* state, that is, the default channel and zone that your radio operates on.

If your radio is in a feature, you can return to the home display by pressing the EXIT menu or softkey.

If your radio is not in a feature, you can return to the home display by pressing the  menu button or softkey.

You can also programme the orange button as a home button through the CPS.

Note: The default channel and zone are programmed by your system manager.

Trunked Modes or Conventional Channels

Depending on how your radio is programmed, you can select conventional channels or trunked talkgroups. Conventional channels consist of a transmit and receive frequency pair, an associated squelch code pair, and a time-out timer value. See “Conventional Features” on page 43.

Trunked modes consist of the system/announcement group/talkgroup combination and a time-out timer value. See “Trunking Features” on page 53.

Field Programming

Other radio features may be slaved to the selected mode by field programming. This *mode slaving* means that the radio is preprogrammed to automatically give you the proper operation for each mode you select.

You may use the control head to program your own mode names. The names you assign are clearly shown in the alphanumeric display. You can see all the key operating information, including the mode selected or being scanned, and the on/off status of various features. The operating conditions are shown either by the display or by visual/ audio indicators, or by both.







Interpreting Radio Status Indicators



Your radio has three types of status indicators:

- Status annunciators that appear on the display
- LED indicators
- Alert tones

Status Annunciators

These are small symbols that appear on the display above the channel name indicating status as you operate various radio features.

| <i>Annunciator</i> | <i>Indicates...</i> |
|---|--|
|  | <p>Carrier Squelch (Conventional mode only)</p> <p>All active traffic on the selected channel in being monitored during conventional operation.</p> <p>When not displayed, traffic is not open to monitoring.</p> |
|  | <p>Secure Operation only</p> <p>When lit solid, radio is transmitting in secure mode.</p> <p>When blinking, radio is receiving in secure mode.</p> <p>When off, radio is operating in clear mode.</p> |
|  | <p>Call Received</p> <p>Blinks when a Private Call, Phone Call or page is received.</p> |
|  | <p>Scan</p> <p>The radio is scanning a preprogrammed list of channels/modes for activity.</p> |
|  | <p>Priority Scan</p> <p>Indicates scanning of a priority mode (blinking for Priority 1 mode; solid for Priority 2 mode).</p> |
|  | <p>RSSI</p> <p>Radio signal strength.</p> |

| <i>Annunciator</i> | <i>Indicates...</i> |
|---|--|
| L | Tx Power Level Transmission power is low. |
|  | PPP Link Establishment Radio is ready to receive data through a data cable. |
| → | Direct/Talkaround (Conventional operation only) When on, indicates you are talking directly to another radio. When off, you are talking through a repeater. |
|  | Packet Data Activity The radio is transmitting/receiving data. |
|  | Packet Data IP The radio is ready to access the FNE ***. |

LED Indications

The LED indicator on the front of the control head indicates operational status as you use various features:

| <i>LED State</i> | <i>Indicates...</i> |
|--|------------------------------|
| Continuous red when you press PTT button to transmit | Normal transmission |
| Unlit when you press PTT button to transmit | Not transmitting |
| Steady yellow | Channel activity is present. |
| Blinking Green | Receiving a call or page. |

Alert Tones

Your radio uses alert tones to inform you of radio conditions.

| <i>Type of Tone</i> | <i>Indicates...</i> | <i>Action</i> |
|----------------------------|---|--------------------------------------|
| Short, low-pitched tone | Unsuccessful power-up. Radio failed self-test. Radio not ready for use. | Contact your service representative. |
| | Invalid (bad) key press. A key press was rejected. | |
| | Time-out timer warning. Transmission time will expire in four seconds. | |
| Short, medium-pitched tone | Valid (good) key press. A key press was accepted. | |
| | Pressed emergency button to enter emergency. Emergency entered. | |
| Short, high-pitched tone | Successful power-up. Radio passed self-test. | |

| Type of Tone | Indicates... | Action |
|---|---|-------------------------------------|
| Continuous, low-pitched tone | Transmit on receive-only mode. Pressed PTT button on receive-only mode. | Release PTT button. |
| | Transmit inhibit on busy mode. Pressed PTT button while mode is busy. | |
| | Invalid mode. An invalid or unprogrammed operation. | |
| | Time-out timer timed out. Transmission terminated. | Release PTT button. |
| Continuous, medium-pitched tone | Emergency alarm/call exit. Exiting. | |
| Faint beeping tone every ten seconds (trunked systems only) | Failsoft. | |
| “Bah-bah-bah-bah” (trunked systems only) | Trunked system busy. Radio is in queue. | Waiting for next available mode. |
| Single, medium-pitched tones followed by group of four medium-pitched tones | Your page has been received by the target radio. | |
| Group of two medium-pitched tones | Private Conversation call received. | |
| Group of three medium-pitched (di-di-dit) tones (trunked systems only) | Call back. A talkgroup is now available. | Okay to transmit in that talkgroup. |

Getting to Know Your Radio

| Type of Tone | Indicates... | Action |
|---|---|---------------|
| Group of four medium-pitched tones every five seconds | Call Alert (page) received by your radio. | |
| Short, medium-pitched tone (trunking only) | Echo received in response to emergency alarms. | |
| Four short, medium-pitched tones | Emergency alarm acknowledged. | |
| Continuous, low-pitched tone | No Emergency. Current trunking personality or conventional system does not have emergency enabled. No emergency tone. | |
| Group of two high-pitched tones | Fast ring in Private call. System is searching for target radio. | |

Alert Tones (Secure-Equipped Radios Only)

Your secure-equipped radio uses alert tones to let you know the condition of security features.

| <i>Type of Tone</i> | <i>Indication</i> | <i>Action</i> |
|--|--|--|
| One beep immediately after PTT button press | Indicates clear transmission on secure-equipped radio. | |
| Six medium-pitched tones | Keyfail. Encryption key lost or erased. | Reload key. |
| Six medium-pitched tones (continuous) | Keyfail. Radio set in secure position. PTT is being pressed. | Set radio to clear, or select a clear mode, or reload key. |
| Six medium-pitched tones on radio power-up | Encrypted operation problem. Radio is set to either clear or secure. | Reload key. |
| Six medium-pitched tones every five to ten seconds | Encrypted operation problem. PTT button not being pressed. | Set radio to clear, or select a clear mode, or reload key. |
| Consecutive, medium-pitched tones | Loss of encryption key during secure operation. | Reload key. |

Entering Characters Using the Keypad

Your XTL 1500 radio accepts input through the keypad in the form of numeric or alphanumeric strings. You may use manual keypad entry to select a status or a mode, to program a list, or to call a radio ID.

For instance, when you access the Status function using the **STS** softkey, the display shows the last successfully acknowledged status first. If you would like to send a different status message, you can scroll to the entry or, in the case of long lists, use the keypad to enter a number corresponding to its numeric location in the list. If you wish to access the twelfth status entry in the list, for example, you can press **1** and then **2**, and press the PTT button to transmit that status.

This concludes an introduction on operating your XTL 1500 radio. You can now begin familiarizing yourself with using your radio to perform basic procedures such as transmitting and receiving. These are covered in the following chapter.

Basic Radio Operation

This section describes how to perform the following basic radio procedures:

- Monitoring Conventional Modes (page 16)
- Selecting a Zone and Mode (page 17)
- Receiving on Conventional Modes (page 18)
- Adjusting the Squelch Setting (page 18)
- Receiving on Trunked Systems (page 19)
- Transmitting on Conventional Modes (page 19)
- Transmitting on Trunked Systems (page 20)

Use the foldout at the back of this user guide as a reference when you review these procedures.

This section also has information on the following feature:

- Time-Out Timer or TOT (page 21)

Monitoring Conventional Modes

To monitor conventional modes, do the following:

- 1 Press the preprogrammed Monitor button.
- 2 The display shows **MON ON** and the carrier squelch annunciator is turned on indicating that the squelch circuit has been opened, allowing you to monitor all of the traffic on the channel.



To cancel monitoring:

- 1 Press the preprogrammed Monitor button
- 2 The display shows **MON OFF** and the carrier squelch annunciator is turned off.



Note: If radio is in conventional mode, with Carrier Squelch selected, the carrier squelch annunciator will remain on the display.

Selecting a Zone and Mode (Channel)

A *channel* is a group of radio characteristics such as transmit/receive frequency pairs stored in your radio. A *zone* is a grouping of channels. A *mode* is a combination of zones and channels. Your radio is programmed by your system manager to have channels and zones that you need in order to perform your day-to-day operations.

When your radio powers up, it defaults to the last selected zone and channel before it was powered off previously. At times, you may need to select a different zone or channel to transmit or receive on, as follows:

- 1 Press the  button below ZONE.



- 2 The display shows the current zone and mode.



- 3 Rotate the Mode Knob until the desired zone is displayed.



OR

- 4 Press ZNUP or ZNDN preprogrammed buttons or softkeys to scroll through the zones.

OR

- 5 If you know the zone number, enter it using the keypad on the keypad microphone.

- 6 Press the **PTT** button to begin transmitting on the displayed zone.

- 7 To select a particular mode within a zone, rotate the **Mode Knob** until the desired mode is displayed.

Note: After the selection timer expires, the radio will automatically select the zone and mode.

Receiving on a Conventional Mode

Follow these steps to receive on a conventional mode:

- 1 Select a desired zone and mode (see page 17).
- 2 When you hear a transmission, use the **Volume Knob** to adjust the volume to a comfortable listening level if necessary.

Your radio is now set to receive on the selected mode.

Note: If the mode is busy when your radio is receiving a clear signal, the yellow LED blinks continuously until the mode is not in use.

Adjusting the Squelch Setting

Your radio's ability to transmit and receive signals varies as you move away from or close to your base station. You can adjust your radio's squelch to improve its ability to receive transmissions.

Follow these steps to change the squelch setting:

- 1 Press **SQL**.
The display shows **SQL XX**, where **XX** is a squelch level setting of 0 to 15.

- 2 To scroll to the desired squelch setting, choose one of the following:

Rotate the **Mode Knob**

OR

Press the + or - softkeys

OR

Use the navigation keys on the keypad mic.

- 3 Press the **EXIT** softkey to return to the selected channel.
-

Receiving on Trunked Systems

Follow these steps to receive while operating on a trunked system:

- 1 Select a desired zone and mode (see page 17).
- 2 When you hear a transmission, use the **Volume Knob** to adjust the volume to a comfortable listening level if necessary.

Your radio is now set to receive on the selected mode.

Transmitting on Conventional Modes

Follow these steps to transmit on a conventional mode:

- 1 Select a desired zone and mode (see page 17).

When you hear a transmission, use the **Volume Knob** to adjust the volume to a comfortable listening level if necessary.

- 2 When a mode becomes available, press and hold the **PTT** button to transmit. Speak clearly into the microphone.

The red LED lights continuously when the radio is transmitting.

- 3 Release the **PTT** button to receive.

Note: If you try to transmit on a receive-only mode, you will hear a continuous low-pitched (“invalid mode”) tone.

Transmitting on Trunked Systems

Follow these steps to transmit on a trunked system:

- 1 Select a desired zone and mode (see page 17).



Note: If no secure voice modes are available for a transmission, the display shows **NO SEC**.

You must switch to a clear mode or wait until a secure voice channel is available before you can transmit.

When you hear a transmission, use the **Volume Knob** to adjust the volume to a comfortable listening level if necessary.

- 2 Press and hold the **PTT** button to transmit.
Speak clearly into the microphone.
The red LED lights steadily when the radio is transmitting.
- 3 Release the **PTT** button to receive.

Notes: If you hear a busy (“bah-bah-bah-bah”) signal, release the **PTT** button. You hear a “di-di-dit” (“call-back”) tone. You have three seconds to transmit before you hear another busy signal.

If transmission is not possible for some reason, you hear a continuous, low-pitched (“talk prohibit”) tone. Your radio may be out of range.

Time-Out Timer

This feature limits the amount of time you can continuously transmit. Your system manager can program the timer for up to 465 seconds at 15-second intervals. XTL 1500 radios are programmed at the factory to time-out after 60 seconds.

Notes: You hear a low-pitched alert tone four seconds before your transmission is about to expire.

If you hold down the **PTT** button longer than the programmed time, you hear a continuous, low-pitched tone. This tone ceases to sound when you release the **PTT** button.

Notes

Common Radio Features

This section contains information and procedures associated with various features that may have been enabled in your radio by your system manager.

The following information is covered in this section:

- Conventional Squelch Options (page 27)
- Types of Scan (page 31)
- PTT-ID (page 33)
- Time-Out Timer (page 33)

The following procedures are covered in this section:

- Sending a status call (trunking systems only) (page 24)
- Selecting the transmit power level (page 26)
- Sending an emergency alarm (page 28)
- Sending a silent emergency alarm (page 29)
- Sending an emergency call (page 29)
- Muting and unmuting keypad tones (page 30)
- Turning scanning on or off (page 32)
- Deleting nuisance modes from the scan list (page 32)
- Telephone operation (page 34)
- Call Alert (page 35)
- Optional external alarms (horn and/or lights) (page 41)

Sending a Status Call (Trunking Only)

A Status Call is a text message sent to the dispatcher informing him or her of your situation. It does not involve a voice transmission. The status call feature is available on both conventional and trunked systems. For example, a status call might indicate to the dispatcher that you are ENROUTE or AT SITE.

Status names are field-programmable. In trunking modes, each radio can have up to eight separate statuses.

Follow these steps to send a status call to your dispatcher:

- 1 Press the  button below STS

OR

Press the preprogrammed Status button and proceed to step 3.



- 2 The display shows the last acknowledged status entry or the first status entry in the list.

- 3 Rotate the **Mode Knob** button to scroll through the available status choices

OR

Use the navigation keys on the keypad mic.

Stop scrolling when you reach the desired status (for example, STS 3).



- 4 Press the **PTT** button to transmit the selected status. The display shows PLS WAIT.



The dispatcher transmits an acknowledgment upon receipt of the status. Four tones sound and **ACK RCVD** is displayed by your radio upon receipt. The radio then returns to normal dispatch operation.

• 4 tones



In a trunking system, if the status is not acknowledged after approximately six seconds, the display alternately shows **NO ACK** and the associated status name. You also hear a continuous low-pitched (“talk prohibit”) tone until you press the **PTT** button.



• Talk-prohibit tone

5 If you do not receive an acknowledgment:

Press the **EXIT** softkey to exit status and return to normal dispatch operation.

OR

Press the **PTT** button to transmit the status again.

Note: If you enter the status menu without taking any action for six seconds, you will hear an alert tone warning you that status menus are active. You can still receive voice transmissions during this time. Press the **PTT** button to transmit the status, or press the **EXIT** softkey to exit the status menu.

Selecting Transmit Power Level

You may need to change the transmit power level on your XTL 5000 radio based on operating conditions.

- 1 Press the  button below PWR.

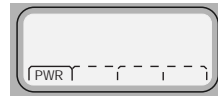

- 2 The display shows HIGH PWR or LOW PWR depending on what was selected previously.
- 3 Press the softkey to switch from HIGH PWR to LOW PWR.

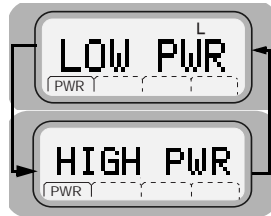

Note: When you power on your radio, it automatically defaults to a HIGH PWR transmit state even if you had selected LOW PWR before you turned the radio off.

Conventional Squelch Options

The term “squelch” is used to describe the muting of audio circuits when signal levels received by a radio fall below a pre-determined threshold. With carrier squelch, you hear all channel activity that exceeds the radio’s preset squelch level. This squelch level is programmed by your system manager.

Analog Squelch Options

Tone Private-Line (PL), Digital Private-Line (DPL), and network ID are coded squelch modes; carrier squelch is not. Your system manager can program each mode with one of these squelch options as appropriate.

During carrier squelch operation, all traffic on the channel is heard. During PL or DPL operation, your radio responds to only those messages intended specifically for you.

Digital Squelch Options

Each conventional personality can be programmed for one of the following squelch options in digital mode:

- **Digital Carrier-Operated Squelch (DOS)** — This option allows you to hear all digital traffic.
- **Normal Squelch** — This option allows you to hear any digital traffic that has the correct network access code.
- **Selective Squelch** — This option allows you to hear any digital traffic that has the correct network access code and the correct talkgroup.
- **Data Squelch** — This option allows you to hear any digital traffic that matches the network access code and sel call packet.

Sending an Emergency Alarm

This feature is useful when you want to alert the dispatcher of an emergency condition. The dispatcher receives your radio ID in addition to the emergency message. An emergency call gives your radio priority over any other traffic on the channel.

Follow the steps below to send an emergency alarm:

Press the orange button **(T1)**.

The display alternately shows **EMERGENCY** and the name of the current zone and mode. You hear a short, medium-pitched (“emergency”) tone.



- Short tone

When the dispatcher acknowledges the emergency, you hear four short, medium-pitched tones and the display shows **ACK** **RCVD**. The radio automatically exits emergency mode and returns to the home display.

Note: If you do not receive an acknowledgment for the emergency alarm, the radio automatically re-transmits the emergency alarm. The number of repetitions is preprogrammed by your system manager.

Sending an Emergency Call

These steps explain the sending of a trunked *emergency alarm with call*. When sending a trunked emergency call only (not available for conventional emergency), an emergency alarm is not automatically sent to the dispatcher.

- 1 Press the orange button (**T1**).

EMERGENCY and the zone and mode are alternately displayed, and a short, medium-pitched emergency tone sounds.

The emergency alarm is automatically sent to the dispatcher.



- 2 Press the **PTT** button and announce your emergency.

The emergency alarm ends and the radio enters the emergency call mode. The radio operates in the normal *dispatch manner* while in emergency call operation.

- 3 To exit the emergency call mode, press the orange emergency button (**T1**) for more than 1-1/2 seconds (programmable).

A medium-pitched exit tone sounds until you release **T1**. The radio returns to normal operation.

Notes: The operating mode for your emergency call assumes one of two possible programmed operations:

- For non-revert operation, you will talk on the mode you selected before the emergency call.
- For revert operation, you will talk on a programmed emergency mode.

If you change operating modes while in emergency call operation, the emergency call is moved to, and continues on, the new mode.



Important: Exit the emergency call mode when you have finished.

Special Considerations for Emergencies

- If you press the emergency button while in a mode that has no emergency capability, a low-pitched tone sounds.
- If the unit is out of the range of the system and/or the emergency alarm is not acknowledged, a tone sounds and the display shows NO ACK.
- If you press the emergency button, then change to a mode that has no emergency capability, a NO EMERG display alternates with the mode name display, and a continuous low-pitched tone sounds until a valid emergency mode is selected or until the emergency is cancelled.
- When an emergency is active, changing to another mode where emergency is enabled (trunked or conventional) causes an emergency alarm and/or emergency call to be active on the new mode.

Types of Scan

Your XTL 1500 radio can monitor traffic on many different channels by scanning a list containing as many as 15 conventional or trunked modes. Up to 2 different scan lists are available per radio. A special package configured by your service provider can allow up to a maximum of 20 scan lists. Setting the modes to be scanned is programmed in advance by a qualified radio technician.

Types of Scan Lists

| <i>List Type</i> | <i>Description</i> |
|------------------|---|
| Conventional | Only conventional modes are in the list. |
| Talkgroup Scan | Conventional and Trunking modes from one trunking system are in the list. Priority scan operation is not available. |

Types of Scanning

| <i>Type</i> | <i>Description</i> |
|----------------------|---|
| Automatic (autoscan) | When selected, a channel with autoscan automatically begins scanning its associated scan list. The radio continues auto scanning until you select a channel without autoscan enabled. |
| Operator-Selectable | Scan can be programmed, by a qualified radio technician, to be selected either from a menu or by a preprogrammed Scan button. |

Notes:

- You cannot turn scan off on a mode that has autoscan enabled.
- Scan lists stay in memory when you turn scan off, turn the radio off, or disconnect the radio from the battery.

Turning Scan On or Off

- 1 Press  below SCAN.

OR

Alternatively press the preprogrammed **Scan** button.



- 2 The display shows SCAN ON if previously SCAN OFF was selected and the scan indicator is turned on.



OR

- 3 The display shows SCAN OFF if previously SCAN ON was selected and the scan indicator is turned off



Deleting Nuisance Modes

During scanning, you can temporarily delete modes you do not want to hear. This feature must be preprogrammed by your system manager.

Follow these steps to delete a nuisance mode:

- 1 When the radio is locked onto the mode you want to delete, Press the preprogrammed *Nuisance Delete* button.

OR

Press the **NUIS** softkey to delete the mode.

A valid key-press chirp tone sounds. The mode is deleted and the radio continues to scan the remaining modes.

Note: You cannot delete priority modes and the designated transmit channel.

- 2 To resume scanning the deleted mode, press scan off and then back on again.

OR

Turn power off and then back on again.

PTT-ID (Optional)

This stands for Push-to-Talk ID. This feature is programmed as needed for each channel by your system manager.

If this feature is made available for your talkgroup, it allows you to see the ID number of the radio from which you are receiving a transmission. This ID could be up to eight characters in length and is shown on your display as well as on your dispatcher's display.

In addition, your radio ID number is automatically sent when you transmit. For digital voice transmissions, your radio ID is sent continuously during the voice transmission.

Time-Out Timer

A time-out timer function prevents locking up a repeater or channel by prolonged keying of the transmitter. You cannot transmit longer than the preset timer setting. If you attempt to do so, the radio automatically stops your transmission, and you hear a talk-prohibit tone.

Note: You will hear a brief, low-pitched, warning tone four seconds before the transmission times out.

The timer is set for 60 seconds at the factory, but it can be reprogrammed by a qualified radio technician for between 15 and 465 seconds (7.75 minutes), in 15-second intervals, or it can be disabled entirely for each radio mode.

Telephone Operation (Conventional and Trunking)

You can use your radio in a manner similar to a standard telephone.

Answering a Telephone Call

Note: This section is only applicable for trunking modes.

When your radio receives a telephone call:

- Telephone-like ringing sounds.
- PHN CALL and the present mode are alternately displayed.
- The Call-Received status annunciator (🎵) blinks in the display.



Note: Incoming phone numbers are not stored in the phone list.

- 1 Press the **RESP** softkey or the Call-Response preprogrammed menu button.

Note: The Call-Received status annunciator is no longer displayed.

- 2 Press the **PTT** button to talk; release the **PTT** button to listen.
- 3 Press **EXIT** or the Phone menu button to hang up. The radio returns to the home display.

Note: For conventional mode, your radio behaves as in normal dispatch call. When it receives a telephone call, the radio immediately unmutes with the display blank.

Call Alert (Conventional and Trunking)

With Call Alert, your radio can receive, respond to, and send pages (like a beeper), depending upon how it is programmed.

Paging the Last ID Number Transmitted or Received

- 1 Press the  button below PAGE.



- 2 The display shows the last ID number transmitted or received.

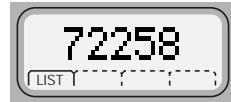

- 3 Go to "Sending a Call Alert Page" on page 38 to send your page.

Entering Directly the ID Number to Be Paged

You can use the keypad to directly enter the ID number of the person you want to page. Follow these steps to enter the ID directly:

- 1 For Call Alert, press the PAGE softkey.



The display shows the last ID number transmitted or received.



- 2 Use the keypad to enter the new ID number.



Notes: If you enter more than six digits and press the **PTT** button, you will hear a bad key-press tone.

Press the ◀ button to move the cursor to the left and erase the previous digit. When you have erased the last digit, press the ◀ button to display the last entry in the list. Press the ▶ button to display the first list entry.

Scrolling to an ID Number in the Page List

- 1 Press the ● button below **PAGE**.



- 2 The display shows the last ID number transmitted or received.



- 3 Rotate the **Mode** Knob to scroll through the list.

The member's name and ID number are alternately displayed when you stop.

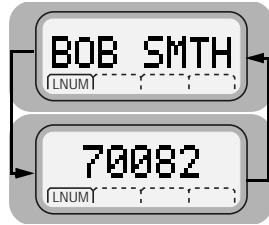

Note: The last member of the list equals the last ID number transmitted or received. This is the same as location **00** in the list.

- 4 Refer to "Sending a Call Alert Page" on page 38 to send your page.
-

Going Directly to an ID Number in the Page List

Note: See “Programming a Page or Call Number” on page 55.

- 1 Press the  button below PAGE.



- 2 The display shows the last ID number transmitted or received.



- 3 Rotate the **Mode Knob** to scroll through the list.

Note: The last member of the list equals the last ID number transmitted or received. This is the same as location **00** in the list.

- 4 Do the following:

- Press the numeric keys to enter the first digit of the location number.

That position in the list is immediately displayed only if there are fewer than 10 members. The member's name and ID number are alternately displayed.

OR

- If there are 10 or more members, **LOC#X|** is displayed (where X is a 0 or a 1 and it is the first digit entered).

The cursor blinks to show the location of the second digit.



- Press the numeric keys to enter the second digit of the location number.

The member's name and ID number are alternately displayed.

Note: The display shows `INVALID` if you enter a nonexisting number (for example, 24). The radio will revert back to step 4.

- 5 Refer to "Sending a Call Alert Page" on page 38 for sending a page.
-

Sending a Call Alert Page

Follow these steps to send a call alert page:

- 1 Press the **PTT** button.

If you hear four tones, the system has received the ID number. The radio you called is on the air and has received your page. Your radio automatically returns to the home display.

If you hear only one tone, the system has received the ID number, but the radio you are paging is not on the air. Proceed to the next step.

- 2 To try paging the number again, press the **PTT** button.

OR

To hang up, press the **EXIT** softkey to hang up. The radio returns to the home display.

Note: If you hear a low-pitched alert tone and the display shows `NO ACK`, the radio you called did not acknowledge the Call Alert within six seconds. Try again or press the **EXIT** softkey to exit.



Answering a Call Alert Page

- 1 If you hear a recurring four-beep tone, your radio is receiving a Call Alert page. The display alternately shows the current mode name and PAGE RCV. The Call-Received status annunciator (🎵) blinks.

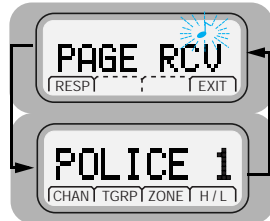

- Note:** The four-beep tone will continue until you answer the page or reset the radio.
- 2 To turn-off the Call Alert audible and visual indicators:
Press any keypad key or control head button (except the orange button), or change the mode.

You can answer a Call Alert page using the **PTT** button or using Enhanced Private Call.

Answering a Page Using PTT Button

- 1 Press the **PTT** button.
The display shows the current mode. The audible alert and 🎵 status annunciator turns off.
 - 2 The radio stores the ID number of the paging radio as the last ID number received.
- Note:** Pressing the **PTT** button enables you to transmit, and releasing it enables you to listen to a transmission. Everyone in the talkgroup will hear your voice when you transmit.

Answering a Page Using Enhanced Private Call

- 1 Press the programmed quick-response or call button.

OR

Press the  button below **CALL**.

The display shows the ID number of the paging radio.



- 2 Press the **PTT** button.
The ID number is transmitted.
- 3 Pause for one second to allow the alert tone to sound on the receiving radio.
Release the **PTT** button to listen to the transmission.

Notes: The display shows **NO ANSR** if the party does not answer within 20 seconds. An alert tone sounds and the telephone-like ringing will stop.



The display shows **NO ACK** if the called radio is not in service. No ringing will sound.



- 4 Press the **PTT** button to continue with your Private Conversation after you hear the other party's voice.
 - 5 Press **EXIT** to hang up. The radio returns to the home display.
-

Optional External Alarms (Horn and/or Lights)

Your radio can be equipped to activate external alarms when a Call Alert page, Selective Call, or Private Conversation call is received.

This feature is useful when you must leave the vehicle, but need to receive any incoming messages. Because this option requires the installation of additional relays, ask the system administrator if this option is installed.

Turning External Alarm(s) On or Off

Permanent Horn and/or Lights

- 1 Press the  button below H/L.
- 2 The display shows H/L ON if previously H/L OFF was selected and enables horn and lights.



The display alternatively shows the enabled alarm and the selected mode.

Note: The radio will remember the current state of the horn and lights feature when the radio is turned off

Changing or Turning Off the Selected Alarm(s)

- 1 Press the  button below H/L.
- 2 The display shows H/L OFF if previously H/L ON was selected and disables horn and lights.



The display alternatively shows the enabled alarm and the selected mode.

When a Call Is Received While Alarms Are Turned On

When a call is received, the vehicle's horn sounds for four seconds, and/or the vehicle's lights turn on for 60 seconds. (These time intervals can be changed by the system administrator.)



The display alternates between the type of call received (CALL RCV, or PAGE RCV) and the selected mode name. The Call-Received status annunciator both blink.

Non-rearmable

To turn off the external alarm(s), press the  button below H/L or any other control head button.

When the external alarm(s) are turned off, the feature is deactivated. To reactivate the feature, perform the steps of “Turning External Alarm(s) On or Off” on page 41.

Rearmable

To turn off the external alarm(s), press any control head button. When the external alarm(s) are turned off, they are automatically rearmed.

Conventional Features

This chapter shows you how to access features available in conventional operation. The following topics are covered:

- Repeater/Direct Operation (page 43)
- Status Calls (Digital Modes Only) (page 44)
- Smart PTT (page 45)
- Talkgroup Calls (page 46)
- Selective Calls (page 47)

Repeater/Direct Operation

Two types of operation are available with this feature:

| | |
|-----------------|---|
| Direct | You can bypass the repeater and talk directly to another radio. The transmit and receive frequencies are identical. |
| Repeater | You talk through the repeater, thereby increasing the radio's range. The transmit and receive frequencies differ. |

If repeater/direct is associated with a mode, that mode is programmed by your system manager for repeater or direct operation.

Status Calls (Digital Modes Only)

Radio status calls are used to inform the dispatcher of the present state of the mobile unit. For example, a status might be **ENROUTE** or **AT SITE**. Status names are field programmable. Each radio can have up to 8 separate statuses.

Sending a Status Call

- 1 Press the **STS** softkey, and the display shows the last-acknowledged status name.
- 2 Rotate the **Mode knob** to review the list of status names, or use the keypad to enter the number of the status you wish to send.

Note: If no button is pressed for a period of time, an inactivity warning will sound.

- 3 The display shows the desired status name or number, press the preprogrammed **SEL** menu button or the **PTT** button to send the transmission.

One of the following conditions occurs:

- The radio display shows **PLS WAIT** until the transmission is received and acknowledged.

When the dispatcher acknowledges the status, four high-pitched tones sound, and the display shows **ACK RCVD**.

The radio then returns to normal dispatch operation.

- If the status is **not acknowledged** after approximately six seconds, the display alternates between **NO ACK** and the associated status name. A low-pitched tone also sounds continuously.
- If there is no acknowledgment, do one of the following:

Press the microphone **PTT** button or preprogrammed **SEL** menu button to resend the status transmission.

OR

Press the **EXIT** softkey to return to normal dispatch operation.

Smart PTT

Smart PTT is a feature that can be programmed for modes according to your needs and/or the needs of your workgroup. This gives the system manager better control of radio operations. You may notice two differences in radio operation while on a mode programmed for Smart PTT:

- You will not be able to transmit and will hear a continuous alert tone until you release the PTT button.
- The monitor function is disabled.

Three radio-wide variations of smart PTT can be enabled on your radio:

| | |
|---|--|
| Transmit Inhibit on Busy Channel | You will not be able to transmit if any traffic is detected on the mode. |
| Transmit Inhibit on Busy Mode with Wrong Squelch Code feature | You will not be able to transmit on an active mode with a squelch code other than your own; or with an encryption key other than your own if your radio is secure-equipped. You can transmit if the PL code is the same as yours. |
| Quick-Key Override | This feature can work with variation 1 or 2. You can override transmit-inhibit by quick-keying the radio; in other words, pressing the PTT button twice within the time programmed for Smart PTT Quick-Key Timer . (The default value is half a second). |

Talkgroup Calls

This feature enables your system manager to define a group of conventional system users who can share the use of a conventional channel. Talkgroups can be associated with a personality as programmed by your system manager, or you can select them yourself.

If you have a radio that is secure-equipped, encryption keys are slaved to talkgroups. When talkgroups are enabled, encryption keys can be selected by changing the active talkgroup. (See “Secure Features” on page 73 for more information.)

Selecting a Talkgroup

Follow the steps below to select a talkgroup:

- 1 Press the  button directly below TGRP. The display shows the last user-selected and stored talkgroup, and the available menu entries.



- 2 Rotate the **Mode Knob** to scroll through the list of talkgroups.

OR

Use the keypad to enter the number of the desired index.

- 3 Press the  button directly below PSET (PRESET) to select the preset or programmed talkgroup.



OR

Press the  button directly below SEL (SELECT) to save the currently displayed talkgroup and return to the home display.

Note: If the encryption key slaved to the new talkgroup is erased, the display shows **KEY FAIL**. You hear a momentary key fail tone.



If the encryption key slaved to the new talkgroup is not allowed, the display shows **ILGL KEY**. You hear a momentary illegal key tone.



- 4 Press the **EXIT** to exit this menu.
-

Selective Calls

With the Selective Call feature, your radio conversation is heard only by you and the other party involved.

Calling the Last ID Number Transmitted or Received

- 1 Press the  button below **CALL**



- 2 The display shows the last ID number transmitted or received.



- 3 Refer to “Starting a Selective Call” on page 51 to place your call.
-

Entering Directly the ID Number to Be Called

You can use the keypad to directly enter the ID number of the person you want to call. Follow these steps to enter the ID directly:

- 1 For Selective Call, press the **CALL** softkey.

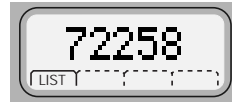

The display shows the last ID number transmitted or received.

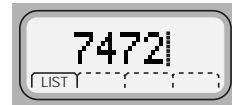

- 2 Use the keypad to enter the new ID number.



Notes: If you enter more than, or less than, six digits and press the **PTT** button, you will hear a bad key-press tone.

Press the  button to move the cursor to the left and erase the previous digit. When you have erased the last digit, press the  button to display the last entry in the list. Press the  button to display the first list entry.

Scrolling to an ID Number in the Call List

The same call list is shared by the Private Conversation.

- 1 Press the  button below CALL.

The display shows the last ID number transmitted or received.

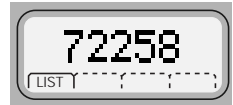

- 2 Rotate the **Mode Knob** to scroll through the list.

The member's name and ID number are alternately displayed when you stop.

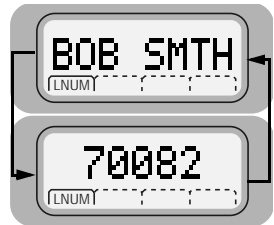

Note: The last member of the list equals the last ID number transmitted or received. This is the same as location **00** in the list.

- 3 Refer to “Starting a Selective Call” on page 51 to place your call.

Going Directly to an ID Number in the Call List

- 1 Press the  button below CALL.

The display shows the last ID number transmitted or received.



- 2 Rotate the **Mode Knob** to scroll through the list.

Note: The last member of the list equals the last ID number transmitted or received. This is the same as location **00** in the list.

- 3 Do the following:

- Press the numeric keys to enter the first digit of the location number.

That position in the list is immediately displayed only if there are fewer than 10 members. The member's name and ID number are alternately displayed.

OR

- If there are 10 or more members, LOC#X| is displayed (where X is a 0 or a 1 and it is the first digit entered).



The cursor blinks to show the location of the second digit.

- 4 Press the numeric keys to enter the second digit of the location number.

The member's name and ID number are alternately displayed.

Note: The display shows **INVALID** if you enter a nonexisting number (for example, 24). The radio will revert back to step 3.

Starting a Selective Call

Follow the steps below to initiate a Selective Call:

- 1 Press the **PTT** button.

The display shows the caller ID number and Zone channel.

The Call-Received status annunciator (🎵) blinks

- 2 Pause for one second for the alert tone to sound on the receiving radio.
- 3 When the person you called answers, press the **PTT** button to respond.
- 4 To hang up, press the **EXIT** softkey.

The radio returns to the home display.

Notes

Trunking Features

Features Used on Trunking Systems

This chapter shows you how to access features available on trunking systems. The following topics are covered:

- Viewing Your Radio's ID Number (page 54)
- Programming a Page, Call, or Phone List Number (page 55)
- Programming a Page, Call, or Phone List Name (page 58)
- Enhanced Private Conversation (page 60)
- Dynamic Regrouping (page 67)
- SmartZone Operation (page 68)
- Out-of-Range Indication (page 71)
- Trunked Announcement (page 72)

Viewing Your Radio's ID Number

- 1 Press the  button below CALL.



- 2 The display shows the ID number.

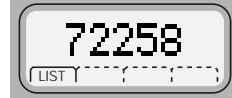

- 3 Press the left navigation key on the keypad mic.

OR

If you are in the preprogrammed call list, press the  button on the keypad mic.



The display shows ID: and the ID number.

- 4 Press the EXIT softkey to return to the home display.
-

Programming a Page or Call Number

This feature lets you change the ID numbers assigned to the call lists used by the trunked Private Conversation™ and Call Alert features, as well as the phone numbers used by the phone feature.

- 1 Press the  button below PROG.



- 2 Press the  button below PHON, CALL or PAGE as appropriate to access the call list you want to edit.



The display shows the first member's name above either the phone number or above the radio ID number.





- 3 Rotate the **Mode Knob** buttons to view other list members.

OR

To directly access an entry, use the keypad to enter its numerical position in the list (any programmed location from 1 to 100).

- 4 Press the NUM softkey to enter number edit mode.
- 5 Erase the old number by pressing the  button to delete each digit.

Note: If you accidentally erase all the numbers, press the  or  button to exit without making any changes. Start again at step 3. To return to the home display without making any changes, press the EXIT softkey.

Trunking Features

- 6** Press the numeric keys (**0** through **9**) to enter the new number.

The blinking cursor indicates the position of the next number to be added.



To enter a number at the blinking cursor, refer to the following table.

The following table shows what keys to press and how many times to press them to enter a character.

| Key | Number of times the key is pressed | | | | | | | | |
|-----|------------------------------------|-----|-----|---|---|---|---|---|---|
| | 1 | 2 | 3 | 4 | 5 | 6 | 7 | 8 | 9 |
| 0 | 0 | () | < > | | | | | | |
| 1 | 1 | & | % | | | | | | |
| 2 | A | B | C | 2 | a | b | c | | |
| 3 | D | E | F | 3 | d | e | f | | |
| 4 | G | H | I | 4 | g | h | i | | |
| 5 | J | K | L | 5 | j | k | l | | |
| 6 | M | N | O | 6 | m | n | o | | |
| 7 | P | Q | R | S | 7 | p | q | r | s |
| 8 | T | U | V | 8 | t | u | v | | |
| 9 | W | X | Y | Z | 9 | w | x | y | z |
| * | * | / | + | - | = | | | | |
| # | # | . | ! | ? | , | ; | | | |

Note: Some phone networks require a pause in the phone dialing sequence. To enter a pause in a phone number (up to 16 digits), press ***** first, and then **#**. The display shows **P** for pause.

7 Do one of the following:

- Press the **SAVE** softkey to save your changes.

You can continue to edit other numbers by returning to step 3.

OR

- Press the **EXIT** softkey to exit the number editing mode without saving the changes.

8 Press the **EXIT** softkey to exit the programming mode and return to the home display.

Programming a Page or Call Name

This feature lets you change the ID names assigned to the call lists used by the trunked Private Conversation and Call Alert features, as well as the phone names used by the phone feature.

- 1 Press the  button below PROG.



- 2 Do one of the following:

- Press the  button below PHON to access the phone list,



OR

- Press the  button below CALL or PAGE to access the call list.

The display shows the first member's name above either the phone number or above the radio ID number.

The display shows the programming-mode annunciator (a blinking ) until you exit the programming list mode.



- 3 Do one of the following:

- Rotate the **Mode Knob** to view other list members.

OR

- Use the keypad to enter a member's position number (any preprogrammed location from 1 to 100) to go directly to that member.

- 4 Press the NAME softkey, to enter the name edit mode.

- 5 Erase the old name by pressing  to delete each character.

Note: If you erase all of the characters, Rotate the **Mode Knob** to exit without making any changes. Begin again at step 3, or press **EXIT** to return to the home display.

- 6** Press any button on the telephone-style keypad to enter new characters.

The blinking cursor indicates the position of the next character to be added.



To enter a character at the blinking cursor, refer to the following table.

Refer to the table on page 56 to see what keys to press and how many times to press them to select a character.

Note: To leave a space in the text, press  twice.

- 7** Do one of the following:

- Press the **SAVE** softkey to save your changes.

You can continue to edit other names by returning to step 3.

OR

- Press the **EXIT** softkey to exit the name editing mode without saving the changes.

- 8** Press the **EXIT** softkey to exit the programming mode and return to the home display.
-

Hang Up Box (HUB)

To temporarily suspend Scan Mode operation, remove the microphone from the Hang Up Box (HUB). You are allowed to use the microphone while scan is suspended. Priority Member scanning is **not** suspended, however. This feature applies to all Scan Lists and Scan Types. Scan is resumed once the microphone is returned to the holding clip and the preprogrammed hang time has elapsed.

Priority Scan List members are continuously scanned only when the Scan List, **Designated Tx Member** field is set to "Talkback" in the radio programming. Otherwise, all scan mode operation is suspended.

Enhanced Private Conversation

With Enhanced Private Conversation™, your radio conversation is heard only by you and the other party involved.

Calling the Last ID Number Transmitted or Received

- 1 Press the  button below CALL.
The display shows the last ID number transmitted or received.
- 2 The display shows the last ID number transmitted or received.



- 3 Refer to "Sending a Private Conversation Call" on page 64 to place your call.
-

Entering Directly the ID Number to Be Called

You can use the keypad to directly enter the ID number of the person you want to call. Follow these steps to enter the ID directly:

- 1 For Private Conversation, press the  button to scroll to the CALL softkey.



The display shows the last ID number transmitted or received.

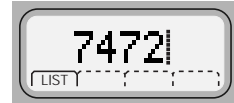

- 2 Use the keypad to enter the new ID number.



Notes: If you enter more than, or less than, six digits and press the PTT button, you will hear a bad key-press tone.

Press the  button to move the cursor to the left and erase the previous digit. When you have erased the last digit, press the  button to display the last entry in the list. Press the  button to display the first list entry.

Scrolling to an ID Number in the Call List

The same call list is shared by Selective Call.

- 1 Press the  button below CALL.
The display shows the last ID number transmitted or received.

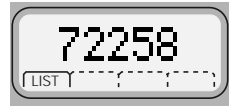

- 2 Rotate the **Mode knob** to scroll through the list.

The member's name and ID number are alternately displayed when you stop.

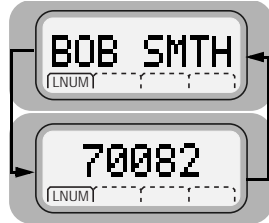

Note: The last member of the list equals the last ID number transmitted or received. This is the same as location **00** in the list.

- 3 Refer to "Sending a Private Conversation Call" on page 64 to place your call.

Going Directly to an ID Number in the Call List

- 1 Press the  button below CALL.

The display shows the last ID number transmitted or received.



- 2 Rotate the **Mode knob** to scroll through the list.

Note: The last member of the list equals the last ID number transmitted or received. This is the same as location **00** in the list.

- 3 Do the following:

- Press the numeric keys to enter the first digit of the location number.

That position in the list is immediately displayed only if there are fewer than 10 members. The member's name and ID number are alternately displayed.

OR

If there are 10 or more members, **LOC#X|** is displayed (where **X** is a 0 or a 1 and it is the first digit entered).



The cursor blinks to show the location of the second digit.

- Press the numeric keys to enter the second digit of the location number.

The member's name and ID number are alternately displayed.

Note: The display shows **INVALID** if you enter a nonexisting number (for example, 24). The radio reverts back to step 3.

- 4 Refer to "Sending a Private Conversation Call" on page 64 to place your call.

Sending a Private Conversation Call

Follow the steps below to initiate a Private Call:

- 1 Press the **PTT** button to send a Private Conversation Call to the radio whose ID number you have selected.

The radio transmits the ID number.

- 2 Pause for one second for the alert tone to sound on the receiving radio.

Notes: If the party does not answer within 20 seconds, the display shows **NO ANSR**. You hear an alert tone and the telephone-like ringing stops.



If the radio you called is not in service, the display shows **NO ACK**. You will not hear ringing.



- 3 When the person you called answers, press the **PTT** button to respond.
- 4 To hang up, press the **EXIT** softkey.

The radio returns to the home display.

Answering an Enhanced Private Conversation Call

If you hear two alert tones (repeating every 5 seconds for 20 seconds) sound, **CALL RCV** and the present mode are alternately displayed.



The Call-Received status annunciator (🎵) blinks.

Note: If you do not answer within 20 seconds, the radio returns to the home display.

- 1 Press the  button below **CALL**.

OR

If your radio has a programmed call-response or call button, press it to see the display shown in step 2. Proceed to step 3.

- 2 The display shows the last ID number transmitted or received either as the incoming caller's ID number (Private Conversation II).

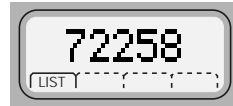

Note: If you press the **PTT** button before you press the quick-response button, your response is transmitted to everyone in the talkgroup. Press the **PTT** button to answer the call.

- 3 A busy tone indicates the system is busy. If you hear a call-back tone, a mode is available. The radio automatically keys up for three seconds, after which you can begin speaking.

4 To hang up, do one of the following:

- Press the **EXIT** softkey.

OR

- Press the preprogrammed quick-response button if your radio has one.

The caller's ID number is saved as the last ID number received.

The radio returns to the home display.

Dynamic Regrouping

This feature is programmed in each radio by a qualified radio technician. During special operations, dynamic regrouping allows the dispatcher to temporarily reassign selected radios to a single trunked mode so they can communicate with each other.

Electronic (Menu) Mode Selection

Dynamic Regrouping is transparent to you until the dispatcher activates it. You hear an invalid-mode tone if you select dynamic regrouping from the radio menu and it is not active.

- If you hear a gurgle-like tone, dynamic regrouping is activated. Transmit and receive as usual.
- When the dispatcher cancels dynamic-regrouping:
 - The radio returns to the pre-dynamic regrouping mode if the dynamic regrouping mode was selected.
 - The radio remains active on the selected mode if the dynamic regrouping mode was not selected.

Selecting Enable and Disable

The dispatcher can classify regrouped radios as *select-enabled* or *select-disabled*.

- Select-enabled radios can be changed to any available mode including the dynamic regrouping mode, once the dynamic position is selected.
- Select-disabled radios can not be changed from the dynamic mode that the dispatcher has selected.

Note: Scan, phone, and Private Conversation cannot be selected while the radio is select disabled.

SmartZone Operation

A SmartZone® system allows up to 50 sites in a wide-area trunking system. Site switching features allow the radio to quickly switch to other sites within the SmartZone system. These features are based on signal strength and site preferences. No action is required on your part for site switching.

However, your radio does have other SmartZone features that you can access.

Locking/Unlocking a Site

- 1 Press the  button below **SITE**.
The display shows the current lock state (**LOCKED** in this case) together with **UNLK**, and **LOCK** softkeys on the lower line.

OR

Press the preprogrammed Site Lock button to display the current lock state. Press and hold the preprogrammed Site Lock button. The lock state (**SITE LOCKED** or **SITE UNLOCKED**) will change once. Release the button to save the new lock state.



Note: You can view the current site by pressing the preprogrammed search button.

- 2 The home display returns.
-

Searching for a Site

The display shows **SITE XX** when you press the programmable *site view* button if your SmartZone radio has not received the current site's ID from the control channel.



1 Do one of the following:

- Momentarily press the preprogrammed Search button.

The display shows the number or name of the affiliated site, followed by the Received Signal Strength Indicator (RSSI) level of the site.



OR

- Press and hold the preprogrammed **Search** button.

The display shows **SCANNING** until the radio affiliates with a new site. The number of the new site is then displayed.



2 The home display is automatically returned.

Site Trunking

STE TRNK is alternately displayed (if so programmed) with the selected mode whenever the radio's usable site is not communicating with the SmartZone controller. You can only communicate with other radios operating at the same site when STE TRNK is displayed. No wide-area calls can be made from a site-trunking site.

Failsoft

If a trunking system experiences a complete failure, the radio will revert to failsoft operation and automatically switch to its failsoft channel. During failsoft, trunking repeaters will transmit a medium-pitched tone every 10 seconds. The radio periodically leaves failsoft to search for a trunking site. The radio returns to failsoft if no trunking sites are found.

If you press the PTT button while the radio is searching for a trunking site, the radio returns to failsoft and transmits. In failsoft, you can only communicate with other radios on the same mode and site. No wide-area call can be made from a failsoft mode. When the trunking system returns to normal operation, your radio will automatically leave the failsoft operation and return to trunked operation.

Since the normal trunking features do not operate during failsoft, much of the privacy of trunked systems is lost. You must share the channel with other users until the failure is corrected.

To continue, in Failsoft, to communicate with other talkgroups:

- 1 Rotate the **Mode knob** switch to change to a different repeater frequency.

The failsoft condition is indicated by a faint beeping tone every nine seconds (radio unscquelched).

When the trunking system returns to normal operation, the beeping tone stops.

- 2 Press the **PTT** button to talk, and release the button to listen.
-

Out-of-Range Indication

The out-of-range display/audible indication feature can be enabled by your system manager. The display alternately shows `OUT RNG` and the current selected mode name. You hear a low-pitched tone every six seconds:

- When the radio is out of range of the system and can no longer lock onto the control channel,

OR

- When the radio is in failsoft and cannot lock onto the failsoft channel.

The out-of-range indication remains in effect until one of the following conditions occur:

- The radio locks on a control channel.
- The radio locks on a failsoft channel.
- The radio is turned off.

Trunked Announcement

The announcement capability allows a user to make announcements to the entire user group, as well as monitor talkgroup calls and other announcements.

Announcement calls are handled in two different ways, depending on the trunked central controller configuration. The two types are called *ruthless* and *non-ruthless* preemption.

- **Ruthless Preemption:** When a ruthless preemption announcement call is initiated, the requesting radio begins transmitting immediately. All associated talkgroup calls taking place on other channels are immediately halted, and the radios are steered to the announcement call.

Transmitting radios continue to transmit until the PTT button is released, at which time they also unmute for the announcement call. Individual calls (Private Conversation and telephone interconnect) are not affected.

- **Non-Ruthless Preemption:** When a non-ruthless preemption announcement is initiated, the initiating unit receives a telephone-type busy tone, followed by a call back when all associated talkgroup conversations end.

Once an announcement call is pending, any attempts by other users to initiate a talkgroup call will result in a telephone-type busy tone. These users will not receive a call back until the announcement call is complete.

Initiating an Announcement

If your radio has been programmed to allow announcement calls:

- 1 Rotate the **Mode knob** to locate the announcement-group mode.
 - 2 Press the microphone **PTT** button to initiate the announcement.
-

Secure Features

Features Available on Secure XTL 1500

This chapter covers features available on XTL 1500 Digital Mobile Radios with secure encryption. The following topics are covered:

- Transmitting in Secure and Clear Modes (page 74)
- System Considerations (page 75)
- Loss Indication (page 75)
- Selecting a Key (Conventional Only) (page 76)

Note: The information in this section applies to both conventional and trunked systems.

Transmitting in Secure and Clear Modes

If your radio is secure-capable, you can transmit messages in secure mode.

To transmit a message in secure or encrypted mode:

- 1 Press and release the preprogrammed **SEC** softkey when your radio is on personalities or talkgroups that have been designated by your system manager for secure transmissions.
- 2 Press the **PTT** button to transmit while the radio is on a personality or talkgroup programmed for secure.

The radio will begin transmitting in secure mode. The display shows  (secure status annunciator) when the transmission is in progress.

To transmit a message in non-encrypted or clear mode:

Press and release the preprogrammed **SEC** softkey again.

The radio will transmit in clear mode when you press the **PTT** button. The display does not show the  status annunciator.

Note: You cannot change from secure to clear while the **PTT** button is pressed. The radio will generate an illegal tone and the transmission will be ended.

Take note that the radio will then exit from its current mode. If current mode is SECURE, then it will exit to CLEAR mode.

Secure-equipped radios automatically determine whether a voice message is being received in secure or clear mode. This allows you to receive either type of message without having to reset the preprogrammed Secure button.

System Considerations

- **Trunked Systems only:** If you press the **PTT** button when no secure-voice channel is available, the display shows **NO SEC** and a continuous talk-prohibit tone sounds until you release the **PTT** button.
- **Analog trunking systems:** You **are not allowed** to change from a secure transmission to a clear transmission during a secure trunked call. If you attempt to change from a secure to a clear transmission during a call, the radio generates a talk-prohibit tone, and the display will show **SEC ONLY**.
- **Digital trunking systems:** You **are allowed** to change from a secure transmission to a clear transmission during a secure trunked call.

Loss Indication

When you press the **PTT** button while in the coded mode and without the encryption module containing a valid key, the speaker generates bursts of alert tones, and the display shows **KEY FAIL** until you release the **PTT** button.

When the radio is first turned on, six medium-pitched tones sound and the display momentarily shows **KEY FAIL** to indicate that the encryption module does not contain a valid key for the current mode.

If the periodic keyfail tone feature is enabled, six medium-pitched tones are generated every five to ten seconds while the radio is not transmitting or receiving to remind you that the radio does not have a valid key for the current mode. The keyfail reminder will not sound when the radio is in clear mode.

Selecting a Key (Conventional Only)

This feature allows you to manually select one of the 18 encryption keys.

Follow these steps to select a key:

- 1 Press and hold down **SEC** softkey until a tone sounds, which indicates entry into the Secure Menu.

- 2 Press the  button below **KEY**.

The display shows the following options **SEL** (select), **ABRT** (abort) and **PSET** (pset). Rotate the **Mode Knob** to find the desired key.



- 3 Choose one of the following:

- a. To save a key, press **SEL** (select).



- b. To select the default encryption keys on a radio-wide basis, press **PSET**. Selecting preset will cause the radio to return to its preprogrammed keys on a per-zone/-mode basis.

- 4 To abort this menu, press **ABRT** or the **PTT** button. The **ABRT** option exits the key-select menu without saving the selected key choice. Pressing the **PTT** button exits the menu without saving the selected key choice and allows the radio to transmit.

Notes: When you abort the key-select menu, the radio uses the key that was selected prior to entry into the menu.

Troubleshooting

The following are suggestions to assist you in troubleshooting possible operating problems.



CAUTION

The cables that connect to the rear of the radio could have live voltage on some of their pins. Do not remove or reconnect these cables. Only a qualified radio technician should perform this task. Service performed by unauthorized personnel may cause the radio to transmit an emergency alarm even if the unit is turned off.

If your radio is locked up or the display shows FL 01/90, turn the radio off and then back on. If this does not correct the condition, take the radio to a qualified radio technician for service.

If radio operation is intermittent, check with other persons using the system for similar problems before taking the radio in for service. Similar problems indicate a system malfunction rather than a radio failure.

If symptoms persist or, if your unit exhibits other problems, contact a qualified radio technician.

Notes

Accessories

Motorola provides the following approved accessories to improve the productivity of your XTL 1500 mobile two-way radio.

For a list of Motorola-approved antennas, batteries, and other accessories, visit the following web site which lists approved accessories: <http://www.motorola.com/governmentandenterprise>

Antennas

| | |
|------------|--|
| HAD4006_ | VHF, 136–144 MHz, quarterwave whip, roof mount |
| HAD4007_ | VHF, 144–150.8 MHz, quarterwave, roof mount |
| HAD4008_ | VHF, 150.8–162 MHz, quarterwave, roof mount |
| HAD4009_ | VHF, 162–174 MHz, quarterwave, roof mount |
| RAD4010_RB | VHF, 136–174 MHz, halfwave, roof mount |
| HAE4003_ | UHF, 450–470 MHz, quarterwave whip |
| HAE4004_ | UHF, 470–512 MHz, quarterwave |
| HAE4011_ | UHF, 450–470 MHz, 3.5 db, roof mount |
| HAE4012_ | UHF, 470–495 MHz, 3.0 db, roof mount |
| HAE4013_ | UHF, 494–512 MHz, 3.0 db, roof mount |
| HAE6010_ | UHF, 380–433 MHz, 3.5 db gain |
| HAE6011_ | UHF, 380–433 MHz, 5.0 db gain |
| HAE6012_ | UHF, 380–433 MHz, quarterwave whip |
| HAE6013_ | UHF, 380–470 MHz, 2.0 db gain, wideband |
| RAE4014_RB | UHF, 450–470 MHz, 5.0 db |
| RAE4016_RB | UHF, 494–512 MHz, 5.0 db gain |
| HAF4013_ | 764–870 MHz, 3db, low profile |
| HAF4014_ | 764–870 MHz, 3db, elevated feed |
| HAF4016_ | 764–870 MHz, quarterwave, roof mount |
| HAF4017_ | 764–870 MHz, 3db, Collinear |

| | |
|------------|--|
| RRA4935_ | 900 MHz (890-960 MHz) 3 dBi Low Roof Top 14' cable length |
| RAF4003_RM | 900 MHz (890-960 MHz) 3 dBi Low Roof Top 22' cable length |

Cables

| | |
|----------|-------------------------------|
| HKN4191_ | Power, high-power, dash-mount |
| HKN6160_ | Data, 6-ft., dash-mount (kit) |
| GKN6271_ | Ignition Sense Cable |

Microphones

| | |
|----------|--------------------------------|
| HMN1090_ | Standard palm microphone |
| HMN4079_ | Keypad Microphone |
| HMN1088_ | ControlStation Desk Microphone |
| HMN1081_ | System 9000 |

Miscellaneous

| | |
|----------|-----------------------------|
| HLN5113_ | Emergency footswitch |
| HLN6188_ | Emergency pushbutton |
| HLN6372_ | Key lock mount |
| HLN5131_ | Emergency Pushbutton Switch |
| TLN4533_ | Relays |
| HKN4258_ | Cable Relays |

Speakers

| | |
|----------|---------------------------|
| HSN4031_ | 7.5 W MCS external |
| HSN4038_ | External 7.5 Watt Speaker |

Trunnion Kits

| | |
|----------|--------------------------------|
| HLN6861_ | HW Millennium Standard Install |
|----------|--------------------------------|

Notes

Appendix: Maritime Radio Use in the VHF Frequency Range

Special Channel Assignments

Emergency Channel

If you are in imminent and grave danger at sea and require emergency assistance, use **VHF Channel 16** to send a distress call to nearby vessels and the United States Coast Guard. Transmit the following information, in this order:

- 1 "MAYDAY, MAYDAY, MAYDAY."
- 2 "THIS IS _____, CALL SIGN _____."
State the name of the vessel in distress 3 times, followed by the call sign or other identification of the vessel, stated 3 times.
- 3 Repeat "MAYDAY" and the name of the vessel.
- 4 "WE ARE LOCATED AT _____."
State the position of the vessel in distress, using any information that will help responders to locate you, e.g.:
 - latitude and longitude
 - bearing (state whether you are using true or magnetic north)
 - distance to a well-known landmark
 - vessel course, speed or destination
- 5 State the nature of the distress.
- 6 Specify what kind of assistance you need.
- 7 State the number of persons on board and the number needing medical attention, if any.
- 8 Mention any other information that would be helpful to responders, such as type of vessel, vessel length and/or tonnage, hull color, etc.
- 9 "OVER."
- 10 Wait for a response.
- 11 If you do not receive an immediate response, remain by the radio and repeat the transmission at intervals until you receive a response. Be prepared to follow any instructions given to you.

Non-Commercial Call Channel

For non-commercial transmissions, such as fishing reports, rendezvous arrangements, repair scheduling, or berthing information, use **VHF Channel 9**.

Operating Frequency Requirements

A radio designated for shipboard use must comply with Federal Communications Commission Rule Part 80 as follows:

- on ships subject to Part II of Title III of the Communications Act, the radio must be capable of operating on the 156.800 MHz frequency
- on ships subject to the Safety Convention, the radio must be capable of operating:
 - in the simplex mode on the ship station transmitting frequencies specified in the 156.025–157.425 MHz frequency band, and
 - in the semiduplex mode on the two frequency channels specified in the table below.

Note: Simplex channels 3, 21, 23, 61, 64, 81, 82, and 83 **cannot be lawfully used** by the general public in US waters.

Additional information about operating requirements in the Maritime Services can be obtained from the full text of FCC Rule Part 80 and from the US Coast Guard.

Table A-1: VHF Marine Channel List

| Channel Number | Frequency (MHz) | |
|----------------|-----------------|---------|
| | Transmit | Receive |
| 1 | 156.050 | 160.650 |
| 2 | 156.100 | 160.700 |
| * | 156.150 | 160.750 |
| 4 | 156.200 | 160.800 |
| 5 | 156.250 | 160.850 |
| 6 | 156.300 | – |
| 7 | 156.350 | 160.950 |
| 8 | 156.400 | – |

Table A-1: VHF Marine Channel List (Continued)

| Channel Number | Frequency (MHz) | |
|----------------|-----------------|---------|
| | Transmit | Receive |
| 9 | 156.450 | 156.450 |
| 10 | 156.500 | 156.500 |
| 11 | 156.550 | 156.550 |
| 12 | 156.600 | 156.600 |
| 13** | 156.650 | 156.650 |
| 14 | 156.700 | 156.700 |
| 15** | 156.750 | 156.750 |
| 16 | 156.800 | 156.800 |
| 17** | 156.850 | 156.850 |
| 18 | 156.900 | 161.500 |
| 19 | 156.950 | 161.550 |
| 20 | 157.000 | 161.600 |
| * | 157.050 | 161.650 |
| 22 | 157.100 | 161.700 |
| * | 157.150 | 161.750 |
| 24 | 157.200 | 161.800 |
| 25 | 157.250 | 161.850 |
| 26 | 157.300 | 161.900 |
| 27 | 157.350 | 161.950 |
| 28 | 157.400 | 162.000 |
| 60 | 156.025 | 160.625 |
| * | 156.075 | 160.675 |
| 62 | 156.125 | 160.725 |
| 63 | 156.175 | 160.775 |
| * | 156.225 | 160.825 |
| 65 | 156.275 | 160.875 |
| 66 | 156.325 | 160.925 |
| 67** | 156.375 | 156.375 |
| 68 | 156.425 | 156.425 |

Table A-1: VHF Marine Channel List (Continued)

| Channel Number | Frequency (MHz) | |
|----------------|-----------------|---------|
| | Transmit | Receive |
| 69 | 156.475 | 156.475 |
| 71 | 156.575 | 156.575 |
| 72 | 156.625 | – |
| 73 | 156.675 | 156.675 |
| 74 | 156.725 | 156.725 |
| 75 | *** | *** |
| 76 | *** | *** |
| 77** | 156.875 | – |
| 78 | 156.925 | 161.525 |
| 79 | 156.975 | 161.575 |
| 80 | 157.025 | 161.625 |
| * | 157.075 | 161.675 |
| * | 157.125 | 161.725 |
| * | 157.175 | 161.775 |
| 84 | 157.225 | 161.825 |
| 85 | 157.275 | 161.875 |
| 86 | 157.325 | 161.925 |
| 87 | 157.375 | 161.975 |
| 88 | 157.425 | 162.025 |

* Simplex channels 3, 21, 23, 61, 64, 81, 82, and 83 **cannot be lawfully used** by the general public in US waters.

** Low power (1 W) only

*** Guard band

Note: A – in the Receive column indicates that the channel is transmit only.

Glossary

| | |
|-----------------------------------|---|
| ACK | A cknowledgment of communication. |
| Channel | A group of characteristics, such as transmit/receive frequency pairs, radio parameters, and encryption encoding. |
| Coded Squelch | Used on conventional channels to make sure you hear only the communication meant for you. |
| Control Channel | In a trunking system, one of the channels that is used to provide a continuous, two-way/data communications path between the central controller and all radios on the system. |
| Conventional | Typically refers to radio-to-radio communications, sometimes through a repeater. You share a frequency, or frequencies, with other users without the aid of a central controller to assign communication channels. Therefore, you should monitor each channel before transmitting to avoid interfering with another user who may be transmitting. |
| Cursor | A visual tracking marker (a blinking line) that indicates a location on the display. |
| Digital Private-Line (DPL) | A continuous, sub-audible data signal, transmitted with the carrier. |
| Dispatcher | An individual who has radio system management duties. |
| Failsoft | A back-up system allowing you to communicate in a non-trunked, conventional mode should the trunked system fail. |
| FCC | F ederal C ommunications C ommission. |
| Hang Up | Disconnect. |

| | |
|--|---|
| Home Display | The first display information after the radio completes its self test. |
| LCD | Liquid-Crystal Display. |
| Mode | A programmed combination of operating parameters; for example, a channel or talkgroup. |
| Mode-Slaving | Radio programmed to automatically give the proper operation for a given mode you have selected. |
| Monitoring (Conventional Operation) | Press a programmed monitor button to listen to traffic on the active channel. This way, you can avoid talking over someone else's conversation. |
| Page | A one-way alert, with audio and/or display messages. |
| Push-To-Talk (PTT) Button | The PTT button engages the transmitter and places the radio in transmit (send) operation when pressed. Press this button to transmit, and release it to receive. |
| Repeater | A conventional radio feature, in which you talk through a receive/transmit facility that re-transmits received signals in order to improve communications range and coverage. |
| RF | Radio Frequency. A part of the general frequency spectrum between the audio and infrared light regions (about 10 kHz to 10,000,000 MHz). |

| | |
|---|---|
| Squelch | The muting of audio circuits when received signal levels fall below a pre-determined threshold. With carrier squelch, you hear all channel activity which exceeds the radio's preset squelch level. |
| Standby | An operating condition whereby the radio's speaker is muted but still continues to receive data. |
| Talkgroup | An organization (or group) of radio users who communicate with each other, using the same communication path. |
| Tone Private-Line (PL) Coded Squelch | A continuous sub-audible tone transmitted with the carrier. |
| Trunking | The automatic sharing of communications paths between a large number of users. Allows radio users to share a smaller number of frequencies because a repeater, or communications path, is assigned to a talkgroup for the length of a conversation. |
| Zone | A grouping of channels or talkgroups. |

Notes

Commercial Warranty and Service

Limited Warranty

MOTOROLA COMMUNICATION PRODUCTS

I. WHAT THIS WARRANTY COVERS AND FOR HOW LONG:

MOTOROLA INC. (“MOTOROLA”) warrants the MOTOROLA manufactured Communication Products listed below (“Product”) against defects in material and workmanship under normal use and service for a period of time from the date of purchase as scheduled below:

| | |
|-------------------------------|--------------|
| ASTRO XTL 1500 Portable Units | One (1) Year |
| Product Accessories | One (1) Year |

Motorola, at its option, will at no charge either repair the Product (with new or reconditioned parts), replace it (with a new or reconditioned Product), or refund the purchase price of the Product during the warranty period provided it is returned in accordance with the terms of this warranty. Replaced parts or boards are warranted for the balance of the original applicable warranty period. All replaced parts of Product shall become the property of MOTOROLA.

This express limited warranty is extended by MOTOROLA to the original end user purchaser only and is not assignable or transferable to any other party. This is the complete warranty for the Product manufactured by MOTOROLA. MOTOROLA assumes no obligations or liability for additions or modifications to this warranty unless made in writing and signed by an officer of MOTOROLA. Unless made in a separate agreement between MOTOROLA and the original end user purchaser, MOTOROLA does not warrant the installation, maintenance or service of the Product.

MOTOROLA cannot be responsible in any way for any ancillary equipment not furnished by MOTOROLA which is attached to or used in connection with the Product, or for operation of the Product with any ancillary equipment, and all such equipment is expressly excluded from this warranty. Because each system which may use the Product is unique, MOTOROLA disclaims liability for range, coverage, or operation of the system as a whole under this warranty.

II. GENERAL PROVISIONS:

This warranty sets forth the full extent of MOTOROLA'S responsibilities regarding the Product. Repair, replacement or refund of the purchase price, at MOTOROLA's option, is the exclusive remedy. THIS WARRANTY IS GIVEN IN LIEU OF ALL OTHER EXPRESS WARRANTIES. IMPLIED WARRANTIES, INCLUDING WITHOUT LIMITATION, IMPLIED WARRANTIES OF MERCHANTABILITY AND FITNESS FOR A PARTICULAR PURPOSE, ARE LIMITED TO THE DURATION OF THIS LIMITED WARRANTY. IN NO EVENT SHALL MOTOROLA BE LIABLE FOR DAMAGES IN EXCESS OF THE PURCHASE PRICE OF THE PRODUCT, FOR ANY LOSS OF USE, LOSS OF TIME, INCONVENIENCE, COMMERCIAL LOSS, LOST PROFITS OR SAVINGS OR OTHER INCIDENTAL, SPECIAL OR CONSEQUENTIAL DAMAGES ARISING OUT OF THE USE OR INABILITY TO USE SUCH PRODUCT, TO THE FULL EXTENT SUCH MAY BE DISCLAIMED BY LAW.

III. STATE LAW RIGHTS:

SOME STATES DO NOT ALLOW THE EXCLUSION OR LIMITATION OF INCIDENTAL OR CONSEQUENTIAL DAMAGES OR LIMITATION ON HOW LONG AN IMPLIED WARRANTY LASTS, SO THE ABOVE LIMITATION OR EXCLUSIONS MAY NOT APPLY.

This warranty gives specific legal rights, and there may be other rights which may vary from state to state.

IV. HOW TO GET WARRANTY SERVICE:

You must provide proof of purchase (bearing the date of purchase and Product item serial number) in order to receive warranty service and, also, deliver or send the Product item, transportation and insurance prepaid, to an authorized warranty service location. Warranty service will be provided by Motorola through one of its authorized warranty service locations. If you first contact the company which sold you the Product, it can facilitate your obtaining warranty service. You can also call Motorola at 1-888-567-7347 US/Canada.

V. WHAT THIS WARRANTY DOES NOT COVER:

- A) Defects or damage resulting from use of the Product in other than its normal and customary manner.
- B) Defects or damage from misuse, accident, water, or neglect.
- C) Defects or damage from improper testing, operation, maintenance, installation, alteration, modification, or adjustment.
- D) Breakage or damage to antennas unless caused directly by defects in material workmanship.
- E) A Product subjected to unauthorized Product modifications, disassemblies or repairs (including, without limitation, the addition to the Product of non-Motorola supplied equipment) which adversely affect performance of the Product or interfere with Motorola's normal warranty inspection and testing of the Product to verify any warranty claim.
- F) Product which has had the serial number removed or made illegible.
- G) Rechargeable batteries if:
 - any of the seals on the battery enclosure of cells are broken or show evidence of tampering.
 - the damage or defect is caused by charging or using the battery in equipment or service other than the Product for which it is specified.
- H) Freight costs to the repair depot.
- I) A Product which, due to illegal or unauthorized alteration of the software/firmware in the Product, does not function in accordance with MOTOROLA's published specifications or the FCC type acceptance labeling in effect for the Product at the time the Product was initially distributed from MOTOROLA.

- J) Scratches or other cosmetic damage to Product surfaces that does not affect the operation of the Product.
- K) Normal and customary wear and tear.

VI. PATENT AND SOFTWARE PROVISIONS:

MOTOROLA will defend, at its own expense, any suit brought against the end user purchaser to the extent that it is based on a claim that the Product or parts infringe a United States patent, and MOTOROLA will pay those costs and damages finally awarded against the end user purchaser in any such suit which are attributable to any such claim, but such defense and payments are conditioned on the following:

- A) that MOTOROLA will be notified promptly in writing by such purchaser of any notice of such claim;
- B) that MOTOROLA will have sole control of the defense of such suit and all negotiations for its settlement or compromise; and
- C) should the Product or parts become, or in MOTOROLA's opinion be likely to become, the subject of a claim of infringement of a United States patent, that such purchaser will permit MOTOROLA, at its option and expense, either to procure for such purchaser the right to continue using the Product or parts or to replace or modify the same so that it becomes non-infringing or to grant such purchaser a credit for the Product or parts as depreciated and accept its return. The depreciation will be an equal amount per year over the lifetime of the Product or parts as established by MOTOROLA.

MOTOROLA will have no liability with respect to any claim of patent infringement which is based upon the combination of the Product or parts furnished hereunder with software, apparatus or devices not furnished by MOTOROLA, nor will MOTOROLA have any liability for the use of ancillary equipment or software not furnished by MOTOROLA which is attached to or used in connection with the

Product. The foregoing states the entire liability of MOTOROLA with respect to infringement of patents by the Product or any parts thereof.

Laws in the United States and other countries preserve for MOTOROLA certain exclusive rights for copyrighted MOTOROLA software such as the exclusive rights to reproduce in copies and distribute copies of such Motorola software. MOTOROLA software may be used in only the Product in which the software was originally embodied and such software in such Product may not be replaced, copied, distributed, modified in any way, or used to produce any derivative thereof. No other use including, without limitation, alteration, modification, reproduction, distribution, or reverse engineering of such MOTOROLA software or exercise of rights in such MOTOROLA software is permitted. No license is granted by implication, estoppel or otherwise under MOTOROLA patent rights or copyrights.

VII. GOVERNING LAW:

This Warranty is governed by the laws of the State of Illinois, USA.

Service

Proper repair and maintenance procedures will assure efficient operation and long life for this product. A Motorola maintenance agreement will provide expert service to keep this and all other communication equipment in perfect operating condition. A nationwide service organization is provided by Motorola to support maintenance services. Through its maintenance and installation program, Motorola makes available the finest service to those desiring reliable, continuous communications on a contract basis. For a contract service agreement, please contact your nearest Motorola service or sales representative, or an authorized Motorola dealer.

Express Service Plus (ESP) is an optional extended service coverage plan, which provides for the repair of this product for a period of three years from the date of shipment from the factory, or the date of delivery if purchased from an authorized Motorola two-way radio dealer. For more information about ESP, contact the Motorola Radio Support Center, 2204 Galvin Drive, Elgin, IL 60123, 1-800-227-6772.

Notes

Index

Symbols

- 700/800 MHz frequencies2
- 900 MHz frequencies2

A

- alarm
 - sending emergency28
- alarms
 - call received while on42
 - non-rearmable42
 - optional external
 - purpose41
 - turning on and off41
 - rearmable42
 - selected, turning on and off41
- alert tones
 - general10
 - secure-equipped radios13
- analog
 - trunking system considerations 75
- analog squelch options27
- annunciator
 - call received8
 - carrier squelch8
 - direct9
 - purpose8
 - scan8
 - secure operation8
- answering
 - call alert page (Enhanced Private Call)40
 - call alert page (PTT button)39
 - private conversation call65
 - telephone call34
- autoscan31

B

- basic radio operation15
- box, hang up (HUB)60

C

- call

- send a status24
- sending emergency29
- talkgroup46
- Call Alert60
- call alert page
 - answering using Enhanced Private Call40
 - answering using PTT button ...39
 - sending38
- call list
 - directly accessing last ID
 - number37, 50, 63
 - scrolling to last ID
 - number36, 49, 62
- call received status annunciator ...8
- calling last ID number47, 60
- calls, status44
- carrier squelch status
 - annunciator8
- channel
 - definition17
 - selecting17
- channels, conventional7
- conventional
 - channel7
- conventional mode
 - receiving18
 - scan31
 - squelch options27
 - transmitting19
- conventional operation
 - encryption key selection76

D

- deleting nuisance modes32
- digital carrier-operated squelch ..27
- digital squelch options27
- digital trunking system
 - considerations75
- direct entry of last ID
 - number35, 48, 61
- direct status annunciator9
- display

- description6
- dynamic regrouping
 - mode (menu) selection67
 - purpose67
 - select-disabled67
 - select-enabled67

E

- editing
 - selecting characters59
- electronic (menu) mode selection 67
- emergencies, special
 - considerations30
- emergency alarm
 - sending28
- emergency call, sending29
- encryption key selection76
- Enhanced Private Conversation ..60
- external alarms
 - optional (horns and lights)41
 - turning on and off41

F

- failsoft
 - operation70
 - tone70
- features
 - common radio23
 - trunking53
- frequency range
 - VHF2
- frequency ranges
 - 700/800 MHz2
 - 900 MHz2
 - UHF2

G

- glossary87

H

- hang up box (HUB)60
- HOME key7

- HUB (hang up box)60

I

- identifying radio by PTT-ID33
- indicator
 - LED10
 - out-of-range71
- initiate
 - trunked announcement72

K

- key
 - HOME7
- keypad
 - description3
 - manual entry14
 - selecting characters59

L

- last47
- last ID number
 - calling47, 60
 - direct entry35, 48, 61
 - directly accessing37, 50, 63
 - paging60
 - scrolling call list36, 49, 62
- LED indicator10
- loss indication, secure operation 75

M

- manual keypad entry14
- mode
 - conventional
 - receiving18
 - transmitting19
 - definition17
 - selection17
 - slaving7
 - trunked7
- modes
 - deleting nuisance32
 - monitoring conventional16

-
- monitoring conventional modes ..16
 - N**
 - non-rearmable alarms42
 - non-ruthless preemption72
 - normal squelch27
 - nuisance modes, deleting32
 - O**
 - operation
 - basic radio15
 - repeater/direct43
 - smart PTT45
 - SmartZone68
 - telephone34
 - operator-selectable scan31
 - options
 - analog squelch27
 - conventional squelch27
 - digital squelch27
 - out-of-range indication71
 - override, quick-key45
 - P**
 - paging last ID number60
 - patent disclosure iii
 - power, selecting transmit26
 - preemption
 - non-ruthless72
 - ruthless72
 - private conversation call
 - answering65
 - sending51
 - sending call alert page38
 - programming
 - name
 - call list58
 - page list58
 - phone list58
 - number
 - call list55
 - page list55
 - phone list55
 - PTT (Push-to-Talk)
 - smart45
 - PTT-ID
 - identifying a radio33
 - Push-to-Talk Identification (PTT-ID)33
 - Q**
 - quick-key override45
 - R**
 - radio
 - basic operation15
 - scanning mode lists31
 - radio features, common23
 - rearmable alarms42
 - receiving
 - on conventional modes18
 - on trunked systems19
 - regrouping
 - dynamic67
 - select-disabled radios67
 - select-enabled radios67
 - repeater/direct operation43
 - ruthless preemption72
 - S**
 - scan status annunciator8
 - scanning
 - autoscan31
 - conventional scan31
 - mode lists31
 - operator-selectable31
 - talkgroup scan31
 - turning on and off32
 - scroll keys, description6
 - scrolling to last ID
 - number36, 49, 62
 - secure operation status
 - annunciator8
 - select-disable regrouping67

Index

- selected alarms, turning on
 - and off41
- select-enable regrouping67
- selecting
 - characters59
 - encryption key76
 - talkgroups46
 - transmit power26
 - zone and mode (channel)17
- selection
 - channel17
 - mode17
 - zone17
- selective squelch27
- send
 - status call44
- sending
 - call alert page38
 - emergency alarm28
 - emergency call29
 - private conversation call51
- service95
- site
 - lock68
 - trunking70
- site view search69
- slaved programming7
- slaving, mode7
- smart PTT45
- SmartZone system
 - operation68
 - site lock68
 - site trunking70
 - site view search69
- softkeys, description6
- squelch
 - digital carrier-operated27
 - normal27
 - options
 - analog27
 - digital27
 - selective27
- status
 - annunciators8
 - call24
 - status calls
 - description44
 - sending44
- T**
- talkgroup
 - calls46
 - scan31
 - selection46
- telephone call
 - answering34
- telephone operation,
 - description34
- time-out timer21, 33
- timer, time-out21
- tones
 - alert (general)10
 - alert (secure-equipped radios) 13
 - failsoft70
- transmit power, selecting26
- transmitting
 - on conventional modes19
 - on trunked systems20
- troubleshooting77
- trunked
 - announcement
 - capability72
 - initiate72
 - mode7
 - system considerations75
- trunking
 - failsoft70
 - features53
 - programming page, call, and
 - phone list names58
 - programming page, call, and
 - phone list numbers55
 - SmartZone operation68
 - status calls24, 44
 - systems
 - receiving19

transmitting20

U

UHF frequencies2

units

troubleshooting77

V

VHF frequency2

maritime radio use83

W

warranty91

Z

zone

definition17

selection17

Notes

Control Head Foldout Page

