



MOTOROLA

APX O5 Control Head Mobile Radio User Guide



ASTRO® APX™ O5 Control Head Mobile Radio Quick Reference Card

Product Safety and RF Exposure Compliance



Before using this product, read the operating instructions for safe usage contained in the Product Safety and RF Exposure booklet enclosed with your radio.

ATTENTION!

This radio is restricted to occupational use only to satisfy FCC RF energy exposure requirements. Before using this product, read the RF energy awareness information and operating instructions in the Product Safety and RF Exposure booklet enclosed with your radio (Motorola Publication part number 6881095C99) to ensure compliance with RF energy exposure limits.

Radio Controls

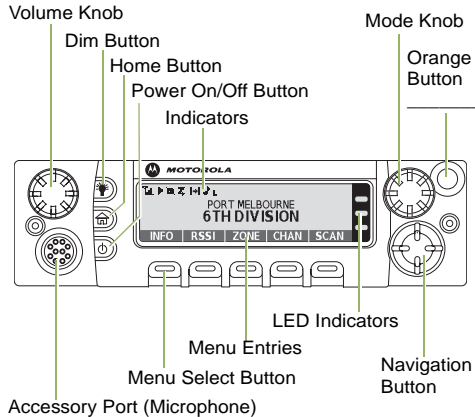

Radio On/Off

Press the Power On/Off button to toggle the power on or off.

Adjusting Volume

Turn the Volume Knob clockwise to increase volume or counterclockwise to decrease the volume.

Selecting a Zone

- 1 **▶** or **◀** to **ZONE**.
- 2 **▶** or **◀** button until the desired zone is displayed.
- 3 Press **⬆** or the **PTT** button to confirm the selected zone number.
- 4 Press the **PTT** button to begin transmitting on the displayed zone channel.

Selecting a Channel

- 1 Press and hold **▶** to scroll to **CHAN** and press the **Menu Select** button directly below **CHAN**. The display shows the current zone and channel.
- 2 Rotate the **Mode** knob to the desired channel.
- 3 Press **⬆** or the **PTT** button to confirm the channel.
- 4 Press the **PTT** button to transmit on the displayed zone channel.

Receiving and Transmitting

- 1 Take the microphone off hook.
- 2 Select zone/channel.
- 3 Listen for a transmission.
OR
Turn the **Volume** Knob.
OR
▶ or **◀** to **MON** then press the **Menu Select** button directly below **MON** and listen for activity.
- 4 Adjust volume, if necessary.
- 5 Press the **PTT** button to transmit; release to receive.

Sending an Emergency Alarm

- 1 Press the **Emergency** button. A tone sounds and the display alternates **EMERGENCY** and the home display.
- 2 A dispatcher acknowledgment **ACK RECEIVED** display follows.
AND, Trunking Only:
A high-pitched tone indicates that the alarm has been received by the trunked system's central controller.
- 3 Press and hold the emergency button or the **PTT** button to return to normal operation.

*To exit emergency at any time, press and hold the **Emergency** button.*



PMLN5592B



Sending an Emergency Call (Trunking Only)

- 1 Press Emergency button.
- 2 A tone sounds and the display alternates **EMERGENCY** and the home display.
OR
A talk prohibited tone sounds when the selected channel does not support emergency.
- 3 Press and hold the **PTT** button. Speak clearly into the microphone.
- 4 Release the **PTT** to end the transmission.





*To exit emergency at any time, press and hold the **Emergency** button.*







Sending a Silent Emergency Alarm







- 1 Press the preprogrammed **Emergency** button to activate the silent alarm feature.
- 2 The display does not change; the LED does not light up, and there is no tone.

*If silent emergency alarm is used with emergency call, pressing the **PTT** button exits the silent mode and initiates the emergency call.*

Display Status Icons

	Receiving a call or data.
	Transmitting a call or data.
	Received an Individual Call.
	The more stripes, the stronger the signal strength for the current site (trunking only).

	Direct radio-to-radio communication or communication through a repeater. On = Direct Off = Repeater
	This channel is being monitored.
	Voice muting the affiliated trunking talkgroup or selected conventional channel. On = Enabled Off = Disabled
	L = Radio is set at Low power. H = Radio is set at High power.
	Scanning a scan list.
	Blinking dot = Detects activity on the Priority-One Channel during scan. Steady dot = Detects activity on the Priority-Two Channel during scan.
	Radio is in the view or program mode. On steady = View mode. Blinking = Program mode.

	The vote scan feature is enabled.
	On = Secure operation. Off = Clear operation. Blinking = Receiving an encrypted voice call.
	On = AES Secure operation. Off = Clear operation. Blinking = Receiving an encrypted voice call.
	On = Location feature enabled, and location signal available. Off = Location feature disabled. Blinking = Location feature enabled, but location signal unavailable.
	On = User is currently associated with the radio. Off = User is currently not associated with the radio. Blinking = Device registration or user registration with the server failed due to an invalid username or pin.
	Data activity is present.

Menu Navigation

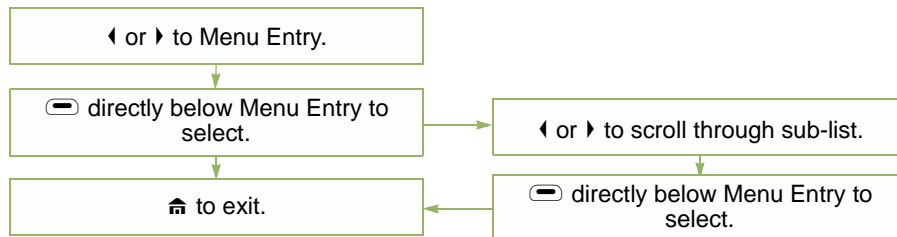

Declaration of Conformity

This declaration is applicable to your radio **only** if your radio is labeled with the FCC logo shown below.

DECLARATION OF CONFORMITY

Per FCC CFR 47 Part 2 Section 2.1077(a)



Responsible Party
Name: Motorola, Inc.

Address: Motorola, Inc. 1301 E. Algonquin Rd. Schaumburg, IL60196-1078, U.S.A.
Phone Number: 1-800-927-2744

Hereby declares that the product:

Model Name: **APX 7500 / APX 6500**

conforms to the following regulations:

FCC Part 15, subpart B, section 15.107(a), 15.107(d) and section 15.109(a)

Class B Digital Device

As a personal computer peripheral, this device complies with Part 15 of the FCC Rules. Operation is subject to the following two conditions:

1. This device may not cause harmful interference, and
2. This device must accept any interference received, including interference that may cause undesired operation.

Note: This equipment has been tested and found to comply with the limits for a Class B digital device, pursuant to part 15 of the FCC Rules. These limits are designed to provide reasonable protection against harmful interference in a residential installation. This equipment generates, uses and can radiate radio frequency energy and, if not installed and used in accordance with the instructions, may cause harmful interference to radio communications. However, there is no guarantee that interference will not occur in a particular installation.

If this equipment does cause harmful interference to radio or television reception, which can be determined by turning the equipment off and on, the user is encouraged to try to correct the interference by one or more of the following measures:

- Reorient or relocate the receiving antenna.
- Increase the separation between the equipment and receiver.
- Connect the equipment into an outlet on a circuit different from that to which the receiver is connected.
- Consult the dealer or an experienced radio/TV technician for help.

Contents

This User Guide contains all the information you need to use the APX™ Mobile Radios.

Declaration of Conformityi

Important Safety Informationix
 Product Safety and RF Exposure Compliance ix

Software Versionix

Computer Software Copyrights x

Documentation Copyrights x

Disclaimer x

Getting Started 1

How to Use This User Guide 1

Notations Used in This Manual 1

Additional Performance Enhancement2

Dynamic System Resilience (DSR)2

CrossTalk Prevention2

Encrypted Integrated Data (EID)2

SecureNet 2

What Your Dealer/System Administrator
 Can Tell You 3

Preparing Your Radio for Use3

Turning On the Radio 4

Validating Compatibility During Power Up 4

Adjusting the Volume 5

Identifying Radio Controls5

Radio Parts and Controls 6

O5 Control Head and Microphone 6

Programmable Features 7

Assignable Radio Functions 7

Assignable Settings or Utility Functions 9

Accessing the Preprogrammed Functions 9

Using the Menu Select Buttons 9

Using the Advance Programmable Buttons 10

Using the Navigation Buttons 10

Home Button 10

Data Feature Button 10

4-Way Navigation Button 11

Volume Knob 11

Mode Knob 11

Using the Keypad 12



Keypad Characters – Uppercase Mode	12
Keypad Characters – Lowercase Mode	13
Keypad Characters – Numeric Mode	14
Keypad Characters – Hexadecimal Mode	15
Push-To-Talk (PTT) Button	16

Identifying Status Indicators16

Status Icons	17
Text Messaging Service (TMS) Icons	19
Status Icons	19
TMS Menu Options	20
LED Indicator	21
Intelligent Lighting Indicators	22
Alert Tones	23

General Radio Operation26

Selecting a Zone	26
Selecting a Radio Channel	27
Receiving and Responding to a Radio Call	27
Receiving and Responding to a Talkgroup Call	28
Receiving and Responding to a Private Call (Trunking Only)	28
Receiving and Responding to a Telephone Call	29
Making a Radio Call	30

Making a Talkgroup Call	30
Making a Private Call (Trunking Only)	31
Making a Telephone Call	32
Repeater or Direct Operation	33
Monitoring Features	33
Monitoring a Channel	33
Conventional Mode Operation	34

Advanced Features 35

Advanced Call Features	35
Calling a Phone Not in the List	35
Receiving and Making a Selective Call (Conventional Only)	36
Receiving a Selective Call	36
Making a Selective Call	36
Using the Talkgroup Call Feature (Conventional Operation Only)	37
Selecting a Talkgroup	37
Sending a Status Call	38
Using the Dynamic Regrouping Feature (Trunking Only)	38
Requesting a Reprogram	39
Classifying Regrouped Radios	39
Multiple Control Head Features	40
Multiple Control Head Features	40
Setting the Initial Control Head's ID	40

All Active Mode	41	Changing Priorities Status While Scan is On	53
Intercom Feature in All Active Mode	41	Restoring Priorities in a Scan List	53
One Active Mode	41	Hang Up (HUB)	53
Contacts	43	Call Alert Paging	54
Making a Private Call from Contacts	43	Receiving a Call Alert Page	54
Adding a New Contact Entry	45	Sending a Call Alert Page	55
Deleting a Contact Entry	46	In-Call User Alert	56
Adding a Contact to a Call List or Phone List	46	Emergency Operation	56
Editing a Contact in a Call List or a Phone List	47	Sending an Emergency Alarm	57
Editing an Entry Alias	47	Sending an Emergency Call (Trunking Only)	57
Editing as Entry ID	47	Sending an Emergency Alarm with	
Editing a Call Type	48	Emergency Call	57
Scan Lists	49	Sending a Silent Emergency Alarm	58
Viewing a Scan List	49	Special Considerations for Emergencies	59
Editing the Scan List	49	Automatic Registration Service (ARS)	60
Changing the Scan List Status	50	Selecting or Changing ARS Mode	60
Viewing and Changing the Priority Status	50	Accessing the User Login Feature	61
Scan	51	Logging In as a User	61
Turning Scan On or Off	51	Logging Out	62
Turning Scan On While Disregarding the		Text Messaging Service (TMS)	63
Squelch Code (Conventional Channels Only)	51	Accessing TMS Feature	63
Transmitting While the Scan is On	51	Composing and Sending a New Text Message ...	64
Radio Programmed for Talkback Scan	51	Sending a Quick Text Message	65
Radio Programmed for Non-Talkback Scan	52	Using the Priority Status and Request Reply	
Deleting a Nuisance Channel	52	Features	67
Restoring a Nuisance Channel	52	Appending or Removing a Priority Status to a	

Text Message	67	MDC Over-the-Air Rekeying (OTAR) Page	77
Appending or Removing a Request Reply to a Text Message	67	Hear Clear	78
Appending a Priority Status and a Reply Request to a Text Message	67	The Global Positioning System (GPS)	78
Removing a Priority Status and a Reply Request from a Text Message	68	Understanding the GPS Feature	78
Managing Text Messages	68	Enhancing GPS Performance	79
Receiving a Text Message	68	The Outdoor Location Feature (Using GPS)	79
Viewing a Text Message from the Inbox	69	Accessing the Outdoor Location Feature	80
Replying to a Received Text Message	70	Saving a Waypoint	81
Accessing the Drafts Folder	71	Viewing a Saved Waypoint	82
Managing Sent Text Messages	71	Editing the Alias of a Waypoint	83
Viewing a Sent Text Message	71	Editing the Coordinates of a Waypoint	83
Sending a Sent Text Message	72	Deleting a Single Saved Waypoint	84
Deleting Text Messages	73	Deleting All Saved Waypoints	85
Secure Operations	73	Measuring the Distance and Bearing from a Saved Waypoint	85
Managing Encryption	73	Using the Location Feature While in Emergency Mode	86
Loading a Single Encryption Key	73	Trunking System Controls	86
Loading the Group Encryption Keys	74	Using the Failsoft System	86
Using the Multikey Feature	74	Going Out-of-Range	87
Selecting an Encryption Key (Conventional Only)	75	SmartZone®	87
Enabling Secure Transmission	75	Using Site Trunking Feature	87
Accessing the Secure Feature	75	Locking and Unlocking a Site	88
Selecting a Keypad	76	Viewing and Changing a Site	88
Erasing the Selected Encryption Keys	76	Viewing the Current Site	88
Requesting an Over-the-Air Rekey	77	Changing the Current Site	89
		Trunked Announcement	89

Initiating an Announcement	90	Accessing Radio Information	98
Ignition Switch Options	90	Viewing IP Information	99
Blank	90	Viewing Control Assignments	99
Tx Inhibit	90	Using Optional External Alarms	
PTT Tx Inhibit	90	(Horn and Lights)	100
Required	91	Using Non-Permanent Horn and Lights	100
Soft Power Off	91	Using Permanent Horn and Lights	100
Ignition Only Power Up	91	Changing the Selected Alarms	101
Emergency Power Up	91	Receiving a Call While Alarms are Turned On ..	101
Auto Power Off Timer	92	Turning Off Non-Rearmable External Alarms ...	101
Utilities	92	Turning Off Rearmable External Alarms	102
Viewing Recent Calls List	92	Using the Voice Announcement	102
Selecting the Power Level	93	Helpful Tips	104
Selecting a Radio Profile	93	Accessories	105
Controlling the Display Backlight	94	Appendix: Maritime Radio Use in the VHF	
Turning Keypad Tones On or Off	94	 Frequency Range	106
Turning Voice Mute On or Off	95	Special Channel Assignments	106
Using the Time-Out Timer	95	Emergency Channel	106
Using the Conventional Squelch		Non-Commercial Call Channel	106
Operation Features	96	Operating Frequency Requirements	107
Analog Options	96		
Digital Options	96		
Using the PL Defeat Feature	97		
Using the Digital PTT ID Feature	97		
Using the Smart PTT Feature (Conventional Only)	97		
Accessing General Radio Information	98		

Glossary109

Commercial Warranty and Service113

Important Safety Information

Product Safety and RF Exposure Compliance



Caution

Before using this product, read the operating instructions for safe usage contained in the Product Safety and RF Exposure booklet enclosed with your radio.

ATTENTION!

This radio is restricted to occupational use only to satisfy FCC RF energy exposure requirements.

Before using this product, read the RF energy awareness information and operating instructions in the Product Safety and RF Exposure booklet enclosed with your radio (Motorola Publication part number 6881095C99) to ensure compliance with RF energy exposure limits.

For a list of Motorola-approved antennas and other accessories, visit the following website:

<http://www.motorola.com/governmentandenterprise>

Software Version

All the features described in the following sections are supported by the radio's software version **R05.00.00** or later.

Accessing Radio Information on page 98 to determine your radio's software version.

Check with your dealer or system administrator for more details of all the features supported.

Computer Software Copyrights

The Motorola products described in this manual may include copyrighted Motorola computer programs stored in semiconductor memories or other media. Laws in the United States and other countries preserve for Motorola certain exclusive rights for copyrighted computer programs including, but not limited to, the exclusive right to copy or reproduce in any form the copyrighted computer program. Accordingly, any copyrighted Motorola computer programs contained in the Motorola products described in this manual may not be copied, reproduced, modified, reverse-engineered, or distributed in any manner without the express written permission of Motorola. Furthermore, the purchase of Motorola products shall not be deemed to grant either directly or by implication, estoppel, or otherwise, any license under the copyrights, patents or patent applications of Motorola, except for the normal non-exclusive license to use that arises by operation of law in the sale of a product.

Documentation Copyrights

No duplication or distribution of this document or any portion thereof shall take place without the express written permission of Motorola. No part of this manual may be reproduced, distributed, or transmitted in any form or by any means, electronic or mechanical, for any purpose without the express written permission of Motorola.

Disclaimer

The information in this document is carefully examined, and is believed to be entirely reliable. However, no responsibility is assumed for inaccuracies. Furthermore, Motorola reserves the right to make changes to any products herein to improve readability, function, or design. Motorola does not assume any liability arising out of the applications or use of any product or circuit described herein; nor does it cover any license under its patent rights, nor the rights of others.

Getting Started

Take a moment to review the following:

How to Use This User Guide	page 1
Notations Used in This Manual	page 1
Additional Performance Enhancement	page 2
What Your Dealer/System Administrator Can Tell You	page 3

How to Use This User Guide

This User Guide covers the basic operation of the APX™ Mobile Radios.

However, your dealer or system administrator may have customized your radio for your specific needs. Check with your dealer or system administrator for more information.

Notations Used in This Manual

Throughout the text in this publication, you will notice the use of **WARNING**, **Caution**, and **Note**. These notations are used to emphasize that safety hazards exist, and the care that must be taken or observed. The following special notations identify certain items:





An operational procedure, practice, or condition, etc., which may result in injury or death if not carefully observed.



An operational procedure, practice, or condition, etc., which may result in damage to the equipment if not carefully observed.

Note:

An operational procedure, practice, or condition, etc., which is essential to emphasize.

Example	Description
Home button or 	Buttons and keys are shown in bold print or as an icon.
PHONE	Menu entries are shown similar to the way they appear on the radio's display.
	This means "Press the right side of the 4-way Navigation button."

■ Additional Performance Enhancement

The following are some of the latest creations designed to enhance the security, quality and efficiency of APX mobile radios.

Dynamic System Resilience (DSR)

DSR ensures the radio system is seamlessly switched to a backup master site dynamically in case of system failure. DSR also provides additional indication e.g. failure detection, fault recovery, and redundancy within the system to address the user in need. Mechanisms related to the Integrated Voice and Data (IV & D) or data centric are all supported by DSR.

CrossTalk Prevention

This feature prevents crosstalk scenario from happening, especially when a wideband antenna is used. This feature allows the adjustment of the Trident Transmitting SSI clock rate in the radio to be varied from the Receiving Frequency. This subsequently reduced the possibilities of radio frequency interfering spurs and prevents the issues of crosstalk.

Encrypted Integrated Data (EID)

EID provides security encryption and authentication of IV & D data bearer service communication between the radio and the Customer Enterprise Network.

SecureNet

SecureNet allows user to perform secured communications on an Analog or Motorola Data Communication (MDC) channel. The MDC OTAR feature will allow users to perform OTAR activities on an MDC channel.

■ What Your Dealer/System Administrator Can Tell You

You can consult your dealer or system administrator about the following:

- Is your radio preprogrammed with any preset conventional channels?
- Which buttons have been programmed to access other features?
- What optional accessories may suit your needs?

Preparing Your Radio for Use

Turning On the Radio page 4
 Validating Compatibility During Power Up page 4
 Adjusting the Volume page 5

■ Turning On the Radio

Press the **Power On/Off Button** briefly to power on the radio.

After a short time, the red, yellow and green LEDs light up. The display then shows Zone and channel text, and menu items display on the screen.

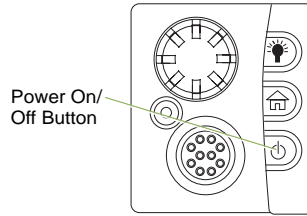

The backlight will turn on to the last selected dim level.

Note: Pressing the **Power On/Off Button** before the LED lights up will be ignored.

If **FAIL ###/###** appears in the display, the radio will not function until the condition has been corrected.

If **ERROR ###/###** appears, some non-critical data has been changed. If either of these displays appear, if the display goes blank, or if the unit appears to be locked up, see **Helpful Tips** on page 104 for more information.

If **CH MISMATCH** appears, means that either the Control Head has been connected to an incompatible transceiver, or vice versa.

If your radio does not power up, contact your dealer.

To turn off the radio, press the **Power On/Off Button** after the LEDs light up.

📄 Validating Compatibility During Power Up

The radio validates and updates the software and hardware of your control head(s) during power up. Follow the procedure below when your radio runs this task.

Procedure:

- 1 The display shows **MAINTENANCE MODE REMOTE DEVICE**; promptly followed by other maintenance statuses.
- 2 The display shows **UPDATE DONE PLEASE RESET** upon completion.
OR
The display shows **UPDATE FAILED PLEASE RESET** when it fails to update.
- 3 Press the **Power On/Off Button** to reset. The radio runs the usual power up operation if the software updates are complete.
OR
The radio runs the Maintenance Mode if the updates are not complete and repeat step 1.

Note: If **SW INCOMPLETE** appears, use Flashport Recovery Tool to update the control heads before you power on the radio again.

■ Adjusting the Volume

To increase the volume, rotate the **Volume Knob** clockwise.

To decrease the volume, rotate the **Volume Knob** counterclockwise.

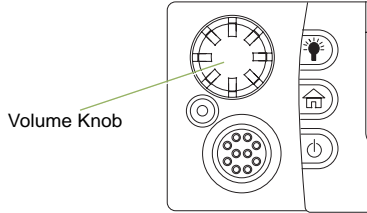

Identifying Radio Controls

Take a moment to review the following:

- Radio Parts and Controls page 6
 - O5 Control Head and Microphone page 6
- Programmable Features page 7
 - Assignable Radio Functions page 7
 - Assignable Settings or Utility Functions page 9
- Accessing the Preprogrammed Functions page 9
 - Using the Menu Select Buttons page 9
 - Using the Advance Programmable Buttons page 10
 - Using the Navigation Buttons page 10
- Using the Keypad page 12
 - Keypad Characters – Uppercase Mode page 12
 - Keypad Characters – Lowercase Mode page 13
 - Keypad Characters – Numeric Mode page 14
 - Keypad Characters – Hexadecimal Mode page 15
- Push-To-Talk (PTT) Button page 16

Radio Parts and Controls

O5 Control Head and Microphone

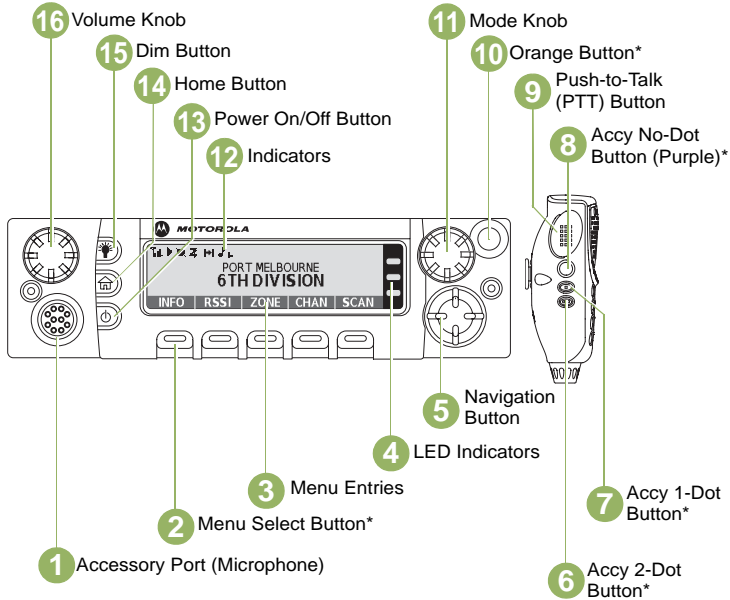

*These controls/buttons are programmable.

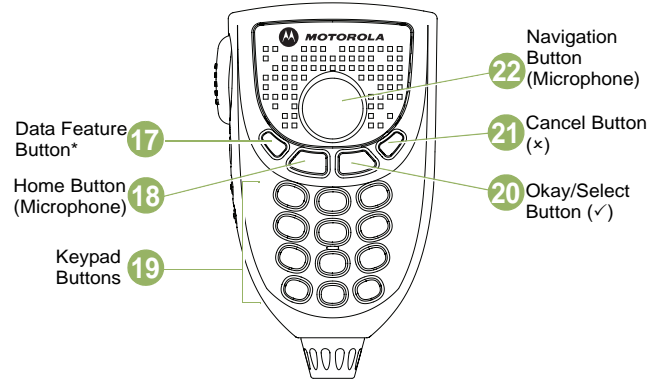

*This button is programmable.

Note: The microphone is not part of a radio. It is an optional accessory.

Identifying Radio Controls

■ Programmable Features

Any reference in this manual to a control that is “preprogrammed” means that the control must be programmed by a dealer or a qualified radio technician using the radio’s programming software, in order to assign a feature to that control.

The programmable buttons can be programmed as shortcuts to radio functions or preset channels/groups depending on the duration of a button press:

- **Press** – Pressing and releasing rapidly.
- **Long press** – Pressing and holding for the programmed duration (between 0.25 seconds and 3.75 seconds).
- **Hold down** – Keeping the button pressed.

Assignable Radio Functions

Call Alert – Allows the radio to function like a pager, or to verify if a radio is active on the system.

Call Response – Allows you to answer a private call or phone call.

Channel – Selects a channel.

Contacts – Selects the Contacts menu.

Dynamic Priority (Conventional Only) – Allows any channel in a scan list (except for the Priority-One channel) to temporarily replace the Priority-Two channel.

Emergency – Depending on the programming, initiates or cancels an emergency alarm or call.

Information – Displays the basic radio information, IP-related information, and buttons or switches control mapping.

Intercom – Enables users of multiple control heads to talk to each other via the control heads in a multi-control head setup.

Internet Protocol Address – Displays the Internet Protocol (IP) address, device name, and status of the radio.

Location – Determines the current location (latitude, longitude, time and date), and also the distance and bearing to another location. Or, turns the GPS functionality on or off for all locations.

Message – Enters the current message list.

Monitor (Conventional Only) – Monitors a selected channel for all radio traffic until function is disabled.

Multiple Private Line (Conventional Only) – Selects the Multiple Private Line lists.

Nuisance Delete – Temporarily removes an unwanted channel, except for priority channels or the designated transmit channel, from the scan list.

One Touch 1 – 4 – Launches a specific feature with one single button-press. You can setup as much as four separately programmed buttons for four different features.

Phone – Allows you to make and receive calls similar to standard phone calls.

Private Call (Trunking Only) – Allows a call from an individual radio to another individual radio.

Radio Profiles – Allows for easy access to a set of preprogrammed visual and audio settings of the radio.

Recent Calls – Allows for easy access to the list of calls recently received or made.

Rekey Request – Notifies the dispatcher that you require a new encryption key.

Repeater Access Button (RAB) (Conventional Only) – Allows to manually send a repeater access codeword.

Reprogram Request (Trunking Only) – Notifies the dispatcher that you want a new dynamic regrouping assignment.

Request-To-Talk (Conventional Only) – Notifies the dispatcher that you want to send a voice call.

Scan – Toggles scan on or off.

Secure/Clear – Toggles secure transmission on or off.

Selective Call (Conventional Only) – Calls an assigned radio.

Site Display (Trunking Only) – Views the current site or enable a site search for SmartZone operation.

Site Lock/Unlock (Trunking Only) – Toggles between lock and unlock mode when using the SmartZone option.

Status – Sends data calls to the dispatcher about a predefined status.

Talkaround/Direct (Conventional Only) – Toggles between using a repeater and communicating directly with another radio.

Talkgroup (Conventional Only) – Allows a call from an individual radio to a group of radios.

Text Messaging Service (TMS) – Selects the text messaging menu.

TMS Quick Text – Selects a predefined message.

User – Automatically registers with the server.

Zone Down – Toggles downward through the zones in the radio.

Zone Select – Allows selection from a list of zones.

Zone Up – Toggles upward through the zones in the radio.

Assignable Settings or Utility Functions

Dim – Changes the display brightness.

Front/Rear – Switches one of two control heads to be active at one time.

Horns/Lights – Toggles horns and lights feature on or off.

Low Power – Toggles transmit power level between high and low.

Voice Announcement – Audibly indicates the current feature mode, Zone or Channel the user has just assigned.

Voice Mute – Toggles voice mute on or off for the channels which have enabled In-Call User Alert. When Voice Mute is active, the radio remains muted to all conventional dispatch calls and affiliated trunking group calls.

Accessing the Preprogrammed Functions

You can access various radio functions through one of the following ways:

- A short or long press of the relevant programmable buttons.

OR

- Use the **Menu Select Button** ().

Using the Menu Select Buttons

The **Menu Select Buttons** allow to access the menu entries of features.

Note: Check with your dealer or system administrator for the list of features activated in your radio.

Your radio may be preprogrammed differently from the following example, but the steps for selecting a channel may appear as shown below:

- Press the **Menu Select** button () directly below **CHAN**.

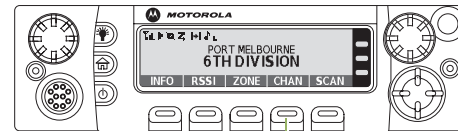

Menu Select Button

Using the Advance Programmable Buttons

This feature is to help you to shorten the process of applying certain common features.

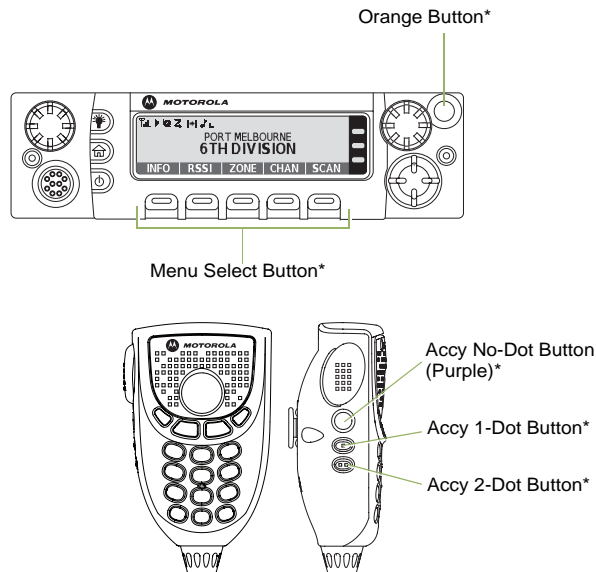



* These programmable buttons support the **One Touch Button** feature.

(Quick Access) One Touch Button – Enters a menu with a short press on the preprogrammed One Touch button. Features assigned to these buttons are Call, Call Alert, Phone, Repeater Access, MDC RTT Button Access, Status and Message.

Using the Navigation Buttons

Home Button

The  button returns you to the home (default) display. In most cases, this is the current mode.

For selected radio features, the  button is also used to save user-edited radio settings or information before returning you to the Home screen.

Note: Some features do not require you to press  to go to the Home screen. Refer to the individual feature sections in this manual for further details on saving user-edited radio settings or information.

The  button also can revert to home channel. Check with your dealer or system administrator for more information.

Data Feature Button

Use this button to access data-related features, such as the Text Messaging Service (TMS) feature screen.

 **4-Way Navigation Button**

Use this button to scroll up, down, left or right.

Press and release one of the button to scroll from one entry to the next one. Press and hold one of the button to have the radio toggles through the list automatically (release the button to stop).

 **Volume Knob**

Use this **Volume Knob** to adjust the volume of the speakers by turning it clockwise or counterclockwise.

 **Mode Knob**

Use this **Mode Knob** to scroll through the channels by turning it clockwise or counterclockwise.

■ Using the Keypad

You can use the 3 x 4 alphanumeric keypad on the keypad microphone to access your radio's features. The keypad functions in a manner similar to a standard telephone keypad when entering numeric digits. When the keypad is used to edit a list, each key can generate different characters of the alphabet. The tables below show the number of times a key needs to be pressed to generate the required character.

📄 Keypad Characters – Uppercase Mode

Key	Number of Times Key is Pressed																				
	1	2	3	4	5	6	7	8	9	10	11	12	13	14	15	16	17	18	19	20	21
1	1	.	,	?	!	;	@	_	-	*	#	&	\$	/	+	=	\	"	'	()
2 abc	A	B	C																		
3 def	D	E	F																		
4 ghi	G	H	I																		
5 jkl	J	K	L																		
6 mno	M	N	O																		
7 pqrs	P	Q	R	S																	
8 tuv	T	U	V	8																	
9 wx yz	W	X	Y	Z																	
0	Toggle between mixed case mode, uppercase mode, and lowercase mode.																				
*	Space																				
#	Toggle between numeric and letter mode.																				

Keypad Characters – Lowercase Mode

Key	Number of Times Key is Pressed																				
	1	2	3	4	5	6	7	8	9	10	11	12	13	14	15	16	17	18	19	20	21
1	1	.	,	?	!	;	@	_	-	*	#	&	\$	/	+	=	\	"	'	()
2 abc	a	b	c																		
3 def	d	e	f																		
4 ghi	g	h	i																		
5 jkl	j	k	l																		
6 mno	m	n	o																		
7 pqrs	p	q	r	s																	
8 tuv	t	u	v																		
9 wx yz	w	x	y	z																	
0	Toggle between mixed case mode, uppercase mode, and lowercase mode.																				
*	Space																				
#	Toggle between numeric and letter mode.																				

Keypad Characters – Numeric Mode

Key	Number of Times Key is Pressed																				
	1	2	3	4	5	6	7	8	9	10	11	12	13	14	15	16	17	18	19	20	21
1	1	.	,	?	!	;	@	_	-	*	#	&	\$	/	+	=	\	“	‘	()
2 abc	2																				
3 def	3																				
4 ghi	4																				
5 jkl	5																				
6 mno	6																				
7 pqrs	7																				
8 tuv	8																				
9 wx yz	9																				
0	0																				
*	Space																				
#	Toggle between numeric and letter mode.																				

Keypad Characters – Hexadecimal Mode

Key	Number of Times Key is Pressed																					
	1	2	3	4	5	6	7	8	9	10	11	12	13	14	15	16	17	18	19	20	21	
1	1																					
2 abc	2	A	B	C																		
3 def	3	D	E	F																		
4 ghi	4																					
5 jkl	5																					
6 mno	6																					
7 pqrs	7																					
8 tuv	8																					
9 wx yz	9																					
0	0																					
*	Not applicable																					
#	Not applicable																					

■ Push-To-Talk (PTT) Button

The **PTT** button on the side of the microphone serves two basic purposes:

- While a call is in progress, the **PTT** button allows the radio to transmit to other radios in the call.

Press and hold down **PTT** button to talk. Release the **PTT** button to listen.

The microphone is activated when the **PTT** button is pressed.

- While a call is not in progress, the **PTT** button is used to make a new call. See **Making a Radio Call** on page 30 for more information.

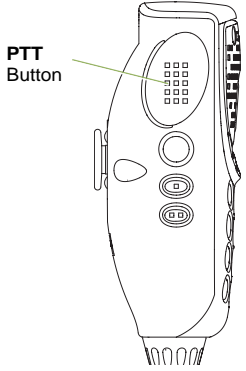

Identifying Status Indicators

Your radio indicates its operational status through the following:

- Status Icons page 17
- Text Messaging Service (TMS) Icons page 19
 - Status Icons page 19
 - TMS Menu Options page 20
- LED Indicator page 21
- Intelligent Lighting Indicators page 22
- Alert Tones page 23

■ Status Icons

The liquid crystal display (LCD) of your radio shows the radio status, text entries, and menu entries.

The following are the icons that appear on the radio's display.



Receiving

Radio is receiving a call or data.



Transmitting

Radio is transmitting a call or data.



Call Received

Radio has received an Individual Call.



Received Signal Strength Indicator (RSSI)

The number of bars displayed represents the received signal strength for the current site, for trunking only. The more stripes in the icon, the stronger the signal.



Direct

- **On** = Radio is currently configured for direct radio-to-radio communication (during conventional operation only).
- **Off** = Radio is connected with other radios through a repeater.



Monitor (Carrier Squelch)

Selected channel is being monitored (during conventional operation only).



In-Call User Alert

- **On** = The feature is enabled. Voice muting of the affiliated trunking talkgroup or selected conventional channel is activated.
- **Off** = The feature is disabled. Voice muting of the affiliated trunking talkgroup or selected conventional channel is deactivated.

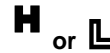

Power Level

- **L** = Radio is set at Low power.
- **H** = Radio is set at High power.



Scan

Radio is scanning a scan list.



Priority Channel Scan

- **Blinking dot** = Radio detects activity on channel designated as Priority-One.
- **Steady dot** = Radio detects activity on channel designated as Priority-Two.



View/Program Mode

Radio is in the view or program mode.

- **On steady** = View mode
- **Blinking** = Program mode



Vote Scan Enabled

The vote scan feature is enabled.



Secure Operation

- **On** = Secure operation.
- **Off** = Clear operation.
- **Blinking** = Receiving an encrypted voice call.



AES Secure Operation

- **On** = AES Secure operation.
- **Off** = Clear operation.
- **Blinking** = Receiving an encrypted voice call.



Location Signal

- **On** = Location feature is enabled, and location signal is available.
- **Off** = Location feature is disabled.
- **Blinking** = Location feature is enabled, but no location signal is available.



User Login Indicator (IP Packet Data)

- **On** = User is currently associated with the radio.
- **Off** = User is currently not associated with the radio.
- **Blinking** = Device registration or user registration with the server failed due to an invalid username or pin.



Data Activity

Data activity is present.



Hexadecimal

Indicates that the text entry is currently in hexadecimal mode.

■ Text Messaging Service (TMS) Icons

This feature allows you to send and receive text messages. See **Text Messaging Service (TMS)** on page 63 for more information.

📄 Status Icons

The following icons appear on the radio's display for TMS features:



Inbox Full

The Inbox is full.



Message Sent

The text message is sent successfully.



Message Unsent

The text message cannot be sent.



Unread Message

- User receives a new message.
- The selected text message in the Inbox has not been read.

Read Message

The selected text message in the Inbox has been read.

3/6

Message Index

Indicates the index of the current message the user is viewing.

Example: If the user is looking at the third message out of a total of 6 messages in the Inbox folder, the icon is displayed as the icon on the left column.



Priority Status

- The "Priority" feature is toggled on before the message is sent.
- Messages in the Inbox folder are flagged with "Priority".



Request Reply

- The "Request Reply" feature is toggled on before the message is sent.
- Messages in the Inbox folder are flagged with "Request Reply".





Priority Status and Request Reply

- User is composing a message with a priority status and a request for a reply.
- Messages in the Inbox folder are flagged with "Priority" and "Request Reply".

123

Numeric

Indicates that the text entry is currently in numeric mode.

Abc

Mixed Case

Indicates that the text entry is currently in normal text mode.

ABC

Uppercase

Indicates that the text entry is currently in uppercase mode.

abc

Lowercase

Indicates that the text entry is currently in lowercase mode.

TMS Menu Options

Menu Option	Description/Function
INBX	Brings you to your incoming messages screen.
COMP	Brings you to the compose screen.
DRFT	Brings you to the saved message screen.
SENT	Brings you to the sent messages screen.
BACK	Brings you back to the previous menu screen.
EDIT	Edits a draft message or key in a target address.
SAVE	Saves the messages you have edited to the Draft folder.
RPLY	Replies to a message.
DEL	Deletes a message or a character text during editing mode.
NEW	Creates a new message.
LIST	Brings you to the predefined messages screen.
IMPT	Toggles the "Priority Status" icon on or off for an outgoing message.
RQRP	Toggles "Request Reply" icon on or off for an outgoing message.

Menu Option	Description/Function
CURR	Deletes the current selected message.
ALL	Selects to delete all the messages in the current folder.
YES	Deletes all the messages in the current folder.
NO	Cancel the delete all messages options.
EXIT	Exits to the Home screen.
OPTN	Brings you to the Options main screen.
SEL	Selects a predefined message or address.
SEND	Sends the message.

LED Indicator

LED indicator shows the operational status of your radio.

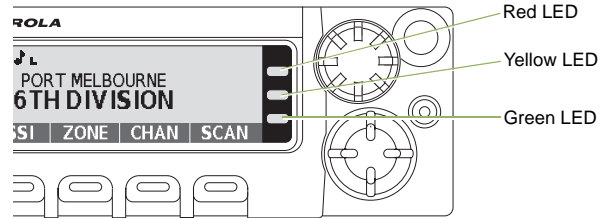

Solid red – Radio is transmitting.

Rapidly blinking red – Radio has failed the self test upon powering up or encountered a fatal error.

Solid yellow – Channel is busy.

Blinking yellow – Radio is receiving a secured transmission.

Solid green – Radio is powering up, or is on a non-priority channel while in the Scan List Programming mode.

Blinking green – Radio is receiving an individual or telephone call, or is on a Priority-Two channel while in the Scan List Programming mode.

Rapidly blinking green – Radio is on a Priority-One channel while in the Scan List Programming mode.

■ Intelligent Lighting Indicators

This feature temporarily changes the radio's display backlight color and the alert text background color to help signal that a radio event has occurred.

Note: This feature must be preprogrammed by a qualified radio technician.

Backlight	Event	When
Orange	Emergency Alerts	The radio initiates an emergency alarm or call.
		The radio receives an emergency alarm or call.
Red	Critical Alerts	The radio is out of range.
		The radio enters failsoft mode.
		The radio is unable to establish a full connection with the system.
Green	Call Alerts	The radio is unable to authenticate or register with the system.
		The radio receives a private call.
		The radio receives a phone call.
		The radio receives a call alert.
		The radio receives a selective call.

■ Alert Tones

An alert tone is a sound or group of sounds. Your radio uses alert tones to inform you of your radio's conditions. The following table lists these tones and when they occur.

You Hear	Tone Name	Heard
Short, Low-Pitched Tone	Radio Self Test Fail	When radio fails its power-up self test.
	Reject	When an unauthorized request is made.
	Time-Out Timer Warning	Four seconds before time out.
	No ACK Received	When radio fails to receive an acknowledgment.
Long, Low-Pitched Tone	Individual Call Warning Tone	When radio is in an individual call for greater than 6 seconds without any activity.
	Time-Out Timer Timed Out	When the Time-Out Timer has expired.
	Talk Prohibit/PTT Inhibit	(When PTT button is pressed) transmissions are not allowed.
	Out of Range	(When PTT button is pressed) the radio is out of range of the system.
A Group of Low-Pitched Tones	Invalid Mode	When radio is on an unpreprogrammed channel.
	Busy	When system is busy.

You Hear	Tone Name	Heard
Short, Medium-Pitched Tone	Valid Key-Press	When correct key is pressed.
	Radio Self Test Pass	When radio passes its power-up self test.
	Clear Voice	At beginning of a non-coded communication.
	Priority Channel Received	When activity on a priority channel is received.
	Emergency Alarm Entry	When entering the emergency state.
	Central Echo	When central controller has received a request from a radio.
Long, Medium-Pitched Tone	Volume Set	When volume is changed on a quiet channel.
	Emergency Exit	When exiting the emergency state.
A Group of Medium-Pitched Tones	Failsoft	When the trunking system fails.
	Automatic Call Back	When voice channel is available from previous request.
	Talk Permit	(When PTT button is pressed) verifying system accepting transmissions.
	Keyfail	When encryption key has been lost.
	Console Acknowledge	When status, emergency alarm, or reprogram request ACK is received.
	Received Individual Call	When Call Alert or Private Call is received.
	Call Alert Sent	When Call Alert is received by the target radio.
Site Trunking	When a SmartZone trunking system fails.	

You Hear	Tone Name	Heard
Ringing	Fast Ringing	When system is searching for target of Private Call.
	Enhanced Call Sent	When waiting for target of Private Call to answer the call.
	Phone Call Received	When a land-to-mobile phone call is received.
Gurgle	Dynamic Regrouping	(When the PTT button is pressed) a dynamic ID has been received.
Unique, Low-Pitched Chirp	New Message	When a new message is received.
Unique, High-Pitched Chirp	Priority Status	When a priority message is received.

General Radio Operation

Once you understand how your APX Mobile Radio is configured, you are ready to use your radio.

Use this navigation guide to familiarize yourself with the basic Call features:

- Selecting a Zone page 26
- Selecting a Radio Channel page 27
- Receiving and Responding to a Radio Call. page 27
- Making a Radio Call page 30
- Repeater or Direct Operation page 33
- Monitoring Features page 33

Selecting a Zone

A zone is a group of channels.

Note: Your radio must be preprogrammed to allow you to use these features.

Procedure:

- 1 **▶** or **◀** to **ZONE**.

- 2 Press the **Menu Select** button directly below **ZONE**. The display shows the current zone and channel.

- 3 **▶** or **◀** button until the desired zone is displayed.

- 4 Press **⏏** or the **PTT** button to confirm the selected zone number.

- 5 Press the **PTT** button to begin transmitting on the displayed zone channel.

■ Selecting a Radio Channel

A channel is a group of radio characteristics, such as transmit/receive frequency pairs.

Use the following procedure to select a channel.

Note: Your radio must be preprogrammed to allow you to use this feature. If you select a channel that is not within the preprogrammed band, the radio indicates that it is on an unsupported frequency with both audio and visual warnings.

Consult a qualified radio technician for the right choice between the following methods.

Procedure:

Rotate the **Mode** knob until the display shows the desired channel.

OR

- 1 Press and hold **▶** to scroll to **CHAN** and press the **Menu Select** button directly below **CHAN**. The display shows the current zone and channel.
- 2 Rotate the **Mode** knob to the desired channel.
- 3 Press **⏠** or the **PTT** button to confirm the channel.

Press the **PTT** button to transmit on the displayed zone channel.

■ Receiving and Responding to a Radio Call

Once you have selected the required channel and/or zone, you can proceed to receive and respond to calls.

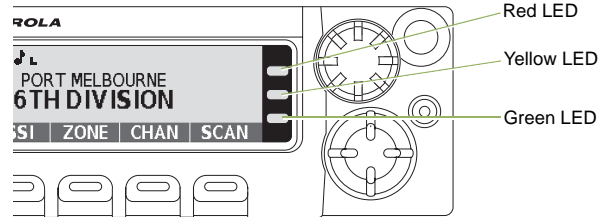

You see solid red while the radio is transmitting, and solid yellow when the radio is receiving a transmission (conventional mode only). There is no LED indication when the radio receives a transmission in trunking mode.

If the radio is receiving a secure transmission, the LED blinks yellow.

Receiving and Responding to a Talkgroup Call

To receive a call from a group of users, your radio must be configured as part of that talkgroup.

Procedure:

When you receive a talkgroup call (while on the Home screen), depending on how your radio is preprogrammed:

1 **ASTRO Conventional Only:**

The LED lights up solid yellow. The display shows the talkgroup alias or ID, and the caller alias or ID.

OR

Trunking Only:

The display shows the caller alias or ID.

2 Hold the microphone vertically 1 to 2 inches (2.5 to 5.0 cm) from your mouth.

3 Press the **PTT** button to respond to the call. The LED lights up solid red.

4 Release the **PTT** button to listen.

See **Making a Talkgroup Call** on page 30 for details on making a Talkgroup Call.

Receiving and Responding to a Private Call (Trunking Only)

A Private Call is a call from an individual radio to another individual radio.

These one-to-one calls between two radios are not heard by others in the current talkgroup. The calling radio automatically verifies that the receiving radio is active on the system and can display the caller ID.

Note: If the feature inactivity timer is enabled, your radio automatically exits the feature when your radio is left idle long enough for the time to expire. You will hear the Menu Inactive Exit Tone upon feature exit.

Procedure:

When you receive a Private Call:

1 You hear two alert tones and the LED blinks green. The display shows **CALL RECEIVED** and the caller alias or ID.

2 Press the **Menu Select** button directly below **RESP** within 20 seconds after the call indicators begin.

3 During the call, the display shows the caller alias (name), if it is in the call list.

OR

During the call, the display shows the caller ID (number), if the caller's name is not in the call list.

- 4 Press and hold the **PTT** button to talk. Release the **PTT** button to listen.
- 5 Press **⏏** to hang up and return to the Home screen.

Note: If you press **PTT** button before pressing the **Menu Select** button directly below **RESP**, your conversation will be heard by all members of the talk group.

If 20 seconds pass before you press the **Menu Select** button directly below the **RESP**, you will not respond privately to the call just received. Instead, you initiate a Private Call.

See **Making a Private Call (Trunking Only)** on page 31 for details on making a Private Call.

Receiving and Responding to a Telephone Call

This feature allows you to receive calls similar to standard phone calls from a landline phone.

Note: If the feature inactivity timer is enabled, your radio automatically exits the feature when your radio is left idle long enough for the time to expire. You will hear the Menu Inactive Exit Tone upon feature exit.

Procedure:

- 1 You hear a telephone-type ringing and the LED blinks green. The backlight of the screen turns green. The display shows **PHONE CALL** and the call received icon blinks.
- 2 Press the **Menu Select** button directly below **RESP**.
- 3 Press and hold the **PTT** button to talk. Release the **PTT** button to listen.
- 4 Press **⏏** or the **Menu Select** button directly below **EXIT** to hang up and return to the **Home** screen.

See **Making a Telephone Call** on page 32 for details.

■ Making a Radio Call

You can select a zone, channel, subscriber ID, or talkgroup by using:

- The preprogrammed Zone menu
- The Mode Knob
- A preprogrammed **One Touch** button
- The Contacts list (see **Contacts** on page 43).

Note: If the feature inactivity timer is enabled, your radio automatically exits the feature when your radio is left idle long enough for the time to expire. You will hear the Menu Inactive Exit Tone upon feature exit.

Making a Talkgroup Call

To make a call to a group of users, your radio must be configured as part of that talkgroup.

Procedure:

- 1 **▶** or **◀** to **TGRP** and press the **Menu Select** button directly below **TGRP**.
The display shows the last-selected talkgroup.
Press the **Menu Select** button directly below **SEL**.
OR
Rotate the **Mode Knob** to select the channel with the desired talkgroup.
-

- 2 Hold the microphone vertically 1 to 2 inches (2.5 to 5.0 cm) from your mouth.
 - 3 Press the **PTT** button to make the call.
 - 4 **ASTRO Conventional Only:**
The LED lights up solid red. The display shows the talkgroup alias or ID.
OR
Trunking Only:
The LED lights up solid red.
 - 5 Speak clearly into the microphone.
 - 6 Release the **PTT** button to listen.
-

Making a Private Call (Trunking Only)

This feature allows you to send an individual Call Alert or page if there is no answer from the target radio. Your radio must be preprogrammed to allow you to use this feature.



Procedure:

Press the preprogrammed **Quick Access (One-Touch)**



Enhanced Private Call button to dial the preprogrammed ID and proceed to Step 5.

OR

Follow the procedure below.

- 1  or  to **CALL**.

- 2 Press the **Menu Select** button directly below **CALL**. The display shows the last transmitted or received.

- 3 Press the **Menu Select** button directly below **CNTS** to scroll through and select the required ID.
OR
 Press the **Menu Select** button directly below **LIST** to go to the first number of the call list.
OR
 or  to the required ID.
OR
 Use the keypad to enter the required ID.

- 4 Press the **PTT** button to start the Private Call.

- 5 A telephone-type ringing sounds if the receiving unit is in service. The display shows **CALLING...<NUMBER>** or **CALLING...<ALIAS>**.

- 6 Hold the microphone vertically 1 to 2 inches (2.5 to 5.0 cm) from your mouth.

- 7 When you are connected, the display shows the ID of the target radio. Press and hold the **PTT** button to talk. Release the **PTT** button to listen.
OR
 If no acknowledgment is received, the display shows **NO ACKNOWLEDGE**.
OR
 If the target radio does not respond before the time out, the display shows **NO ANSWER**.

- 8 Press  to return to the **Home** screen.

See ***Sending a Call Alert Page*** on page 55 for more information.

Making a Telephone Call





This feature allows you to make calls similar to standard phone calls to a mobile or landline phone.

Procedure:

Press the preprogrammed **Quick Access (One-Touch) Phone Call** button to dial the preprogrammed phone number and proceed to Step 5.

OR

Follow the procedure below.

- 1  or  to **PHON**.
- 2 Press the **Menu Select** button directly below **PHON**. The display shows the last transmitted phone number.
- 3 Press the **Menu Select** button directly below **CNTS** to scroll through and select the required ID.
OR
Press the **Menu Select** button directly below **LIST** to go to the first number of the call list.
OR
 or  to the required phone number.
OR
Use the keypad to enter the required phone number.
- 4 Press and release the **PTT** button to dial the phone number.
- 5 Hold the microphone vertically 1 to 2 inches (2.5 to 5.0 cm) from your mouth.

- 6 When your call is answered, press the **PTT** button to talk.
- 7 Release the **PTT** button to listen.
- 8 Press  to return to the Home screen.

See **Alert Tones** on page 23 for more information if your call is **NOT** answered.

■ Repeater or Direct Operation

The **REPEATER** operation increases the radio's range by connecting with other radios through a repeater. The transmit and receive frequencies are different.

The **DIRECT** or "talkaround operation" allows you to bypass the repeater and connect directly to another radio. The transmit and receive frequencies are the same.

Procedure:

Press the preprogrammed **Repeater/Direct** switch to toggle between talkaround and repeater modes.

OR

Follow the procedure below.

- 1 **▶** or **◀** to **DIR**.

- 2 Press the **Menu Select** button directly below **DIR**.

- 3 The display shows **REPEATER MODE** if the radio is currently in Repeater mode.
OR
 The display shows **DIRECT MODE** and the Talkaround icon if the radio is currently in Direct mode (during conventional operation only).

*You can repeat step 2 to toggle between the two modes. Once in Direct Mode, press **PTT** button to start conversation with the radios nearby.*

■ Monitoring Features

Radio users who switch from analog to digital radios often assume that the lack of static on a digital channel is an indication that the radio is not working properly. This is not the case.

Digital technology quiets the transmission by removing the "noise" from the signal and allowing only the clear voice or data information to be heard.

Monitor a channel to ensure the channel is clear before transmitting.

Monitoring a Channel

Procedure:

Lift the microphone off hook.

Conventional Modes Only:

- 1 Listen for activity on that channel.

- 2 Adjust the **Volume** knob if necessary.

- 3 If you hear no activity, press and hold the **PTT** button to start your conversation.

OR

Trunked Modes Only:

- 1 Press the **PTT** button.
- 2 If you hear two, short, high-pitched tones, or if you hear no tone and the **T** indicator lights steadily, then proceed with your message.
- 3 Release the **PTT** button to receive (listen).

*If you are not in the range of the system, you may hear a continuous low-pitched tone and the display shows **OUT OF RANGE**.*

 **Conventional Mode Operation**

This feature allows you to monitor channel traffic on conventional channels by defeating the coded squelch. Thus you can listen to another user active on the channel. This way, you may be prevented from talking over someone else's conversation.

Note: This feature must first be enabled by a qualified radio technician or system administrator.

Procedure:

Take the control head off hook. (This is the same as monitor on. You hear all channel traffic.)

OR

- 1 At **Home** mode where the default zone and channel are being displayed, **▶** or **◀** button to **MON**.
- 2 Press the **Menu Select** button directly below **MON** momentarily to activate monitoring. The display shows **MONITOR ON**.
- 3 Press the **Menu Select** button to deactivate the monitoring. The display shows **MONITOR OFF**.

***MONITOR ON** shown on the display indicates that the radio is monitoring. Pressing the **Menu Select** button again turns monitor off and you don't hear all channel traffic.*

*If you try to transmit on a receive-only channel, you hear an invalid tone until you release the **PTT** button.*





Advanced Features

Use this navigation guide to learn more about advanced features available with your radio:

Advanced Call Features	page 35
Multiple Control Head Features	page 40
Contacts	page 43
Scan Lists	page 49
Scan	page 51
Call Alert Paging	page 54
Emergency Operation	page 56
Automatic Registration Service (ARS)	page 60
Text Messaging Service (TMS)	page 63
Secure Operations	page 73
The Global Positioning System (GPS)	page 78
Trunking System Controls	page 86
Ignition Switch Options	page 90
Utilities	page 92

Advanced Call Features

Calling a Phone Not in the List

- 1  or  to **PHON**.
- 2 Press the **Menu Select** button directly below **PHON**.
- 3 Enter the desired phone number from the optional keypad microphone. The display updates as the numbers are entered.
- 4 Press  button on the keypad microphone to make the call.
- 5 Press and hold the **PTT** button to talk. Release the **PTT** button to listen.
- 6 Press  or **Menu Select** button directly below **PHON** to exit.

Receiving and Making a Selective Call (Conventional Only)

This feature allows you to receive a call from or to call a specific individual. It is intended to provide privacy and to eliminate the annoyance of having to listen to conversations that are of no interest to you.

Receiving a Selective Call

Procedure:

- 1 When you receive a Selective Call, you hear two alert tones and the LED lights up solid yellow. The call received icons blink and the display alternates between **CALL RECEIVED** and the home display.
- 2 The speaker unmutes.
- 3 Hold the microphone vertically 1 to 2 inches (2.5 to 5.0 cm) from your mouth.
- 4 Press and hold the **PTT** button to talk. Release the **PTT** button to listen.

Note: If you press **PTT** button before pressing the **Menu Select** button directly below **CALL**, your conversation will be heard by all members of the talk group.

*If 20 seconds pass before you press the **Menu Select** button directly below the **CALL**, you will not respond privately to the call just received. Instead, you initiate a Selective Call. See **Making a Selective Call** on page 36.*





Making a Selective Call

Procedure:

Press the preprogrammed **Quick Access (One-Touch) Selective Call** button to dial the preprogrammed ID and proceed to Step 4.

OR

Follow the procedure below.

- 1  or  to **CALL**.
 - 2 Press the **Menu Select** button directly below **CALL**. The display shows the last transmitted or received ID.
 - 3 Press the **Menu Select** button directly below **CNTS** to scroll through and select the required ID.
- OR**
Press the **Menu Select** button directly below **LIST** to go to the last number dialed.
- OR**
 or  to the required ID.
- OR**
Use the keypad to enter the required ID.

- 4 Hold the microphone vertically 1 to 2 inches (2.5 to 5.0 cm) from your mouth.
- 5 Press and hold the **PTT** button to start the Selective Call. The display shows the ID of the target radio.
- 6 Release the **PTT** button to listen.
- 7 Press  to return to the Home screen.

If you do not press  button to hang up, your radio will remain in Selective Call state with the other unit. You will miss all subfleet traffic and incoming phone calls.

Using the Talkgroup Call Feature (Conventional Operation Only)

This feature allows you to define a group of conventional system users so that they can share the use of a conventional channel.



Note: Encryption keys are associated to talkgroups. When talkgroups are enabled, encryption keys are changed by changing the active talkgroup. See **Secure Operations** on page 73 for more information.

Selecting a Talkgroup

Procedure:

- 1  or  to TGRP.

- 2 Press the **Menu Select** button directly below **TGRP**. The display shows the last talkgroup that was selected and stored.

- 3  or  to **PSET** for the preset preprogrammed talkgroup.

OR

-  or  to the required talkgroup.

OR

Use the keypad to enter the number of the corresponding talkgroup in the list.

- 4 Press the **Menu Select** button directly below **SEL** to save the currently selected talkgroup and return to the **Home** screen.

- 5 If the encryption key associated to the new talkgroup is erased, a momentary key fail tone sounds and the display shows **KEY FAIL**.

OR

If the encryption key that is associated to the new talkgroup is not allowed, a momentary key fail tone sounds and the display shows **ILLEGAL KEY**.

- 6 Press  or the **PTT** button to exit.

Sending a Status Call

This feature allows you to send data calls to the dispatcher about a predefined status.

Each status can have up to a 14-character name. A maximum of eight status conditions is possible.





Note: If the feature inactivity timer is enabled, your radio automatically exits the feature when your radio is left idle long enough for the time to expire. You will hear the Menu Inactive Exit Tone upon feature exit.

Procedure:

Press the preprogrammed **Status** button and proceed to Step 3.

OR

Follow the procedure below.

- 1  or  to **STS**.
- 2 Press the **Menu Select** button directly below **STS**.
- 3 The display shows the last acknowledged status call, or the first status in the list.
- 4  or  to the required status.
OR
Use the keypad to enter a number corresponding to the location in the status list.
- 5 Press the **PTT** button to send the status. The display shows **PLEASE WAIT**.

- 6 When the dispatcher acknowledges, four tones sound and the display shows **ACK RECEIVED**. The radio returns to normal dispatch operation.

OR

If no acknowledgment is received, a low-pitched tone sounds and the display shows **NO ACKNOWLEDGE**.

- 7 Press  to return to the Home screen.

*No traffic is heard on trunked channels while Status Calls is selected. If the radio detects no Status Call activity for six seconds, an alert tone sounds until you press  or the **PTT** button.*

Using the Dynamic Regrouping Feature (Trunking Only)

This feature allows the dispatcher to temporarily reassign selected radios to a single special channel so they can communicate with each other. This feature is typically used during special operations and is enabled by a qualified radio technician.

You will not notice whether your radio has this feature enabled until a dynamic regrouping command is sent by the dispatcher.

Note: If you try to access a zone or channel that has been reserved by the dispatcher as a dynamically regrouped mode for other users, an invalid tone sounds.

Procedure:

- 1 When your radio is dynamically regrouped, it automatically switches to the dynamically regrouped channel. A “gurgle” tone sounds and the display shows the dynamically regrouped channel's name.
- 2 Press the **PTT** button to talk. Release **PTT** button to listen.

When the dispatcher cancels dynamic regrouping, the radio automatically returns to the zone and channel that you were using before the radio was dynamically regrouped.

Requesting a Reprogram



This feature lets you notify the dispatcher that you want a new dynamic regrouping assignment.

Procedure:

Press the preprogrammed **Reprogram Request** button to send reprogram request to the dispatcher and proceed to Step 3.

OR

Follow the procedure below.

- 1  or  to **RPGM**.
- 2 Press the **Menu Select** button directly below **RPGM** to send reprogram request to the dispatcher.
- 3 The display shows **REPROGRAM RQST** and **PLEASE WAIT**.
- 4 If you hear five beeps, the dispatcher has acknowledged the reprogram request. The display shows **ACK RECEIVED** and

the radio returns to the Home screen.

OR

If the dispatcher does not acknowledge the reprogram request within six seconds, a low-pitched alert tone sounds and the display shows **NO ACKNOWLEDGE**.

Try again or press  to cancel and return to the Home screen.

Classifying Regrouped Radios

The dispatcher can classify regrouped radios into either of two categories: **Select Enabled** or **Select Disabled**.

- Select-enabled radios are free to change to any available channel, including the dynamic-regrouping channel, once the user has selected the dynamic-regrouping position.
- Select-disabled radios cannot change channels while dynamically regrouped. The dispatcher has forced the radio to remain on the dynamic-regrouping channel.

The Scan or Private Call feature cannot be selected while your radio is Select Disabled.

■ Multiple Control Head Features

📄 Multiple Control Head Features

This feature allows a transceiver to control as many as four O5 control heads on APX 7500 and, up to two O5 control heads on APX 6500. You can use the CAN cables to connect in any configuration that does not exceed 131 feet (40 meters) in combined length. Refer the O5 Control Head Installation Manual (HLN6947) for further information.

The Multiple Control Head (MCH) feature consists of 2 modes that can be programmed via Customer Programming Software (CPS):

- All Active mode
- One Active mode

Note: If two or more control heads are connected to the system before enabling the MCH feature in the CPS, the radio will display **EXTRA CH** or **CH ID # ERR**. Both errors are **FATAL**.

📄 Setting the Initial Control Head's ID

This feature allows you to setup the control head in the **Front Panel Programming (FPP)** mode. During the setup, the control heads are defined as Control Head Number 1, Control Head Number 2, Control Head Number 3 and Control Head Number 4.

Procedure:

- 1 Press the **Power** button to power off the radio.
- 2 Press and hold the left-most **Menu Select** button and the emergency button simultaneously.
- 3 While continuing to depress these two buttons, press the **Power** button to power on the radio and the control head.
- 4 The radio and the control head will power on into **FPP** mode. The display shows control head's ID number.
- 5 Turn the **Mode** knob to change the control head's ID number.
- 6 Press the **Power** button to power off the radio and exit **FPP** mode.
- 7 Repeat steps 1 to 5 above to set the ID number for the rest of the attached control heads.

All Active Mode

The All Active mode enables all connected control heads attached to the radio to operate concurrently with each other. When you activate a feature on one control head, the rest of the control heads will have the same activated features and indicators on their respective display.

Note: The multiple control head feature allows only control heads of the same type to be connected. Upon power up, if a control head of a different type is connected to the radio, the radio reports the **FATAL** error **CH MISMATCH** on the display of all attached control heads.

Intercom Feature in All Active Mode

The intercom feature allows one control head user to talk to another control head user in a Multiple Control Head configuration. At any given time, when a control head being operated has priority for the intercom call, all other control heads are blocked until the active control head releases **PTT** button.

This can be made on any attached control head. This feature only applies to control heads in the All Active mode.

Procedure:

- 1 Press the **Menu Select** button directly below **INTC** to activate the intercom feature of any of the control heads.

- 2 Press the **PTT** button to initiate an intercom transmission. All control heads that are attached will receive the same intercom call.
- 3 The display of the control heads receiving the intercom call shows the alias/ID number of the transmitting control head.
- 4 Press the **Menu Select** button directly below **EXIT** to deactivate the intercom feature.
OR
Press  to deactivate the intercom feature.

*The intercom feature also deactivates when user initiates a mode change. If the radio is on an emergency channel, pressing of the **EMERGENCY** button or the emergency footswitch button on any control head also deactivates the intercom feature.*

One Active Mode

The One Active mode enables only one control head to be visibly active at a time in a **two** control head system.

Note: In the One Active mode, if more than two control heads are present upon power up, the radio shows a **FATAL** error **EXTRA CH** on the display of all attached control heads.

The active control head commands the system normally while the inactive control head is in remote mode with its display shows **REMOTE**.

The **Volume** knob, **DIM** button, **Front/Rear (F/R)** softkey and **Emergency** button remain active on the inactive control head, while all other controls are disabled. Emergency footswitch and VIP inputs remain active on the inactive control head. The VIP input control head is configurable in the CPS and VIP should be attached to the control head selected in the CPS.

Note: Only two (2) control heads are supported in the one active mode.

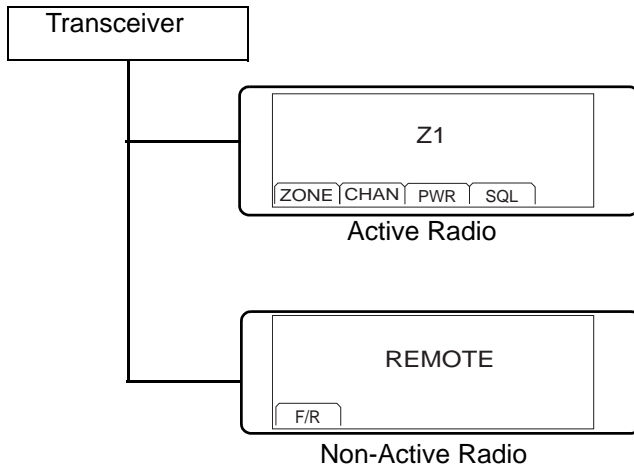

Follow the procedure below to change the command between the two control heads.

Procedure:

Press the **Menu Select** button directly below **F/R**.

OR

Press the **Menu Select** button preprogrammed user button on the keypad microphone.

■ Contacts

This feature provides “address-book” capabilities on your radio. Each entry corresponds to an alias (name) or ID (number) that you use to initiate a call.

Contact entries are alphabetically sorted according to entry alias. Each alias can have up to 5 IDs of different call types associated with it.

Additionally, each entry, depending on context (conventional, trunking, or phone), associates with one or more of the four types of calls: Phone Call, Selective Call, Private Call, or Call Alert.

Each entry within Contacts displays the following information:

- Call Alias (Name)
- Call ID (Number)
- Call Type (Icon)
- WACN ID (Astro 25 Trunking IDs only)
- System ID

Note: Your radio must be preprogrammed to allow you to add, edit, or delete the contact entries.

Your radio also supports a maximum of 50 call lists. Each list can store up to 100 IDs (numbers).

Note: Your radio is preprogrammed with a number of contacts per Call Lists. Check with your dealer or system administrator for more information.

If the feature inactivity timer is enabled, your radio automatically exits the feature when your radio is left idle long enough for the time to expire. You will hear the Menu Inactive Exit Tone upon feature exit.

Making a Private Call from Contacts

Note: Your radio must be preprogrammed to allow you to use this feature.

Procedure:

Use the Options Menu.

- 1 **▶** or **◀** to **CNTS**.

- 2 Press the **Menu Select** button directly below **CNTS** to the call list. The display shows Contact Alias.

- 3 **▶** or **◀** to the required subscriber alias.

- 4 Press the **Menu Select** button directly below **OPTN**.

- 5 **▶** or **◀** to **CALL** and press the **Menu Select** button directly below **SEL**.

- 6 **▶** or **◀** to select the call type.

- 7 Hold the microphone vertically 1 to 2 inches (2.5 to 5.0 cm) from your mouth.
- 8 Press the **PTT** button to initiate the call. During the call, the display shows the subscriber alias.
- 9 Press and hold the **PTT** button to talk. The LED lights up solid red.
OR
Release the **PTT** button to listen. The LED lights up solid green.
- 10 If there is no voice activity for a programmed period of time, the call ends.
OR
The call ends when it reaches the maximum ring time.

OR

Use the **PTT** button:

- 1 **▶** or **◀** to **CNTS**.
- 2 Press the **Menu Select** button directly below **CNTS**.
- 3 **▶** or **◀** to the required subscriber alias.
- 4 Press the **Menu Select** button directly below **CNTS**. The display shows Contact Alias.
- 5 Hold the microphone vertically 1 to 2 inches (2.5 to 5.0 cm) from your mouth.

- 6 Press the **PTT** button to initiate the call. During the call, the display shows the subscriber alias.
- 7 Press and hold the **PTT** button to talk. The LED lights up solid red.
OR
Release the **PTT** button to listen. The LED lights up solid yellow.
- 8 If there is no voice activity for a preprogrammed period of time, the call ends.
OR
The call ends when it reaches the maximum ring time.

Adding a New Contact Entry

Procedure:

- 1 **▶** or **◀** to **CNTS**.

- 2 Press the **Menu Select** button directly below **CNTS**. The entries are alphabetically sorted.

- 3 **▶** or **◀** to **[NEW CONTACT]** and press the **Menu Select** button directly below **SEL**.

- 4 The display shows **NAME**. Press the **Menu Select** button directly below **EDIT**.
Use the keypad to enter the name.
Press **◀** to move one space to the left.
Press **▶** to move one space to the right.
Press the **Menu Select** button below **DEL** to delete any unwanted characters.
Press **(*)** to add a space.
Press **(0)** to toggle between mixed case mode, uppercase mode, and lowercase mode.
Press **(#)** to toggle between numeric and letter mode.

- 5 Press the **Menu Select** button directly below **OK** once you have entered the name.
OR
Press the **Menu Select** button directly below **CNCL** to return to the previous screen.

- 6 **▶** or **◀** to **[ADD NUMBER]** and press the **Menu Select** button directly below **SEL**. The display shows **TYPE 1 <DEFAULT TYPE>**.

- 7 Press **Menu Select** button directly below **EDIT**.

- 8 **▶** or **◀** to the required channel and press the **Menu Select** button directly below **OK**.

- 9 **▶** or **◀** to **NUMBER 1** and press the **Menu Select** button directly below **EDIT**.
The display shows **NUMBER 1** and a cursor appears.
Use the keypad to enter the number.
Press **◀** to move one space to the left.
Press **▶** to move one space to the right.
Press the **Menu Select** button directly below **DEL** to delete any unwanted characters.

- 10 Press the **Menu Select** button directly below **OK** once you have entered the number.
OR
Press the **Menu Select** button directly below **CNCL** to return to the previous screen.

- 11 Press the **Menu Select** button directly below **DONE** once you have finished.

- 12 The display shows **<ENTRY> STORED**, confirming that the contact entry has been added.

- 13 The radio returns to the main Contacts screen.

Deleting a Contact Entry

Procedure:

- 1 **▶** or **◀** to **CNTS**.

- 2 Press the **Menu Select** button directly below **CNTS**. The entries are alphabetically sorted.

- 3 **▶** or **◀** to the entry you want to delete and press the **Menu Select** button directly below **OPTN**.

- 4 **▶** or **◀** to **DELETE** and press the **Menu Select** button directly below **SEL**. The display shows **<ENTRY> CONFIRM DEL?**.

- 5 Select **YES** to delete the entry. The display shows **<ENTRY> DELETED** and the radio returns to the main screen for Contacts.
OR
Select **NO** to return to the main screen for Contacts.

Adding a Contact to a Call List or Phone List

Procedure:

- 1 **▶** or **◀** to **CNTS**.

- 2 Press the **Menu Select** button directly below **CNTS**. The entries are alphabetically sorted.

- 3 **▶** or **◀** to the entry you want to add to the call list and press the **Menu Select** button directly below **OPTN**.

- 4 **▶** or **◀** to **ADD TO CALLST** or **ADD TO PHONLST** and press the **Menu Select** button directly below **SEL**.

- 5 **▶** or **◀** until the display shows **[AVAILABLE]** and press the **Menu Select** button directly below **ADD** to add as a new entry.
OR
▶ or **◀** until the display shows **<ENTRY>** and its associated number and press the **Menu Select** button directly below **RPLC** to replace the existing entry.



- 6 The display shows **<ENTRY> ADDED**, confirming the addition of the contact to the list.

- 7 The radio returns to the main display for Contacts.



Editing a Contact in a Call List or a Phone List



Editing an Entry Alias



Procedure:





- 1  or  to **CNTS**.

- 2 Press the **Menu Select** button directly below **CNTS**. The entries are alphabetically sorted.

- 3  or  to the entry you want to edit and press the **Menu Select** button directly below **OPTN**.

- 4  or  to **EDIT** and press the **Menu Select** button directly below **SEL**.

- 5  or  to the entry alias you wish to change and press the **Menu Select** button directly below **EDIT**.



- 6 A cursor appears.
Use the keypad to edit the name.
Press  to move one space to the left.
Press  to move one space to the right.
Press the **Menu Select** button below **DEL** to delete any unwanted characters.
Press  to add a space.
Press  to toggle between mixed case mode, uppercase mode, and lowercase mode.
Press  to toggle between numeric and letter mode.

- 7 Press the **Menu Select** button directly below **OK** once you have finished. The display returns to the Edit Contact screen.



- 8 Press the **Menu Select** button directly below **DONE** to save your changes and return to the main screen for Contacts.



Editing as Entry ID



Procedure:



- 1  or  to **CNTS**.

- 2 Press the **Menu Select** button directly below **CNTS**. The entries are alphabetically sorted.

- 3  or  to the entry you want to edit and press the **Menu Select** button directly below **OPTN**.

- 4  or  to **EDIT** and press the **Menu Select** button directly below **SEL**.

- 5  or  to the entry ID you wish to change and press the **Menu Select** button directly below **EDIT**.

- 6 A cursor appears.
Use the keypad to edit the number.
Press  to move one space to the left.
Press  to move one space to the right.
Press the **Menu Select** button below **DEL** to delete any unwanted characters.

Press ***** to add a space.

Press **0** to toggle between mixed case mode, uppercase mode, and lowercase mode.

Press **#** to toggle between numeric and letter mode.

- 7 Press the **Menu Select** button directly below **OK** once you have finished. The display returns to the Edit Contact screen.
- 8 Press the **Menu Select** button directly below **DONE** to save your changes and return to the main screen for Contacts.

Editing a Call Type

Procedure:

- 1 **▶** or **◀** to **CNTS**.
- 2 Press the **Menu Select** button directly below **CNTS**. The entries are alphabetically sorted.
- 3 **▶** or **◀** to the entry you want to edit and press the **Menu Select** button directly below **OPTN**.
- 4 **▶** or **◀** to **EDIT** and press the **Menu Select** button directly below **SEL**.
- 5 **▶** or **◀** to **TYPE** and press the **Menu Select** button directly below **EDIT**.
- 6 **▶** or **◀** to choose from the list of call types given and press the **Menu Select** button directly below **OK** to select.
- 7 The display returns to the Edit Contact screen.
- 8 Press the **Menu Select** button directly below **DONE** to save your changes and return to the main screen for Contacts.

■ Scan Lists

Scan lists are created and assigned to individual channels/groups. Your radio scans for voice activity by cycling through the channel/group sequence specified in the scan list for the current channel/group.





Your radio supports different types of Scan Lists:

- Trunking Priority Monitor Scan List
- Conventional Scan List
- Talkgroup Scan List

A maximum of 200 Scan Lists can be programmed in your radio. These lists must be preprogrammed by a qualified radio technician.

Viewing a Scan List







Procedure:

- 1  or  to **SCNL**.
- 2 Press the **Menu Select** button directly below **SCNL**.
- 3  or  to view the members on the list.
- 4 Press the  to exit the current display and return to the Home screen.

Editing the Scan List

This feature lets you change scan list members and priorities.

Procedure:

- 1  or  to **SCNL**.
- 2 Press the **Menu Select** button directly below **SCNL**. The display shows the lists that can be changed.
- 3  or  to the entry you want to edit.
- 4 Press the **Menu Select** button directly below **SEL** to add and/or change the priority of the currently displayed channel in the scan list.
OR
 Press the **Menu Select** button directly below **DEL** to delete the currently displayed channel from the scan list.
OR
 Press the **Menu Select** button directly below **RCL** to view the next member of the scan list.
- 5  or  to select more channels to be added or deleted.
OR
 Use the keypad to go directly to additional channels to be added or deleted.
OR
 Use the **Mode Knob** to select additional channels to be added or deleted.

- 6 Press **⏏** to exit scan list programming and return to the Home screen.
-

See **Viewing and Changing the Priority Status** on page 50 for more information on how to add and/or change the priority of the currently displayed channel in the scan list.

Changing the Scan List Status

Procedure:

- 1 Long press the preprogrammed **Scan** side button.
 - 2 **▶** or **◀** to the member you want to edit.
 - 3 Press the **✓** button or press the **Menu Select** button directly below **SEL** once to add the currently displayed channel to the scan list.
OR
Press the **✓** button or press the **Menu Select** button directly below **SEL**, one or more times to change the scan list status icon of the currently displayed channel.
 - 4 **▶** or **◀** to select more list members whose scan status you want to change.
OR
Use the keypad to go directly to that scan list member.
OR
Use the **Mode Knob** to select another scan list member.
-

- 5 Press **⏏** to exit scan list programming and return to the Home screen.
-

Viewing and Changing the Priority Status

Procedure:

- 1 Below the **SEL**, **DEL**, and **RCL** screen, press the **Menu Select** button directly below **SEL** to view and/or change the priority status of the currently displayed channel.
OR
Below the **SEL**, **DEL**, and **RCL** screen, press the **✓** button or press the **Menu Select** button directly below **SEL**, one or more times to view and/or change the scan list status icon of the currently displayed channel.
 - 2 A Scan icon indicates that the current channel is in the scan list as a non-priority channel. The LED lights up solid green.
OR
A Priority-Two Channel Scan icon indicates that the current channel is in the scan list as the Priority-Two channel. The LED blinks green.
OR
A Priority-One Channel Scan icon indicates that the current channel is in the scan list as the Priority-One channel. The LED rapidly blinks green. You hear all traffic on the Priority-One channel, regardless of traffic on non-priority channels.
OR
No icon indicates that the current channel is deleted from the scan list.
-

■ Scan

This feature allows you to monitor traffic on different channels by scanning a preprogrammed list of channels.

📄 Turning Scan On or Off

Procedure:

Press the preprogrammed **Scan** button.

OR

Follow the procedure below.

- 1 **▶** or **◀** to **SCAN**.

- 2 Press the **Menu Select** button directly below **SCAN**.

- 3 The display shows **SCAN OFF** if scan is disabled. Press the **Menu Select** button directly below **SCAN** to enable scan.
OR
The display shows **SCAN ON** and the scan status icon if scan is enabled. Press the **Menu Select** button directly below **SCAN** to disable scan.

- 4 The radio returns to the Home screen.

📄 Turning Scan On While Disregarding the Squelch Code (Conventional Channels Only)

Procedure:

- 1 **▶** or **◀** to **MON**.

- 2 Press the **Menu Select** button directly below **MON**.

- 3 The brief **MONITOR ON** display indicates that the radio is disregarding the squelch code.

While scanning for activity, you can still receive fleetwide, system-wide, dynamic regrouping, incoming telephone interconnect and Private Conversation/Call Alert calls.

Respond to these types of calls as you would normally on the selected channel. However, when scanning different channels while in talkgroup scan, incoming Private Conversation/Call Alert calls may be missed.

📄 Transmitting While the Scan is On

📄 Radio Programmed for Talkback Scan

Procedure:

- 1 Press the **PTT** button to transmit on the channel indicated by the display.

The radio does not begin scanning again for a predetermined hang time after you release the **PTT** button, allowing the other party to respond. If the other party responds within the hang time, scanning does not resume until the full hang time expires after they have finished speaking, allowing the conversation to be completed.

To transmit on the selected channel if another channel is active, first turn scan off by pressing the **Menu Select** button below **SCAN** momentarily.

Radio Programmed for Non-Talkback Scan

Procedure:

- 1 Press the **PTT** button at any time to transmit on the selected channel or fixed channel.
-



To make a *Call Alert* page, or *Private Conversation* call while scanning, press either the **Menu Select** button directly below **PAGE** or **CALL**. The call is entered on the selected channel and scanning is halted until the call is exited by pressing  or pressing the **Menu Select** button below either **PAGE** or **CALL**.

Deleting a Nuisance Channel

If a channel continually generates unwanted calls or noise (termed a “nuisance” channel), you can temporarily remove the unwanted channel from the scan list.

This capability does not apply to priority channels or the designated transmit channel.

Procedure:

- 1 When the radio is locked onto the channel to be deleted,  or  to **NUIS**.

 - 2 Press the **Menu Select** button directly below **NUIS**.
-

Restoring a Nuisance Channel

Procedure:

To restore the deleted nuisance channel, do **one** of the following:

- Turn scan off, then on.
OR
- Change modes.
OR
- Turn off the radio, and then turn it back on.

Nuisance mode delete can be disabled by the system administrator.

Changing Priorities Status While Scan is On

While the radio is scanning, the dynamic priority change feature allows you to temporarily change any channel in a scan list (except for the Priority-One channel) to the Priority-Two channel.

This change remains in effect until scan is turned off. Scan then reverts to the preprogrammed (original) setting.

Procedure:

- 1 Press the **Menu Select** button directly below **DYNP** to change the priority of a non-priority channel in the scan list to Priority-Two.

- 2 Press  momentarily to exit the scan list and resume scanning.

Restoring Priorities in a Scan List

Procedure:

To restore the original channel priorities in a scan list, do one of the following:

- Turn scan off, then on.
OR
- Change channels.
OR
- Turn off the radio, and then turn it back on.

Hang Up (HUB)

To temporarily suspend Scan Mode operation, remove the control head from the Hang Up Box (HUB). You are allowed to use the control head while scan is suspended. However, Priority Member scanning is not suspended. This feature applies to all Scan Lists and Scan Types. Scan is resumed once the control head is returned to the holding clip and the preprogrammed hang time has elapsed.

Note: Priority Scan List members are continuously scanned only when the Scan List, **Designated Tx Member** field is set to “Talkback” in the radio programming. Otherwise, all scan mode operation is suspended.

■ Call Alert Paging

This feature allows your radio to work like a pager.

Even if other users are away from their radios, or if they are unable to hear their radios, you can send them an individual Call Alert page. You can also verify if a radio is active on the system.

Depending on how your radio is programmed, when you make an Enhanced Private Call, the radio either automatically sends a Call Alert page if there is no answer after the maximum ring time, **OR** when you press the **PTT** button.

Note: This feature must be preprogrammed by a qualified radio technician.

Receiving a Call Alert Page

Procedure:

When you receive a Call Alert page

- 1 You hear four repeating alert tone and the green LED blinks.
OR
You hear one alert tone and the green LED blinks if Call Alert Tone Auto Reset is enabled.

- 2 The call received icons blinks and the display shows **PAGE RECEIVED**.

- 3 Press the **PTT** button to answer.
OR
Press any button to clear the Call Alert page.

See ***Making a Talkgroup Call*** on page 30 or ***Making a Private Call (Trunking Only)*** on page 31 for more information.

Sending a Call Alert Page





Note: If the feature inactivity timer is enabled, your radio automatically exits the feature when your radio is left idle long enough for the time to expire. You will hear the Menu Inactive Exit Tone upon feature exit.

Procedure:

Press the preprogrammed **Quick Access (One-Touch) Call Alert Paging** button to send a page to the preprogrammed ID and proceed to Step 5 of the procedure below.

OR





Follow the procedure below.

- 1  or  to **PAGE**.
- 2 Press the **Menu Select** button directly below **PAGE**.
- 3  or  to select the required ID.
- 4 Press the **PTT** button to send the page.
- 5 The display shows **PAGING...<NUMBER>** or **<ALIAS>**.
- 6 If the call alert page is sent successfully, four highpitch tone sounds and the display shows **ACK RECEIVED**.
OR
If the call alert page is not acknowledged, a low tone sounds and the display shows **NO ACKNOWLEDGE**.
- 7 The radio returns to the Home screen.
OR

Press the **Menu Select** button directly below **OK** to return to the main screen for Contacts.

OR

Follow the procedure below.



- 1  or  to **CALL**.
- 2 Press the **Menu Select** button directly below **CALL**.
- 3  or  to select the required ID, press the **PTT** button to initiate the call.
- 4 If the target radio does not respond after a preprogrammed period of time, the display shows **SEND PAGE?**.
- 5 Press the **Menu Select** button directly below **YES** to send the call alert page.
OR
Press the **Menu Select** button directly below **NO** to exit the screen without sending the call alert page.
- 6 The display shows **PAGING...<ALIAS>**.
- 7 If the call alert page is sent successfully, a tone sounds and the display shows **ACK RECEIVED**.
OR
If the call alert page is not acknowledged, a low tone sounds and the display shows **NO ACKNOWLEDGE**.
- 8 The radio returns to the Home screen.
OR

Press the **Menu Select** button directly below **OK** to return to the main screen for Contacts.

In-Call User Alert

You can enable and disable voice transmission, if needed.

Procedure:

- 1 Make sure you are in Home mode where the default zone and mode are being displayed.
- 2  or  to scroll to the **VMUT**.
- 3 Press the **Menu Select** button directly below **VMUT**.
- 4 Press the **Menu Select** button directly below **VMUT** or the **VMut** preprogrammed button again to turn the feature off and you will be able to hear to normal dispatch calls.

*Pressing the **Menu Select** button directly below **VMUT** or the **VMut** programmed button momentarily toggles between Voice mute on and Voice mute off. **VOICE MUTE ON** shown on the display indicates that the radio is muted to all conventional dispatch calls and affiliated trunking group calls.*

Emergency Operation

The Emergency feature is used to indicate a critical situation.

If the **Orange** button is preprogrammed to send an emergency signal, this signal overrides any other communication over the selected channel.

Your radio supports 5 Emergency modes:

- Emergency Call
- Emergency Alarm
- Emergency Alarm with Call
- Silent Emergency Alarm
- Special Considerations for Emergencies

Check with your dealer or system administrator for more information on the programming of this feature.

Only **one** of the Emergency modes above can be assigned to the preprogrammed **Emergency** button or the **Emergency** footswitch.

Note: To exit emergency at any time, press and hold the preprogrammed Emergency button for about a second.

Sending an Emergency Alarm

This feature allows you to send a data transmission, which identifies the radio sending the emergency, to the dispatcher.

Procedure:

- 1 Press the preprogrammed **Emergency** button. A tone sounds and the display alternates **EMERGENCY** and the home display.
- 2 A dispatcher acknowledgment **ACK RECEIVED** display follows.
AND, Trunking Only:
A high-pitched tone indicates that the alarm has been received by the trunked system's central controller.
- 3 Press and hold the emergency button or the **PTT** button to return to normal operation.

Sending an Emergency Call (Trunking Only)

Procedure:

- 1 Press preprogrammed **Emergency** button.
- 2 A tone sounds and the display alternates **EMERGENCY** and the home display.
OR
A short low-pitched tone sounds when the selected channel does not support emergency.
- 3 Hold the microphone vertically 1 to 2 inches (2.0 to 2.5 cm) from your mouth.
- 4 Press and hold the **PTT** button. Speak clearly into the microphone.
- 5 Release the **PTT** to end the transmission.
- 6 Press and hold the preprogrammed Emergency button until a tone sounds to exit Emergency mode.

Sending an Emergency Alarm with Emergency Call

This feature allows you to send an Emergency Alarm to another radio. Upon acknowledgement, both radios can communicate over a preprogrammed Emergency channel.

If the radio has both emergency call and alarm features enabled, it automatically proceeds to the call mode after the alarm is acknowledged.

Procedure:

- 1 Press the preprogrammed **Emergency** button to activate the emergency call/alarm feature.
- 2 The display alternates **EMERGENCY** and the home display.
- 3 A high-pitched tone sounds, indicating that the alarm has been received by the trunked system's central controller. A dispatcher acknowledgment (four high-pitched tones) follows, accompanied by an **ACK RECEIVED** display.
- 4 Hold the microphone vertically 1 to 2 inches (2.0 to 2.5 cm) from your mouth.
- 5 Press and hold the **PTT** button. Speak clearly into the microphone.
- 6 Release the **PTT** to end the transmission.
- 7 Press and hold the preprogrammed Emergency button until a tone sounds to exit Emergency mode.

Turning the radio off also cancels the emergency state.

Sending a Silent Emergency Alarm

This feature allows you to send an Emergency Alarm to another radio without any audio or visual indicator.

Upon acknowledgement, your radio's microphone is automatically activated, allowing you to communicate with the other radio without pressing the **PTT** button.

This activated microphone state is also known as "**hot mic**".

Note: If you press the PTT button during hot mic, and continue to press it after the hot mic duration expires, the radio continues to transmit until you release the PTT button.

Procedure:

- 1 Press the preprogrammed **Emergency** button to activate the silent alarm feature.
- 2 Press and hold the emergency button until a tone sounds to exit the silent alarm mode.

*If silent emergency alarm is used with emergency call, pressing the **PTT** button exits the silent mode and initiates the emergency call.*

Special Considerations for Emergencies

- If you press the emergency button while in a channel that has no emergency capability, a low-pitched tone sounds.
- If the unit is out of the range of the system and/or the emergency alarm is not acknowledged, a tone sounds and the display shows **NO ACKNOWLEDGE**.
- If you press the emergency button, then change to a mode that has no emergency capability, the display shows **NO EMERGENCY** and a continuous low-pitched tone sounds until a valid emergency mode is selected or until the emergency is cancelled.
- When an emergency is active, changing to another mode where emergency is enabled (trunked or conventional) causes an emergency alarm and/or emergency call to be active on the new mode.

■ Automatic Registration Service (ARS)

This feature provides an automated data application registration for the radio. When you turn on the radio, the device automatically registers with the server.

Data applications within the fixed network can determine the presence of a device on the system and send data to the device. For example: Text Messaging Service (TMS).

The Automatic Registration Service for the radio consists of two (2) modes:

- ARS Server Mode (default mode)
- ARS Non Server Mode

Note: The default ARS mode can be changed by a qualified radio technician using the radio's programming software.

Selecting or Changing ARS Mode

Procedure:

- 1 After the zone you want is displayed, toggle until the display shows the required channel.

OR

Press and hold **▶** or **◀** to **CHAN**.

Press the **Menu Select** button directly below **CHAN**.

The display shows the current zone is not blinking, and the channel is blinking.

- 2 **▶** or **◀** or rotate the **Mode Knob** to the required channel.
-

- 3 In ARS Server Mode, the display shows the User Login Indicator icon, the zone, and ARS server channel.

OR

In ARS Non-Server Mode, the display shows the User Login Indicator icon, the zone, and ARS non-server channel.

OR

If the channel or mode selected is unprogrammed, the display shows **UNPROGRAMMED**. Repeat Step 2.

- 4 Press **🏠** to confirm the displayed zone and channel.
-

Accessing the User Login Feature

This feature allows you as the user to be associated with the radio. With this association, every data application (Example: Text Messaging Service) takes on a friendly username.

You can still send text messages without logging in as a user. The user login feature only enables the recipient of your message to identify you as the sender by assigning a username to your message.



Note: Valid characters for a username entry are capital letters (A – Z), small letters (a – z), numbers (0 – 9), symbols (*, #, -, /), and the space character.

The maximum length for a username is eight (8) characters. Usernames are not case sensitive in server mode but are case sensitive in non-server mode.

A predefined username may sometimes be invalid because the programming software that is used to set predefined usernames allows you to set usernames comprising of eight (8) characters or more.

Logging In as a User





Procedure:

- 1  or  to **USER**.

- 2 Press the **Menu Select** button directly below **USER**.

- 3 The display shows the User Login screen.

- 4 Press the **Menu Select** button directly below **ID**.

- 5 A blinking cursor appears beside **ID**. Use the keypad to enter a username using the keypad multi-tap function.
OR
 or  to scroll through the list of predefined usernames. Press the **Menu Select** button to select a predefined username.
OR
 Press and hold  or  to scroll through the list of predefined usernames at a fast scroll rate. Press the **Menu Select** button directly below **LOGIN** to select a predefined username.

- 6 If the selected predefined username has more than eight (8) characters, or an invalid character in it, the display momentary shows **INVALID ID**. Repeat Step 5.
OR
 Press the **Menu Select** button directly below **PIN**.

- 7 A blinking cursor appears beside **PIN**. Enter your Personal Identification Number (PIN) number.

The maximum PIN length is 4 digits. The PIN number will appear as asterisks.

- 8 Press the **Menu Select** button directly below **LOGN**.
- 9 In ARS server mode, the display shows the User Login Indicator icon, the ID, **IN PPROGRESS** and **CNCL**.
OR
In ARS non-server mode, the display shows the User Login Indicator icon, the ID, **LOGGED IN** and **LOGT**.
In non-ARS enabled mode, the display shows **OFFLINE** and **LOGT**.
- 10 If the username is invalid, login fails and the user login failure indicator (IP indicator) icon blinks. The display also momentarily shows **LOGIN FAILED**. Repeat step 5.
OR
If the PIN is invalid, login fails and the user login failure indicator (IP indicator) icon blinks. The display also momentarily shows **LOGIN FAILED**. Repeat Step 7.
OR
Press the **Menu Select** button directly below **CNCL** to cancel the login in progress screen and return to the initial user login screen.
OR
Wait for the logged in confirmation screen. If the login process is successful, the display shows the successful user login indicator (IP indicator) icon and **LOGGED IN** and **LOGT**.

Logging Out

Once the data application registration is completed, you can log out.

Procedure:

- 1 **▶** or **◀** to **LOGT**.
- 2 Press the **Menu Select** button directly below **LOGT**.
- 3 Display shows the User Login Indicator icon and **CLEAR PRIVATE DATA?**.
- 4 Select **YES** to clear all your private data. The display shows momentary **PRIVATE DATA CLEARED**.
OR
Select **NO** to keep your private data.

Note: Private data refers to all messages in the text messaging Inbox, Draft and Sent folder. The next radio user will be able to access your Inbox, Draft and Sent messages if private data is not deleted.

■ Text Messaging Service (TMS)

This feature allows you to send and receive text messages. The **maximum** length of characters for a text message is **200**.

There are three (3) types of text messages:

- A new text message (free form message)
- A predefined message (quick text message)
- An edited quick text message

The main menu consists of the following options:

- Inbox
- Compose
- Drafts
- Sent

Note: See **Status Icons** on page 19 for more details on the TMS icons and **TMS Menu Options** on page 20 for more details on each menu option.

📄 Accessing TMS Feature

Note: If the feature inactivity timer is enabled, your radio automatically exits the feature when your radio is left idle long enough for the time to expire. You will hear the Menu Inactive Exit Tone upon feature exit.

Press the **Menu Select** button directly below **BACK** at any time to return to the previous screen.

Procedure:

Press the preprogrammed **Data Feature** button or the **TMS** button to access the TMS feature screen.

OR

Press and hold the preprogrammed **Data Feature** button or the **TMS** button to access the Inbox screen.

OR

Follow the procedure below.

- 1 **▶** or **◀** to **TMS**.

- 2 Press the **Menu Select** button directly below **TMS** to access the TMS feature screen.

- 3 **▶** or **◀** to scroll through the main menu options.

📄 Composing and Sending a New Text Message

Note: During the uppercase and lowercase mode, multi-tapping the keys only scrolls through the letters. For example, **A->B->C**, **a->b->c**.

During the num lock mode, except for **1**, pressing the keypad only enters the numeric digits. Subsequent presses of the same key inserts the same digit to the text message (no multi-tap).

Procedure:

- 1 **▶** or **◀** to **TMS**.

- 2 Press the **Menu Select** button directly below **TMS** to access the TMS feature screen.

- 3 Press the **Menu Select** button directly below **COMP** to see the compose options.

- 4 Press the **Menu Select** button directly below **NEW** to compose a new message.

- 5 A blinking cursor appears on the **Compose** screen. Use the keypad to type or edit your message.
 - Press **◀** to move one space to the left.
 - Press **▶** to move one space to the right.
 - Press the **Menu Select** button directly below **DEL** to delete any unwanted characters.
 - Press **(*)** to add a space.

- 6 Press the **Menu Select** button directly below **OPTN** once the message is composed.

- 7 **▶** or **◀** to **SEND** and press the **Menu Select** button directly below **SEND** to send.

OR

 - ▶** or **◀** to **BACK** and press the **Menu Select** button directly below **BACK** to return to Compose screen if you want to edit the message.

- 8 **▶** or **◀** to scroll through the address list and press the **Menu Select** button below **SEL** to select the required address.

OR

 - ▶** or **◀** to **[OTHER RECPNT]** and press the **Menu Select** button below **EDIT**.

A blinking cursor appears in the **ENTER ADDRESS** screen. Use the keypad to type the address entry.

 - Press **◀** to move one space to the left.
 - Press **▶** to move one space to the right.
 - Press the **Menu Select** button below **DEL** to delete any unwanted characters.
 - Press **(*)** to add a space.
 - Press **(0)** to toggle between mixed case mode, uppercase mode, and lowercase mode.
 - Press **(#)** to toggle between numeric and letter mode.

9 Press the **Menu Select** button below **SEND** to send the message.

OR

Press the **PTT** button to send the message.

10 The display shows the **SEND MESSAGE** screen and **SENDING MSG.**

11 If the message is sent, a tone sounds and the display shows **MSG SENT.**

OR

If the message is not sent, a low tone sounds and the display shows **SEND FAILED.**

If the message fails to send, the radio returns you to the main TMS screen.

Note: You can append a priority status and/or a request reply to your message. See **Using the Priority Status and Request Reply Features** on **page 67** for more information.

Note: You can also select the **DRFT** option to save your message in the Drafts folder to send it at a later time. See **Accessing the Drafts Folder** on **page 71** for more details.

Sending a Quick Text Message

Quick Text messages are messages that are predefined and usually consist of messages that are used most frequently.

Each Quick Text message has a **maximum** length of 50 characters.

Procedure:

Press the preprogrammed **Quick Text** button and proceed to Step 3.

OR



Follow the procedure below.

1  or  to **TMS.**

2 Press the **Menu Select** button directly below **TMS** to access the TMS feature screen.

3 Press the **Menu Select** button directly below **COMP** to access the compose options.

4  or  to **LIST.**

5  or  to scroll through the list of messages and press the **Menu Select** button directly below **SEL** to select the required message.

6 The message appears on the **Compose** screen, with a blinking cursor at the end of it.

Use the keypad to edit the message.

Press  to move one space to the left.

Press **▶** to move one space to the right.

Press the **Menu Select** button directly below **DEL** to delete any unwanted characters.

Press **(*)** to add a space.

Press **(0)** to toggle between mixed case mode, uppercase mode, and lowercase mode.

Press **(#)** to toggle between numeric and letter mode.

7 Press the **Menu Select** button directly below **OPTN**.

8 **▶** or **◀** to **SEND** and press the **Menu Select** button directly below **SEL** to send the message.

9 **▶** or **◀** to scroll through the address list and highlight the required address.

OR

▶ or **◀** to **[OTHER RECPNT]** and press the Menu Select button below **EDIT**.

A blinking cursor appears in the **ENTER ADDRESS** screen. Use the keypad to type the address entry.

Press **◀** to move one space to the left.

Press **▶** to move one space to the right.

Press the **Menu Select** button below **DEL** to delete any unwanted characters.

Press **(*)** to add a space.

Press **(0)** to toggle between mixed case mode, uppercase mode, and lowercase mode.

Press **(#)** to toggle between numeric and letter mode.

10 Press the **Menu Select** button below **SEND** to send the message.

OR

Press the **PTT** button to send the message.

11 The display shows the screen and **SENDING MSG**.

12 If the message is sent, a tone sounds and the display shows **MSG SENT**.

OR

If the message is not sent, a low tone sounds and the display shows **SEND FAILED**.

If the message fails to send, the radio returns you to the main TMS screen.

Note: You can append a priority status and/or a request reply to your message. See **Using the Priority Status and Request Reply Features** on **page 67** for more information.

Using the Priority Status and Request Reply Features

Before sending your message, you can append a priority message and/or a request reply to your message.

Appending or Removing a Priority Status to a Text Message

Note: The Priority Message icon on a message does not imply that the message gets higher priority over the other messages when it is being transmitted. It is just an indication that can be embedded into a message to let the receiver know that the message is important.

Procedure:

After the outgoing message is composed (see **Composing and Sending a New Text Message** on page 64 for more information):

- 1 Press the **Menu Select** button directly below **OPTN**.

- 2 Press the **Menu Select** button directly below **IMPT**.
The priority status icon appears beside the normal message icon on the label bar.

- 3 Press the **Menu Select** button directly below **IMPT** again.
The priority status icon and the normal message icon disappear from the label bar.

Appending or Removing a Request Reply to a Text Message

Procedure:

After the outgoing message is composed (see **Composing and Sending a New Text Message** on page 64 for more information):

- 1 Press the **Menu Select** button directly below **OPTN**.

- 2 Press the **Menu Select** button directly below **RQRP**.
The reply status icon appears beside the normal message icon on the label bar.

- 3 Press the **Menu Select** button directly below **RQRP** again.
The reply status icon and the normal message icon disappear from the label bar.

Appending a Priority Status and a Reply Request to a Text Message

Procedure:

After the outgoing message is composed (see **Composing and Sending a New Text Message** on page 64 for more information):

- 1 Press the **Menu Select** button directly below **OPTN**.

- 2 **▶** or **◀** to **IMPT** and press the **Menu Select** button directly below **IMPT** to indicate the message as important.
AND

▶ or ◀ to **RQRP** and press the **Menu Select** button directly below **RQRP** to request for a reply.

- 3 The priority status and reply status icons appear beside the normal message icon on the label bar.

Removing a Priority Status and a Reply Request from a Text Message

When an outgoing message is indicated with priority status and reply status icons, follow the procedure below to remove these indicators.

Procedure:

- 1 Press the **Menu Select** button directly below **OPTN**.
- 2 ▶ or ◀ to **IMPT** and press the **Menu Select** button directly below **IMPT** to remove the priority status icon.
AND
▶ or ◀ to **RQRP** and press the **Menu Select** button directly below **RQRP** to remove the reply status icon.
- 3 The priority status, reply status and normal message icons disappear from the label bar.

Managing Text Messages

Receiving a Text Message

Note: When you receive a message that is flagged with the "Request Reply" icon, you must manually respond to the sender that you have received the message. The system will not automatically send back a notification that the radio has received such message.

Procedure:

When you receive a message, press and hold the preprogrammed **Data Feature** button or the **TMS Feature** button to access the Inbox and go to Step3.

OR

Follow the procedure below.

- 1 The new message icon appears and the display momentarily shows **NEW MSG**.
- 2 Press the **Menu Select** button directly below **TMS** to access the message.
- 3 The display shows alias or ID with the sender of the latest received message on top.

Viewing a Text Message from the Inbox

The Inbox can hold up to thirty (30) messages.

Note: ▶ or ◀ to read the message if fills more than one screen.

Procedure:

Press the preprogrammed **Data Feature** button or the **TMS Feature** button to access the TMS feature screen, and proceed to Step 3.

OR

Press and hold the preprogrammed **Data Feature** button or the **TMS Feature** button to access the Inbox screen and proceed to Step 4.

OR

Follow the procedure below.

- 1 ▶ or ◀ to **TMS**.

- 2 Press the **Menu Select** button directly below **TMS** to access the TMS feature screen.

- 3 Press the **Menu Select** button below **INBX** to view Inbox feature screen.

- 4 The display shows alias or IDs, with the sender of the latest received message.

*While on the review message screen, press the **Menu Select** button directly below **RPLY**, **DEL**, or **BACK** to access the option.*

- Select **RPLY** to reply the message.
- Select **DEL** to delete the message.
- Select **BACK** to return to the previous screen.

Note: The icon at the top right corner of the screen indicates the status of the message. See **Text Messaging Service (TMS)** on page 63 for more information.

Replying to a Received Text Message

Note: The original date and time stamp, address and message content is automatically appended to the reply message.

Procedure:

- 1 **▶** or **◀** to the required aliases or ID and press the **Menu Select** button below **SEL** to view the message.

- 2 Press the **Menu Select** button directly below **RPLY** to reply to a message.

- 3 **▶** or **◀** to **NEW** and press the **Menu Select** button directly below **NEW**.
OR
▶ or **◀** to **LIST** and press the **Menu Select** button directly below **LIST** for a predefined message.
OR
▶ or **◀** to scroll through the list of messages and press the **Menu Select** button directly below **SEL** to select the required message.

- 4 A blinking cursor appears on the screen.
OR
The predefined message appears on the **Compose** screen, with a blinking cursor at the end of it.

- 5 Use the keypad to type or edit your message.
Press **◀** to move one space to the left.

Press **▶** to move one space to the right.

Press the **Menu Select** button below **DEL** to delete any unwanted characters.

Press **(*)** to add a space.

Press **(0)** to toggle between mixed case mode, uppercase mode, and lowercase mode.

Press **(#)** to toggle between numeric and letter mode.

- 6 Press the **Menu Select** button directly below **OPTN** once you have finished writing the message.

- 7 **▶** or **◀** to **SEND** and press the **Menu Select** button directly below **SEND** to send the message.

- 8 The display shows the **Send Message** screen and **SENDING MSG**.



Press the **Menu Select** button directly below **BACK** at any time to return to the previous screen.

Note: You can append a priority message and/or a request reply to your message. **Using the Priority Status and Request Reply Features** on page 67 for more information.



Accessing the Drafts Folder

This folder stores the messages that were saved previously. The Drafts folder can hold up to 10 messages. The oldest draft in the folder is deleted when the 11th message comes in.

Procedure:

- 1  or  to **TMS**.

- 2 Press the **Menu Select** button directly below **TMS** to access the TMS feature screen.

- 3  or  to **DRFT** and press the **Menu Select** button below **DRFT**.

- 4 The display shows the first draft message.

Press the **Menu Select** button directly below **EDIT**, **DEL**, or **BACK** to access the option.

- Select **EDIT** to edit the message before sending it.
- Select **DEL** to delete the message.
- Select **BACK** to return to the previous screen.

Managing Sent Text Messages

Once a message is sent to another radio, it is saved in the Sent folder. The most recent sent text message is always added to the top of the Sent list.

The Sent folder is capable of storing a maximum of ten (10) last sent messages. When the folder is full, the oldest text message in the folder is deleted when the 11th message comes in.

Viewing a Sent Text Message



The icon at the top right corner of the screen indicates the status of the message. See **Text Messaging Service (TMS)** on page 63 for more information.

Procedure:



Press the preprogrammed **Data Feature** button or the **TMS Feature** button to access the TMS feature screen, and proceed to Step 3.

OR

Follow the procedure below.

- 1  or  to **TMS**.

- 2 Press the **Menu Select** button directly below **TMS** to access the TMS feature screen.

- 3  or  to **SENT** and press the **Menu Select** button below **SENT**.

Press the **Menu Select** button directly below **OPTN**, **DEL**, or **BACK** to access the option.

- Select **OPTN** to send to the message.
- Select **DEL** to delete the message.
- Select **BACK** to return to the previous screen.

Note: The icon at the top right corner of the screen indicates the status of the message. See **Text Messaging Service (TMS) Icons** on page 19 for more information.

Sending a Sent Text Message

Procedure:

- 1 Press the **Menu Select** button directly below **OPTN** while viewing the message.
- 2 **▶** or **◀** to **SEND** and press the **Menu Select** button directly below **SEND** to send the message.
- 3 **▶** or **◀** to scroll through the address list and highlight the required address.
OR
▶ or **◀** to **[OTHER RECPNT]** and press the **Menu Select** button below **EDIT**.
A blinking cursor appears in the **ENTER ADDRESS** screen.
Use the keypad to type the address entry.
Press **◀** to move one space to the left.

Press **▶** to move one space to the right.

Press the **Menu Select** button below **DEL** to delete any unwanted characters.

Press **(*)** to add a space.

Press **(0)** to toggle between mixed case mode, uppercase mode, and lowercase mode.

Press **(#)** to toggle between numeric and letter mode.



- 4 Press the **Menu Select** button below **SEND** or the **PTT** button to send the message.
- 5 The display shows the **Send Message** screen and **SENDING MSG**.
- 6 Press the **Menu Select** button directly below **BACK** to return to the previous screen.

Note: You can append a priority message and/or a request reply to your message. See **Using the Priority Status and Request Reply Features** on page 67 for more details.

Deleting Text Messages

Procedure:

From the Inbox, Draft, or Sent screen:

- 1  or  to scroll through the messages.

- 2 Press the **Menu Select** button directly below **DEL** to view the delete options.

- 3 Press the **Menu Select** button directly below **CURR** to delete the current message.
OR
Press the **Menu Select** button directly below **ALL** to delete all the messages.

■ Secure Operations

Secure radio operation provides the highest commercially available level of voice security on both trunked and conventional channels.

Unlike other forms of security, Motorola digital encryption provides signaling that makes it virtually impossible for others to decode any part of an encrypted message.

Managing Encryption

Note: Refer to the Key-Variable Loader (KVL) manual for equipment connections and setup.

Loading a Single Encryption Key



Procedure:

- 1 Attach the KVL to your radio. Upon attaching the KVL, the radio display shows **KEYLOADING**.

- 2 Press the **Menu Select** button below **TARGET**.

- 3 Press the **Menu Select** button below **LOAD**.

- 4 Press the **Menu Select** button below **KEY**.

- 5  or  to required key.

- 6 Press the **Menu Select** button below **LOAD** to load the key to your radio.

- 7 When the key has been loaded successfully, the radio sounds a short tone for single-key radios.

Loading the Group Encryption Keys

Procedure:

- 1 Attach the KVL to your radio.
- 2 Press the **Menu Select** button below **TARGET**.
- 3 Press the **Menu Select** button below **LOAD**.
- 4 Press the **Menu Select** button below **GROUP**.
- 5 **▶** or **◀** to required group.
- 6 Press the **Menu Select** button below **LOAD** to load the key to your radio.
- 7 Your mobile radio display shows **KEYLOADING** when it is loading key(s) from KVL.
- 8 When the key has been loaded successfully, the radio sounds an alternating tone for multikey radios.

Using the Multikey Feature

This feature allows the radio to be equipped with different encryption keys and supports the DES-OFB algorithm.

There are two types of multikey:

- **Conventional Multikey** – The encryption keys can be tied (strapped), on a one-per-channel basis, through Customer Programming Software. In addition, you can have operator-selectable keys, operator-selectable keysets, and operator-selectable key erasure. If talkgroups are enabled in conventional, then the encryption keys are strapped to the talkgroups.
- **Trunked Multikey** – If you use your radio for both conventional and trunked applications, you have to strap your encryption keys for trunking on a per-talkgroup or announcement-group basis. In addition, you may strap a different key to other features, such as dynamic regrouping, failsft, or emergency talkgroup. You can have operator-selectable key erasure.

Selecting an Encryption Key (Conventional Only)

Procedure:

- 1 **▶** or **◀** to **KEY**.

- 2 Press the **Menu Select** button directly below **KEY**. The display shows the last user-selected and stored encryption key, and the available menu selections.

- 3 **▶** or **◀** to scroll through the encryption keys.
OR
Use the keypad to enter the number of the desired key.

- 4 Press the **Menu Select** button directly below **SEL** to save the newly selected key and return to the Home screen.
OR
Press , the **PTT** button, or the **Menu Select** button directly below **EXIT** to exit.

Note: If the selected key is erased, a momentary keyfail tone sounds and the display shows **KEY FAIL**.
OR
If the selected key is not allowed, a momentary illegal key tone sounds and the display shows **ILLEGAL KEY**.

Enabling Secure Transmission

Procedure:

- 1 **▶** or **◀** to **SEC** and press the **Menu Select** button directly below **SEC**. The display shows  and the current key if multi-key has been enabled.

- 2 Monitor the mode to be sure it is not in use.

- 3 Press **PTT** button to transmit.

Note: If the selected channel is preprogrammed for clear-only operation – when you press the **PTT** button, an invalid mode tone sounds and the display shows **CLEAR TX** only.

The radio does not transmit until you disable the secure mode.

Accessing the Secure Feature

Procedure:

- 1 **▶** or **◀** to **SEC**.

- 2 Press and hold the **Menu Select** button directly below **SEC** to display Secure feature screen.

- 3 The display shows the **Secure** screen.

Selecting a Keyset





This feature allows you to select one or more groups of several encryption keys from among the available keys stored in the radio.

For example, you could have a group of three keys structured to one keyset, and another group of three different keys structured to another keyset; by changing keysets, you would automatically switch from one set of keys to the other.

Every channel to which one of the original keys was tied now has the equivalent new key instead.

Note: Press , the **PTT** button, or the **EXIT** menu selection to exit this menu at any time without changing the keyset selection.

Procedure:





- 1  or  to **KSET**.
- 2 Press the **Menu Select** button directly below **KSET**. The display shows the last user-selected and stored keyset, and the available keyset menu selections.
- 3  or  to scroll through the keysets.
OR
Use the keypad to enter the number of the desired keyset.
- 4 Press the **Menu Select** button directly below **SEL** to save the newly selected keyset.

- 5 The radio exits keyset selection and returns to the Home screen.

Erasing the Selected Encryption Keys

This feature allows you to erase all or selected encryption keys.

Procedure:

- 1  or  to **ERAS**.
- 2 Press the **Menu Select** button directly below **ERAS**. The display shows the last user-selected and stored encryption key, and the available menu selections.
- 3  or  to the desired encryption key.
OR
Use the keypad to enter the number of the desired key.
- 4 Press the **Menu Select** button directly below **ALL** to delete all keys.
OR
Press the **Menu Select** button directly below **SNGL** to delete current shown key.
OR
Press the **Menu Select** button directly below **ABRT** to abort this screen and return to Home screen.

Requesting an Over-the-Air Rekey

This feature, also known as **OTAR**, allows the dispatcher to reprogram the encryption keys in the radio remotely. The dispatcher performs the rekey operation upon receiving a rekey request from the user.

Procedure:

- 1 **▶** or **◀** to **REKY**.

- 2 Press the **Menu Select** button directly below **REKY**.

- 3 Press the **PTT** button to send the rekey request.
OR
Press the **PTT** button again, or the **📡** or **Emergency** button, to exit the feature and transmit in normal mode.

- 4 If the rekey operation fails, a bad-key tone sounds and the display shows **REKEY FAIL**.

Note: The rekey operation failure indicates that your radio does not contain the Unique Shadow Key (USK). This key must be loaded into the radio with the key-variable loader (KVL) before the rekey request can be sent.

Refer to your local key management supervisor for more information.

MDC Over-the-Air Rekeying (OTAR) Page

This feature allows to view or define MDC Over-the-Air Rekeying (OTAR) features. It is applied only when operating in secure encrypted mode and only for conventional communications. In addition to Rekey Requests, OTAR transmissions include Delayed Acknowledgements, and Power-up Acknowledgements.

Some of the options selected may also need to be set up at the Key Management Controller (KMC) site to work properly.

Note: This feature must be preprogrammed by a qualified radio technician. Check with your dealer or system administrator for more information.

Hear Clear

There are two components of Hear Clear.

1 Companding:

Reduces the channel noise, e.g. OTA transmission, that is predominantly present in UHF2 and 900 MHz channel with the following features.

- **Compressor** – reduces the background noise flow and the speech signal at transmitting radio.
- **Expander** – expands the speech while the noise flow remains the same at receiving radio.

2 Random FM Noise Canceller (Flutter Fighter):

Reduces the unwanted effects of random FM noise pulses caused by channel fading under high Signal-to-Noise (S/N) conditions such as in a moving in a transportation. The fading effects, heard as audio pops and clicks, are cancelled without affecting the desired audio signal.

The Random FM Noise Canceller operates only in receive mode.

Note: This feature must be preprogrammed by a qualified radio technician. Check with your dealer or system administrator for more information.

The Global Positioning System (GPS)

This feature uses information from the Global Positioning System (GPS) satellites orbiting the Earth to determine the approximate geographical location of your radio, expressed as latitude and longitude. The availability and accuracy of this location information (and the amount of time that it takes to calculate it) varies depending on the environment in which you are using the GPS feature.

For example, GPS location fixes are very difficult to obtain indoors, in covered locations, between high buildings, or in situations where you have not established a clear broad view of the sky.

Understanding the GPS Feature

The GPS technology uses radio signals from earth orbiting satellites, to establish the location co-ordinates, maximizing your view of clear unobstructed sky is essential for optimum performance.

Where adequate signals from multiple satellites are not available (usually because you cannot establish a view of a wide area of the sky), the GPS feature of your radio will not work. Such situations include but are not limited to:

- In underground locations
- Inside of buildings, trains, or other covered vehicles

- Under any other metal or concrete roof or structure
- Between tall buildings or under dense tree-cover
- In temperature extremes outside the operating limits of your radio

Even where location information can be calculated in such situations, it may take longer to do so, and your location estimate may not be as accurate. Therefore, in any emergency situation, always report your location to your dispatcher.

Note: Even where adequate signals from multiple satellites are available, your GPS feature only provides an approximate location, usually within 20 meters from your actual location, but sometimes further away.

Keep in mind that the accuracy of the location information and the time it takes to obtain it varies depending upon circumstances, particularly the ability to receive signals from an adequate number of satellites.

Note: The satellites used by the GPS feature are controlled by the U.S. government and are subject to changes implemented in accordance with the Department of Defense GPS user policy and the Federal Radio Navigation Plan. These changes may affect the performance of the GPS feature on your radio.

Enhancing GPS Performance

Sometimes, the GPS feature may be unable to complete a location calculation successfully. You then see a message indicating that your radio cannot connect to enough visible satellites.

To maximize the ability of your radio to determine a fix, please note the following guidelines:

- For your initial fix, hold the radio in the face position.
- Stay in the open. The GPS feature works best where there is nothing between your radio and a large amount of open sky.

The Outdoor Location Feature (Using GPS)

This feature allows you to determine your current location using a location menu, as well as your current distance and bearing in relation to another location. Radio location may be requested and reported over-the-air.

Your radio stores up to a maximum of sixty (60) programmable location coordinates, also known as waypoints. When the memory is full, the next waypoints automatically replaces the oldest waypoints in the radio.

The radio also stores four (4) preprogrammed waypoints. These coordinates cannot be deleted.



Programmable Waypoints	Preprogrammed Waypoints
User-configurable location coordinates.	Fixed location coordinates: <ul style="list-style-type: none"> • Home • Emergency • Last Known Location • Destination
Only the alias is editable, not the coordinates.	The Home and Destination coordinates are editable.
Coordinates can be deleted one at a time, or all at once.	Coordinates cannot be deleted.

Note: If the feature inactivity timer is enabled, your radio automatically exits the feature when your radio is left idle long enough for the time to expire. You will hear the Menu Inactive Exit Tone upon feature exit.

Accessing the Outdoor Location Feature



Note: An **ON** menu key may be present on the location menu if it is preprogrammed by the dealer or system administrator.

Procedure:

- 1  or  to **LOC**.

- 2 Press the **Menu Select** button directly below **LOC**. The display shows **LOCATION OFF <LATITUDE>**.

- 3 Press the **Menu Select** button directly below **ON** to turn on the GPS. The display shows **PREVIOUS LOC <LATITUDE>**.

- 4  or  to check the longitude, time and date of the last successful location fix.

- 5 Press the **Menu Select** button directly below **RFSH** to obtain a new location fix.

- 6 The top line temporarily displays **PLEASE WAIT** while the new location is being determined. While the new location is being determined, the location signal can be a solid or blinking icon.

- 7 Once the location coordinates are fixed, the display shows the current latitude. Toggle to see the longitude, time and date. The location coordinates are updated automatically every five seconds while the location signal is present.



- 8 Press the **Menu Select** button directly below **EXIT** to exit the feature and return to the main screen.

OR



Press  or the **PTT** button (if preprogrammed) to exit this menu.

OR



Follow the procedure below to turn off the GPS (This feature is enabled by a qualified radio technician.):

- 1  or  to **LOC**.

 - 2 Press the **Menu Select** button directly below **LOC**. The display shows **PREVIOUS LOC <LATITUDE>**.

 - 3  or  to check the longitude, time and date of the last successful location fix.

 - 4 Press the **Menu Select** button directly below **OPTN**.

 - 5  or  to **TURN OFF GPS** (if preprogrammed).

 - 6 Press the **Menu Select** button directly below **SEL** to turn off the GPS. The display shows **LOCATION OFF**.

 - 7 Press the **Menu Select** button directly below **EXIT** to exit the feature and return to the main screen.
- OR**
- Press  or the **PTT** button (if preprogrammed) to exit this menu.
-







The radio also exits the menu if the emergency button is pressed.





Saving a Waypoint

Procedure:

While in the current location display:

- 1 Press the **Menu Select** button directly below **OPTN**.

- 2  or  to **SAVE AS WAYPT** and press the **Menu Select** button directly below **SEL**.
OR
 or  to **SAVE AS HOME** and press the **Menu Select** button directly below **SEL** and proceed to Step 5.
OR
 or  to **SAVE AS DEST.** and press the **Menu Select** button directly below **SEL** and proceed to Step 5.

- 3 A blinking cursor appears in the screen. Use the keypad to type the alias via multi-tap.
Press  to move one space to the left.
Press  to move one space to the right.
Press the **Menu Select** button below **DEL** to delete any unwanted characters.
Press  to add a space.
Press  to toggle between mixed case mode, uppercase mode, and lowercase mode.
Press  to toggle between numeric and letter mode.

- 4 Press the **Menu Select** button directly below **OK** once you are done.

- 5 The display shows **SAVED AS <WAYPOINT NAME>**.
OR
The display shows **SAVED AS HOME**.
OR
The display shows **SAVED AS DEST..**

- 6 Press **⏠** or the **PTT** button (if preprogrammed) to exit this menu.

Viewing a Saved Waypoint

Procedure:

While in the current location display:

- 1 Press the **Menu Select** button directly below **OPTN**.

- 2 **▶** or **◀** to **WAYPOINTS**.

- 3 Press the **Menu Select** button directly below **SEL**.

- 4 **▶** or **◀** to desired waypoint.

- 5 Press the **Menu Select** button directly below **OPTN**. The display shows **VIEW**.

- 6 Press the **Menu Select** button directly below **SEL**.

- 7 **▶** or **◀** again to view longitude, time and date the waypoint was detected.

- 8 Press the **Menu Select** button directly below **BACK** to return to previous Waypoint screen.
OR
Press **⏠** or the **PTT** button (if preprogrammed) to exit this menu.

Editing the Alias of a Waypoint

Procedure:

While in the current location display:

- 1 Press the **Menu Select** button directly below **OPTN**.

 - 2 **▶** or **◀** to **WAYPOINTS**.

 - 3 Press the **Menu Select** button directly below **SEL**.

 - 4 **▶** or **◀** to desired waypoints.

 - 5 Press the **Menu Select** button directly below **OPTN**.

 - 6 **▶** or **◀** to **EDIT NAME** and press the **Menu Select** button directly below **SEL**.

 - 7 A blinking cursor appears in the **Edit Name** screen. Use the keypad to edit the alias.
 - Press **◀** to move one space to the left.
 - Press **▶** to move one space to the right.
 - Press the **Menu Select** button below **DEL** to delete any unwanted characters.
 - Press **(*)** to add a space.
 - Press **(0)** to toggle between mixed case mode, uppercase mode, and lowercase mode.
 - Press **(#)** to toggle between numeric and letter mode.

 - 8 Press the **Menu Select** button directly below **OK** once you are done.
- OR**

Press the **Menu Select** button directly below **CNCL** to return to the Waypoints main screen.

- 9 The display shows **<WAYPOINT NAME> UPDATED**.

- 10 Press **⏠** or the **PTT** button (if preprogrammed) to exit this menu.

Editing the Coordinates of a Waypoint

Procedure:

While in the current location display:

- 1 Press the **Menu Select** button directly below **OPTN**.

- 2 **▶** or **◀** to **WAYPOINTS** and press the **Menu Select** button directly below **SEL**.

- 3 **▶** or **◀** to desired waypoints.

- 4 Press the **Menu Select** button directly below **OPTN**.

- 5 **▶** or **◀** to **EDIT LOCATION** and press the **Menu Select** button directly below **SEL**.

- 6 The first number blinks.
 - Press **◀** to move to the previous number/coordinates.
 - Press **▶** to move to the next number/coordinates.
 - Press **▲** or **▼** to change the North (N), South (S), East (E) or West (W) direction.

Press the **Menu Select** button below **EDIT** to change the number/coordinates.

7 A blinking cursor appears in the **EDIT LOCATION** screen.

Press **←** to move one space to the left.

Press **→** to move one space to the right.

Press the **Menu Select** button below **Del** to delete any unwanted characters.

8 Press the **Menu Select** button directly below **OK** once you are done.

OR

Press the **Menu Select** button directly below **CNCL** to return to the previous screen.

9 Press the **Menu Select** button directly below **OK** once you are done with the new coordinates.

OR

Press the **Menu Select** button directly below **CNCL** to return to the previous screen then skip to step 11.

10 The display shows **[HOME] UPDATED** and the radio returns to the Waypoints main screen.

OR

The display shows **[DESTINATION] UPDATED** and the radio returns to the Waypoints main screen.

11 Press **⏠** or the **PTT** button (if preprogrammed) to exit this menu.

Deleting a Single Saved Waypoint

Procedure:

While in the current location display:

1 Press the **Menu Select** button directly below **OPTN**.

2 **→** or **←** to **WAYPOINTS**.

3 Press the **Menu Select** button directly below **SEL**.

4 **→** or **←** to desired waypoints.

5 Press the **Menu Select** button directly below **OPTN**.

OR

Press the **Menu Select** button directly below **DEL** and then skip to step 7.

6 **→** or **←** to **DELETE** and press the **Menu Select** button directly below **SEL**.

7 The display shows **<WAYPOINT NAME> CONFIRM DEL?**.

8 Press the **Menu Select** button directly below **YES** to delete. The display shows **<WAYPOINT NAME> DELETED**.

OR

Press the **Menu Select** button directly below **NO** to return to previous Waypoint screen.

9 Press **⏠** or the **PTT** button (if preprogrammed) to exit this menu.

Deleting All Saved Waypoints

Procedure:

- 1** Press the **Menu Select** button directly below **OPTN**.

- 2** **▶** or **◀** to **WAYPOINTS** and press the **Menu Select** button directly below **SEL**.

- 3** **▶** or **◀** to desired waypoints and press the **Menu Select** button directly below **OPTN**.

- 4** **▶** or **◀** to **DELETE ALL** and press the **Menu Select** button directly below **SEL**.

- 5** The display shows **ALL SAVED WAYP CONFIRM DEL?**.

- 6** Press the **Menu Select** button directly below **YES** to delete. The display shows **ALL SAVED WAYP DELETED**.
OR
Press the **Menu Select** button directly below **NO** to return to previous Waypoint screen.

- 7** Press **⏠** or the **PTT** button (if preprogrammed) to exit this menu.

Measuring the Distance and Bearing from a Saved Waypoint

Procedure:

While in the current location display:

- 1** Press the **Menu Select** button directly below **OPTN**.

- 2** **▶** or **◀** to **DIST FRM HERE** and press the **Menu Select** button directly below **SEL**.

- 3** **▶** or **◀** to the required waypoint, and press the **Menu Select** button directly below **SEL**.

- 4** The display shows the distance and bearing from the current to the selected coordinates.

- 5** Press the **Menu Select** button directly below **BACK** to return to the previous Waypoint screen.
OR
Press **⏠** or the **PTT** button (if preprogrammed) to exit this menu.

Using the Location Feature While in Emergency Mode

When the Emergency feature is activated by pressing the emergency button, the radio exits the Location menu and returns to the home (default) display so that you can see which channel the emergency signal is going out on.

However, you may re-enter the Location menu while still in emergency mode, provided that Silent Emergency has not been activated.

If you have turned Location off using the **ON/OFF** menu key, it automatically turns back on when Emergency is activated.

If there is a solid location signal during Emergency, the current location and the location information received is saved as Emergency and Last Known Location waypoints, respectively.

■ Trunking System Controls

Using the Failsoft System

The failsoft system ensures continuous radio communications during a trunked system failure. If a trunking system fails completely, the radio goes into failsoft operation and automatically switches to its failsoft channel.

The failsoft condition is indicated by a faint beeping tone every nine seconds (radio unsquelched) until the trunking system returns to normal operation.

To continue, in Failsoft, to communicate with other talkgroups, refer to the following procedure.

Procedure:

- 1 Rotate the **Mode Knob** to change to a different repeater frequency.
 - 2 Press the **PTT** button to talk, and release the button to listen.
-

When the trunking system returns to normal operation, your radio automatically leaves failsoft operation and returns to trunked operation.

Going Out-of-Range

OUT OF RANGE when your radio goes out of the range of the system, it can no longer lock onto a control channel.

Procedure:

- 1 A low-pitched tone sounds.

AND/OR

The display shows the currently selected zone/channel combination and **OUT OF RANGE**.

- 2 Your radio remains in this out-of-range condition until:
It locks onto a control channel.

OR

It locks onto a failsoft channel.

OR

It is turned off.

SmartZone®

The SmartZone® feature extends communications beyond the reach of a single-trunked site (antenna location) when operating in a SmartZone system. SmartZone units provide expanded wide-area coverage.

SmartZone automatically switches the radio to a different site when the current site signal becomes unacceptable. This usually happens when the vehicle in which the radio is located is driven out of the range of one site, and into the range of another.

Under normal conditions, a SmartZone-enabled radio functions invisibly to the operator. However, the operator does have some manual controls on the Control Head – the **RSSI** menu entry. This button can be used to check, or change, the SmartZone operation.

Using Site Trunking Feature

If the zone controller loses communication with any site, that site reverts to site trunking.

The display shows the currently selected zone/channel combination and **SITE TRUNKING**.

Note: When this occurs, you can communicate only with other radios within your trunking site.

Locking and Unlocking a Site



This feature allows your radio to lock onto a specific site and not roam among wide-area talkgroup sites. This feature should be used with caution, since it inhibits roaming to another site in a wide-area system.

Procedure:

Use the preprogrammed **Site Lock/Unlock** button to toggle the lock state between locked and unlocked.

OR

Follow the procedure below.

- 1  or  to **SITE**.

- 2 Press the **Menu Select** button directly below **SITE**.

- 3 Press the **Menu Select** button directly below **LOCK** to lock the site.
OR
Press the **Menu Select** button directly below **UNLK** to unlock the site.



- 4 The radio saves the new site lock state and returns to the Home screen.

Viewing and Changing a Site

This feature allows you to view the number of the current site or force your radio to change to a new one.

Viewing the Current Site

Procedure:

- 1 Press the preprogrammed **Site Search** button.
OR
 or  to **RSSI**.

- 2 The display momentarily shows the name of the current site and its corresponding received signal strength indicator (RSSI).

Changing the Current Site

Procedure:

- 1 Press and hold down the preprogrammed **Site Search** button.
OR
Press and hold down the **Menu Select** button directly below **RSSI**.

- 2 A tone sounds and the display momentarily shows **SCANNING SITE**.

When the radio finds a new site, it returns to the Home screen.

Trunked Announcement

The announcement capability allows you to make announcements to the entire user group, as well as monitor talkgroup calls and other announcements.

Announcement calls are handled in two different ways, depending on the trunked central controller configuration. The two types are called *ruthless* and *non-ruthless* preemption.

- **Ruthless Preemption:**

When a ruthless preemption announcement call is initiated, the requesting radio begins transmitting immediately. All associated talkgroup calls taking place on other channels are immediately halted, and the radios are steered to the announcement call.

Transmitting radios continue to transmit until the **PTT** button is released, at which time they also unmute for the announcement call. Individual calls (Private Conversation and telephone interconnect) are not affected.

- **Non-Ruthless Preemption:**

When a non-ruthless preemption announcement is initiated, the initiating unit receives a telephone-type busy tone, followed by a call back when all associated talkgroup conversations end.

Once an announcement call is pending, any attempts by other users to initiate a talkgroup call will result in a telephone-type busy tone. These users will not receive a call back until the announcement call is complete.

Initiating an Announcement

If your radio has been programmed to allow announcement calls:

Procedure:

- 1 Press the **Mode Knob** to locate the announcement-group mode.
- 2 Press the microphone **PTT** button to initiate the announcement.

■ Ignition Switch Options

This feature allows the user to select the radio's functionality based on the Ignition State of the radio user's vehicle. The available options are as follows.

Blank

This option allows the user to power on and power off the radio through the **Power** button regardless of the Ignition's current state.

Tx Inhibit

This option allows the user to power on and power off the radio through the **Power** button regardless of the Ignition's current state. In addition, if the Ignition is not present, then all transmissions are inhibited. This includes receiving any Trunking dispatch communications since the radio will not affiliate with the Trunking systems.

PTT Tx Inhibit

This option allows the user to power on and power off the radio through the **Power** button regardless of the Ignition's current state. In addition, if the Ignition is not present, then all **PTT** button transmissions are inhibited. However, the radio is able to affiliate with the Trunking systems.

Required

This option allows the user to power on the radio only if the Ignition is present. The radio can be powered off either through **Power** button press or when Ignition is lost. In addition, the radio automatically powers on when the Ignition is present only if the radio was turned off due to the ignition being removed.

This option allows the radio to power off when Inactivity Auto Power Off Timer expires, or, when Ignition Auto Power Off Timer expires.

Soft Power Off

This option allows the user to power on the radio either through **Power** button presses or when the Ignition is detected. Meanwhile, if the **Power** button was pressed or the Ignition was removed, the radio will be turned off.

This option allows the radio to power off when Inactivity Auto Power Off Timer expires, or, when Ignition Auto Power Off Timer expires.

Ignition Only Power Up

This option allows the user to power on the radio only when Ignition is detected and will power off when it is removed. The radio does not power on or off with the **Power** button press.

This option allows the radio to power off when Inactivity Auto Power Off Timer expires, or, when Ignition Auto Power Off Timer expires.

Note: While "Ignition" is not present, the radio powers-off with a radio-user Power Off button / knob selection if the radio was powered-up with an Emergency Power Up footswitch-press or Ignition Auto Power Off timer is running.
While "Ignition" is present, the radio powers-on with a radio-user Power On button / knob selection only if the radio was powered-down with Inactivity Auto Power Off timer.

Emergency Power Up

This feature allows the user to power on the radio and automatically transmits an emergency mode transmission on personalities with emergency enabled, with the use of a footswitch. In addition, when the Ignition Switch option is set to either Tx Inhibit or PTT Tx Inhibit, this feature will not be available to the users.

Press the footswitch to turn on the radio and launch Emergency. A tone sounds and the display shows **Emergency**.

Auto Power Off Timer

Auto Power Off feature powers off the radio when no user actions occur during a preprogrammed length of time. There are two different versions of Auto Power Off:

Inactivity Auto Power Off Timer – This timer begins once the radio is power-on. While the timer is active any user interaction with the radio resets the timer.

Ignition Auto Power Off Timer – This timer begins once the vehicle key is removed, when the voltage at the ignition sense is removed. While the timer is active any user interaction with the radio resets the timer. When the vehicle key is reapplied, the voltage at the ignition is reconnected, this timer is stopped.

Although both Inactivity Auto Power Off and Ignition Auto Power Off can be enabled together, Ignition Auto Power Off timer is mutually exclusive with Inactivity Auto Power Off timer when both are enabled.

During the last two minutes of the timer countdown, the radio generates continuous low tone and blinks **POWERING OFF** warning on the display until the timer expires or is reset. The radio automatically powers off after the timer expires. The duration of the timer is preprogrammed.

Utilities



Viewing Recent Calls List

This feature allows you to view the recent incoming and outgoing call information of the following call types:



- Call Alert
- Selective Call
- Private Call
- Phone Call (Outgoing only)

Note: The radio can also be preprogrammed to log the radio IDs associated with incoming Dispatch Calls. Check with your dealer or system administrator for more information.

Procedure:

- 1  or  to **RCNT**.

- 2 Press the **Menu Select** button directly below **RCNT** to access the **Recent Calls** feature screen.

- 3  or  to scroll through the list.

- 4 Press the **Menu Select** button directly below **BACK** to return to Home screen.
OR
Press  or the **PTT** button to return to the Home screen.

If the feature inactivity timer is enabled, your radio automatically exits the feature when your radio is left idle long enough for the time to expire. You will hear the Menu Inactive Exit Tone upon feature exit.

Selecting the Power Level

You can select the power level at which your radio transmits. The radio always turns on to the default setting.

Note: This feature must be preprogrammed by a qualified radio technician.

Settings:

- Select **LOW** for a shorter transmitting distance and to conserve power.
- Select **HIGH** for a longer transmitting distance.

Procedure:

Use the preprogrammed **Transmit Power Level Switch** to toggle transmit power level between high and low.

OR

Follow the procedure below.

- 1  or  to **PWR**.
- 2 Press the **Menu Select** button directly below **PWR**.

- 3 The display shows **LOW POWER** and the low power icon.
OR
The display shows **HIGH POWER** and the high power icon.

Selecting a Radio Profile

This feature allows you to manually switch the visual and audio settings of the radio. The display, backlight, alert tones, and audio settings are defined according to the preprogrammed radio settings of each radio profile.





Please refer to a qualified technician for more information.

Note: If the feature inactivity timer is enabled, your radio automatically exits the feature when your radio is left idle long enough for the time to expire. You will hear the Menu Inactive Exit Tone upon feature exit.

Procedure:

Use the preprogrammed **Profile** button and proceed to Step 3.
OR

Follow the procedure below.

- 1  or  to **PRFL**.
- 2 Press the **Menu Select** button directly below **PRFL** to access the **Profiles** feature screen.
- 3  or  to scroll through the menu selections.
- 4 Press the **Menu Select** button directly below **SEL** to select the required radio profile.

OR

Press the **Menu Select** button directly below **EXIT** to exit the screen without making any changes.

- 5** The radio returns to the Home screen. The profile name on the Home screen indicates the current selected radio profile.
-

Controlling the Display Backlight

You can enable or disable the radio's display backlight as needed, if poor light conditions make the display difficult to read.

Depending on how your radio is preprogrammed, you can also maintain a minimum backlight level on the radio's display.

Procedure:

Note: Press the **DIM** button to toggle the backlight on or off.

OR

Press any key of the keypad, the **Menu Select** or **Menu Navigation** buttons, or any programmable radio controls or buttons to turn the backlight on.

Turning Keypad Tones On or Off



You can enable and disable keypad tones as needed.

Procedure:

Press the preprogrammed **Keypad Mute** button to turn the tones on or off.

OR

Follow the procedure below.

- 1**  or  to **MUTE**.
- 2** Press the **Menu Select** button directly below **MUTE**.
- 3** The display momentarily shows **TONES OFF**, indicating that the keypad tones are disabled.

OR

The display momentarily shows **TONES ON**, and a short tone sounds, indicating that the keypad tones are enabled.

Turning Voice Mute On or Off

You can enable and disable voice muting of the affiliated trunking talkgroup or selected conventional channel as needed.

Procedure:

Press the preprogrammed Voice Mute button to turn the feature on or off.

OR

Follow the procedure below.

- 1 **▶** or **◀** to **VMUT**.
- 2 Press the **Menu Select** button directly below **VMUT**.
- 3 The display momentarily shows **VOICE MUTE OFF**, and a short tone sounds, indicating that the feature is disabled.

OR

The display momentarily shows **VOICE MUTE ON**, and a short tone sounds, indicating that the feature is enabled.

Using the Time-Out Timer

This feature turns off your radio's transmitter. You cannot transmit longer than the preset timer setting.

If you attempt to do so, the radio automatically stops your transmission, and you hear a talk-prohibit tone.

The timer is defaulted at 60 seconds, but it can be preprogrammed from 3 to 120 seconds, in 15-second intervals, or it can be disabled entirely for each radio mode, by a qualified radio technician.

Note: You will hear a brief, low-pitched, warning tone four seconds before the transmission times out.

Procedure:

- 1 Hold down the **PTT** button longer than the preprogrammed time. You hear a short, low-pitched warning tone, the transmission is cut-off, and the LEDs goes out until you release the **PTT** button.
- 2 Release the **PTT** button. The LEDs relight and the timer resets.
- 3 Press the **PTT** button to re-transmit. The time-out timer restarts and the red LED lights up.

Using the Conventional Squelch Operation Features

This feature filters out unwanted calls with low signal strength or channels that have a higher than normal background noise.

1 Procedure:

▶ or ◀ to **SQL**.

2 Press the **Menu Select** button directly below **SQL**.

The display shows **SQUELCH XX**, where **XX** is the value for the current squelch.

3 Press the **Menu Select** button directly below “+” to increase the squelch volume.

OR

Press the **Menu Select** button directly below “-” to decrease the squelch volume.

4 Press **⏠** to return to the selected channel.

Analog Options

Tone Private Line (PL), Digital Private-Line (DPL), and carrier squelch can be available (preprogrammed) per channel.

Option	Result
Carrier squelch (C)	You hear all traffic on a channel.
PL or DPL	The radio responds only to your messages.

Digital Options

One or more of the following options may be preprogrammed in your radio. Consult your dealer or system administrator for more information.

Option	Result
Digital Carrier-Operated Squelch (COS)	You hear any digital traffic.
Normal Squelch	You hear any digital traffic having the correct network access code.
Selective Switch	You hear any digital traffic having the correct network access code and correct talkgroup.

Using the PL Defeat Feature

This feature allows you to override any coded squelch (DPL or PL) that might be preprogrammed to a channel. The radio also unmutes to any digital activity on a digital channel.

Procedure:

Place the preprogrammed **PL Defeat** switch in the PL Defeat position. You hear any activity on the channel.

OR

The radio is muted if no activity is present.

Note: When this feature is active, the Carrier Squelch status indicator is displayed.

Using the Digital PTT ID Feature

This feature allows you to the radio ID (number) of the radio from whom you are currently receiving a transmission. This ID, consisting up to a maximum of eight characters, can be viewed by both the receiving radio and the dispatcher.

Your radio's ID number is also automatically sent every time the PTT button is pressed. This is a per-channel feature. For digital voice transmissions, your radio's ID is sent continuously during the voice message.

Using the Smart PTT Feature (Conventional Only)

Smart **PTT** is a per-personality, programmable feature used in conventional radio systems to keep radio users from talking over other radio conversations.

When smart **PTT** is enabled in your radio, you cannot transmit on an active channel.

If you try to transmit on an active smart-**PTT** channel, you hear an alert tone, and the transmission is inhibited. The LED lights up solid yellow to indicate that the channel is busy.

Three variations of smart PTT are available:

Mode	Description
Transmit Inhibit on Busy Channel with Carrier	You cannot transmit if any traffic is detected on the channel.
Transmit Inhibit on Busy Channel with Wrong Squelch Code	You cannot transmit on an active channel with a squelch code or (if secure-equipped) encryption key other than your own. If the PL code is the same as yours, the transmission is not prevented.
Quick-Key Override	This feature can work in conjunction with either of the two above variations. You can override the transmit-inhibit state by quick-keying the radio. In other words, two PTT button presses within the preprogrammed time limit.

Accessing General Radio Information

Your radio contains information on the following:

- Radio Information
- IP Display
- Control Assignments

Note: If the feature inactivity timer is enabled, your radio automatically exits the feature when your radio is left idle long enough for the time to expire. You will hear the Menu Inactive Exit Tone upon feature exit.

Accessing Radio Information



This feature displays the following information of your radio:

- Host Version
- Secure Version
- CH 1 – 4 Version (depending on the number of channels connected.)
- TIB Version
- TRC Version
- URC Version
- DSP Version
- KG (Secure Algorithm)
- Serial Number
- MCHIB Version
- CHIB Version
- AUX CH Version
- Siren Version
- VRS Version
- DVRS App Version (only when DVRS is available)



- DVRS DSP Version (only when DVRS is available)
- Model Number
- ESN
- Flash Code
- Tuning Version
- DVRS CP Version (only when DVRS is available)
- Serial Number
- Flash Size & Type
- RF Band
- Processor Version

Note: Press  at any time to return to the Home screen.



Procedure:

- 1  or  to **INFO**.

 - 2 Press the **Menu Select** button directly below **INFO**.

 - 3  or  to **RADIO INFO** and press the **Menu Select** button directly below **SEL**.

 - 4 The display shows the Information screen.

 - 5  or  to scroll through the various information.
- OR**
Press the **Menu Select** button directly below **BACK** to return to previous screen.
- OR**
Press  to exit and return to the home display.
-

Viewing IP Information

This feature displays the device name, IP address, and status of your radio.



Note: The device name of your radio is preprogrammed. Check with your dealer or system administrator for more information.

Procedure:



Press the preprogrammed Info button and proceed to Step 3.



OR

Follow the procedure below.

- 1  or  to **INFO**.

- 2 Press the **Menu Select** button directly below **INFO**.

- 3  or  to **IP INFO** and press the **Menu Select** button directly below **SEL**.



- 4  or  to scroll through the various information.
OR
Press the **Menu Select** button directly below **BACK** to return to previous screen.
OR
Press  to exit and return to the Home display.

Viewing Control Assignments



This feature displays the programmable radio functions assigned to the controls of your radio for the currently selected channel.



See **Programmable Features** on page 7 for more information on the various programmable features of your radio.

Procedure:

- 1  or  to **INFO**.

- 2 Press the **Menu Select** button directly below **INFO**.

- 3  or  to **CONTROL MAP** and press the **Menu Select** button directly below **SEL**.

- 4  or  to scroll through the various information.
OR
Press the **Menu Select** button directly below **BACK** to return to previous screen.
OR
Press  to exit and return to the Home display.

Using Optional External Alarms (Horn and Lights)

All control heads can be equipped for external alarms (horn and lights) that are activated when a Call Alert page, Private Conversation call, or phone call is received.

The radio always powers up with the horn and lights feature enabled.

Note: The horn and lights feature must be enabled by a qualified radio technician.

Using Non-Permanent Horn and Lights

Procedure:

- 1 Press the **Menu Select** button directly below **H/L** momentarily. The last selected alarm(s) are enabled, and the display shows the enabled alarm(s) alternating with the selected mode, until it is turned off.
- 2 Press the **Menu Select** button directly below **H/L** momentarily to turn off the alarm(s). The display shows **HORN/LITES OFF**.

Using Permanent Horn and Lights

If Permanent Horn and Lights is enabled, horn and lights will automatically be turned on when the radio powers up.

Procedure:

- 1 Press the **Menu Select** button directly below **H/L** once to turn off the alarm(s).
- 2 Press the **Menu Select** button directly below **H/L** momentarily to enable the last selected alarm(s). The display briefly shows the enabled alarms, and then **reverts back to the selected mode**.

Changing the Selected Alarms

Procedure:

- 1 Press the **Menu Select** button directly below **H/L** until the display shows the required alarm.
- 2 Press the **Menu Select** button directly below the required entry and the display exits to Home screen.

Press the **Menu Select** button directly below the entry activates the option. Below are the selections available.

- Select **H+L** to turn on both horn and lights. The display shows **HORN/LITES ON**.
- Select **LGTS** to turn on the lights. The display shows **LIGHTS ON**.
- Select **HORN** to turn on the horn. The display shows **HORN ON**.

An **OFF** entry is shown at the softkey when one of the features above is active. Selecting the **OFF** deactivates the current active alarm.

Receiving a Call While Alarms are Turned On

When you receive a call with the Alarms turned on:

Procedure:

- 1 You hear the vehicle's horn sounds for four seconds, and/or the car lights turn on for 60 seconds.
- 2 The display shows the type of call received (**CALL**, **PAGE**, or **PHONE**) and the selected mode name.

The time interval can be modified by a qualified radio technician.

Turning Off Non-Rearmable External Alarms

Procedure:

- 1 Press the **Menu Select** button directly below **CALL**, **PAGE** or **PHON** will turn off the external alarm(s) and place you directly in that feature.
OR
Press the **PTT** button or any control-head button to turn off the external alarm(s).
- 2 Press the **Menu Select** button directly below **H/L** momentarily to rearm the horn and lights feature.

The **Volume Knob** and the **DIM** button have no effect on the state of the external alarm(s).

Turning Off Rearmable External Alarms

Procedure:

- 1 Press the **Menu Select** button directly below **CALL**, **PAGE** or **PHON** to turn off the external alarm(s) and place you directly in that feature.

The external alarm(s) is turned off and automatically rearmmed so that when you exit the entry, the external alarm(s) will automatically turn on.

OR

Press the **PTT** button or any control head button other than the **Menu Select** button directly below **H/L** to turn off the external alarm(s).

The external alarm(s) is turned off and automatically rearmmed so that when you exit the entry, the external alarm(s) will automatically turn on.

OR

Press the **Menu Select** button directly below **H/L** to turn off the external alarm(s) and exit the Horn and Lights feature.

Press the **Menu Select** button directly below **H/L** momentarily to rearm the horn and lights feature.

*The **Volume knob** and the **DIM** button have no effect on the state of the external alarms.*

Using the Voice Announcement

This feature enables the radio to audibly indicate the current feature mode, Zone or Channel the user has just assigned. This audio indicator can be customized per customer requirements. This is typically useful when the user is in a difficult condition to read the content shown on the display.

Each voice announcement is within a limit of three seconds maximum. The sum total duration for all voice announcements in a radio shall be no more than 1000 seconds.

Note: This feature must be preprogrammed by a qualified radio technician.

The features which Voice Announcement supports are:

- Zone
- Channel
- Scan
- Monitor
- Talkaround/Direct
- Tx Inhibit

Note: Voice announcements support certain number of zone-channel, but not all.

Seek advice from your dealer or qualified technician for the best selections for this feature.

The two options of priority for the Voice Announcement available are:

- **High** – enables the voice of the feature to announce even when the radio is receiving calls.
- **Low** – disables the voice of the feature from announcing when the radio is receiving calls.

Procedure:

You hear a voice announcement when the features below are preprogrammed in the radio.

- The radio powers up. The radio announces the current zone and channel it is transmitting.
- Press the preprogrammed voice announcement button (which specifically programmed to playback the current zone and channel). The radio announces the current zone and channel it is transmitting.

Note: Pressing this preprogrammed playback button will always enable the voice feature to announce in High priority.

All the three programmable buttons at the side of the radio support this feature.

- Change to a new zone. The radio announces the current zone and channel it is transmitting.
- Change to a new channel within the current zone. The radio announces the current channel.

- Press either the **Menu Select** button or preprogrammed button of the radio to launch or terminate Scan, Monitor, Talkaround/Direct or Transmit Inhibit. The radio announces the corresponding feature activation or deactivation.

Helpful Tips

The following are suggestions to assist you in troubleshooting possible operating problems.



Caution

The cables that connect to the rear of the radio could have live voltage on some of their pins. Do not remove or reconnect these cables. Only a qualified radio technician should perform this task. Service performed by unauthorized personnel may cause the radio to transmit an emergency alarm even if the unit is turned off.

If your radio is locked up or the display shows **FAIL 01/09**, turn the radio off and then back on. If this does not correct the condition, take the radio to a qualified radio technician for service.

If radio operation is intermittent, check with other persons using the system for similar problems before taking the radio in for service. Similar problems indicate a system malfunction rather than a radio failure.

If symptoms persist or, if your unit exhibits other problems, contact a qualified radio technician.

Accessories

For a list of Motorola-approved antennas and other accessories, visit the following website:

<http://www.motorola.com/governmentandenterprise>

On the website, search for *APX Mobile Radios*. You will see the accessories information besides the specifications of the radio. You can also contact your dealer for details.

Appendix: Maritime Radio Use in the VHF Frequency Range

Take a moment to review the following:

Special Channel Assignments. page 106

Operating Frequency Requirements. page 107

■ Special Channel Assignments

Emergency Channel

If you are in imminent and grave danger at sea and require emergency assistance, use **VHF Channel 16** to send a distress call to nearby vessels and the United States Coast Guard. Transmit the following information, in this order:

- 1 "MAYDAY, MAYDAY, MAYDAY."
- 2 "THIS IS _____, CALL SIGN _____."
State the name of the vessel in distress 3 times, followed by the call sign or other identification of the vessel, stated 3 times.
- 3 Repeat "MAYDAY" and the name of the vessel.

- 4 "WE ARE LOCATED AT _____."
State the position of the vessel in distress, using any information that will help responders to locate you, e.g.:
 - *latitude and longitude*
 - *bearing (state whether you are using true or magnetic north)*
 - *distance to a well-known landmark*
 - *vessel course, speed or destination*
- 5 State the nature of the distress.
- 6 Specify what kind of assistance you need.
- 7 State the number of persons on board and the number needing medical attention, if any.
- 8 Mention any other information that would be helpful to responders, such as type of vessel, vessel length and/or tonnage, hull color, etc.
- 9 "OVER."
- 10 Wait for a response.
- 11 If you do not receive an immediate response, remain by the radio and repeat the transmission at intervals until you receive a response. Be prepared to follow any instructions given to you.

Non-Commercial Call Channel

For non-commercial transmissions, such as fishing reports, rendezvous arrangements, repair scheduling, or berthing information, use **VHF Channel 9**.

■ Operating Frequency Requirements

A radio designated for shipboard use must comply with Federal Communications Commission Rule Part 80 as follows:

- on ships subject to Part II of Title III of the Communications Act, the radio must be capable of operating on the 156.800 MHz frequency
- on ships subject to the Safety Convention, the radio must be capable of operating:
 - in the simplex mode on the ship station transmitting frequencies specified in the 156.025 – 157.425 MHz frequency band, and
 - in the semiduplex mode on the two frequency channels specified in the table below.

Note: Simplex channels 3, 21, 23, 61, 64, 81, 82, and 83 cannot be lawfully used by the general public in US waters.

Additional information about operating requirements in the Maritime Services can be obtained from the full text of FCC Rule Part 80 and from the US Coast Guard.

Table A-1: VHF Marine Channel List

Channel Number	Frequency (MHz)	
	Transmit	Receive
1	156.050	160.650

Table A-1: VHF Marine Channel List (Continued)

Channel Number	Frequency (MHz)	
	Transmit	Receive
2	156.100	160.700
*	156.150	160.750
4	156.200	160.800
5	156.250	160.850
6	156.300	–
7	156.350	160.950
8	156.400	–
9	156.450	156.450
10	156.500	156.500
11	156.550	156.550
12	156.600	156.600
13**	156.650	156.650
14	156.700	156.700
15**	156.750	156.750
16	156.800	156.800
17**	156.850	156.850
18	156.900	161.500
19	156.950	161.550
20	157.000	161.600
*	157.050	161.650
22	157.100	161.700
*	157.150	161.750

Table A-1: VHF Marine Channel List (Continued)

Channel Number	Frequency (MHz)	
	Transmit	Receive
24	157.200	161.800
25	157.250	161.850
26	157.300	161.900
27	157.350	161.950
28	157.400	162.000
60	156.025	160.625
*	156.075	160.675
62	156.125	160.725
63	156.175	160.775
*	156.225	160.825
65	156.275	160.875
66	156.325	160.925
67**	156.375	156.375
68	156.425	156.425
69	156.475	156.475
71	156.575	156.575
72	156.625	—
73	156.675	156.675
74	156.725	156.725
75	***	***
76	***	***
77**	156.875	—

Table A-1: VHF Marine Channel List (Continued)

Channel Number	Frequency (MHz)	
	Transmit	Receive
78	156.925	161.525
79	156.975	161.575
80	157.025	161.625
*	157.075	161.675
*	157.125	161.725
*	157.175	161.775
84	157.225	161.825
85	157.275	161.875
86	157.325	161.925
87	157.375	161.975
88	157.425	162.025

* Simplex channels 3, 21, 23, 61, 64, 81, 82, and 83 cannot be **lawfully used** by the general public in US waters.

** Low power (1 W) only

*** Guard band

Note: A – in the Receive column indicates that the channel is transmit only.

Glossary

This glossary is a list of specialized terms used in this manual.

Term	Definition
ACK	Acknowledgment of communication.
Active Channel	A channel that has traffic on it.
Analog Signal	An RF signal that has a continuous nature rather than a pulsed or discrete nature.
ARS	Automatic Registration Service
ASTRO 25 Trunking	Motorola standard for wireless digital trunked communications.
ASTRO Conventional	Motorola standard for wireless digital conventional communications.
Autoscan	A feature that allows the radio to automatically scan the members of a scan list.
AUX CH	Auxiliary Control Head
Call Alert	Privately page an individual by sending an audible tone.

Term	Definition
Carrier Squelch	Feature that responds to the presence of an RF carrier by opening or unmuting (turning on) a receiver's audio circuit. A squelch circuit silences the radio when no signal is being received so that the user does not have to listen to "noise".
Central Controller	A software-controlled, computer-driven device that receives and generates data for the trunked radios assigned to it. It monitors and directs the operations of the trunked repeaters.
Channel	A group of characteristics such as transmit/receive frequency pairs, radio parameters, and encryption encoding.
CHIB	Control Head Interface Board
Control Channel	In a trunking system, one of the channels that is used to provide a continuous, two-way/data communications path between the central controller and all radios on the system.
Conventional	Typically refers to radio-to-radio communications, sometimes through a repeater (see Trunking).
Conventional Scan List	A scan list that includes only conventional channels.

Term	Definition
CP	Codeplug
Cursor	A visual tracking marker (a blinking line) that indicates a location on the display.
Deadlock	Displayed by the radio after three failed attempts to unlock the radio. The radio must be powered off and on prior to another attempt.
Digital Private Line (DPL)	A type of coded squelch using data bursts. Similar to PL except a digital code is used instead of a tone.
Digital Signal	An RF signal that has a pulsed, or discrete, nature, rather than a continuous nature.
Dispatcher	An individual who has radio system management duties.
DSP	Digital Signal Processing
Dynamic Regrouping	A feature that allows the dispatcher to temporarily reassign selected radios to a single special channel so they can communicate with each other.
ESN	Electrical Serial Number

Term	Definition
Failsoft	A feature that allows communications to take place even though the central controller has failed. Each trunked repeater in the system transmits a data word informing every radio that the system has gone into failsoft.
FCC	Federal Communications Commission.
FM	Frequency Modulation
Hang Up	Disconnect.
Home screen	The first display information after the radio completes its self test.
KVL	Key-variable loader: A device for loading encryption keys into the radio.
LCD	Liquid crystal display
LED	Light-emitting diode
Menu Entry	A software-activated feature shown at the bottom of the display – selection of these features is controlled by the  .
MCHB	Millennium Control Head Board

Term	Definition
Monitor	Check channel activity through menu entries. If the channel is clear, you hear static. If the channel is in use, you hear conversation. It also serves as a way to check the volume level of the radio, since the radio “opens the squelch” when the monitor button is pressed.
Multi-System Talkgroup Scan List	A scan list that can include both talkgroups (trunked) and channels (conventional).
Network Access Code	Network Access Code (NAC) operates on digital channels to reduce voice channel interference between adjacent systems and sites.
Non-Tactical/ Revert	The user talks on a preprogrammed emergency channel. The emergency alarm is sent out on this same channel.
OTAR	Over-the-air rekeying.
Page	A one-way alert, with audio and/or display messages.
Personality	A set of unique features specific to a radio.
PIN	Personal Identification Number
Preprogrammed	Refers to a software feature that has been activated by a qualified radio technician.

Term	Definition
Private (Conversation) Call	A feature that lets you have a private conversation with another radio user in the talkgroup.
Private Line (PL)	A sub-audible tone that is transmitted such that only receivers decoding the tone receives it.
Programmable	Refers to a radio control that can have a radio feature assigned to it.
PTT	Push-To-Talk – the PTT button engages the transmitter and puts the radio in transmit (send) operation when pressed.
Radio Frequency (RF)	The part of the general frequency spectrum between the audio and infrared light regions (about 10 kHz to 10,000,000 MHz).
Repeater	A conventional radio feature, where you talk through a receive/transmit facility that re-transmits received signals, in order to improve communications range and coverage.
Selective Call	A feature that allows you to call a select individual, intended to provide privacy and to eliminate the annoyance of having to listen to conversations of no interest to you.

Term	Definition
Selective Switch	Any digital P25 traffic having the correct Network Access Code and the correct talkgroup.
Squelch	Special electronic circuitry, added to the receiver of a radio, that reduces, or cuts off, unwanted signals before they are heard in the speaker.
Standby	An operating condition whereby the radio's speaker is muted but still continues to receive data.
Status Calls	Pre-defined text messages that allow the user to send a conditional message without talking.
Tactical/ Non-Revert	The user talks on the channel that was selected before the radio entered the emergency state.
Talkaround	Bypass a repeater and talk directly to another unit for easy local unit-to-unit communications.
Talkgroup	An organization or group of radio users who communicate with each other using the same communication path.
TMS	Text Messaging Service

Term	Definition
Trunking	The automatic sharing of communications paths between a large number of users (see Conventional).
Trunking Priority Monitor Scan List	A scan list that includes talkgroups that are all from the same trunking system.
USK	Unique Shadow Key
UTC	Coordinated Universal Time. The international time standard (formerly Greenwich Mean Time, or GMT). Zero hours UTC is midnight in Greenwich, England, which is located at 0 degrees longitude. Everything east of Greenwich (up to 180 degrees) is later in time; everything west is earlier. There are 42 time authorities around the world that are constantly synchronizing with each other. Abbreviated as UTC (English backronym = Universal Time, Coordinated), it is also known as Zulu (Z) Time.
Zone	A grouping of channels.

Commercial Warranty and Service

Limited Warranty

MOTOROLA COMMUNICATION PRODUCTS

I. WHAT THIS WARRANTY COVERS AND FOR HOW LONG:

MOTOROLA INC. ("MOTOROLA") warrants the MOTOROLA manufactured Communication Products listed below ("Product") against defects in material and workmanship under normal use and service for a period of time from the date of purchase as scheduled below:

APX Mobile Radio	One (1) Year
Product Accessories	One (1) Year

MOTOROLA, at its option, will at no charge either repair the Product (with new or reconditioned parts), replace it (with a new or reconditioned Product), or refund the purchase price of the Product during the warranty period provided it is returned in accordance with the terms of this warranty. Replaced parts or boards are warranted for the balance of the original applicable warranty period. All replaced parts of Product shall become the property of MOTOROLA.

This express limited warranty is extended by MOTOROLA to the original end user purchaser only and is not assignable or transferable to any other party. This is the complete warranty for the

Product manufactured by MOTOROLA. MOTOROLA assumes no obligations or liability for additions or modifications to this warranty unless made in writing and signed by an officer of MOTOROLA. Unless made in a separate agreement between MOTOROLA and the original end user purchaser, MOTOROLA does not warrant the installation, maintenance or service of the Product.

MOTOROLA cannot be responsible in any way for any ancillary equipment not furnished by MOTOROLA which is attached to or used in connection with the Product, or for operation of the Product with any ancillary equipment, and all such equipment is expressly excluded from this warranty. Because each system which may use the Product is unique, MOTOROLA disclaims liability for range, coverage, or operation of the system as a whole under this warranty.

II. GENERAL PROVISIONS:

This warranty sets forth the full extent of MOTOROLA'S responsibilities regarding the Product. Repair, replacement or refund of the purchase price, at MOTOROLA'S option, is the exclusive remedy. THIS WARRANTY IS GIVEN IN LIEU OF ALL OTHER EXPRESS WARRANTIES. IMPLIED WARRANTIES, INCLUDING WITHOUT LIMITATION, IMPLIED WARRANTIES OF MERCHANTABILITY AND FITNESS FOR A PARTICULAR PURPOSE, ARE LIMITED TO THE DURATION OF THIS LIMITED WARRANTY. IN NO EVENT SHALL MOTOROLA BE LIABLE FOR DAMAGES IN EXCESS OF THE PURCHASE PRICE OF THE PRODUCT, FOR ANY LOSS OF USE, LOSS OF TIME, INCONVENIENCE, COMMERCIAL LOSS, LOST PROFITS OR SAVINGS OR OTHER INCIDENTAL, SPECIAL OR CONSEQUENTIAL DAMAGES ARISING OUT OF THE USE OR

INABILITY TO USE SUCH PRODUCT, TO THE FULL EXTENT SUCH MAY BE DISCLAIMED BY LAW.

III. STATE LAW RIGHTS:

SOME STATES DO NOT ALLOW THE EXCLUSION OR LIMITATION OF INCIDENTAL OR CONSEQUENTIAL DAMAGES OR LIMITATION ON HOW LONG AN IMPLIED WARRANTY LASTS, SO THE ABOVE LIMITATION OR EXCLUSIONS MAY NOT APPLY.

This warranty gives specific legal rights, and there may be other rights which may vary from state to state.

IV. HOW TO GET WARRANTY SERVICE:

You must provide proof of purchase (bearing the date of purchase and Product item serial number) in order to receive warranty service and, also, deliver or send the Product item, transportation and insurance prepaid, to an authorized warranty service location. Warranty service will be provided by MOTOROLA through one of its authorized warranty service locations. If you first contact the company which sold you the Product (e.g., dealer or communication service provider), it can facilitate your obtaining warranty service. You can also call MOTOROLA at 1-800-927-2744 US/Canada.

V. WHAT THIS WARRANTY DOES NOT COVER:

- A) Defects or damage resulting from use of the Product in other than its normal and customary manner.
- B) Defects or damage from misuse, accident, water, or neglect.

- C) Defects or damage from improper testing, operation, maintenance, installation, alteration, modification, or adjustment.
- D) Breakage or damage to antennas unless caused directly by defects in material workmanship.
- E) A Product subjected to unauthorized Product modifications, disassembles or repairs (including, without limitation, the addition to the Product of non-MOTOROLA supplied equipment) which adversely affect performance of the Product or interfere with MOTOROLA's normal warranty inspection and testing of the Product to verify any warranty claim.
- F) Product which has had the serial number removed or made illegible.
- G) Rechargeable batteries if:
 - any of the seals on the battery enclosure of cells are broken or show evidence of tampering.
 - the damage or defect is caused by charging or using the battery in equipment or service other than the Product for which it is specified.
- H) Freight costs to the repair depot.
- I) A Product which, due to illegal or unauthorized alteration of the software/firmware in the Product, does not function in accordance with MOTOROLA's published specifications or the FCC certification labeling in effect for the Product at the time the Product was initially distributed from MOTOROLA.
- J) Scratches or other cosmetic damage to Product surfaces that does not affect the operation of the Product.
- K) Normal and customary wear and tear.

VI. PATENT AND SOFTWARE PROVISIONS:

MOTOROLA will defend, at its own expense, any suit brought against the end user purchaser to the extent that it is based on a claim that the Product or parts infringe a United States patent, and MOTOROLA will pay those costs and damages finally awarded against the end user purchaser in any such suit which are attributable to any such claim, but such defense and payments are conditioned on the following:

- A) that MOTOROLA will be notified promptly in writing by such purchaser of any notice of such claim;
- B) that MOTOROLA will have sole control of the defense of such suit and all negotiations for its settlement or compromise; and
- C) should the Product or parts become, or in MOTOROLA's opinion be likely to become, the subject of a claim of infringement of a United States patent, that such purchaser will permit MOTOROLA, at its option and expense, either to procure for such purchaser the right to continue using the Product or parts or to replace or modify the same so that it becomes non-infringing or to grant such purchaser a credit for the Product or parts as depreciated and accept its return. The depreciation will be an equal amount per year over the lifetime of the Product or parts as established by MOTOROLA.

MOTOROLA will have no liability with respect to any claim of patent infringement which is based upon the combination of the Product or parts furnished hereunder with software, apparatus or devices not furnished by MOTOROLA, nor will MOTOROLA have any liability for the use of ancillary equipment or software not furnished by MOTOROLA which is attached to or used in connection with the Product. The foregoing states the entire liability of MOTOROLA with respect to infringement of patents by the Product or any parts thereof.

Laws in the United States and other countries preserve for MOTOROLA certain exclusive rights for copyrighted MOTOROLA software such as the exclusive rights to reproduce in copies and distribute copies of such MOTOROLA software. MOTOROLA software may be used in only the Product in which the software was originally embodied and such software in such Product may not be replaced, copied, distributed, modified in any way, or used to produce any derivative thereof. No other use including, without limitation, alteration, modification, reproduction, distribution, or reverse engineering of such MOTOROLA software or exercise of rights in such MOTOROLA software is permitted. No license is granted by implication, estoppel or otherwise under MOTOROLA patent rights or copyrights.

VII. GOVERNING LAW:

This Warranty is governed by the laws of the State of Illinois, U.S.A.

SERVICE

Proper repair and maintenance procedures will assure efficient operation and long life for this product. A Motorola maintenance agreement will provide expert service to keep this and all other communication equipment in perfect operating condition. A nationwide service organization is provided by Motorola to support maintenance services. Through its maintenance and installation program, Motorola makes available the finest service to those desiring reliable, continuous communications on a contract basis. For a contract service agreement, please contact your nearest Motorola service or sales representative, or an authorized Motorola dealer.

Express Service Plus (ESP) is an optional extended service coverage plan, which provides for the repair of this product for a period of three years from the date of shipment from the factory, or the date of delivery if purchased from an authorized Motorola two-way radio dealer. For more information about ESP, contact the Motorola Radio Support Center, 2204 Galvin Drive, Elgin, IL 60123, 1-800-227-6772.

© 2009, 2010 by Motorola, Inc. All Rights Reserved. 09/10
1301 E. Algonquin Rd., Schaumburg,
IL 60196-1078, U.S.A.

Printed in the U.S.A.



6875947M01-C