

VML750 — LTE Vehicular Subscriber Modem (VSM) Installation Guide



Copyrights

The Motorola products described in this document may include copyrighted Motorola computer programs. Laws in the United States and other countries preserve for Motorola certain exclusive rights for copyrighted computer programs. Accordingly, any copyrighted Motorola computer programs contained in the Motorola products described in this document may not be copied or reproduced in any manner without the express written permission of Motorola.

© 2014 Motorola Solutions, Inc. All Rights Reserved

No part of this document may be reproduced, transmitted, stored in a retrieval system, or translated into any language or computer language, in any form or by any means, without the prior written permission of Motorola Solutions, Inc.

Furthermore, the purchase of Motorola products shall not be deemed to grant either directly or by implication, estoppel or otherwise, any license under the copyrights, patents or patent applications of Motorola, except for the normal nonexclusive, royalty-free license to use that arises by operation of law in the sale of a product.

Disclaimer

Please note that certain features, facilities, and capabilities described in this document may not be applicable to or licensed for use on a particular system, or may be dependent upon the characteristics of a particular mobile subscriber unit or configuration of certain parameters. Please refer to your Motorola contact for further information.

Trademarks

MOTOROLA, MOTO, MOTOROLA SOLUTIONS, and the Stylized M Logo are trademarks or registered trademarks of Motorola Trademark Holdings, LLC and are used under license. All other trademarks are the property of their respective owners.

European Union (EU) Waste of Electrical and Electronic Equipment (WEEE) directive



The European Union's WEEE directive requires that products sold into EU countries must have the crossed out trashbin label on the product (or the package in some cases).

As defined by the WEEE directive, this cross-out trashbin label means that customers and end-users in EU countries should not dispose of electronic and electrical equipment or accessories in household waste.

Customers or end-users in EU countries should contact their local equipment supplier representative or service centre for information about the waste collection system in their country.

Document History

Edition	Description	Date
Release 1.0	First release of VML750 — LTE Vehicular Subscriber Modem (VSM) Installation Guide.	April 2014
Release 2.0	Second release of VML750 — LTE Vehicular Subscriber Modem (VSM) Installation Guide.	July 2014

This page intentionally left blank.

Contents

VML750 — LTE Vehicular Subscriber Modem (VSM) Installation Guide

Notational Conventions	-xii
Required Documents for complete VSM Deployment	-xiii
Motorola Solutions Support Center	-xiv
Support Center	-xiv
North America Parts Organization	-xiv
Safety	-xiv
FCC Interference	-xv
Legal Notice	-xv

Chapter 1: VML750 Description

The VML750 Unit	1-1
Modem	1-2
Connector Panel	1-3
Connector Panel for B20 LTE Only Configuration	1-4
LED Indicator Panel with Power Button and SIM Card Door	1-5
Power Button	1-5
SIM Card	1-6

Chapter 2: VML750 Installation

Unpacking and Inspecting the Shipment	2-1
Safety and General Information	2-1
Planning the Installation	2-3
Installation Constraints	2-3
Cables Routing	2-5
Drilling Holes	2-5
Tools and Equipment	2-5
Antennas	2-6
Antennas for LTE B14 + VzW	2-6
Antenna for Configuration Supporting LTE Private Network on WWAN1	2-6
Antenna Configuration for LTE Public Network on WWAN2	2-7
Antennas for B20 LTE only Configuration	2-8
Main Antenna	2-8
Diversity Antenna	2-8
Cables	2-9
Mounting Brackets	2-11
Modem Installation Process	2-12
Antenna Mounting	2-12
Special Antennas Installation Considerations	2-13

General Antenna Installation Safety Considerations	2-13
Main Antenna	2-13
Modem Installation Procedure	2-14
Cables Routing and Connection Procedure	2-15
DC Power and Ignition Cable Installation	2-15
Antenna Cables Installation (Main and Diversity) for LTE Private Network Configuration	2-16
Antenna Cables Installation (Main and Diversity) for B20 LTE only Configuration	2-17
LAN/Ethernet Cable Installation	2-18
Micro USB Cable Installation	2-18
SIM Installation	2-19
CryptR Card Removal and Installation	2-20
Cap Installation	2-23
Powering the Modem Up	2-23

Chapter 3: Troubleshooting the VML750

Troubleshooting	3-2
LED Indicators Functions	3-5

Chapter 4: Using the VML750

General	4-1
-------------------	-----

Appendix A: Specifications

Physical	A-1
Communication Ports	A-1
RF Ports	A-1
Power Port	A-2
LEDs.	A-2
Operating Temperature	A-2
Power	A-2
RF Characteristics.	A-2

Appendix B: Reference

Replacement Parts.	B-1
Replacement Parts List	B-1
Kit Replacement Parts List.	B-2
Approved Antennas List.	B-2
Antennas Cables Replacements	B-2

Appendix C: LTE & LMR Antennas Mounting Recommendations

Police Patrol Vehicle Antennas Location Considerations — Overview.	C-1
Planning Antenna Mounting Location on a Police Patrol Vehicle	C-2

List of Figures

Figure 1-1: VML750 - General View	1-2
Figure 1-2: Connector Panel	1-3
Figure 1-3: Connector Panel	1-4
Figure 1-4: LED Indicators Panel.	1-5
Figure 2-1: VML750 - Schematic Car Installation	2-4
Figure 2-2: VML750 - Dimensions	2-4
Figure 2-3: Antenna for Configuration Supporting LTE Private Network on WWAN1	2-7
Figure 2-4: Antenna for LTE Public Network on WWAN2	2-7
Figure 2-5: Main Antenna	2-8
Figure 2-6: Diversity Antenna - Standard Configuration	2-9
Figure 2-7: Available Cables	2-9
Figure 2-8: Bracket Dimensions	2-11
Figure 2-9: Mounting Brackets	2-14
Figure 2-10: DC Power and Ignition Cable Routing Into Engine Compartment	2-15
Figure C-1: Police Patrol Vehicle — Antennas Location Suggestion	C-2

This page intentionally left blank.

List of Tables

Table 3-1: Troubleshooting the VML750	3-2
Table 3-2: LED Indicators Functions	3-5

This page intentionally left blank.

This page intentionally left blank.

VML750 — LTE Vehicular Subscriber Modem (VSM) Installation Guide

What Is Covered In This Manual?

The VML750 LTE VSM Installation Guide provides general instructions for installing, operating, and troubleshooting the VML750.

This guide includes the following configurations:

- F0025 (VML750) model -
 - FLN1057 sub model — LTE B14 + VzW.
 - FLN1310 sub model — LTE B20.

The guide is organized as follows:

- [Chapter 1, "VML750 Description"](#) provides the product overview.
- [Chapter 2, "VML750 Installation"](#) provides unpacking instructions and all required procedures for installing the VML750.
- [Chapter 3, "Troubleshooting the VML750"](#) provides details regarding possible malfunctions that may occur after first-time installation of the VML750, their probable cause, and the recommended corrective actions.
- [Chapter 4, "Using the VML750"](#) provides general information regarding the use of the VML750.
- [Appendix A, "Specifications"](#) provides the VML750 modem specifications.
- [Appendix B, "Reference"](#) provides part numbers information for the modem and antennas.

Notational Conventions

.....

The following conventions are used in this document:

- *Italics* are used to highlight the following:
 - Chapters and sections in this and related documents
 - Dialog box, window and screen names
 - Drop-down list and list box names
 - Check box and radio button names
- **Bold** text is used to highlight the following:
 - Key names on a keypad
 - Button names on a screen
- bullets (•) indicate:
 - Action items
 - Lists of alternatives
 - Lists of required steps that are not necessarily sequential
- Sequential lists (e.g., those that describe step-by-step procedures) appear as numbered lists.

Required Documents for complete VSM Deployment

.....

To complete the full deployment of the modem, you may need the following documents:

- Information related to VML750 configuration in the *VML750 Configuration Guide P/N 6802988C55* located at: <https://businessonline.motorolasolutions.com>
- Information related to VML750 monitoring can be found in the *VML750 LTE Vehicle Subscriber Modem (VSM) Status Utility Quick Reference Guide P/N 6802988C79*.
- Information related to the device licensing can be found in the *Device Licensing Quick Reference Guide P/N 6871024P25* located at: <https://businessonline.motorolasolutions.com>

Motorola Solutions Support Center

Support Center

The Motorola Solutions Support Center (SSC) is the primary Motorola Solutions support contact. Call:

- Prior to any software reload.
- To confirm troubleshooting results and analysis prior to removing and replacing a Field Replaceable Unit (FRU) and Field Replaceable Entity (FRE) to repair the system.

For...	Phone
Domestic calls	800-221-7144
International calls	302-444-9800

North America Parts Organization

For assistance in ordering replacement parts or identifying a part number, contact Motorola's parts organization. Please remember that your first response when troubleshooting your system is to call the Motorola SSC.

For...	Phone
Phone Orders	800-422-4210 (US and Canada orders) 302-444-9842 (International orders)
Fax Orders	800-622-6210 (US and Canada orders)
Help identifying an item or part number	800-422-4210 and select choice 3 from the menu.

Safety

Before installing/using this product, the installer/operator must be familiar with the RF energy awareness information and operating instructions in the “Product Safety and RF Energy Exposure Booklet for Mobile Two-Way Radios Installed in Vehicles or as Fixed Site Control Stations” enclosed with the VML750 LTE VSM (Motorola Publication part number 6881095C99) to ensure compliance with Radio Frequency (RF) energy exposure limits.

FCC Interference

This device complies with Part 15 of the FCC Rules. Operation is subject to the following two conditions:

- This device may not cause harmful interference.
- This device must accept any interference received, including interference that may cause undesired operation.



NOTE

Changes or modifications made to this product, not expressly approved by Motorola, will void the user's authority to operate the equipment, per FCC Rule Part 15.21.

Legal Notice

The VML750 OSS legal notice will be provided by Motorola per request.

This page intentionally left blank.

VML750 Description

The VML750 Unit

The Motorola VML750 - LTE Vehicular Subscriber Modem (VSM) is a low-power modem. The following models and their SKU are available:

- F0025 family:
 - FLN1057: A multi-mode modem that has the ability to operate in LTE Band 14/13 and 3G EvDo BC0/BC1. The modem supports WiFi as client and AP as well as GPS for location and support for data encryption (CyrptR).
 - FLN1310: A multi-mode modem that has the ability to operate in LTE Band 20. The modem supports WiFi as client and AP as well as GPS for location and support for data encryption (CyrptR).

See [Figure 1-1](#).

Figure 1-1 VML750 - General View



Item #	Description
1	Modem
2	LED Indicator Panel (Front Panel)
3	Connector Panel (Back Panel - not shown)

For detailed specifications of the VML750 unit, see [Appendix A, "Specifications"](#).

Modem

The modem has a connector panel (back panel) and a LED Indicator panel with a Power button (front panel).

Connector Panel

The VML750 Connector panel consists of the following (see [Figure 1-2](#)):

Figure 1-2 Connector Panel

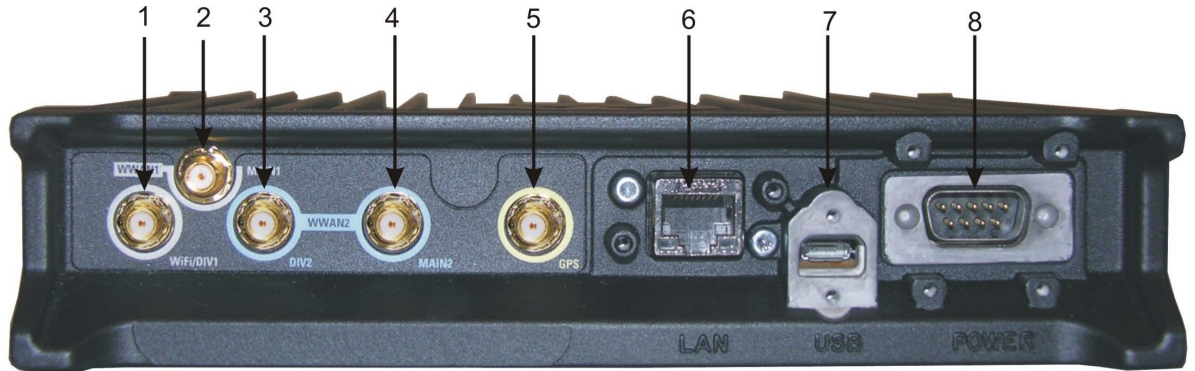

Item #	Description
1	RF SMA female type connector (WWAN1 DIV/WiFi)
2	RF SMA female type connector (WWAN1 main)
3	RF SMA female type connector (WWAN2 DIV)
4	RF SMA female type connector (WWAN2)
5	RF SMA female type connector (GPS)
6	LAN/Ethernet communication connector (RJ45)
7	Micro AB type connector (USB 2.0)
8	DC power and GPIO D-type, 9-pin connector

Connector Panel for B20 LTE Only Configuration

The VML750 Connector panel consists of the following (see [Figure 1-3](#)):

Figure 1-3 Connector Panel

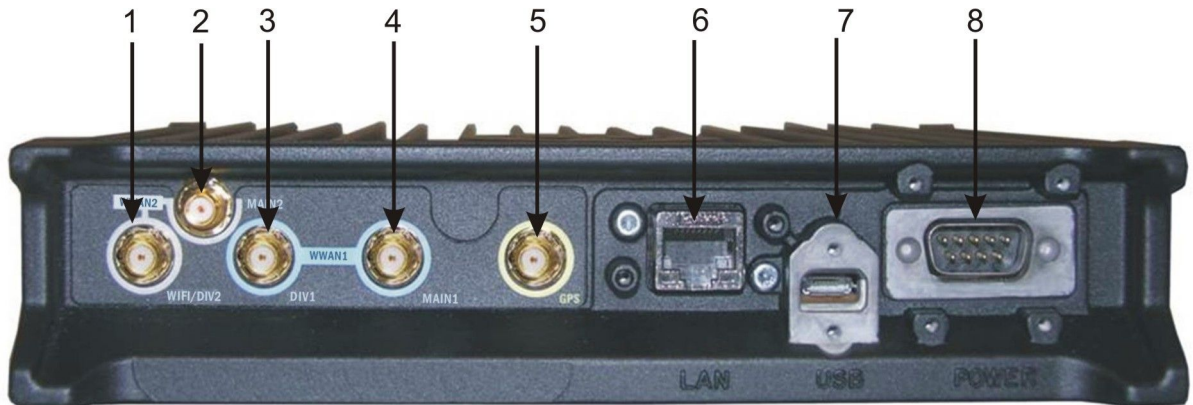

Item #	Description
1	RF SMA female type connector (WWAN2 DIV/WiFi)
2	RF SMA female type connector (WWAN2 main)
3	RF SMA female type connector (WWAN1 DIV1) (does not apply for B20 LTE only configuration)
4	RF SMA female type connector (WWAN1 MAIN1) (does not apply for B20 LTE only configuration)
5	RF SMA female type connector (GPS)
6	LAN/Ethernet communication connector (RJ45)
7	Micro AB type connector (USB 2.0)
8	DC power D-type, 9-pin connector

LED Indicator Panel with Power Button and SIM Card Door

A set of six LEDs is used for diagnostics and testing of the unit (see [Figure 1-4](#)).

Figure 1-4 LED Indicators Panel

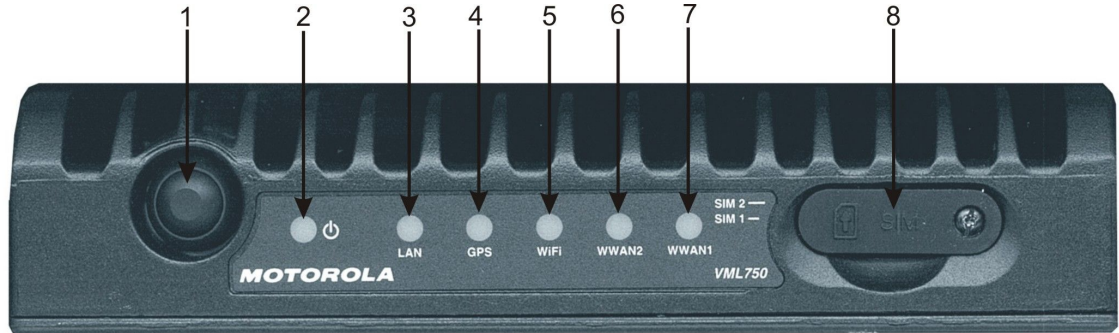

Item #	Description
1	Power Button
2	Power Indicator
3	LAN
4	GPS
5	WiFi
6	WWAN2
7	WWAN1 (does not apply for B20 LTE only configuration)
8	SIM Card Door

Power Button

The Power button is used to turn the VML750 On or Off when Ignition Sense is disabled. If the Ignition Sense is enabled, you also need to turn your vehicle ignition switch to On. This button is also used to apply factory reset.

SIM Card

If your LTE modem is intended to home on your private Motorola LTE network, you are provided with a Motorola LTE SIM card (to be inserted into SIM1 slot). If your LTE modem is intended to home on a public carrier LTE network, you need to obtain a SIM card from that public carrier and insert into SIM2 slot. The SIM card must be inserted with the metal leads facing down and the notched corner on the left. The WiFi modem is still operational without a SIM card.



NOTE

- WiFi must be configured prior to use. Refer to *VML750 Configuration Guide* (6802988C55) located in <https://businessonline.motorolasolutions.com> for configuration procedure.

VML750 Installation

Unpacking and Inspecting the Shipment

Unpack your equipment and check the contents to ensure that you have received all the specified items. Thoroughly inspect the equipment for shipping damage as soon as possible after delivery. Report any damage you find to your Motorola Customer Service representative immediately.

Safety and General Information

A properly installed VML750 unit minimizes service calls. When mounting the VML750 unit components, consider the following factors:



NOTE

This device requires professional installation to satisfy compliance with FCC requirements.

- The mounting surface must have sufficient strength to support the equipment being mounted and to prevent it from becoming loose over time.
- Do not attach components to any part of the vehicle subjected to excessive vibration.
- Do not mount the VML750 unit on a flat surface where the unit could become partially submersed in water.
- The proposed location of the equipment being mounted or wires/cables attached must not interfere with driver/passenger seating or leg space.

- Select a location such that heat from the unit does not damage any wiring or any other plastic or heat-sensitive parts of the automobile.
- Use the supplied mounting hardware.
- Leave sufficient space around the VML750 unit for air flow and installation.
- Select a location that permits routing the cables as directly as possible.
- Ensure that the cables are not stretched, and not subject to heat from the engine, transmission housing, or heating ducts.
- Crimp connectors securely.
- Do not run cables over sharp edges that may cause excessive wear or chaffing of the cable insulation.
- Do not install components in locations where they may cause interference to the operation of the vehicle's controls.
- Only qualified personnel may install communication equipment.
- Ensure secure tightening of cable connectors.

**NOTE**

Install this product in a vehicle in accordance with the vehicle manufacturer's guidelines and the instructions detailed in this manual. Use only the Motorola parts specified in this manual.

Check the required mounting locations. It might be necessary to penetrate the firewall to reach the battery. Before drilling commences, ensure cable clearance on the opposite side of the firewall and do not install the vehicle's Electronic Control Modules (ECM's) on the opposite side of the firewall. Protect the cable where it passes through the firewall by using a grommet or similar protective measures.

**CAUTION**

Installing the VML750 at the end of the vehicle above the exhaust pipe may cause the VML750 to overheat.

**WARNING****VEHICLES EQUIPPED WITH AIR BAGS**

An air bag inflates with great force. DO NOT place objects, including communications equipment, in the area over the air bag or in the air bag deployment area. If the communication equipment is improperly installed and the air bag inflates, this could cause serious injury.

If necessary, contact the vehicle manufacturer for air bag information specific to the vehicle.

**WARNING**

Verify that none of the vehicle's systems are affected by use of the unit, e.g. cruise control, ABS braking, traction control, engine management, direction indicators, lights, etc.

**WARNING**

Use existing openings through the firewall to avoid drilling. If drilling is a must, verify not to damage the Vehicle Electronic Control Modules (ECM's), fuel lines, brake lines, and/or cable looms.

**WARNING**

For vehicles equipped with electronic braking systems, see “ANTI-SKID BRAKING PRECAUTIONS”, Motorola publication 68P81109E34.

It is mandatory that modems installed in vehicles fuelled by liquefied petroleum gas conform to the National Fire Protection Association standard NFPA 58, which applies to vehicles with a liquid propane (LP) gas container in the trunk or other sealed off space within the interior of the vehicle. The NFPA 58 requires the following:

- (1) The space in which the LP gas container and its fittings are located must be isolated by a seal from the space containing modem equipment.
- (2) Removable (outside) filling connections shall be used.
- (3) The container space shall be vented to the outside.

Planning the Installation

Planning is the key to fast, easy and safe installation.

**IMPORTANT**

Take the following points into consideration when selecting a location and planning the installation.

Installation Constraints

Refer to the Safety Instructions in “Product Safety and RF Energy Exposure Booklet for Mobile Two-Way Radios Installed in Vehicles or as Fixed Site Control Stations” P/N 6881095C99.

The VML750 must be installed in the car's trunk, on the floor or the side walls (cooling fins facing up, or to the side).



IMPORTANT

The VML750 **must not** be installed with the cooling fins facing down. Failure to comply may cause overheating problems and performance degradation.

Figure 2-1 shows a schematic VML750 installation in a car.

Figure 2-1 VML750 - Schematic Car Installation

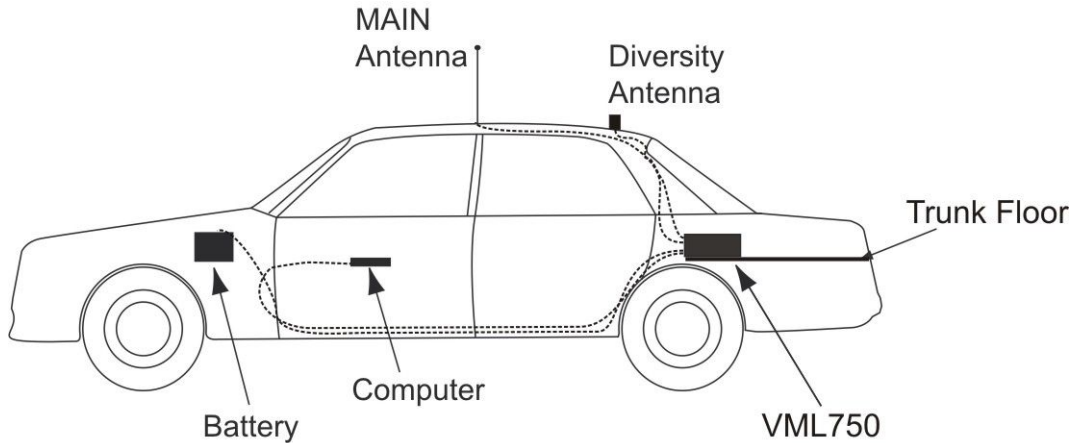

Before beginning the installation process make sure that the space available at the installation site is adequate for the modem and its accessories. Each installation configuration requires a different area for mounting the modem without obstruction.

When choosing a location, ensure easy installation and replacement of the unit.

Figure 2-2 gives the VML750 dimensions.

Figure 2-2 VML750 - Dimensions



Cables Routing

- Before running a wire or drilling a hole, inspect the vehicle and determine how and where you intend to mount the antenna, modem, and the input/output device.
- Plan wire and cable routing to provide maximum protection from overheating, battery acid, moving parts and sharp edges.
- Keep cables away from ignition circuits to reduce noise pickup in the radio equipment.
- Verify that the cables are of sufficient length. Do not connect two short lengths with a splice; doing so results in power loss. Refrain from loose excess in the cables, but leave enough slack to allow re-connection if necessary.
- Do not run cables externally or underneath floor mats.
- Do not locate cables where the driver or passengers can kick them or where they can interfere with operation of the driver's foot pedals.
- When routing the cables, refrain from creating sharp bends or kinks.



NOTE

For detailed antenna cables routing instructions, refer to the Installation Guide supplied with each antenna.

Drilling Holes

- Where possible, use existing holes in the firewall, the trunk wall and the channels above or beneath the doors.
- If you must drill holes, verify not to damage other wiring, break lines or fuel lines.
- When drilling a hole in the roof, take care not to snag the roof liner.
- To prevent rusting after drilling, remove all metal burrs and residue, and completely clean the area to ensure the removal of all steel dust.
- Insert rubber grommets in all drilled holes to protect cables, except for antennas cables.

Tools and Equipment

- #2 Phillips screwdriver
- Electric drill and drill bit set
- X-acto knife or equivalent
- Wire strippers
- Long nose pliers
- Small side cutters
- Crimping tool

- Wrench set, including 8 mm for tray to unit attachment
- Crescent wrench
- Spanner wrench
- 3 mm Allen wrench set for unit to tray attachment
- No. 8 Torx screwdriver
- Electrical tape

Antennas



NOTE

The following antennas described are for various VSM family products.

Antennas for LTE B14 + VzW

Antenna for Configuration Supporting LTE Private Network on WWAN1

The antenna is used to enhance the reception capability in poor reception areas and also to support Multiple Input Multiple Output (MIMO) modes for LTE.

The antenna can be provided with 12ft or 17ft coaxial cable.

The antenna is constructed of three antennas:

- External Whip — for main (to be connected to WWAN1 main)
- Internal antenna - for diversity and WiFi (to be connected to WWAN1 diversity)
- GPS active antenna (to be connected to WWAN1 GPS port)

The antenna is provided with three short flexible coaxial cables (threads) coming out of the antenna bottom side (see [Figure 2-3](#)).

Figure 2-3 Antenna for Configuration Supporting LTE Private Network on WWAN1



Antenna Configuration for LTE Public Network on WWAN2

Two identical antennas are used; one for the main and one for div.

The antenna can be provided with 12ft or 17ft coaxial cable.

Figure 2-4 Antenna for LTE Public Network on WWAN2



Antennas for B20 LTE only Configuration

Main Antenna

The Main antenna is used to enhance the reception capability in poor reception areas and also to support Multiple Input Multiple Output (MIMO) modes for LTE.

The antenna can be provided with 12ft or 17ft coaxial cable.

The Main antenna is shown in [Figure 2-5](#).

Figure 2-5 Main Antenna



Diversity Antenna

The diversity antenna is constructed of three antennas.

- External Whip — does not apply for B20 LTE only configuration
- Internal antenna for WWAN2 diversity and WiFi (to be connected to WWAN2 diversity)
- GPS active antenna (to be connected to GPS port)

The antenna is provided with three short flexible coaxial cables (threads) coming out of the antenna bottom side. Depending on the antenna option purchased, two 12ft or 17ft coaxial cables are also provided in order to connect between these threads and the modem connectors. The cables will be connected to the GPS and to the WWAN2 div. (see [Figure 2-6](#)).



NOTE

Be sure to use the RG-174 cable to GPS port.

Figure 2-6 Diversity Antenna - Standard Configuration



Cables

The following cables are available with the VML750 (see [Figure 2-7](#)).

Figure 2-7 Available Cables

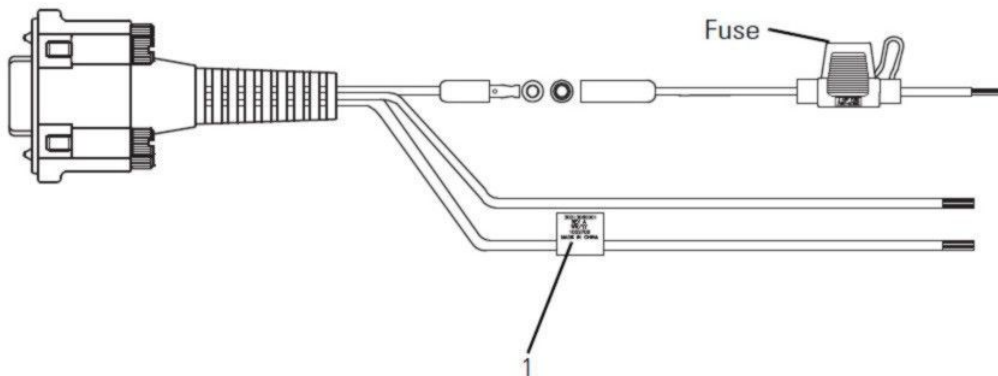

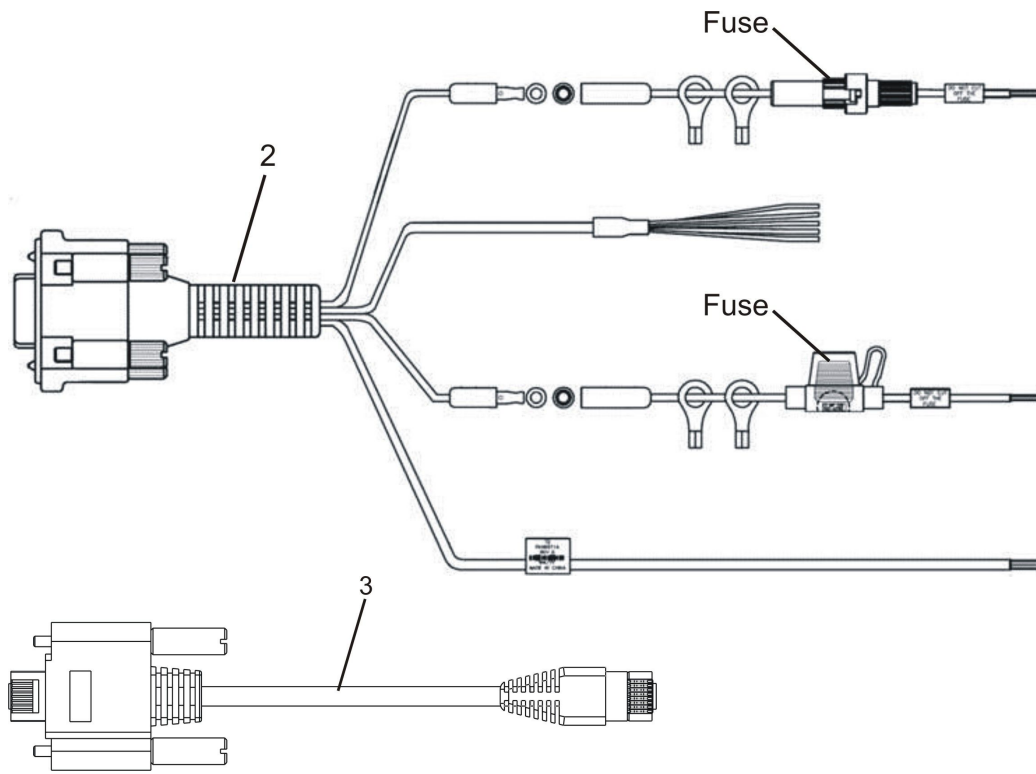

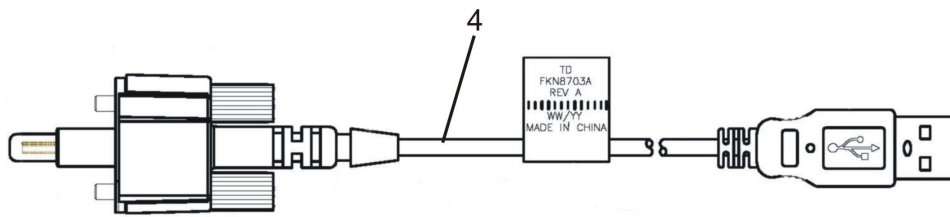

Item #	Description
1	DC Power and Ignition cable (P/N FKN8663)
2	DC Power and Ignition cable + GPIO (P/N FKN8671)
3	LAN/Ethernet cable (P/N FKN8570)
4	Micro USB cable (P/N FKN8703, can be purchased separately)

Mounting Brackets

Use the brackets (2 brackets are supplied) for mounting the VML750 securely on a flat surface.

Figure 2-8 Bracket Dimensions

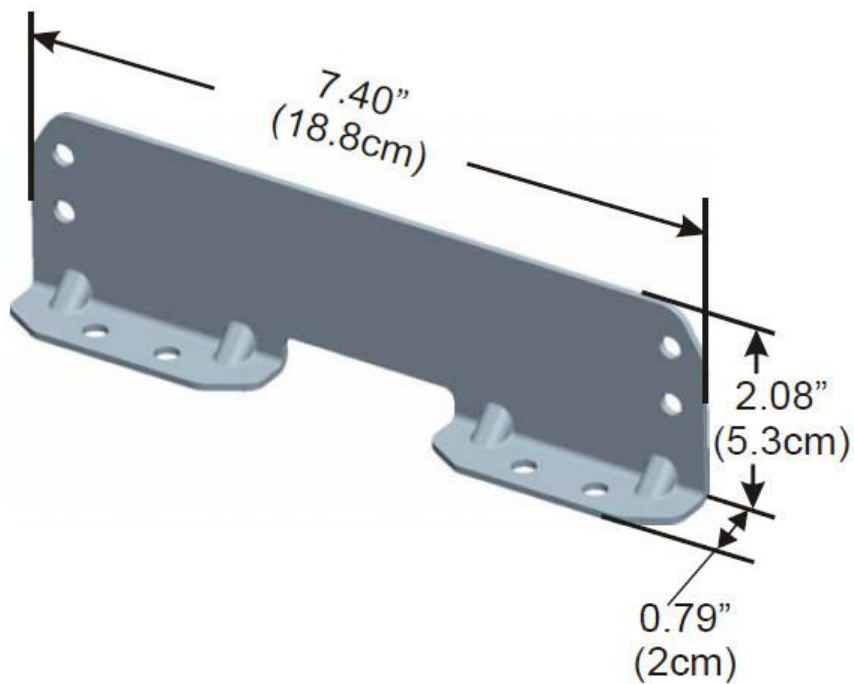

Modem Installation Process

Process 2-1 describes the steps for the modem installation.

Process 2-1 How to Install the VML750 Modem

1	Ensure adequate space for the installation. (See " Planning the Installation " on page 2-3)
2	Install the antennas. (See " Antenna Mounting " on page 2-12). Refer to the Installation Guide supplied with each antenna.
3	Route the cables. (See " Planning the Installation " on page 2-3 and " Cables Routing and Connection Procedure " on page 2-15).
4	Install the brackets and the unit. (See " Modem Installation Procedure " on page 2-14).
5	Connect the DC Power and Ignition cable. (See " DC Power and Ignition Cable Installation " on page 2-15).
6	Connect the main antenna cables. (See " Antenna Cables Installation (Main and Diversity) for LTE Private Network Configuration " on page 2-16 or " Antenna Cables Installation (Main and Diversity) for B20 LTE only Configuration " on page 2-17).
7	Connect the LAN/Ethernet cable (see " LAN/Ethernet Cable Installation " on page 2-18) or the Micro USB cable (see Procedure 2-7 , " How to Install the Micro USB Cable ," on page 2-18).
8	Place caps on unused connector(s). (See " Cap Installation " on page 2-23).
9	Perform VML750 Power-on process. (See " Powering the Modem Up " on page 2-23).

Antenna Mounting

Procedure 2-1 gives general instructions for mounting the antennas.

Procedure 2-1 How to Mount the Antennas

- 1 Mount the antennas in accordance with the instructions provided with each antenna kit and with the “Product Safety and RF Energy Exposure Booklet for Mobile Two-Way Radios Installed in Vehicles or as Fixed Site Control Stations” enclosed with the VML750 LTE VSM (Motorola Publication part number 6881095C99).

Special Antennas Installation Considerations

General Antenna Installation Safety Considerations



WARNING

The antennas must be installed in a location that will ensure a distance of at least 8” (20 cm) between any of them and any bystander.



CAUTION

If your vehicle is equipped with PSNB (Public Safety Narrow Band) equipment, special attention must be taken when installing the antennas. A minimum distance of 78” (198 cm) must be kept in order to ensure coexistence between all systems.

Main Antenna



IMPORTANT

The antenna must be installed on a flat metal surface (minimum size 24” (61 cm) x 24” (61 cm)).



NOTE

The main antenna must be installed on the vehicle’s roof, preferably in the center front side of it. Make sure that the vehicle roof material is metal. If not, use a 2 ft x 2 ft metal ground plane and mount the antenna in its center. For best performance, a minimum distance of 36” (91.44 cm) must be kept between this antenna and any other antenna.

Modem Installation Procedure

Procedure 2-2 describes how to install the modem on a flat surface.

Procedure 2-2 How to Install the Modem on a Flat Surface

- 1 Position the two mounting brackets (1) on both sides of the modem (2) and fasten using 4 screws each. See Figure 2-9.

Figure 2-9 Mounting Brackets

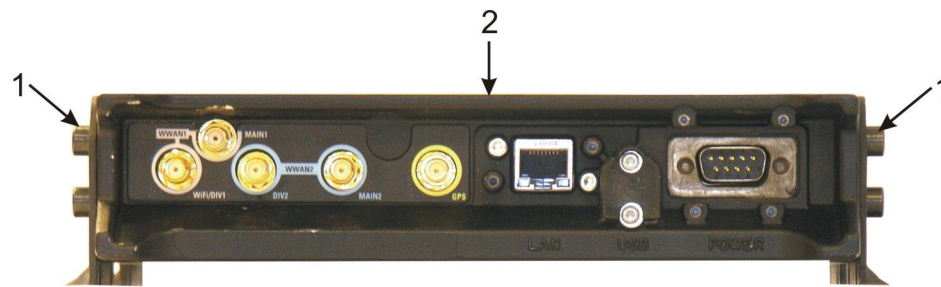

- 2 Locate the VML750 with the mounting brackets attached on the dedicated flat surface.
- 3 Centerpunch the marked spots and fix the modem in position using the self-drilling supplied screws.

Cables Routing and Connection Procedure

DC Power and Ignition Cable Installation



NOTE

The unit is used with a negative ground system only.
The FKN8663/FKN8671 DC Power cable is equipped with a 5-Ampere fuse (slow-blow).
Verify that the vehicle electrical system can support current values larger than that.



CAUTION

Insert the fuse into the fuse holder after installation completion and after carefully inspecting all connections.

The VML750 supports 12/24 V vehicle batteries, i.e. 13.8 V \pm 20% and 27.6 V \pm 20% DC vehicle batteries. Connecting the VML750 to a higher voltage battery source (i.e. 48V) may damage it.

See [Figure 2-10](#) before routing or connecting the DC Power and Ignition cable and use the following process.

Figure 2-10 DC Power and Ignition Cable Routing Into Engine Compartment

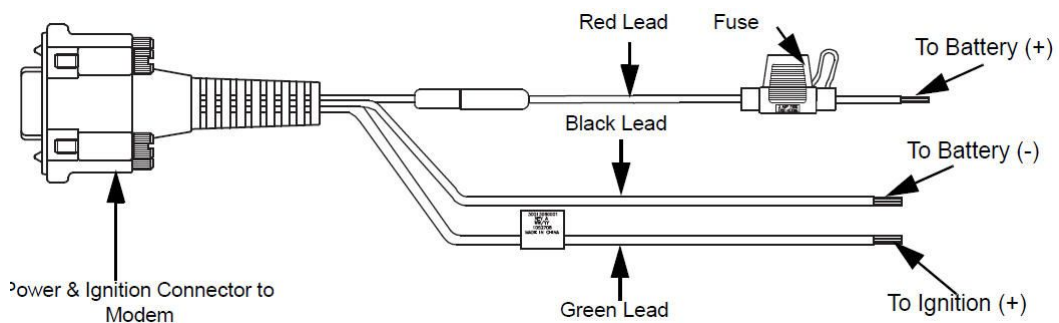

[Procedure 2-3](#) describes how to install the DC power and ignition cable.

Procedure 2-3 How to Install the DC Power and Ignition Cable

- 1 Remove the fuse from the fuse holder. Route the DC Power cable leads through the firewall and into the engine compartment. Use an existing opening or, if necessary, drill a 2 cm (26/32") diameter hole through the firewall. Insert a grommet into the hole to prevent damage to the DC Power cable.

Procedure 2-3 How to Install the DC Power and Ignition Cable (Continued)

2	On the engine side of the firewall, connect the black lead to the negative (-) battery terminal.
3	<p>On the engine side of the firewall, connect the red (A+) lead to the vehicle's battery as follows:</p> <ol style="list-style-type: none"> 1. Verify that the fuse holder is at a distance of 20-30 cm (7.87-11.8") away from the connection point, ensuring that it is not close to any hot engine component. 2. Mount the fuse holder using the provided mount, and dress wires as necessary. Connect the red lead plug adaptor (on the fuse holder) to the matching receptacle on the red lead of the DC Power cable. 3. Connect the red lead of the DC Power cable to the positive (+) battery terminal. Cable tie the wire every 4" (10 cm) along its length, do not tie to existing vehicle cables 4. Insert the fuse into the fuse holder.
4	Verify that the cables in the engine compartment do not obstruct any of the vehicle controls or touch hot or moveable parts of the engine.
5	<p>For ignition installation, perform the following steps:</p> <ol style="list-style-type: none"> 1. Consult the vehicle documentation to locate the ignition wire. 2. Verify that the voltage is high with ignition on, during start (cranking), accessory, and while vehicle is running. When the ignition is off, the voltage is zero. 3. Connect the green lead of the DC Power cable to ignition (+). Cable tie the wire every 4" (10 cm) along its length, do not tie to existing vehicle systems.
6	Connect the DC Power and ignition cable connector to POWER connector on the VML750 Connector panel. Fasten the connector using the four fastening screws.

Antenna Cables Installation (Main and Diversity) for LTE Private Network Configuration

Procedure 2-4 How to Install Antenna Cables (Main and Diversity)

1	<p>For WWAN1 antenna cables installation:</p> <ol style="list-style-type: none"> 1. Connect the connector of the cable marked with "External" to the WWAN1 Main port on the VML750 connector panel. 2. Connect the connector of the cable marked with "Internal" to the WWAN1 DIV port on the VML750 connector panel. 3. Connect the connector of the cable marked with "GPS" to the GPS port on the VML750 connector panel.
----------	--

Procedure 2-4 How to Install Antenna Cables (Main and Diversity) (Continued)

- 2** For WWAN2 antenna cable installation (two identical antennas for main and div.):
1. Connect the antenna to WWAN2 Main port on the VML750 connector panel.
 2. Connect the antenna to WWAN2 Div. port on the VML750 connector panel.



IMPORTANT

Do not use pliers or any other metallic tool for tightening. Hand tighten only! Fully tighten the antenna cable connector and verify it is well fastened.

Antenna Cables Installation (Main and Diversity) for B20 LTE only Configuration

Procedure 2-5 How to Install Antenna Cables (Main and Diversity)

1



NOTE

The combo antenna is provided with three flexible coaxial cables coming out of the antenna bottom side (two threads for internal and GPS are used). Two 12ft coaxial cables are also provided in order to connect between the internal and GPS threads and the modem connectors.

Connect the internal cable connector to the WWAN2 DIV port on the VSM connector panel.

Connect the GPS cable connector to the GPS port on the VSM connector panel.



IMPORTANT

Be sure to connect the RG-174 cable to the GPS connector.
Form a service loop to contain any excess cable length. It is required to form the service loop for the flexible cables coming out of the antenna bottom near the cable exit. These service loops should have a minimum bend radius of 1" (2.54 cm). If needed, form a second service loop for the excess length of the jumper cables near the VSM with minimum bend radius of 3" (7.63 cm). Use plastic cable ties to secure the cable.

Procedure 2-5 How to Install Antenna Cables (Main and Diversity) (Continued)

2	<p>For the Main antenna, connect the RF cable from the antenna to WWAN2 main.</p> <div style="display: flex; align-items: center;"><div style="background-color: #800040; color: white; padding: 2px 5px; font-weight: bold;">IMPORTANT</div></div> <p>Do not use pliers or any other metallic tool for tightening. Hand tighten only! Fully tighten the antenna cable connector and verify it is well fastened.</p>
----------	---

LAN/Ethernet Cable Installation

Procedure 2-6 How to Install the LAN/Ethernet Cable

1	<p>Connect the LAN/Ethernet cable from the LAN connector on the Connector panel to your vehicle's Mobile Data Terminal.</p> <div style="display: flex; align-items: center;"><div style="background-color: #800040; color: white; padding: 2px 5px; font-weight: bold;">IMPORTANT</div></div> <p>Do not use pliers or any other metallic tool for tightening. Hand tighten only! Fully tighten the LAN/Ethernet cable connector and verify it is well fastened.</p>
2	<p>Follow the LAN/Ethernet cable $8 \pm 2''$ (20 ± 5 cm) away from where it attaches to the VML750 and secure it to the vehicle body.</p>

Micro USB Cable Installation



NOTE

Perform the following procedure if you are not installing the LAN/Ethernet cable.

Procedure 2-7 How to Install the Micro USB Cable

1	<p>Connect the Micro USB cable from the Micro USB connector on the Connector panel to your vehicle's Mobile Data Terminal USB connector.</p> <div style="display: flex; align-items: center;"><div style="background-color: #800040; color: white; padding: 2px 5px; font-weight: bold;">IMPORTANT</div></div> <p>Do not use pliers or any other metallic tool for tightening. Hand tighten only! Fully tighten the Micro USB cable connector and verify it is well fastened.</p>
----------	--

Procedure 2-7 How to Install the Micro USB Cable (Continued)

- 2 Follow the Micro USB cable $8 \pm 2''$ (20 ± 5 cm) away from where it attaches to the VML750 and secure it to the vehicle body.

SIM Installation

If your LTE modem is intended to home on your private Motorola LTE network, you will be provided with a Motorola LTE SIM card. If your LTE modem is intended to home on a public carrier LTE network, you will need to obtain a SIM card from that public carrier to be inserted into the VML750.

Procedure 2-8 How to Install a SIM Card

- 1 Locate the SIM card door on the front right side of the VML750. Unscrew the door and put to the side.

**NOTE**

If a SIM card is in the slot, your LTE modem has been staged for you (refer to *VML750 Configuration Guide P/N 6802988C55* if required); skip to [step 4](#).

- 2 Locate the SIM card provided for you by Motorola or your public carrier. Hold the card so that the metal contacts are facing down.

- 3 Insert the card into the SIM slot until you feel it 'click' into place.

**NOTE**

SIM 1 slot is for private network.
SIM 2 slot is for public carrier network.

- 4 Close the door and screw it back into place. Make sure the screw is well tightened and that the door does not move.

CryptR Card Removal and Installation

Perform the following procedures if you are required to replace the CryptR card.



IMPORTANT

Verify that your VML750 is disconnected from the power source prior to performing the following procedure.

Procedure 2-9 How to Remove the CryptR Card

- 1 On the VSM bottom cover, open the two Torx 8 captive screws fastening the CryptR card door.

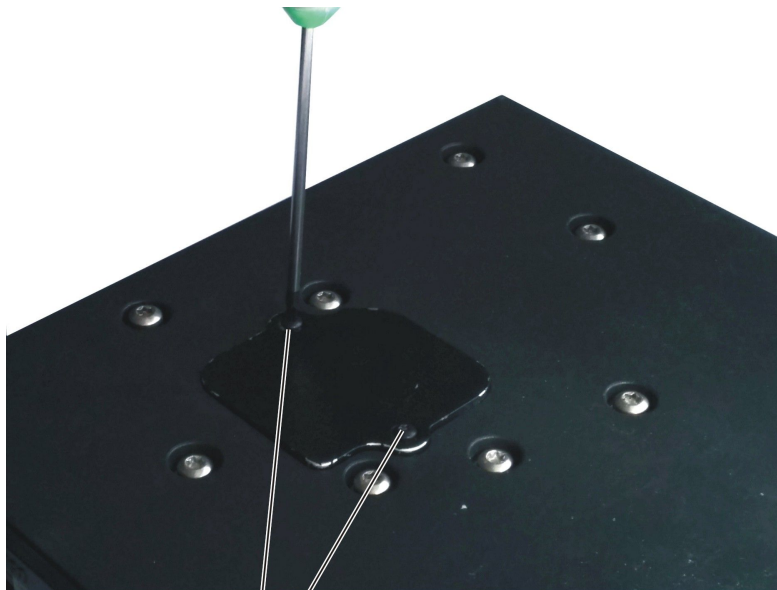

Captive Screws (2)

Procedure 2-9 How to Remove the CryptR Card (Continued)

- 2** Use one of the captive screws to pull the door from the cover.



CryptR Card Door

- 3** Pull the card lock back to release it and lift it up.

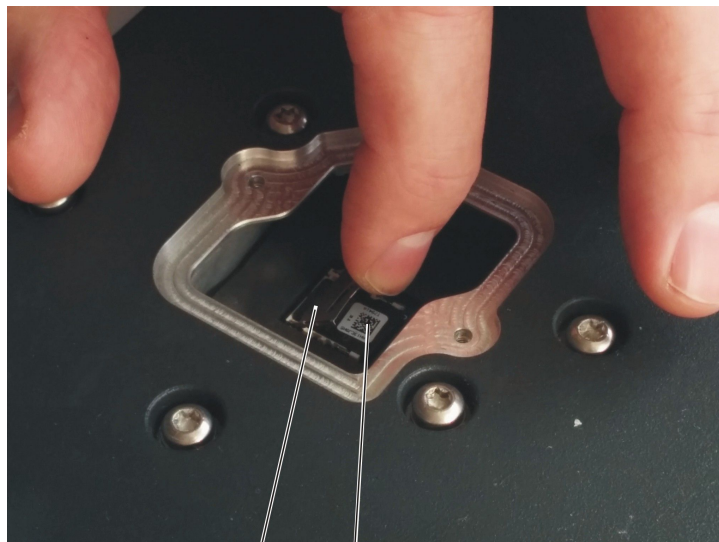

Card Lock
CryptR Card

Procedure 2-9 How to Remove the CryptR Card (Continued)

- 4** Remove the card from the VSM.

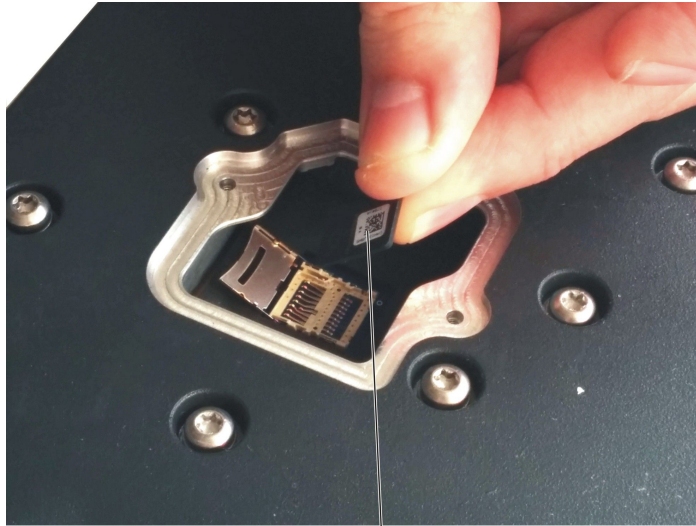

CryptR Card

Procedure 2-10 How to Install the CryptR Card

- 1**



NOTE

Use the photos in [Procedure 2-9](#) to better understand the required steps.

Insert the CryptR card into its location in the VSM.

- 2** Lower the lock and push it forward to lock it.
- 3** Install the card door on the VSM lower cover.
- 4** Close two Torx 8 captive screws. Fasten with a torque of 12 Inch-Lib.

Cap Installation

Procedure 2-11 How to Install Cap(s) on Unused Connector(s)

- 1 To protect any unused connectors (WWAN2, LAN/Ethernet, USB) on the back of the VML750, screw caps provided in the installation kit onto these unused ports.

Powering the Modem Up

Perform the following procedure after installing the modem.

Procedure 2-12 How to Power up the Modem

- 1 Verify that the vehicle's ignition switch is in On position .
- 2 Press and hold the Power button on the LED Indicator Panel for 2–3 seconds. Release the button when the Power LED turns green (blinking or solid).
- 3 If your modem is connected to a computer using LAN/Ethernet/USB cable, LAN LED turns green. If no LAN/Ethernet/USB cable is connected, LAN LED is off.
- 4 The GPS LED blinks orange while your modem is searching for GPS satellites. After satellites have been acquired, the GPS LED turns green.



NOTE

The time interval for acquiring satellites during initial power up may take up to 5 minutes.

- 5 WiFi LED is tuned off until WiFi configuration was performed (refer to the *VML750 Configuration Guide, P/N 6802988C55*).



NOTE

Does not apply for B20 LTE only configuration.

Procedure 2-12 How to Power up the Modem (Continued)

6 After configuring the modem to WiFi Access Point mode, the WiFi LED turns green. When data is transferred, the WiFi LED blinks green.



NOTE

Does not apply for B20 LTE only configuration.

7



NOTE

If your VML750 is equipped to support LTE, you will need to activate it on the associated LTE network (your own private PS LTE network or on the public carrier network). To do this, contact the manager of your network (Motorola, public carrier, or your own internal technical support) and provide the SIM card identifier number, called the IMSI. This identifier can be found on the plastic credit card frame for the SIM.

If you are in LTE coverage area, the following sequence will take place, if a SIM card is inserted and the SIM door is closed:

1. LTE LED blinks orange while the modem searches for the LTE network.
2. LTE LED blinks green while registering to the network.
3. LTE LED is solid green after registration and activation.



NOTE

The time interval for registering and activating your account may vary and could typically take up to 2 minutes.
If the SIM door is not closed, the LTE LED rapidly blinks red.
If SIM card is not inserted, the LTE LED blinks red.

Troubleshooting the VML750

Motorola has made every effort to ensure that this product is of excellent quality. However, if you experience any problems with the product, please contact your local Motorola service representative with product related information. For complete information on ordering required parts and kits, contact your local customer service representative and refer to [Appendix B, "Reference"](#).

Troubleshooting

This paragraph gives details regarding possible malfunctions that may occur after first time installation of the VML750, their probable cause and the recommended corrective action. For correct LED indications, refer to [Table 3-2](#).



IMPORTANT

Contact Motorola Solutions Support Center (SSC) team for further troubleshooting assistance if necessary. For contact information, refer to "[Motorola Solutions Support Center](#)" on page -xiv.

Table 3-1 Troubleshooting the VML750

Malfunction	Probable Cause	Corrective Action
VML750 does not turn On.	Power cable is not properly connected.	<ol style="list-style-type: none"> 1. Check the cable connections, connect as required and turn the VML750 On. 2. Verify that the Power LED is blinking red (standby mode). 3. Press the Power button to turn On (expect LED behavior according to ignition state).
	Power button was not properly pressed.	<ol style="list-style-type: none"> 1. Apply power to the modem. 2. Verify that the Power LED is blinking red. 3. Press the Power button for 2–3 sec. 4. Verify that the Power LED is blinking orange (in "ignition enabled" mode), or blinking green and then solid green (in "ignition disabled" mode).
No LAN/Ethernet connection.	LAN/Ethernet cable is not connected, or, Micro USB cable is not connected.	Connect the LAN/Ethernet cable (refer to " LAN/Ethernet Cable Installation " on page 2-18) or the Micro USB cable (refer to " Micro USB Cable Installation " on page 2-18) and verify that the LAN LED is green.
No GPS reception.	GPS cable (from Main antenna) is not connected.	<ol style="list-style-type: none"> 1. Connect the GPS cable (refer to "Antenna Cables Installation (Main and Diversity) for B20 LTE only Configuration" on page 2-17 or "Antenna Cables Installation (Main and Diversity) for B20 LTE only Configuration" on page 2-17). 2. Verify that the GPS LED is blinking orange and then changes to solid green.

Table 3-1 Troubleshooting the VML750 (Continued)

Malfunction	Probable Cause	Corrective Action
No WiFi connection.	WiFi was not configured as required.	Refer to <i>VML750 Configuration Guide</i> (6802988C55) located in https://businessonline.motorolasolutions.com for WiFi configuration.
	Div/WiFi cable is not connected.	<ol style="list-style-type: none"> <li data-bbox="948 470 1543 640">1. Connect the Div/WiFi cable (refer to "Antenna Cables Installation (Main and Diversity) for B20 LTE only Configuration" on page 2-17 or "Antenna Cables Installation (Main and Diversity) for B20 LTE only Configuration" on page 2-17). <li data-bbox="948 646 1543 691">2. Verify that the WiFi LED is blinking/solid green.

Table 3-1 Troubleshooting the VML750 (Continued)

Malfunction	Probable Cause	Corrective Action
No LTE connection.	Device has not yet been activated on the LTE network.	 <div style="background-color: #00AEEF; color: white; padding: 2px; display: inline-block; margin-left: 10px;">NOTE</div> <p>The following steps assumes a subscription for the LTE service has been created by your network manager or service provider.</p> <ol style="list-style-type: none"> 1. Locate ICCID (the identifier for the LTE SIM card) or PSN (the device serial number) which will be printed on a sticker affixed to the VML750 casing. 2. Contact the network manager or technical service department and report the ICCID or the PSN number. 3. Verify that your device has been activated on the LTE network. Refer to Procedure 2-12, "How to Power up the Modem," on page 2-23.
	SIM card is not inserted/damaged.	<ol style="list-style-type: none"> 1. Insert a new SIM into relevant SIM slot. Refer to Procedure 2-8, "How to Install a SIM Card," on page 2-19 2. Close the SIM door. 3. Turn the VML750 On. 4. Verify the LTE LED is blinking orange/green and then change to solid green.
	LTE cable (from Main antenna) is not connected.	<ol style="list-style-type: none"> 1. Connect the LTE cable (refer to "Antenna Cables Installation (Main and Diversity) for B20 LTE only Configuration" on page 2-17). 2. Verify the LTE LED is blinking orange/green and then change to solid green. 3. If the above does not help, check the connection between the jumper and the thread cable.
	Missing LTE Band.	Refer to <i>VML750 Configuration Guide</i> (6802988C55) located in https://businessonline.motorolasolutions.com for downloading the licence file.

LED Indicators Functions

Table 3-2 describes the functions of the LED indicators on the VML750 front panel.

Table 3-2 LED Indicators Functions

LED Name:	Power	LAN	WWAN1 (Does not apply for B20 LTE only configuration)	WWAN2	WiFi	GPS
LED Status						
OFF	Power off	No link	Off	Off	Off	Off
Solid Green	Power on	Link is on	Connected	Connected	Available (for AP) Connected (for client)	Tracking
Blinking Green	Powering up	TX/RX Activity	Connecting/ Registering	Connecting/ Registering	TX/RX Activity (for AP) Scanning (for client)	—
Solid Orange	—	—	—	—	—	—
Blinking Orange	No Ignition The user turns the power On (power button pressed) but ignition is off	—	Searching for signal	Searching for signal	—	Searching for signal
Solid Red	—	—	Problem/ Overheat	Problem/ Overheat	Problem/ Overheat	Problem
Blinking Red	Standby External power is connected to the system	—	SIM card is not installed in the modem	SIM card is not installed in the modem	—	—
Rapid Blinking Red	Problem	—	SIM door is open	SIM door is open	—	—

This page intentionally left blank.

Using the VML750

General

After installing the VML750 in your vehicle it must be configured for proper operation. To configure your modem, refer to *VML750 Configuration Guide P/N 6802988C55*. After configuring the modem, it should be turned on automatically upon your vehicle ignition and operate properly.

If you detect any malfunction in the VML750 operation, refer to [Chapter 3, "Troubleshooting the VML750"](#).

This page intentionally left blank.

Specifications

Physical

Dimensions (Modem)	8.07"x7.87"x1.71" (20.5 cm x 20 cm x 4.35 cm \pm 1 mm)
Weight (Modem)	6 Pounds (2.5 Kg)

Communication Ports

Amphenol	LAN – Ethernet 10/100 – RJ45 USB 2.0 high speed – Micro AB
----------	---

RF Ports

WWAN1 MAIN1	SMA connector (Female) (does not apply for B20 LTE only configuration)
WWAN1 Diversity + WiFi	SMA connector (Female) (does not apply for B20 LTE only configuration)
WWAN2 Main Rx/Tx	SMA connector (Female)
WWAN2 Diversity(Diversity + WiFi for B20 LTE only)	SMA connector (Female)
GPS	SMA connector (Female)

Power Port

Power	9-pin D-TYPE
-------	--------------

LEDs

Refer to [Table 3-2](#).

Operating Temperature

Ambient temperature	-30°C to +60°C
---------------------	----------------

Power

Input Voltage	11 to 33 VDC
Power Consumption:	
Modem Standby	≤ 0.3 A RMS
Modem Transmit	≤ 1 A RMS

RF Characteristics

Frequency:	
LTE	4G BC14 Tx 788–798 MHz 4G BC14 Rx 758–769 MHz 4G BC13 Tx 777–787 MHz 4G BC13 Rx 746–756 MHz
EVDO	3G BC0 Tx 824–849 MHz 3G BC0 Rx 869–894 MHz 3G BC1 Tx 1850–1910 MHz 3G BC1 Rx 1930–1990 MHz
WiFi	2401-2472 MHz
Bandwidth:	
LTE	5 MHz 10 MHz
WiFi	20 MHz (802.11b/g/n)

Output transmit power:	
LTE	23 dBm
EVDO	23 dBm
WiFi	15 dBm
Receiver sensitivity:	
LTE	10 MHz -94 dBm, typ -96 dBm 5 MHz -97 dBm, typ -99 dBm
WiFi (802.11g)	-87 dBm
Frequency Stability:	
LTE	± 2.5 ppm
WiFi	± 20 ppm

This page intentionally left blank.

Reference

Replacement Parts

Replace damaged parts with identical replacement parts.
For complete information on ordering required parts and kits, please contact your local Motorola service representative.

Replacement Parts List

Kit/Part Number	Description
Antennas	
Refer to " Approved Antennas List " on page B-2	
Bracket, Screws & Washers	
0312002B14	Mounting Screw, Bracket to Car, 8
03013013001	Mounting Screw, VSM to Bracket, 8
0487779V56	Flat Washer, VSM to Bracket, 8
0487623U12	Spring Washer, VSM to Bracket, 8
07013065001	Bracket, 2
Cables	
FKN8570	LAN/Ethernet Cable (177"/450 cm)
FKN8730	Micro USB cable
FKN8663	DC Power & Ignition Cable (177"/450 cm)
FKN8671	DC Power & Ignition Cable + GPIO (177"/450 cm)
SIM card	
TBD	SIM Card Kit (the x stands for the customer number)
CryptR card	
TBD	CryptR Micro SD card

Kit Replacement Parts List

Kit/Part Number	Description
FLN1310	VML750, BC20 LTE VSM Modem
FLN1057	VML750, VzW LTE VSM Modem

Approved Antennas List

Kit/Part Number	Kit Description
AN000036A01	VML750 base antenna with a cap
FTN0073 (85013022001)	Wideband Fix-Mounted Vehicular Antenna (12 ft cable)
FTN7686 (85013016001)	LTE Whip Antenna
FTN6070 (85013022001)	Wideband Fix-Mounted Vehicular Antenna (17 ft cable)

Antennas Cables Replacements

Kit/Part Number	Kit Description
CB000133A01	SMA-F to SMA-M 12 ft RG174 cable type
CB000133A02	SMA-F to SMA-M 17 ft RG174 cable type
30013096001	NMO Antenna Mount
30013072001	SMA-F to SMA-M 12 ft LMR200 cable type
30013093001	SMA-F to SMA-M 17 ft LMR240 cable type

LTE & LMR Antennas Mounting Recommendations

This appendix provides procedures for determining the mounting locations for a Public Safety Narrow Band (PSNB) LMR 700/800MHz antenna and Broad Band (BB) LTE 700MHz antennas.

The following procedures are given:

- Police patrol vehicle with a PSNB antenna and a standard BB antenna.
- Bus with a PSNB antenna and a low profile BB antenna

Police Patrol Vehicle Antennas Location Considerations — Overview

The antennas mounting location is selected individually for every vehicle before starting the actual installation process. The following list gives general recommendations for determining the mounting location of PSNB and BB antennas based on several key considerations:

- Keep a minimum distance of 7.87” (20 cm) between the LTE [BB] antennas; including WiFi to any other antenna and any potential bystander (for bystander safety).
- Follow the guidelines in the installation and safety manuals of the LMR [PSNB] radios with regards to mounting locations and operation of radio in the presence of bystanders (for bystander safety).
- Keep a minimum spatial separation of 78” (198 cm) between the PSNB and BB LTE antennas this separation provides a minimum of 35 dB isolation to reduce interferences.
- Keep a minimum spatial separation of 36” (91.4 cm) between the two BB LTE (main and diversity) antennas for potential interference reduction and for optimal Multiple Input Multiple Output (MIMO) and Maximum Ratio diversity Combining (MRC) performance.

Planning Antenna Mounting Location on a Police Patrol Vehicle

Figure C-1 shows a basic suggestion for antennas location. Procedure C-1 describes the planning.

Figure C-1 Police Patrol Vehicle — Antennas Location Suggestion

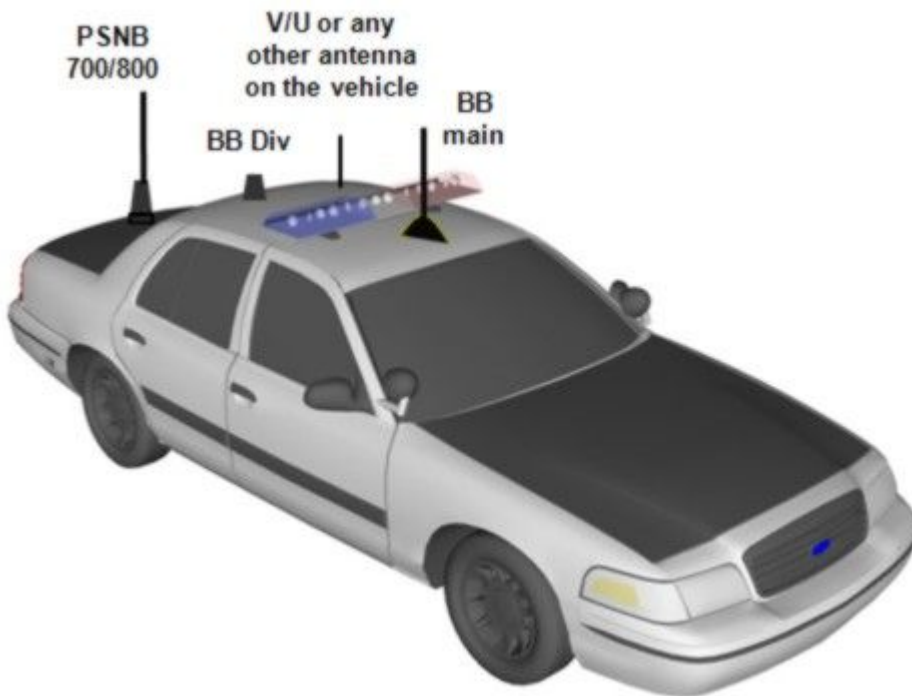

Legend:

- BB — Broad Band LTE Antennas
- PSNB — Public Safety Narrow Band 700/800 Antenna
- V/U — Existing VHF/UHF Antenna



IMPORTANT

Antennas must be installed on a flat metal surface (minimum size 24” (61 cm) x 24” (61 cm)).

Procedure C-1 Planning Antennas Location on a Police Patrol Vehicle

1	Observe the existing antennas.
2	Draw an imaginary 36” (91.4 cm) radius circles around the existing antennas.

Procedure C-1 Planning Antennas Location on a Police Patrol Vehicle (Continued)

3	Draw imaginary lines 7.8" (20 cm) from both sides of the vehicle's roof and trunk cover.
4	Plan mounting the antennas on areas determined by step 2 and 3 i.e. not closer than 36" (91.4 cm) to any existing antenna and at least 7.8" (20 cm) from the vehicle sides.
5	Plan the antennas mounting locations, taking into account the available coaxial cables length.
6	If possible, plan mounting the PSNB antenna on the vehicle's trunk cover.
7	Define the Diversity BB antenna location on the vehicle's roof with a minimum direct distance of 78" (198 cm) from the PSNB antenna. If a PSNB antenna is not required, plan mounting the Diversity/WiFi antenna on the vehicle's trunk cover.
8	Define the Main BB antenna location on the vehicle's roof with a minimum distance of 36" (91.4 cm) to the Diversity BB antenna and of 78" (198 cm) to the PSNB antenna. It is recommended to install the main antenna on the center line at the front side of the vehicle's roof.
9	Some vehicles may already have a PSNB antenna mounted. For these vehicles, it is recommended to reinstall the PSNB antenna on the vehicle's trunk cover.