



PROFESSIONAL DIGITAL TWO-WAY RADIO

MOTOTRBO™

XPR 5550/XPR 5550e, XPR 5580/XPR 5580e
ALPHANUMERIC DISPLAY MOBILE RADIO

USER GUIDE

en-US

fr-CA



OCTOBER 2018

© 2018 Motorola Solutions, Inc. All rights reserved.



MN003677A01-AD

Declaration of Conformity

This declaration is applicable to your radio only if your radio is labeled with the FCC logo shown below.

Declaration of Conformity

Per FCC CFR 47 Part 2 Section 2.1077(a)



Responsible Party

Name: Motorola Solutions, Inc.

Address: 1303 East Algonquin Road, Schaumburg, IL 60196-1078, U.S.A.

Phone Number: 1-800-927-2744

Hereby declares that the product:

Model Name: **XPR 5550/XPR 5580/XPR 5550e/XPR 5580e**

conforms to the following regulations:

FCC Part 15, subpart B, section 15.107(a), 15.107(d), and section 15.109(a)

Class B Digital Device

As a personal computer peripheral, this device complies with Part 15 of the FCC Rules. This device complies with Industry Canada licence-exempt RSS standard(s). Operation is subject to the following two conditions:

- 1 This device may not cause harmful interference, and
- 2 This device must accept any interference received, including interference that may cause undesired operation.

**NOTICE:**

This equipment has been tested and found to comply with the limits for a Class B digital device, pursuant to part 15 of the FCC Rules. These limits are designed to provide reasonable protection against harmful interference in a residential installation. This equipment generates, uses and can radiate radio frequency energy and, if not installed and used in accordance with the instructions, may cause harmful interference to radio communications. However, there is no guarantee that interference will not occur in a particular installation.

If this equipment does cause harmful interference to radio or television reception, which can be determined by turning the equipment off and on, the user is encouraged to try to correct the interference by one or more of the following measures:

- Reorient or relocate the receiving antenna.
- Increase the separation between the equipment and receiver.
- Connect the equipment into an outlet on a circuit different from that to which the receiver is connected.
- Consult the dealer or an experienced radio or TV technician for help.

Contents

Declaration of Conformity.....	2	Viewing WAVE Endpoints Information.....	42
Important Safety Information.....	28	Changing WAVE Configuration.....	43
Notice to Users (FCC and Industry Canada).....	29	Making Group Calls.....	43
Software Version.....	30	Part I: Capacity Max Operations.....	45
Copyrights.....	31	Push-To-Talk (PTT) Button.....	45
Computer Software Copyrights.....	33	Programmable Buttons.....	45
Handling Precautions.....	34	Assignable Radio Functions.....	46
Chapter 1: Basic Operations.....	35	Assignable Settings or Utility Functions.....	48
Powering Up the Radio.....	35	Accessing Programmed Functions.....	48
Powering Off the Radio.....	35	Status Indicators.....	49
Adjusting the Volume.....	35	Icons.....	49
Chapter 2: Radio Controls.....	37	LED Indicator.....	55
Volume/Channel Knob.....	37	Tones.....	55
Setting Dual Knob Operation		Audio Tones.....	56
Preference.....	38	Indicator Tones.....	56
Keypad Microphone Buttons.....	39	Registration.....	56
Chapter 3: WAVE.....	41	Zone and Channel Selections.....	58
Setting Active WAVE Channel	41	Selecting Zones	58
Viewing WAVE Channel Information.....	42	Selecting Zones by Using the Alias	
		Search.....	58
		Selecting a Call Type.....	59
		Selecting a Site.....	59

Roam Request.....	59	Making Private Calls.....	71
Site Lock On/Off.....	60	Making Private Calls by Using the Programmable Number Key	72
Site Restriction.....	60	Making Private Calls by Using the Alias Search	73
Site Trunking	61	Making a Private Call with a One Touch Call Button.....	74
Calls.....	61	Making Private Calls by Using the Manual Dial	75
Group Calls.....	62	Receiving Private Calls.....	76
Making Group Calls.....	62	Accepting Private Calls.....	77
Making Group Calls by Using the Contacts List.....	63	Declining Private Calls.....	77
Making Group Calls by Using the Programmable Number Key	64	All Calls.....	78
Making Group Calls by Using the Alias Search	65	Making All Calls.....	78
Responding to Group Calls.....	67	Making All Calls by Using the Programmable Number Key	78
Broadcast Call.....	68	Making All Calls by Using the Alias Search.....	79
Making Broadcast Calls.....	68	Receiving All Calls.....	81
Making Broadcast Calls Using the Contact List.....	69	Phone Calls.....	81
Making Broadcast Calls Using the Programmable Number Key..	70	Making Phone Calls.....	82
Receiving Broadcast Calls.....	70		
Private Call.....	71		

Making Phone Calls with the Programmable Button 	83	Turning Talkgroup Scan On or Off.....	97
Making Phone Calls by Using the Contacts List	85	Receive Group List.....	97
Making Phone Calls by Using the Alias Search.....	87	Priority Monitor.....	98
Making Phone Calls by Using the Manual Dial.....	89	Editing Priority for a Talkgroup.....	99
Dual Tone Multi Frequency.....	92	Multi-Talkgroup Affiliation.....	100
Initiating DTMF Calls.....	92	Adding Talkgroup Affiliation.....	100
Responding to Phone Calls as All Calls.....	92	Removing Talkgroup Affiliation..	101
Responding to Phone Calls as Group Calls.....	92	Talkback.....	101
Responding to Phone Calls as Private Calls.....	93	Bluetooth.....	102
Call Preemption.....	94	Turning Bluetooth On and Off....	103
Voice Interrupt.....	94	Connecting to Bluetooth Devices.....	103
Enabling Voice Interrupt.....	94	Connecting to Bluetooth Devices in Discoverable Mode...	104
Advanced Features.....	95	Disconnecting from Bluetooth Devices.....	105
Call Queue.....	95	Switching Audio Route between Internal Radio Speaker and Bluetooth Device.....	106
Priority Call.....	96	Viewing Device Details.....	106
Talkgroup Scan.....	96	Deleting Device Name.....	106
		Bluetooth Mic Gain.....	107

Indoor Location.....	107	Removing Associations Between Entries and Programmable Number Keys.....	116
Turning Indoor Location On or Off.....	108	Adding New Contacts	117
Accessing Indoor Location Beacons Information.....	109	Call Indicator Settings.....	118
Multi-Site Controls.....	109	Activating or Deactivating Call Ringers for Private Calls.....	118
Starting Manual Site Search.....	109	Activating or Deactivating Call Ringers for Text Messages	118
Site Lock On/Off.....	110	Activating or Deactivating Call Ringers for Call Alerts.....	119
Accessing Neighbor Sites List...	110	Activating or Deactivating Call Ringers for Selective Calls.....	120
Home Channel Reminder.....	111	Activating or Deactivating Call Ringers for Telemetry Status with Text.....	120
Muting the Home Channel Reminder.....	111	Assigning Ring Styles.....	121
Setting New Home Channels.....	111	Escalating Alarm Tone Volume..	122
Remote Monitor.....	112	Call Log Features.....	122
Initiating Remote Monitor.....	112	Viewing Recent Calls.....	122
Initiating Remote Monitor by Using the Contacts List	113	Storing Aliases or IDs from the Call List.....	123
Initiating Remote Monitors by Using the Manual Dial.....	113	Deleting Calls from the Call List.	123
Contacts Settings.....	114		
Assigning Entries to Programmable Number Keys.....	115		

Deleting All Calls from the Call List	124	Responding to Emergency Alarms with Call.....	136
Viewing Details from the Call List.....	125	Status Message.....	137
Call Alert Operation.....	125	Sending Status Messages.....	137
Making Call Alerts.....	126	Sending Status Message by Using Programmable Button.....	138
Making Call Alerts by Using the Contacts List.....	126	Sending a Status Message by Using the Contacts List.....	139
Responding to Call Alerts	127	Sending Status Message by Using Manual Dial.....	139
Mute Mode.....	127	Viewing Status Messages.....	140
Turning On Mute Mode.....	128	Responding to Status Messages	141
Setting Mute Mode Timer.....	128	Deleting a Status Message.....	142
Exiting Mute Mode.....	129	Deleting All Status Messages ...	142
Emergency Operation.....	129	Text Messaging.....	143
Sending Emergency Alarms.....	130	Text Messages.....	143
Sending Emergency Alarms with Call.....	131	Viewing Text Messages .	143
Sending Emergency Alarms with Voice to Follow.....	133	Viewing Telemetry Status Text Messages.....	144
Receiving Emergency Alarms ...	134	Responding to Text Messages.....	144
Responding to Emergency Alarms	135		

- Responding to Text Messages with Quick Text..... 145
- Resending Text Messages 146
- Forwarding Text Messages..... 147
- Forwarding Text Messages by Using the Manual Dial..... 147
- Editing Text Messages.... 148
- Writing Text Messages.... 149
- Sending Text Messages.. 149
- Deleting Text Messages from the Inbox..... 150
- Deleting All Text Messages from the Inbox 151
- Sent Text Messages..... 152
- Viewing Sent Text Messages..... 152
- Sending Sent Text Messages..... 153

- Deleting Sent Text Messages from the Sent Items Folder..... 154
- Deleting All Sent Text Messages from the Sent Items Folder 154
- Saved Text Messages..... 155
- Viewing Saved Text Messages..... 155
- Editing Saved Text Messages..... 155
- Deleting Saved Text Messages from the Drafts Folder..... 156
- Quick Text Messages 157
- Sending Quick Text Messages 157
- Text Entry Configuration..... 158
- Enabling or Disabling Word Correct..... 158
- Enabling or Disabling Word Predict..... 159
- Sentence Cap..... 160
- Viewing Custom Words..... 160

Editing Custom Words.....	161	Stunning a Radio by Using the Manual Dial.....	174
Adding Custom Words.....	162	Reviving a Radio.....	174
Deleting a Custom Word.....	163	Reviving a Radio by Using the Contacts List.....	175
Deleting All Custom Words.....	164	Reviving a Radio by Using the Manual Dial.....	176
Job Tickets.....	164	Radio Kill.....	177
Accessing the Job Ticket Folder	165	Lone Worker.....	177
Logging In or Out of the Remote Server.....	166	Password Lock Features.....	177
Creating Job Tickets.....	166	Accessing Radios by Using Passwords.....	177
Responding to Job Tickets.....	167	Unlocking Radios in Locked State.....	178
Sending Job Tickets Using One Job Ticket Template.....	168	Turning Password Lock On or Off.....	178
Sending Job Tickets Using More Than One Job Ticket Template..	168	Changing Passwords.....	179
Deleting Job Tickets.....	169	Notification List	180
Deleting All Job Tickets.....	170	Accessing Notification List	181
Privacy.....	170	Over-the-Air Programming	181
Turning Privacy On or Off.....	171	Selecting Third-Party Peripherals Connection Modes.....	182
Stun/Revive.....	172	Received Signal Strength Indicator.....	182
Stunning a Radio.....	172		
Stunning a Radio by Using the Contacts List	173		

Viewing RSSI Values.....	182	Setting Tones/Alerts Volume Offset Levels.....	192
Front Panel Configuration.....	183	Turning Talk Permit Tone On or Off....	192
Entering Front Panel Configuration Mode.....	183	Turning Power Up Tone On or Off.....	193
Editing FPC Mode Parameters..	183	Setting Text Message Alert Tones.....	194
Wi-Fi Operation.....	183	Changing Display Modes.....	194
Turning Wi-Fi On or Off.....	184	Adjusting Display Brightness.....	195
Connecting to a Network Access Point.....	185	Turning Horns/Lights On or Off	195
Checking Wi-Fi Connection Status	186	Turning LED Indicators On or Off.....	196
Refreshing the Network List.....	186	Turning Public Address System On or Off.....	197
Adding a Network.....	187	Turning External Public Address System On or Off.....	197
Viewing Details of Network Access Points.....	188	Turning Introduction Screen On or Off..	198
Removing Network Access Points.....	189	Setting Languages.....	199
Utilities.....	189	Identifying Cable Type.....	199
Power Levels.....	189	Turning Voice Announcement On or Off	200
Setting Power Levels.....	190	Turning Option Board On or Off.....	200
Turning Radio Tones/Alerts On or Off..	190	Text-to-Speech.....	200
Turning Keypad Tones On or Off.....	191	Setting Text-to-Speech.....	201
		Setting Menu Timer.....	201

Turning Digital Microphone AGC On or Off	202	Additional Radio Controls in Connect Plus Mode.....	212
Turning Intelligent Audio On or Off.....	202	Push-To-Talk (PTT) Button.....	212
Turning the Acoustic Feedback Suppressor Feature On or Off.....	203	Programmable Buttons.....	212
Turning Trill Enhancement On or Off....	204	Assignable Radio Functions.....	213
Audio Ambience.....	205	Assignable Settings or Utility Functions.....	214
Setting Audio Ambience.....	205	Identifying Status Indicators in Connect Plus Mode.....	215
Audio Profiles.....	206	Display Icons.....	215
Setting Audio Profiles.....	206	Call Icons.....	217
Turning Global Navigation Satellite System On or Off.....	207	Advanced Menu Icons.....	218
General Radio Information	207	Sent Item Icons	218
Checking Radio Alias and ID	208	Bluetooth Device Icons.....	219
Checking Firmware and Codeplug Versions.....	208	LED Indicator.....	220
Checking Software Update Information.....	209	Indicator Tones.....	220
Checking GNSS Information.....	209	Alert Tones.....	221
Displaying Site Information.....	210	Switching Between Connect Plus and Non-Connect Plus Modes.....	221
Viewing Enterprise Wi-Fi Certificate Details.....	210	Making and Receiving Calls in Connect Plus Mode.....	221
Part II: Connect Plus Operations.....	212	Selecting a Site.....	221



Roam Request.....	222	Inbound Phone Multi-Group Call	228
Site Lock On/Off.....	222	Making a Radio Call.....	228
Site Restriction.....	222	Making a Call with the Channel	
Selecting a Zone.....	223	Selector Knob.....	229
Using Multiple Networks.....	224	Making a Group Call.....	229
Selecting a Call Type.....	224	Making a Private Call.....	230
Receiving and Responding to a Radio		Making a Site All Call.....	230
Call.....	224	Making a Multi-group Call	
Receiving and Responding to a		231
Group Call.....	225	Making a Private Call with a	
Receiving and Responding to a		One Touch Call Button.....	231
Private Call.....	225	Making a Call with the	
Receiving a Site All Call.....	226	Programmable Manual Dial	
Receiving an Inbound Private		Button.....	232
Phone Call.....	227	Making a Private Call.....	232
Making a Buffered Over-		Making an Outbound Private	
Dial in an Inbound Phone		Phone Call with the	
Private Call.....	227	Programmable Manual Dial	
Making a Live Over-Dial		Button.....	233
in an Inbound Phone		Making an Outbound Private	
Private Call.....	228	Phone Call via the Phone Menu	234
Receiving an Inbound Phone		Making an Outbound Private	
Talkgroup Call.....	228	Phone Call from Contacts.....	234























Waiting for the Channel Grant in an Outbound Private Phone Call	236	Responding to a Transmission During a Scan.....	243
Making a Buffered Over-Dial in a Connected Outbound Private Phone Call.....	236	User Configurable Scan.....	243
Making a Live Over-Dial in a Connected Outbound Private Phone Call.....	237	Turning Scan On or Off.....	244
Advanced Features in Connect Plus Mode....	237	Editing the Scan List.....	245
Home Channel Reminder.....	237	Add or Delete a Group via the Add Members Menu.....	246
Auto Fallback.....	238	Understanding Scan Operation.....	248
Indications of Auto Fallback Mode.....	238	Scan Talkback.....	249
Making/Receiving Calls in Fallback Mode.....	239	Editing Priority for a Talkgroup.....	249
Returning to Normal Operation..	239	Contacts Settings.....	250
Radio Check.....	240	Making a Private Call from Contacts.....	251
Sending a Radio Check.....	240	Making a Call Alias Search.....	251
Remote Monitor.....	241	Adding a New Contact.....	252
Initiating Remote Monitor.....	241	Call Indicator Settings.....	253
Scan.....	242	Activating and Deactivating Call Ringers for Call Alert.....	253
Starting and Stopping Scan.....	242	Activating and Deactivating Call Ringers for Private Calls.....	254
		Activating and Deactivating Call Ringers for Text Message.....	254
		Selecting a Ring Alert Type.....	255

Escalating Alarm Tone Volume..	255	Responding to an Emergency	
Call Log.....	256	Call.....	264
Viewing Recent Calls.....	256	Responding to an Emergency	
Deleting a Call from a Call List...256		Alert.....	265
Viewing Details from a Call List. 257		Ignore Emergency Revert Call...265	
Call Alert Operation.....	257	Initiating an Emergency Call..... 266	
Responding to Call Alerts	258	Initiating an Emergency Call	
Making a Call Alert from the		with Voice to Follow.....	266
Contact List.....	258	Initiating an Emergency Alert..... 267	
Making a Call Alert with the One		Exiting Emergency Mode.....	267
Touch Access Button.....	259	Text Messaging.....	268
Mute Mode.....	259	Sending a Quick Text Message. 268	
Turning On Mute Mode.....	260	Sending a Quick Text Message	
Setting Mute Mode Timer.....	260	with the One Touch Access	
Exiting Mute Mode.....	261	Button.....	269
Emergency Operation.....	261	Accessing the Drafts Folder.....	269
Receiving an Incoming		Viewing a Saved Text	
Emergency.....	263	Message.....	269
Saving the Emergency Details		Editing and Sending a	
to the Alarm List.....	263	Saved Text Message.....	270
Deleting the Emergency Details.264		Deleting a Saved Text	
		Message from Drafts.....	271







Managing Fail-to-Send Text Messages.....	272	Deleting All Text Messages from the Inbox	279
Resending a Text Message.....	272	Privacy.....	280
Forwarding a Text Message.....	272	Making a Privacy-Enabled (Scrambled) Call.....	281
Managing Sent Text Messages. 273		Security.....	281
Viewing a Sent Text Message.....	273	Radio Disable.....	282
Sending a Sent Text Message.....	274	Radio Enable.....	283
Deleting All Sent Text Messages from Sent Items.....	275	Bluetooth Operation.....	285
Receiving a Text Message.....	276	Turning Bluetooth On and Off....	285
Reading a Text Message.....	276	Finding and Connecting to a Bluetooth Device.....	286
Managing Received Text Messages.....	276	Finding and Connecting from a Bluetooth Device (Discoverable Mode).....	287
Viewing a Text Message from the Inbox.....	277	Disconnecting from a Bluetooth Device.....	287
Replying to a Text Message from the Inbox..	277	Switching Audio Route between Internal Radio Speaker and Bluetooth Device.....	288
Deleting a Text Message from the Inbox.....	278	Viewing Device Details.....	288
		Deleting Device Name.....	289
		Bluetooth Mic Gain.....	289



Indoor Location.....	290	Setting the Tone Alert Volume Offset Level.....	299
Turning Indoor Location On or Off.....	290	Turning the Talk Permit Tone On or Off.....	300
Accessing Indoor Location Beacons Information.....	291	Turning the Power Up Alert Tone On or Off.....	301
Notification List.....	292	Setting the Power Level.....	301
Accessing the Notification List...	292	Changing the Display Mode.....	302
Wi-Fi Operation.....	292	Adjusting the Display Brightness	303
Turning Wi-Fi On or Off.....	293	Turning the Introduction Screen On or Off.....	303
Connecting to a Network Access Point.....	294	Language.....	304
Checking Wi-Fi Connection Status	295	Turning the LED Indicator On or Off.....	305
Refreshing the Network List.....	295	Identifying Cable Type.....	305
Adding a Network.....	296	Voice Announcement.....	305
Viewing Details of Network Access Points.....	297	Menu Timer.....	306
Removing Network Access Points.....	298	Turning Horns/Lights On or Off..	307
Utilities.....	298	Setting Dual Knob Operation Preference.....	307
Turning the Radio Tones/Alerts On or Off.....	298	Digital Mic AGC (Mic AGC-D)....	308
		Intelligent Audio.....	308

Turning the Acoustic Feedback Suppressor Feature On or Off... 310	Assignable Radio Functions..... 324
Turning GNSS On or Off..... 311	Assignable Settings or Utility Functions 327
Accessing General Radio Information..... 311	Accessing Programmed Functions..... 328
Checking the Radio Model Number Index..... 312	Status Indicators..... 328
Checking the CRC of the Option Board OTA Codeplug File..... 312	Icons..... 328
Displaying the Site ID (Site Number)..... 313	LED Indicators 335
Checking the Site Info.... 313	Tones..... 336
Checking the Radio ID.... 314	Indicator Tones..... 336
Checking the Firmware Version and Codeplug Version..... 314	Audio Tones..... 336
Checking for Updates..... 315	Conventional Analog and Digital Modes..... 337
Viewing Enterprise Wi-Fi Certificate Details..... 322	Icon Information..... 337
Part III: Other Systems..... 324	IP Site Connect  337
Push-To-Talk Button 324	Capacity Plus–Single-Site  338
Programmable Buttons..... 324	Capacity Plus–Multi-Site  339
	Zone and Channel Selections..... 339
	Selecting Zones 340
	Selecting Zones by Using the Alias Search..... 340
	Selecting Channels..... 341
	Calls..... 341
	Group Calls..... 342





- Making Group Calls..... 342
- Making Group Calls by Using the Contacts List 343
- Making Group Calls by Using the Programmable Number Key   343
- Responding to Group Calls..... 344
- Private Calls  345
 - Making Private Calls  345
 - Making Private Calls by Using the Contacts List  346
 - Making Private Calls by Using the Manual Dial  347
 - Making Private Calls by Using the Programmable Number Key   348
 - Responding to Private Calls  . 349
- All Calls..... 349
 - Receiving All Calls..... 349
 - Making All Calls..... 350
 - Making All Calls by Using the Programmable Number Key  . 351
- Selective Calls  352
 - Making Selective Calls..... 352
 - Responding to Selective Calls  352
- Phone Calls  353
 - Making Phone Calls  354
 - Making Phone Calls by Using the Contacts List  355
 - Making Phone Calls by Using the Manual Dial  357
 - Making Group, Private, Phone or All Calls by Using the Alias Search   360
 - Dual Tone Multi Frequency..... 362
 - Initiating DTMF Calls..... 362
 - Responding to Phone Calls as Group Calls  362
 - Responding to Phone Calls as All Calls  363
 - Responding to Phone Calls as Private Calls  363
- Stopping Radio Calls  364









Talkaround.....	365	Adding New Entries to the Scan List.....	373
Toggling Between Repeater and Talkaround Modes.....	365	Adding New Entries to the Scan List by Using the Alias Search 🗉	374
Advanced Features.....	365	Deleting Entries from the Scan List.....	375
Home Channel Reminder.....	366	Setting Priority for Entries in the Scan List.....	375
Muting the Home Channel Reminder.....	366	Scan.....	376
Setting New Home Channels.....	366	Turning Scan On or Off	377
Radio Check 🗉	367	Responding to Transmissions During Scanning.....	377
Sending Radio Checks 🗉	367	Deleting Nuisance Channels.....	378
Sending Radio Checks by Using the Manual Dial 🗉	368	Restoring Nuisance Channels... ..	378
Remote Monitor.....	369	Vote Scan 🗉	378
Initiating Remote Monitor.....	369	Contacts Settings.....	379
Initiating Remote Monitor by Using the Contacts List	370	Making Group Calls by Using the Contacts List	379
Initiating Remote Monitor by Using the Manual Dial 🗉	370	Making Private Calls by Using the Contacts List 🗉	380
Scan Lists.....	371		
Viewing Entries in the Scan List	372		
Viewing Entries in the Scan List by Using the Alias Search	372		

- Assigning Entries to Programmable Number Keys  381
- Removing Associations Between Entries and Programmable Number Keys  382
- Adding New Contacts 383
- Setting Default Contact  383
- Call Indicator Settings.....384
 - Activating or Deactivating Call Ringers for Call Alerts..... 384
 - Activating or Deactivating Call Ringers for Private Calls  385
 - Activating or Deactivating Call Ringers for Selective Calls 385
 - Activating or Deactivating Call Ringers for Text Messages  ...386
 - Activating or Deactivating Call Ringers for Telemetry Status with Text.....387
 - Assigning Ring Styles..... 387
 - Escalating Alarm Tone Volume..388

- Call Log Features..... 388
 - Viewing Recent Calls..... 389
 - Deleting Calls from the Call List  389
 - Viewing Call List Details  390
 - Storing Aliases or IDs from the Call List  390
- Call Alert Operation 391
 - Making Call Alerts..... 391
 - Making Call Alerts by Using the Contacts List..... 391
 - Making Call Alerts by Using the Manual Dial..... 392
 - Responding to Call Alerts 393
- Mute Mode.....393
 - Turning On Mute Mode..... 394
 - Setting Mute Mode Timer.....394
 - Exiting Mute Mode..... 395
- Emergency Operation395
 - Receiving Emergency Alarms.... 396
 - Responding to Emergency Alarms.....397

Exiting Emergency Mode After Receiving the Emergency Alarm	398	Responding to Text Messages with Quick Text	405
Sending Emergency Alarms	398	Resending Text Messages	406
Sending Emergency Alarms with Call	399	Forwarding Text Messages	407
Emergency Alarms with Voice to Follow	400	Forwarding Text Messages by Using the Manual Dial	407
Sending Emergency Alarms with Voice to Follow	401	Editing Text Messages	408
Reinitiating Emergency Mode	401	Writing Text Messages	409
Exiting Emergency Mode After Sending the Emergency Alarm	402	Sending Text Messages	409
Deleting an Alarm Item from the Alarm List	402	Deleting Text Messages from the Inbox	410
Text Messaging	403	Deleting All Text Messages from the Inbox	411
Text Messages	403	Sent Text Messages	412
Viewing Text Messages	403	Viewing Sent Text Messages	412
Viewing Telemetry Status Text Messages	404	Sending Sent Text Messages	413
Responding to Text Messages	404		

Deleting Sent Text		Viewing Custom Words.....	420
Messages from the Sent		Editing Custom Words.....	421
Items Folder 	414	Adding Custom Words.....	422
Deleting All Sent Text		Deleting a Custom Word.....	423
Messages from the Sent		Deleting All Custom Words.....	424
Items Folder	414	Job Tickets.....	424
Saved Text Messages.....	415	Accessing the Job Ticket Folder	425
Viewing Saved Text		Logging In or Out of the Remote	
Messages.....	415	Server.....	426
Editing Saved Text		Creating Job Tickets.....	426
Messages.....	415	Responding to Job Tickets.....	427
Deleting Saved Text		Sending Job Tickets Using One	
Messages from the Drafts		Job Ticket Template.....	428
Folder.....	416	Sending Job Tickets Using More	
Quick Text Messages 	417	Than One Job Ticket Template..	428
Sending Quick Text		Deleting Job Tickets.....	429
Messages 	417	Deleting All Job Tickets.....	430
Text Entry Configuration.....	418	Privacy 	430
Enabling or Disabling Word		Turning Privacy On or Off 	431
Correct.....	418	Multi-Site Controls.....	432
Enabling or Disabling Word		Starting Manual Site Search.....	432
Predict.....	419	Site Lock On/Off.....	432
Sentence Cap.....	420		

Accessing Neighbor Sites List... 433	Switching Audio Route between Internal Radio Speaker and Bluetooth Device..... 442
Security  433	Viewing Device Details..... 442
Disabling Radios  433	Deleting Device Name..... 443
Disabling Radios by Using the Contacts List  434	Bluetooth Mic Gain..... 443
Disabling Radios by Using the Manual Dial  435	Indoor Location..... 444
Enabling Radios  435	Turning Indoor Location On or Off..... 444
Enabling Radios by Using the Contacts List  436	Accessing Indoor Location Beacons Information..... 445
Enabling Radios by Using the Manual Dial  437	Notification List 446
Lone Worker..... 438	Accessing Notification List 446
Bluetooth..... 438	Auto-Range Transponder System  ... 446
Turning Bluetooth On and Off.... 439	Over-the-Air Programming  447
Connecting to Bluetooth Devices..... 439	Selecting Third-Party Peripherals Connection Modes..... 447
Connecting to Bluetooth Devices in Discoverable Mode... 441	Received Signal Strength Indicator..... 448
Disconnecting from Bluetooth Devices..... 441	Viewing RSSI Values..... 448
	Password Lock Features..... 449
	Accessing Radios by Using Passwords..... 449

Unlocking Radios in Locked State.....	449	Setting Squelch Levels	458
Turning Password Lock On or Off.....	450	Power Levels.....	459
Changing Passwords.....	451	Setting Power Levels.....	459
Front Panel Configuration.....	451	Turning Radio Tones/Alerts On or Off..	460
Entering Front Panel Configuration Mode.....	452	Turning Keypad Tones On or Off.....	461
Editing FPC Mode Parameters..	452	Setting Tones/Alerts Volume Offset Levels.....	461
Wi-Fi Operation.....	452	Turning Talk Permit Tone On or Off.....	462
Turning Wi-Fi On or Off.....	453	Turning Power Up Tone On or Off.....	463
Connecting to a Network Access Point.....	453	Setting Text Message Alert Tones.....	463
Checking Wi-Fi Connection Status	454	Changing Display Modes.....	464
Refreshing the Network List.....	455	Adjusting Display Brightness.....	465
Adding a Network.....	456	Turning Horns/Lights On or Off	465
Viewing Details of Network Access Points.....	456	Turning LED Indicators On or Off.....	466
Removing Network Access Points.....	457	Turning Public Address System On or Off.....	466
Utilities.....	458	Turning External Public Address System On or Off.....	467
Squelch Levels	458	Turning Introduction Screen On or Off..	468
		Setting Languages.....	468
		Identifying Cable Type.....	469
		Voice Operating Transmission	469

Turning Voice Operating Transmission On or Off.....	470	Turning Global Navigation Satellite System On or Off.....	479
Turning Voice Announcement On or Off	470	Flexible Receive List 📶	479
Turning Option Board On or Off.....	471	Turning Flexible Receive List On or Off.....	480
Text-to-Speech.....	471	General Radio Information	480
Setting Text-to-Speech.....	471	Checking Radio Alias and ID	480
Turning Automatic Call Forwarding On or Off.....	472	Checking Firmware and Codeplug Versions.....	481
Setting Menu Timer.....	473	Checking Software Update Information.....	481
Turning Analog Microphone AGC On or Off	473	Checking GNSS Information.....	482
Turning Digital Microphone AGC On or Off	474	Displaying Site Information.....	483
Turning Intelligent Audio On or Off.....	475	Viewing Enterprise Wi-Fi Certificate Details.....	483
Turning the Acoustic Feedback Suppressor Feature On or Off.....	475	Part IV: Authorized Accessories List.....	484
Turning Trill Enhancement On or Off....	476	Maritime Radio Use in the VHF Frequency Range....	489
Audio Ambience.....	477	Special Channel Assignments.....	489
Setting Audio Ambience.....	477	Emergency Channel.....	489
Audio Profiles.....	478	Non-Commercial Call Channel.....	489
Setting Audio Profiles.....	478	Operating Frequency Requirements.....	490

Declaration of Compliance for the Use of
Distress and Safety Frequencies.....492

Technical Parameters for Interfacing External
Data Sources.....492

Limited Warranty..... 493

MOTOROLA SOLUTIONS
COMMUNICATION PRODUCTS..... 493

I. WHAT THIS WARRANTY COVERS AND
FOR HOW LONG:..... 493

II. GENERAL PROVISIONS..... 494

III. STATE LAW RIGHTS:.....494

IV. HOW TO GET WARRANTY SERVICE.....494

V. WHAT THIS WARRANTY DOES NOT
COVER.....494

VI. PATENT AND SOFTWARE PROVISIONS495

VII. GOVERNING LAW..... 496

Important Safety Information

RF Energy Exposure and Product Safety Guide for Mobile Two-Way Radios

ATTENTION!

This radio is restricted to Occupational use only. Before using the radio, read the RF Energy Exposure and Product Safety Guide for Mobile Two-Way Radios which contains important operating instructions for safe usage and RF energy awareness and control for Compliance with applicable standards and Regulations.

For a list of Motorola Solutions-approved antennas and other accessories, visit the following website:

<http://www.motorolasolutions.com>

Any modification to this device, not expressly authorized by Motorola Solutions, may void the user's authority to operate this device.

Under Industry Canada regulations, this radio transmitter may only operate using an antenna of a type and maximum (or lesser) gain approved for the transmitter by Industry Canada. To reduce potential radio interference to other users, the antenna type and its gain should be so chosen

that the equivalent isotropically radiated power (e.i.r.p.) is not more than that necessary for successful communication.

This radio transmitter has been approved by Industry Canada to operate with Motorola Solutions-approved antenna with the maximum permissible gain and required antenna impedance for each antenna type indicated. Antenna types not included in this list, having a gain greater than the maximum gain indicated for that type, are strictly prohibited for use with this device.

Notice to Users (FCC and Industry Canada)

This device complies with Part 15 of the FCC rules and Industry Canada's license-exempt RSS's per the following conditions:

- This device may not cause harmful interference.
- This device must accept any interference received, including interference that may cause undesired operation.
- Changes or modifications made to this device, not expressly approved by Motorola Solutions, could void the authority of the user to operate this equipment.

Software Version

All the features described in the following sections are supported by the software version **R02.09.00.0000** or later.

See [Checking Firmware and Codeplug Versions on page 208](#) to determine the software version of your radio.

Check with your dealer or system administrator for more information.

Copyrights

The Motorola Solutions products described in this document may include copyrighted Motorola Solutions computer programs. Laws in the United States and other countries preserve for Motorola Solutions certain exclusive rights for copyrighted computer programs. Accordingly, any copyrighted Motorola Solutions computer programs contained in the Motorola Solutions products described in this document may not be copied or reproduced in any manner without the express written permission of Motorola Solutions.

© 2018 Motorola Solutions, Inc. All Rights Reserved

No part of this document may be reproduced, transmitted, stored in a retrieval system, or translated into any language or computer language, in any form or by any means, without the prior written permission of Motorola Solutions, Inc.

Furthermore, the purchase of Motorola Solutions products shall not be deemed to grant either directly or by implication, estoppel or otherwise, any license under the copyrights, patents or patent applications of Motorola Solutions, except for the normal non-exclusive, royalty-free license to use that arises by operation of law in the sale of a product.

[Send Feedback](#)

Disclaimer

Please note that certain features, facilities, and capabilities described in this document may not be applicable to or licensed for use on a specific system, or may be dependent upon the characteristics of a specific subscriber unit or configuration of certain parameters. Please refer to your Motorola Solutions contact for further information.

Trademarks

MOTOROLA, MOTO, MOTOROLA SOLUTIONS, and the Stylized M Logo are trademarks or registered trademarks of Motorola Trademark Holdings, LLC and are used under license. All other trademarks are the property of their respective owners.

European Union (EU) Waste of Electrical and Electronic Equipment (WEEE) directive



■ The European Union's WEEE directive requires that products sold into EU countries must have the crossed out trash bin label on the product (or the package in some cases).

As defined by the WEEE directive, this cross-out trash bin label means that customers and end-users in EU countries

should not dispose of electronic and electrical equipment or accessories in household waste.

Customers or end-users in EU countries should contact their local equipment supplier representative or service centre for information about the waste collection system in their country.

Computer Software Copyrights

The Motorola Solutions products described in this manual may include copyrighted Motorola Solutions computer programs stored in semiconductor memories or other media. Laws in the United States and other countries preserve for Motorola Solutions certain exclusive rights for copyrighted computer programs including, but not limited to, the exclusive right to copy or reproduce in any form the copyrighted computer program. Accordingly, any copyrighted Motorola Solutions computer programs contained in the Motorola Solutions products described in this manual may not be copied, reproduced, modified, reverse-engineered, or distributed in any manner without the express written permission of Motorola Solutions. Furthermore, the purchase of Motorola Solutions products shall not be deemed to grant either directly or by implication, estoppel, or otherwise, any license under the copyrights, patents or patent applications of Motorola Solutions, except for the normal non-exclusive license to use that arises by operation of law in the sale of a product.

The AMBE+2™ voice coding Technology embodied in this product is protected by intellectual property rights including

patent rights, copyrights and trade secrets of Digital Voice Systems, Inc.

This voice coding Technology is licensed solely for use within this Communications Equipment. The user of this Technology is explicitly prohibited from attempting to decompile, reverse engineer, or disassemble the Object Code, or in any other way convert the Object Code into a human-readable form.

U.S. Pat. Nos. #5,870,405, #5,826,222, #5,754,974, #5,701,390, #5,715,365, #5,649,050, #5,630,011, #5,581,656, #5,517,511, #5,491,772, #5,247,579, #5,226,084 and #5,195,166.

Handling Precautions

The MOTOTRBO Series Digital Portable radio meets IP67 specifications, allowing your radio to withstand adverse field conditions such as being submersed in water. This section describes some basic handling precautions.



CAUTION:

Do not disassemble your radio. This could damage radio seals and result in leak paths into the radio. Radio maintenance should only be done in service depot that is equipped to test and replace the seal on the radio.

- If your radio has been submersed in water, shake your radio well to remove any water that may be trapped inside the speaker grille and microphone port. Trapped water could cause decreased audio performance.
- If your radio's battery contact area has been exposed to water, clean and dry battery contacts on both your radio and the battery before attaching the battery to radio. The residual water could short-circuit the radio.
- If your radio has been submersed in a corrosive substance (for example, saltwater), rinse radio and battery in fresh water then dry radio and battery.
- To clean the exterior surfaces of your radio, use a diluted solution of mild dishwashing detergent and fresh water (for example, one teaspoon of detergent to one gallon of water).
- Never poke the vent (hole) located on the radio chassis below the battery contact. This vent allows for pressure equalization in the radio. Doing so may create a leak path into radio and your radio's submersibility may be lost.
- Never obstruct or cover the vent, even with a label.
- Ensure that no oily substances come in contact with the vent.
- Your radio with antenna attached properly is designed to be submersible to a maximum depth of 1 m (3.28 ft) and a maximum submersion time of 30 minutes. Exceeding either maximum limit or use without antenna may result in damage to your radio.
- When cleaning your radio, do not use a high pressure jet spray on radio as this will exceed the 1 m depth pressure and may cause water to leak into your radio.

Basic Operations

This chapter explains the operations to get you started on using the radio.

Powering Up the Radio

Follow the procedure to power up your radio.

Press the **On/Off** button.

If successful:

- A tone sounds.
- The green LED lights up.
- The display shows MOTOTRBO (TM), followed by a welcome message or image.
- The Home screen lights up.

If the Tones/Alerts function is disabled, there is no tone upon powering up.

Check your battery if your radio does not power up. Make sure that it is charged and properly attached. Contact your dealer if your radio still does not power up.

Powering Off the Radio

Follow the procedure to power off your radio.

Press and hold the **On/Off** button.

The radio may take up to seven seconds to completely turn off.

The display shows **Powering Down**.

Adjusting the Volume

Follow the procedure to change the volume level of your radio.

Do one of the following:

- Turn the **On/Off/Volume Control Knob** clockwise to increase the volume.
- Turn the **On/Off/Volume Control Knob** counterclockwise to decrease the volume.



NOTICE:

Your radio can be programmed to have a minimum volume offset where the volume level cannot be lowered past the programmed minimum volume. Check with your dealer or system administrator for more information.

Radio Controls

This chapter explains the buttons and functions to control the radio.

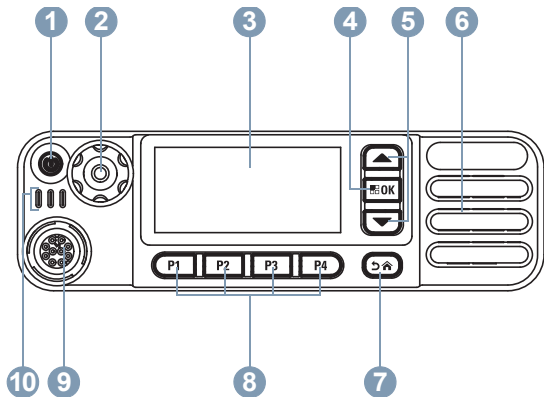

- 1 On/Off/Information Button
- 2 Volume/Channel Knob
- 3 Display
- 4 Menu/OK Button
- 5 Scroll Up/Down Buttons
- 6 Speaker



- 7 Return/Home Button
- 8 Front Programmable Buttons
- 9 Accessory Connector
- 10 LED Indicators

Volume/Channel Knob

The **Volume/Channel Knob** can be programmed for dual volume and channel control, or for volume control only.

To adjust the volume, see [Adjusting the Volume on page 35](#).



To change the channels, press and hold the **Volume/Channel Knob** until the channel selection state is displayed. Turn the **Volume/Channel Knob** to select the channel. Do one of the following to exit the channel selection state:



- Press the **Volume/Channel Knob**.
- Press  .
- Press  .
- Wait for the menu timer to expire.



Setting Dual Knob Operation Preference

Follow the procedure to set the dual knob operation preference of the radio.



- 1 Press  to access the menu.

- 2 Press  or  to Utilities. Press  to select.

- 3 Press  or  to Radio Settings. Press  to select.

- 4 Press  or  to Dual Knob. Press  to select.

The display shows Volume Only and Volume & Channel.











- 5 Press  or  to the required setting. Press  to select.

A ✓ appears beside the selected settings. The screen returns to the previous menu.

Keypad Microphone Buttons

You can use the 3 x 4 alphanumeric keypad on the 4-Way Navigation Keypad Microphone (Motorola Solutions part number RMN5127_) to access your radio features. Many characters require that you press a key multiple times. The table shows the number of times a key needs to be pressed to generate the required character.

Key	Number of Times Key is Pressed												
	1	2	3	4	5	6	7	8	9	10	11	12	13
1 <small>.,?</small>	1	.	,	?	!	@	&	'	%	—	:	*	#
2 <small>ABC</small>	A	B	C	2									
3 <small>DEF</small>	D	E	F	3									
4 <small>GHI</small>	G	H	I	4									
5 <small>JKL</small>	J	K	L	5									

Key	Number of Times Key is Pressed												
	1	2	3	4	5	6	7	8	9	10	11	12	13
	M	N	O	6									
	P	Q	R	S	7								
	T	U	V	8									
	W	X	Y	Z	9								
	0		NOTICE: Press to enter "0" and long press to activate the CAPS lock. Another long press to turn off the CAPS lock.										
	* or del		NOTICE: Press during text entry to delete the character. Press during numeric entry to enter a "*".										
	# or spac e		NOTICE: Press during text entry to insert a space. Press during numeric entry to enter a "#".										

WAVE

Wide Area Voice Environment (WAVE™) provides a new method of making calls between two radios.

This feature also supports calls between radios and other devices with WAVE capabilities. However, a WAVE channel must be set up to use this feature.

When in a WAVE channel, the radio is unable to receive calls from other systems and can only receive WAVE calls.

If the radio is in a WAVE channel, the radio enables Wi-Fi automatically and proceeds to log into the WAVE server. WAVE calls are made when the radio is connected to an IP network through Wi-Fi.



NOTICE:

This feature is applicable to XPR 5550e/XPR 5580e only.

Table 1: WAVE Display Icons

The following icons appear momentarily on the display when WAVE is enabled.



WAVE Connected

WAVE is connected.







WAVE Disconnected



WAVE is disconnected.



Setting Active WAVE Channel

WAVE channels are configured through CPS. Follow the procedure to select the required WAVE channel.

- 1 Press  to access the menu.

- 2 Press  or  to WAVE Channels. Press  to select.

- 3 Press  or  to the required WAVE channel. Press  to select.



- 4 Press  or  to Set As Active. Press  to select.



The display shows  beside the selected channel.



Viewing WAVE Channel Information

Follow the procedure to view WAVE channel information.

- 1 Do one of the following:
 - Press the programmed **WAVE Channel List** button. Skip the following steps.
 - Press  to access the menu.

-
- 2 Press  or  to WAVE Channels. Press  to select.

-
- 3 Press  or  to the required WAVE channel. Press  to select.



-
- 4 Press  or  to View Details. Press  to select.



The display shows the WAVE channel details.

Viewing WAVE Endpoints Information

Follow the procedure to view WAVE Endpoints information.

- 1 Do one of the following:
 - Press the programmed **Contact** button. Skip to [step 3](#).
 - Press  to access the menu.

-
- 2 Press  or  to Endpoints. Press  to select.

-
- 3 Press  or  to the required WAVE Endpoint. Press  to select.



-
- 4 Press  to select View Details.



The display shows the WAVE Endpoint details.



Changing WAVE Configuration



Follow the procedure to set the WAVE server IP address, user ID, and password.



- 1 Press  to access the menu.



- 2 Press  or  to Utilities. Press  to select.



- 3 Press  or  to Radio Settings. Press  to select.

- 4 Press  or  to WAVE. Press  to select.

- 5 Press  to select Server Address. Press  to change the server address. Press  to select.

- 6 Press  to User ID. Press  to change the user ID. Press  to select.

- 7 Press  to Password. Press  to view or change the WAVE password. Press  to select.

- 8 Press  to Apply. Press  to apply all the changes made.

The display shows the positive mini notice momentarily before returning to the Radio Settings screen.

Making Group Calls

Follow the procedure to make group calls on a WAVE Channel.

- 1 Select the WAVE channel with the required group alias or ID.

- 2 Press the **PTT** button to make the call.
The green LED lights up. The first text line displays the **Group Call** icon and alias. The second text line displays the WAVE group alias.

- 3 Do one of the following:

- Wait for the Talk Permit Tone to end and speak clearly into the microphone if enabled.
 - Wait for the **PTT** Sidetone to end and speak clearly into the microphone if enabled
-

4 Release the **PTT** button to listen.

The green LED lights up when the target radio responds. The display shows the **Group Call** icon, and alias or ID, and the transmitting radio alias or ID.

- #### 5 If the Channel Free Indication feature is enabled, you hear a short alert tone the moment the transmitting radio releases the **PTT** button, indicating the channel is free for you to respond. Press the **PTT** button to respond to the call.

The call ends when there is no voice activity for a predetermined period. The radio returns to the screen you were on prior to initiating the call.

Capacity Max Operations

Capacity Max is a control channel-based trunked radio system. Features that are available to the radio users under this system are available in this chapter.

Push-To-Talk (PTT) Button

The **PTT** button serves two basic purposes.

- While a call is in progress, the **PTT** button allows the radio to transmit to other radios in the call. The microphone is activated when the **PTT** button is pressed.
- While a call is not in progress, the **PTT** button is used to make a new call.

Press and hold the **PTT** button to talk. Release the **PTT** button to listen.

If the Talk Permit Tone or the **PTT** Sidetone is enabled, wait until the short alert tone ends before talking.

If the Channel Free Indication feature is enabled on your radio (programmed by your dealer), you will hear a short alert tone the moment the target radio (the radio that is receiving your call) releases the **PTT** button, indicating the channel is free for you to respond.

You hear a continuous Talk Prohibit Tone if your call is interrupted, for example when the radio receives an Emergency call. You should release the **PTT** button.

Programmable Buttons

Depending on the duration of a button press, your dealer can program the programmable buttons as shortcuts to radio functions.

Short press

Pressing and releasing rapidly.

Long press

Pressing and holding for the programmed duration.



NOTICE:

See [Emergency Operation on page 395](#) for more information on the programmed duration of the **Emergency** button.

Assignable Radio Functions

The following radio functions can be assigned to the programmable buttons by your dealer or system administrator.

Audio Ambience

Allows the user to select an environment the radio is operating in.

Audio Profiles

Allows the user to select the preferred audio profile.

Bluetooth® Audio Switch

Toggles audio routing between internal radio speaker and external Bluetooth-enabled accessory.

Bluetooth Connect

Initiates a Bluetooth find-and-connect operation.

Bluetooth Disconnect

Terminates all existing Bluetooth connections between your radio and any Bluetooth-enabled devices.

Bluetooth Discoverable

Enables your radio to enter Bluetooth Discoverable Mode.

Contacts

Provides direct access to the Contacts list.

Call Alert

Provides direct access to the contacts list for you to select a contact to whom a Call Alert can be sent.

Call Log

Selects the call log list.

Emergency

Depending on the programming, initiates or cancels an emergency.

Ext Public Address (PA)

Toggles audio routing between the connected PA loudspeaker amplifier and the internal PA system of the radio.

Reset Home Channel

Sets a new home channel.

Silence Home Channel Reminder

Mutes the Home Channel Reminder.

Indoor Location

Toggles Indoor Location on or off.

Intelligent Audio

Toggles intelligent audio on or off.

Manual Dial

Initiates a Private Call by keying in any subscriber ID.

Manual Site Roam

Starts the manual site search.

Mic AGC

Toggles the internal microphone automatic gain control (AGC) on or off.

Notifications

Provides direct access to the Notifications list.

One Touch Access

Directly initiates a predefined Broadcast, Private, Phone or Group Call, a Call Alert, or a Quick Text message.

Option Board Feature

Toggles option board feature(s) on or off for option board-enabled channels.

Phone

Provides direct access to the Phone Contacts list.

Privacy

Toggles privacy on or off.

Public Address (PA)

Toggles the internal PA system of the radio on or off.

Radio Alias and ID

Provides radio alias and ID.

Remote Monitor

Turns on the microphone of a target radio without it giving any indicators.

Site Info

Displays the current Capacity Max site name and ID.

Plays site announcement voice messages for the current site when Voice Announcement is enabled.

Site Lock

When toggled on, the radio searches the current site only. When toggled off, the radio searches other sites in addition to the current site.

Telemetry Control

Controls the Output Pin on a local or remote radio.

Text Message

Selects the text message menu.

Toggle Call Priority Level

Enables your radio to enter Call Priority Level High/Normal.

Trill Enhancement

Toggles trill enhancement on or off.

Voice Announcement On/Off

Toggles voice announcement on or off.

Voice Announcement for Channel

Plays zone and channel announcement voice messages for the current channel. This function is unavailable when Voice Announcement is disabled.

Wi-Fi

Toggles Wi-Fi on or off.

Zone Selection

Allows selection from a list of zones.

Assignable Settings or Utility Functions

The following radio settings or utility functions can be assigned to the programmable buttons.

Tones/Alerts

Toggles all tones and alerts on or off.

Backlight

Toggles display backlight on or off.

Channel Up/Down

Depending on the programming, changes channel to previous or next channel.

Display Mode

Toggles the day/night display mode on or off.



Power Level



Toggles transmit power level between high and low.

Accessing Programmed Functions

Follow the procedure to access programmed functions in your radio.

- 1 Do one of the following:
 - Press the programmed button. Proceed to [step 3](#).
 - Press  to access the menu.

- 2 Press  or  to the menu function, and press  to select a function or enter a sub-menu.

- 3 Do one of the following:
 - Press  to return to the previous screen.
 - Long press  to return to the Home screen.Your radio automatically exits the menu after a period of inactivity and returns to the Home screen.

The Menu Navigation Buttons are also available on a keypad microphone. See [Keypad Microphone Buttons on page 39](#).

Status Indicators

This chapter explains the status indicators and audio tones used in the radio.

Icons

The Liquid Crystal Display (LCD) of your radio shows the radio status, text entries, and menu entries.







Table 2: Display Icons







The following icons appear on the status bar at the top of the radio display. The icons are arranged left most in order of appearance or usage, and are channel-specific.









	<p>Bluetooth Connected The Bluetooth feature is enabled. The icon stays lit when a remote Bluetooth device is connected.</p>
--	---

	<p>Bluetooth Not Connected The Bluetooth feature is enabled but there is no remote Bluetooth device connected.</p>
	<p>Emergency Radio is in Emergency mode.</p>
	<p>GNSS Available GNSS feature is enabled. The icon stays lit when a position fix is available.</p>
	<p>GNSS Not Available GNSS feature is enabled but is not receiving data from the satellite.</p>
	<p>High Volume Data Radio is receiving high volume data and channel is busy.</p>
	<p>Indoor Location Available¹ Indoor location status is on and available.</p>

¹ Only applicable for models with the latest software and hardware.

	<p>Indoor Location Unavailable¹ Indoor location status is on but unavailable due to Bluetooth disabled or Beacons Scan suspended by Bluetooth.</p>
	<p>Mute Mode Mute Mode is enabled and speaker is muted.</p>
	<p>Notification Notification List has one or more missed events.</p>
	<p>Option Board The Option Board is enabled. (Option board enabled models only)</p>
	<p>Option Board Non-Function The Option Board is disabled.</p>
	<p>Over-the-Air Programming Delay Timer Indicates time left before automatic restart of radio.</p>

	<p>Priority 1 Indicates Priority Talkgroup 1.</p>
	<p>Priority 2 Indicates Priority Talkgroup 2.</p>
	<p>Received Signal Strength Indicator (RSSI) The number of bars displayed represents the radio signal strength. Four bars indicate the strongest signal. This icon is only displayed while receiving.</p>
	<p>Response Inhibit Response Inhibit is enabled.</p>
	<p>Ring Only Ringing mode is enabled.</p>
	<p>Secure The Privacy feature is enabled.</p>
	<p>Shared Frequency Indicates radio is locking to shared control channel.</p>

	Silent Ring Silent ring mode is enabled.
	Site Roaming The site roaming feature is enabled.
	Status Indicates a new status message.
	Tones Disable Tones are turned off.
	Unsecure The Privacy feature is disabled.
	Wi-Fi Excellent² Wi-Fi signal is excellent.
	Wi-Fi Good² Wi-Fi signal is good.
	Wi-Fi Average² Wi-Fi signal is average.





	Wi-Fi Poor² Wi-Fi signal is poor.
	Wi-Fi Unavailable² Wi-Fi signal is unavailable.

Table 3: Advance Menu Icons

The following icons appear beside menu items that offer a choice between two options or as an indication that there is a sub-menu offering two options.

	Checkbox (Checked) Indicates that the option is selected.
	Checkbox (Empty) Indicates that the option is not selected.
	Solid Black Box Indicates that the option selected for the menu item with a sub-menu.

² Only applicable for XPR 5550e/XPR 5580e.

Table 4: Bluetooth Device Icons

The following icons appear next to items in the list of Bluetooth-enabled devices available to indicate the device type.





	<p>Bluetooth Audio Device Bluetooth-enabled audio device, such as a headset.</p>
	<p>Bluetooth Data Device Bluetooth-enabled data device, such as a scanner.</p>
	<p>Bluetooth PTT Device Bluetooth-enabled PTT device, such as a PTT-Only Device (POD).</p>

Table 5: Call Icons

The following icons appear on the display during a call. These icons also appear in the Contacts list to indicate alias or ID type.

	<p>Bluetooth PC Call Indicates a Bluetooth PC Call in progress.</p>
---	--

In the Contacts list, it indicates a Bluetooth PC Call alias (name) or ID (number).

**Call Priority High**

Indicating Call Priority Level High is enabled.

**Dispatch Call**

The Dispatch Call contact type is used to send a text message to a dispatcher PC through a third-party Text Message Server.

**Group Call/All Call**

Indicates a Group Call or All Call in progress.

In the Contacts list, it indicates a group alias (name) or ID (number).

**Private Call**

Indicates a Private Call in progress.

In the Contacts list, it indicates a subscriber alias (name) or ID (number).





	<p>Phone Call as Group/All Call Indicates a Phone Call as Group Call or All Call in progress.</p> <p>In the Contacts list, it indicates a group alias (name) or ID (number).</p>
	<p>Phone Call as Private Call Indicates a Phone Call as Private Call in progress.</p> <p>In the Contacts list, it indicates a phone alias (name) or ID (number).</p>

Table 6: Job Tickets Icons

The following icons appear momentarily on the display in the Job Ticket folder.

	<p>All Jobs Indicates all jobs listed.</p>
	<p>New Jobs Indicates new jobs.</p>







	<p>In Progress Jobs are transmitting. This is seen before indication for Job Tickets Send Failed or Sent Successfully.</p>
	<p>Send Failed Jobs cannot be sent.</p>
	<p>Sent Successfully Jobs have been successfully sent.</p>
	<p>Priority 1 Indicates Priority Level 1 for jobs.</p>
	<p>Priority 2 Indicates Priority Level 2 for jobs.</p>
	<p>Priority 3 Indicates Priority Level 3 for jobs.</p>

Table 7: Mini Notice Icons

The following icons appear momentarily on the display after an action to perform a task is taken.













	Failed Transmission (Negative)
	Failed action taken.
	Successful Transmission (Positive)
	Successful action taken.
	Transmission in Progress (Transitional)
	Transmitting. This is seen before indication for Successful Transmission or Failed Transmission.

Table 8: Sent Items Icons

The following icons appear at the top right corner of the display in the Sent Items folder.

 or 	In Progress
	The text message to a subscriber alias or ID is pending transmission, followed by waiting for acknowledgement.

	The text message to a group alias or ID is pending transmission.
 or 	Individual or Group Message Read
	The text message has been read.
 or 	Individual or Group Message Unread
	The text message has not been read.
 or 	Send Failed
	The text message cannot be sent.
 or 	Sent Successfully
	The text message has been successfully sent.

LED Indicator

The LED indicator shows the operational status of your radio.

Blinking Red

Radio has failed the self-test upon powering up.

Radio is receiving an emergency transmission.

Radio is transmitting in low battery state.

Radio has moved out of range if Auto-Range Transponder System is configured.

Mute Mode is enabled.

Solid Green

Radio is powering up.

Radio is transmitting.

Radio is sending a Call Alert or an emergency transmission.

Blinking Green

Radio is receiving a call or data.

Radio is retrieving Over-the-Air Programming transmissions over the air.

Radio is detecting activity over the air.



NOTICE:

This activity may or may not affect the programmed channel of the radio due to the nature of the digital protocol.

Double Blinking Green

Radio is receiving a privacy-enabled call or data.

Solid Yellow

Radio is in Bluetooth Discoverable Mode.

Blinking Yellow

Radio has yet to respond to a Call Alert.

Double Blinking Yellow

Radio has Auto Roaming enabled.

Radio is actively searching for a new site.

Radio has yet to respond to a Group Call Alert.

Radio is locked.

Tones

The following are the tones that sound through on the radio speaker.



High Pitched Tone



Low Pitched Tone

Audio Tones

Audio tones provide you with audible indications of the status, or response to data received on the radio.



Continuous Tone

A monotone sound. Sounds continuously until termination.



Periodic Tone

Sounds periodically depending on the duration set by the radio. Tone starts, stops, and repeats itself.



Repetitive Tone

A single tone that repeats itself until it is terminated by the user.



Momentary Tone

Sounds once for a short duration set by the radio.

Indicator Tones

Indicator tones provide you with audible indications of the status after an action to perform a task is taken.



Positive Indicator Tone



Negative Indicator Tone

Registration

There are a number of registration-related messages that you may receive.

Registering

Typically, registration is sent to the system during power-up, Talkgroup change, or during site roaming. If a radio fails registration on a site, the radio automatically attempts to roam to another site. The radio temporarily removes the site where registration was attempted from the roaming list.

The indication means that the radio is busy searching for a site to roam, or that the radio has found a site successfully but is waiting for a response to the registration messages from the radio.

When `Registering` is displayed on the radio, a tone sounds and the yellow LED double flashes to indicate a site search.

If the indications persist, the user should change locations or if allowed, manually roam to another site.

Out of Range

A radio is deemed to be out of range when the radio is unable to detect a signal from the system or from the current site. Typically, this indication means that the radio is outside of the geographic outbound radio frequency (RF) coverage range.

When `Out of Range` is displayed on the radio, a repetitive tone sounds and the red LED flashes.

Contact your dealer or system administrator if the radio still receives out of range indications while being in an area with good RF coverage.

Talkgroup Affiliation Failed

A radio tries to affiliate to the Talkgroup specified in the channels or Unified Knob Position (UKP) during registration.

A radio that is in affiliation fail state is unable to make or receive calls from the Talkgroup that the radio is trying to affiliate to.

When a radio fails to affiliate with a Talkgroup, `UKP Alias` is displayed in the home screen with a highlighted background.

Contact your dealer or system administrator if the radio receives affiliation failure indications.

Register Denied

Registration denied indicators are received when the registration with the system is not accepted.

The radio does not indicate to the radio user the specific reason the registration was denied. Normally, a registration is denied when the system operator has disabled the access of the radio to the system.

When a radio is denied registration, `Register Denied` is displayed on the radio and the yellow LED double flashes to indicate a site search.

Zone and Channel Selections





This chapter explains the operations to select a zone or channel on your radio.



The radio can be programmed with a maximum of 250 Capacity Max Zones with a maximum of 160 Channels per zone. Each Capacity Max zone contains a maximum of 16 assignable positions.

Selecting Zones

Follow the procedure to select the required zone on your radio.

- 1 Do one of the following:
 - Press the programmed **Zone Selection** button. Proceed to [step 3](#).
 - Press  to access the menu.





- 2 Press  or  to Zone. Press  to select. The display shows  and the current zone.

- 3 Press  or  to the required zone. Press  to select.

The display shows `<Zone> Selected` momentarily and returns to the selected zone screen.

Selecting Zones by Using the Alias Search

Follow the procedure to select the required zone on your radio by using the alias search.

- 1 Press  to access the menu.
- 2 Press  or  to Zone. Press  to select. The display shows  and the current zone.
- 3 Enter the first character of the required alias. The display shows a blinking cursor.
- 4 Enter the rest of the characters of the required alias.

The alias search is case-insensitive. If there are two or more entries with the same name, the display shows the entry listed first in the list.

The first text line shows the characters you entered. The following text lines show the shortlisted search results.

5 Press  to select.

The display shows <Zone> Selected momentarily and returns to the selected zone screen.

Selecting a Call Type

Use the Channel Selector Knob to select a call type. This can be a Group Call, Broadcast Call, All Call, or Private Call, depending on how your radio is programmed. If you change the Channel Selector Knob to a different position (that has a call type assigned to it), this causes the radio to re-register with the Capacity Max System. The radio registers with the Talkgroup ID that has been programmed for the new Channel Selector Knob position call type.

Your radio does not operate when selected to an unprogrammed channel, use the Channel Selector Knob to select a programmed channel instead.

Once the required zone is displayed (if you have multiple zones in your radio), turn the programmed Channel Selector Knob to select the call type.

Selecting a Site

A site provides coverage for a specific area. In a multi-site network, the Capacity Max radio will automatically search for a new site when the signal level from the current site drops to an unacceptable level.

The Capacity Max system can support up to 250 sites.

Roam Request

A Roam Request tells the radio to search for a different site, even if the signal from the current site is acceptable.

If there are no sites available:

- The radio display shows Searching and continues to search through the list of sites.

- The radio will return to the previous site, if the previous site is still available.

**NOTICE:**

This is programmed by your dealer.

Press the programmed **Manual Site Roam** button.

You hear a tone, indicating the radio has switched to a new site. The display shows `Site ID <Site Number>`.

Site Lock On/Off

When toggled on, the radio searches the current site only. When toggled off, the radio searches other sites in addition to the current site.

Press the programmed **Site Lock** button.

If the **Site Lock** function is toggled on:

- You hear a positive indicator tone, indicating the radio has locked to the current site.
- The display shows `Site Locked`.

If the **Site Lock** function is toggled off:

- You hear a negative indicator tone, indicating the radio is unlocked.
 - The display shows `Site Unlocked`.
-

Site Restriction

In Capacity Max system, your radio administrator has the ability to decide which network sites your radio is and is not allowed to use.

The radio does not have to be reprogrammed to change the list of allowed and disallowed sites. If your radio attempts to register at a disallowed site, your radio receives indication that the site is denied. The radio then searches for a different network site.

When experiencing site restrictions, your radio displays `Register Denied` and the yellow LED double flashes to indicate a site search.

Site Trunking

A site must be able to communicate with the Trunk Controller to be considered as System Trunking.

If the site cannot communicate with the Trunk Controller in the system, a radio enters Site Trunking mode. While in Site Trunking, the radio provides a periodic audible and visual indication to the user to inform the user of their limited functionality.

When a radio is in Site Trunking, the radio displays `Site Trunking` and a repetitive tone sounds.

The radios in Site Trunking are still able to make group and individual voice calls as well as send text messages to other radios within the same site. Voice consoles, logging recorders, phone gateways, and data applications cannot communicate to the radios at the site.

Once in Site Trunking, a radio that is involved in calls across multiple sites will only be able to communicate with other radios within the same site. Communication to and from other sites would be lost.



NOTICE:

If there are multiple sites that cover the current location of the radio and one of the sites enters Site Trunking, the radio roams to another site if within coverage.

Calls

This chapter explains the operations to receive, respond to, make, and stop calls.

You can select a subscriber alias or ID, or group alias or ID after you have selected a channel by using one of these features:

Alias Search

This method is used for Group, Private, and All Calls only with a keypad microphone.

Contacts List

This method provides direct access to the Contacts list.

Manual Dial (by using Contacts)

This method is used for Private and Phone Calls only with a keypad microphone.

Programmed Number Keys

This method is used for Group, Private, and All Calls only with a keypad microphone.



NOTICE:

You can only have one alias or ID assigned to a number key, but you can have more than one number key associated to an alias or ID. All the number keys on a keypad microphone can be assigned. See [Assigning Entries to Programmable Number Keys on page 381](#) for more information.

Programmed One Touch Access Button

This method is used for Group, Private, and Phone Calls only.

You can only have one ID assigned to a **One Touch Access** button with a short or long programmable button press. Your radio can have multiple **One Touch Access** buttons programmed.

Programmable Button

This method is used for Phone Calls only.

Volume/Channel Selector Knob

This method manually selects a subscriber alias or ID, or group alias or ID.

The LED lights up solid green while the radio is transmitting and blinks green when the radio is receiving.



NOTICE:

The LED lights up solid green while the radio is transmitting and double blinks green when the radio is receiving a privacy-enabled call.

To unscramble a privacy-enabled call, your radio must have the same Privacy Key, or the same Key Value and Key ID (programmed by your dealer), as the transmitting radio (the radio you are receiving the call from).

See [Privacy on page 430](#) for more information.

Group Calls

Your radio must be configured as part of a group to receive a call from or make a call to the group of users.

Making Group Calls

To make a call to a group of users, your radio must be configured as part of that group. Follow the procedure to make Group Calls on your radio.

- 1 Do one of the following:
 - Select a channel with the active group alias or ID. See [Selecting a Call Type on page 59](#).

- Press the programmed **One Touch Access** button.

2 Press the **PTT** button to make the call.

The green LED lights up. The first text line shows the **Group Call** icon and alias.

3 Do one of the following:

- Wait for the Talk Permit Tone to end and speak clearly into the microphone if enabled.
 - Wait for the **PTT** Sidetone to end and speak clearly into the microphone if enabled.
-

4 Release the **PTT** button to listen.

The green LED lights up when the target radio responds. The display shows the **Group Call** icon, and alias or ID, and the transmitting radio alias or ID.

- ## 5 If the Channel Free Indication feature is enabled, you hear a short alert tone the moment the transmitting radio releases the **PTT** button, indicating the channel is free for you to respond. Press the **PTT** button to respond to the call.



The call ends when there is no voice activity for a predetermined period.



The call initiator can press  to end a Group Call.

Making Group Calls by Using the Contacts List

Follow the procedure to make Group Calls on your radio by using the Contacts list.

- 1 Press  **OK** to access the menu.
-

- 2 Press  or  to **Contacts**. Press  **OK** to select.
-

- 3 Press  or  to the required alias or ID. Press  **OK** to select.
-

- 4 Press the **PTT** button to make the call. The green LED lights up.

The first line displays the subscriber alias or ID. The second line displays `Group Call` and the **Group Call** icon.

5 Do one of the following:

- Wait for the Talk Permit Tone to end and speak clearly into the microphone if enabled.
 - Wait for the **PTT** Sidetone to end and speak clearly into the microphone if enabled.
-

6 Release the **PTT** button to listen.

The green LED blinks when any user in the group responds. The display shows the **Group Call** icon, and alias or ID, and the transmitting radio alias or ID.

7 If the Channel Free Indication feature is enabled, you hear a short alert tone the moment the transmitting radio releases the **PTT** button, indicating the channel is free for you to respond. Press the **PTT** button to respond to the call.

The call ends when there is no voice activity for a predetermined period.

The call initiator can press  to end the Group Call.

You hear a short tone. The display shows `Call Ended`.

Making Group Calls by Using the Programmable Number Key

Follow the procedure to make Group Calls on your radio by using the programmable number key.

- 1** Long press the programmed number key to the predefined alias or ID when you are on the Home screen.

If a number key is assigned to an entry in a particular mode, this feature is not supported when you long press the number key in another mode.

A negative indicator tone sounds if the number key is not associated to an entry.

- 2** Press the **PTT** button to make the call.
The green LED lights up.
-

3 Release the **PTT** button to listen.

The green LED blinks when any user in the group responds.

4 If the Channel Free Indication feature is enabled, you hear a short alert tone the moment the transmitting radio releases the **PTT** button, indicating the channel is free for you to respond. Press the **PTT** button to respond to the call.

The call ends when there is no voice activity for a predetermined period. The radio returns to the screen you were on before initiating the call.

The call initiator can press  to end the Group Call.

See [Assigning Entries to Programmable Number Keys on page 381](#) for more information.

Making Group Calls by Using the Alias Search

You can also use alias or alphanumeric search to retrieve the required subscriber alias. This feature is only applicable

while in Contacts. Follow the procedure to make any calls by using the alias search.

1 Press to access the menu.

2 Press or to Contacts. Press to select.

The display shows the entries in alphabetical order.

3 Press or to the required subscriber alias or ID. The first line of the display shows Phone Number: . The second line of the display shows a blinking cursor. Use the keypad to enter a telephone number.

4 Press to select. If the entry selected is empty, a negative indicator tone sounds and the display shows Phone Call Invalid #.

5 Press or to Call Phone and Press to select. If the access code was not preconfigured in the Contacts list, the first line of the display shows



Access Code:. The second line of the display shows a blinking cursor. Enter the access code and

press the  button to proceed. If successful, the DTMF tone sounds. You hear the dialing tone of the telephone user. The first line of the display shows the subscriber alias or ID, and the RSSI icon. The second line of the display shows **Phone Call** and the Phone Call icon. If unsuccessful, a tone sounds and the display shows **Phone Call Failed**. Your radio returns to the Access Code input screen. If the access code was preconfigured in the Contacts list, the radio returns to the screen you were on prior to initiating the call.

-
- 6 Press the **PTT** button to talk and release it to listen. The **RSSI** icon disappears during transmission.
-
- 7 To enter extra digits, if requested by the Phone Call, do one of the following.
- Press any keypad key to begin the input of the extra digits. The first line of the display shows **Extra Digits:**. The second line of the display shows a blinking cursor. Enter the extra digits and press the  button to proceed. The DTMF

tone sounds and the radio returns to the previous screen.

- Press **One Touch Access** button. The DTMF tone sounds. If the entry for the **One Touch Access** button is empty, a negative indicator tone sounds.

-
- 8 Press  to end the call. If deaccess code was not preconfigured in the Contacts list, the first line of the display shows **De-Access Code:**. The second line of the display shows a blinking cursor. Enter the deaccess code and press  to proceed. The radio returns to the previous screen. The DTMF tone sounds and the display shows **Ending Phone Call**. If successful, a tone sounds and the display shows **Phone Call Ended**. Your radio returns to the Phone Call screen. If unsuccessful, your radio returns to the Phone Call screen. When you press the **PTT** button while in the Phone Contacts screen, as tone sounds and the display shows **Press OK to Place Phone Call**. When the telephone user ends the call, a tone sounds and the display shows **Phone Call Ended**. If the call ends while you are entering the extra digits

requested by the Phone Call, your radio returns to the screen you were on prior to initiating the call.

- 9 If the Channel Free Indication feature is enabled, you hear a short alert tone the moment the transmitting radio releases the **PTT** button, indicating the channel is free for you to respond. Press the **PTT** button to respond to the call.



The call ends when there is no voice activity for a predetermined period. A tone sounds. The display shows `Call Ended`.

The call initiator can press  to end the Group Call.



NOTICE:

During the channel access, press  to dismiss the call attempt and a tone sounds button or to exit

alias search. Press  button or  to exit alias search. During the call, when you press **One Touch Access** button with the deaccess code preconfigured or enter the deaccess code as the input for extra digits, your radio attempts to end the call. During channel access and access/deaccess code or extra digits transmission, you radio responds to On/Off button, Volume Knob, and Channel Rocker only. A tone sounds for every invalid input.

Responding to Group Calls

Follow the procedure to respond to Group Calls on your radio.

When you receive a Group Call:

- The green LED blinks.
- The display shows the **Group Call** icon at the top right corner.
- The first text line shows the caller alias.

- The second text line displays the group call alias.
- Your radio unmutes and the incoming call sounds through the speaker.

1 Do one of the following:

- If the Channel Free Indication feature is enabled, you hear a short alert tone the moment the transmitting radio releases the **PTT** button, indicating the channel is free for you to respond. Press the **PTT** button to respond to the call.
- If the Voice Interrupt feature is enabled, press the **PTT** button to interrupt the audio from the transmitting radio and free the channel for you to respond.

The green LED lights up.

2 Do one of the following:

- Wait for the Talk Permit Tone to end and speak clearly into the microphone if enabled.
- Wait for the **PTT** Sidetone to end and speak clearly into the microphone if enabled.

3 Release the **PTT** button to listen.

The call ends when there is no voice activity for a predetermined period.

Broadcast Call

A Broadcast Call is a one-way voice call from any user to an entire talkgroup.

The Broadcast Call feature allows only the call initiating user to transmit to the talkgroup, while the recipients of the call cannot respond.

The broadcast initiator can also end the broadcast call. To receive a call from a group of users, or to call a group of users, the radio must be configured as part of a group.

Making Broadcast Calls

Follow the procedure to make Broadcast Calls on your radio.

1 Do one of the following:

- Select a channel with the active group alias or ID. See [Selecting a Call Type on page 59](#).
 - Press the programmed **One Touch Access** button.
-

- 2 Press the **PTT** button to make the call.
The green LED lights up. The display shows the **Group Call** icon and alias.
-



- 3 Do one of the following:
- Wait for the Talk Permit Tone to end and speak clearly into the microphone if enabled.
 - Wait for the **PTT** Sidetone to end and speak clearly into the microphone if enabled.



The call initiator can press  to end the Broadcast Call.

Making Broadcast Calls Using the Contact List

Follow the procedure to make Broadcast Calls on your radio using the Contacts list.

- 1 Press  to access the menu.
-

- 2 Press  or  to **Contacts**. Press  to select.
-

- 3 Press  or  to the required alias or ID.
Press  to select.
-

- 4 Press the **PTT** button to make the call.
The green LED blinks.
The first line displays the subscriber alias or ID. The second line displays **Group Call** and the **Group Call** icon.
-

- 5 Do one of the following:
- Wait for the Talk Permit Tone to end and speak clearly into the microphone if enabled.
 - Wait for the **PTT** Sidetone to end and speak clearly into the microphone if enabled.

The call initiator can press  to end the Broadcast Call.

Making Broadcast Calls Using the Programmable Number Key

Follow the procedure to make Broadcast Calls on your radio using the programmable number key.

- 1 Long press the programmed number key to the predefined alias or ID when you are on the Home screen.

If a number key is assigned to an entry in a particular mode, this feature is not supported when you long press the number key in another mode.

A negative indicator tone sounds if the number key is not associated to an entry.

- 2 Press the **PTT** button to make the call.

The green LED lights up. The display shows the **Group Call** icon at the top right corner. The first text line shows the caller alias.

- 3 Do one of the following:

- Wait for the Talk Permit Tone to end and speak clearly into the microphone if enabled.

- Wait for the **PTT** Sidetone to end and speak clearly into the microphone if enabled.

The call initiator can press  to end the Broadcast Call.

Receiving Broadcast Calls

Follow the procedure to receive a Broadcast Call on your radio.

When you receive a Broadcast Call:

- The green LED blinks.
- The display shows the **Group Call** icon at the top right corner.
- The first text line shows the caller alias.
- The second text line displays the group call alias.
- Your radio unmutes and the incoming call sounds through the speaker.

**NOTICE:**

Recipient users are not allowed to Talkback during a Broadcast Call. The display shows `Talkback Prohibit`. The Talkback Prohibit Tone will sound momentarily if the **PTT** button is pressed during a Broadcast Call.

Private Call

A Private Call is a call from an individual radio to another individual radio.

There are two ways to set up a Private Call.

- The first call type is called Off Air Call Set-Up (OACSU). OACSU sets up the call after performing a radio presence check and completes the call automatically.
- The second type is called Full Off Air Call Set-Up (FOACSU). FOACSU also sets up the call after performing a radio presence check. However, FOACSU calls require user acknowledgment to complete the call and allows the user to either Accept or Decline the call.

The type of call is configured by the system administrator.

**NOTICE:**

Both the call initiator and recipient are able to terminate an on-going Private Call by pressing



Making Private Calls

Your radio must be programmed for you to initiate a Private Call. If this feature is not enabled, you hear a negative indicator tone when you initiate the call. Follow the procedure to make Private Calls on your radio. If the target radio is not available, a short tone sounds and the display show `Party Not Available`.

- 1 Do one of the following:
 - Select a channel with the active subscriber alias or ID. See [Selecting a Call Type on page 59](#).
 - Press the programmed **One Touch Access** button.
-
- 2 Press the **PTT** button to make the call.

The green LED lights up. The display shows the **Private Call** icon, the subscriber alias, and call status.
-

- 3 Wait for the Talk Permit Tone to end and speak clearly into the microphone if enabled.
-

- 4 Release the **PTT** button to listen.

The green LED lights up when the target radio responds.

- 5 The call ends when there is no voice activity for a predetermined period. You will hear a short tone. The display shows `Call Ended`.

Both the call initiator and recipient are able to

terminate an on-going Private Call by pressing  .

Making Private Calls by Using the Programmable Number Key

Follow the procedure to make Private Calls on your radio by using the programmable number key.

- 1 Long press the programmed number key to the predefined alias or ID when you are on the Home screen.

If a number key is assigned to an entry in a particular mode, this feature is not supported when you long press the number key in another mode.

A negative indicator tone sounds if the number key is not associated to an entry.

- 2 Press the **PTT** button to make the call.

The green LED lights up. The display shows the **Private Call** icon at the top right corner. The first text line shows the caller alias. The second text line shows the call status.

- 3 Release the **PTT** button to listen.

The green LED blinks when the target radio responds. The display shows the destination alias.

- 4 The call ends when there is no voice activity for a predetermined period. You will hear a short tone. The display shows `Call Ended`.



Both the call initiator and recipient are able to



terminate an on-going Private Call by pressing  .

See [Assigning Entries to Programmable Number Keys on page 381](#) for more information.



Making Private Calls by Using the Alias Search

- 1 Press  to access the menu.

- 2 Press  or  to **Contacts**. Press  to select.
The display shows the entries in alphabetical order.

- 3 Press  or  to the required subscriber alias or ID. The first line of the display shows **Phone Number:**. The second line of the display shows a blinking cursor. Use the keypad to enter a telephone number.

- 4 Press  to select. If the entry selected is empty, a negative indicator tone sounds and the display shows **Phone Call Invalid #**.

- 5 Press  or  to **Call Phone** and Press  to select. If the access code was not preconfigured

in the **Contacts** list, the first line of the display shows **Access Code:**. The second line of the display shows a blinking cursor. Enter the access code and

press the  button to proceed. If successful, the DTMF tone sounds. You hear the dialing tone of the telephone user. The first line of the display shows the subscriber alias or ID, and the **RSSI** icon. The second line of the display shows **Phone Call** and the **Phone Call** icon. If unsuccessful, a tone sounds and the display shows **Phone Call Failed**. Your radio returns to the **Access Code** input screen. If the access code was preconfigured in the **Contacts** list, the radio returns to the screen you were on before initiating the call.



- 6 Press the **PTT** button to talk and release it to listen. The **RSSI** icon disappears during transmission.

- 7 To enter extra digits, if requested by the **Phone Call**, do one of the following.
 - Press any keypad key to begin the input of the extra digits. The first line of the display shows **Extra Digits:**. The second line of the display shows a blinking cursor. Enter the extra digits and press the  button to proceed. The DTMF

tone sounds and the radio returns to the previous screen.

- Press **One Touch Access** button. The DTMF tone sounds. If the entry for the **One Touch Access** button is empty, a negative indicator tone sounds.

8

Press  to end the call. If deaccess code was not preconfigured in the Contacts list, the first line of the display shows `De-Access Code:`. The second line of the display shows a blinking cursor. Enter the deaccess code and press  to proceed. The radio returns to the previous screen. The DTMF tone sounds and the display shows `Ending Phone Call`. If successful, a tone sounds and the display shows `Phone Call Ended`. Your radio returns to the Phone Call screen. If unsuccessful, your radio returns to the Phone Call screen. When you press the **PTT** button while in the Phone Contacts screen, a tone sounds and the display shows `Press OK to Place Phone Call`. When the telephone user ends the call, a tone sounds and the display shows `Phone Call Ended`. If the call ends while you are entering the extra digits

requested by the Phone Call, your radio returns to the screen you were on before initiating the call.

- 9 The call ends when there is no voice activity for a predetermined period. You will hear a short tone. The display shows `Call Ended`.



Both the call initiator and recipient are able to

terminate an on-going Private Call by pressing .



NOTICE:

During the channel access, press  to dismiss the call attempt and a tone sounds button or to exit

alias search. Press  button or  to exit alias search. During the call, when you press **One Touch Access** button with the deaccess code preconfigured or enter the deaccess code as the input for extra digits, your radio attempts to end the call.

Making a Private Call with a One Touch Call Button

The One Touch Call feature allows you to easily make a Private Call to a pre-defined Private Call alias or ID. This

feature can be assigned to a short or long programmable button press.

You can only have one alias or ID assigned to a One Touch Call button. Your radio can have multiple One Touch Call buttons programmed.

1 Press the programmed **One Touch Call** button to make a Private Call to the pre-defined Private Call alias or ID.

2 Press the **PTT** button to make the call.
The LED lights up solid green.
The display shows the Private Call alias or ID.

3 Wait for the Talk Permit Tone to finish (if enabled) and speak clearly into the microphone.



4 Release the **PTT** button to listen.
When the target radio responds, the LED blinks green.
If there is no voice activity for a predetermined period of time, the call ends.



Both the call initiator and recipient are able to terminate an on-going Private Call by pressing .



Making Private Calls by Using the Manual Dial

Follow the procedure to make Private Calls on your radio by using the manual dial.



1 Press  to access the menu.

2 Press  or  to **Contacts**. Press  to select.

3 Press  or  to **Manual Dial**. Press  to select.

4 Press  or  to **Radio Number**. Press  to select.

5 Do one of the following:

- Enter the subscriber ID, and press  to proceed.
- Edit the previously dialed subscriber ID, and press  to proceed.

6 Press the **PTT** button to make the call.

The green LED lights up. The display shows the destination alias.

7 Wait for the Talk Permit Tone to end and speak clearly into the microphone if enabled.

8 Release the **PTT** button to listen.

The green LED lights up when the target radio responds. The display shows the transmitting user alias or ID.

9 If the Channel Free Indication feature is enabled, you hear a short alert tone the moment the transmitting radio releases the **PTT** button, indicating the channel is free for you to respond. Press the **PTT** button to respond to the call.

The call ends when there is no voice activity for a predetermined period. A tone sounds. The display shows **Call Ended**.

Both the call initiator and recipient are able to terminate an on-going Private Call by pressing .

Receiving Private Calls

When you receive Private Calls configured as Off Air Call Set-Up (OACSU):

- The green LED blinks.
- Your radio unmutes and the incoming call sounds through the speaker.



**NOTICE:**

Depending on how your radio is configured, either OACSU or Full Off Air Call Set-Up (FOACSU), responding to Private Calls may or may not require user acknowledgment.

For the OACSU configuration, your radio unmutes and the call connects automatically.

Accepting Private Calls

When you receive Private Calls configured as Full Off Air Call Set-Up (FOACSU):

- The green LED blinks.
- 1 To accept a Private Call configured as FOACSU, do one of the following:
 - Press  or  to **Accept** and press  to answer a Private Call.
 - Press the **PTT** button on any entry.

The green LED lights up.

- 2 Wait for the Talk Permit Tone to end and speak clearly into the microphone if enabled.

- 3 Release the **PTT** button to listen.

The call ends when there is no voice activity for a predetermined period. A tone sounds. The display shows **Call Ended**.

**NOTICE:**

Both the call initiator and recipient are able to terminate an on-going Private Call by





pressing  .

Declining Private Calls

When you receive Private Calls configured as Full Off Air Call Set-Up (FOACSU):

- The green LED blinks.

To decline a Private Call configured as FOACSU, do one of the following:

- Press  or  to **Reject** and press  to decline a Private Call.
- Press  to decline a Private Call.

All Calls

An All Call is a call from an individual radio to every radio on the site or every radio at a group of sites, depending on system configuration.

An All Call is used to make important announcements, requiring full attention from the user. The users on the system cannot respond to an All Call.

Capacity Max supports Site All Call and Multi-site All Call. The system administrator may configure one or both of these in your radio.



NOTICE:

Subscribers can support System-Wide All Calls but Motorola Solutions infrastructure does not support System-Wide All Calls.

Making All Calls

Your radio must be programmed for you to make an All Call. Follow the procedure to make All Calls on your radio.

- 1 Select a channel with the active All Call group alias or ID. See [Selecting a Call Type on page 59](#).

- 2 Press the **PTT** button to make the call.

The green LED lights up. The display shows the **Group Call** icon and either All Call, Site All Call, or Multi Site Call depending on the type of configuration.

- 3 Do one of the following:

- Wait for the Talk Permit Tone to end and speak clearly into the microphone if enabled.
- Wait for the **PTT** Sidetone to end and speak clearly into the microphone if enabled.

Users on the channel cannot respond to an All Call.

The call initiator can press  to end the All Call.

Making All Calls by Using the Programmable Number Key

Follow the procedure to make All Calls on your radio by using the programmable number key.

- 1 Long press the programmed number key assigned to the predefined alias or ID when you are on the Home screen.

If a number key is assigned to an entry in a particular mode, this feature is not supported when you long press the number key in another mode.

A negative indicator tone sounds if the number key is not associated to an entry.

2 Press the **PTT** button to make the call.

The green LED lights up. The display shows the **Group Call** icon and either All Call, Site All Call, or Multi Site Call depending on the type of configuration.

3 Do one of the following:



- Wait for the Talk Permit Tone to end and speak clearly into the microphone if enabled.
- Wait for the **PTT** Sidetone to end and speak clearly into the microphone if enabled.

The call initiator can press  to end the All Call.



See [Assigning Entries to Programmable Number Keys on page 381](#) for more information.

Making All Calls by Using the Alias Search



1 Press  to access the menu.

2 Press  or  to Contacts. Press  to select.

The display shows the entries in alphabetical order.

3 Press  or  to the required subscriber alias or ID. The first line of the display shows Phone Number#. The second line of the display shows a blinking cursor. Use the keypad to enter a telephone number.

4 Press  to select. If the entry selected is empty, a negative indicator tone sounds and the display shows Phone Call Invalid #.

5 Press  or  to Call Phone. Press  to select. If the access code was not preconfigured in



the Contacts list, the first line of the display shows `Access Code:`. The second line of the display shows a blinking cursor. Enter the access code and

press the  button to proceed. If successful, the DTMF tone sounds. You hear the dialing tone of the telephone user. The first line of the display shows the subscriber alias or ID, and the RSSI icon. The second line of the display shows `Phone Call` and the Phone Call icon. If unsuccessful, a tone sounds and the display shows `Phone Call Failed`. Your radio returns to the Access Code input screen. If the access code was preconfigured in the Contacts list, the radio returns to the screen you were on prior to initiating the call.

-
- 6 Press the **PTT** button to talk and release it to listen. The RSSI icon disappears during transmission.
-
- 7 To enter extra digits, if requested by the Phone Call, do one of the following.
- Press any keypad key to begin the input of the extra digits. The first line of the display shows `Extra Digits:`. The second line of the display shows a blinking cursor. Enter the extra digits and press the  button to proceed. The DTMF

tone sounds and the radio returns to the previous screen.

- Press **One Touch Access** button. The DTMF tone sounds. If the entry for the **One Touch Access** button is empty, a negative indicator tone sounds.

-
- 8 Press  to end the call. If deaccess code was not preconfigured in the Contacts list, the first line of the display shows `De-Access Code:`. The second line of the display shows a blinking cursor. Enter the deaccess code and press  to proceed. The radio returns to the previous screen. The DTMF tone sounds and the display shows `Ending Phone Call`. If successful, a tone sounds and the display shows `Phone Call Ended`. Your radio returns to the Phone Call screen. If unsuccessful, your radio returns to the Phone Call screen. When you press the **PTT** button while in the Phone Contacts screen, as tone sounds and the display shows `Press OK to Place Phone Call`. When the telephone user ends the call, a tone sounds and the display shows `Phone Call Ended`. If the call ends while you are entering the extra digits

requested by the Phone Call, your radio returns to the screen you were on prior to initiating the call.



NOTICE:

The call initiator can press  to end the All Call.

Receiving All Calls

When you receive an All Call, the following occur:

- A tone sounds.
- The green LED blinks.
- The display shows the **Group Call** icon at the top right corner.
- The first text line shows the caller alias ID.
- The second text line displays either `All Call`, `Site All Call`, or `Multi Site Call` depending on the type of configuration.
- Your radio unmutes and the incoming call sounds through the speaker.

The radio returns to the screen before receiving the All Call when the call ends.

If the Channel Free Indication feature is enabled, you hear a short alert tone when the transmitting radio releases the

PTT button, indicating the channel is free for you to use. You cannot respond to an All Call.



NOTICE:

The radio stops receiving the All Call if you switch to a different channel while receiving the call. You are not able to continue with any menu navigation or editing until the call ends during an All Call.

Phone Calls

A Phone Call is a call in between an individual radio or a group of radios and a telephone.

Depending on how the radio is configured, the following features may or may not be made available:

- Dual Tone Multi Frequency (DTMF) tone
- De-access code
- Displaying of caller alias or ID on receiving a phone call
- Ability to reject or accept a phone call

The Phone Call capability can be enabled by assigning and setting up phone numbers on the system. Check with your system administrator to determine how your radio has been programmed.

Making Phone Calls

Follow the procedure to make Phone Calls on your radio.

- 1 Press the programmed **One Touch Access** button to the predefined alias or ID.

If the entry for the **One Touch Access** button is empty, a negative indicator tone sounds.

If the access code is not preconfigured in the Contact List, the display shows `Access Code:.`

-
- 2 Enter the access code, and press  to proceed.
The access or deaccess code cannot be more than 10 characters.

-
- 3 Press the **PTT** button to respond to the call.

-
- 4 Release the **PTT** button to listen.

-
- 5 Enter extra digits with the keypad if requested by the call, and press  to proceed.

If the call ends while you are entering the extra digits requested by the call, your radio returns to the screen you were on before initiating the call.

The DTMF Tone sounds. Your radio returns to the previous screen.

-
- 6 Press  to end the call.

-
- 7 Do one of the following:

- If the deaccess code was not preconfigured, enter the deaccess code when the display shows `De-Access Code:.`, and press  to proceed. The radio returns to the previous screen.
- Press the programmed **One Touch Access** button. If the entry for the **One Touch Access** button is empty, a negative indicator tone sounds.

The DTMF Tone sounds and the display shows `Ending Phone Call.`

If the call ends successfully:



- A tone sounds.
- The display shows `Call Ended.`

If the call fails to end, the radio returns to the Phone Call screen. Repeat the last two steps or wait for the telephone user to end the call.

Making Phone Calls with the Programmable Button

Follow the procedure to make Phone Calls with the programmable button.

1 Press the programmed **Phone** button to enter into the Phone Entry list.

2 Press  or  to the required alias or ID.
Press  to select.

If the access code was not preconfigured in the Contacts list, the display shows `Access Code:`.

Enter the access code and press the  button to proceed.

The green LED lights up. The display shows **Phone Call** icon, subscriber alias or ID, and call status.

If the call-setup is successful:

- The DTMF tone sounds.
- You hear the call waiting tone of the telephone user.
- The display shows **Phone Call** icon, subscriber alias or ID, `Phone Call`, and call status.

If call-setup is unsuccessful:

- A tone sounds.
- The display shows `Phone Call Failed`.
- Your radio returns to the Access Code input screen. If the access code was preconfigured in the Contacts list, the radio returns to the screen you were on prior to initiating the call.

3 Press the **PTT** button to talk. Release the **PTT** button to listen. The RSSI icon disappears during transmission.

4 To enter extra digits, if requested by the Phone Call. Do one of the following:

- Press any keypad key to begin the input of the extra digits. The display shows `Extra Digits:` and a blinking cursor. Enter the extra digits and

press the  button to proceed. The DTMF tone sounds and the radio returns to the previous screen.

- Press **One Touch Access** button. The DTMF tone sounds. If the entry for the **One Touch Access** button is empty, a negative indicator tone sounds.

5 Press  to end the call.

If deaccess code was not preconfigured in the Contacts list, the display shows `De-Access Code:`.

Enter the deaccess code and press the  button to proceed.

The DTMF tone sounds and the display shows `Ending Phone Call`.

If the end-call-setup is successful, a tone sounds and the display shows `Call Ended`.

If the end-call-setup is unsuccessful, your radio returns to the Phone Call screen.

When you press **PTT** button while in the Phone Contacts screen, a tone sounds and the display shows `Press OK to Place Call`.

When the telephone user ends the call, a tone sounds and the display shows `Phone Call Ended`.

If the call ends while you are entering the extra digits requested by the Phone Call, your radio returns to the screen you were on prior to initiating the call.



NOTICE:

During channel access, press  to dismiss the call attempt and a tone sounds.



During the call, when you press **One Touch Access** button with the deaccess code preconfigured or enter the deaccess code as the input for extra digits, your radio attempts to end the call.

During channel access and access/deaccess code or extra digits transmission, you radio responds to **On/Off** button, **Volume On/Off Volume Knob**, and **Channel Up/Down Channel Rocker** only. A tone sounds for every invalid input.



Making Phone Calls by Using the Contacts List

Follow the procedure to make Phone Calls on your radio by using the Contacts list.

1 Press  to access the menu.

2 Press  or  to `Contacts`. Press  to select.

The display shows the entries in alphabetical order.

3 Press  or  to the required alias or ID.

Press  to select.



When you press the **PTT** button while on the Phone Contacts screen:

- A negative indicator tone sounds.
- The display shows `Press OK to Place Call`.

If the selected entry is empty:

- A negative indicator tone sounds.

- The display shows `Phone Call Invalid #`.
-

4 Press  or  to `Call Phone`. Press  to select.

The display shows `Access Code:` if the access code was not preconfigured.

5 Enter the access code, and press  to proceed.

The access or deaccess code cannot be more than 10 characters.

The display shows `Calling`, subscriber alias or ID, and the **Phone Call** icon.

If the call is successful:

- The DTMF Tone sounds.
- You hear the call waiting tone of the telephone user.
- The display shows the subscriber alias or ID, the **Phone Call** icon, and `Phone Call`.

If the call is unsuccessful:

- A tone sounds.

- The display shows `Phone Call Failed` and then, `Access Code:`.
- Your radio returns to the screen you were on prior to initiating the call if the access code has been preconfigured in the Contacts list.

6 Press the **PTT** button to respond to the call.

The **RSSI** icon disappears.

7 Release the **PTT** button to listen.

8 Enter extra digits with the keypad if requested by the call, and press  to proceed.

If the call ends while you are entering the extra digits requested by the call, your radio returns to the screen you were on prior to initiating the call.

The DTMF Tone sounds. Your radio returns to the previous screen.

9 Press  to end the call.

10 If the deaccess code was not preconfigured, enter the deaccess code when the display shows `De-`

`Access Code:`, and press  to proceed.

The radio returns to the previous screen. The DTMF Tone sounds and the display shows `Ending Phone Call`.

If the call ends successfully:

- A tone sounds.
- The display shows `Call Ended`.

If the call fails to end, the radio returns to the Phone Call screen. Repeat [step 9](#) and [step 10](#), or wait for the telephone user to end the call. When you press the PTT button while in the Phone Contacts screen, as tone sounds and the display shows `Press OK to Place Call`.

When the telephone user ends the call, a tone sounds and the display shows `Phone Call Ended`.

If the call ends while you are entering the extra digits requested by the Phone Call, your radio returns to the screen you were on prior to initiating the call.

**NOTICE:**

During the channel access, press  to dismiss the call attempt and a tone sounds.

During the call, when you press **One Touch Access** button with the deaccess code preconfigured or enter the deaccess code as the input for extra digits, your radio attempts to end the call.

During channel access and access/deaccess code or extra digits transmission, you radio responds to **On/Off** button, **Volume Knob**, and **Channel Rocker** only. A tone sounds for every invalid input.



Making Phone Calls by Using the Alias Search

You can also use alias or alphanumeric search to retrieve the required subscriber alias. This feature is only applicable while in Contacts. Follow the procedure to make Phone Calls on your radio by using the alias search.



- 1 Press  to access the menu.
-

- 2 Press  or  to Contacts. Press  to select.

The display shows the entries in alphabetical order.

- 3 Press  or  to the required subscriber alias or ID.
-

- 4 Press  to select. If the entry selected is empty, a negative indicator tone sounds and the display shows `Phone Call Invalid #`.
-

- 5 Press  or  to Call Phone. Press  to select.

If the access code was not preconfigured in the Contacts list, the display shows `Access Code:` and a blinking cursor. Enter the access code and press the  button to proceed.

If successful:

- The DTMF tone sounds.
- You hear the call waiting tone of the telephone user.

- The display shows the subscriber alias or ID, the **RSSI** icon, Phone Call, and the **Phone Call** icon.

If unsuccessful:

- A tone sounds.
- The display shows Phone Call Failed.
- Your radio returns to the Access Code input screen. If the access code was preconfigured in the Contacts list, the radio returns to the screen you were on prior to initiating the call.

6 Press the **PTT** button to talk and release it to listen. The **RSSI** icon disappears during transmission.

7 To enter extra digits, if requested by the Phone Call, do one of the following.

- Press any keypad key to begin the input of the extra digits. The display shows Extra Digits: and a blinking cursor. Enter the extra digits and press the  button to proceed. The DTMF tone sound

- Press **One Touch Access** button. The DTMF tone sounds. If the entry for the **One Touch Access** button is empty, a negative indicator tone sounds and the radio returns to the previous screen.

8 Press  to end the call.

If deaccess code was not preconfigured in the Contacts list, the display shows De-Access Code: and a blinking cursor. Enter the deaccess code and press  to proceed.

The radio returns to the previous screen. The DTMF tone sounds and the display shows Ending Phone Call.

If successful:

- A tone sounds.
- The display shows Phone Call Ended.
- Your radio returns to the Phone Call screen.

If unsuccessful:



- Your radio returns to the Phone Call screen.

- When you press the **PTT** button while in the Phone Contacts screen, a tone sounds and the display shows `Press OK to Place Phone Call`.
 - When the telephone user ends the call, a tone sounds and the display shows `Phone Call Ended`.
 - If the call ends while you are entering the extra digits requested by the Phone Call, your radio returns to the screen you were on prior to initiating the call.
-



NOTICE:



During the channel access, press  to dismiss the call attempt and a tone sounds button or to exit



alias search. Press  button or  to exit alias search. During the call, when you press **One Touch Access** button with the deaccess code preconfigured or enter the deaccess code as the input for extra digits, your radio attempts to end the call. During channel access and access/deaccess code or extra digits transmission, your radio responds to On/Off button, Volume Knob, and Channel Rocker only. A tone sounds for every invalid input.



Making Phone Calls by Using the Manual Dial

Follow the procedure to make Phone Calls on your radio by using the manual dial.

- 1 Press  to access the menu.
-

2 Press  or  to **Contacts**. Press  to select.

3 Press  or  to **Manual Dial**. Press  to select.

4 Press  or  to **Phone Number**. Press  to select.
The display shows **Number:** and a blinking cursor.

5 Enter the telephone number, and press  to proceed.

The display shows **Access Code:** and a blinking cursor if the access code was not preconfigured.

6 Enter the access code, and press  to proceed. The access or deaccess code cannot be more than 10 characters.

The green LED lights up. The display shows the **Phone Call** icon, subscriber alias, and call status.

If the call is successful:

- The DTMF Tone sounds.
- You hear the call waiting tone of the telephone user.
- The display shows subscriber alias and the **Phone Call** icon.

If the call is unsuccessful:

- A tone sounds.
 - The display shows **Phone Call Failed** and then, **Access Code:**.
 - Your radio returns to the screen you were on before initiating the call if the access code has been preconfigured in the **Contacts** list.
-

7 Press  to end the call.

8 Do one of the following:

- If the deaccess code was not preconfigured, enter the deaccess code when the display shows **De-Access Code:**, and press  to proceed. The radio returns to the previous screen.

- Press the programmed **One Touch Access** button. If the entry for the **One Touch Access** button is empty, a negative indicator tone sounds.

The DTMF Tone sounds and the display shows Ending Phone Call.

If the call ends successfully:

- A tone sounds.
- The display shows Call Ended.

If the call fails to end, the radio returns to the Phone Call screen. Repeat [step 7](#), or wait for the telephone user to end the call.



NOTICE:

When you press **PTT** button while in the Phone Contacts screen, a tone sounds and the display shows Press OK to Place Phone Call.

When the telephone user ends the call, a tone sounds and the display shows Call Ended.

If the call ends while you are entering the extra digits requested by the Phone Call, your radio returns to the screen you were on before initiating the call.

During the channel access, press  to dismiss the call attempt and a tone sounds.

During the call, when you press **One Touch Access** button with the deaccess code preconfigured or enter the deaccess code as the input for extra digits, your radio attempts to end the call.

During channel access and access/deaccess code or extra digits transmission, your radio responds to **On/Off** button, **Volume Knob**,

and **Channel Rocker** only. A tone sounds for every invalid input.



Dual Tone Multi Frequency

The Dual Tone Multi Frequency (DTMF) feature allows the radio to operate in a radio system with an interface to the telephone systems.

You can turn off the DTMF tone by disabling all radio tones and alerts. See [Turning Radio Tones/Alerts On or Off on page 190](#) for more information.

Initiating DTMF Calls

Follow the procedure to initiate DTMF calls on your radio.

- 1 Press and hold the **PTT** button.
- 2 Do one of the following:
 - Enter the desired number to initiate a DTMF call.
 - Press  to initiate a DTMF call.
 - Press  to initiate a DTMF call.

Responding to Phone Calls as All Calls

When you receive a Phone Call as an All Call, the receiving radio is unable to talkback or respond. The recipient user is also not allowed to end the All Call.

When you receive a Phone Call as an All Call:

- The display shows the **Phone Call** icon at the top right corner.
- The display shows either **All Call**, **Site All Call**, or **Multi Site Call** depending on the type of configuration and **Phone Call**.
- The green LED blinks.
- Your radio unmutes and the incoming call sounds through the speaker.

Responding to Phone Calls as Group Calls

Follow the procedure to respond to Phone Calls as Group Calls on your radio.

When you receive a Phone Call as a Group Call:

- The display shows the **Phone Call** icon and **Phone Call**.

- The green LED blinks.
- Your radio unmutes and the incoming call sounds through the speaker.

1 Press the **PTT** button to respond to the call.

2 Release the **PTT** button to listen.

3 Press  to end the call.



NOTICE:

Your radio is not able to terminate a phone call as a group call. The telephone user must end the call. The recipient user is only allowed to talk back during the call.

The display shows `Ending Phone Call`.
If the call ends successfully:

- A tone sounds.
- The display shows `Call Ended`.

If the call fails to end, the radio returns to the Phone Call screen. Repeat [step 3](#) or wait for the telephone user to end the call.

Responding to Phone Calls as Private Calls

Follow the procedure to respond to Phone Calls as Private Calls on your radio.

When you receive a Phone Call as a Private Call:

- The display shows the **Phone Call** icon and `Phone Call`.
- The green LED blinks.
- Your radio unmutes and the incoming call sounds through the speaker.

1 Press the **PTT** button to respond to the call.

2 Release the **PTT** button to listen.

3 Press  to end the call.



NOTICE:

Your radio is not able to terminate a phone call as a group call. The telephone user must end the call. The recipient user is only allowed to talk back during the call.

The display shows `Ending Phone Call`.

If the call ends successfully:

- A tone sounds.
- The display shows `Call Ended`.

If the call fails to end, the radio returns to the Phone Call screen. Repeat [step 3](#) or wait for the telephone user to end the call.

Call Preemption

Call Preemption allows a radio to stop any in-progress voice transmission and initiate a priority transmission.

With the Call Preemption feature, the system interrupts and preempts ongoing calls in instances where trunked channels are unavailable.

Higher priority calls such as an Emergency Call or an All Call preempt the transmitting radio to accommodate the higher priority call. If no other Radio Frequency (RF) channels are available, an Emergency Call preempts an All Call as well.

Voice Interrupt

Voice Interrupt allows the user to shut down an in-progress voice transmission.

This feature uses reverse channel signaling to stop the in-progress voice transmission of a radio, if the interrupting radio is configured to Voice Interrupt, and the transmitting radio is configured to be Voice Call Interruptible. The interrupting radio is then allowed to make a voice transmission to the participant in the stopped call.

The Voice Interrupt feature significantly improves the probability of successfully delivering a new transmission to the intended parties when a call is in progress.

Voice Interrupt is accessible to the user only if this feature has been set up in the radio. Check with your dealer or system administrator for more information.

Enabling Voice Interrupt

Follow the procedure to initiate Voice Interrupt on your radio.

Your radio must be programmed to allow you to use this feature. Check with your dealer or system administrator for more information.

- 1 To interrupt the transmission during an on-going call, press the **PTT** button.

On the interrupted radio, the display shows `Call Interrupted`. The radio sounds a negative indicator tone until the **PTT** button is released.

- 2 Wait for acknowledgment.

If successful:

- A positive indicator tone sounds.

If unsuccessful:

- A negative indicator tone sounds.
-

- 3 Do one of the following:

- Wait for the Talk Permit Tone to end and speak clearly into the microphone if enabled.
 - Wait for the **PTT** Sidetone to end and speak clearly into the microphone if enabled.
-

Advanced Features

This chapter explains the operations of the features available in your radio.

[Send Feedback](#)

Your dealer or system administrator may have customized your radio for your specific needs. Check with your dealer or system administrator for more information.

Call Queue

When there are no resources available to process a call, Call Queue enables the call request to be placed in the system queue for the next available resources.

You hear a Call Queue Tone after pressing the **PTT** button and radio screen displays `Call In Queue` indicating that the radio has entered Call Queue State. The **PTT** button may be released once the Call Queue Tone is heard.

If the call setup is successful, the following occur:

- The green LED blinks.
- If enabled, the Talk Permit Tone sounds.
- The display shows the call type icon, ID or alias.
- The radio user has up to 4 seconds to press the **PTT** button to begin voice transmission.

If the call setup is unsuccessful, the following occur:

- If enabled, the Reject Tone sounds.
- The display shows the failure notice screen momentarily.

- The call is terminated and the radio exits the call setup.

Priority Call

Priority Call allows the system to preempt one of the ongoing non-priority calls and initiate the requested high priority call when all channels are busy.

With all channels occupied with high priority calls, the system does not preempt any calls, and places the requesting high-priority call into call queue. If the system fails to place the requesting high-priority call into call queue, it declares failure.

The default settings for Priority Call are preconfigured. Press the programmable button to toggle between normal and high priority level. When you use the following features, the call priority level reverts automatically to the preconfigured setting.

- All voice calls
- DMR III Text Message/Text Message
- Job Ticket
- Remote monitor



NOTICE:

Check with your dealer or system administrator to determine how your radio has been programmed.

The following are the types of Priority Call:

High Priority

The radio displays `Next Call: High Priority`.

Call Priority High icon appears at the top of your radio display.

Voice Announcement sounds `Next Call: High Priority`.

Normal Priority

The radio displays `Next Call: Normal Priority`.

Call Priority High icon disappears.

Voice Announcement sounds `Next Call: Normal Priority`.

Talkgroup Scan

This feature allows your radio to monitor and join calls for groups defined by a Receive Group List.

When scan is enabled, the scan icon appears on the status bar and the LED blinks yellow. Your radio unmutes to any member in its Receive Group List.

When scan is disabled, your radio does not receive transmission from any members of the Receive Group List, except for All Call and the selected Talkgroup.







NOTICE:



Talkgroup Scan can be configured by using CPS. Check with your system administrator to determine how your radio has been programmed.



Turning Talkgroup Scan On or Off

Follow the procedure to turn Talkgroup Scan on or off on your radio.

- 1 Press  to access the menu.

- 2 Press  or  to Scan. Press  to select.

- 3 Do one of the following:
 - Press  or  to Turn On. Press  to select.

- Press  or  to Turn Off. Press  to select.
-

If scan is enabled:

- The display shows Scan On and **Scan** icon.
- The yellow LED blinks.
- A positive indicator tone sounds.

If scan is disabled:

- The display shows Scan Off.
- The **Scan** icon disappears.
- The LED turns off.
- A negative indicator tone sounds.

Receive Group List

Receive Group List is a feature that allows you to create and assign members on the talkgroup scan list.

This list is created when your radio is programmed and it determines which groups can be scanned. Your radio can support a maximum of 16 members in this list.

If your radio has been programmed to edit the scan list, you can:

- Add/remove talkgroups.
- Add, remove, and/or edit priority for talkgroups. Refer to [Editing Priority for a Talkgroup on page 99](#).
- Add, remove, and/or edit affiliation talkgroups. Refer to [Adding Talkgroup Affiliation on page 100](#) and [Removing Talkgroup Affiliation on page 101](#).
- Replace the existing scan list with a new scan list.



IMPORTANT:

To add member into the list, the talkgroup must first be configured in the radio.



NOTICE:

Receive Group List is programmed by the system administrator. Check with your dealer or system administrator for more information.

Priority Monitor

The Priority Monitor feature allows the radio to automatically receive transmission from talkgroups with higher priority even when radio is in a talkgroup call.

Radio leaves lower priority talkgroup call for higher priority talkgroup call.



NOTICE:

This feature can only be accessed when Talkgroup Scan feature is enabled.

Priority Monitor feature applies only to members in the Receive Group List. There are two Priority Talkgroups: Priority 1 (P1) and Priority 2 (P2). P1 has higher priority than P2. In Capacity Max system, the radio receives transmission according to the priority order below:

- 1 Emergency Call for P1 Talkgroup
- 2 Emergency Call for P2 Talkgroup
- 3 Emergency Call for non-priority Talkgroups in the Receive Group List
- 4 All Call
- 5 P1 Talkgroup Call
- 6 P2 Talkgroup Call
- 7 Non-priority Talkgroups in the Receive Group List

See [Editing Priority for a Talkgroup on page 99](#) for more information on how to add, remove, and/or edit the priority of the talkgroups in the scan list.

**NOTICE:**

This feature is programmed by the system administrator. Check with your dealer or system administrator for more information.

Editing Priority for a Talkgroup

In the Talkgroup Scan Menu, you can view or edit the priority of a talkgroup.

- 1 Press to access the menu.

- 2 Press or to Scan. Press to select.

- 3 Press or to View/Edit List. Press to select.

- 4 Press or to the required talkgroup. Press to select.

The current priority is indicated by a **Priority 1** or **Priority 2** icon beside the talkgroup.

- 5 Press or to Edit Priority. Press to select.

- 6 Press or to the required priority level. Press to select.

If another talkgroup has been assigned to Priority 1 or Priority 2, you can choose to overwrite the current priority. When the display shows **Overwrite**

Existing?, press or to the following options:

- No to return to the previous step.
- Yes to overwrite.

The display shows positive mini notice before returning to the previous screen. The priority icon appears beside the talkgroup.

Multi-Talkgroup Affiliation

In a Capacity Max system, your radio can be configured for up to seven talkgroups at a site.

Of the 16 talkgroups in the Receive Group List, up to seven talkgroups can be assigned as affiliation talkgroups. The selected talkgroup and the priority talkgroups are automatically affiliated.



NOTICE:

This feature is programmed by the system administrator. Check with your dealer or system administrator for more information.

Adding Talkgroup Affiliation

Follow the procedure to add a talkgroup affiliation.

- 1 Press to access the menu.

- 2 Press or to Scan. Press to select.

- 3 Press or to View/Edit List. Press to select.

- 4 Press or to the required talkgroup ID or alias. Press to select.

The affiliation status is displayed at the View/Edit List. The display shows beside the selected talkgroup ID or alias.

- 5 Press or to Edit Affiliation. Press to select.
-

- 6 Do one of the following:

- Press or to On. Press to select.
- Press or to Off. Press to select.

When On is selected, appears beside the talkgroup ID or alias.

If affiliation is successful, the display shows beside the selected talkgroup ID or alias.

If affiliation is unsuccessful, remains beside the talkgroup ID or alias.



**NOTICE:**



The radio displays `List Full` when a maximum of seven talkgroups are selected for affiliation in the scan list. To select a new talkgroup for affiliation, remove an existing affiliated talkgroup to make way for the new addition. See [Removing Talkgroup Affiliation on page 101](#) for more information.



Removing Talkgroup Affiliation

When the affiliation list is full and you want to select a new talkgroup for affiliation, remove an existing affiliated talkgroup to make way for the new addition. Follow the procedure to remove a talkgroup affiliation.



- 1 Press  to access the menu.





- 2 Press  or  to `Scan`. Press  to select.

- 3 Press  or  to `View/Edit List`. Press  to select.

- 4 Press  or  to the required talkgroup ID or alias. Press  to select.

The affiliation status is displayed at the `View/Edit List`. The display shows  beside the selected talkgroup ID or alias.

- 5 Press  or  to `Edit Affiliation`. Press  to select.

- 6 Press  or  to `Off`. Press  to select.
When `Off` is selected,  disappears from beside the talkgroup ID or alias.

Talkback

The Talkback feature allows you to respond to a transmission while scanning.

If your radio scans into a call from the selectable group scan list, and if the **PTT** button is pressed during the scanned call, the operation of the radio depends on whether Talkback was enabled or disabled during radio

programming. Check with your dealer or system administrator for more information.

Talkback Disabled

The radio leaves the scanned call and attempts to transmit on the contact for the currently selected channel position. After the Call Hang Time on the currently selected contact expires, the radio returns to the home channel and starts the Scan Hang Time Timer. The radio resumes group scan after its Scan Hang Time Timer expires.

Talkback Enabled

If the **PTT** button is pressed during the Group Hang Time of the scanned call, the radio attempts to transmit to the scanned group.



NOTICE:

If you scan into a call for a group that is not assigned to a channel position in the currently selected zone and the call ends, switch to the proper zone and then select the channel position of the group to talk back to that group.

Bluetooth

This feature allows you to use your radio with a Bluetooth-enabled device (accessory) through a Bluetooth

connection. Your radio supports both Motorola Solutions and Commercially available Off-The-Shelf (COTS) Bluetooth-enabled devices.

Bluetooth operates within a range of 10 m (32 ft) line of sight. This is an unobstructed path between your radio and your Bluetooth-enabled device. For high degree of reliability, Motorola Solutions recommends to not separate the radio and the accessory.





At the fringe areas of reception, both voice and tone quality start to sound "garbled" or "broken". To correct this problem, position your radio and Bluetooth-enabled device closer to each other (within the 10 m defined range) to re-establish clear audio reception. The Bluetooth function of your radio has maximum power of 2.5 mW (4 dBm) at the 10 m range.

Your radio can support up to three simultaneous Bluetooth connections with Bluetooth-enabled devices of unique types. For example, a headset, a scanner, and a PTT-Only Device (POD). Multiple connections with Bluetooth-enabled devices of the same type are not supported.

Refer to the user manual of your respective Bluetooth-enabled device for more details on the full capabilities of your Bluetooth-enabled device.

**NOTICE:**



If disabled through CPS, all Bluetooth-related features are disabled and the Bluetooth device database is erased.





- Press  or  to Off. Press  to select. The display shows  beside Off.





Turning Bluetooth On and Off

Follow the procedure to turn Bluetooth on and off.

- 1 Press  to access the menu.

- 2 Press  or  to Bluetooth. Press  to select.

- 3 Press  or  to My Status. Press  to select.
The display shows On and Off. The current status is indicated by a .



- 4 Do one of the following:
 - Press  or  to On. Press  to select. The display shows  beside On.



Connecting to Bluetooth Devices



Follow the procedure to connect to Bluetooth devices.

Turn on your Bluetooth-enabled device and place it in pairing mode.

- 1 Press  to access the menu.

- 2 Press  or  to Bluetooth. Press  to select.

- 3 Press  or  to Devices. Press  to select.

- 4 Do one of the following:
 - Press  or  to the required device. Press  to select.

- Press  or  to Find Devices to locate available devices. Press  or  to the required device. Press  to select.

- 5 Press  or  to Connect. Press  to select.

Your Bluetooth-enabled device may require additional steps to complete the pairing. Refer to the user manual of your Bluetooth-enabled device.

The display shows Connecting to <Device>.

Wait for acknowledgment.

If successful:

- A positive indicator tone sounds.
- The display shows <Device> Connected and the **Bluetooth Connected** icon.
- The display shows  beside the connected device.

If unsuccessful:

- A negative indicator tone sounds.
- The display shows Connecting Failed.









NOTICE:

If pin code is required, see [Accessing Radios by Using Passwords on page 177](#).

Connecting to Bluetooth Devices in Discoverable Mode

Follow the procedure to connect to Bluetooth devices in discoverable mode.

Turn on your Bluetooth-enabled device and place it in pairing mode.

- 1 Press  to access the menu.
- 2 Press  or  to Bluetooth. Press  to select.
- 3 Press  or  to Find Me. Press  to select. The radio can now be found by other Bluetooth-enabled devices for a programmed duration. This is called Discoverable Mode.

Wait for acknowledgment.

If successful:







- A positive indicator tone sounds.
- The display shows <Device> Connected and the **Bluetooth Connected** icon.
- The display shows ✓ beside the connected device.



If unsuccessful:



- A negative indicator tone sounds.
- The display shows Connecting Failed.

Disconnecting from Bluetooth Devices

Follow the procedure to disconnect from Bluetooth devices.

- 1 Press  to access the menu.
- 2 Press  or  to Bluetooth. Press  to select.
- 3 Press  or  to Devices. Press  to select.

- 4 Press  or  to the required device. Press  to select.

- 5 Press  or  to Disconnect. Press  to select.

The display shows Disconnecting from <Device>.



NOTICE:

Your Bluetooth-enabled device may require additional steps to disconnect. Refer to respective user manuals of any Bluetooth-enabled devices.

Wait for acknowledgment.

- A tone sounds.
- The display shows <Device> Disconnected and the **Bluetooth Connected** icon disappears.
- The ✓ disappears beside the connected device.

Switching Audio Route between Internal Radio Speaker and Bluetooth Device

Follow the procedure to toggle audio routing between internal radio speaker and external Bluetooth device.

Press the programmed **Bluetooth Audio Switch** button.



The display shows one of the following results:

- A tone sounds. The display shows `Route Audio to Radio.`
- A tone sounds. The display shows `Route Audio to Bluetooth.`



Viewing Device Details



Follow the procedure to view device details on your radio.

- 1 Press  to access the menu.

- 2 Press  or  to Bluetooth. Press  to select.

- 3 Press  or  to Devices. Press  to select.



- 4 Press  or  to the required device. Press  to select.



- 5 Press  or  to View Details. Press  to select.



Deleting Device Name



You can remove a disconnected device from the list of Bluetooth-enabled devices.

- 1 Press  to access the menu.

- 2 Press  or  to Bluetooth. Press  to select.

3 Press  or  to `Devices`. Press  to select.



4 Press  or  to the required device. Press  to select.



5 Press  or  to `Delete`. Press  to select. The display shows `Device Deleted`.



Bluetooth Mic Gain



This feature allows the user to control the microphone gain value of the connected Bluetooth-enabled device.

1 Press  to access the menu.

2 Press  or  to `Bluetooth`. Press  to select.

3 Press  or  to `BT Mic Gain`. Press  to select.

4 Press  or  to the `BT Mic Gain` type and the current values. Press  to select. You can edit the values here.

5 Press  or  to increase or to decrease values. Press  to select.

Indoor Location











NOTICE:

Indoor Location feature is applicable for models with the latest software and hardware. Check with your dealer or system administrator for more information.

Indoor Location is used to keep track of the location of radio users. When Indoor Location is activated, the radio is in a limited discoverable mode. Dedicated beacons are used to locate the radio and determine its position.

Turning Indoor Location On or Off

You can turn on or turn off Indoor Location by performing one of the following actions.

- Access this feature through the menu.
 - a. Press  to access the menu.
 - b. Press  or  to Bluetooth and press  to select.
 - c. Press  or  to Indoor Location and press  to select.
 - d. Press  to turn on Indoor Location.

The display shows Indoor Location On. You hear a positive indicator tone.

One of the following scenarios occurs.

- If successful, the Indoor Location Available icon appears on the Home screen display.

- If unsuccessful, the display shows Turning On Failed. You hear a negative indicator tone.

- e. Press  to turn off Indoor Location.

The display shows Indoor Location Off. You hear a positive indicator tone.

One of the following scenarios occurs.

- If successful, the Indoor Location Available icon disappears on the Home screen display.
- If unsuccessful, the display shows Turning Off Failed. You hear a negative indicator tone.

- Access this feature by using the programmed button.
 - a. Long press the programmed **Indoor Location** button to turn on Indoor Location.

The display shows Indoor Location On. You hear a positive indicator tone.

One of the following scenarios occurs.

- If successful, the Indoor Location Available icon appears on the Home screen display.

- If unsuccessful, the display shows **Turning On Failed**. If unsuccessful, you hear a negative indicator tone.
- b. Press the programmed **Indoor Location** button to turn off Indoor Location.

The display shows **Indoor Location Off**. You hear a positive indicator tone.



One of the following scenarios occurs.



- If successful, the Indoor Location Available icon disappears on the Home screen display.
- If unsuccessful, the display shows **Turning Off Failed**. If unsuccessful, you hear a negative indicator tone.



Accessing Indoor Location Beacons Information

Follow the procedure to access Indoor Location beacons information.

- 1 Press  to access the menu.

- 2 Press  or  to **Bluetooth** and press  to select.

- 3 Press  or  to **Indoor Location** and press  to select.

- 4 Press  or  to **Beacons** and press  to select.

The display shows the beacons information.

Multi-Site Controls

These features are applicable when your current radio channel is configured to a Capacity Max system.

Starting Manual Site Search

Follow the procedure to start manual site search when the received signal strength is poor in order to attempt to find a site with better signal.

If the radio finds a new site:

- A positive indicator tone sounds.

If the radio fails to find a new site:

- A negative indicator tone sounds.

Site Lock On/Off

When toggled on, the radio searches the current site only.
When toggled off, the radio searches other sites in addition to the current site.

Press the programmed **Site Lock** button.

If the **Site Lock** function is toggled on:

- You hear a positive indicator tone, indicating the radio has locked to the current site.
- The display shows `Site Locked`.



If the **Site Lock** function is toggled off:



- You hear a negative indicator tone, indicating the radio is unlocked.
 - The display shows `Site Unlocked`.
-



Accessing Neighbor Sites List

This feature allows the user to check the adjacent sites list of the current home site. Follow the procedure to access the Neighbor Sites List:

- 1 Press  to access the menu.

- 2 Press  or  to Utilities. Press  to select.

- 3 Press  or  to Radio Info. Press  to select.

- 4 Press  or  to Neighbor Sites. Press  to select.

Home Channel Reminder

This feature provides a reminder when the radio is not set to the home channel for a period of time.

If this feature is enabled when your radio is not set to the home channel for a period of time, the following occurs periodically:

- The Home Channel Reminder tone and announcement sound.
- The first line of the display shows Non.
- The second line shows Home Channel.

Muting the Home Channel Reminder

When the Home Channel Reminder sounds, you can temporarily mute the reminder.



Press the **Silence Home Channel Reminder** programmable button.



The first line of the display shows HCR and the second line shows Silenced.



Setting New Home Channels





When the Home Channel Reminder occurs, you can set a new home channel.

- 1 Do one of the following:
 - Press the **Reset Home Channel** programmable button to set the current channel as the new Home Channel. Skip the following steps. The first line of the display shows the channel alias and the second line shows New Home Ch.
 - Press  to access the menu.
-

- 2 Press  or  to Utilities. Press  to select.
-

- 3 Press  or  to Radio Settings. Press  to select.
-

- 4 Press  or  to Home Channel. Press  to select.
-

- 5 Press  or  to the desired new home channel alias. Press  to select.
- The display shows  beside the selected home channel alias.
-

Remote Monitor

This feature is used to turn on the microphone of a target radio with a subscriber alias or ID. You can use this feature to remotely monitor any audible activity surrounding the target radio.



Both your radio and the target radio must be programmed to allow you to use this feature.

If initiated, the green LED blinks once on the target radio. This feature automatically stops after a programmed duration or when there is any user operation on the target radio.

Initiating Remote Monitor

Follow the procedure to initiate Remote Monitor on your radio.

- 1 Press the programmed **Remote Monitor** button.
-

- 2 Press  or  to the required alias or ID. Press  to select.

The display shows a transitional mini notice, indicating the request is in progress. The green LED lights up.

- 3 Wait for acknowledgment.

If successful:

- A positive indicator tone sounds.
- The display shows a positive mini notice.
- The audio from the monitored radio starts playing for a programmed duration, and the display shows `Rem. Monitor`. Once the timer expires, an alert tone sounds, and the LED turns off.



If unsuccessful:



- A negative indicator tone sounds.
 - The display shows a negative mini notice.
-



Initiating Remote Monitor by Using the Contacts List

Follow the procedure to initiate Remote Monitor on your radio by using the Contacts list.

- 1 Press  to access the menu.

- 2 Press  or  to Contacts. Press  to select.

- 3 Press  or  to the required alias or ID.
Press  to select.

- 4 Press  or  to Remote Mon.. Press  to select.

The display shows a transitional mini notice, indicating the request is in progress. The green LED lights up.

- 5 Wait for acknowledgment.
If successful:

- A positive indicator tone sounds.
- The display shows a positive mini notice.
- The audio from the monitored radio starts playing for a programmed duration, and the display shows Rem. Monitor. Once the timer expires, an alert tone sounds, and the LED turns off.



If unsuccessful:



- A negative indicator tone sounds.
- The display shows a negative mini notice.



Initiating Remote Monitors by Using the Manual Dial

Follow the procedure to initiate Remote Monitor on your radio by using the manual dial.



- 1 Press  to access the menu.

- 2 Press  or  to Contacts. Press  to select.

3 Press  or  to Manual Dial. Press  to select.

4 Press  or  to Radio Number. Press  to select.

5 Do one of the following:

- Enter the subscriber alias or ID, and press  to proceed.
 - Edit the previously dialed ID, and press  to proceed.
-

6 Press  or  to Remote Mon.. Press  to select.

The display shows a transitional mini notice, indicating the request is in progress. The green LED lights up.

7 Wait for acknowledgment.

If successful:

- A positive indicator tone sounds.

- The display shows a positive mini notice.
- The audio from the monitored radio starts playing for a programmed duration, and the display shows Rem. Monitor. Once the timer expires, an alert tone sounds, and the LED turns off.

If unsuccessful:

- A negative indicator tone sounds.
 - The display shows a negative mini notice.
-

Contacts Settings

Contacts provides address book capabilities on your radio. Each entry corresponds to an alias or ID that you use to initiate a call. The entries are alphabetically sorted.

Each entry, depending on context, associates with the different call types: Group Call, Private Call, Broadcast Call, Site All Call, Multi-site All Call, PC Call, or Dispatch Call.

PC Call and Dispatch Call are data-related. They are only available with the applications. Refer to the data applications documentation for further details.

Additionally, Contacts menu allows you to assign each entry to a programmable number key or more on a keypad

microphone. If an entry is assigned to a number key, your radio can perform a quick dial on the entry.



NOTICE:

You see a checkmark before each number key that is assigned to an entry. If the checkmark is before Empty, you have not assign a number key to the entry.

Each entry within Contacts displays the following information:

- Call Type
- Call Alias
- Call ID







NOTICE:



If the Privacy feature is enabled on a channel, you can make privacy-enabled Group Calls, Private Calls, All Calls, and Phone Calls on that channel. Only target radios with the same Privacy Key, or the same Key Value and Key ID as your radio will be able to decrypt the transmission.



Assigning Entries to Programmable Number Keys



Follow the procedure to assign entries to programmable number keys on your radio.

- 1 Press  to access the menu.



- 2 Press  or  to Contacts. Press  to select.

- 3 Press  or  to the required alias or ID. Press  to select.

- 4 Press  or  to Program Key. Press  to select.



- 5 Do one of the following:
 - If the desired number key has not been assigned to an entry, press  or  to the desired number key. Press  to select.

- If the desired number key has been assigned to an entry, the display shows `The Key is Already Assigned` and then, the first text line shows `Overwrite?`. Do one of the following:

Press  or  to `Yes`. Press  to select.

The radio sounds a positive indicator tone and the display shows `Contact Saved` and a positive mini notice.

Press  or  to `No` to return to the previous step.

Each entry can be associated to different number keys. You see a  before each number key that is assigned to an entry. If the  is before `Empty`, that number key is not assigned.



If a number key is assigned to an entry in a particular mode, this feature is not supported when you long press the number key in another mode.



The screen automatically returns to the previous menu.

Removing Associations Between Entries and Programmable Number Keys



Follow the procedure to remove the associations between entries and programmable number keys on your radio.



- Do one of the following:
 - Long press the programmed number key to the required alias or ID. Proceed to [step 4](#).
 - Press  to access the menu.
-

- Press  or  to `Contacts`. Press  to select.
-

- Press  or  to the required alias or ID. Press  to select.
-

- Press  or  to `Program Key`. Press  to select.
-

- 5 Press  or  to Empty. Press  to select.
The first text line shows Clear from all keys.
-

- 6 Press  or  to Yes. Press  to select.



NOTICE:

When an entry is deleted, the association between the entry and its programmed number key(s) is removed.



A positive indicator tone sounds. The display shows Contact Saved.



The screen automatically returns to the previous menu.



Adding New Contacts

Follow the procedure to add new contacts on your radio.

- 1 Press  to access the menu.
-



- 2 Press  or  to Contacts. Press  to select.
-

- 3 Press  or  to New Contact. Press  to select.
-

- 4 Press  or  to select contact type Radio Contact or Phone Contact. Press  to select.
-

- 5 Enter the contact number with the keypad, and press  to proceed.
-

- 6 Enter the contact name with the keypad, and press  to proceed.
-

- 7 Press  or  to the required ringer type.
Press  to select.

A positive indicator tone sounds. The display shows a positive mini notice.



Call Indicator Settings



This feature allows the radio users to configure call or text message ringing tones.



Activating or Deactivating Call Ringers for Private Calls



Follow the procedure to activate or deactivate call ringers for Private Calls on your radio.



- 1 Press  to access the menu.



- 2 Press  or  to Utilities. Press  to select.

- 3 Press  or  to Radio Settings. Press  to select.

- 4 Press  or  to Tones/Alerts. Press  to select.

- 5 Press  or  to Call Ringers. Press  to select.

- 6 Press  or  to Private Call. Press  to select.



- 7 Press  or  to the required tone. Press  to select.



If enabled, ✓ appears beside Enabled. If disabled, ✓ disappears beside Enabled.



Activating or Deactivating Call Ringers for Text Messages



Follow the procedure to activate or deactivate call ringers for text messages on your radio.





- 1 Press  to access the menu.





2 Press  or  to Utilities. Press  to select.

3 Press  or  to Radio Settings. Press  to select.

4 Press  or  to Tones/Alerts. Press  to select.

5 Press  or  to Call Ringers. Press  to select.



6 Press  or  to Text Message. Press  to select.
The display shows  and the current tone.



7 Press  or  to the required tone. Press  to select. The display shows  beside the selected tone.



Activating or Deactivating Call Ringers for Call Alerts



Follow the procedure to activate or deactivate call ringers for Call Alerts on your radio.



1 Press  to access the menu.

2 Press  or  to Utilities. Press  to select.

3 Press  or  to Radio Settings. Press  to select.

4 Press  or  to Tones/Alert. Press  to select.











5 Press  or  to Call Ringers. Press  to select.



6 Press  or  to Call Alert. Press  to select.



- 7 Press  or  to the required tone. Press  to select. The display shows ✓ beside the selected tone.
-



Activating or Deactivating Call Ringers for Selective Calls

Follow the procedure to activate or deactivate call ringers for Selective Calls on your radio.

- 1 Press  to access the menu.
-
- 2 Press  or  to Utilities. Press  to select.
-
- 3 Press  or  to Radio Settings. Press  to select.
-
- 4 Press  or  to Tones/Alerts. Press  to select.
-

- 5 Press  or  to Call Ringers. Press  to select.
-



- 6 Press  or  to Selective Call. Press  to select.
The display shows ✓ and the current tone.
-



- 7 Press  or  to the required tone. Press  to select. The display shows ✓ beside the selected tone.
-

Activating or Deactivating Call Ringers for Telemetry Status with Text



Follow the procedure to activate or deactivate call ringers for telemetry status with text on your radio.



- 1 Press  to access the menu.
-

2 Press  or  to Utilities. Press  to select.

3 Press  or  to Radio Settings. Press  to select.

4 Press  or  to Tones/Alert. Press  to select.

5 Press  or  to Call Ringers. Press  to select.

6 Press  or  to Telemetry. Press  to select.

The current tone is indicated by a .

Assigning Ring Styles



The radio can be programmed to sound one of eleven predefined ringing tones when receiving a Private Call, a Call Alert, or a Text Message from a particular contact. The

radio sounds out each ring style as you navigate through the list. Follow the procedure to assign ring styles on your radio.



1 Press  to access the menu.

2 Press  or  to Contacts. Press  to select.

The entries are alphabetically sorted.



3 Press  or  to the required alias or ID.

Press  to select.

4 Press  or  to View/Edit. Press  to select.

5 Press  until display shows Ringer menu

A  indicates the current selected tone.

6 Press  or  to the required tone. Press

 to select.



A  appears beside the selected tone.



- Delete All Calls
- View Details

Viewing Recent Calls

Follow the procedure to view recent calls on your radio.

1 Press  to access the menu.

2 Press  or  to Call Log. Press  to select.

3 Press  or  to the preferred list. The options are Missed, Answered, and Outgoing lists.

Press  to select.

The display shows the most recent entry.

4 Press  or  to view the list.

You can start a call with the alias or ID the display is currently showing by pressing the **PTT** button.

Escalating Alarm Tone Volume

The radio can be programmed to continually alert, when a radio call remains unanswered. This is done by automatically increasing the alarm tone volume over time. This feature is known as Escalart.

Call Log Features

Your radio keeps track of all recent outgoing, answered, and missed Private Calls. The call log feature is used to view and manage recent calls.



Missed Call Alerts may be included in the call logs, depending on the system configuration on your radio. You can perform the following tasks in each of your call lists:



- Store Alias or ID to Contacts
- Delete Call



Storing Aliases or IDs from the Call List



Follow the procedure to store aliases or IDs on your radio from the Call list.

- 1 Press  to access the menu.

- 2 Press  or  to Call Log. Press  to select.

- 3 Press  or  to the required list. Press  to select.

- 4 Press  or  to the required alias or ID.
Press  to select.

- 5 Press  or  to Store. Press  to select.
The display shows a blinking cursor.

- 6 Enter the rest of the characters of the required alias.
Press  to select.



You can store an ID without an alias.



The display shows a positive mini notice.



Deleting Calls from the Call List



Follow the procedure to delete calls on your radio from the Call list.

- 1 Press  to access the menu.





- 2 Press  or  to Call Log. Press  to select.

- 3 Press  or  to the required list. Press  to select.
If the list is empty:
 - A tone sounds.
 - The display shows List Empty.

4 Press  or  to the required alias or ID.
Press  to select.

5 Press  or  to Delete Entry?. Press  to select.



6 Do one of the following:



- Press  to select Yes to delete the entry.
The display shows Entry Deleted.
 - Press  or  to No. Press  to select.
The radio returns to the previous screen.
-



Deleting All Calls from the Call List



Follow the procedure to delete all calls on your radio from the Call list.

1 Press  to access the menu.





2 Press  or  to Call Log. Press  to select.

3 Press  or  to the required list. Press  to select.

4 Press  or  to the required alias or ID.
Press  to select.

5 Press  or  to Delete All. Press  to select.



6 Do one of the following:



- Press  to select Yes to delete all entries.
The display shows a positive mini notice.
 - Press  or  to No. Press  to select.
The radio returns to the previous screen.
-



Viewing Details from the Call List



Follow the procedure to view details on your radio from the Call list.

- 1 Press  to access the menu.

- 2 Press  or  to Call Log. Press  to select.

- 3 Press  or  to the required list. Press  to select.

- 4 Press  or  to the required alias or ID.
Press  to select.

- 5 Press  or  to View Details. Press  to select.
The display shows the details.

Call Alert Operation

Call Alert paging enables you to alert a specific radio user to call you back when they are able to do so.

This feature is applicable for subscriber aliases or IDs only and is accessible through the menu by using Contacts, manual dial, or a programmed **One Touch Access** button.

In Capacity Max, the Call Alert feature allows a radio user or a dispatcher to send an alert to another radio user requesting the radio user to call back the initiating radio user when available. Voice communication is not involved in this feature.

The Call Alert Operation can be configured by the dealer or the system administrator in two ways:

- The radio is configured to allow the user to press the **PTT** button to respond directly to the call initiator by making a Private Call.
- The radio is configured to allow the user to press the **PTT** button and continue with other Talkgroup communication. Pressing the **PTT** button on the call alert entry will not allow the user to respond to the call initiator. The user must navigate to the Missed Call Log option at the Call Log menu and respond to the Call Alert from there.

An Off Air Call Set-Up (OACSU) private call allows the user to respond immediately while a Full Off Air Call Set-Up (FOACSU) private call requires user acknowledgment for the call. OACSU type calls are therefore, recommended being used for the call alert feature. See [Private Call on page 71](#).

Making Call Alerts

Follow the procedure to make Call Alerts on your radio.

- 1 Press the programmed **One Touch Access** button.

The display shows **Call Alert** and the subscriber alias or ID. The green LED lights up.

- 2 Wait for acknowledgment.



If the Call Alert acknowledgment is received, the display shows a positive mini notice.



If the Call Alert acknowledgment is not received, the display shows a negative mini notice.



Making Call Alerts by Using the Contacts List

Follow the procedure to make Call Alerts on your radio by using the Contacts list.

- 1 Press  to access the menu.
-

- 2 Press  or  to **Contacts**. Press  to select.
-

- 3 Press  or  to the required alias or ID. Press  to select.
-

- 4 Press  or  to **Call Alert**. Press  to select.

The display shows **Call Alert** and the subscriber alias or ID. The green LED lights up.

- 5 Wait for acknowledgment.
 - If the Call Alert acknowledgment is received, the display shows a positive mini notice.

- If the Call Alert acknowledgment is not received, the display shows a negative mini notice.

The Call Alert is moved to the Missed Call option at the Call Log menu. You can respond to the caller from the Missed Called log.

Responding to Call Alerts

Follow the procedure to respond to Call Alerts on your radio.

When you receive a Call Alert:

- A repetitive tone sounds.
- The yellow LED blinks.
- The display shows the notification list listing a Call Alert with the alias or ID of the calling radio.

Depending on the configuration by your dealer or system administrator, you can respond to a Call Alert by doing one of the following:

- Press the **PTT** button and respond with a Private Call directly to the caller.
- Press the **PTT** button to continue normal talkgroup communication.

See [Notification List on page 180](#) and [Call Log Features on page 122](#) for more information.

Mute Mode

Mute Mode provides an option to the user to silence all audio indicators of the radio.

Once Mute Mode feature is initiated, all audio indicators are muted except higher priority features such as Emergency operations.

When Mute Mode is exited, the radio resumes playing ongoing tones and audio transmissions.



NOTICE:

This is a purchasable feature. Check with your dealer or system administrator for more information.

Turning On Mute Mode

Follow the procedure to turn on Mute Mode.

Access this feature by using the programmed **Mute Mode** button.

The following occurs when Mute mode is enabled:



- Positive Indicator Tone sounds.
- Display shows `Mute Mode On`.
- The red LED light starts blinking and remains blinking until Mute Mode is exited.
- Display shows **Mute Mode** icon on home screen.
- Radio is muted.
- Mute Mode Timer begins counting down the duration that is configured.



Setting Mute Mode Timer



Mute Mode feature can be enabled for a pre-configured amount of time by setting the Mute Mode Timer. The timer duration is configured in the radio menu and can range between 0.5–6 hours. Mute Mode is exited once the timer expires.



If the timer is left at 0, the radio remains in Mute mode for an indefinite period until the programmed **Mute Mode** button is pressed.

- 1 Press  to access the menu.

- 2 Press  or  to Utilities. Press  to select.

- 3 Press  or  to Radio Settings. Press  to select.

- 4 Press  or  to Mute Timer. Press  to select.

- 5 Press  or  to edit the numeric value of each digit, and press .

Exiting Mute Mode

This feature can be exited automatically once the Mute Mode Timer expires.

Do one of the following to exit Mute mode manually:

- Press the programmed **Mute Mode** button.
- Press the **PTT** button on any entry.

The following occurs when Mute mode is disabled:

- Negative Indicator Tone sounds.
- Display shows `Mute Mode Off`.
- The blinking red LED turns off.
- **Mute Mode** icon disappears from home screen.
- Your radio unmutes and speaker state is restored.
- If the timer has not expired, Mute mode timer is stopped.



NOTICE:

Mute Mode is also exited if the user transmits voice or switches to an unprogrammed channel.

Emergency Operation

An Emergency Alarm is used to indicate a critical situation. You are able to initiate an Emergency at any time even when there is activity on the current channel.

In Capacity Max, the receiving radio can only support a single Emergency Alarm at a time. If initiated, a second Emergency Alarm will override the first alarm.

When an Emergency Alarm is received, the recipient may choose to either delete the alarm and exit the Alarm List, or respond to the Emergency Alarm by pressing the **PTT** button and transmitting non-emergency voice.

Your dealer or system administrator can set the duration of a button press for the programmed **Emergency** button, except for long press, which is similar with all other buttons:

Short Press

Duration between 0.05 seconds and 0.75 seconds.

Long Press

Duration between 1.00 second and 3.75 seconds.

The **Emergency** button is assigned with the Emergency On/Off feature. Check with your dealer for the assigned operation of the **Emergency** button.

**NOTICE:**

If short press the **Emergency** button is assigned to turn on the Emergency mode, then long press the **Emergency** button is assigned to exit the Emergency mode.

If long press the **Emergency** button is assigned to turn on the Emergency mode, then short press the **Emergency** button is assigned to exit the Emergency mode.

Your radio supports three Emergency Alarms:

- Emergency Alarm
- Emergency Alarm with Call
- Emergency Alarm with Voice to Follow

In addition, each alarm has the following types:

Regular

Radio transmits an alarm signal and shows audio and/or visual indicators.

Silent

Radio transmits an alarm signal without any audio or visual indicators. Radio receives calls without any sound through the speaker, until the programmed *hot mic* transmission period is over and/or you press the **PTT** button.

Silent with Voice

Radio transmits an alarm signal without any audio or visual indicators, but allow incoming calls to sound through the speaker.

**NOTICE:**

Only one of the Emergency Alarms above can be assigned to the programmed **Emergency** button or the **Emergency** footswitch.

Sending Emergency Alarms

This feature allows you to send an Emergency Alarm, a non-voice signal, which triggers an alert indication on a group of radios. Follow the procedure to send Emergency Alarms on your radio.

Your radio does not display any audio or visual indicators during Emergency mode when it is set to Silent.

- 1 Press the programmed **Emergency On** button.

You see one of these results:

- The display shows Tx Alarms and the destination alias.
- The display shows Tx Telegram and the destination alias.

The green LED lights up. The **Emergency** icon appears.



NOTICE:

If programmed, the Emergency Search tone sounds. This tone is muted when the radio transmits or receives voice, and stops when the radio exits Emergency mode. The Emergency Search tone can be programmed by the dealer or system administrator.

2 Wait for acknowledgment.

If successful:

- The Emergency tone sounds.
- The green LED blinks.
- The display shows `Alarm Sent`.

If unsuccessful after all retries have been exhausted:

- A tone sounds.
- The display shows `Alarm Failed`.

The radio exits the Emergency Alarm mode and returns to the Home screen.



NOTICE:

When configured for Emergency Alarm only, the emergency process consists only of the Emergency Alarm delivery. The emergency ends when an acknowledgment is received from the system, or when channel access attempts have been exhausted.

No voice call is associated with the sending of an Emergency Alarm when operating as Emergency Alarm Only.

Sending Emergency Alarms with Call

This feature allows you to send an Emergency Alarm with Call to a group of radios or a dispatcher. Upon acknowledgment by the infrastructure within the group, a group of radios can communicate over a programmed Emergency channel.

The radio must be configured for Emergency Alarm and Call to perform an emergency call after the alarm process.

1 Press the programmed **Emergency On** button.

The display shows Tx Alarm and the destination alias. The **Emergency** icon appears. The green LED lights up.



NOTICE:

If programmed, the Emergency Search tone sounds. This tone is muted when the radio transmits or receives voice, and stops when the radio exits Emergency mode.

If an Emergency Alarm acknowledgment is successfully received:

- The Emergency tone sounds.
- The green LED blinks.
- The display shows Alarm Sent.
- Your radio enters the Emergency call mode when the display shows Emergency and the destination group alias.

If an Emergency Alarm acknowledgment is not successfully received:

- All retries are exhausted.
- A low-pitched tone sounds.
- The display shows Alarm Failed.

- The radio exits the Emergency Alarm mode.

2 Press the **PTT** button to initiate a voice transmission.

The green LED lights up. The display shows the **Group Call** icon.

3 Do one of the following:

- Wait for the Talk Permit Tone to end and speak clearly into the microphone if enabled.
- Wait for the **PTT** Sidetone to end and speak clearly into the microphone if enabled.

4 Release the **PTT** button to listen.

The display shows the caller and group aliases.

5 If the Channel Free Indication feature is enabled, you hear a short alert tone the moment the transmitting radio releases the **PTT** button, indicating the channel is free for you to respond. Press the **PTT** button to respond to the call.

- 6 Press the **Emergency Off** button to exit the Emergency mode.

The radio returns to the Home screen.



NOTICE:

Depending on how your radio is programmed, you may or may not hear a Talk Permit tone. Your radio dealer or system administrator can provide more information on how your radio has been programmed for Emergency.

The Emergency Call initiator may press  to end an on-going emergency call. The radio returns to a call idle state but the emergency call screen remains open.



NOTICE:

Your radio cannot detect a non-IMPRES microphone that is attached to the rear accessory connector.

When no microphone is detected at the specified programmed connector, your radio checks the alternative connector. Here, your radio gives priority to the detected microphone.

If your radio has Emergency Cycle Mode enabled, repetitions of *hot mic* and receiving period are made for a programmed duration. During Emergency Cycle Mode, received calls sound through the speaker.

If you press the **PTT** button during the programmed receiving period, you hear a prohibit tone, indicating that you should release the **PTT** button. The radio ignores the **PTT** button press and remains in Emergency mode.

If you press the **PTT** button during *hot mic*, and continue to press it after the *hot mic* duration expires, the radio continues to transmit until you release the **PTT** button.

If the Emergency Alarm request fails, the radio does not retry to send the request, and enters the *hot mic* state directly.

Sending Emergency Alarms with Voice to Follow

This feature allows you to send an Emergency Alarm with Voice to Follow to a group of radios. Your radio microphone is automatically activated, allowing you to communicate with the group of radios without pressing the **PTT** button. This activated microphone state is also known as *hot mic*.

**NOTICE:**

Some accessories may not support *hot mic*. Check with your dealer or system administrator for more information.

Follow the procedure to send Emergency Alarms with voice to follow on your radio.

- 1 Press the programmed **Emergency On** button or the **Emergency** footswitch.

You see one of these results:

- The display shows Tx Alarm and the destination alias.
- The display shows Tx Telegram and the destination alias.

The green LED lights up. The **Emergency** icon appears.

-
- 2 Once the display shows Alarm Sent, speak clearly into the microphone.

The radio automatically stops transmitting when:

- The cycling duration between *hot mic* and receiving calls expires, if Emergency Cycle Mode is enabled.

- The *hot mic* duration expires, if Emergency Cycle Mode is disabled.

-
- 3 Press the **Emergency Off** button to exit the Emergency mode.

The radio returns to the Home screen.

Receiving Emergency Alarms

The receiving radio can only support a single Emergency Alarm at a time. If initiated, a second Emergency Alarm will override the first alarm. Follow the procedure to receive and view Emergency Alarms on your radio.

When you receive an Emergency Alarm:

- A tone sounds.
- The red LED blinks.
- The display shows the Emergency Alarm List, the Emergency Talkgroup ID or alias, and the ID or alias of the transmitting radio.

- 1 Press  to view the alarm.
-

2 Press  to view the action options and details of the entry in the Alarm List.

3 Press  and select Yes to exit the Alarm list.

The radio returns to the home screen with an **Emergency Icon** displayed at the top, indicating the unresolved Emergency Alarm. The **Emergency Icon** disappears once the entry in the Alarm List is deleted.

4 Press  to access the menu.

5 Select `Alarm List` to revisit the Alarm list.



6 The tone sounds and the red LED blinks until you exit the Emergency mode. However, the tone can be silenced. Do one of the following:

- Press the **PTT** button to call the group of radios which received the Emergency Alarm.
 - Press any programmable button.
-

Responding to Emergency Alarms

When an Emergency Alarm is received, the recipient may choose to either delete the alarm and exit the Alarm List, or respond to the Emergency Alarm by pressing the **PTT** button and transmitting non-emergency voice. Follow the procedure to respond to Emergency Alarms on your radio.

1 If the Emergency Alarm Indication is enabled, the Emergency Alarm List appears when the radio

receives an Emergency Alarm. Press  or  to the required alias or ID.

2 If the Channel Free Indication feature is enabled, you hear a short alert tone the moment the transmitting radio releases the **PTT** button, indicating the channel is free for you to respond. Press the **PTT** button to transmit non-emergency voice to the same group the Emergency Alarm targeted.

The green LED lights up.

3 Do one of the following:

- Wait for the Talk Permit Tone to end and speak clearly into the microphone if enabled.

- Wait for the **PTT** Sidetone to end and speak clearly into the microphone if enabled.
-

4 Release the **PTT** button to listen.

When the emergency initiating radio responds:

- The red LED blinks.
- The display shows the **Emergency Call** icon, the Emergency Talkgroup ID or alias, and the ID or alias of the transmitting radio.



NOTICE:

If the Emergency Call Indication is not enabled, the display shows the **Group Call** icon, Emergency Talkgroup ID or alias, and the ID or alias of the transmitting radio.

Responding to Emergency Alarms with Call

Follow the procedure to respond to Emergency Alarms with Call on your radio.

When you receive an Emergency Call:

- The Emergency Call Tone sounds if the Emergency Call Indication and Emergency Call Decode Tone is enabled. The Emergency Call Tone will not sound if only the Emergency Call Indication is enabled.
- The display shows the **Emergency Call** icon at the top right corner.
- The text line shows the Emergency Talkgroup ID or alias, and the ID or alias of the transmitting radio.
- Your radio unmutes and the incoming call sounds through the speaker.

- 1** If the Channel Free Indication feature is enabled, you hear a short alert tone the moment the transmitting radio releases the **PTT** button, indicating the channel is free for you to respond. Press the **PTT** button to respond to the call.

The green LED lights up.

- 2** Wait for the Talk Permit Tone to end and speak clearly into the microphone if enabled.
-

3 Release the **PTT** button to listen.

When the emergency initiating radio responds:

- The red LED blinks.

- The display shows the **Emergency Call** icon, the Emergency Talkgroup ID or alias, and the ID or alias of the transmitting radio.

**NOTICE:**

If the Emergency Call Indication is not enabled, the display shows the **Group Call** icon, Emergency Talkgroup ID or alias, and the ID or alias of the transmitting radio.

Status Message

This feature allows the user to send status messages to other radios.

The Quick Status list is configured by using CPS-RM and comprises up to a maximum of 99 statuses.













The maximum length for each status message is 16 characters.

**NOTICE:**

Every status has a corresponding digital value ranging from 0–99. An alias can be specified to each status for ease of reference.

Sending Status Messages

Follow the procedure below to send a status message.

- Do one of the following:
 - Press the programmed **One Touch Access** button. Skip the following steps.
 - Press  to access the menu.
- Press  or  to **Status**. Press  to select.
- Press  or  to **Quick Status**. Press  to select.
- Press  or  to the required status message. Press  to select.
- Press  or  to the required subscriber alias or ID, or group alias or ID. Press  to select.

If successful:

- A positive indicator tone sounds.
- The LED turns off.
- The display shows a positive mini notice momentarily before returning to the `Quick Status` screen.
- The display shows ✓ beside the sent status message.



If unsuccessful:



- A negative indicator tone sounds.
- The LED turns off.
- The display shows the failure notice momentarily before returning to the `Quick Status` screen.

Sending Status Message by Using Programmable Button

Follow the procedure to send a status message by using the programmable button.

1 Press the programmed **Status Message** button.

2 Press  or  to the required status message.
Press  to select. The contact list is displayed.

3 Press  or  to the required subscriber alias or ID, or group alias or ID. Press  to select.

If successful:

- A positive indicator tone sounds.
- The LED turns off.
- The display shows a positive mini notice momentarily before returning to the `Quick Status` screen.
- The display shows ✓ beside the sent status message.



If unsuccessful:



- A negative indicator tone sounds.
- The LED turns off.
- The display shows the failure notice momentarily before returning to the `Quick Status` screen.



Sending a Status Message by Using the Contacts List



Follow the procedure to send a status message by using the contacts list.

- 1 Press  to access the menu.

- 2 Press  or  to `Contacts`. Press  to select.

- 3 Press  or  to the required subscriber alias or ID, or group alias or ID. Press  to select.

- 4 Press  or  to `Send Status`. Press  to select.

- 5 Press  or  to the required status message. Press  to select.

If successful:

- A positive indicator tone sounds.

[Send Feedback](#)

- The LED turns off.
- The display shows a positive mini notice momentarily before returning to the `Quick Status` screen.
- The display shows  beside the sent status message.



If unsuccessful:



- A negative indicator tone sounds.
- The LED turns off.
- The display shows the failure notice momentarily before returning to the `Quick Status` screen.



Sending Status Message by Using Manual Dial

Follow the procedure to send a status message by using the manual dial.



- 1 Press  to access the menu.



- 2 Press  or  to `Contacts`. Press  to select.

3 Press  or  to Manual Dial. Press  to select.

4 Press  or  to Radio Number. Press  to select.

5 Enter the required subscriber alias or ID, or group alias or ID, and press  to proceed.

6 Press  or  to Send Status. Press  to select.

7 Press  or  to the required status message. Press  to select.

If successful:

- A positive indicator tone sounds.
- The LED turns off.
- The display shows a positive mini notice momentarily before returning to the Quick Status screen.
- The display shows  beside the sent status message.



If unsuccessful:

- A negative indicator tone sounds.
- The LED turns off.
- The display shows the failure notice momentarily before returning to the Quick Status screen.



Viewing Status Messages

Follow the procedure to view status messages.

1 Press  to access the menu.

2 Press  or  to Status. Press  to select.

3 Press  or  to Inbox. Press  to select.

4 Press  or  to the required status message.

Press  to select.



The content of the status message is displayed to the radio user.

Received status messages can also be viewed by accessing the Notification List. See [Notification List on page 180](#) for more information.



Responding to Status Messages

Follow the procedure to reply status messages.

1 Press  to access the menu.

2 Press  or  to Status. Press  to select.



3 Press  or  to Inbox. Press  to select.

4 Press  or  to the required status message.

Press  to select.

5 The content of the status is displayed. Press  to select.

6 Press  or  to Reply. Press  to select.

7 Press  or  to the required status message.

Press  to select.

If successful:

- A positive indicator tone sounds.
- The LED turns off.
- The display shows a positive mini notice before returning to the *Inbox* screen.
- The display shows  beside the sent status message.











If unsuccessful:

- A negative indicator tone sounds.
- The LED turns off.



- The display shows the failure notice momentarily before returning to the `Inbox` screen.

Deleting a Status Message

Follow the procedure to delete a status message from your radio.

- 1 Press  to access the menu.
- 2 Press  or  to `Status`. Press  to select.
- 3 Press  or  to `Inbox`. Press  to select.
- 4 Press  or  to the required status message. Press  to select.
- 5 The content of the status is displayed. Press  to select.











- 6 Press  or  to `Delete`. Press  to select.



- 7 Press  or  to `Yes`. Press  to select.

- The display shows a positive mini notice before returning to the `Inbox` screen.

Deleting All Status Messages

Follow the procedure to delete all status messages from your radio.

- 1 Press  to access the menu.
- 2 Press  or  to `Status`. Press  to select.
- 3 Press  or  to `Inbox`. Press  to select.
- 4 Press  or  to `Delete All`. Press  to select.

5 Press  or  to Yes. Press  to select.

- The display shows `List Empty`.

Text Messaging

Your radio is able to receive data, for example a text message, from another radio or a text message application.

There are two types of text messages, Digital Mobile Radio (DMR) Short Text Message and text message. The maximum length of a DMR Short Text Message is 23 characters. The maximum length of a text message is 280 characters, including the subject line. The subject line only appears when you receive messages from e-mail applications.



NOTICE:

The maximum character length is only applicable for models with the latest software and hardware. For radio models with older software and hardware, the maximum length of a text message is 140 characters. Check with your dealer or system administrator for more information.







Text Messages



The text messages are stored in an Inbox, and sorted according to the most recently received.

The radio exits the current screen once the inactivity timer expires. Long press  at any time to return to the Home screen.

Viewing Text Messages

Follow the procedure to view text messages on your radio.











- 1 Press  to access the menu.
- 2 Press  or  to Messages. Press  to select.
- 3 Press  or  to Inbox. Press  to select.
If the Inbox is empty:
 - The display shows `List Empty`.
 - A tone sounds, if the Keypad Tone is turned on.

- 4 Press  or  to the required message. Press  to select.

The display shows a subject line if the message is from an e-mail application.

Viewing Telemetry Status Text Messages

Follow the procedure to view a telemetry status text message from the inbox.

- 1 Press  to access the menu.
-
- 2 Press  or  to Messages. Press  to select.
-
- 3 Press  or  to Inbox. Press  to select.
-
- 4 Press  or  to the required message. Press  to select.

You cannot reply to a Telemetry Status text message.

The display shows Telemetry: <Status Text Message>.

- 5 Long press  to return to the Home screen.

Responding to Text Messages

Follow the procedure to respond to text messages on your radio.

When you receive a text message:









- The display shows the Notification list with the alias or ID of the sender.
- The display shows the **Message** icon.





NOTICE:

The radio exits the Text Message alert screen and sets up a Private or Group Call to the sender of the message if the **PTT** button is pressed.

- 1 Do one of the following:

- Press  or  to Read. Press  to select.
The display shows the text message. The display shows a subject line if the message is from an e-mail application.
- Press  or  to Read Later. Press  to select.
The radio returns to the screen you were on prior to receiving the text message.
- Press  or  to Delete. Press  to select.

2 Do one of the following:

- Press  to return to inbox.
 - Press  a second time to reply, forward, or delete the text message.
-

Responding to Text Messages with Quick Text

Follow the procedure to respond to text messages with Quick Text messages on your radio.

1 Do one of the following:

- Press the programmed **Text Message** button.
Proceed to Step 3.
- Press  to access the menu.



2 Press or to Messages. Press to select.



3 Press or to Inbox. Press to select.



4 Press or to the required message. Press to select.

The display shows a subject line if the message is from an e-mail application.

5 Press  to access the sub-menu.

6 Press  or  to Reply. Press  to select.

7 Press  or  to Quick Reply. Press  to select.

8 Press  or  to the required message. Press  to select.

The display shows a transitional mini notice, confirming the message is being sent.

9 Wait for acknowledgment.

If successful:

- A tone sounds.
- The display shows a positive mini notice.

If unsuccessful:

- A tone sounds.
- The display shows a negative mini notice.

- The radio returns to the Resend option screen.
-

Resending Text Messages

Follow the procedure to resend text messages on your radio.

When you are at the Resend option screen:

Press  to resend the same message to the same subscriber or group alias or ID.

If successful:

- A positive indicator tone sounds.
- The display shows a positive mini notice.



If unsuccessful:



- A negative indicator tone sounds.
 - The display shows a negative mini notice.
 - The radio returns to the Resend option screen.
-

Forwarding Text Messages

Follow the procedure to forward text messages on your radio.

When you are at the **Resend** option screen:

- 1 Press  or  to **Forward**, and press  to send the same message to another subscriber or group alias or ID.

- 2 Press  or  to the required alias or ID.
Press  to select.

The display shows a transitional mini notice, confirming your message is being sent.

- 3 Wait for acknowledgment.

If successful:

- A tone sounds.
- The display shows a positive mini notice.

If unsuccessful:

- A tone sounds.

- The display shows a negative mini notice.



NOTICE:



You can also manually select a target radio address (see [Forwarding Text Messages by Using the Manual Dial on page 407](#)).

Forwarding Text Messages by Using the Manual Dial

Follow the procedure to forward text messages by using the manual dial on your radio.

- 1 Press  or  to **Forward**. Press  to select.

- 2 Press  to send the same message to another subscriber or group alias or ID.

- 3 Press  or  to **Manual Dial**. Press  to select.

The display shows **Radio Number:.**

- 4 Enter the subscriber ID, and press  to proceed.
The display shows a transitional mini notice, confirming your message is being sent.
-

- 5 Wait for acknowledgment.

If successful:

- A tone sounds.
- The display shows a positive mini notice.

If unsuccessful:

- A tone sounds.
 - The display shows a negative mini notice.
-



Editing Text Messages

Select **Edit** to edit the message.









NOTICE:

If a subject line is present (for messages received from an e-mail application), you cannot edit it.







- 1 Press  or  to **Edit**. Press  to select.
The display shows a blinking cursor.
-

- 2 Use the keypad to edit your message.

- Press  to move one space to the left.
 - Press  or  to move one space to the right.
 - Press  to delete any unwanted characters.
 - Long press  to change text entry method.
-

- 3 Press  once message is composed.
-

- 4 Do one of the following:



- Press  or  to **Send** and press  to send the message.
- Press  or  to **Save** and press  to save the message to the Drafts folder.
- Press  to edit the message.



- Press  to choose between deleting the message or saving it to the Drafts folder.

Writing Text Messages

Follow the procedure to write text message on your radio.

- 1 Do one of the following:
 - Press the programmed **Text Message** button. Proceed to [step 3](#).
 - Press  to access the menu.

- 2 Press  or  to Messages. Press  to select.

- 3 Press  or  to Compose. Press  to select.

A blinking cursor appears.

- 4 Use the keypad to type your message.

Press  to move one space to the left.





Press  or  to move one space to the right.

Press  to delete any unwanted characters.

Long press  to change text entry method.

- 5 Press  once message is composed.

Do one of the following:







- Press  to send the message.
- Press . Press  or  to choose among editing, deleting, or saving the message. Press  to select.

Sending Text Messages

Follow the procedure to send text message on your radio.

It is assumed that you have a newly written text message or a saved text message.

Select the message recipient. Do one of the following:

- Press  or  to the required alias or ID. Press  to select.
- Press  or  to Manual Dial. Press  to select. Key in the subscriber ID. The first line of the display shows Radio Number:!. The second line of the display shows a blinking cursor. Key in the subscriber alias or ID. Press .

The display shows transitional mini notice, confirming your message is being sent.

If successful:

- A tone sounds.
- The display shows positive mini notice.

If unsuccessful:

- A low tone sounds.
- The display shows negative mini notice.
- The message is moved to the Sent Items folder.
- The message is marked with a Send Failed icon.



NOTICE:

For a newly written text message, the radio returns you to the Resend option screen.

Deleting Text Messages from the Inbox

Follow the procedure to delete text messages from the Inbox on your radio.

1 Do one of the following:



- Press the programmed **Text Message** button. Proceed to [step 3](#).
- Press  to access the menu.

2 Press or to Messages. Press to select.

3 Press or to Inbox. Press to select.

If the Inbox is empty:



- The display shows List Empty.
 - A tone sounds.
-

- 4 Press  or  to the required message. Press  to select.

The display shows a subject line if the message is from an e-mail application.

- 5 Press  to access the sub-menu.
-

- 6 Press  or  to Delete. Press  to select.
-

- 7 Press  or  to Yes. Press  to select.

The display shows a positive mini notice. The screen returns to the Inbox.



Deleting All Text Messages from the Inbox



Follow the procedure to delete all text messages from the Inbox on your radio.

- 1 Do one of the following:



- Press the programmed **Text Message** button. Proceed to [step 3](#).



- Press  to access the menu.
-

- 2 Press  or  to Messages. Press  to select.
-

- 3 Press  or  to Inbox. Press  to select. If the Inbox is empty:

- The display shows List Empty.
 - A tone sounds.
-

- 4 Press  or  to Delete All. Press  to select.
-

- 5 Press  or  to Yes. Press  to select. The display shows a positive mini notice.
-

Sent Text Messages

Once a message is sent to another radio, it is saved in Sent Items folder. The most recent sent text message is always added to the top of the Sent Items folder. You can resend, forward, edit, or delete a Sent text message.

The Sent Items folder is capable of storing a maximum of 30 last sent messages. When the folder is full, the next sent text message automatically replaces the oldest text message in the folder.

If you exit the message sending screen while the message is being sent, the radio updates the status of the message in the Sent Items folder without providing any indication in the display or via sound.

If the radio changes mode or powers down before the status of the message in Sent Items folder is updated, the radio cannot complete any In-Progress messages and automatically marks it with a **Send Failed** icon.

The radio supports a maximum of five In-Progress messages at one time. During this period, the radio cannot send any new message and automatically marks it with a **Send Failed** icon.

If you long press  at any time, the radio returns to the Home screen.







NOTICE:



If the channel type, for example a conventional digital or Capacity Plus channel, is not a match, you can only edit, forward, or delete a Sent message.

Viewing Sent Text Messages

Follow the procedure to view sent text messages on your radio.

- 1 Do one of the following:
 - Press the programmed **Text Message** button. Proceed to [step 3](#).
 - Press  to access the menu.



- 2 Press  or  to Messages. Press  to select.

- 3 Press  or  to Sent Items. Press  to select.

If the Sent Items folder is empty:

 - The display shows `List Empty`.

- A low tone sounds, if the Keypad Tone is turned on.



-
- 4 Press  or  to the required message. Press  to select.



The icon at the top right corner of the screen indicates the status of the message. See [Sent Item Icons](#).

Sending Sent Text Messages

Follow the procedure to send a sent text messages on your radio.

When you are viewing a Sent message:

- 1 Press  .
- 2 You can either resend or forward the sent text message. Do one of the following:
 -  to Resend. Press  to select.

-  to Forward. Press  to select.

The display shows a transitional mini notice, confirming your message is being sent.

- 3 Wait for acknowledgment.

If successful:

- A tone sounds.
- The display shows a positive mini notice.

If unsuccessful:

- A tone sounds.
 - The display shows a negative mini notice.
 - The radio proceeds to the Resend option screen. See [Resending Text Messages on page 146](#) for more information.
-

Deleting Sent Text Messages from the Sent Items Folder

Follow the procedure to delete sent text messages from the Sent Items folder on your radio.

When you are viewing a Sent message:



- 1 Press  .



- 2 Press  or  to Delete. Press  to select.

Deleting All Sent Text Messages from the Sent Items Folder

Follow the procedure to delete all sent text messages from the Sent Items folder on your radio.



- 1 Do one of the following:
 - Press the programmed **Text Message** button. Proceed to [step 3](#).
 - Press  to access the menu.







- 2 Press  or  to Messages. Press  to select.

- 3 Press  or  to Sent Items. Press  to select.

If the Sent Items folder is empty:

- The display shows List Empty.
- A tone sounds.

- 4 Press  or  to Delete All. Press  to select.

- 5 Do one of the following:
 - Press  or  to Yes. Press  to select.
The display shows a positive mini notice.
 - Press  or  to No. Press  to select.
The radio returns to the previous screen.

Saved Text Messages

You can save a text message to send it at a later time.

If a **PTT** button press or a mode change causes the radio to exit the text message writing/editing screen while you are in the process of writing or editing a text message, your current text message is automatically saved to the Drafts folder.



The most recent saved text message is always added to the top of the Drafts list.

The Drafts folder stores a maximum of 10 last saved messages. When the folder is full, the next saved text message automatically replaces the oldest text message in the folder.



Viewing Saved Text Messages

Follow the procedure to view saved text message on your radio.

- 1 Do one of the following:
 - Press the programmed **Text Message** button. Proceed to [step 3](#).
 - Press  to access the menu.





- 2 Press  or  to Messages. Press  to select.

- 3 Press  or  to Drafts. Press  to select.

- 4 Press  or  to the required message. Press  to select.

Editing Saved Text Messages

Follow the procedure to edit saved text message on your radio.

- 1 Press  while viewing the message.
- 2 Press  or  to Edit. Press  to select. A blinking cursor appears.
- 3 Use the keypad to type your message.

Press  to move one space to the left.







Press  or  to move one space to the right.

Press  to delete any unwanted characters.

Long press  to change text entry method.

4 Press  once message is composed.

Do one of the following:

- Press  or  to Send. Press  to send the message.
- Press . Press  or  to choose between saving or deleting the message. Press  to select.

Deleting Saved Text Messages from the Drafts Folder



Follow the procedure to delete saved text message from drafts on your radio.



1 Do one of the following:

- Press the programmed **Text Message** button. Proceed to [step 3](#).
- Press  to access the menu.

2 Press  or  to Messages. Press  to select.

3 Press  or  to Drafts. Press  to select.

4 Press  or  to the required message. Press  to select.

5 Press  or  to Delete. Press  to delete the text message.





Quick Text Messages



Your radio supports a maximum of 50 Quick Text messages as programmed by your dealer.



While Quick Text messages are predefined, you can edit each message before sending it.

Sending Quick Text Messages

Follow the procedure to send predefined Quick Text messages on your radio to a predefined alias.

- 1 Do one of the following:
 - Press the programmed **Text Message** button. Proceed to [step 3](#).
 - Press the programmed **One Touch Access** button. Proceed to [step 6](#).
The display shows a transitional mini notice, confirming your message is being sent.
 - Press  to access the menu.
-
- 2 Press  or  to Messages. Press  to select.
-

- 3 Press  or  to Quick Text. Press  to select.
-

- 4 Press  or  to the required Quick Text message. Press  to select.
-

- 5 Do the following to select the recipient and send the message.

The display shows a transitional mini notice, confirming that your message is being sent.

- 6 Wait for acknowledgment.

If successful:

- A positive indicator tone sounds.
- The display shows a positive mini notice.

If unsuccessful:

- A negative indicator tone sounds.
- The display shows a negative mini notice.

- The radio proceeds to the **Resend** option screen. See [Resending Text Messages on page 146](#) for more information.

Text Entry Configuration

Your radio allows you to configure different text.

You can configure the following settings for entering text on your radio:



- Word Predict
- Word Correct
- Sentence Cap
- My Words

Your radio supports the following text entry methods:

- Numbers
- Symbols
- Predictive or Multi-Tap
- Language (If programmed)















NOTICE:

Press  at any time to return to the previous screen or long press  to return to the Home Screen. The radio exits the current screen once the inactivity timer expires.



Enabling or Disabling Word Correct

Supplies alternative word choices when the word entered into the text editor is not recognized by the in-built dictionary.

- 1 Press  to access the menu.
- 2 Press  or  to Utilities. Press  to select.
- 3 Press  or  to Radio Settings. Press  to select.
- 4 Press  or  to Text Entry. Press  to select.

5 Press  or  to Word Correct. Press  to select.



6 Do one of the following:

- Press  or  to Word Correct. Press  to select.
 - Press to enable Word Correct. If enabled, ✓ appears beside Enabled.
 - Press to disable Word Correct. If disabled, ✓ disappears beside Enabled.
-



Enabling or Disabling Word Predict



Word Predict: Your radio can learn common word sequences that you often enter. It then predicts the next word you may want to use after you enter the first word of a common word sequence into the text editor.

1 Press  to access the menu.



2 Press  or  to Utilities. Press  to select.

3 Press  or  to Radio Settings. Press  to select.

4 Press  or  to Text Entry. Press  to select.

5 Press  or  to Word Predict. Press  to select.



6 Do one of the following:



- Press  to enable the Word Predict. If enabled, ✓ appears beside Enabled.
 - Press  to disable Microphone Dynamic Distortion Control. If disabled, ✓ disappears beside Enabled.
-



Sentence Cap



This feature is used to automatically enable capitalization of the first letter in the first word for every new sentence.

- 1 Press  **OK** to access the menu.



- 2 Press  or  to Utilities. Press  **OK** to select.

- 3 Press  or  to Radio Settings. Press  **OK** to select.

- 4 Press  or  to Text Entry. Press  **OK** to select.

- 5 Press  or  to Sentence Cap. Press  **OK** to select.



- 6 Do one of the following:



- Press  **OK** to enable Sentence Cap. If enabled, ✓ appears beside Enabled.
- Press  **OK** to disable Sentence Cap. If disabled, ✓ disappears beside Enabled.



Viewing Custom Words



You can add your own custom words into the in-built dictionary of your radio. Your radio maintains a list to contain these words.



- 1 Press  **OK** to access the menu.

- 2 Press  or  to Utilities. Press  **OK** to select.

- 3 Press  or  to Radio Settings. Press  **OK** to select.

4 Press  or  to Text Entry. Press  to select.



5 Press  or  to My Words. Press  to select.



6 Press  or  to List of Words. Press  to select.
The display shows the list of custom words.



Editing Custom Words



You can edit custom words saved in your radio.



1 Press  to access the menu.



2 Press  or  to Utilities. Press  to select.

3 Press  or  to Radio Settings. Press  to select.

4 Press  or  to Text Entry. Press  to select.





5 Press  or  to My Words. Press  to select.

6 Press  or  to List of Words. Press  to select.
Display shows the list of custom words.

7 Press  or  to the required word. Press  to select.

8 Press  or  to Edit. Press  to select.

9 Use the keypad to edit your custom word.

- Press  to move one space to the left.
- Press  key to move one space to the right.
- Press the  key to delete any unwanted characters.
- Long press  to change text entry method.

10 Press  once your custom word is completed.



The display shows transitional mini notice, confirming your custom word is being saved.

- If the custom word is saved, a tone sounds and the display shows positive mini notice.
- If the custom word is not saved, a low tone sounds and the display show negative mini notice.



Adding Custom Words



You can add custom words into the in-built radio dictionary.



1 Press  to access the menu.

2 Press  or  to Utilities. Press  to select.



3 Press  or  to Radio Settings. Press  to select.



4 Press  or  to Text Entry. Press  to select.

5 Press  or  to My Words. Press  to select.

6 Press  or  to Add New Word. Press  to select.
Display shows the list of custom words.

7 Use the keypad to edit your custom word.

- Press  to move one space to the left.
- Press  key to move one space to the right.

- Press the  key to delete any unwanted characters.
- Long press  to change text entry method.

8 Press  once your custom word is completed.



The display shows transitional mini notice, confirming your custom word is being saved.



- If the custom word is saved, a tone sounds and the display show positive mini notice.
- If the custom word is not saved, a low tone sounds and the display show negative mini notice.



Deleting a Custom Word



Follow the procedure to delete the custom words saved in your radio.



1 Press  to access the menu.

2 Press  or  to Utilities. Press  to select.

3 Press  or  to Radio Settings. Press  to select.





4 Press  or  to Text Entry. Press  to select.

5 Press  or  to My Words. Press  to select.

6 Press  or  to the required word. Press  to select.

7 Press  or  to Delete. Press  to select.



8 Choose one of the following.



- At Delete Entry?, press  to select Yes. The display shows Entry Deleted.
- Press  or  to No. Press  to return to the previous screen.



Deleting All Custom Words



Follow the procedure to delete all custom words from the in-built dictionary of your radio.



- 1 Press  to access the menu.

- 2 Press  or  to Utilities. Press  to select.





- 3 Press  or  to Radio Settings. Press  to select.

- 4 Press  or  to Text Entry. Press  to select.

- 5 Press  or  to My Words. Press  to select.

- 6 Press  or  to Delete All. Press  to select.

7 Do one of the following:

- At Delete Entry?, press  to select Yes. The display shows All Entries Deleted.
 - Press  or  to No to return to the previous screen. Press  to select.
-

Job Tickets

This feature allows your radio to receive messages from the dispatcher listing out tasks to perform.



NOTICE:

This feature can be customized through CPS according to user requirements. Check with your dealer or system administrator for more information.

There are two folders that contain different Job Tickets:

My Tasks folder

Personalized Job Tickets assigned to your signed in user ID.

Shared Tasks folder

Shared Job Tickets assigned to a group of individuals.

You can respond to Job Tickets in order to sort them into Job Ticket Folders. By default, the folders are **All**, **New**, **Started**, and **Completed**. Check with your dealer or system administrator for an additional 10 folders.



NOTICE:

Job Tickets are retained even after the radio is powered down and powered up again.

All Job Tickets are located in the **All** folder. Depending on how your radio is programmed, Job Tickets are sort by their priority level followed by time received. New Job Tickets, Job Tickets with recent changes in state, and Job Tickets with the highest priority are listed first. Upon reaching the maximum number of Job Tickets, the next Job Ticket automatically replaces the last Job Ticket in your radio. Your radio supports a maximum of 100 or 500 Job Tickets, depending on your radio model. Check with your dealer or system administrator for more information. Your radio automatically detects and discards duplicated Job Tickets with the same Job Ticket ID.

Depending on the importance of the Job Tickets, the dispatcher adds a Priority Level to them. There are three priority levels: Priority 1, Priority 2, and Priority 3. Priority 1 has the highest priority and Priority 3 has the lowest priority. There are also Job Tickets with no priority.



Your radio updates accordingly when dispatcher makes the following changes:



- Modify content of Job Tickets.
- Add or edit Priority Level of Job Tickets.
- Move Job Tickets from folder to folder.
- Canceling of Job Tickets.



Accessing the Job Ticket Folder

Follow the procedure to access the Job Ticket folder.

- 1 Do one of the following:
 - Press the programmed **Job Ticket** button. Proceed to [step 3](#).
 - Press  to access the menu.





- 2 Press  or  to Job Tickets. Press  to select.

- 3 Press  or  to the required folder. Press  to select.

- 4 Press  or  to the required Job Ticket.
Press  to select.
-

Logging In or Out of the Remote Server

This feature allows you to log in and log out of the remote server by using your user ID.

- 1 Press  to access the menu.
-
- 2 Press  or  to Log In. Press  to select.
If you are already logged in, menu displays Log Out.
The display shows a transitional mini notice, indicating the request is in progress.
-

- 3 Wait for acknowledgment.
If successful:
- A positive indicator tone sounds.
 - The display shows a positive mini notice.







If unsuccessful:

- A negative indicator tone sounds.
 - The display shows a negative mini notice.
-

Creating Job Tickets

Your radio is able to create Job Tickets, which are based on a Job Ticket template and send out tasks that need to be performed.



CPS programming software is required to configure the Job Ticket template.



- 1 Press  to access the menu.
-
- 2 Press  or  to Job Tickets. Press  to select.
-
- 3 Press  or  to Create Ticket. Press  to select.
-



Responding to Job Tickets

Follow the procedure to respond to job tickets on your radio.



- 1 Press  to access the menu.

- 2 Press  or  to Job Tickets. Press  to select.

- 3 Press  or  to the required folder. Press  to select.

- 4 Press  or  to the required job ticket. Press  to select.

- 5 Press  once more to access the sub-menu.
You can also press the corresponding number key (1–9) to **Quick Reply**.

- 6 Press  or  to the required job ticket. Press  to select.

The display shows a transitional mini notice, indicating the request is in progress.

- 7 Wait for acknowledgment.

If successful:

- A positive indicator tone sounds.
- The display shows a positive mini notice.

If unsuccessful:

- A negative indicator tone sounds.
- The display shows a negative mini notice.



Sending Job Tickets Using One Job Ticket Template

If your radio is configured with one Job Ticket template, perform the following actions to send the Job Ticket.

- 1 Use the keypad to type the required room number.

Press  to select.

- 2 Press  or  to Room Status. Press  to select.
-

- 3 Press  or  to the required option. Press  to select.
-

- 4 Press  or  to Send. Press  to select.

The display shows a transitional mini notice, indicating the request is in progress.

- 5 Wait for acknowledgment.

If successful:



- A positive indicator tone sounds.
- The display shows a positive mini notice.

If unsuccessful:

- A negative indicator tone sounds.
 - The display shows a negative mini notice.
-

Sending Job Tickets Using More Than One Job Ticket Template

If your radio is configured with more than one Job Ticket template, perform the following actions to send the Job Tickets.

- 1 Press  or  to the required option. Press  to select.
-

- 2 Press  or  to Send. Press  to select.

The display shows a transitional mini notice, indicating the request is in progress.

3 Wait for acknowledgment.

If successful:

- A positive indicator tone sounds.
- The display shows a positive mini notice.

If unsuccessful:

- A negative indicator tone sounds.
 - The display shows a negative mini notice.
-

Deleting Job Tickets

Follow the procedure to delete job tickets on your radio.

1 Do one of the following:

- Press the programmed **Job Ticket** button. Proceed to [step 4](#)
 - Press  to access the menu.
-

2 Press or to Job Tickets. Press to select.

3 Press or to the required folder. Press to select.

4 Press or to All folder. Press to select.

5 Press or to the required Job Ticket. Press to select.

6 Press again while viewing the Job Ticket.

7 Press or to Delete. Press to select.

The display shows a transitional mini notice, indicating the request is in progress.

8 Wait for acknowledgment.

If successful:

- A positive indicator tone sounds.
- The display shows a positive mini notice.

If unsuccessful:

- A negative indicator tone sounds.
 - The display shows a negative mini notice.
-



Deleting All Job Tickets



Follow the procedure to delete all job tickets on your radio.



1 Do one of the following:

- Press the programmed **Job Ticket** button. Proceed to [step 3](#).
 - Press  to access the menu.
-







2 Press  or  to Job Tickets. Press  to select.

3 Press  or  to the required folder. Press  to select.

4 Press  or  to All folder. Press  to select.

5 Press  or  to Delete All. Press  to select.

6 Do one of the following:

- Press  or  to Yes. Press  to select.
The display shows a positive mini notice.
 - Press  or  to No. Press  to select.
The radio returns to the previous screen.
-

Privacy

This feature helps to prevent eavesdropping by unauthorized users on a channel by the use of a software-based scrambling solution. The signaling and user identification portions of a transmission are not scrambled.

Your radio must have privacy enabled on the channel to send a privacy-enabled transmission, although this is not a necessary requirement for receiving a transmission. While

on a privacy-enabled channel, the radio is still able to receive clear or unscrambled transmissions.

Your radio only supports Enhanced Privacy. To unscramble a privacy-enabled call or data transmission, your radio must be programmed to have the same Key Value and Key ID for Enhanced Privacy as the transmitting radio.

If your radio receives a scrambled call that is of a different Key Value and Key ID, you hear nothing at all for Enhanced Privacy.

On a privacy-enabled channel, your radio is able to receive clear or unscrambled calls, depending on how your radio is programmed. In addition, your radio may play a warning tone or not, depending on how it is programmed.



NOTICE:

This feature is not applicable in Citizens Band channels that are in the same frequency.

The green LED lights up when the radio is transmitting, and blinks rapidly when the radio is receiving an ongoing privacy-enabled transmission.







NOTICE:



Some radio models may not offer this Privacy feature, or may have a different configuration. Check with your dealer or system administrator for more information.



Turning Privacy On or Off





Follow the procedure to turn privacy on or off on your radio.





- 1 Do one of the following:
 - Press the programmed **Privacy** button. Skip the steps below.
 - Press  to access the menu.

- 2 Press  or  to Utilities. Press  to select.

- 3 Press  or  to Radio Settings. Press  to select.

- 4 Press  or  to Privacy. Press  to select.

- 5 Do one of the following:
 - Press  or  to On. Press  to select. The display shows  beside On.

- Press  or  to Off. Press  to select. The display shows  beside Off.
-

Stun/Revive

This feature allows you to enable or disable any radio in the system. For example, the dealer or system administrator may want to disable a stolen radio to prevent unauthorized users from using it, and enable the radio when it is recovered.

A radio can be disabled (stunned) or enabled (revived) either through the console or through a command initiated by another radio.

Once a radio is disabled, the radio sounds a negative indicator tone and the home screen shows Channel Denied.

When a radio is stunned, the radio cannot request nor receive any user initiated services on the system that performed the Stun procedure. However, the radio can switch to another system. The radio continues to send GNSS location reports and can be monitored remotely when it was stunned.





NOTICE:

The dealer or system administrator may permanently disable a radio. See [Radio Kill on page 177](#) for more information.

Stunning a Radio

Follow the procedure to disable a radio.

- 1 Press the programmed **Radio Disable** button.
-

- 2 Press  or  to the required alias or ID.
Press  to select.

The display shows a transitional mini notice, indicating the request is in progress. The green LED blinks.

- 3 Wait for acknowledgment.

If successful:

- A positive indicator tone sounds.
- The display shows a positive mini notice.



If unsuccessful:



- A negative indicator tone sounds.
 - The display shows a negative mini notice.
-



Stunning a Radio by Using the Contacts List

Follow the procedure to disable a radio by using the Contacts List.

- 1 Press  to access the menu.

- 2 Press  or  to `Contacts`. Press  to select.

- 3 Press  or  to the required alias or ID.
Press  to select.

- 4 Press  or  to `Radio Disable`. Press  to select.

The display shows a transitional mini notice, indicating the request is in progress. The green LED blinks.

- 5 Wait for acknowledgment.

If successful:

- A positive indicator tone sounds.
- The display shows a positive mini notice.



If unsuccessful:



- A negative indicator tone sounds.
 - The display shows a negative mini notice.
-



Stunning a Radio by Using the Manual Dial

Follow the procedure to disable a radio by using the manual dial.



- 1 Press  to access the menu.

- 2 Press  or  to Contacts. Press  to select.

- 3 Press  or  to Manual Dial. Press  to select.

- 4 Press  or  to Radio Number. Press  to select.
The first text line shows Radio Number:.

- 5 Enter the subscriber ID, and press  to proceed.

- 6 Press  or  to Radio Disable. Press  to select.

The display shows a transitional mini notice, indicating the request is in progress. The green LED blinks.

- 7 Wait for acknowledgment.

If successful:

- A positive indicator tone sounds.
- The display shows a positive mini notice.



If unsuccessful:

- A negative indicator tone sounds.
- The display shows a negative mini notice.

Reviving a Radio

Follow the procedure to enable a radio.

- 1 Press the programmed **Radio Enable** button.

2 Press  or  to the required alias or ID.

Press  to select.

The display shows `Radio Enable` and the subscriber alias or ID. The green LED lights up.

3 Wait for acknowledgment.

If successful:

- A positive indicator tone sounds.
- The display shows a positive mini notice.



If unsuccessful:



- A negative indicator tone sounds.
 - The display shows a negative mini notice.
-



Reviving a Radio by Using the Contacts List

Follow the procedure to enable a radio by using the Contacts List.

1 Press  to access the menu.

2 Press  or  to `Contacts`. Press  to select.

3 Press  or  to the required alias or ID.
Press  to select.

4 Press  or  to `Radio Enable`. Press  to select.

The green LED blinks.

The display shows `Radio Enable` and the subscriber alias or ID. The green LED lights up.

5 Wait for acknowledgment.

If successful:

- A tone sounds.
- The display shows `Radio Enable Successful`.

If unsuccessful:



- A tone sounds.



- The display shows Radio Enable Failed.



Reviving a Radio by Using the Manual Dial

Follow the procedure to enable a radio by using the Manual Dial.

1 Press  to access the menu.



2 Press  or  to Contacts. Press  to select.

3 Press  or  to Manual Dial. Press  to select.

4 Press  or  to Private Call. Press  to select.

The first text line shows Radio Number:.

5 Enter the subscriber ID, and press  to proceed.

6 Press  or  to Radio Enable. Press  to select.

The green LED blinks.

The display shows Radio Enable and the subscriber alias or ID. The green LED lights up.

7 Wait for acknowledgment.

If successful:

- A tone sounds.
- The display shows Radio Enable Successful.

If unsuccessful:

- A tone sounds.
 - The display shows Radio Enable Failed.
-

Radio Kill

This feature is an enhanced security measure to restrict unauthorized access to a radio.

Radio Kill causes a radio to be rendered inoperable. For example, the dealer or system administrator may want to kill a stolen or misplaced radio to prevent unauthorized usage.

When powered on, a killed radio displays `Radio Killed` on the screen momentarily to indicate the killed state.



NOTICE:

A killed radio can only be revived at a Motorola Solutions service depot. Check with your dealer or system administrator for more information.

Lone Worker

This feature prompts an emergency to be raised if there is no user activity, such as any radio button press or activation of the channel selector, for a predefined time.

Following no user activity for a programmed duration, the radio pre-warns you using an audio indicator once the inactivity timer expires.

If there is still no acknowledgment by you before the predefined reminder timer expires, the radio initiates an emergency condition as programmed by the dealer or system administrator.

See [Emergency Operation on page 129](#) for more information.



NOTICE:

Check with your dealer or system administrator for more information.

Password Lock Features

This feature allows you to restrict access to the radio by asking for a password when the device is turned on.

You can use a keypad microphone or **Scroll Up/Down** buttons to enter the password.



Accessing Radios by Using Passwords

Follow the procedure to access your radio by using a password.

- 1 Enter the current four-digit password.

**NOTICE:**

The use of **Emergency** footswitch cancels out password input to access the radio.

- Use a keypad microphone.
- Press  or  to edit the numeric value of each digit, and press  to enter and move to the next digit.

2 Press  to enter the password.

If successful, the radio powers up.

If unsuccessful:

- After the first and second attempt, the display shows `Wrong Password`. Repeat [step 1](#).
- After the third attempt, the display shows `Wrong Password` and then, `Radio Locked`. A tone sounds. The yellow LED double blinks. Your radio enters into locked state for 15 minutes.

**NOTICE:**

In locked state, your radio responds to inputs from the **On/Off/Volume Control Knob** and programmed **Backlight** button only.

Unlocking Radios in Locked State

Your radio is unable to receive calls in locked state. Follow the procedure to unlock your radio in locked state.

Do one of the following:



- If the radio is powered on, wait for 15 minutes and then repeat the steps in [Accessing Radios by Using Passwords on page 177](#) to access the radio.
- If the radio is powered off, power up the radio. Your radio restarts the 15-minute timer for locked state. A tone sounds. The yellow LED double blinks. The display shows `Radio Locked`.



Wait for 15 minutes and then repeat the steps in [Accessing Radios by Using Passwords on page 177](#) to access the radio.



Turning Password Lock On or Off

Follow the procedure to turn password lock on or off on your radio.



-
- 1 Press  to access the menu.

2 Press  or  to Utilities. Press  to select.

3 Press  or  to Radio Settings. Press  to select.

4 Press  or  to Passwd Lock. Press  to select.









5 Enter the current four-digit password.

- Use a keypad microphone.
 - Press  or  to edit the numeric value of each digit, and press  to enter and move to the next digit.
A positive indicator tone sounds for every digit pressed.
-

6 Press  to enter the password.

If the password is incorrect, the display shows Wrong Password and automatically returns to the previous menu.



7 Do one of the following:



- Press  or  to Turn On. Press  to select.
The display shows  beside Turn On.
 - Press  or  to Turn Off. Press  to select.
The display shows  beside Turn Off.
-



Changing Passwords

Follow the procedure to change passwords on your radio.



1 Press  to access the menu.

2 Press  or  to Utilities. Press  to select.

- 3 Press  or  to Radio Settings. Press  to select.

- 4 Press  or  to Passwd Lock. Press  to select.

- 5 Enter the current four-digit password, and press  to proceed.
If the password is incorrect, the display shows Wrong Password and automatically returns to the previous menu.

- 6 Press  or  to Change PWD. Press  to select.

- 7 Enter a new four-digit password, and press  to proceed.

- 8 Re-enter the new four-digit password, and press  to proceed.
If successful, the display shows Password Changed.

If unsuccessful, the display shows Passwords Do Not Match.

The screen automatically returns to the previous menu.

Notification List

Your radio has a Notification list that collects all your unread events on the channel, such as unread text messages, telemetry messages, missed calls, and call alerts.

The display shows the **Notification** icon when the Notification list has one or more events.



The list supports a maximum of 40 unread events. When the list is full, the next event automatically replaces the oldest event. After the events are read, they are removed from the Notification list.



For text messages, missed calls, and call alert events, the maximum number of notifications are 30 text messages and 10 missed calls or call alerts. This maximum number depends on individual feature (job tickets or text messages or missed calls or call alerts) list capability.

Accessing Notification List

Follow the procedure to access the Notification list on your radio.

- 1 Press  to access the menu.

- 2 Press  or  to Notification. Press  to select.

- 3 Press  or  to the required event. Press  to select.

Long press  to return to the Home screen.

Over-the-Air Programming

Your dealer can remotely update your radio by using Over-the-Air Programming (OTAP) without physical connection. Additionally, some settings can also be configured by using OTAP.

When your radio undergoes OTAP, the green LED blinks.

When your radio receives high volume data:

- The display shows the **High Volume Data** icon.
- The channel becomes busy.
- A negative tone sounds if you press the **PTT** button.

When OTAP completes, depending on the configuration:

- A tone sounds. The display shows **Updating Restarting**. Your radio restarts by powering off and on again.
- You can select **Restart Now** or **Postpone**. When you select **Postpone**, your radio returns to the previous screen. The display shows the **OTAP Delay Timer** icon until the automatic restart occurs.

When your radio powers up after automatic restart:

- If successful, the display shows **Sw Update Completed**.
- If unsuccessful, the display shows **Sw Update Failed**.



See [Checking Software Update Information on page 209](#) for the updated software version.

Selecting Third-Party Peripherals Connection Modes



Follow the procedure to select one of the following third-party peripherals connection modes:



- Motorola Solutions
- PC and Audio
- Data Accessory
- Telemetry
- Generic

1 Press  to access the menu.

2 Press  or  to Utilities. Press  to select.

3 Press  or  to Radio Settings. Press  to select.

4 Press  or  to Cable Type. Press  to select.

5 Press  or  to the required connection mode. Press  to select.

The display shows the selected connection mode.
The screen returns to the previous menu.

Received Signal Strength Indicator



This feature allows you to view the Received Signal Strength Indicator (RSSI) values.

The display shows the **RSSI** icon at the top right corner. See [Display Icons](#) for more information on the **RSSI** icon.

Viewing RSSI Values

Follow the procedure to view RSSI values on your radio.

When you are at the Home screen:

1 Press  three times and immediately press  three times, all in 5 seconds.

The display shows the current RSSI values.

- 2 Long press  to return to the Home screen.
-



Front Panel Configuration



You are able to customize certain feature parameters in Front Panel Configuration (FPC) to enhance the use of your radio.

Entering Front Panel Configuration Mode

Follow the procedure to enter front panel programming mode on your radio.





Long press  at any time to return to the Home screen.

- 1 Press  to access the menu.
-
- 2 Press  or  to Utilities. Press  to select.
-

- 3 Press  or  to Program Radio. Press  to select.
-

Editing FPC Mode Parameters

Use the following buttons as required while navigating through the feature parameters.

-  ,  – Scroll through options, increase/decrease values, or navigate vertically.
-  – Select the option or enter a sub-menu.
-  – Short-press to return to previous menu or to exit the selection screen. Long-press to return to Home screen.

Wi-Fi Operation

This feature allows you to set up and connect to a Wi-Fi network. Wi-Fi supports updates for radio firmware,

codeplug, and resources such as language packs and voice announcement.



NOTICE:

This feature is applicable to XPR 5550e/XPR 5580e only.

Wi-Fi® is a registered trademark of Wi-Fi Alliance®.

Your radio supports WEP/WPA/WPA2-Personal and WPA/WPA2-Enterprise Wi-Fi networks.

WEP/WPA/WPA2-Personal Wi-Fi network

Uses pre-shared key (password) based authentication.

Pre-shared key can be entered by using the menu or CPS/RM.

WPA/WPA2-Enterprise Wi-Fi network

Uses certificate-based authentication.

Your radio must be pre-configured with a certificate.



NOTICE:







Check with your dealer or system administrator to connect to WPA/WPA2-Enterprise Wi-Fi network.

Turning Wi-Fi On or Off



The programmed **Wi-Fi On or Off** button is assigned by default. Check with your dealer or system administrator to determine how your radio has been programmed.

Voice Announcements for the programmed **Wi-Fi On or Off** button can be customized through CPS according to user requirements. Check with your dealer or system administrator for more information.

You can turn on or turn off Wi-Fi by performing one of the following actions.

- Press the programmed **Wi-Fi On or Off** button. Voice Announcement sounds Turning On Wi-Fi or Turning Off Wi-Fi.
- Access this feature using the menu.
 - a. Press  to access the menu.
 - b. Press  or  to `wiFi` and press  to select.
 - c. Press  or  to `wiFi On` and press  to select.

Press  to turn on Wi-Fi. The display shows  beside `Enabled`.

Press  to turn off Wi-Fi. The  disappears from beside `Enabled`.

Connecting to a Network Access Point

When you turn on Wi-Fi, the radio scans and connects to a network access point.







NOTICE:



You can also connect to a network access point using the menu.

The WPA-Enterprise Wi-Fi network access points are pre-configured. Check with your dealer or system administrator to determine how your radio has been programmed.

- 1 Press  to access the menu.

- 2 Press  or  to `WiFi` and press  to select.



- 3 Press  or  to `Networks` and press  to select.

- 4 Press  or  to a network access point and press  to select.



NOTICE:

For WPA-Enterprise Wi-Fi, if a network access point is not preconfigured, the `Connect` option is not available.

- 5 Press  or  to `Connect` and press  to select.

- 6 For WPA-Personal Wi-Fi, enter the password and press  .

- 7 For WPA-Enterprise Wi-Fi, password is configured by using RM.

If the preconfigured password is correct, your radio automatically connects to the selected network access point.

If the preconfigured password is incorrect, the display shows `Authentication Failure`, and automatically returns to the previous menu.

If the connection is successful, the radio displays a notice and the network access point is saved into the profile list.

If the connection is unsuccessful, the radio displays shows the failure notice screen momentarily and automatically returns to the previous menu.

Checking Wi-Fi Connection Status

Follow the procedure to check the Wi-Fi Connection status.

Press the programmed **Wi-Fi Status Query** button for the connection status by using Voice Announcement. Voice Announcement sounds `Wi-Fi is Off`, `Wi-Fi is On but No Connection`, or `Wi-Fi is On with Connection`.

- The display shows `WiFi Off` when the Wi-Fi is turned off.
- The display shows `WiFi On, Connected` when the radio is connected to a network.

- The display shows `WiFi On, Disconnected` when the Wi-Fi is turned on but the radio is not connected to any network.

Voice Announcements for the Wi-Fi status query results can be customized through CPS according to user requirements. Check with your dealer or system administrator for more information.









NOTICE:

The programmed **Wi-Fi Status Query** button is assigned by default. Check with your dealer or system administrator to determine how your radio has been programmed.

Refreshing the Network List



Follow the procedure to refresh the network list.

- Perform the following actions to refresh the network list through the menu.
 - a. Press  to access the menu.
 - b. Press  or  to `WiFi` and press  to select.

- c. Press  or  to `Networks` and press  to select.

When you enter the `Networks` menu, the radio automatically refreshes the network list.

- If you are already in the `Networks` menu, perform the following action to refresh the network list.

Press  or  to `Refresh` and press  to select.

The radio refreshes and displays the latest network list.

Adding a Network





NOTICE:



This task is not applicable to WPA-Enterprise Wi-Fi networks.

If a preferred network is not in the available network list, perform the following actions to add a network.

- 1 Press  to access the menu.
-

- 2 Press  or  to `WiFi` and press  to select.
-

- 3 Press  or  to `Networks` and press  to select.
-

- 4 Press  or  to `Add Network` and press  to select.
-

- 5 Enter the Service Set Identifier (SSID) and press  .
-

- 6 Press  or  to `Open` and press  to select.
-



- 7 Enter the password and press  .



The radio displays a positive mini notice to indicate that the network is successfully saved.



Viewing Details of Network Access Points



You can view details of network access points.

- 1 Press  to access the menu.

- 2 Press  or  to WiFi and press  to select.

- 3 Press  or  to Networks and press  to select.

- 4 Press  or  to a network access point and press  to select.

- 5 Press  or  to View Details and press  to select.



NOTICE:

WPA-Personal Wi-Fi and WPA-Enterprise Wi-Fi display different details of Network Access Points.

WPA-Personal Wi-Fi

For a connected network access point, your radio displays Service Set Identifier (SSID), Security Mode, Media Access Control (MAC) address, and Internet Protocol (IP) address.

For a non-connected network access point, your radio displays SSID and Security Mode.

WPA-Enterprise Wi-Fi

For a connected network access point, your radio displays SSID, Security Mode, Identity, Extended Authentication Protocol (EAP) Method, Phase 2 Authentication, Cert Name, MAC address, IP address, Gateway, DNS1, and DNS2.

For a non-connected network access point, your radio displays SSID, Security Mode, Identity, EAP Method, Phase 2 Authentication, and Cert Name.

Removing Network Access Points









NOTICE:



This task is not applicable to Enterprise Wi-Fi networks.



Perform the following actions to remove network access points from the profile list.

- 1 Press  to access the menu.

- 2 Press  or  to Wi-Fi and press  to select.

- 3 Press  or  to Networks and press  to select.

- 4 Press  or  to the selected network access point and press  to select.

- 5 Press  or  to Remove and press  to select.

- 6 Press  or  to Yes and press  to select.

The radio displays a positive mini notice to indicate that the selected network access point is successfully removed.

Utilities

This chapter explains the operations of the utility functions available in your radio.

Power Levels

You can customize the power setting to high or low for each channel.

High

This enables communication with radios located at a considerable distance from you.

Low

This enables communication with radios in closer proximity.



**NOTICE:**



This feature is not applicable in Citizens Band channels that are in the same frequency.

Setting Power Levels

Follow the procedure to set the power levels on your radio.









- 1 Do one of the following:
 - Press the programmed **Power Level** button. Skip the steps below.
 - Press  to access the menu.

- 2 Press  or  to Utilities. Press  to select.

- 3 Press  or  to Radio Settings. Press  to select.

- 4 Press  or  to Power. Press  to select.

- 5 Do one of the following:



- Press  or  to High. Press  to select.
The display shows  beside High.
- Press  or  to Low. Press  to select.
The display shows  beside Low.



- 6 Long press  to return to the Home screen.



Turning Radio Tones/Alerts On or Off



You can enable and disable all radio tones and alerts, if needed, except for incoming Emergency alert tone . Follow the procedure to turn tones and alerts on or off on your radio.

- 1 Do one of the following:
 - Press the programmed **Tones/Alerts** button. Skip the following steps.
 - Press  to access the menu.



2 Press  or  to Utilities. Press  to select.

3 Press  or  to Radio Settings. Press  to select.

4 Press  or  to Tones/Alerts. Press  to select.

5 Press  or  to All Tones. Press  to select.



6 Press  to enable or disable all tones and alerts. The display shows one of the following results:



- If enabled,  appears beside Enabled.
 - If disabled,  disappears beside Enabled.
-



Turning Keypad Tones On or Off



Follow the procedure to turn keypad tones on or off on your radio.

1 Press  to access the menu.



2 Press  or  to Utilities. Press  to select.

3 Press  or  to Radio Settings. Press  to select.

4 Press  or  to Tones/Alerts. Press  to select.

5 Press  or  to Keypad Tones. Press  to select.



6 Press  to enable or disable keypad tones. The display shows one of the following results:



- If enabled,  appears beside Enabled.
- If disabled,  disappears beside Enabled.



Setting Tones/Alerts Volume Offset Levels



This feature adjusts the volume of the tones or alerts, allowing it to be higher or lower than the voice volume. Follow the procedure to set the tones and alerts volume offset levels on your radio.



- 1 Press  to access the menu.

- 2 Press  or  to Utilities. Press  to select.



- 3 Press  or  to Radio Settings. Press  to select.

- 4 Press  or  to Tones/Alerts. Press  to select.

- 5 Press  or  to Vol. Offset. Press  to select.

- 6 Press  or  to the required volume offset level.

A feedback tone sounds with each corresponding volume offset level.



- 7 Do one of the following:
 - Press  to select. The required volume offset level is saved.
 - Press  to exit. The changes are discarded.



Turning Talk Permit Tone On or Off



Follow the procedure to turn Talk Permit Tone on or off on your radio.

- 1 Press  to access the menu.

- 2 Press  or  to Utilities. Press  to select.



3 Press  or  to Radio Settings. Press  to select.

4 Press  or  to Tones/Alerts. Press  to select.

5 Press  or  to Talk Permit. Press  to select.

6 Press  to enable or disable the Talk Permit Tone.



The display shows one of the following results:



- If enabled,  appears beside Enabled.
 - If disabled,  disappears beside Enabled.
-



Turning Power Up Tone On or Off



Follow the procedure to turn Power Up Tone on or off on your radio.

1 Press  to access the menu.



2 Press  or  to Utilities. Press  to select.

3 Press  or  to Radio Settings. Press  to select.

4 Press  or  to Tones/Alerts. Press  to select.

5 Press  or  to Power Up. Press  to select.



6 Press  to enable or disable the Power Up Tone. The display shows one of the following results:



- If enabled,  appears beside Enabled.
- If disabled,  disappears beside Enabled.



Setting Text Message Alert Tones





You can customize the text message alert tone to Momentary or Repetitive for each entry in the Contacts list. Follow the procedure to set the text message alert tones on your radio.



- 1 Press  to access the menu.

- 2 Press  or  to **Contacts**. Press  to select.

- 3 Press  or  to the required alias or ID.
Press  to select.

- 4 Press  or  to **Message Alert**. Press  to select.



- 5 Do one of the following:
 - Press  or  to **Momentary**. Press  to select.
The display shows  beside **Momentary**.



- Press  or  to **Repetitive**. Press  to select.
The display shows  beside **Repetitive**.
-



Changing Display Modes

You can change the display mode of the radio between Day or Night, as needed. This feature affects the color palette of the display. Follow the procedure to change the display mode of your radio.



- 1 Do one of the following:
 - Press the programmed **Display Mode** button. Skip the following steps.
 - Press  to access the menu.

- 2 Press  or  to **Utilities**. Press  to select.

- 3 Press  or  to **Radio Settings**. Press  to select.

- 4 Press  or  to Display. Press  to select.

The display shows Day Mode and Night Mode.



- 5 Press  or  to the required setting. Press  to select.

The display shows ✓ beside the selected setting.



Adjusting Display Brightness

Follow the procedure to adjust the display brightness on your radio. Display brightness cannot be adjusted when Auto Brightness is enabled.



- 1 Do one of the following:
 - Press the programmed **Brightness** button. Skip the following steps.
 - Press  to access the menu.
-

- 2 Press  or  to Utilities. Press  to select.
-

- 3 Press  or  to Radio Settings. Press  to select.
-

- 4 Press  or  to Brightness. Press  to select.

The display shows the progress bar.

- 5 Press  or  to decrease or increase the display brightness. Press  to select.



The setting value is varied from 1 to 8.



Turning Horns/Lights On or Off



Your radio is able to notify you of an incoming call through the horns and lights feature. When activated, an incoming call sounds the horn and turns on the lights of your vehicle. This feature needs to be installed through your radio rear

accessory connector by your dealer. Follow the procedure to turn all horns and lights on or off on your radio.

- 1 Do one of the following:
 - Press the programmed **Horns/Lights** button. Skip the steps below.
 - Press  to access the menu.

- 2 Press  or  to Utilities. Press  to select.

- 3 Press  or  to Radio Settings. Press  to select.



- 4 Press  or  to Horns/Lights. Press  to select.



- 5 Press  to enable or disable Horns/Lights. The display shows one of the following results:
 - If enabled, ✓ appears beside Enabled.
 - If disabled, ✓ disappears beside Enabled.



Turning LED Indicators On or Off

Follow the procedure to turn the LED indicators on or off on your radio.

- 1 Press  to access the menu.

- 2 Press  or  to Utilities. Press  to select.

- 3 Press  or  to Radio Settings. Press  to select.



- 4 Press  or  to LED Indicator. Press  to select.



- 5 Press  to enable or disable the LED indicator. The display shows one of the following results:
 - If enabled, ✓ appears beside Enabled.
 - If disabled, ✓ disappears beside Enabled.



Turning Public Address System On or Off



Follow the procedure to enable or disable the internal public address (PA) system of your radio.

- 1 Do one of the following:
 - Press the programmed **Public Address** button. Skip the following steps.
 - Press  to access the menu.

- 2 Press  or  to Utilities. Press  to select.

- 3 Press  or  to Radio Settings. Press  to select.



- 4 Press  or  to Public Address. Press  to select.



- 5 Press  to enable or disable Public Address.
 - If enabled,  appears beside Enabled.
 - If disabled,  disappears beside Enabled.



Turning External Public Address System On or Off

Follow the procedure to enable or disable the external public address (PA) system of your radio.



- 1 Do one of the following:
 - Press the programmed **Ext Public Address** button. Skip the following steps.
 - Press  to access the menu.

- 2 Press  or  to Utilities. Press  to select.

3 Press  or  to Radio Settings. Press  to select.

4 Press  or  to External Public Address. Press  to select.



5 Press  to enable or disable external public address.

- If enabled,  appears beside Enabled.
 - If disabled,  disappears beside Enabled.
-



Turning Introduction Screen On or Off



You can enable and disable the Introduction Screen by following the procedure.

1 Press  to access the menu.

2 Press  or  to Utilities. Press  to select.



3 Press  or  to Radio Settings. Press  to select.

4 Press  or  to Display. Press  to select.

5 Press  or  to Intro Screen. Press  to select.

6 Press  to enable or disable the Introduction Screen.



The display shows one of the following results:



- If enabled,  appears beside Enabled.
 - If disabled,  disappears beside Enabled.
-



Setting Languages





Follow the procedure to set the languages on your radio.

- 1 Press  to access the menu.

- 2 Press  or  to Utilities. Press  to select.

- 3 Press  or  to Radio Settings. Press  to select.



- 4 Press  or  to Languages. Press  to select.



- 5 Press  or  to the required language. Press  to select.
The display shows  beside the selected language.



Identifying Cable Type

Do the following steps to select the type of cable your radio uses.

- 1 Press  to access the menu.

- 2 Press  or  to Utilities. Press  to select.

- 3 Press  or  to Radio Settings. Press  to select.

- 4 Press  or  to Cable Type. Press  to select.

- 5 The current cable type is indicated by a .

Turning Voice Announcement On or Off

This feature enables the radio to audibly indicate the current zone or channel the user has just assigned, or the programmable button the user has just pressed.

This is typically useful when the user has difficulty reading the content shown on the display.

This audio indicator can be customized according to customer requirements. Follow the procedure to turn Voice Announcement on or off on your radio.

Turning Option Board On or Off

Option board capabilities within each channel can be assigned to programmable buttons. A channel can support up to 6 option board features. Follow the procedure to turn option board on or off on your radio.

Press the programmed **Option Board** button.

Text-to-Speech

The Text-to-Speech feature can only be enabled by your dealer or system administrator. If Text-to-Speech is enabled, the Voice Announcement feature is automatically disabled. If Voice Announcement is enabled, then the Text-to-Speech feature is automatically disabled.

This feature enables the radio to audibly indicate the following features:



- Current Channel
- Current Zone
- Programmed button feature on or off
- Content of received text messages
- Content of received Job Tickets



This audio indicator can be customized per customer requirements. This feature is typically useful when the user is in a difficult condition to read the content shown on the display.



Setting Text-to-Speech



Follow the procedure to set the Text-to-Speech feature.

- 1 Press  to access the menu.

- 2 Press  or  to Utilities. Press  to select.

- 3 Press  or  to Radio Settings. Press  to select.

- 4 Press  or  to Voice Announcement. Press  to select.

- 5 Press  or  to any of the following features. Press  to select.
The available features are as follows:
 - All
 - Messages



- Job Tickets
- Channel
- Zone
- Program Button



✓ appears beside the selected setting.



Setting Menu Timer



You can set the time your radio stays in the menu before it automatically switches to the Home screen. Follow the procedure to set the menu timer.



- 1 Press  to access the menu.

- 2 Press  or  to Utilities. Press  to select.

- 3 Press  or  to Radio Settings. Press  to select.

4 Press  or  to Display. Press  to select.

5 Press  or  to Menu Timer. Press  to select.



6 Press  or  to the required setting. Press  to select.

Turning Digital Microphone AGC On or Off



The Digital Microphone Automatic Gain Control (AGC) controls the microphone gain of the radio automatically while transmitting on a digital system.

This feature suppresses loud audio or boosts soft audio to a preset value in order to provide a consistent level of audio. Follow the procedure to turn Digital Microphone AGC on or off on your radio.

1 Press  to access the menu.



2 Press  or  to Utilities. Press  to select.

3 Press  or  to Radio Settings. Press  to select.

4 Press  or  to Mic AGC-D. Press  to select.

5 Press  to enable or disable Digital Microphone AGC.

The display shows one of the following results:

- If enabled,  appears beside Enabled.
 - If disabled,  disappears beside Enabled.
-

Turning Intelligent Audio On or Off

Your radio automatically adjusts the audio volume to overcome current background noise in the environment, inclusive of both stationary and non-stationary noise sources. This is a receive-only feature and does not affect



transmission audio. Follow the procedure to turn Intelligent Audio on or off on your radio.









NOTICE:

This feature is not applicable during a Bluetooth session.









- 1 Do one of the following:
 - Press the programmed **Intelligent Audio** button. Skip the steps below.
 - Press  to access the menu.

- 2 Press  or  to Utilities. Press  to select.

- 3 Press  or  to Radio Settings. Press  to select.

- 4 Press  or  to Intelligent Audio. Press  to select.



- 5 Do one of the following:



- Press  or  to On. Press  to select. The display shows  beside On.
- Press  or  to Off. Press  to select. The display shows  beside Off.



Turning the Acoustic Feedback Suppressor Feature On or Off



This feature allows you to minimize acoustic feedback in received calls.

- 1 Press  to access the menu.





- 2 Press  or  to Utilities and press  to select.

- 3 Press  or  to Radio Settings and press  to select.

- 4 Press  or  to AF Suppressor and press  to select.

You can also use  or  buttons to change the selected option.

- 5 Do one of the following.



- Press  to enable Acoustic Feedback Suppressor. The display shows  beside Enabled.
- Press  to disable Acoustic Feedback Suppressor. The  disappears from beside Enabled.



Turning Trill Enhancement On or Off



You can enable this feature when you are speaking in a language that contains many words with alveolar trill (rolling "R") pronunciations. Follow the procedure to turn Trill Enhancement on or off on your radio.

- 1 Do one of the following:









- Press the programmed **Trill Enhancement** button. Skip the steps below.
- Press  to access the menu.

- 2 Press  or  to Utilities. Press  to select.

- 3 Press  or  to Radio Settings. Press  to select.

- 4 Press  or  to Trill Enhance. Press  to select.

- 5 Do one of the following:

- Press  or  to On. Press  to select. The display shows  beside On.
- Press  or  to Off. Press  to select. The display shows  beside Off.

Audio Ambience

You can customize the audio ambience for your radio according to your environment.

Default

This is the default setting.

Loud

This setting enables Noise Suppressor and increases speaker loudness for use in noisy surroundings.

Work Group



This setting enables AF Suppressor and disables AGC for use when a group of radios are near to each other.



Setting Audio Ambience



Follow the procedure to set the audio ambience on your radio according to your environment.

- 1 Press  to access the menu.

- 2 Press  or  to Utilities. Press  to select.

- 3 Press  or  to Radio Settings. Press  to select.

- 4 Press  or  to Audio Ambience. Press  to select.

- 5 Press  or  to the required setting. Press  to select.

The settings are as follows.

- Choose **Default** for the default factory settings.
- Choose **Loud** to increase speaker loudness when using in noisy surroundings.
- Choose **Work Group** to reduce acoustic feedback when using with a group of radios that are near to each other.

The display shows  beside the selected setting.

Audio Profiles

You can customize the audio profiles for your radio according to your preference.

Default

This is the default setting.

Level 1, Level 2, and Level 3

These settings are intended to compensate for noise-induced hearing loss that is typical for adults in their 40's, 50's, and 60's or over.



Treble Boost, Mid Boost, and Bass Boost



These settings are intended for a tinnier sound, a more nasal sound, and a deeper sound.



Setting Audio Profiles



Follow the procedure to set audio profiles on your radio.

- 1 Press  to access the menu.

- 2 Press  or  to Utilities. Press  to select.

- 3 Press  or  to Radio Settings. Press  to select.

- 4 Press  or  to Audio Profiles. Press  to select.

- 5 Press  or  to the required setting. Press  to select.

The settings are as follows.

- Choose **Default** to disable the previously selected audio profile and return to the default factory settings.
- Choose **Level 1**, **Level 2**, or **Level 3** for audio profiles intended to compensate for noise-induced hearing loss that is typical for adults over 40 years of age.
- Choose **Treble Boost**, **Mid Boost**, or **Bass Boost** for audio profiles that align with your

preference for tinnier, more nasal, or deeper sounds.

The display shows ✓ beside the selected setting.

Turning Global Navigation Satellite System On or Off

Global Navigation Satellite System (GNSS) is a satellite navigation system that determines the radio precise location. GNSS includes Global Positioning System (GPS), Global Navigation Satellite System (GLONASS), and BeiDou Navigation Satellite System (BDS).









NOTICE:

Selected radio models may offer GPS, GLONASS, and BDS. GNSS constellation is configured by using CPS. Check with your dealer or system administrator to determine how your radio has been programmed.

- 1 Do one of the following steps to toggle GNSS on or off on your radio.
 - Press the programmed **GNSS** button.

- Press  to access the menu. Proceed to the next step.

- 2 Press  or  to Utilities. Press  to select.

- 3 Press  or  to Radio Settings. Press  to select.

- 4 Press  or  to GNSS. Press  to select.

- 5 Press  to enable or disable GNSS.
If enabled, ✓ appears beside Enabled.
If disabled, ✓ disappears beside Enabled.

General Radio Information



Your radio contains information on various general parameters.

The general information of your radio is as follows:

- Radio alias and ID.
- Firmware and Codeplug versions.
- Software update.
- GNSS information.
- Site information.



NOTICE:

Press  to return to the previous screen. Long press  to return to the Home screen. The radio exits the current screen once the inactivity timer expires.



Checking Radio Alias and ID



Follow the procedure to check the radio alias and ID on your radio.



- 1 Do one of the following:
 - Press the programmed **Radio Alias and ID** button. Skip the following steps. A positive indicator tone sounds.

You can press the programmed **Radio Alias and ID** button to return to the previous screen.

- Press  to access the menu.

2 Press  or  to Utilities. Press  to select.



3 Press  or  to Radio Info. Press  to select.



4 Press  or  to My ID. Press  to select.
The first text line shows the radio alias. The second text line shows the radio ID.



Checking Firmware and Codeplug Versions

Follow the procedure to check the firmware and codeplug versions on your radio.



- 1 Press  to access the menu.



2 Press  or  to Utilities. Press  to select.

3 Press  or  to Radio Info. Press  to select.

4 Press  or  to Versions. Press  to select.

The display shows the current firmware and codeplug versions.

3 Press  or  to Radio Info. Press  to select.

4 Press  or  to SW Update. Press  to select.



The display shows the date and time of the latest software update.

Software Update menu is only available after at least one successful OTAP or Wi-Fi session. See [Over-the-Air Programming on page 447](#) for more information.

Checking Software Update Information

This feature shows the date and time of the latest software update carried out through OTAP or Wi-Fi. Follow the procedure to check the software update information on your radio.

1 Press  to access the menu.

2 Press  or  to Utilities. Press  to select.

[Send Feedback](#)



Checking GNSS Information

Displays the GNSS information on your radio, such as values of:



- Latitude
- Longitude
- Altitude
- Direction
- Velocity
- Horizontal Dilution of Precision (HDOP)



- Satellites
- Version

1 Press  to access the menu.

2 Press  or  to Utilities. Press  to select.

3 Press  or  to Radio Info. Press  to select.



4 Press  or  to GNSS Info. Press  to select.



5 Press  or  to the required item. Press  to select. The display shows the requested GNSS information.



Displaying Site Information

Follow the procedure to display the current site name your radio is on.

1 Press  to access the menu.

2 Press  or  to Utilities. Press  to select.

3 Press  or  to Radio Info. Press  to select.



4 Press  or  to Site Info. Press  to select.



The display shows the current site name.

Viewing Enterprise Wi-Fi Certificate Details



You can view the details of the selected Enterprise Wi-Fi Certificate.

1 Press  to access the menu.

2 Press  or  to Utilities. Press  to select.

3 Press  or  to Certificate Menu. Press  to select.

✓ appears beside ready certificates.

4 Press  or  to the required certificate.
Press  to select.

Your radio displays the full details of the certificate.



NOTICE:

For unready certificates, the display shows only Status.

Connect Plus Operations

Connect Plus is a full trunking solution based on DMR technology. Connect Plus uses a dedicated control channel for channel requests and allocations. Features that are available to the radio users under this system are available in this chapter.

Additional Radio Controls in Connect Plus Mode

This chapter explains the additional radio controls available to the radio user through preprogrammed means such as programmable buttons and assignable radio functions.

Push-To-Talk (PTT) Button

The **PTT** button on the side of the radio serves two basic purposes:

- While a call is in progress, the **PTT** button allows the radio to transmit to other radios in the call.

Press and hold the **PTT** button to talk. Release the **PTT** button to listen.

The microphone is activated when the **PTT** button is pressed.

- While a call is not in progress, the **PTT** button is used to make a new call (see [Making a Radio Call on page 228](#)).

If the Talk Permit Tone is enabled, wait until the short alert tone ends before talking.

Programmable Buttons

Your dealer can program the programmable buttons as shortcuts to radio functions depending on the duration of a button press:

Short press

Pressing and releasing rapidly.

Long press

Pressing and holding for the programmed duration.



NOTICE:

The programmed duration of a button press is applicable for all assignable radio/utility functions or settings. See [Emergency Operation on page 261](#) for more information on the programmed duration of the *Emergency* button.

Assignable Radio Functions

Bluetooth® Audio Switch

Toggles audio routing between internal radio speaker and external Bluetooth-enabled accessory.

Bluetooth Connect

Initiates a Bluetooth find-and-connect operation.

Bluetooth Disconnect

Terminates all existing Bluetooth connections between your radio and any Bluetooth-enabled devices.

Bluetooth Discoverable

Enables your radio to enter Bluetooth Discoverable Mode.

Busy Queue Cancellation

Exits the busy mode when a non-Emergency call in the Busy Queue was initiated. Emergency calls, once accepted into the Busy Queue, cannot be cancelled.

Call Log

Selects the call log list.

Channel Announcement

Plays zone and channel announcement voice messages for the current channel.

Contacts

Provides direct access to the Contacts list.

Emergency On/Off

Depending on the programming, initiates or cancels an emergency.

Horns/Lights

Toggles horns and lights feature on or off.

Indoor Location

Toggles Indoor Location on or off.

Intelligent Audio

Toggles intelligent audio on or off.

Manual Dial

Depending on the programming, initiates a Private or Phone Call by keying in any subscriber ID or phone number.

One Touch Access

Directly initiates a predefined Private Call, a Call Alert, a Quick Text message, or Home Revert.

Privacy

Toggles privacy on or off.

Radio Check

Determines if a radio is active in a system.

Radio Enable

Allows a target radio to be remotely enabled.

Radio Disable

Allows a target radio to be remotely disabled.

Remote Monitor

Turns on the microphone of a target radio without it giving any indicators.

Reset Home Channel

Sets a new home channel.

Ring Alert Type

Provides direct access to the Ring Alert Type Setting.

Roam Request

Requests to search for a different site.

Scan

Toggles scan on or off.

Silence Home Channel Reminder

Mutes the Home Channel Reminder.

Site Lock On/Off

When toggled on, the radio searches the current site only. When toggled off, the radio searches other sites in addition to the current site.

Text Message

Selects the text message menu.

Voice Announcement On/Off

Toggles voice announcement on or off.

Wi-Fi

Toggles Wi-Fi on or off.

Zone

Allows selection from a list of zones.

Assignable Settings or Utility Functions

AF Suppressor

Toggles the Acoustic Feedback Suppressor feature on or off.

All Tones/Alerts

Toggles all tones and alerts on or off.

Backlight Brightness

Adjusts the brightness level.

Channel Up/Down

Depending on the programming, changes channel to previous or next channel.

Display Mode

Toggles the day/night display mode on or off.

Global Navigation Satellite System (GNSS)

Toggles the satellite navigation system on or off.

Power Level

Toggles transmit power level between high and low.

Unassigned

Indicates that the button function has not yet been assigned.

Identifying Status Indicators in Connect Plus Mode







Display Icons









The following are icons that appear on the display of the radio.









	Received Signal Strength Indicator (RSSI)
The number of bars displayed represents the radio signal strength. Four bars indi-	



	cate the strongest signal. This icon is only displayed while receiving.
	Bluetooth Not Connected The Bluetooth feature is enabled but there is no remote Bluetooth device connected.
	Bluetooth Connected The Bluetooth feature is enabled. The icon stays lit when a remote Bluetooth device is connected.
	High Volume Data Radio is receiving high volume data and channel is busy.
	Indoor Location Available ³ Indoor location status is on and available.
	Indoor Location Unavailable ³ Indoor location status is on but unavailable due to Bluetooth disabled or Beacons Scan suspended by Bluetooth.

³ Only applicable for models with the latest software and hardware

	<p>Mute Mode Mute Mode is enabled and speaker is muted.</p>
	<p>Notification Notification List has items to review.</p>
	<p>Power Level Radio is set at Low power or Radio is set at High power.</p>
	<p>Tones Disable Tones are turned off.</p>
	<p>Option Board The Option Board is enabled.</p>
	<p>Option Board Non-Function The Option Board is disabled.</p>
	<p>GNSS Available The GPS/GNSS feature is enabled. The icon stays lit when a position fix is available.</p>



	<p>GNSS Not Available/Out of Range The GPS/GNSS feature is enabled but is not receiving data from the satellite.</p>
	<p>Scan Scan feature is enabled.</p>
	<p>Emergency Radio is in Emergency mode.</p>
	<p>Secure The Privacy feature is enabled.</p>
	<p>Unsecure The Privacy feature is disabled.</p>
	<p>Site Roaming The site roaming feature is enabled.</p>
	<p>Contact Radio contact is available.</p>
	<p>Call Log Radio call log.</p>

	Message Incoming message.
	Ring Only Ringing mode is enabled.
	Silent Ring Silent ring mode is enabled.
	Vibrate Vibrate mode is enabled.
	Vibrate and Ring Vibrate and Ring mode is enabled.
	Wi-Fi Excellent ⁴ Wi-Fi signal is excellent.
	Wi-Fi Good ⁴ Wi-Fi signal is good.
	Wi-Fi Average ⁴ Wi-Fi signal is average.

	Wi-Fi Poor ⁴ Wi-Fi signal is poor.
	Wi-Fi Unavailable ⁴ Wi-Fi signal is unavailable.

Call Icons

The following icons appear on your radio display during a call. These icons also appear in the Contacts list to indicate ID type.

	Private Call Indicates a Private Call in progress. In the Contacts list, it indicates a subscriber alias (name) or ID (number).
	Group Call/Site All Call Indicates a Group Call or Site All Call in progress. In the Contacts list, it indicates a group alias (name) or ID (number).

⁴ Only applicable for XPR 5550e/XPR 5580e



Phone Call as Private Call

Indicates a Phone Call as Private Call in progress.



Bluetooth PC Call

Indicates a Bluetooth PC Call in progress.

In the Contacts list, it indicates a Bluetooth PC Call alias (name) or ID (number).



Dispatch Call

The Dispatch Call contact type is used to send a text message to a dispatcher PC through a third-party Text Message Server.

Advanced Menu Icons

The following icons appear beside menu items that offer a choice between two options or as an indication that there is a sub-menu offering two options.



Checkbox (Empty)

Indicates the option is not selected.



Checkbox (Checked)

Indicates the option is selected.



Solid Black Box

Indicates the option selected for the menu item with a sub-menu.

Sent Item Icons

The following icons appear at the top right corner of the radio display in the Sent Items folder.



Sent Successfully

The text message is sent successfully.

OR





In-Progress



OR



- The text message to a group alias or ID is pending transmission.
- The text message to a subscriber alias or ID is pending transmission, followed by waiting for acknowledgement.



Individual or Group Message Read

The text message has been read.

OR



OR

Individual or Group Message Unread

The text message has not been read.



Send Failed

The text message has not been sent.

OR



Bluetooth Device Icons

The following icons also appear next to items in the list of Bluetooth-enabled devices available to indicate the device type.



Bluetooth Data Device

Bluetooth-enabled data device, such as a scanner.



Bluetooth Audio Device

Bluetooth-enabled audio device, such as a headset.



Bluetooth PTT Device

Bluetooth-enabled PTT device, such as a PTT-Only Device (POD).

LED Indicator

The LED indicator shows the operational status of your radio.

Blinking red	Radio is transmitting at low battery condition, receiving an emergency transmission or has failed the self-test upon powering up, or has moved out of range if radio is configured with Auto-Range Transponder System. Mute Mode is enabled.
Rapidly blinking red	Radio is receiving over-the-air file transfer (Option Board firmware file, Network Frequency file or Option Board Codeplug file) or upgrading to a new Option Board firmware file.
Blinking green and yellow	Radio is receiving a Call Alert, received a text message or Scan is enabled and is receiving activity.
Solid yellow	Radio is in Bluetooth Discoverable Mode.



Double blinking yellow	Radio is actively searching for a new site.
Blinking yellow	Radio is receiving a Call Alert or Scan is enabled and is idle (radio will remain muted to any activity).
Solid green	Radio is powering up or transmitting.
Blinking green	Radio is powering up, receiving a call or data.
Double blinking green	Radio is receiving a privacy-enabled call.

Indicator Tones

The following are the tones that sound through the radio speaker.





High pitched tone Low pitched tone

Indicator tones provide you with audible indications of the status after an action to perform a task is taken.

	Positive Indicator Tone
	Negative Indicator Tone

Alert Tones

Alert tones provide you with audible indications of the status, or response to data received on the radio.

Continuous Tone 	A monotone sound. Sounds continuously until termination.
Periodic Tone 	Sounds periodically depending on the duration set by the radio. Tone starts, stops, and repeats itself.
Repetitive Tone 	A single tone that repeats itself until it is terminated by the user.
Momentary Tone 	Sounds only once for a short period of time defined by the radio.

Switching Between Connect Plus and Non-Connect Plus Modes

To switch to a non-Connect Plus mode, you must change to another zone, if programmed by your dealer or system administrator. Check with your dealer or system administrator to see if your radio has been programmed with non-Connect Plus zones, and what features are available while operating in non-Connect Plus zones.

Making and Receiving Calls in Connect Plus Mode

This section explains general radio operations and call features that are available in your radio.

Selecting a Site

A site provides coverage for a specific area. A Connect Plus site has a site controller and a maximum of 15 repeaters. In a multi-site network, the Connect Plus radio will automatically search for a new site when the signal level from the current site drops to an unacceptable level.

Roam Request

A Roam Request tells the radio to search for a different site, even if the signal from the current site is acceptable.

If there are no sites available:

- The radio displays `Searching` and `Selected Channel Alias` and continues to search through the list of sites.
- The radio will return to the previous site, if the previous site is still available.



NOTICE:

This is programmed by your dealer.

Press the programmed **Roam Request** button.

You hear a tone, indicating the radio has switched to a new site. The display shows `Site ID <Site Number>`.

Site Lock On/Off

When toggled on, the radio searches the current site only. When toggled off, the radio searches other sites in addition to the current site.

Press the programmed **Site Lock** button.

If the **Site Lock** function is toggled on:

- You hear a positive indicator tone, indicating the radio has locked to the current site.
- The display shows `Site Locked`.

If the **Site Lock** function is toggled off:

- You hear a negative indicator tone, indicating the radio is unlocked.
 - The display shows `Site Unlocked`.
-

Site Restriction

Your Connect Plus radio system administrator has the ability to decide which network sites your radio is and is not allowed to use. Your radio does not need to be reprogrammed to change the list of allowed and disallowed sites. If your radio attempts to register at a disallowed site,

you see a brief message stating: Site <number given> Not Allowed. The radio then searches for a different network site.





Selecting a Zone

The radio can be programmed with a maximum of 16 Connect Plus Zones and each Connect Plus zone contains a maximum of 16 assignable positions on the Channel Selector Knob.

Each assignable knob position can be used to start one of the following voice call types:

- Group Call
- Multi-group Call
- Site All Call
- Private Call

1 Access the Zone feature by performing the following:

Radio Controls	Steps
Programmed Zone Selection button	Press the programmed Zone Selection button.
Radio menu	<p>a Press  to access the menu.</p> <p>b Press  or  to Zone and press  to select.</p>

The current zone is displayed and indicated by a  .

2 Select the required zone.

Radio Control	Steps
 or 	Press  or  and scroll to the required zone.

- 3 Press  to select.

The display shows <Zone> Selected momentarily and returns to the selected zone screen.

Using Multiple Networks

If your radio has been programmed to use multiple Connect Plus networks, you can select a different network by switching to the Connect Plus zone that is assigned to the desired network. These network-to-zone assignments are configured by your dealer through radio programming.

Selecting a Call Type

Use the Channel Selector Knob to select a call type. This can be a Group Call, Multi-group Call, Site All Call or Private Call, depending on how your radio is programmed. If you change the Channel Selector Knob to a different position (that has a call type assigned to it), this causes the radio to re-register with the Connect Plus site. The radio registers with the Registration Group ID that has been programmed for the new Channel Selector Knob position call type.

If you select a position that has no call type assigned to it, your radio sounds a continuous tone and the display shows Unprogrammed. Your radio does not operate when selected to an unprogrammed channel, use the Channel Selector Knob to select a programmed channel instead.

Once the required zone is displayed (if you have multiple zones in your radio), turn the programmed Channel Selector Knob to select the call type.

Receiving and Responding to a Radio Call

Once the channel, subscriber ID or call type is displayed, you can proceed to receive and respond to calls.

The LED lights up solid green while the radio is transmitting and blinks green when the radio is receiving.

**NOTICE:**

The LED lights up solid green while the radio is transmitting and double blinks green when the radio is receiving a privacy-enabled call. To unscramble a privacy-enabled call, your radio must have the same Privacy Key, OR the same Key Value and Key ID (programmed by your dealer), as the transmitting radio (the radio you are receiving the call from).

See [Privacy on page 280](#) for more information.

Receiving and Responding to a Group Call

To receive a call from a group of users, your radio must be configured as part of that group.

When you receive a Group Call (while on the Home screen), the LED blinks green. The Group Call icon appears in the top right corner. The first text line shows the caller alias. The second text line displays the group call alias.

Your radio unmutes and the incoming call sounds through the radio speaker.

- 1 Hold the microphone 1 to 2 inches (2.5 to 5.0 cm) from your mouth.

The LED lights up solid green.

- 2 Wait for one of the Talk Permit Tone to finish (if enabled), and speak clearly into the microphone.
-

- 3 Release the **PTT** button to listen.

If there is no voice activity for a predetermined period of time, the call ends.

**NOTICE:**

See [Making a Group Call on page 229](#) for details on making a Group Call.

Receiving and Responding to a Private Call

A Private Call is a call from an individual radio to another individual radio.

When you receive a Private Call, the LED blinks green. The first line of the display shows the subscriber alias or ID, and the RSSI icon. The second line displays `Private Call` and the Private Call icon. Your radio unmutes and the incoming call sounds through the speaker of the radio.

- 1 Hold the microphone 1 to 2 inches (2.5 to 5.0 cm) from your mouth.

- 2 Press the **PTT** button to respond to the call.
The LED lights up solid green.

- 3 Wait for the Talk Permit Tone to finish (if enabled), and speak clearly into the microphone.

- 4 Release the **PTT** button to listen.

If there is no voice activity for a predetermined period of time, the call ends.

The display shows `Call Ended`.

See [Making a Private Call on page 230](#) for details on making a Private Call.

Receiving a Site All Call

A Site All Call is a call from an individual radio to every radio on the site. It is used to make important announcements requiring the user's full attention.

When you receive an Site All Call, a tone sounds and the LED blinks green.

The Group Call icon appears in the top right corner. The first text line shows the caller alias. The second text line displays `Site All Call`. Your radio unmutes and the incoming call sounds through the radio speaker.

Once the Site All Call ends, the radio returns to the previous screen before receiving the call. A Site All Call does not wait for a predetermined period of time before ending.

You cannot respond to a Site All Call.



NOTICE:

See [Making a Site All Call on page 230](#) for details on making a Site All Call.

The radio stops receiving the Site All Call if you switch to a different channel while receiving the call. During a Site All Call, you will not be able to use any programmed button functions until the call ends.

Receiving an Inbound Private Phone Call

When you receive an Inbound Private Phone Call, the Phone Call as Private Call icon appears in the top right corner. The first text line shows Phone Call.

- 1 Press and hold the **PTT** button to answer and talk. Release the **PTT** button to listen.
-



- 2 Long press  to end the call.

The first line of the display shows Ending. The second line of the display shows Phone Call.... The display returns to the Phone Call screen. The display shows Phone Call Ended.

Making a Buffered Over-Dial in an Inbound Phone Private Call

During the call, the Phone Call as Private Call icon appears in the top right corner. The first text line of the display shows Phone Call.

- 1 Use the keypad to enter the digits and press the  button.

Press  followed by  within 2 seconds to insert a pause. The P replaces * and # on the display.

The Phone Call as Private Call icon appears in the top right corner. The first text line of the display shows the entered digits.

- 2 Long press  to end the call.

The first line of the display shows Ending. The second line of the display shows Phone Call.... The display returns to the Phone Call screen.

The display shows Phone Call Ended.

Making a Live Over-Dial in an Inbound Phone Private Call

During the call, the Phone Call as Private Call icon appears in the top right corner. The first text line of the display shows `Phone Call`.

- 1 Press the **PTT** button and use the keypad to enter the digits.

The Phone Call as Private Call icon appears in the top right corner. The first text line of the display shows the Live Dial digits.

- 2 Long press  to end the call.

The first line of the display shows `Ending`. The second line of the display shows `Phone Call....`. The display returns to the Phone Call screen.

The display shows `Phone Call Ended`.

Receiving an Inbound Phone Talkgroup Call

When you receive an Inbound Phone Talkgroup Call, the Group Call icon appears in the top right corner. The first text line shows `Call11`.

Press the **PTT** button to talk and release it to listen.

Inbound Phone Multi-Group Call

When you receive an Inbound Phone Multi-Group Call, the Group Call icon appears in the top right corner. The first text line shows `Multigroup Call`. The radio unmutes and the incoming multi-group call sounds through the radio speaker.

Making a Radio Call

After selecting your channel, you can select a subscriber alias or ID, or group alias or ID by using:

- The Channel Selector Knob.
- A programmed **One Touch Access** button – The One Touch Access feature allows you to make a Private Call to a predefined ID easily. This feature can be assigned

to a short or long programmable button press. You can only have one ID assigned to a **One Touch Access** button. Your radio can have multiple **One Touch Access** buttons programmed.

- The Contacts list (see [Contacts Settings on page 250](#)).



NOTICE:

Your radio must have the Privacy feature enabled on the channel to send a privacy-enabled transmission. Only target radios with the same Key Value and Key ID as your radio will be able to unscramble the transmission.

See [Privacy on page 280](#) for more information.

Making a Call with the Channel Selector Knob

This feature allows the radio users to make different call types : Group Call, Private Call, Site All Call, Multi-group Call.

Making a Group Call

To make a call to a group of users, your radio must be configured as part of that group.

1 Select the channel with the active group alias or ID. See [Selecting a Call Type on page 224](#).

2 Hold the microphone 1 to 2 inches (2.5 to 5.0 cm) from your mouth.

3 Press the **PTT** button to make the call.

The LED lights up solid green. The Group Call icon appears in the top right corner. The first text line shows the group call alias.

4 Wait for the Talk Permit Tone to finish (if enabled), and speak clearly into the microphone.

5 Release the **PTT** button to listen.

When the target radio responds, the LED blinks green, the radio unmutes and the response sounds through the radio speaker. You see the Group Call icon, the group alias or ID, and transmitting radio alias or ID on your display.

If there is no voice activity for a predetermined period of time, the call ends. Radio returns to the screen you were on prior to initiating the call.

Making a Private Call

While you can receive and/or respond to a Private Call initiated by an authorized individual radio, your radio must be programmed for you to initiate a Private Call.

You will hear a negative indicator tone, when you make a Private Call using the **One Touch Access** button, or the Channel Selector Knob, if this feature is not enabled.

- 1 Do one of the following.
 - Select the channel with the active subscriber alias or ID. See [Selecting a Call Type on page 224](#).
 - Press the programmed **One Touch Access** button.

-
- 2 Hold the microphone 1 to 2 inches (2.5 to 5.0 cm) from your mouth.

-
- 3 Press the **PTT** button to make the call.

The LED lights up solid green. The Private Call icon appears on the top right corner. The first text line shows the target subscriber alias. The second text line displays the call status.

-
- 4 Wait for the Talk Permit Tone to finish (if enabled), and speak clearly into the microphone.

-
- 5 Release the **PTT** button to listen.

When the target radio responds, the LED blinks green.

If there is no voice activity for a predetermined period of time, the call ends. You hear a short tone. The display shows `Call Ended`.

Your radio may be programmed to perform a radio presence check prior to setting up the Private Call. If the target radio is not available, you hear a short tone and see negative mini notice on the display.

Making a Site All Call

This feature allows you to transmit to all users on the site that are currently not engaged in another call. Your radio must be programmed to allow you to use this feature.

Users on the channel/site cannot respond to an Site All Call.

- 1 Select the channel with the active Site All Call group alias. See [Selecting a Call Type on page 224](#).

- 2 Hold the microphone 1 to 2 inches (2.5 to 5.0 cm) from your mouth.
-
- 3 Press the **PTT** button to make the call.
The LED lights up solid green. The Group Call icon appears in the top right corner. The first text line shows `Site All Call`.
-
- 4 Wait for the Talk Permit Tone to finish (if enabled), and speak clearly into the microphone.
-

Making a Multi-group Call

This feature allows you to transmit to all users on multiple groups. Your radio must be programmed to allow you to use this feature.



NOTICE:

Users on the groups cannot respond to a Multi-group Call.

- 1 Turn the Channel Selector Knob to select the Multi-group alias or ID.
-

- 2 Press the **PTT** button to make the call.

The LED lights up solid green. The display shows the Multi-group alias or ID.

Wait for the Talk Permit Tone to finish (if enabled) and speak clearly into the microphone.

Making a Private Call with a One Touch Call Button



NOTICE:

Programmable buttons press must be initiated from the Home screen.

The One Touch Call feature allows you to easily make a Private Call to a pre-defined Private Call alias or ID. This feature can be assigned to a short or long programmable button press.

You can **ONLY** have one alias or ID assigned to a One Touch Call button. Your radio can have multiple One Touch Call buttons programmed.

- 1 Press the programmed **One Touch Call** button to make a Private Call to the pre-defined Private Call alias or ID.
-

- 2 Hold the microphone 1 to 2 inches (2.5 to 5.0 cm) from your mouth.
-

- 3 Press the **PTT** button to make the call.
The LED lights up solid green.
The display shows the Private Call alias or ID.
-

- 4 Wait for the Talk Permit Tone to finish (if enabled) and speak clearly into the microphone.
-

- 5 Release the **PTT** button to listen.
When the target radio responds, the LED blinks green.
If there is no voice activity for a predetermined period of time, the call ends.
-

Making a Call with the Programmable Manual Dial Button

This feature allows the radio users to make private calls using the programmable manual dial button.

Making a Private Call

- 1 Press the programmed **Manual Dial** button to enter into the Manual Dial screen.

The display shows `Number: .`

- 2 Use the keypad to enter a subscriber alias or Private ID.
-

- 3 Hold the microphone 1 to 2 inches (2.5 to 5.0 cm) from your mouth.
-

- 4 Press the **PTT** button to make the call.
The LED lights up solid green. The Private Call icon appears in the top right corner. The first text line shows the subscriber alias. The second text line displays the call status.
-

- 5 Wait for the Talk Permit Tone to finish (if enabled) and speak clearly into the microphone.
-

- 6 Release the **PTT** button to listen.

When the target radio responds, the LED blinks green.



If there is no voice activity for a predetermined period of time, the call ends. You hear a short tone. The display shows `Call Ended`.

Making an Outbound Private Phone Call with the Programmable Manual Dial Button

- 1 Press the programmed **Manual Dial** button to enter into the Manual Dial screen.

The display shows `Number:.`

- 2 Use the keypad to enter a telephone number, and press  to place a call to the entered number.

Press  to delete any unwanted characters. Press  followed by  within 2 seconds to insert a pause. The P replaces * and # on the display.

If successful, the first line of the display shows `Phone Call`. The second line of the display shows the dialed telephone number.

If an invalid telephone number is selected, the display shows a negative mini notice, `Phone Call Failed, Resource Not Available, or Invalid Permissions`.

If  is pressed with no telephone number entered, the radio sounds a positive indicator tone then a negative indicator tone. The display remains the same.



- 3 Long press  to end the call.

The first line of the display shows `Ending`. The second line of the display shows `Phone Call....`

The display shows `Phone Call Ended`.



Making an Outbound Private Phone Call via the Phone Menu

- 1 Press  to access the menu.

- 2 Press  or  to Phone and press  to select.

- 3 Press  to select Manual Dial.
The first line of the display shows `Number`, the second line of the display shows a blinking cursor.

- 4 Use the keypad to enter a telephone number, and press  to place a call to the entered number.

Press  to delete any unwanted characters. Press  followed by  within 2 seconds to insert a pause. The P replaces * and # on the display.

If successful, the first line of the display shows `Phone Call`. The second line of the display shows the dialed telephone number.

If an invalid telephone number is selected, the display shows a negative mini notice, `Phone Call Failed, Resource Not Available, or Invalid Permissions`.

If  is pressed with no telephone number entered, the radio sounds a positive indicator tone then a negative indicator tone. The display remains the same.

- 5 Long press  to end the call.
The first line of the display shows `Ending`. The second line of the display shows `Phone Call....`
The display shows `Phone Call Ended`.



Making an Outbound Private Phone Call from Contacts









NOTICE:

If the Phone Manual Dial is disabled in MOTOTRBO Connect Plus Option Board CPS, the `Phone Number` item will **not** be displayed in the Menu.

- 1 Press  to access the menu.



- 2 Press  or  to `Contacts` and press  to select.

- 3 Press  or  to `Manual Dial` and press  to select.

- 4 Press  or  to `Phone Number` and press  to select.

The first line of the display shows `Number`, the second line of the display shows a blinking cursor.

- 5 Use the keypad to enter a telephone number, and press  to place a call to the entered number.
If the **PTT** button is pressed, the display shows a negative mini notice, `Press OK to Send` and returns to the previous screen.

Press  to delete any unwanted characters. Press  followed by  within 2 seconds to insert a pause. The `P` replaces `*` and `#` on the display.

If successful, the first line of the display shows `Phone Call`. The second line of the display shows the dialed telephone number.

If  is pressed with no telephone number entered, the radio sounds a positive indicator tone then a negative indicator tone. The display remains the same.

- 6 Long press  to end the call.

The first line of the display shows `Ending`. The second line of the display shows `Phone Call....`

The display shows `Phone Call Ended`.

Waiting for the Channel Grant in an Outbound Private Phone Call

When you make a Private Phone Call, the first line of the display shows `Phone Call`. The second line of the display shows the dialed telephone number.

When the call is connected, the Phone Call as Private Call icon appears in the top right corner. The first line of the display shows the telephone number.

If unsuccessful, the display shows a negative mini notice, `Phone Call Failed, Resource Not Available, or Invalid Permissions`.

Long press  to end the call.



The display returns to the previous screen.

Making a Buffered Over-Dial in a Connected Outbound Private Phone Call

During the call, the Phone Call as Private Call icon appears in the top right corner. The first text line of the display shows the telephone number.

- 1 Use the keypad to enter the digits.

Press  to delete any unwanted characters. Press

 followed by  within 2 seconds to insert a pause. The P replaces * and # on the display.

The first text line of the display shows `Extra Digits`, the second text line of the display shows the entered extra digits.



- 2 Press the  button.

If the **PTT** button is pressed, the display shows a negative mini notice, `Press OK to Send` and returns to the previous screen.

The Phone Call as Private Call icon appears in the top right corner. The first text line of the display

shows the telephone number with the over-dial digits appended.

3 Do one of the following.

- Press  to return to the Phone Call screen.
- Long press  to end the call.

Making a Live Over-Dial in a Connected Outbound Private Phone Call

During the call, the Phone Call as Private Call icon appears in the top right corner. The first text line of the display shows the telephone number.

1 Press the **PTT** button and use the keypad to enter the digits.

The Phone Call as Private Call icon appears in the top right corner. The first text line of the display shows the telephone number with the over-dial digits appended.

2 Long press  to end the call.

The first line of the display shows `Ending`. The second line of the display shows `Phone Call....`

The display shows `Phone Call Ended`.

Advanced Features in Connect Plus Mode

This chapter explains the operations of the features available in your radio.

Home Channel Reminder

This feature provides a reminder when the radio is not set to the home channel for a period of time.

If this feature is enabled by using the CPS, the Home Channel Reminder tone and announcement sound, the first line of the display shows `Non` and the second line shows `Home Channel` periodically when the radio is not set to the home channel for a period of time.

You can respond to the reminder by performing one of the following actions:

- Return to the home channel.
- Mute the reminder temporarily by using the programmable button.
- Set a new home channel by using the programmable button.

Auto Fallback

Auto Fallback is a system feature that allows you to continue to make and receive non-emergency calls on the selected Group Contact in the event of certain types of Connect Plus system failures.

If one of these failures occurs, your radio attempts to roam to a different Connect Plus site. This search process may result in your radio finding an operable Connect Plus site, or it may result in your radio finding a “Fallback Channel” (if your radio is enabled for Auto Fallback). A Fallback Channel is a repeater that is normally part of an operable Connect Plus site, but is currently unable to communicate with either its site controller or the Connect Plus network. In Fallback mode, the repeater operates as a single digital repeater. Auto Fallback Mode supports non-emergency Group Calls only. No other call types are supported in Fallback Mode.

Indications of Auto Fallback Mode

When your radio is using a Fallback channel, you hear the intermittent “Fallback Tone” approximately once every 15 seconds (except while transmitting). The display periodically shows a brief message, “Fallback Channel”. Your radio only permits PTT on the selected Group Contact (Group Call, Multigroup Call, or Site All Call). It does not allow you to make other types of calls.

Making/Receiving Calls in Fallback Mode



NOTICE:

Calls are heard only by radios that are monitoring the same Fallback channel and selected to the same Group. Calls are not networked to other sites or other repeaters.

Emergency voice calls or Emergency Alerts are not available in Fallback mode. If you press the emergency button in Fallback mode, the radio provides an invalid key press tone. Display-equipped radios also show the message, "Feature not available".

Private (radio to radio) and Phone calls are not available in Fallback mode. If you attempt a call to a private contact, you will receive a denial tone. At this point you should select a desired group contact. Other non-supported calls include Remote Monitor, Call Alert, Radio Check, Radio Enable, Radio Disable, Text messaging, Location Updates, and packet data calls.

Enhanced Traffic Channel Access (ETCA) is not supported in Auto Fallback mode. If two or more radio users press **PTT** at the same time (or at

almost the same time), it is possible that both radios transmit until **PTT** is released. In this event, it is possible that none of the transmissions will be understood by receiving radios.

Making calls in Fallback mode is similar to normal functioning. Simply select the group contact you wish to use (using the radio's normal channel selection method), and then press the **PTT** to start your call. It is possible that the channel may be in use already by another group. If the channel is in use, you receive a busy tone and the display will say "Channel Busy". You may select Group, Multi-group or Site All Call contacts using your radio's normal channel selection method. While the radio is operating on the Fallback Channel, the Multigroup operates just like other Groups. It is only heard by radios that are currently selected to the same Multi-group.

Returning to Normal Operation

If the site returns to normal trunking operation while you are in range of your Fallback repeater, your radio automatically exits Auto Fallback mode. You hear a registration "beep" when the radio successfully registers. If you are in the range of an operable site (that is not in Fallback mode), you may press the Roam Request button (if programmed for your radio) to force your radio to search for and register on

an available site. If no other site is available, your radio returns to Auto Fallback mode after searching is complete. If you drive out of coverage of your Fallback repeater, your radio enters Search mode (display indicates Searching).

Radio Check













If enabled, this feature allows you to determine if another radio is active in a system without disturbing the user of that radio. No audible or visual notification is shown on the target radio.

This feature is only applicable for subscriber aliases or IDs.

Sending a Radio Check

- 1 Access the Radio Check feature.

Radio Control	Steps
Programmed Radio Check button	a Press the programmed Radio Check button.

Radio Control	Steps
	b Press  or  to the required subscriber alias or ID and press  to select.
Menu	<p>a Press  to access the menu.</p> <p>b Press  or  to Contacts and press  to select.</p> <p>c Press  or  to the required subscriber alias or ID and press  to select.</p> <p>d Press  or  to Radio Check and press  to select.</p>

The display shows the Target Alias, indicating the request is in progress. The LED lights up solid green.

2 Wait for acknowledgment.

If the target radio is active in the system, a tone sounds and the display briefly shows `Target Radio Available`.

If the target radio is not active in the system, a tone sounds and the display briefly shows `Target Radio Not Available`.

Radio returns to the subscriber alias or ID screen when initiated via Menu.

Radio returns to the Home Screen if initiated via the programmable button.

Remote Monitor

Use the Remote Monitor feature to turn on the microphone of a target radio (subscriber alias or IDs only). The green LED will blink once on the target subscriber. You can use this feature to monitor, remotely, any audible activity surrounding the target radio.

Your radio must be programmed to allow you to use this feature.







Initiating Remote Monitor











NOTICE:

Remote Monitor automatically stops after a programmed duration or when there is any attempt to initiate transmission, change channels or power down the radio.

1 Access the Remote Monitor feature.

Radio Control	Steps
Programmed Remote Monitor Button	<p>a Press the programmed Remote Monitor button.</p> <p>b Press  or  to the required subscriber alias or ID and press  to select.</p>
Menu	<p>a Press  to access the menu.</p> <p>b Press  or  to Contacts and press  to select.</p>

Radio Control	Steps
	<p>c Press  or  to the required subscriber alias or ID and press  to select.</p> <p>d Press  or  to Manual Dial and press  to select.</p> <p>e Press  or  to Remote Mon. and press  to select.</p>

The first text line shows Rem. Monitor. The second text line displays the Target Alias, indicating the request is in progress. The LED lights up blinking green.

2 Wait for acknowledgment.

If successful, a positive indicator tone sounds and the display momentarily shows Rem. Monitor Successful. Your radio starts playing audio from the monitored radio for a programmed duration and

display shows Rem. Monitor, followed by target alias. Once the timer expires, the radio sounds an alert tone and the LED turns off.

If unsuccessful, the radio sounds a negative indicator tone the display shows Rem. Monitor Failed.

Scan

This feature allows your radio to monitor and join calls for groups defined in a pre-programmed scan list. When scan is enabled, the scan icon appears on the status bar and the LED blinks yellow when idle.

Starting and Stopping Scan









NOTICE:

This procedure turns the Scan feature On or Off for all Connect Plus zones with the same Network ID as your currently selected zone. It is important to note that even when the Scan feature is turned on via this procedure, scan may still be disabled for some (or all) groups on your scan list. See [Editing the Scan List on page 245](#) for more information.

You can start and stop scanning by pressing the programmed **Scan** button **OR** follow the procedure described next.

- 1 Press  to access the menu.

 - 2 Press  or  to Scan and press  to select.

 - 3 Press  or  to Turn On or Turn Off and press  to select.
 - The display shows Scan On if scan is enabled.
 - The Scan menu shows Turn Off if scan is enabled.
 - The display shows Scan Off if scan is disabled.
 - The Scan menu shows Turn On if scan is disabled.
-

Responding to a Transmission During a Scan

During scanning, your radio stops on a group where activity is detected. The radio continuously listens for any member in the scan list when idle on the control channel.

- 1 Hold the microphone 1 to 2 inches (2.5 to 5.0 cm) from your mouth.

 - 2 Press the **PTT** button during hang time.
The LED lights up solid green.

 - 3 Wait for the Talk Permit Tone to finish (if enabled), and speak clearly into the microphone.

 - 4 Release the **PTT** button to listen.
If you do not respond within the hang time, the radio returns to scanning other groups.
-

User Configurable Scan

If the Edit List menu is enabled, a user is able to Add and Remove the scan members from the Add Member menu. A

Scan List member must be a regular Group Contact (for example, not Multi-group or Site All Call/Network Wide All Call) that is currently assigned to a Channel Selector position in a Connect Plus Zone with the same Network ID as the currently selected Zone. The Talkgroup alias must not match any Talkgroup that has been included in the current Zone Scan List.

Scan can be turned on or off from the menu or by pressing a programmed **Scan On/Off** button.

This feature functions only when the radio is not currently involved in a call. If you are presently listening to a call, your radio cannot scan for other group calls, and is therefore unaware they are in progress. Once your call is finished, your radio returns to the control channel time slot and is able to scan for groups that are in the scan list.

Turning Scan On or Off







NOTICE:



This procedure turns the Scan feature On or Off for all zones with the same Network ID as your currently selected zone. It is important to note that even when the Scan feature is turned on via this procedure, scan may still be disabled for some (or all) groups on your scan list. See the next section for more information.

If Scan is turned on, the Scan icon appears on your display. When Scan is on and you are not participating in a call, the LED blinks green and yellow.

The procedure for turning Scan on or off depends on how your radio is programmed. If programmed with a Scan On/Off button, use the button to toggle the feature on or off. If your radio has been programmed so that Scan can be turned on or off via the menu, follow the procedure described next.

- 1 Press  OK to access the menu.

- 2 Press  or  to Scan and press  OK to select.

- 3 Press  or  to Turn On or Turn Off and press  to select.
- The display shows `Scan On` momentarily if scan is disabled.
 - The display shows `Scan Off` momentarily if scan is enabled.

Editing the Scan List



NOTICE:

If the scan list entry happens to be the currently selected group, the radio listens for activity on this group regardless of whether the list entry currently shows a check mark or not. Whenever a radio is not in a call, the radio listens for activity on its Selected Group, Multi-group, the Site All Call, and its Default Emergency Revert Group (if configured for one). This operation cannot be disabled. If Scan is enabled the radio will also listen for activity on enabled Zone Scan List members.

Your scan list determines which groups can be scanned. The list is created when your radio is programmed. If your







radio has been programmed to allow you to edit the scan list, you can:

- Enable/disable scan for individual groups on the list.
- Add and Remove the scan members from the Add Member menu. Refer to [Add or Delete a Group via the Add Members Menu on page 246](#).



NOTICE:

A Scan List member must be a regular Group Contact (not Multi-group or Site All Call/Network Wide All Call) that is currently assigned to a Channel Selector position in a Connect Plus Zone with the same Network ID as the currently selected Zone. The Talkgroup alias must not match any Talkgroup that has been included in the current Zone Scan List.

- 1 Press  to access the menu.
-
- 2 Press  or  to View/Edit List and press  to select.
-
- 3 Press  or  to the desired Group name.

If a check mark precedes the Group name, then scan is currently enabled for this Group.

If there is no check mark preceding the Group name, then scan is currently disabled for this Group.

- 4  to select the desired Group.

The display shows `Enable` if scan is currently disabled for the Group.

The display shows `Disable` if scan is currently enabled for the Group.

- 5 Select the displayed option (`Enable` or `Disable`) and press  to select.

Depending on which option was selected, the radio momentarily displays `Scan Enabled` or `Scan Disabled` as confirmation.



The radio displays the Zone scan list again. If scan was enabled for the Group, the check mark displays before the Group name. If scan was disabled for the Group, the check mark is removed before the Group name.



Add or Delete a Group via the Add Members Menu

The Connect Plus radio does not allow a duplicate group number or a duplicate group alias to be placed on a zone scan list (or to be shown as a "scan candidate"). Thus, the list of "scan candidates" described in [step 6](#) and [step 7](#) sometimes changes after adding or deleting a group from the zone scan list.

If your radio has been programmed to allow you to edit the scan list, you can use the Add Members menu to add a group to the scan list of the currently selected zone, or to delete a group from the scan list of the currently selected zone.

- 1 Press  to access the menu.
-



- 2 Press  or  to Scan option and press  to select.
-

- 3 Press  or  to <Add Members> and press  to select.

The display shows Add Members from Zone n (n = the Connect Plus zone number of the first Connect Plus zone in your radio with the same Network ID as your currently selected zone).

- 4 Do one of the following.

- If the group you want to add to the scan list is assigned to a channel selector position in that zone, go to [step 6](#).
- If the group you want to add to the scan list is assigned to a channel selector position in a different Connect Plus zone, go to [step 5](#).

- 5 Press  or  to scroll a list of Connect Plus zones that have the same Network ID as the currently selected zone.

- 6 After locating the Connect Plus zone where the desired group is assigned to a channel selector position, press  to select.

Your radio displays the first entry in a list of groups assigned to a channel position in that zone. The groups on the list are called "scan candidates", because they can be added to the scan list of your currently selected zone (or they are already on the zone scan list).

If the zone does not have any groups that can be added to the scan list, the radio displays No Candidates.

- 7 Press  or  to scroll through the list of candidate groups.

If a plus sign (+) is displayed immediately before the group alias, this indicates the group is currently on the scan list for the selected zone.

If the plus sign (+) is not displayed immediately before the alias, the group is not currently on the scan list, but can be added.

- 8 Press  when the desired group alias is displayed.

If this group is not currently on the scan list for the currently selected zone, the **Add** (Group Alias) message is displayed.

If this group is already on the scan list for the currently selected zone, the **Delete** (Group Alias) message is displayed.

- 9 Press  to accept the displayed message (**Add** or **Delete**).

If deleting a group from the list, you will know the operation is successful because the plus sign (+) will no longer display immediately before the alias.

If adding a group to the list, you will know the operation is successful because the plus sign (+) will display before the alias.

If you are attempting to add a group, and the list is already full, the radio displays **List Full**. If this should occur, it will be necessary to delete a group from the scan list prior to adding a new one.

- 10 When finished, press  as many times as necessary to return to the desired menu.

Understanding Scan Operation



NOTICE:

If the Radio joins a call for a Zone Scan List member from a different Zone and Call Hang Timer expires before you are able to respond, in order to respond, you must navigate to the Zone and Channel of the Scan List Member and start a new call.

There are some circumstances in which you can miss calls for groups that are in your scan list. When you miss a call for one of the following reasons, this does not indicate a problem with your radio. This is a normal scan operation for Connect Plus.

- Scan feature is not turned on (check for the scan icon on the display).
- Scan list member has been disabled via the menu (see [Editing the Scan List on page 245](#)).
- You are participating in a call already.
- No member of the scanned group is registered at your site (Multisite systems only).

Scan Talkback

If your radio scans into a call from the selectable group scan list, and if the **PTT** button is pressed during the scanned call, the operation of the radio depends on whether Scan Talkback was enabled or disabled during radio programming. Check with your dealer or system administrator for more information.

Scan Talkback Disabled

The radio leaves the scanned call and attempts to transmit on the contact for the currently selected channel position. After the Call Hang Time on the currently selected contact expires, the radio returns to the home channel and starts the Scan Hang Time Timer. The radio resumes group scan after its Scan Hang Time Timer expires.

Scan Talkback Enabled

If the **PTT** button is pressed during the Group Hang Time of the scanned call, the radio attempts to transmit to the scanned group.



NOTICE:

If you scan into a call for a group that is not assigned to a channel position in the currently selected zone and you miss the Hang Time of the call, switch to the proper zone and then select the channel position of the group to talk back to that group.

Editing Priority for a Talkgroup

The Priority Monitor feature allows the radio to automatically receive transmission from the talkgroup with higher priority when it is in another call. A tone sounds when the radio switches to the call with higher priority. There are two levels of priority for the talkgroups: P1 and P2. P1 has higher priority than P2.







NOTICE:



If Default Emergency Revert Group ID is configured in MOTOTRBO Connect Plus Option Board CPS, there are three levels of priority for talkgroups: P0, P1, and P2. P0 is the permanent Emergency Revert Group ID and the highest priority. Check with your dealer or system administrator for more information.



1



Press  to access the menu.

2 Press  or  to Scan and press  to select.

3 Press  or  to View/Edit List and press  to select.

4 Press  or  to the required talkgroup and press  to select.

5 Press  or  to Edit Priority and press  to select.

6 Press  or  to the required priority level and press  to select.

The display shows positive mini notice before returning to the previous screen. The priority icon appears on the left of the talkgroup.

Contacts Settings



NOTICE:

You can add, or edit subscriber IDs for Connect Plus Contacts. Deleting subscriber IDs can only be performed by your dealer.

If the Privacy feature is enabled on a channel, you can make a privacy-enabled voice call on that channel. Only target radios with the same Privacy Key, or the same Key Value and Key ID as your radio are able to unscramble the transmission.

Access to Contact Lists depends on the zone configuration:

- If only one zone is configured in the radio, the Contact List directly displays the list from the current selected zone.
- If multiple zones are configured in the radio, the Zone Contact Folder displays all zones with identical network IDs as the current selected zone. The user can access the contacts in these zones.





Contacts provide “address-book” capabilities on your radio. Each entry corresponds to an alias or ID that you use to initiate a call.

Each zone provides a Contact List with up to 100 contacts. The following contact types are available:

- Private Call
- Group Call
- Multigroup Call
- Site All Call Voice
- Site All Call Text
- Dispatch Call

The Dispatch Call contact type is used to send a text message to a dispatcher PC through a third-party Text Message Server.

Making a Private Call from Contacts

- 1 Press  to access the menu.
- 2 Press  or  to `Contacts` and press  to select.
The entries are alphabetically sorted.
- 3 Hold the microphone 1 to 2 inches (2.5 to 5.0 cm) from your mouth.

- 4 Press the **PTT** button to make the call.
The LED lights up solid green.

- 5 Wait for the Talk Permit Tone to finish (if enabled), and speak clearly into the microphone.

- 6 Release the **PTT** button to listen.

When the target radio responds, the LED blinks green and the display shows the transmitting user's ID.





If there is no voice activity for a predetermined period of time, the call ends.

You hear a short tone. The display shows `Call Ended`.



Making a Call Alias Search

You can also use alias or alphanumeric search to retrieve the required subscriber alias.

This feature is only applicable while in Contacts.

- 1 Press  to access the menu.
- 2 Press  or  to **Contacts** and press  to select.

The entries are alphabetically sorted.

- 3 Key in the first character of the required alias, and then press the  or  button to locate the required alias.

- 4 Hold the microphone 1 to 2 inches (2.5 to 5.0 cm) from your mouth.

- 5 Press the **PTT** button to make the call.
The LED lights up solid green. The display shows the destination alias.

- 6 Wait for the Talk Permit Tone to finish (if enabled), and speak clearly into the microphone.





- 7 Release the **PTT** button to listen.



When the target radio responds, the LED blinks green.

If there is no voice activity for a predetermined period of time, the call ends.

The display shows **Call Ended**.



Adding a New Contact

- 1 Press  to access the menu.
- 2 Press  or  to **Contacts** and press  to select.

- 3 Press  or  to **New Contact** and press  to select.

- 4 Use the keypad to enter the contact number and press  to confirm.

- 5 Use the keypad to enter the contact name and press  to confirm.



- 6 If adding a Radio Contact, press  or  to the required ringer type and press  to select. The radio sounds a positive indicator tone and the display shows `Contact Saved`.
-



Call Indicator Settings

This feature allows the radio users to configure call or text message ringing tones.



Activating and Deactivating Call Ringers for Call Alert



You can select, or turn on or off ringing tones for a received Call Alert.

- 1 Press  to access the menu.
-
- 2 Press  or  to `Utilities` and press  to select.
-



- 3 Press  or  to `Radio Settings` and press  to select.
-

- 4 Press  or  to `Tones/Alert` and press  to select.
-

- 5 Press  or  to `Call Ringers` and press  to select.
-

- 6 Press  or  to `Call Alert` and press  to select.

The current tone is indicated by a .



- 7 Press  or  to the required tone and press  to select.



 appears beside selected tone.



Activating and Deactivating Call Ringers for Private Calls



You can turn on or off the ringing tones for a received Private Call.



- 1 Press  to access the menu.

- 2 Press  or  to `Utilities` and press  to select.

- 3 Press  or  to `Radio Settings` and press  to select.

- 4 Press  or  to `Tones/Alerts` and press  to select.

- 5 Press  or  to `Call Ringers` and press  to select.

- 6 Press  or  to `Private Call` and press  to select.

- 7 Press  to enable/disable the Private Call ringing tones.



The display shows  beside `Enabled`, if Private Call ringing tones are enabled.



The  is not displayed when Private Call ringing tones are disabled.



Activating and Deactivating Call Ringers for Text Message



You can turn on or off the ringing tones for a received Text Message.



- 1 Press  to access the menu.

- 2 Press  or  to `Utilities` and press  to select.



3 Press  or  to Radio Settings and press  to select.

4 Press  or  to Tones/Alerts and press  to select.

5 Press  or  to Call Ringers and press  to select.

6 Press  or  to Text Message and press  to select.

The current tone is indicated by a .

7 Press  or  to the required tone and press  to select.

 appears beside selected tone.

Selecting a Ring Alert Type



NOTICE:

The programmed **Ring Alert Type** button is assigned by your dealer or system administrator. Check with your dealer or system administrator to determine how your radio has been programmed.

You can program the radio calls to one predetermined vibrate call. If All Tones status is disabled, the radio displays the All Tone Mute icon. If All Tones status is enabled, the related ring alert type is displayed.

The radio vibrates once if it is a momentary ring style. The radio vibrates repetitively if it is a repetitive ring style. When set to Ring and Vibrate, the radio sounds a specific ring tone if there is any incoming radio transaction (for example, Call Alert or Message). It sounds like a positive indicator tone or missed call.

Escalating Alarm Tone Volume

You can program your radio to continually alert you when a radio call remains unanswered. This is done by

automatically increasing the alarm tone volume over time. This feature is known as Escalert.

Call Log

Your radio keeps track of all recent outgoing, answered, and missed Private Calls. Use the call log feature to view and manage recent calls.



You can perform the following tasks in each of your call lists:



- Delete
- View Details
- Store

Viewing Recent Calls

The lists are Missed, Answered, and Outgoing.

- 1 Press  to access the menu.

- 2 Press  or  to Call Log and press  to select.

- 3 Press  or  to preferred list and press  to select.



The display shows the most recent entry at the top of the list.



- 4 Press  or  to view the list.

Press the **PTT** button to start a Private Call with the current selected alias or ID.



Deleting a Call from a Call List



- 1 Press  to access the menu.

- 2 Press  or  to Call Log and press  to select.





- 3 Press  or  to the required list and press  to select.

When you select a call list and it contains no entries, the display shows **List Empty**, and sounds a low tone if Keypad Tones are turned on .

4 Press  or  to the required alias or ID and press  to select.



5 Press  or  to **Delete** and press  to select.



6 Do one of the following:



- Press  to select **Yes** to delete the entry. The display shows **Entry Deleted**.
- Press  or  to **No**, and press the  button to return to the previous screen.



Viewing Details from a Call List

1 Press  to access the menu.

2 Press  or  to **Call Log** and press  to select.

3 Press  or  to the required list and press  to select.

4 Press  or  to the required alias or ID and press  to select.

5 Press  or  to **View Details** and press  to select.
Display shows details of call list.

Call Alert Operation

Call Alert paging enables you to alert a specific radio user to call you back when they are able to do so.

This feature is accessible through the menu by using **Contacts**, manual dial or a programmed **One Touch Access** button.

Responding to Call Alerts

Follow the procedure to respond to Call Alerts on your radio.

When you receive a Call Alert:

- A repetitive tone sounds.
- The yellow LED blinks.
- The display shows the notification list listing a Call Alert with the alias or ID of the calling radio.



Depending on the configuration by your dealer or system administrator, you can respond to a Call Alert by doing one of the following:







- Press the **PTT** button and respond with a Private Call directly to the caller.
- Press the **PTT** button to continue normal talkgroup communication. The Call Alert is moved to the Missed Call option at the Call Log menu. You can respond to the caller from the Missed Called log.



See [Notification List on page 180](#) and [Call Log Features on page 122](#) for more information.

Making a Call Alert from the Contact List

- 1 Press  to access the menu.

- 2 Press  or  to `Contacts` and press  to select.

- 3 Use one of the steps described next to select the required subscriber alias or ID:
 - select the subscriber alias directly
 - Press  or  to the required subscriber alias and press  to select.
 - use the `Manual Dial` menu
 - Press  or  to `Manual Dial` and press  to select.
 - The `Manual Dial` text entry screen shall be displayed. Enter the Subscriber ID and press  .

- 4 Press  or  to Call Alert and press  to select.

The display shows Call Alert: <Subscriber Alias or ID>Call Alert and the subscriber alias or ID, indicating that the Call Alert has been sent.

The LED lights up solid green when your radio is sending the Call Alert.

If the Call Alert acknowledgement is received, the display shows Call Alert Successful.

If the Call Alert acknowledgement is not received, the display shows Call Alert Failed.

The LED lights up solid green when your radio is sending the Call Alert.

If the Call Alert acknowledgement is received, the display shows Call Alert Successful.

If the Call Alert acknowledgement is not received, the display shows Call Alert Failed.

Making a Call Alert with the One Touch Access Button

Press the programmed **One Touch Access** button to make a Call Alert to the predefined alias.

The display shows Call Alert and the subscriber alias or ID, indicating that the Call Alert has been sent.

Mute Mode

Mute Mode provides an option to the user to silence all audio indicators of the radio.

Once Mute Mode feature is initiated, all audio indicators are muted except higher priority features such as Emergency operations.

When Mute Mode is exited, the radio resumes playing ongoing tones and audio transmissions.



NOTICE:

This is a purchasable feature. Check with your dealer or system administrator for more information.

Turning On Mute Mode

Follow the procedure to turn on Mute Mode.

Access this feature by using the programmed **Mute Mode** button.

The following occurs when Mute mode is enabled:



- Positive Indicator Tone sounds.
- Display shows Mute Mode On.
- The red LED light starts blinking and remains blinking until Mute Mode is exited.
- Display shows **Mute Mode** icon on home screen.
- Radio is muted.
- Mute Mode Timer begins counting down the duration that is configured.



Setting Mute Mode Timer



Mute Mode feature can be enabled for a pre-configured amount of time by setting the Mute Mode Timer. The timer duration is configured in the radio menu and can range between 0.5–6 hours. Mute Mode is exited once the timer expires.



If the timer is left at 0, the radio remains in Mute mode for an indefinite period until the programmed **Mute Mode** button is pressed.

- 1 Press  to access the menu.

- 2 Press  or  to Utilities. Press  to select.

- 3 Press  or  to Radio Settings. Press  to select.

- 4 Press  or  to Mute Timer. Press  to select.

- 5 Press  or  to edit the numeric value of each digit, and press .

Exiting Mute Mode

This feature can be exited automatically once the Mute Mode Timer expires.

Do one of the following to exit Mute mode manually:

- Press the programmed **Mute Mode** button.
- Press the **PTT** button on any entry.

The following occurs when Mute mode is disabled:

- Negative Indicator Tone sounds.
- Display shows `Mute Mode Off`.
- The blinking red LED turns off.
- **Mute Mode** icon disappears from home screen.
- Your radio unmutes and speaker state is restored.
- If the timer has not expired, Mute mode timer is stopped.



NOTICE:

Mute Mode is also exited if the user transmits voice or switches to an unprogrammed channel.

Emergency Operation



NOTICE:

If your radio is programmed for Silent or Silent with Voice emergency initiation, in most cases it automatically exits silent operation after the Emergency Call or Emergency Alert is finished. The exception to this rule is when Emergency Alert is the configured Emergency Mode and Silent is the configured Emergency Type. If your radio is programmed in this manner, the silent operation continues until you cancel silent operation by pressing **PTT** or the button configured for Emergency Off.

Emergency voice calls and Emergency Alerts are not supported when operating in Connect Plus Auto Fallback mode. For more information see the [Auto Fallback on page 238](#).

An Emergency Alert is used to indicate a critical situation. You can initiate an Emergency at any time on any screen display, even when there is activity on the current channel. Pressing the **Emergency** button initiates the programmed Emergency mode. The programmed Emergency mode may also be initiated by triggering the optional Man Down feature. The Emergency feature may be disabled in your radio.

Your dealer can set the duration of a button press for the programmed **Emergency** button, except for long press, which is similar with all other buttons:

Short press

Between 0.05 seconds and 0.75 seconds.

Long press

Between 1.00 second and 3.75 seconds.

The **Emergency** button is assigned with the Emergency On/Off feature. Check with your dealer for the assigned operation of the **Emergency** button.

- If the short press for the **Emergency** button is assigned to turn on the Emergency mode, then the long press for the **Emergency** button is assigned to exit the Emergency mode.
- If the long press for the **Emergency** button is assigned to turn on the Emergency mode, then the short press for the **Emergency** button is assigned to exit the Emergency mode.

When your radio is selected to a Connect Plus zone, it supports three Emergency modes:

Emergency Call

You must press the **PTT** button to talk on the assigned emergency time slot.

Emergency Call with Voice to Follow

For the first transmission on the assigned emergency time slot, the microphone is automatically unmuted and you may talk without pressing the **PTT** button. The microphone stays “hot” in this fashion for a time period programmed into the radio. For subsequent transmissions in the same Emergency call, you must press the **PTT** button.

Emergency Alert

An Emergency Alert is not a voice call. It is an emergency notification that is sent to radios that are configured to receive these alerts. The radio sends an emergency alert by using the control channel of the currently registered site. The Emergency Alert is received by radios in the Connect Plus network that are programmed to receive them (no matter which network site they are registered to).

Only one of the Emergency Modes can be assigned to the Emergency button per zone. In addition, each Emergency mode has the following types:

Regular

Radio initiates an Emergency and shows audio and/or visual indicators.

Silent

Radio initiates an Emergency without any audio or visual indicators. The radio suppresses all audio or visual indications of the Emergency until you press the **PTT** button to start a voice transmission.

Silent with Voice

The same as Silent operation, except that the radio also unmutes for some voice transmissions.

Receiving an Incoming Emergency

Your radio may be programmed to sound an alert tone and also display information about the incoming Emergency. If so programmed, upon receiving the incoming Emergency, the display shows the Emergency Details screen with the emergency icon, the Alias or ID of the radio that requested the Emergency, the Group Contact being used for the Emergency, and one additional line of information. The additional information is the name of the zone that contains the Group Contact.

At the present time, the radio displays only the most recently decoded Emergency. If a new Emergency is received before the prior Emergency is cleared, the details for the new Emergency replace the details of the previous Emergency.

Depending on how your radio has been programmed, the Emergency Details screen (or Alarm List screen) will stay on your radio display even after the Emergency ends. You can save the emergency details to the Alarm List, or you can delete the emergency details as described in the following sections.

Saving the Emergency Details to the Alarm List

Saving the emergency details to the Alarm List allows you to view the details again at a later time by selecting Alarm List from the Main Menu.

- 1 While the Emergency Details (or Alarm List) screen is displayed, press  .
The **Exit Alarm List** screen displays.

-
- 2 Perform one of the following actions:
 - Select **Yes** and press  to save the emergency details to the Alarm List, and to exit the Emergency Details (or Alarm List) screen.



- Select **No** and press  to return to the Emergency Details (or Alarm List) screen.
-

Deleting the Emergency Details

- 1 While the Emergency Details screen is displayed, press  .

The **Delete** screen displays.

- 2 Perform one of the following actions:

- Select **Yes** and press  to delete the emergency details.
 - Select **No** and press  to return to the Emergency Details screen.
-

Responding to an Emergency Call



NOTICE:

If you do not respond to the Emergency Call within the time allotted for the Emergency Call Hang Time, the Emergency call will end. If you want to speak to the group after the Emergency Call Hang Time expires, you must first select the channel position assigned to the group (if not already selected). Then, press **PTT** to start a non-Emergency Call to the group.

- 1 When receiving an Emergency Call, press any button to stop all Emergency Call received indications.

 - 2 Press the **PTT** button to initiate a voice transmission on the Emergency group.
All radios that are monitoring this group hear your transmission.

 - 3 Wait for the Talk Permit Tone to finish (if enabled) and speak clearly into the microphone.
The LED lights up green.
-

4 Release the **PTT** button to listen.

When the emergency initiating radio responds, the LED blinks green. You see the Group Call icon, the group ID, and transmitting radio ID on your display.

Responding to an Emergency Alert



NOTICE:

The Group contact used for the Emergency Alert should not be used for voice communication. This could prevent other radios from sending and receiving Emergency Alerts on the same group.

An Emergency Alert from a radio indicates that the user is in an urgent situation. You may respond to the alert by initiating a private call to the radio who declared the emergency, initiating a group call to a designated talk group, sending the radio a Call Alert, initiating a Remote Monitor of that radio, etc. The proper response is determined by your organization and the individual situation.

Ignore Emergency Revert Call

This feature enhancement is to provide an option for the radio to ignore an active Emergency Revert Call.

To enable Ignore Emergency Revert Call, the radio must be configured at the Connect Plus Customer Programming Software (CPCPS).

When the feature is enabled, the radio does not display Emergency Call indications and does not receive any audio on the default Emergency Revert Group ID.

Check with your dealer or system administrator for more information.

Initiating an Emergency Call



NOTICE:

If your radio is set to Silent, it does not display any audio or visual indicators during Emergency mode until you press the **PTT** button to initiate a voice transmission.

If your radio is set to Silent with Voice, it does not initially display any audio or visual indicators that the radio is in Emergency mode. However, your radio unmutes for the transmissions of radios responding to your emergency. The emergency indicators only appear once you press the **PTT** button to initiate a voice transmission from your radio.

For both "Silent" and "Silent with Voice" operation, the radio automatically exits silent operation after the Emergency Call is finished.

- 1 Press the programmed **Emergency** button.
- 2 Press the **PTT** button to initiate a voice transmission on the Emergency group.

When you release the **PTT** button, the Emergency call continues for the time allotted for the Emergency Call Hang Time.

If you press the **PTT** button during this time, the Emergency call continues.

Initiating an Emergency Call with Voice to Follow

Your radio must be programmed for this type of operation.

When enabled for this operation, when you press the programmed **Emergency** button, and when your radio receives the time slot assignment, the microphone is automatically activated without pressing the **PTT** button. This activated microphone state is also known as "hot mic". The "hot mic" applies to the first voice transmission from your radio during the Emergency call. For subsequent transmissions in the same Emergency call, you must press the **PTT** button.

- 1 Press the programmed **Emergency** button.
- 2 The microphone remains active for the "hot mic" time specified in your radio codeplug programming.
During this time, the LED lights up green.

- 3 Press and hold the **PTT** button to talk longer than the programmed duration.
-

Initiating an Emergency Alert



NOTICE:

If your radio is programmed for "Silent" or "Silent with Voice", it will not provide any audio or visual indications that it is sending an Emergency Alert. If programmed for "Silent", the silent operation continues indefinitely until you press PTT or the button configured for "Emergency Off". If programmed for "Silent with Voice", the radio automatically cancels silent operation when the site controller broadcasts the Emergency Alert.

Press the orange **Emergency** button.

Upon transmitting the Emergency Alert to the site controller, the radio display shows the Emergency icon, the Group contact used for the Emergency Alert, and TX Alarm.

Once the Emergency Alert is successfully sent and is being broadcast for other radios to hear, a positive indicator tone sounds and the radio displays Alarm Sent. If the

Emergency Alert is unsuccessful, a negative indicator tone sounds and the radio displays Alarm Failed.

Exiting Emergency Mode



NOTICE:

If the Emergency call ends due to the expiration of the Emergency Hang Time, but the emergency condition is not over, press the **Emergency** button again to restart the process.

If you initiate an Emergency Alert by pressing the programmed **Emergency** button, your radio automatically exits Emergency mode after receiving a response from the Connect Plus system.

If you initiate an Emergency call by pressing the programmed **Emergency** button, your radio will be assigned a channel automatically when one becomes available. Once your radio has transmitted a message indicating the emergency, you cannot cancel your Emergency call. However, if you pressed the button by accident or the emergency no longer exists, you may wish to say this over the assigned channel. When you release the **PTT** button, the Emergency call is discontinued after the Emergency Call Hang Time expires.

If your radio was configured for Emergency with Voice to Follow, use the “hot mic” period to explain your error, then press and release the **PTT** button to discontinue the transmission. The Emergency call is discontinued after the Emergency Call Hang Time expires.

Text Messaging

Your radio is able to receive data, for example a text message, from another radio or a text message application.

There are two types of text messages, Digital Mobile Radio (DMR) Short Text Message and text message. The maximum length of a DMR Short Text Message is 23 characters. The maximum length of a text message is 280 characters, including the subject line. The subject line only appears when you receive messages from e-mail applications.



NOTICE:







The maximum character length is only applicable for models with the latest software and hardware. For radio models with older software and hardware, the maximum length of a text message is 140 characters. Check with your dealer or system administrator for more information.

Sending a Quick Text Message

Your radio supports a maximum of 10 Quick Text messages as programmed by your dealer.

While Quick Text messages are predefined, you can edit each message before sending it.

If you are sending the message, perform the following to select a recipient:

- Press  or  to the required alias and press  to select.
- Press  or  to Manual Dial, and press  to select. The first line of the display shows Number: . The second line of the display shows a blinking cursor. Key in the subscriber alias or ID and press .

The display shows `Sending Message`, confirming your message is being sent.

If the message is sent successfully, a tone sounds and the display shows `Message Sent`.

If the message cannot be sent, a low tone sounds and the display shows `Message Send Failed`.

If the text message fails to send, the radio returns you to the `Resend` option screen (see [Managing Fail-to-Send Text Messages on page 272](#)).

Sending a Quick Text Message with the One Touch Access Button

You can send Quick Text messages using the programmable button programmed by your dealer.

Press the programmed **One Touch Access** button to send a predefined Quick Text message to a predefined alias.

The display shows `Sending Message`, confirming your message is being sent.

If the message is sent, a tone sounds and the display shows `Message Sent`.

If the message cannot be sent, a low tone sounds and the display shows `Message Send Failed`.

If the text message fails to send, the radio returns you to the `Resend` option screen (see [Managing Fail-to-Send Text Messages on page 272](#)).

Accessing the Drafts Folder

The Drafts folder stores a maximum of ten (10) last saved messages. When the folder is full, the next saved text message automatically replaces the oldest text message in the folder.







NOTICE:



You can edit saved text message before sending it. Only available with a keypad microphone (see [Editing and Sending a Saved Text Message on](#)



[page 270](#). Long press  at any time to return to the Home screen.

Viewing a Saved Text Message

- 1 Access the **Text Message** feature.



Radio Controls	Steps
Programmed Text Message button	Press the programmed Text Message button.
Menu	<p>a Press  to access the menu.</p> <p>b Press  or  to Messages and press  to select.</p>

2 Press  or  to Drafts and press  to select.

3 Press  or  to the required message and press  to select.





Editing and Sending a Saved Text Message

1 Press  again while viewing the message.

2 Press  or  to Edit and press  to select.

A blinking cursor appears.







3 Use the keypad to type your message.

Press  to move one space to the left. Press  or the  key to move one space to the right. Press the  key to delete any unwanted characters.

Long press  to change text entry method.

4 Press  once message is composed.

5 Select the message recipient by:

- Press  or  to the required alias and press  to select.
- Press  or  to Manual Dial, and press  to select. The first line of the display shows Number:1. The second line of the display shows a blinking cursor. Key in the subscriber alias or ID and press .

The display shows Sending Message, confirming your message is being sent.





If the message is sent successfully, a tone sounds and the display shows Message Sent.



If the message cannot be sent, a low tone sounds and the display shows Message Send Failed.



If the text message cannot be sent, it is moved to the Sent Items folder and marked with a Send Failed icon.



Deleting a Saved Text Message from Drafts

- 1 Access the **Text Message** feature.

Radio Controls	Steps
Programmed Text Message button	Press the programmed Text Message button.
Menu	<ol style="list-style-type: none"> Press  to access the menu. Press  or  to Messages and press  to select.

- 2 Press  or  to Drafts and press  to select.

3 Press  or  to the required message and press  to select.

4 Press  or  to Delete and press  to delete the text message.

Managing Fail-to-Send Text Messages

You can select one of the following options while at the Resend option screen:

- Resend
- Forward
- Edit

Resending a Text Message



Press  to resend the same message to the same subscriber/group alias or ID.



If the message is sent successfully, a tone sounds and the display shows the positive mini notice.

If the message cannot be sent, the display shows the negative mini notice.

Forwarding a Text Message

Select Forward to send the message to another subscriber/group alias or ID.

1 Press  or  to Forward and press  to select.

2 To select the message recipient, press  or  to the required alias or ID and press  to select.

The display shows `Sending Message`, confirming your message is being sent.

If the message is sent successfully, a tone sounds and the display shows `Message Sent`.

If the message cannot be sent, a low tone sounds and the display shows `Message Send Failed`.

Managing Sent Text Messages

Once a message is sent to another radio, it is saved in Sent Items. The most recent sent text message is always added to the top of the Sent Items list.

The Sent Items folder is capable of storing a maximum of 30 last sent messages. When the folder is full, the next sent text message automatically replaces the oldest text message in the folder.



NOTICE:

Long press at any time to return to the Home screen.

Viewing a Sent Text Message

- 1 Access the **Text Message** feature.

Radio Controls	Steps
Programmed Text	Press the programmed Text Message button.

Radio Controls	Steps
Message button	
Menu	<p>a Press to access the menu.</p> <p>b Press or to Messages and press to select.</p>

- 2 Press or to Sent Items and press to select.

- 3 Press or to the required message and press to select.



The icon at the top right corner of the screen indicates the status of the message (see [Sent Item Icons on page 218](#)).

Sending a Sent Text Message

You can select one of the following options while viewing a sent text message:

- Resend
- Forward
- Edit
- Delete

1 Press  again while viewing the message.

2  or  to one of the following options and press  to select.

Option	Steps
Forward	Select Forward to send the selected text message to another subscriber/group alias or ID (see Forwarding a Text Message on page 272).
Delete	Select Delete to delete the text message.

Option	Steps
Resend	<p>Select Resend to resend the selected text message to the same subscriber/group alias or ID.</p> <p>The display shows Sending Message, confirming that the same message is being sent to the same target radio.</p> <p>If the message is sent successfully, a tone sounds and the display shows Message Sent.</p> <p>If the message cannot be sent, a low tone sounds and the display shows Message Send Failed.</p> <p>If the message fails to send, the radio returns you to the Resend option screen. Press  to resend the message to the same subscriber/group alias or ID.</p>

If you exit the message sending screen while the message is being sent, the radio updates the status

of the message in the Sent Items folder without any audio or visual indication.

If the radio changes mode or powers down before the status of the message in Sent Items is updated, the radio cannot complete any In-Progress messages and automatically marks it with a **Send Failed** icon.





The radio supports a maximum of five In-Progress messages at one time. During this period, the radio cannot send any new message and automatically marks it with a **Send Failed** icon.



Deleting All Sent Text Messages from Sent Items

- 1 Access the **Text Message** feature.



Radio Controls	Steps
Programmed Text Message button	Press the programmed Text Message button.



[Send Feedback](#)



Radio Controls	Steps
Menu	<ol style="list-style-type: none"> a Press  to access the menu. b Press  or  to Messages and press  to select.

- 2 Press  or  to Sent Items and press  to select.

When you select Sent Items and it contains no text messages, the display shows List Empty, and sounds a low tone if Keypad Tones are turned on.

- 3 Press  or  to Delete All and press  to select.

- 4 Choose one of the following.
 - Press  or  to Yes and press  to select. The display shows positive mini notice.

- Press  or  to No and press  to return to the previous screen.



Receiving a Text Message

When your radio receives a message, the display shows the Notification List with the alias or ID of the sender and the Message icon.

You can select one of the following options when receiving a text message:



- Read
- Read Later
- Delete

Reading a Text Message

- 1 Press  or  to Read? and press  to select.

Selected message in the Inbox opens.

- 2 Do one of the following:

- Press  to return to the Inbox.
- Press  a second time to reply, forward, or delete the text message.

Managing Received Text Messages

Use the Inbox to manage your text messages. The Inbox is capable of storing a maximum of 30 messages.

Text messages in the Inbox are sorted according to the most recently received.

Your radio supports the following options for text messages:

- Reply (via Quick Text)
- Forward
- Delete
- Delete All







NOTICE:



If the channel type is not a match, you can only forward, delete, or delete all Received messages.



Long press  at any time to return to the Home screen.



Viewing a Text Message from the Inbox

- 1 Press  to access the menu.

- 2 Press  or  to **Messages** and press  to select.





- 3 Press  or  to **Inbox** and press  to select.



- 4 Press  or  to view the messages.



- 5 Do one of the following:
 - Press  to select the current message, and press  again to reply, forward, or delete that message.
 - Long press  to return to the Home screen.

Replying to a Text Message from the Inbox

- 1 Access the **Text Message** feature.

Radio Controls	Steps
Programmed Text Message button	Press the programmed Text Message button.
Menu	<ol style="list-style-type: none"> a Press  to access the menu. b Press  or  to Messages and press  to select.

- 2 Press  or  to **Inbox** and press  to select.

3 Press  or  to the required message and press  to select.

4 Press  once more to access the sub-menu.

5 Use your keypad to write/edit your message.

6 Press  once message is composed.

The display shows `Sending Message`, confirming your message is being sent.





If the message is sent successfully, a tone sounds and the display shows `Message Sent`.



If the message cannot be sent, a low tone sounds and the display shows `Message Send Failed`.



If the message cannot be sent, the radio returns you to the `Resend` option screen (see [Managing Fail-to-Send Text Messages on page 272](#)).

Deleting a Text Message from the Inbox



1 Access the **Text Message** feature.

Radio Controls	Steps
Programmed Text Message button	Press the programmed Text Message button.
Menu	<p>a Press  to access the menu.</p> <p>b Press  or  to <code>Messages</code> and press  to select.</p>

2 Press  or  to `Inbox` and press  to select.

3 Press  or  to the required message and press  to select.

4 Press  once more to access the sub-menu.

5 Press  or  to Delete and press  to select.





6 Press  or  to Yes and press  to select.



The display shows Message Deleted, and the screen returns to the Inbox.

Deleting All Text Messages from the Inbox



1 Access the **Text Message** feature.

Radio Controls	Steps
Programmed Text Message button	Press the programmed Text Message button.

Radio Controls	Steps
Menu	<p>a Press  to access the menu.</p> <p>b Press  or  to Messages and press  to select.</p>

2 Press  or  to Inbox and press  to select.

When you select Inbox and it contains no text messages, the display shows List Empty, and sounds a low tone if Keypad Tones are turned on (see [Turning Keypad Tones On or Off on page 191](#)).

3 Press  or  to Delete All and press  to select.

- 4 Press  or  to Yes and press  to select.

The display shows `Inbox Cleared`.

Privacy

If enabled, this feature helps to prevent eavesdropping by unauthorized users on a channel by the use of a software-based scrambling solution. The signaling and user identification portions of a transmission are not scrambled.

Your radio must have privacy enabled on the current channel selector position to send a privacy-enabled transmission, although this is not a necessary requirement for receiving a transmission. While on a privacy-enabled channel selector position, the radio is still able to receive clear (unscrambled) transmissions.

Your radio supports Enhanced Privacy.

To unscramble a privacy-enabled call transmission, your radio must be programmed to have the same Key Value and Key ID (for Enhanced Privacy) as the transmitting radio.

If your radio receives a scrambled call that is of a different Key Value and Key ID, you hear nothing at all (Enhanced Privacy).

If the radio has a privacy type assigned, the Home screen shows the Secure or Unsecure icon, except when the radio is sending or receiving an Emergency call or alarm.

The LED lights up solid green while the radio is transmitting and blinks green rapidly when the radio is receiving an ongoing privacy-enabled transmission.

You can access this feature by performing one of the following actions:



- Press the programmed **Privacy** button to toggle privacy on or off.
- Using the Radio Menu as described by the steps described next.







NOTICE:

Some radio models may not offer this Privacy feature. Check with your dealer or system administrator for more information.

- 1 Press  to access the menu.
-

2 Press  or  to Utilities and press  to select.

3 Press  or  to Radio Settings or  or  to Connect Plus and press  to select.

4 Press  or  to Enhanced Privacy.

If the display shows Turn On, press  to enable Privacy. The radio displays a message confirming your selection.

If the display shows Turn Off, press  to disable Privacy. The radio displays a message confirming your selection.

If the radio has a privacy type assigned, the secure or unsecure icon appears on the status bar, except when the radio is sending or receiving an Emergency Alert.

Making a Privacy-Enabled (Scrambled) Call

Toggle privacy on using the programmed privacy button or by using the menu. Your radio must have the Privacy feature enabled for the currently selected channel position to send a privacy-enabled transmission. When privacy is enabled for the currently selected channel position, all voice transmissions made by your radio will be scrambled. This includes Group Call, Multigroup Call, talk-back during scanned calls, Site All Call, Emergency Call, and Private Call. Only receiving radios with the same Key Value and Key ID as your radio will be able to unscramble the transmission.

Security

You can enable or disable any radio in the system. For example, you might want to disable a stolen radio, to prevent the thief from using it, and enable that radio, when it is recovered.



















NOTICE:





Performing Radio Disable and Enable is limited to radios with these functions enabled. Check with your dealer or system administrator for more information.

Radio Disable

- 1 Access this feature by performing one of the following actions:

Radio Controls	Steps
Radio Disable button	<p>a Press the programmed Radio Disable button.</p> <p>b Press  or  to the required alias or ID and press  to select.</p>
Radio menu	<p>a Press  to access the menu.</p> <p>b Press  or  to Contacts and press  to select. The entries are alphabetically sorted.</p>

Radio Controls	Steps
	<p>c Use one of the steps described next to select the required subscriber alias or ID:</p> <ul style="list-style-type: none"> • Select the required alias or ID directly. <ul style="list-style-type: none"> • Press  or  to the required alias or ID and press  to select. • Use the Manual Dial menu. <ul style="list-style-type: none"> • Press  or  to Manual Dial and press  to select. • Press  or  to Radio Number and press  to select.

Radio Controls	Steps
	<ul style="list-style-type: none"> The first line of the display shows <code>Radio Number:</code>. The second line of the display shows a blinking cursor. Use the keypad to enter the subscriber alias or ID and press . <p>d Press  or  to <code>Radio Disable</code> and press  to select.</p>

The display shows `Radio Disable: <Target Alias or ID>` and the LED blinks green.







2 Wait for acknowledgement.







If successful, a positive indicator tone sounds and the display shows `Radio Disable Successful`.







If not successful, a negative indicator tone sounds and the display shows `Radio Disable Failed`.

Radio Enable

- 1 Access this feature by performing one of the following actions:

Radio Controls	Steps
Radio Enable button	<ol style="list-style-type: none"> Press the programmed Radio Enable button. Press  or  to the required alias or ID and press  to select.
Radio menu	<ol style="list-style-type: none"> Press  to access the menu. Press  or  to <code>Contacts</code> and press  to select. The entries are alphabetically sorted.

Radio Controls	Steps
	<p>c Use one of the steps described next to select the required subscriber alias or ID</p> <ul style="list-style-type: none"> • Select the required alias or ID directly. <ul style="list-style-type: none"> • Press  or  to the required alias or ID and press  to select. • Use the Manual Dial menu. <ul style="list-style-type: none"> • Press  or  to Manual Dial and press  to select.

Radio Controls	Steps
	<ul style="list-style-type: none"> • Press  or  to Radio Number and press  to select. • The first line of the display shows Radio Number!. The second line of the display shows a blinking cursor. Use the keypad to enter the subscriber alias or ID and press . <p>d Press  or  to Radio Enable and press  to select.</p>

The display shows Radio Enable: <Subscriber Alias or ID> and the LED lights up solid green.

2 Wait for acknowledgement.

If successful, a positive indicator tone sounds and the display shows `Radio Enable Successful`.

If not successful, a negative indicator tone sounds and the display shows `Radio Enable Failed`.

Bluetooth Operation



NOTICE:

If disabled via the CPS, all Bluetooth-related features are disabled and the Bluetooth device database is erased.

This feature allows you to use your radio with a Bluetooth-enabled device (accessory) via a wireless Bluetooth connection. Your radio supports both Motorola Solutions and Commercially available Off-The-Shelf (COTS) Bluetooth-enabled devices.

Bluetooth operates within a range of 10 meters (32 feet) line of sight. This is an unobstructed path between your radio and your Bluetooth-enabled device.





It is not recommended that you leave your radio behind and expect your Bluetooth-enabled device to work with a high degree of reliability when they are separated.



At the fringe areas of reception, both voice and tone quality will start to sound "garbled" or "broken". To correct this problem, simply position your radio and Bluetooth-enabled device closer to each other (within the 10-meter/32 feet defined range) to re-establish clear audio reception. Your radio's Bluetooth function has a maximum power of 2.5 mW (4 dBm) at the 10-meter/32 feet range.

Your radio can support up to 4 simultaneous Bluetooth connections with Bluetooth-enabled devices of unique types. For example, a headset, and a PTT-Only Device (POD). Multiple connections with Bluetooth-enabled devices of the same type are not supported.

Refer to your respective Bluetooth-enabled device's user manual for more details on your Bluetooth-enabled device's full capabilities.









Turning Bluetooth On and Off

- 1 Press  to access the menu.
-
- 2 Press  or  to Bluetooth and press  to select.
-

- 3 Press  or  to **My Status** and press  to select.

The display shows **On** and **Off**. The current status is indicated by a .

- 4 Do one of the following:

- Press  or  to **On** and press  to select. The display shows **On** and a  appears left of the selected status.
- Press  or  to **Off** and press  to select. The display shows **Off** and a  appears left of the selected status.



Finding and Connecting to a Bluetooth Device



Do not turn off your Bluetooth-enabled device or press

 during the finding and connecting operation as this cancels the operation.









- 1 Turn on your Bluetooth-enabled device and place it in pairing mode. Refer to respective Bluetooth-enabled device user manual.



- 2 On your radio, press  to access the menu.

- 3 Press  or  to **Bluetooth** and press  to select.

- 4 Press  or  to **Devices** and press  to select.

- 5 Do one of the following:

- Press  or  to the required device and press  to select.
- Press  or  to **Find Devices** to locate available devices. Press  or  to the required device and press  to select.

- 6 Press  or  to Connect and press  to select.

Display shows Connecting to <Device>. Your Bluetooth-enabled device may require additional steps to complete the pairing. Refer to respective Bluetooth-enabled device user manual.

If successful, the radio display shows <Device>Connected. A tone sounds and  appears besides the connected device. The Bluetooth Connected icon appears on the status bar.

If unsuccessful, the radio display shows Connecting Failed.



Finding and Connecting from a Bluetooth Device (Discoverable Mode)



Do not turn off your Bluetooth or your radio during the finding and connecting operation as this may cancel the operation.

- 1 Turn Bluetooth On.
See [Turning Bluetooth On and Off on page 285](#).

[Send Feedback](#)

- 2 Press  to access the menu.

- 3 Press  or  to Bluetooth and press  to select.

- 4 Press  or  to Find Me and press  to select.



Your radio can now be found by other Bluetooth-enabled devices for a programmed duration. This is called Discoverable Mode.



- 5 Turn on your Bluetooth-enabled device and pair it with your radio.



Refer to respective Bluetooth-enabled device user manual.



Disconnecting from a Bluetooth Device

- 1 On your radio, press  to access the menu.

2 Press  or  to Bluetooth and press  to select.

3 Press  or  to Devices and press  to select.

4 Press  or  to the required device and press  to select.

5 Press  or  to Disconnect and press  to select.

Display shows Disconnecting from <Device>. Your Bluetooth-enabled device may require additional steps to disconnect. Refer to respective Bluetooth-enabled device user manual.

The radio display shows <Device> Disconnected. A positive indicator tone sounds and ✓ disappears beside the connected device. The Bluetooth Connected icon disappears on the status bar.

Switching Audio Route between Internal Radio Speaker and Bluetooth Device



You can toggle audio routing between internal radio speaker and external Bluetooth-enabled accessory.



Press the programmed **Bluetooth Audio Switch** button.



- A tone sounds and display shows Route Audio to Radio.
- A tone sounds and display shows Route Audio to Bluetooth.



Viewing Device Details

1 Press  to access the menu.

2 Press  or  to Bluetooth and press  to select.

3 Press  or  to Devices and press  to select.



4 Press  or  to the required device and press  to select.



5 Press  or  to View Details and press  to select.



Deleting Device Name



You can remove a disconnected device from the list of Bluetooth-enabled devices.

1 Press  to access the menu.

2 Press  or  to Bluetooth and press  to select.

3 Press  or  to Devices and press  to select.

4 Press  or  to the required device and press  to select.



5 Press  or  to Delete and press  to select.

The display shows Device Deleted.



Bluetooth Mic Gain

Allows control of the connected Bluetooth-enabled device microphone gain value.



1 Press  to access the menu.

2 Press  or  to Bluetooth and press  to select.

3 Press  or  to BT Mic Gain and press  to select.

4 Press  or  to the BT Mic Gain type and the current values.

To edit values, press  to select.

5 Press  or  to increase or to decrease values and press  to select.

Indoor Location











NOTICE:

Indoor Location feature is applicable for models with the latest software and hardware. Check with your dealer or system administrator for more information.

Indoor Location is be used to keep track of the location of radio users. When Indoor Location is activated, the radio is in a limited discoverable mode. Dedicated beacons are used to locate the radio and determine its position.

Turning Indoor Location On or Off

You can turn on or turn off Indoor Location by performing one of the following actions.

- Access this feature through the menu.
 - a. Press  to access the menu.
 - b. Press  or  to Bluetooth and press  to select.
 - c. Press  or  to Indoor Location and press  to select.
 - d. Press  to turn on Indoor Location.

The display shows Indoor Location On. You hear a positive indicator tone. One of the following scenarios occurs.

- If successful, the Indoor Location Available icon appears on the Home screen display.

- If unsuccessful, the display shows `Turning On Failed`. You hear a negative indicator tone.

e. Press  to turn off Indoor Location.

The display shows `Indoor Location Off`. You hear a positive indicator tone.

One of the following scenarios occurs.

- If successful, the Indoor Location Available icon disappears on the Home screen display.
- If unsuccessful, the display shows `Turning Off Failed`. You hear a negative indicator tone.

- Access this feature by using the programmed button.

a. Long press the programmed **Indoor Location** button to turn on Indoor Location.

The display shows `Indoor Location On`. You hear a positive indicator tone.

One of the following scenarios occurs.

- If successful, the Indoor Location Available icon appears on the Home screen display.

- If unsuccessful, the display shows `Turning On Failed`. If unsuccessful, you hear a negative indicator tone.

b. Press the programmed **Indoor Location** button to turn off Indoor Location.

The display shows `Indoor Location Off`. You hear a positive indicator tone.



One of the following scenarios occurs.



- If successful, the Indoor Location Available icon disappears on the Home screen display.
- If unsuccessful, the display shows `Turning Off Failed`. If unsuccessful, you hear a negative indicator tone.



Accessing Indoor Location Beacons Information

Follow the procedure to access Indoor Location beacons information.

- 1 Press  to access the menu.

2 Press  or  to Bluetooth and press  to select.

3 Press  or  to Indoor Location and press  to select.

4 Press  or  to Beacons and press  to select.

The display shows the beacons information.

Notification List

Your radio has a Notification List that collects all your "unread" events on the channel, such as unread text messages, missed calls, and call alerts.

The Notification icon appears on the status bar when the Notification List has one or more events.

The list supports a maximum of 40 unread events. When it is full, the next event automatically replaces the oldest event.







NOTICE:



After the events are read, they are removed from the Notification List.

Accessing the Notification List

Follow the procedure to access the notification list.

1 Press  to access the menu.

2 Press  or  to Notification and press  to select.

3 Press  or  to the required event and press  to select.

Long press  to return to the Home Screen.

Wi-Fi Operation

This feature allows you to set up and connect to a Wi-Fi network. Wi-Fi supports updates for radio firmware,

codeplug, and resources such as language packs and voice announcement.



NOTICE:

This feature is applicable to XPR 5550e/XPR 5580e only.

Wi-Fi® is a registered trademark of Wi-Fi Alliance®.

Your radio supports WEP/WPA/WPA2-Personal and WPA/WPA2-Enterprise Wi-Fi networks.

WEP/WPA/WPA2-Personal Wi-Fi network

Uses pre-shared key (password) based authentication.

Pre-shared key can be entered by using the menu or CPS/RM.

WPA/WPA2-Enterprise Wi-Fi network

Uses certificate-based authentication.

Your radio must be pre-configured with a certificate.



NOTICE:







Check with your dealer or system administrator to connect to WPA/WPA2-Enterprise Wi-Fi network.

Turning Wi-Fi On or Off



The programmed **Wi-Fi On or Off** button is assigned by default. Check with your dealer or system administrator to determine how your radio has been programmed.

Voice Announcements for the programmed **Wi-Fi On or Off** button can be customized through CPS according to user requirements. Check with your dealer or system administrator for more information.

You can turn on or turn off Wi-Fi by performing one of the following actions.

- Press the programmed **Wi-Fi On or Off** button. Voice Announcement sounds Turning On Wi-Fi or Turning Off Wi-Fi.
- Access this feature using the menu.
 - a. Press  to access the menu.
 - b. Press  or  to Wi-Fi and press  to select.
 - c. Press  or  to Wi-Fi On and press  to select.

Press  to turn on Wi-Fi. The display shows  beside `Enabled`.

Press  to turn off Wi-Fi. The  disappears from beside `Enabled`.

Connecting to a Network Access Point

When you turn on Wi-Fi, the radio scans and connects to a network access point.









NOTICE:



You can also connect to a network access point using the menu.

The WPA-Enterprise Wi-Fi network access points are pre-configured. Check with your dealer or system administrator to determine how your radio has been programmed.

- 1 Press  to access the menu.

- 2 Press  or  to `WiFi` and press  to select.



- 3 Press  or  to `Networks` and press  to select.

- 4 Press  or  to a network access point and press  to select.



NOTICE:

For WPA-Enterprise Wi-Fi, if a network access point is not preconfigured, the `Connect` option is not available.

- 5 Press  or  to `Connect` and press  to select.

- 6 For WPA-Personal Wi-Fi, enter the password and press  .

- 7 For WPA-Enterprise Wi-Fi, password is configured by using RM.

If the preconfigured password is correct, your radio automatically connects to the selected network access point.

If the preconfigured password is incorrect, the display shows `Authentication Failure`, and automatically returns to the previous menu.

If the connection is successful, the radio displays a notice and the network access point is saved into the profile list.

If the connection is unsuccessful, the radio displays shows the failure notice screen momentarily and automatically returns to the previous menu.

Checking Wi-Fi Connection Status

Follow the procedure to check the Wi-Fi Connection status.

Press the programmed **Wi-Fi Status Query** button for the connection status by using Voice Announcement. Voice Announcement sounds `Wi-Fi is Off`, `Wi-Fi is On but No Connection`, or `Wi-Fi is On with Connection`.

- The display shows `WiFi Off` when the Wi-Fi is turned off.
- The display shows `WiFi On, Connected` when the radio is connected to a network.

- The display shows `WiFi On, Disconnected` when the Wi-Fi is turned on but the radio is not connected to any network.

Voice Announcements for the Wi-Fi status query results can be customized through CPS according to user requirements. Check with your dealer or system administrator for more information.









NOTICE:

The programmed **Wi-Fi Status Query** button is assigned by default. Check with your dealer or system administrator to determine how your radio has been programmed.

Refreshing the Network List



Follow the procedure to refresh the network list.

- Perform the following actions to refresh the network list through the menu.
 - a. Press  to access the menu.
 - b. Press  or  to `WiFi` and press  to select.

- c. Press  or  to `Networks` and press  to select.

When you enter the `Networks` menu, the radio automatically refreshes the network list.

- If you are already in the `Networks` menu, perform the following action to refresh the network list.

Press  or  to `Refresh` and press  to select.

The radio refreshes and displays the latest network list.

Adding a Network





NOTICE:



This task is not applicable to WPA-Enterprise Wi-Fi networks.

If a preferred network is not in the available network list, perform the following actions to add a network.

- 1 Press  to access the menu.
-

- 2 Press  or  to `WiFi` and press  to select.
-

- 3 Press  or  to `Networks` and press  to select.
-

- 4 Press  or  to `Add Network` and press  to select.
-

- 5 Enter the Service Set Identifier (SSID) and press  .
-

- 6 Press  or  to `Open` and press  to select.
-



- 7 Enter the password and press  .



The radio displays a positive mini notice to indicate that the network is successfully saved.



Viewing Details of Network Access Points



You can view details of network access points.

- 1 Press  to access the menu.

- 2 Press  or  to WiFi and press  to select.

- 3 Press  or  to Networks and press  to select.

- 4 Press  or  to a network access point and press  to select.

- 5 Press  or  to View Details and press  to select.



NOTICE:

WPA-Personal Wi-Fi and WPA-Enterprise Wi-Fi display different details of Network Access Points.

WPA-Personal Wi-Fi

For a connected network access point, your radio displays Service Set Identifier (SSID), Security Mode, Media Access Control (MAC) address, and Internet Protocol (IP) address.

For a non-connected network access point, your radio displays SSID and Security Mode.

WPA-Enterprise Wi-Fi

For a connected network access point, your radio displays SSID, Security Mode, Identity, Extended Authentication Protocol (EAP) Method, Phase 2 Authentication, Cert Name, MAC address, IP address, Gateway, DNS1, and DNS2.

For a non-connected network access point, your radio displays SSID, Security Mode, Identity, EAP Method, Phase 2 Authentication, and Cert Name.

Removing Network Access Points









NOTICE:



This task is not applicable to Enterprise Wi-Fi networks.



Perform the following actions to remove network access points from the profile list.

- 1 Press  to access the menu.

- 2 Press  or  to WiFi and press  to select.

- 3 Press  or  to Networks and press  to select.

- 4 Press  or  to the selected network access point and press  to select.

- 5 Press  or  to Remove and press  to select.

- 6 Press  or  to Yes and press  to select.

The radio displays a positive mini notice to indicate that the selected network access point is successfully removed.

Utilities



This chapter explains the operations of the utility functions available in your radio.



Turning the Radio Tones/Alerts On or Off



You can enable and disable all radio tones and alerts (except for the incoming Emergency alert tone) if needed.



Press the programmed **All Tones/Alerts** button to toggle all tones on or off, or follow the procedure described next to access this feature via the radio menu.



- 1 Press  to access the menu.
-

- 2 Press  or  to Utilities and press  to select.

- 3 Press  or  to Radio Settings and press  to select.

- 4 Press  or  to Tones/Alerts and press  to select.



- 5 Press  or  to All Tones and press  to select.



- 6 Press  to enable/disable all tones and alerts.
The display shows  beside Enabled.
The  disappears from beside Enabled.



Setting the Tone Alert Volume Offset Level



You can adjust the Tone Alert Volume Offset level if needed. This feature adjusts the volume of the tones/alerts, allowing it to be higher or lower than the voice volume.



- 1 Press  to access the menu.

- 2 Press  or  to Utilities and press  to select.



- 3 Press  or  to Radio Settings and press  to select.

- 4 Press  or  to Tones/Alerts and press  to select.

- 5 Press  or  to Vol. Offset and press  to select.

6 Press  or  to the required volume value.
The radio sounds a feedback tone with each corresponding volume value.



7 Do one of the following:



- Press  to keep the required displayed volume value.
 - Press  to exit without changing the current volume offset settings.
-



Turning the Talk Permit Tone On or Off

You can enable and disable the Talk Permit Tone if needed.



1 Press  to access the menu.

2 Press  or  to Utilities and press  to select.

3 Press  or  to Radio Settings and press  to select.

4 Press  or  to Tones/Alerts and press  to select.



5 Press  or  to Talk Permit and press  to select.



6 Press  to enable/disable the Talk Permit Tone.
The display shows  beside Enabled.
The  disappears from beside Enabled.



Turning the Power Up Alert Tone On or Off



You can enable and disable the Power Up Alert Tone if needed.

- 1 Press  to access the menu.

- 2 Press  or  to `Utilities` and press  to select.

- 3 Press  or  to `Radio Settings` and press  to select.

- 4 Press  or  to `Tones/Alerts` and press  to select.

- 5 Press  or  to `Power Up` and press  to select.

- 6 Press  to enable/disable the Power Up Alert Tone.

The display shows  beside `Enabled`.

The  disappears from beside `Enabled`.

Setting the Power Level

You can customize your radio power setting to high or low for each Connect Plus zone.



`High` enables communication with tower sites in Connect Plus mode located at a considerable distance from you.



`Low` enables communication with tower sites in Connect Plus mode in closer proximity.



Press the programmed **Power Level** button to toggle transmit power level between high and low.





Follow the procedure described next to access this feature via the radio menu.

- 1 Press  to access the menu.

- 2 Press  or  to Utilities and press  to select.

- 3 Press  or  to Radio Settings and press  to select.



- 4 Press  or  to Power and press  to select.



- 5 Press  or  to the required setting and press  to select.
 ✓ appears beside selected setting. At any time, long press  to return to the Home screen.
 Screen returns to the previous menu.



Changing the Display Mode



You can change radio display mode between Day or Night, as needed. This affects the color palette of the display.

- 1 Press  to access the menu.

- 2 Press  or  to Utilities and press  to select.

- 3 Press  or  to Radio Settings and press  to select.

- 4 Press  or  to Display and press  to select.
 The display shows Day Mode and Night Mode.

- 5 Press  or  to the required setting and press  to enable. ✓ appears besides selected setting.

Adjusting the Display Brightness



You can adjust the display brightness of the radio as needed.









NOTICE:



Display brightness cannot be adjusted when Auto Brightness is enabled.

- 1 Press  to access the menu.



- 2 Press  or  to `Utilities` and press  to select.

- 3 Press  or  to `Radio Settings` and press  to select.

- 4 Press  or  to `Display` and press  to select.

- 5 Press  or  to `Brightness` and press  to select.



The display shows a progress bar.



- 6 Decrease display brightness by pressing  or increase the display brightness by pressing  .
Select from setting of 1 to 8. Press  to confirm your entry.



Turning the Introduction Screen On or Off



You can enable and disable the Introduction Screen if needed.

- 1 Press  to access the menu.

- 2 Press  or  to `Utilities` and press  to select.

3 Press  or  to Radio Settings and press  to select.

4 Press  or  to Display and press  to select.

5 Press  or  to Intro Screen and press  to select.

6 Press  to enable/disable the Introduction Screen.



The display shows  beside Enabled.



The  disappears from beside Enabled.



Language





You can set your radio display to be in your required language.

1 Press  to access the menu.

2 Press  or  to Utilities and press  to select.

3 Press  or  to Radio Settings and press  to select.



4 Press  or  to Languages and press  to select.



5 Press  or  to the required language and press  to enable.  appears beside selected language.



Turning the LED Indicator On or Off



You can enable and disable the LED Indicator if needed.

- 1 Press  to access the menu.

- 2 Press  or  to Utilities and press  to select.

- 3 Press  or  to Radio Settings and press  to select.



- 4 Press  or  to LED Indicator and press  to select.



- 5 Press  to enable/disable the LED Indicator.
The display shows  beside Enabled.
The  disappears from beside Enabled.



Identifying Cable Type

You can select the type of cable your radio uses.

- 1 Press  to access the menu.

- 2 Press  or  to Utilities and press  to select.

- 3 Press  or  to Radio Settings and press  to select.

- 4 Press  or  to Cable Type and press  to select.



- 5 The current cable type is indicated by a .



Voice Announcement





This feature enables the radio to audibly indicate the current Zone or Channel the user has just assigned, or programmable button press. This audio indicator can be customized per customer requirements. This is typically





useful when the user is in a difficult condition to read the content shown on the display.

- 1 Press  to access the menu.

- 2 Press  or  to Utilities and press  to select.

- 3 Press  or  to Radio Settings and press  to select.



- 4 Press  or  to Voice Announcement and press  to select.
You can also use  or  to change the selected option.



- 5 Do one of the following:
 - Press  to enable Voice Announcement. The display shows  beside Enabled.
 - Press  to disable Voice Announcement. The  disappears from beside Enabled.



Menu Timer



Set the period of time your radio stays in the menu before it automatically switches to the Home screen.



- 1 Press  to access the menu.

- 2 Press  or  to Utilities and press  to select.

- 3 Press  or  to Radio Settings and press  to select.

- 4 Press  or  to Display and press  to select.

- 5 Press  or  to Menu Timer and press  to select.



- 6 Press  or  to the required setting and press  to select.



Turning Horns/Lights On or Off



This feature needs to be installed through the rear accessory connector of your radio by your dealer.



Your radio is able to notify you of an incoming call via the horns and lights feature. When activated, an incoming call sounds your vehicle's horn and turns on its lights.

- 1 Do one of the following:
 - Press the programmed **Horns/Lights** button to toggle horns and light feature on or off. Skip the following steps.
 - Press  to access the menu.

- 2 Press  or  to `Utilities` and press  to select.

- 3 Press  or  to `Radio Settings` and press  to select.



- 4 Press  or  to `Horn/Lights` and press  to select.



- 5 Press  to enable/disable Horns/Lights.
The display shows  beside `Enabled`.
The  disappears from beside `Enabled`.



Setting Dual Knob Operation Preference



Your radio has a dual-purpose **Volume/Channel Knob**. Disabling the dual-purpose option sets the knob to work as a Volume Knob only.

- 1  to access the menu.

- 2  or  to `Utilities` and press  to select.

3  or  to Radio Settings and press  to select.

4  or  to Dual Knob and press  to select.

5 The display shows Volume Only and Volume & Ch.
 or  to the required setting and press  to select.



✓ appears beside selected setting.



Screen returns to the previous menu.



Digital Mic AGC (Mic AGC-D)

This feature controls the your radio's microphone gain automatically while transmitting on a digital system. It suppresses loud audio or boosts soft audio to a preset value in order to provide a consistent level of audio.



1 Press  to access the menu.

2 Press  or  to Utilities and press  to select.

3 Press  or  to Radio Settings and press  to select.

4 Press  or  to Mic AGC-D and press  to select.

5 Do one of the following:











- Press  to enable **Mic AGC-D** . The display shows ✓ beside Enabled .
 - Press  to disable **Mic AGC-D** . The ✓ disappears from beside Enabled .
-

Intelligent Audio

Your radio can automatically adjust its audio volume to overcome background noise in the environment, inclusive of all stationary and non-stationary noise sources. This

feature is a Receive-only feature and does not affect Transmit audio.

- 1 Press  to access the menu.





Radio Control	Steps
Menu	<ol style="list-style-type: none"> a Press  to access the menu. b Press  or  to Radio Settings and press  to select. c Press  or  to Radio Settings and press  to select. d Press  or  to Intelligent Audio and press  to select.



Radio Control Steps









NOTICE:

You can also use or to change the selected option.





- e Do one of the following:
 - Press  to enable Intelligent Audio. The display shows  beside Enabled.
 - Press  to disable Intelligent Audio. The  disappears from beside Enabled.

- 2 Press  or  to Utilities and press  to select.

- 3 Press  or  to Radio Settings and press  to select.

4 Press  or  to Intelligent Audio and press  to select.

5 Do one of the following:



- Press  to enable Intelligent Audio. The display shows  beside Enabled.
 - Press  to disable Intelligent Audio. The  disappears from beside Enabled.
-



See [Authorized Accessories List](#) for recommended Bluetooth-enabled audio accessories with in-built Automatic Volume Control for similar performance.



Turning the Acoustic Feedback Suppressor Feature On or Off

This feature allows you to minimize acoustic feedback in received calls.

1 Press  to access the menu.





2 Press  or  to Utilities and press  to select.

3 Press  or  to Radio Settings and press  to select.

4 Press  or  to AF Suppressor and press  to select.

You can also use  or  to change the selected option.

5 Do one of the following.

- Press  to enable Acoustic Feedback Suppressor. The display shows  beside Enabled.
 - Press  to disable Acoustic Feedback Suppressor. The  disappears from beside Enabled.
-





Turning GNSS On or Off



Global Navigation Satellite System (GNSS) is a satellite navigation system that determines the radio precise location. GNSS includes Global Positioning System (GPS), Global Navigation Satellite System (GLONASS), and BeiDou Navigation Satellite System (BDS).





NOTICE:

Selected radio models may offer GPS, GLONASS, and BDS. GNSS constellation is configured by using CPS. Check with your dealer or system administrator to determine how your radio has been programmed.

- 1 Do one of the following:
 - Press the programmed **GNSS** button to toggle the feature on or off. Skip the following steps.
 - Press  to access the menu.
-
- 2 Press  or  to Utilities. Press  to select.
-

- 3 Press  or  to Radio Settings. Press  to select.
-

- 4 Press  or  to GNSS. Press  to select.
-

- 5 Press  to enable/disable GNSS.
 If enabled,  appears beside Enabled.
 If disabled,  disappears beside Enabled.
-



See [Checking the GNSS Information on page 322](#) for details on retrieving GNSS information.

Accessing General Radio Information

Your radio contains information on the following:

- Battery
- Degree of Tilt (Accelerometer)
- Radio Model Number Index
- Option Board Over-the-Air (OTA) Codeplug CRC
- Site Number



- Site Info
- Radio Alias and ID
- Firmware and Codeplug Versions
- GNSS Information



Press  at any time to return to the previous screen or long press  to return to the Home screen. The radio exits the current screen once the inactivity timer expires.

Checking the Radio Model Number Index

This index number identifies your radio model-specific hardware. Your radio system administrator may ask for this number when preparing a new Option Board codeplug for your radio.

- 1 Press  to access the menu.

- 2 Press  or  to `Utilities` and press  to select.

- 3 Press  or  to `Radio Info` and press  to select.



- 4 Press  or  to `Model Index` and press  to select.



The display shows the Model Number Index.



Checking the CRC of the Option Board OTA Codeplug File

Follow the instructions below if your radio system administrator asks you to view the Option Board OTA Codeplug File CRC (Cyclic Redundancy Check). This menu option only appears if the Option Board received its last codeplug update OTA.

- 1 Press  to access the menu.

- 2 Press  or  to `Utilities` and press  to select.

3 Press  or  to Radio Info and press  to select.

4 Press  or  to OE OTA CPcnc and press  to select.

The display shows some letters and numbers. Communicate this information to your radio system administrator exactly as shown.

Displaying the Site ID (Site Number)









NOTICE:



If you are not currently registered at a site, the display shows Not Registered.

The radio briefly shows the Site ID as it registers with a Connect Plus site. Following registration, the radio does not generally indicate the Site number. To display the registered Site number, do the following:

1 Press  to access the menu.

2 Press  or  to Utilities and press  to select.

3 Press  or  to Radio Info and press  to select.

4 Press  or  to Site Number and press  to select.

The display shows the Network ID and the Site Number.

Checking the Site Info



NOTICE:

If you are not currently registered at a site, the display shows Not Registered.



The Site Info feature provides information that can be useful to a service technician. It consists of the following information:



- Repeater number of current Control Channel repeater.



- RSSI: Last signal strength value measured from Control Channel repeater.
- Neighbor List sent by Control Channel repeater (five numbers separated by commas).

If you are requested to use this feature, please report the displayed information exactly as it appears on the screen.

1 Press  to access the menu.

2 Press  or  to Utilities and press  to select.

3 Press  or  to Radio Info and press  to select.

4 Press  or  to Site Info and press  to select.



The display shows the Site Info.



Checking the Radio ID



This feature displays the ID of your radio.

Follow the procedure described next to access this feature via the radio screen.

1 Press  to access the menu.

2 Press  or  to Utilities and press  to select.

3 Press  or  to Radio Info and press  to select.



4 Press  or  to My ID and press  to select.



The display shows the radio ID.



Checking the Firmware Version and Codeplug Version

Displays the firmware version on your radio.

1 Press  to access the menu.

2 Press  or  to Utilities and press  to select.

3 Press  or  to Radio Info and press  to select.

4 Press  or  to Versions and press  to select.

The display a list with the following information:

- (Radio) Firmware Version
 - (Radio) Codeplug Version
 - Option Board Firmware Version
 - Option Board Frequency Version
 - Option Board Hardware Version
 - Option Board Codeplug Version
-

Checking for Updates

Connect Plus provides the ability to update certain files (Option Board Codeplug, Network Frequency File, and Option Board Firmware File) Over-The-Air (OTA).



NOTICE:

Check with the dealer or network administrator to determine whether this feature has been enabled for your radio.

Any display Connect Plus radio has the ability to show its current Option Board OTA Codeplug CRC, Frequency File version or Option Board firmware file version by using a menu option. In addition, display radios that have been enabled for over-the-air file transfer can display the version of a "pending file". A "pending file" is a Frequency File or Option Board firmware file that the Connect Plus radio knows about through system messaging, but the radio has not yet collected all of the file packets. If a display Connect Plus radio has a pending file, the menu provides options to:

- See the version number of the pending file.
- See what percentage of packets has been collected so far.
- Request the Connect Plus radio to resume collecting file packets.

If the radio is enabled for Connect Plus OTA file transfer, there may be times when the radio automatically joins a file transfer without first notifying the radio user. While the radio is collecting file packets, the LED rapidly blinks red and the radio displays the High Volume Data icon on the Home Screen status bar.

**NOTICE:**

The Connect Plus radio cannot collect file packets and receive calls at the same time. If you wish to cancel the file transfer, press and release the **PTT** button. This causes the radio to request a call on the selected Contact Name, and it will also cancel the file transfer for that radio until the process resumes at a later time.

There are several things that can make the file transfer process start again. The first example applies to all OTA file types. The other examples apply only to the Network Frequency File and Option Board Firmware File:

- The radio system administrator re-initiates the OTA file transfer.
- The Option Board pre-defined timer expires, which causes the Option Board to automatically resume the process of collecting packets.

- The timer has not yet expired, but the radio user requests the file transfer to resume through the menu option.

After the Connect Plus radio finishes downloading all file packets, it must upgrade to the newly acquired file. For the Network Frequency File, this is an automatic process and does not require a radio reset. For the Option Board Codeplug File, this is an automatic process that will cause a brief interruption to service as the Option Board loads the new codeplug information and re-acquires a network site. How quickly the radio upgrades to a new Option Board firmware file depend on how the radio has been configured by the dealer or system administrator. The radio will either upgrade immediately after collecting all file packets, or it will wait until the next time that the user turns the radio on.

**NOTICE:**

Check with your dealer or system administrator to determine how your radio has been programmed.

The process of upgrading to a new Option Board firmware file takes several seconds, and it requires the Connect Plus Option Board to reset the radio. Once the upgrade starts, the radio user will not be able to make or receive calls until the process is completed. During the process, radio display prompts user to not turn off the radio.

Firmware File

The following section provides information on the radio firmware.



Firmware Up to Date









NOTICE:



If the Option Board firmware file is not Up to Date (and if the radio has partially collected a more recent Option Board firmware file version) the radio displays a list with additional options; Version, %Received, and Download.

- 1 Press  to access the menu.

- 2 Press  or  to Utilities and press  to select.

- 3 Press  or  to Radio Info and press  to select.



- 4 Press  or  to Updates and press  to select.



- 5 Press  or  to Firmware and press  to select.



The display shows Firmware is Up to Date.



Pending Firmware – Version



- 1 Press  to access the menu.

- 2 Press  or  to Utilities and press  to select.

- 3 Press  or  to Radio Info and press  to select.

- 4 Press  or  to Updates and press  to select.











- 5 Press  or  to Firmware and press  to select.



- 6 Press  or  to `Version` and press  to select.



If there is a pending Option Board firmware file, the display shows the pending firmware version number.

If there is a pending Option Board firmware file, the display shows `Firmware is Up to Date`.

Pending Firmware – % Received

- 1 Press  to access the menu.
-
- 2 Press  or  to `Utilities` and press  to select.
-
- 3 Press  or  to `Radio Info` and press  to select.
-
- 4 Press  or  to `Updates` and press  to select.

- 5 Press  or  to `Firmware` and press  to select.

- 6 Press  or  to `%Received` and press  to select.

The screen displays the percentage of firmware file packets collected so far.



NOTICE:



When at 100%, the radio needs to be power cycled Off and then On to initiate the firmware upgrade.



Pending Firmware – Download

If the Connect Plus radio has previously left an OTA Option Board Firmware File Transfer with a partial file, the unit automatically rejoins the file transfer (if still ongoing) when an internal timer expires. If you want the unit to rejoin an ongoing Option Board Firmware File transfer prior to



expiration of this internal timer, use the Download option as described below.



1 Press  to access the menu.

2 Press  or  to Utilities and press  to select.

3 Press  or  to Radio Info and press  to select.

4 Press  or  to Updates and press  to select.

5 Press  or  to Firmware and press  to select.

6 Press  or  to Download and press  to select.



The display shows the following:

Download Available	Start Download
--------------------	----------------

[Send Feedback](#)

No Download Available	Download not available
-----------------------	------------------------

7 Do one of the following:

- Select Yes and press  to start the download.
- Select No and press  to return to the previous menu.

Frequency File

The following section provides information on the frequency file of the radio.



Frequency File Up to Date









NOTICE:

If the Frequency File is not Up to Date (and if the radio has partially collected a more recent frequency file version) the radio displays a list with additional options; Version, %Received, and Download.



1 Press  to access the menu.



2 Press  or  to Utilities and press  to select.



3 Press  or  to Radio Info and press  to select.

4 Press  or  to Frequency and press  to select.

The display shows Freq. File is Up to Date.

4 Press  or  to Updates and press  to select.



5 Press  or  to Frequency and press  to select.



6 Press  or  to Version and press  to select.

If there is a pending Frequency File, the display shows the pending Frequency File version number.

Frequency File Pending – Version



1 Press  to access the menu.



2 Press  or  to Utilities and press  to select.



3 Press  or  to Radio Info and press  to select.



Frequency File Pending – % Received

1 Press  to access the menu.

2 Press  or  to Utilities and press  to select.

3 Press  or  to Radio Info and press  to select.

4 Press  or  to `Updates` and press  to select.



5 Press  or  to `%Received` and press  to select.



The screen displays the percentage of frequency file packets collected so far.

Frequency File Pending – Download



If the Connect Plus radio has previously left an OTA Network Frequency File Transfer with a partial file, the unit automatically rejoins the file transfer (if still ongoing) when an internal timer expires. If you want the unit to rejoin an ongoing Network Frequency File transfer prior to expiration of this internal timer, use the Download option as described below.

1 Press  to access the menu.

2 Press  or  to `Utilities` and press  to select.

3 Press  or  to `Radio Info` and press  to select.

4 Press  or  to `Updates` and press  to select.

5 Press  or  to `Frequency` and press  to select.

6 Press  or  to `Download` and press  to select.

Download Currently Unavailable	Download not available
Download Currently Available	Start Download

7 Do one of the following:

- Select `Yes` and press to start the download.



- Select **No** and press to return to the previous menu.
-



Checking the GNSS Information



Displays the GNSS information on your radio, such as values of:



- Latitude
- Longitude
- Altitude
- Direction
- Velocity
- Horizontal Dilution of Precision (HDOP)
- Satellites
- Version

1 Press  to access the menu.

2 Press  or  to **Utilities** and press  to select.

3 Press  or  to **Radio Info** and press  to select.

4 Press  or  to **GNSS Info** and press  to select.

5 Press  or  to the required item and press  to select.



The display shows the requested GNSS information.



See [Turning GNSS On or Off on page 311](#) for details on GNSS.

Viewing Enterprise Wi-Fi Certificate Details



You can view the details of the selected Enterprise Wi-Fi Certificate.

1 Press  to access the menu.

2 Press  or  to Utilities. Press  to select.

3 Press  or  to Certificate Menu. Press  to select.

✓ appears beside ready certificates.

4 Press  or  to the required certificate.
Press  to select.

Your radio displays the full details of the certificate.



NOTICE:

For unready certificates, the display shows only Status.

Other Systems

Features that are available to the radio users under this system are available in this chapter.

Push-To-Talk Button

The Push-to-Talk (**PTT**) button serves two basic purposes:

- While a call is in progress, the **PTT** button allows the radio to transmit to other radios in the call. The microphone is activated when the **PTT** button is pressed.
- While a call is not in progress, the **PTT** button is used to make a new call.

Long press the **PTT** button to talk. Release the **PTT** button to listen.

If the Talk Permit Tone or the PTT Sidetone  is enabled, wait until the short alert tone ends before talking.

 If the Channel Free Indication feature is enabled on your radio (programmed by your dealer), you hear a short alert tone the moment the target radio (the radio that is receiving your call) releases the **PTT** button, indicating the channel is free for you to respond.

 You hear a continuous Talk Prohibit Tone if your call is interrupted. You should release the **PTT** button if you hear a continuous Talk Prohibit Tone.

Programmable Buttons

Depending on the duration of a button press, your dealer can program the programmable buttons as shortcuts to radio functions.

Short press

Pressing and releasing rapidly.

Long press

Pressing and holding for the programmed duration.



NOTICE:

See [Emergency Operation on page 395](#) for more information on the programmed duration of the **Emergency** button.

Assignable Radio Functions

The following radio functions can be assigned to the programmable buttons.

Audio Ambience

Allows the user to select an environment the radio is operating in.

Audio Profiles

Allows the user to select the preferred audio profile.

Bluetooth® Audio Switch

Toggles audio routing between internal radio speaker and external Bluetooth-enabled accessory.

Bluetooth Connect

Initiates a Bluetooth find-and-connect operation.

Bluetooth Disconnect

Terminates all existing Bluetooth connections between your radio and any Bluetooth-enabled devices.

Bluetooth Discoverable

Enables your radio to enter Bluetooth Discoverable Mode.

Call Alert

Provides direct access to the contacts list for you to select a contact to whom a Call Alert can be sent.

Call Forwarding 

Toggles Call Forwarding on or off.

Call Log

Selects the call log list.

Channel Announcement

Plays zone and channel announcement voice messages for the current channel.

Contacts

Provides direct access to the Contacts list.

Emergency

Depending on the programming, initiates or cancels an emergency.

Ext Public Address (PA)

Toggles audio routing between the connected PA loudspeaker amplifier and the internal PA system of the radio.

Indoor Location

Toggles Indoor Location on or off.

Intelligent Audio

Toggles intelligent audio on or off.

Manual Dial 

Initiates a Private Call by keying in any subscriber ID.

Manual Site Roam ⁵ 

Starts the manual site search.

⁵ Not applicable in Capacity Plus.

Mic AGC

Toggles the internal microphone automatic gain control (AGC) on or off.

Monitor

Monitors a selected channel for activity.

Notifications

Provides direct access to the Notifications list.

Nuisance Channel Delete⁵

Temporarily removes an unwanted channel, except for the Selected Channel, from the scan list. The Selected Channel refers to the selected zone or channel combination of the user from which scan is initiated.

One Touch Access

Directly initiates a predefined Private, Phone or Group Call, a Call Alert, a Quick Text message, or Home Revert.

Option Board Feature

Toggles option board feature(s) on or off for option board-enabled channels.

Permanent Monitor⁵

Monitors a selected channel for all radio traffic until function is disabled.

Phone

Provides direct access to the Phone Contacts list.

Privacy

Toggles privacy on or off.

Public Address (PA)

Toggles the internal PA system of the radio on or off.

Radio Alias and ID

Provides radio alias and ID.

Radio Check

Determines if a radio is active in a system.

Radio Disable

Allows a target radio to be remotely disabled.

Radio Enable

Allows a target radio to be remotely enabled.

Remote Monitor

Turns on the microphone of a target radio without it giving any indicators.

Repeater/Talkaround⁵

Toggles between using a repeater and communicating directly with another radio.

Reset Home Channel

Sets a new home channel.

Silence Home Channel Reminder

Mutes the Home Channel Reminder.

Scan⁶

Toggles scan on or off.

Site Info

Displays the current site name and ID of Capacity Plus-Multi-Site.

Plays site announcement voice messages for the current site when Voice Announcement is enabled.

Site Lock⁵

When toggled on, the radio searches the current site only. When toggled off, the radio searches other sites in addition to the current site.

Telemetry Control

Controls the Output Pin on a local or remote radio.

Text Message

Selects the text message menu.

Transmit Interrupt Remote Dekey

Stops an ongoing interruptible call to free the channel.

Trill Enhancement

Toggles trill enhancement on or off.

Voice Announcement On/Off

Toggles voice announcement on or off.

Voice Operating Transmission (VOX)

Toggles VOX on or off.

Wi-Fi

Toggles Wi-Fi on or off.

Zone Selection

Allows selection from a list of zones.

Assignable Settings or Utility Functions

The following radio settings or utility functions can be assigned to the programmable buttons.

Tones/Alerts

Toggles all tones and alerts on or off.

Backlight

Toggles display backlight on or off.

Channel Up/Down

Depending on the programming, changes channel to previous or next channel.

⁶ Not applicable in Capacity Plus–Single-Site.

Display Mode







Toggles the day/night display mode on or off.

Power Level

Toggles transmit power level between high and low.

Accessing Programmed Functions

Follow the procedure to access programmed functions in your radio.

- 1 Do one of the following:
 - Press the programmed button. Proceed to [step 3](#).
 - Press  to access the menu.
-
- 2 Press  or  to the menu function, and press  to select a function or enter a sub-menu.
-
- 3 Do one of the following:
 - Press  to return to the previous screen.
 - Long press  to return to the Home screen.

Your radio automatically exits the menu after a period of inactivity and returns to the Home screen.

The Menu Navigation Buttons are also available on a keypad microphone. See [Keypad Microphone Buttons on page 39](#).

Status Indicators

This chapter explains the status indicators and audio tones used in the radio.

Icons







The Liquid Crystal Display (LCD) of your radio shows the radio status, text entries, and menu entries.







Table 9: Display Icons

The following icons appear on the status bar at the top of the radio display. The icons are arranged left most in order of appearance or usage, and are channel-specific.







**Bluetooth Connected**







The Bluetooth feature is enabled. The icon stays lit when a remote Bluetooth device is connected.

	<p>Bluetooth Not Connected</p> <p>The Bluetooth feature is enabled but there is no remote Bluetooth device connected.</p>
	<p>Call Log</p> <p>Radio call log.</p>
	<p>Contact</p> <p>Radio contact is available.</p>
	<p>Emergency</p> <p>Radio is in Emergency mode.</p>
	<p>Flexible Receive List</p> <p>Flexible receive list is enabled.</p>
	<p>GNSS Available </p> <p>GNSS feature is enabled. The icon stays lit when a position fix is available.</p>







	<p>GNSS Not Available </p> <p>GNSS feature is enabled but is not receiving data from the satellite.</p>
	<p>High Volume Data</p> <p>Radio is receiving high volume data and channel is busy.</p>
	<p>Indoor Location Available ⁷</p> <p>Indoor location status is on and available.</p>
	<p>Indoor Location Unavailable ⁷</p> <p>Indoor location status is on but unavailable due to Bluetooth disabled or Beacons Scan suspended by Bluetooth.</p>
	<p>Message</p> <p>Incoming message.</p>
	<p>Monitor</p> <p>Selected channel is being monitored.</p>





⁷ Only applicable for models with the latest software and hardware.

	<p>Mute Mode Mute Mode is enabled and speaker is muted.</p>
	<p>Notification Notification List has one or more missed events.</p>
	<p>Option Board The Option Board is enabled. (Option board enabled models only.)</p>
	<p>Option Board Non-Function The Option Board is disabled.</p>
	<p>Over-the-Air Programming Delay Timer Indicates time left before automatic restart of radio.</p>
	<p>Received Signal Strength Indicator (RSSI) The number of bars displayed represents the radio signal strength. Four bars indicate the strongest signal.</p>

	<p>This icon is only displayed while receiving.</p>
	<p>Ring Only Ringing mode is enabled.</p>
	<p>Scan⁸ Scan feature is enabled.</p>
	<p>Scan-Priority 1⁸ Radio detects activity on channel/group designated as Priority 1.</p>
	<p>Scan-Priority 2⁸ Radio detects activity on channel/group designated as Priority 2.</p>
	<p>Secure The Privacy feature is enabled.</p>
	<p>Sign In Radio is signed in to the remote server.</p>

⁸ Not applicable in Capacity Plus.

	Sign Out Radio is signed out of the remote server.
	Silent Ring Silent ring mode is enabled.
	Site Roaming ⁹ The site roaming feature is enabled.
	Talkaround ⁸ In the absence of a repeater, the radio is configured for direct radio to radio communication.
	Tones Disable Tones are turned off.
	Unsecure The Privacy feature is disabled.
	Vote Scan Vote scan feature is enabled.

	Wi-Fi Excellent ¹⁰ Wi-Fi signal is excellent.
	Wi-Fi Good ¹⁰ Wi-Fi signal is good.
	Wi-Fi Average ¹⁰ Wi-Fi signal is average.
	Wi-Fi Poor ¹⁰ Wi-Fi signal is poor.
	Wi-Fi Unavailable ¹⁰ Wi-Fi signal is unavailable.

⁹ Not applicable in Capacity Plus–Single-Site.
¹⁰ Only applicable for XPR 5550e/XPR 5580e .

Table 10: Advance Menu Icons

The following icons appear beside menu items that offer a choice between two options or as an indication that there is a sub-menu offering two options.





	Checkbox (Checked) Indicates that the option is selected.
	Checkbox (Empty) Indicates that the option is not selected.
	Solid Black Box Indicates that the option selected for the menu item with a sub-menu.

Table 11: Bluetooth Device Icons

The following icons appear next to items in the list of Bluetooth-enabled devices available to indicate the device type.

	Bluetooth Audio Device Bluetooth-enabled audio device, such as a headset.
---	---





	Bluetooth Data Device Bluetooth-enabled data device, such as a scanner.
	Bluetooth PTT Device Bluetooth-enabled PTT device, such as a PTT-Only Device (POD).

Table 12: Call Icons

The following icons appear on the display during a call. These icons also appear in the Contacts list to indicate alias or ID type.

	Bluetooth PC Call Indicates a Bluetooth PC Call in progress. In the Contacts list, it indicates a Bluetooth PC Call alias (name) or ID (number).
	Dispatch Call The Dispatch Call contact type is used to send a text message to a dispatcher PC through a third-party Text Message Server.











	<p>Group Call/All Call Indicates a Group Call or All Call in progress. In the Contacts list, it indicates a group alias (name) or ID (number).</p>
	<p>Private Call Indicates a Private Call in progress. In the Contacts list, it indicates a subscriber alias (name) or ID (number).</p>
	<p>Phone Call as Group/All Call Indicates a Phone Call as Group Call or All Call in progress. In the Contacts list, it indicates a group alias (name) or ID (number).</p>
	<p>Phone Call as Private Call Indicates a Phone Call as Private Call in progress. In the Contacts list, it indicates a phone alias (name) or ID (number).</p>

Table 13: Job Tickets Icons

The following icons appear momentarily on the display in the Job Ticket folder.

	<p>All Jobs Indicates all jobs listed.</p>
	<p>New Jobs Indicates new jobs.</p>
	<p>In Progress Jobs are transmitting. This is seen before indication for Job Tickets Send Failed or Sent Successfully.</p>
	<p>Send Failed Jobs cannot be sent.</p>
	<p>Sent Successfully Jobs have been successfully sent.</p>
	<p>Priority 1 Indicates Priority Level 1 for jobs.</p>



	Priority 2 Indicates Priority Level 2 for jobs.
	Priority 3 Indicates Priority Level 3 for jobs.

Table 14: Mini Notice Icons

The following icons appear momentarily on the display after an action to perform a task is taken.









	Failed Transmission (Negative) Failed action taken.
	Successful Transmission (Positive) Successful action taken.
	Transmission in Progress (Transitional) Transmitting. This is seen before indication for Successful Transmission or Failed Transmission.

Table 15: Sent Items Icons

The following icons appear at the top right corner of the display in the Sent Items folder.

	In Progress The text message to a subscriber alias or ID is pending transmission, followed by waiting for acknowledgment. The text message to a group alias or ID is pending transmission.
	Individual or Group Message Read The text message has been read.
	Individual or Group Message Unread The text message has not been read.

	<p>Send Failed The text message cannot be sent.</p>
	<p>Sent Successfully The text message has been successfully sent.</p>

LED Indicators

LED indicators show the operational status of your radio.

Blinking Red

- Radio has failed the self-test upon powering up.
- Radio is receiving an emergency transmission.
- Radio is transmitting in low battery state.
- Radio has moved out of range if Auto-Range Transponder System is configured.
- Mute Mode is enabled.

Solid Green

- Radio is powering up.

[Send Feedback](#)

Radio is transmitting.

Radio is sending a Call Alert or an emergency transmission.

Blinking Green

Radio is receiving a call or data.

Radio is retrieving Over-the-Air Programming transmissions.

Radio is detecting activity over the air.



NOTICE:

This activity may or may not affect the programmed channel of the radio due to the nature of the digital protocol.

There is no LED indication when the radio is detecting activity over the air in Capacity Plus.

Double Blinking Green

Radio is receiving a privacy-enabled call or data.

Solid Yellow

Radio is monitoring a conventional channel.
Radio is in Bluetooth Discoverable Mode.

Blinking Yellow

Radio is scanning for activity.
Radio has yet to respond to a Call Alert.

Radio has Flexible Receive List enabled.

All Capacity Plus-Multi-Site channels are busy.

Double Blinking Yellow

Radio has Auto Roaming enabled.

Radio is actively searching for a new site.

Radio has yet to respond to a Group Call Alert.

Radio is locked.

Radio is not connected to the repeater while in Capacity Plus.

All Capacity Plus channels are busy.

Tones

The following are the tones that sound through on the radio speaker.



High Pitched Tone



Low Pitched Tone

Indicator Tones

Indicator tones provide you with audible indications of the status after an action to perform a task is taken.



Positive Indicator Tone



Negative Indicator Tone

Audio Tones

Audio tones provide you with audible indications of the status, or response to data received on the radio.



Continuous Tone

A monotone sound. Sounds continuously until termination.



Periodic Tone

Sounds periodically depending on the duration set by the radio. Tone starts, stops, and repeats itself.



Repetitive Tone

A single tone that repeats itself until it is terminated by the user.



Momentary Tone

Sounds once for a short duration set by the radio.

Conventional Analog and Digital Modes

Each channel in your radio can be configured as a conventional analog or conventional digital channel.

Use the **Channel Rocker** to switch between an analog or a digital channel.

Certain features are unavailable when switching from digital to analog mode. The icons for digital features reflect this change by appearing “grayed out”. The disabled features are hidden in the menu.

Your radio also has features available in both analog and digital modes. The minor differences in the way each feature works do **not** affect the performance of your radio.



NOTICE:

Your radio also switches between digital and analog modes during a dual mode scan. See [Scan on page 376](#) for more information.

Icon Information

Throughout this publication, the icons described are used to indicate features supported in either the conventional analog or conventional digital mode, or made available with a keypad-enabled microphone.



Indicates a conventional **Analog Mode-Only** feature.



Indicates a conventional **Digital Mode-Only** feature.

For features that are available in **both** conventional analog and digital modes, both icons are **not** shown.

IP Site Connect

This feature allows your radio to extend conventional communication beyond the reach of a single site by

connecting to different available sites by using an Internet Protocol (IP) network. This is a conventional multi-site mode.

When the radio moves out of range from one site and into the range of another, the radio connects to the repeater of the new site to send or receive calls or data transmissions. This is done either automatically or manually depending on your settings.

In an automatic site search, the radio scans through all available sites when the signal from the current site is weak or when the radio is unable to detect any signal from the current site. The radio then locks on to the repeater with the strongest Received Signal Strength Indicator (RSSI) value.

In a manual site search, the radio searches for the next site in the roam list that is currently in range but which may not have the strongest signal and locks on to the repeater.

**NOTICE:**

Each channel can only have either Scan or Roam enabled, not both at the same time.

Channels with this feature enabled can be added to a particular roam list. The radio searches the channels in the roam list during the automatic roam operation to locate the

best site. A roam list supports a maximum of 16 channels, including the selected channel.

**NOTICE:**

You cannot manually add or delete an entry in the roam list. Check with your dealer or system administrator for more information.

Capacity Plus–Single-Site

Capacity Plus–Single-Site is a single-site trunking configuration of the MOTOTRBO radio system, which uses a pool of channels to support hundreds of users and up to 254 Groups. This feature allows your radio to efficiently utilize the available number of programmed channels while in Repeater Mode.

You hear a negative indicator tone if you try to access a feature not applicable to Capacity Plus–Single-Site by using a programmable button press.

Your radio also has features that are available in conventional digital mode, IP Site Connect, and Capacity Plus. However, the minor differences in the way each feature works does not affect the performance of your radio.

Check with your dealer or system administrator for more information on this configuration.

Capacity Plus–Multi-Site

Capacity Plus–Multi-Site is a multi-channel trunking configuration of the MOTOTRBO radio system, combining the best of both Capacity Plus and IP Site Connect configurations.

Capacity Plus–Multi-Site allows your radio to extend trunking communication beyond the reach of a single site, by connecting to different available sites which are connected with an IP network. It also provides an increase in capacity by efficiently utilizing the combined available number of programmed channels supported by each of the available sites.

When the radio moves out of range from one site and into the range of another, it connects to the repeater of the new site to send or receive calls/data transmissions. Depending on your settings, this is done automatically or manually.

If the radio is set to do this automatically, it scans through all available sites when the signal from the current site is weak or when the radio is unable to detect any signal from the current site. It then locks on to the repeater with the strongest RSSI value.

In a manual site search, the radio searches for the next site in the roam list that is currently in range (but which may not have the strongest signal) and locks on to it.

Any channel with Capacity Plus–Multi-Site enabled can be added to a particular roam list. The radio searches these channels during the automatic roam operation to locate the best site.



NOTICE:

You cannot manually add or delete an entry to the roam list. Check with your dealer or system administrator for more information.

Similar to Capacity Plus–Single Site, icons of features not applicable to Capacity Plus–Multi-Site are not available in the menu. You hear a negative indicator tone if you try to access a feature not applicable to Capacity Plus–Multi-Site by using a programmable button press.

Zone and Channel Selections

This chapter explains the operations to select a zone or channel on your radio. A zone is a group of channels.





Your radio supports up to 99 channels and 2 zones, with a maximum of 99 channels per zone.



Each channel can be programmed with different features and/or support different groups of users.

Selecting Zones

Follow the procedure to select the required zone on your radio.

- 1 Do one of the following:
 - Press the programmed **Zone Selection** button. Proceed to [step 3](#).
 - Press  to access the menu.





- 2 Press  or  to Zone. Press  to select. The display shows  and the current zone.

- 3 Press  or  to the required zone. Press  to select. The display shows <Zone> Selected momentarily and returns to the selected zone screen.

Selecting Zones by Using the Alias Search

Follow the procedure to select the required zone on your radio by using the alias search.

- 1 Press  to access the menu.

- 2 Press  or  to Zone. Press  to select. The display shows  and the current zone.

- 3 Enter the first character of the required alias. The display shows a blinking cursor.

- 4 Enter the rest of the characters of the required alias. The alias search is case-insensitive. If there are two or more entries with the same name, the display shows the entry listed first in the list. The first text line shows the characters you entered. The following text lines show the shortlisted search results.

- 5 Press  to select.

The display shows <Zone> Selected momentarily and returns to the selected zone screen.

Selecting Channels

Follow the procedure to select the required channel on your radio after you have selected a zone.

Do one of the following:

- Press the **Scroll Up/Down** button.
 - Use the **Volume/Channel Knob**.
 - Press the programmed **Channel Up/Down** buttons.
-

Calls

This chapter explains the operations to receive, respond to, make, and stop calls.

You can select a subscriber alias or ID, or group alias or ID after you have selected a channel by using one of these features:

Alias Search

This method is used for Group, Private, and All Calls only with a keypad microphone.

Contacts List

This method provides direct access to the Contacts list.

Manual Dial (by using Contacts)

This method is used for Private and Phone Calls only with a keypad microphone.

Programmed Number Keys

This method is used for Group, Private, and All Calls only with a keypad microphone.



NOTICE:

You can only have one alias or ID assigned to a number key, but you can have more than one number key associated to an alias or ID. All the number keys on a keypad microphone can be assigned. See [Assigning Entries to Programmable Number Keys on page 381](#) for more information.

Programmed One Touch Access Button

This method is used for Group, Private, and Phone Calls only.

You can only have one ID assigned to a **One Touch Access** button with a short or long programmable

button press. Your radio can have multiple **One Touch Access** buttons programmed.

Programmable Button

This method is used for Phone Calls only.

Volume/Channel Selector Knob

This method manually selects a subscriber alias or ID, or group alias or ID.

The LED lights up solid green while the radio is transmitting and blinks green when the radio is receiving.



NOTICE:

The LED lights up solid green while the radio is transmitting and double blinks green when the radio is receiving a privacy-enabled call.

To unscramble a privacy-enabled call, your radio must have the same Privacy Key, or the same Key Value and Key ID (programmed by your dealer), as the transmitting radio (the radio you are receiving the call from).

See [Privacy on page 430](#) for more information.

Group Calls

Your radio must be configured as part of a group to receive a call from or make a call to the group of users.

Making Group Calls

Follow the procedure to make Group Calls on your radio.

- 1 Do one of the following:
 - Select a channel with the active group alias or ID.
 - Press the programmed **One Touch Access** button.

- 2 Press the **PTT** button to make the call.
The green LED lights up. The display shows the **Group Call** icon and the group call alias.

- 3 Release the **PTT** button to listen.
The green LED lights up when the target radio responds. The display shows the **Group Call** icon, the group alias or ID, and the transmitting radio alias or ID.



- 4  If the Channel Free Indication feature is enabled, you hear a short alert tone the moment the transmitting radio releases the **PTT** button, indicating the channel is free for you to respond. Press the **PTT** button to respond to the call.



The call ends when there is no voice activity for a predetermined period. The radio returns to the screen you were on prior to initiating the call.

Making Group Calls by Using the Contacts List

Follow the procedure to make Group Calls on your radio by using the Contacts list.

- 1 Press  to access the menu.

- 2 Press  or  to **Contacts**. Press  to select.

- 3 Press  or  to the required alias or ID.
Press  to select.

- 4 Press the **PTT** button to make the call.
The green LED lights up.

- 5 Release the **PTT** button to listen.

The green LED blinks when any user in the group responds. The display shows the **Group Call** icon, and alias or ID, and the transmitting radio alias or ID.

- 6  If the Channel Free Indication feature is enabled, you hear a short alert tone the moment the transmitting radio releases the **PTT** button, indicating the channel is free for you to respond. Press the **PTT** button to respond to the call.

The call ends when there is no voice activity for a predetermined period.

Making Group Calls by Using the Programmable Number Key

Follow the procedure to make Group Calls on your radio by using the programmable number key.

- 1 Long press the programmed number key to the predefined alias or ID when you are on the Home screen.

If a number key is assigned to an entry in a particular mode, this feature is not supported when you long press the number key in another mode.

A negative indicator tone sounds if the number key is not associated to an entry.

- 2 Press the **PTT** button to make the call.

The green LED lights up.

- 3 Release the **PTT** button to listen.

The green LED blinks when any user in the group responds.

- 4  If the Channel Free Indication feature is enabled, you hear a short alert tone the moment the transmitting radio releases the **PTT** button, indicating the channel is free for you to respond. Press the **PTT** button to respond to the call.

The call ends when there is no voice activity for a predetermined period. The radio returns to the screen you were on before initiating the call.

See [Assigning Entries to Programmable Number Keys on page 381](#) for more information.



Responding to Group Calls

To receive a call from a group of users, your radio must be configured as part of that group. Follow the procedure to respond to Group Calls on your radio.

When you receive a Group Call:

- The green LED blinks.
- The display shows the **Group Call** icon at the top right corner.
- The first text line shows the caller alias.
- The second text line displays the group call alias.
- Your radio unmutes and the incoming call sounds through the speaker.

- 1 Do one of the following:

-  If the Channel Free Indication feature is enabled, you hear a short alert tone the moment the transmitting radio releases the **PTT** button, indicating the channel is free for you to respond. Press the **PTT** button to respond to the call.
-  If the Voice Interrupt feature is enabled, press the **PTT** button to interrupt the audio from the

transmitting radio and free the channel for you to respond.

The green LED lights up.

2 Do one of the following:

- Wait for the Talk Permit Tone to end and speak clearly into the microphone if enabled.
-  Wait for the **PTT** Sidetone to end and speak clearly into the microphone if enabled.

3 Release the **PTT** button to listen.

The call ends when there is no voice activity for a predetermined period.

If the radio receives a Group Call while not on the Home screen, it remains on its current screen prior to answering the call.

Long press  to return to the Home screen to view the caller alias before replying.

Private Calls

A Private Call is a call from an individual radio to another individual radio.

There are two ways to set up a Private Call. The first type sets up the call after performing a radio presence check, while the second type sets up the call immediately. Only one of these types can be programmed to your radio by your dealer.

Making Private Calls

Your radio must be programmed to initiate a Private Call. If this feature is not enabled, a negative indicator tone sounds when you initiate the call. Follow the procedure to make Private Calls on your radio.

Use the Text Message or Call Alert features to contact an individual radio. For more information, see [Text Messaging on page 143](#) or [Call Alert Operation on page 391](#).

1 Do one of the following:

- Select a channel with the active subscriber alias or ID.

- Press the programmed **One Touch Access** button.
-

- 2 Press the **PTT** button to make the call.

The green LED lights up. The display shows the **Private Call** icon, the subscriber alias, and call status.

- 3 Wait for the Talk Permit Tone to end and speak clearly into the microphone if enabled.
-

- 4 Release the **PTT** button to listen.

The green LED blinks when the target radio responds.



- 5  If the Channel Free Indication feature is enabled, you hear a short alert tone the moment the transmitting radio releases the **PTT** button, indicating the channel is free for you to respond. Press the **PTT** button to respond to the call.



The call ends when there is no voice activity for a predetermined period. A tone sounds. The display shows **Call Ended**.

Making Private Calls by Using the Contacts List

Follow the procedure to make Private Calls on your radio by using the Contacts list.

- 1 Press  to access the menu.
-

- 2 Press  or  to **Contacts**. Press  to select.
-

- 3 Press  or  to the required alias or ID. Press  to select.
-

- 4 Press the **PTT** button to make the call. The green LED lights up. The display shows the destination alias.
-

- 5 Wait for the Talk Permit Tone to end and speak clearly into the microphone if enabled.
-

6 Release the **PTT** button to listen.

The green LED blinks when the target radio responds. The display shows the transmitting user alias or ID.



- 7**  If the Channel Free Indication feature is enabled, you hear a short alert tone the moment the transmitting radio releases the **PTT** button, indicating the channel is free for you to respond. Press the **PTT** button to respond to the call.



The call ends when there is no voice activity for a predetermined period. A tone sounds. The display shows **Call Ended**.



Making Private Calls by Using the Manual Dial

Follow the procedure to make Private Calls on your radio by using the manual dial.



- 1** Press  to access the menu.
-

- 2** Press  or  to **Contacts**. Press  to select.
-

- 3** Press  or  to **Manual Dial**. Press  to select.
-

- 4** Press  or  to **Radio Number**. Press  to select.
-

- 5** Do one of the following:

- Enter the subscriber ID, and press  to proceed.
 - Edit the previously dialed subscriber ID, and press  to proceed.
-

- 6** Press the **PTT** button to make the call.
The green LED lights up. The display shows the destination alias.
-

- 7** Wait for the Talk Permit Tone to end and speak clearly into the microphone if enabled.
-

- 8 Release the **PTT** button to listen.

The green LED lights up when the target radio responds. The display shows the transmitting user alias or ID.

- 9  If the Channel Free Indication feature is enabled, you hear a short alert tone the moment the transmitting radio releases the **PTT** button, indicating the channel is free for you to respond. Press the **PTT** button to respond to the call.

The call ends when there is no voice activity for a predetermined period. A tone sounds. The display shows `Call Ended`.

Making Private Calls by Using the Programmable Number Key

Follow the procedure to make Private Calls on your radio by using the programmable number key.

- 1 Long press the programmed number key to the predefined alias or ID when you are on the Home screen.

If a number key is assigned to an entry in a particular mode, this feature is not supported when you long press the number key in another mode.

A negative indicator tone sounds if the number key is not associated to an entry.

- 2 Press the **PTT** button to make the call.

The green LED lights up. The display shows the **Private Call** icon at the top right corner. The first text line shows the caller alias. The second text line shows the call status.

- 3 Release the **PTT** button to listen.

The green LED blinks when the target radio responds. The display shows the destination alias.

- 4  If the Channel Free Indication feature is enabled, you hear a short alert tone the moment the transmitting radio releases the **PTT** button, indicating the channel is free for you to respond. Press the **PTT** button to respond to the call.

The call ends when there is no voice activity for a predetermined period. A tone sounds. The radio



returns to the screen you were on before initiating the call.

See [Assigning Entries to Programmable Number Keys on page 381](#) for more information.

Responding to Private Calls

Follow the procedure to respond to Private Calls on your radio.

When you receive a Private Call:

- The green LED blinks.
 - Your radio unmutes and the incoming call sounds through the speaker.
- 1 Do one of the following:
 -  If the Channel Free Indication feature is enabled, you hear a short alert tone the moment the transmitting radio releases the **PTT** button, indicating the channel is free for you to respond. Press the **PTT** button to respond to the call.
 -  If the Transmit Interrupt Remote Dekey feature is enabled, press the **PTT** button to stop an

ongoing interruptible call and free the channel for you to respond.

The green LED lights up.

- 2 Wait for the Talk Permit Tone to end and speak clearly into the microphone if enabled.
-

- 3 Release the **PTT** button to listen.

The call ends when there is no voice activity for a predetermined period.

All Calls

An All Call is a call from an individual radio to every radio on the channel. An All Call is used to make important announcements, requiring full attention from the user. The users on the channel cannot respond to an All Call.

Receiving All Calls

When you receive an All Call:

- A tone sounds.
- The green LED blinks.

- The display shows the **Group Call** icon at the top right corner.
- The first text line shows the caller alias ID.
- The second text line displays All Call.
- Your radio unmutes and the incoming call sounds through the speaker.

The radio returns to the screen before receiving the All Call when the call ends.

An All Call does not wait for a predetermined period before ending.

 If the Channel Free Indication feature is enabled, you hear a short alert tone when the transmitting radio releases the **PTT** button, indicating the channel is free for you to use.

You cannot respond to an All Call.



NOTICE:

The radio stops receiving the All Call if you switch to a different channel while receiving the call. You are not able to continue with any menu navigation or editing until the end of an All Call.

Making All Calls

Your radio must be programmed for you to make an All Call. Follow the procedure to make All Calls on your radio.

1 Select a channel with the active All Call group alias or ID.

2 Press the **PTT** button to make the call.

The green LED lights up. The display shows the **Group Call** icon and All Call.

3 Do one of the following:

- Wait for the Talk Permit Tone to end and speak clearly into the microphone if enabled.
-  Wait for the **PTT** Sidetone to end and speak clearly into the microphone if enabled.

Users on the channel cannot respond to an All Call.

Making All Calls by Using the Programmable Number Key

Follow the procedure to make All Calls on your radio by using the programmable number key.

- 1 Long press the programmed number key assigned to the predefined alias or ID when you are on the Home screen.

If a number key is assigned to an entry in a particular mode, this feature is not supported when you long press the number key in another mode.

A negative indicator tone sounds if the number key is not associated to an entry.

- 2 Press the **PTT** button to make the call.

The green LED lights up.

- 3 Release the **PTT** button to listen.

The green LED lights up when the target radio responds. You cannot respond to an All Call at the moment.

- 4  If the Channel Free Indication feature is enabled, you hear a short alert tone the moment the transmitting radio releases the **PTT** button, indicating the channel is free for you to respond. Press the **PTT** button to respond to the call.

The call ends when there is no voice activity for a predetermined period. The radio returns to the screen you were on prior to initiating the call. For a Private Call, you hear a short tone when the call ends.

See [Assigning Entries to Programmable Number Keys on page 381](#) for more information.

Selective Calls

A Selective Call is a call from an individual radio to another individual radio. It is a Private Call on an analog system.

Making Selective Calls

Your radio must be programmed for you to initiate a Selective Call. Follow the procedure to make Selective Calls on your radio.

- 1 Select a channel with the active subscriber alias or ID.
-

- 2 Press the **PTT** button to make the call.

The green LED lights up. The display shows the **Private Call** icon, the subscriber alias, and call status.

- 3 Do one of the following:

- Wait for the Talk Permit Tone to end and speak clearly into the microphone if enabled.
 -  Wait for the **PTT** Sidetone to end and speak clearly into the microphone if enabled.
-

- 4 Release the **PTT** button to listen.

The green LED lights up when the target radio responds.

- 5  If the Channel Free Indication feature is enabled, you hear a short alert tone the moment the transmitting radio releases the **PTT** button, indicating the channel is free for you to respond. Press the **PTT** button to respond to the call.

The call ends when there is no voice activity for a predetermined period.

- 6 The display shows `Call Ended`.
-

Responding to Selective Calls

Follow the procedure to respond to Selective Calls on your radio.

When you receive a Selective Call:

- The green LED blinks.
- The first text line shows the **Private Call** icon and the caller alias or `Selective Call` or `Alert with Call`.

- Your radio unmutes and the incoming call sounds through the speaker.

- Press the **PTT** button to respond to the call.
The green LED lights up.

-
- Wait for the Talk Permit Tone to end and speak clearly into the microphone if enabled.

- Release the **PTT** button to listen.
The call ends when there is no voice activity for a predetermined period. A tone sounds. The display shows `Call Ended`.

Phone Calls

A Phone Call is a call from an individual radio to a telephone.

If Phone Call capability is not enabled in your radio:

- The display shows `Unavailable`.
- Your radio mutes the call.
- Your radio returns to the previous screen when the call ends.

During the Phone Call, your radio attempts to end the call when:

- You press the **One Touch Access** button with the deaccess code preconfigured.
- You enter the deaccess code as the input for extra digits.

During channel access, access or deaccess code, or extra digits transmission, your radio responds to the **On/Off**, **Volume Control**, and **Channel Selector** buttons or knobs only. A tone sounds for every invalid input.

During channel access, press  to dismiss the call attempt. A tone sounds.



NOTICE:

The access or deaccess code cannot be more than 10 characters.

Check with your dealer or system administrator for more information.

Making Phone Calls

Follow the procedure to make Phone Calls on your radio.

- 1 Press the programmed **One Touch Access** button to the predefined alias or ID.

If the entry for the **One Touch Access** button is empty, a negative indicator tone sounds. If the access code is not preconfigured in the Contact List, the display shows `Access Code:`.

- 2 Enter the access code, and press  to proceed.

The access or deaccess code cannot be more than 10 characters.

- 3 Press the **PTT** button to respond to the call. Release the **PTT** button to listen.

- 4 Enter extra digits with the keypad if requested by the call, and press  to proceed.

If the call ends while you are entering the extra digits requested by the call, your radio returns to the screen you were on before initiating the call.

The Dual Tone Multi Frequency (DTMF) Tone sounds. Your radio returns to the previous screen.

- 5 Press  to end the call.

- 6 Do one of the following:

- If the deaccess code was not preconfigured, enter the deaccess code when the display shows `De-Access Code:`, and press  to proceed. The radio returns to the previous screen.
- Press the programmed **One Touch Access** button.
If the entry for the **One Touch Access** button is empty, a negative indicator tone sounds.

The DTMF Tone sounds and the display shows `Ending Phone Call`.

If the call ends successfully:



- A tone sounds.
- The display shows `Call Ended`.

If the call fails to end, the radio returns to the Phone Call screen. Repeat the last two steps or wait for the telephone user to end the call.



Making Phone Calls by Using the Contacts List

Follow the procedure to make Phone Calls on your radio by using the Contacts list.

1 Press  to access the menu.

2 Press  or  to Contacts. Press  to select.

The display shows the entries in alphabetical order.



3 Press  or  to the required alias or ID.
Press  to select.

When you press the **PTT** button while on the Phone Contacts screen:

- The first line of the display shows Phone Number:.
- The second line of the display shows a blinking cursor.

If the selected entry is empty:

- A negative indicator tone sounds.
- The display shows Phone Call Invalid #.

4 Press  or  to Call Phone. Press  to select.

The display shows Access Code: if the access code was not preconfigured.

5 Enter the access code, and press  to proceed.

The access or deaccess code cannot be more than 10 characters.

The first text line shows Calling. The second text line shows the subscriber alias or ID, and the **Phone Call** icon.

If the call is successful:

- The DTMF Tone sounds.

- You hear the dialing tone of the telephone user.
- The first text line shows the subscriber alias or ID, and the **RSSI** icon.
- The second text line shows Phone Call, and the **Phone Call** icon.

If the call is unsuccessful:

- A tone sounds.
- The display shows Phone Call Failed and then, Access Code:.
- Your radio returns to the screen you were on prior to initiating the call if the access code has been preconfigured in the Contacts list.

6 Press the **PTT** button to respond to the call.

The **RSSI** icon disappears.

7 Release the **PTT** button to listen.

8 Enter extra digits with the keypad if requested by the call, and press to proceed.

If the call ends while you are entering the extra digits requested by the call, your radio returns to the screen you were on prior to initiating the call.

The DTMF Tone sounds. Your radio returns to the previous screen.

9 Press to end the call.

10 If the deaccess code was not preconfigured, enter the deaccess code when the display shows De-

Access Code:, and press  to proceed.

The radio returns to the previous screen. The DTMF Tone sounds and the display shows Ending Phone Call.

If the call ends successfully:

- A tone sounds.
- The display shows Call Ended.

If the call fails to end, the radio returns to the Phone Call screen. Repeat [step 9](#) and [step 10](#), or wait for the telephone user to end the call. When you press the **PTT** button while in the Phone Contacts screen, a tone sounds and the display shows Press OK to Place Phone Call.

When the telephone user ends the call, a tone sounds and the display shows Phone Call Ended.

If the call ends while you are entering the extra digits requested by the Phone Call, your radio returns to the screen you were on prior to initiating the call.



NOTICE:

During the channel access, press  to dismiss the call attempt and a tone sounds.



During the call, when you press **One Touch Access** button with the deaccess code preconfigured or enter the deaccess code as the input for extra digits, your radio attempts to end the call.



During channel access and access/ deaccess code or extra digits transmission, your radio responds to **On/Off** button, **Volume Knob**, and **Channel Rocker** only. A tone sounds for every invalid input.



Making Phone Calls by Using the Manual Dial

Follow the procedure to make Phone Calls on your radio by using the manual dial.

- 1 Press  to access the menu.

- 2 Press  or  to Contacts. Press  to select.

- 3 Press  or  to Manual Dial. Press  to select.

- 4 Press  or  to Phone Number. Press  to select.
The display shows Number: and a blinking cursor.

- 5 Enter the telephone number, and press  to proceed.

The display shows `Access Code:` and a blinking cursor if the access code was not preconfigured.

- 6 Enter the access code, and press  to proceed.

The access or deaccess code cannot be more than 10 characters.

- 7 The green LED lights up. The display shows the **Phone Call** icon at the top right corner. The first text line shows the subscriber alias. The second text line shows the call status.

If the call is successful:

- The DTMF Tone sounds.
- You hear the dialing tone of the telephone user.
- The first text line shows the subscriber alias.
- The display continues to show the **Phone Call** icon at the top right corner.

If the call is unsuccessful:

- A tone sounds.

- The display shows `Phone Call Failed` and then, `Access Code:`.
- Your radio returns to the screen you were on before initiating the call if the access code has been preconfigured in the Contacts list.

- 8 Press  to end the call.

- 9 Do one of the following:

- If the deaccess code was not preconfigured, enter the deaccess code when the display shows `De-Access Code:`, and press  to proceed. The radio returns to the previous screen.
- Press the programmed **One Touch Access** button.
If the entry for the **One Touch Access** button is empty, a negative indicator tone sounds.

The DTMF Tone sounds and the display shows `Ending Phone Call`.

If the call ends successfully:

- A tone sounds.
- The display shows `Call Ended`.

If the call fails to end, the radio returns to the Phone Call screen. Repeat [step 8](#), or wait for the telephone user to end the call.

**NOTICE:**

When you press **PTT** button while in the Phone Contacts screen, a tone sounds and the display shows `Press OK to Place Phone Call`.

When the telephone user ends the call, a tone sounds and the display shows `Call Ended`.

If the call ends while you are entering the extra digits requested by the Phone Call, your radio returns to the screen you were on before initiating the call.

During the channel access, press  to dismiss the call attempt and a tone sounds.

During the call, when you press **One Touch Access** button with the deaccess code preconfigured or enter the deaccess code as the input for extra digits, your radio attempts to end the call.



During channel access and access/deaccess code or extra digits transmission, your radio responds to **On/Off** button, **Volume Knob**,



and **Channel Rocker** only. A tone sounds for every invalid input.

Making Group, Private, Phone or All Calls by Using the Alias Search





Follow the procedure to make any calls by using the alias search.

- 1 Press  to access the menu.

- 2 Press  or  to **Contacts**. Press  to select.
The display shows the entries in alphabetical order.



- 3 Press  or  to the required subscriber alias or ID. The first line of the display shows **Phone Number:**. The second line of the display shows a blinking cursor. Use the keypad to enter a telephone number.

- 4 Press  to select. If the entry selected is empty, a negative indicator tone sounds and the display shows **Phone Call Invalid #**.

- 5 Press  or  to **Call Phone** and Press  to select. If the access code was not preconfigured in the **Contacts** list, the first line of the display shows **Access Code:**. The second line of the display shows a blinking cursor. Enter the access code and press the  button to proceed. If successful, the DTMF tone sounds. You hear the dialing tone of the telephone user. The first line of the display shows the subscriber alias or ID, and the **RSSI** icon. The second line of the display shows **Phone Call** and the **Phone Call** icon. If unsuccessful, a tone sounds and the display shows **Phone Call Failed**. Your radio returns to the **Access Code** input screen. If the access code was preconfigured in the **Contacts** list, the radio returns to the screen you were on prior to initiating the call.

- 6 Press the **PTT** button to talk and release it to listen. The **RSSI** icon disappears during transmission.



- 7 To enter extra digits, if requested by the Phone Call, do one of the following.
- Press any keypad key to begin the input of the extra digits. The first line of the display shows `Extra Digits:`. The second line of the display shows a blinking cursor. Enter the extra digits and press the  button to proceed. The DTMF tone sounds and the radio returns to the previous screen.
 - Press **One Touch Access** button. The DTMF tone sounds. If the entry for the **One Touch Access** button is empty, a negative indicator tone sounds.

- 8 Press  to end the call. If deaccess code was not preconfigured in the Contacts list, the first line of the display shows `De-Access Code:`. The second line of the display shows a blinking cursor. Enter the deaccess code and press  to proceed. The radio returns to the previous screen. The DTMF tone sounds and the display shows `Ending Phone Call`. If successful, a tone sounds and the display shows `Phone Call Ended`. Your radio returns to the Phone

Call screen. If unsuccessful, your radio returns to the Phone Call screen. When you press the **PTT** button while in the Phone Contacts screen, as tone sounds and the display shows `Press OK to Place Phone Call`. When the telephone user ends the call, a tone sounds and the display shows `Phone Call Ended`. If the call ends while you are entering the extra digits requested by the Phone Call, your radio returns to the screen you were on prior to initiating the call.



NOTICE:

During the channel access, press  to dismiss the call attempt and a tone sounds button or to exit alias search. Press  or  to exit alias search. During the call, when you press the **One Touch Access** button with the deaccess code preconfigured or enter the deaccess code as the input for extra digits, your radio attempts to end the call. During channel access and access/ deaccess code or extra digits transmission, you radio responds to On/Off button, Volume Knob, and Channel Rocker only. A tone sounds for every invalid input.

Dual Tone Multi Frequency



The Dual Tone Multi Frequency (DTMF) feature allows the radio to operate in a radio system with an interface to the telephone systems.

You can turn off the DTMF tone by disabling all radio tones and alerts. See [Turning Radio Tones/Alerts On or Off on page 190](#) for more information.

Initiating DTMF Calls

Follow the procedure to initiate DTMF calls on your radio.

- 1 Press and hold the **PTT** button.

 - 2 Do one of the following:
 - Enter the desired number to initiate a DTMF call.
 - Press  to initiate a DTMF call.
 - Press  to initiate a DTMF call.
-

Responding to Phone Calls as Group Calls

Follow the procedure to respond to Phone Calls as Group Calls on your radio.

When you receive a Phone Call as a Group Call:

- The display shows the **Phone Call** icon at the top right corner.
- The display shows the group alias and Phone Call.

If Phone Call capability is not enabled on your radio, the first line of the display shows `Unavailable` and your radio mutes the call. Your radio returns to the previous screen when the call ends.

- 1 Press the **PTT** button to respond to the call. Release the **PTT** button to listen.

- 2 Press  to end the call.

The display shows `Ending Phone Call`.
If the call ends successfully:

- A tone sounds.
- The display shows `Call Ended`.

If the call fails to end, the radio returns to the Phone Call screen. Repeat this step or wait for the telephone user to end the call.

Responding to Phone Calls as All Calls



When you receive a Phone Call as an All Call, you can respond to or end the call, only if an All Call type is assigned to the channel. Follow the procedure to respond to Phone Calls as All Calls on your radio.

When you receive a Phone Call as an All Call:

- The display shows the **Phone Call** icon at the top right corner.
- The display shows All Call and Phone Call.

If Phone Call capability is not enabled on your radio, the first line of the display shows Unavailable and your radio mutes the call.

Your radio returns to the previous screen when the call ends.

- 1 Press the **PTT** button to respond to the call.

- 2 Release the **PTT** button to listen.

- 3 Press  to end the call.

The display shows Ending Phone Call.

If the call ends successfully:

- A tone sounds.
- The display shows All Call and Call Ended.

If the call fails to end, the radio returns to the Phone Call screen. Repeat [step 3](#) or wait for the telephone user to end the call.

Responding to Phone Calls as Private Calls

Follow the procedure to respond to Phone Calls as Private Calls on your radio.

When you receive a Phone Call as a Private Call:

- The display shows the **Phone Call** icon at the top right corner.
- The display shows the caller alias or Phone Call.

If Phone Call capability is not enabled on your radio, the first line of the display shows `Unavailable` and your radio mutes the call. Your radio returns to the previous screen when the call ends.

- 1 Press the **PTT** button to respond to the call. Release the **PTT** button to listen.
-

- 2 Press  to end the call.

The display shows `Ending Phone Call`.

If the call ends successfully:

- A tone sounds.
- The display shows `Call Ended`.

If the call fails to end, the radio returns to the Phone Call screen. Repeat this step or wait for the telephone user to end the call.

Stopping Radio Calls

This feature allows you to stop an ongoing Group or Private Call to free the channel for transmission. For example, when a radio experiences a "stuck microphone" condition where the **PTT** button is inadvertently pressed by the user.

Your radio must be programmed to allow you to use this feature. Follow the procedure to stop calls on your radio.

- 1 Press the programmed **Transmit Interrupt Remote Dekey** button.

The display shows `Remote Dekey`.

- 2 Wait for acknowledgment.

If successful:

- A positive indicator tone sounds.
- The display shows `Remote Dekey Success`.

If unsuccessful:

- A negative indicator tone sounds.
 - The display shows `Remote Dekey Failed`.
-



NOTICE:

Check with your dealer or system administrator for more information.

Talkaround

This feature allows you to continue communication when your repeater is not operational, or when your radio is out of range from the repeater but within talking range of other radios.

The talkaround setting is retained even after powering down.







NOTICE:



This feature is not applicable in Capacity Plus–Single-Site, Capacity Plus–Multi-Site, and Citizens Band channels that are in the same frequency.



Toggling Between Repeater and Talkaround Modes

Follow the procedure to toggle between Repeater and Talkaround modes on your radio.

- 1 Do one of the following:
 - Press the programmed **Repeater/Talkaround** button. Skip the following steps.
 - Press  to access the menu.

- 2 Press  or  to Utilities. Press  to select.

- 3 Press  or  to Radio Settings. Press  to select.

- 4 Press  or  to Talkaround. Press  to select.

If enabled, ✓ appears beside Enabled.

If disabled, ✓ disappears beside Enabled.

The screen automatically returns to the previous screen.

Advanced Features

This chapter explains the operations of the features available in your radio.

Your dealer or system administrator may have customized your radio for your specific needs. Check with your dealer or system administrator for more information.

Home Channel Reminder

This feature provides a reminder when the radio is not set to the home channel for a period of time.

If this feature is enabled through CPS, when your radio is not set to the home channel for a period of time, the following occurs periodically:

- The Home Channel Reminder tone and announcement sound.
- The first line of the display shows `Non`.
- The second line shows `Home Channel`.

You can respond to the reminder by performing one of the following actions:

- Return to the home channel.
- Mute the reminder temporarily using the programmable button.
- Set a new home channel using the programmable button.

Muting the Home Channel Reminder

When the Home Channel Reminder sounds, you can temporarily mute the reminder.



Press the **Silence Home Channel Reminder** programmable button.



The first line of the display shows `HCR` and the second line shows `Silenced`.



Setting New Home Channels





When the Home Channel Reminder occurs, you can set a new home channel.

- 1 Do one of the following:
 - Press the **Reset Home Channel** programmable button to set the current channel as the new Home Channel. Skip the following steps. The first line of the display shows the channel alias and the second line shows `New Home Ch`.
 - Press  to access the menu.
-

- 2 Press  or  to Utilities. Press  to select.
-

3 Press  or  to Radio Settings. Press  to select.

4 Press  or  to Home Channel. Press  to select.

5 Press  or  to the desired new home channel alias. Press  to select.
The display shows  beside the selected home channel alias.



Radio Check

This feature allows you to determine if another radio is active in a system without disturbing the radio user. No audible or visual notification is shown on the target radio. This feature is only applicable for subscriber aliases or IDs. Your radio must be programmed to allow you to use this feature.

Sending Radio Checks

Follow the procedure to send radio checks on your radio.

1 Press the programmed **Radio Check** button.

2 Press  or  to the required alias or ID.
Press  to select.

The display shows a transitional mini notice, indicating the request is in progress. The green LED lights up.

Wait for acknowledgment.

If you press  when the radio is waiting for acknowledgment, a tone sounds, the radio terminates all retries, and exits Radio Check mode.

If successful:

- A positive indicator tone sounds.
- The display shows a positive mini notice.

If unsuccessful:



- A negative indicator tone sounds.
- The display shows a negative mini notice.



The radio returns to the subscriber alias or ID screen.



Sending Radio Checks by Using the Manual Dial

Follow the procedure to send radio checks on your radio by using the manual dial.

- 1 Press  to access the menu.

- 2 Press  or  to **Contacts**. Press  to select.

- 3 Press  or  to **Manual Dial**. Press  to select.

- 4 Press  or  to **Radio Number**. Press  to select.

- 5 Do one of the following:
 - Enter the subscriber alias or ID, and press  to proceed.

- Edit the previously dialed ID, and press  to proceed.

- 6 Press  or  to **Radio Check**. Press  to select.

The display shows a transitional mini notice, indicating the request is in progress. The green LED lights up.

- 7 Wait for acknowledgment.

If you press  when the radio is waiting for acknowledgement, a tone sounds, the radio terminates all retries, and exits Radio Check mode.

If successful:

- A positive indicator tone sounds.
- The display shows a positive mini notice.

If unsuccessful:

- A negative indicator tone sounds.
- The display shows a negative mini notice.

The radio returns to the subscriber alias or ID screen.

Remote Monitor

This feature is used to turn on the microphone of a target radio with a subscriber alias or ID. You can use this feature to remotely monitor any audible activity surrounding the target radio.



Both your radio and the target radio must be programmed to allow you to use this feature.

This feature stops after a programmed duration or when there is any user operation on the target radio.

Initiating Remote Monitor

Follow the procedure to initiate Remote Monitor on your radio.

1 Press the programmed **Remote Monitor** button.

2 Press  or  to the required alias or ID.

3 Press  to select.

The display shows a transitional mini notice, indicating the request is in progress. The green LED lights up.

4 Wait for acknowledgment.

If successful:

- A positive indicator tone sounds.
- The display shows a positive mini notice.
- The audio from the monitored radio starts playing for a programmed duration, and the display shows `Rem. Monitor`. Once the timer expires, an alert tone sounds, and the LED turns off.



If unsuccessful:



- A negative indicator tone sounds.
 - The display shows a negative mini notice.
-



Initiating Remote Monitor by Using the Contacts List

Follow the procedure to initiate Remote Monitor on your radio by using the Contacts list.

- 1 Press  to access the menu.

- 2 Press  or  to Contacts. Press  to select.

- 3 Press  or  to the required alias or ID.
Press  to select.

- 4 Press  or  to Remote Mon..

- 5 Press  to select.
The display shows a transitional mini notice, indicating the request is in progress. The green LED lights up.

- 6 Wait for acknowledgment.

If successful:

- A positive indicator tone sounds.
- The display shows a positive mini notice.
- The audio from the monitored radio starts playing for a programmed duration, and the display shows Rem. Monitor. Once the timer expires, an alert tone sounds, and the LED turns off.



If unsuccessful:



- A negative indicator tone sounds.
- The display shows a negative mini notice.



Initiating Remote Monitor by Using the Manual Dial

Follow the procedure to initiate Remote Monitor on your radio by using the manual dial.



- 1 Press  to access the menu.

2 Press  or  to `Contacts`. Press  to select.

3 Press  or  to `Manual Dial`. Press  to select.

4 Press  or  to `Radio Number`. Press  to select.

5 Do one of the following:

- Enter the subscriber alias or ID, and press  to proceed.
 - Edit the previously dialed ID, and press  to proceed.
-

6 Press  or  to `Remote Mon..`

7 Press  to select.

The display shows a transitional mini notice, indicating the request is in progress. The green LED lights up.

8 Wait for acknowledgment.

If successful:

- A positive indicator tone sounds.
- The display shows a positive mini notice.
- The audio from the monitored radio starts playing for a programmed duration, and the display shows `Rem. Monitor`. Once the timer expires, an alert tone sounds, and the LED turns off.

If unsuccessful:

- A negative indicator tone sounds.
 - The display shows a negative mini notice.
-

Scan Lists

Scan lists are created and assigned to individual channels or groups. Your radio scans for voice activity by cycling

through the channel or group sequence specified in the scan list for the current channel or group.

Your radio can support up to 250 scan lists, with a maximum of 16 members in a list.

Each scan list supports a mixture of both analog and digital entries.

You can add, delete, or prioritize channels by editing a scan list.

You can attach a new scan list to your radio by using Front Panel Programming. See [Front Panel Configuration on page 183](#) for more information.

The **Priority** icon appears on the left of the member alias, if set, to indicate whether the member is on a Priority 1 or Priority 2 channel list. You cannot have multiple Priority 1 or Priority 2 channels in a scan list. There is no **Priority** icon if priority is set to **None**.







NOTICE:



This feature is not applicable in Capacity Plus.



Viewing Entries in the Scan List

Follow the procedure to view the entries in the Scan list on your radio.

- 1 Press  to access the menu.

- 2 Press  or  to Scan. Press  to select.



- 3 Press  or  to Scan List. Press  to select.



- 4 Press  or  to view each member on the list.

Viewing Entries in the Scan List by Using the Alias Search

Follow the procedure to view entries in the Scan list on your radio by using the alias search.

- 1 Press  to access the menu.

- 2 Press  or  to Scan. Press  to select.

3 Press  or  to Scan List. Press  to select.

4 Enter the first character of the required alias.
The display shows a blinking cursor.



5 Enter the rest of the characters of the required alias.
The alias search is case-insensitive. If there are two or more entries with the same name, the display shows the entry listed first in the list.

The first text line shows the characters you entered.
The following text lines show the shortlisted search results.



Adding New Entries to the Scan List



Follow the procedure to add new entries to the Scan list on your radio.



1 Press  to access the menu.



2 Press  or  to Scan. Press  to select.

[Send Feedback](#)



3 Press  or  to Scan List. Press  to select.



4 Press  or  to Add Member. Press  to select.

5 Press  or  to the required alias or ID.
Press  to select.

6 Press  or  to the required priority level.
Press  to select.
The display shows a positive mini notice and then, Add Another?.











7 Do one of the following:

- Press  or  to Yes to add another entry.
Press  to select. Repeat [step 5](#) and [step 6](#).

- Press  or  to No to save the current list.
Press  to select.
-

Adding New Entries to the Scan List by Using the Alias Search

Follow the procedure to add new entries to the Scan list on your radio by using the alias search.



- 1 Press  to access the menu.
 - 2 Press  or  to Scan. Press  to select.
 - 3 Press  or  to Scan List. Press  to select.
 - 4 Press  or  to Add Member. Press  to select.
 - 5 Enter the first character of the required alias.
The display shows a blinking cursor.
-

- 6 Enter the rest of the characters of the required alias.



The alias search is case-insensitive. If there are two or more entries with the same name, the display shows the entry listed first in the list.



The first text line shows the characters you entered. The following text lines show the shortlisted search results.

- 7 Press  to select.
-

- 8 Press  or  to the required priority level.
Press  to select.

The display shows a positive mini notice and then, Add Another?.



- 9 Do one of the following:
 - Press  or  to Yes to add another entry.
Press  to select. Repeat Step [step 5](#) to Step [step 8](#).



- Press  or  to No to save the current list.
Press  to select.
-



Deleting Entries from the Scan List



Follow the procedure to delete entries from the Scan list.

- 1 Press  to access the menu.

 - 2 Press  or  to Scan. Press  to select.







 - 3 Press  or  to Scan List. Press  to select.

 - 4 Press  or  to the required alias or ID.
Press  to select.

 - 5 Press  or  to Delete. Press  to select.
The display shows Delete Entry?.
-

[Send Feedback](#)

- 6 Do one of the following:

- Press  or  to Yes to delete the entry.
Press  to select.
The display shows a positive mini notice.
 - Press  or  to No to return to the previous screen. Press  to select.
-

- 7 Repeat [step 4](#) to [step 6](#) to delete other entries.
-



- 8 Long press  to return to the Home screen after deleting all required aliases or IDs.
-



Setting Priority for Entries in the Scan List

Follow the procedure to set priorities for entries in the Scan list on your radio.



- 1 Press  to access the menu.
-

2 Press  or  to Scan. Press  to select.

3 Press  or  to Scan List. Press  to select.

4 Press  or  to the required alias or ID.
Press  to select.

5 Press  or  to Edit Priority. Press  to select.

6 Press  or  to the required priority level.
Press  to select.

The display shows a positive mini notice before returning to the previous screen. The **Priority** icon appears on the left of the member alias.

Scan

Your radio cycles through the programmed scan list for the current channel looking for voice activity when you start a scan.



NOTICE:

This feature is not applicable in Capacity Plus.

During a dual-mode scan, if you are on a digital channel, and your radio locks onto an analog channel, it automatically switches from digital mode to analog mode for the duration of the call. This is also true for the reverse.

There are two ways of initiating scan:

Main Channel Scan (Manual)

Your radio scans all the channels or groups in your scan list. On entering scan, your radio may, depending on the settings, automatically start on the last scanned active channel or group, or on the channel where scan was initiated.

Auto Scan (Automatic)

Your radio automatically starts scanning when you select a channel or group that has Auto Scan enabled.

**NOTICE:**

When you configure **Receive Group Message In Scan**, your radio is able to receive group messages from non-home channels. Your radio is able to reply the group messages on home channel but is not able to reply on non-home channels. Check with your dealer or system administrator for more information.

- The display shows `Scan On` and **Scan** icon.
- The yellow LED blinks.



If scan is disabled:



- The display shows `Scan Off`.
- The **Scan** icon disappears.
- The LED turns off.



Turning Scan On or Off

Follow the procedure to turn scan on or off on your radio.

- 1 Press  to access the menu.

- 2 Press  or  to `Scan`. Press  to select.

- 3 Press  or  to `Scan State`. Press  to select.

- 4 Press  or  to the required scan state and press  to select.

If scan is enabled:

Responding to Transmissions During Scanning

During scanning, your radio stops on a channel or group where activity is detected. The radio stays on that channel for a programmed duration known as hang time. Follow the procedure to respond to transmissions during scanning.

- 1  If the Channel Free Indication feature is enabled, you hear a short alert tone the moment the transmitting radio releases the **PTT** button, indicating the channel is free for you to respond. Press the **PTT** button during hang time.
The green LED lights up.

- 2 Release the **PTT** button to listen.

The radio returns to scanning other channels or groups if you do not respond within the hang time.

Deleting Nuisance Channels

If a channel continually generates unwanted calls or noise, (termed a "nuisance" channel), you can temporarily remove the unwanted channel from the scan list. This capability does not apply to the channel designated as the Selected Channel. Follow the procedure to delete nuisance channels on your radio.

- 1 When your radio locks on to an unwanted or nuisance channel, press the programmed **Nuisance Channel Delete** button until you hear a tone.
-

- 2 Release the programmed **Nuisance Channel Delete** button.

The nuisance channel is deleted.

Restoring Nuisance Channels

Follow the procedure to restore nuisance channels on your radio.

Do one of the following:

- Turn the radio off and then power it on again.
 - Stop and restart a scan using the programmed **Scan** button or menu.
 - Change the channel using the **Channel Up/Down** button.
-

Vote Scan

Vote Scan provides you with wide area coverage in areas where there are multiple base stations transmitting identical information on different analog channels.

Your radio scans analog channels of multiple base stations and performs a voting process to select the strongest received signal. Once that is established, your radio receives transmissions from that base station.

During a vote scan, the yellow LED blinks and the display shows the **Vote Scan** icon.

Follow the same procedures as [Responding to Transmissions During Scanning on page 377](#), to respond to a transmission during a vote scan.

Contacts Settings

Contacts provides address book capabilities on your radio. Each entry corresponds to an alias or ID that you use to initiate a call. The entries are alphabetically sorted.

Each entry, depending on context, associates with the different call types: Group Call, Private Call, All Call, PC Call, or Dispatch Call.

PC Call and Dispatch Call are data-related. They are only available with the applications. Refer to the data applications documentation for further details.

➊ Additionally, Contacts menu allows you to assign each entry to a programmable number key or more on a keypad microphone. If an entry is assigned to a number key, your radio can perform a quick dial on the entry.



NOTICE:

You see a checkmark before each number key that is assigned to an entry. If the checkmark is before Empty, you have not assign a number key to the entry.

Each entry within Contacts displays the following information:

- Call Type
- Call Alias

- Call ID







NOTICE:



If the Privacy feature is enabled on a channel, you can make privacy-enabled Group Calls, Private Calls, and All Calls on that channel. Only target radios with the same Privacy Key, or the same Key Value and Key ID as your radio will be able to decrypt the transmission.

Making Group Calls by Using the Contacts List

Follow the procedure to make Group Calls on your radio by using the Contacts list.

- 1 Press  to access the menu.

- 2 Press  or  to Contacts. Press  to select.

- 3 Press  or  to the required alias or ID. Press  to select.

- 4 Press the **PTT** button to make the call.
The green LED lights up.
-



- 5 Release the **PTT** button to listen.
The green LED blinks when any user in the group responds. The display shows the **Group Call** icon, and alias or ID, and the transmitting radio alias or ID.
-



- 6  If the Channel Free Indication feature is enabled, you hear a short alert tone the moment the transmitting radio releases the **PTT** button, indicating the channel is free for you to respond. Press the **PTT** button to respond to the call.
The call ends when there is no voice activity for a predetermined period.
-

Making Private Calls by Using the Contacts List

Follow the procedure to make Private Calls on your radio by using the Contacts list.

- 1 Press  to access the menu.
-

- 2 Press  or  to **Contacts**. Press  to select.
-

- 3 Press  or  to the required alias or ID.
Press  to select.
-

- 4 Press the **PTT** button to make the call.
The green LED lights up. The display shows the destination alias.
-

- 5 Wait for the Talk Permit Tone to end and speak clearly into the microphone if enabled.
-

- 6 Release the **PTT** button to listen.
The green LED blinks when the target radio responds. The display shows the transmitting user alias or ID.
-

- 7  If the Channel Free Indication feature is enabled, you hear a short alert tone the moment the



transmitting radio releases the **PTT** button, indicating the channel is free for you to respond. Press the **PTT** button to respond to the call.



The call ends when there is no voice activity for a predetermined period. A tone sounds. The display shows `Call Ended`.

Assigning Entries to Programmable Number Keys







Follow the procedure to assign entries to programmable number keys on your radio.

- 1 Press  to access the menu.

- 2 Press  or  to `Contacts`. Press  to select.

- 3 Press  or  to the required alias or ID.
Press  to select.

- 4 Press  or  to `Program Key`. Press  to select.

- 5 Do one of the following:
 - If the desired number key has not been assigned to an entry, press  or  to the desired number key. Press  to select.
 - If the desired number key has been assigned to an entry, the display shows `The Key is Already Assigned` and then, the first text line shows `Overwrite?`. Do one of the following:
Press  or  to `Yes`. Press  to select.

The radio sounds a positive indicator tone and the display shows `Contact Saved` and a positive mini notice.

Press  or  to `No` to return to the previous step.

Each entry can be associated to different number keys. You see a  before each number key that is

assigned to an entry. If the ✓ is before Empty, that number key is not assigned.



If a number key is assigned to an entry in a particular mode, this feature is not supported when you long press the number key in another mode.



The screen automatically returns to the previous menu.

Removing Associations Between Entries and Programmable Number Keys



Follow the procedure to remove the associations between entries and programmable number keys on your radio.

- 1 Do one of the following:
 - Long press the programmed number key to the required alias or ID. Proceed to [step 4](#).
 - Press  to access the menu.

- 2 Press  or  to Contacts. Press  to select.



- 3 Press  or  to the required alias or ID.

Press  to select.

- 4 Press  or  to Program Key. Press  to select.

- 5 Press  or  to Empty. Press  to select.

The first text line shows Clear from all keys.

- 6 Press  or  to Yes. Press  to select.



NOTICE:

When an entry is deleted, the association between the entry and its programmed number key(s) is removed.



A positive indicator tone sounds. The display shows Contact Saved.



The screen automatically returns to the previous menu.



Adding New Contacts

Follow the procedure to add new contacts on your radio.

- 1 Press  to access the menu.



- 2 Press  or  to Contacts. Press  to select.

- 3 Press  or  to New Contact. Press  to select.

- 4 Press  or  to select contact type Radio Contact or Phone Contact. Press  to select.

- 5 Enter the contact number with the keypad, and press  to proceed.

- 6 Enter the contact name with the keypad, and press  to proceed.

- 7 Press  or  to the required ringer type.



Press  to select.



A positive indicator tone sounds. The display shows a positive mini notice.



Setting Default Contact

Follow the procedure to set the default contact on your radio.

- 1 Press  to access the menu.

- 2 Press  or  to Contacts. Press  to select.

- 3 Press  or  to the required alias or ID.
Press  to select.

- 4 Press  or  to Set as Default. Press  to select.



A positive indicator tone sounds. The display shows a positive mini notice. The display shows  beside the selected default alias or ID.



Call Indicator Settings



This feature allows the radio users to configure call or text message ringing tones.



Activating or Deactivating Call Ringers for Call Alerts



Follow the procedure to activate or deactivate call ringers for Call Alerts on your radio.





- 1 Press  to access the menu.
-
- 2 Press  or  to Utilities. Press  to select.

- 3 Press  or  to Radio Settings. Press  to select.

- 4 Press  or  to Tones/Alert. Press  to select.

- 5 Press  or  to Call Ringers. Press  to select.



- 6 Press  or  to Call Alert. Press  to select.



- 7 Press  or  to the required tone. Press  to select. The display shows  beside the selected tone.



Activating or Deactivating Call Ringers for Private Calls



Follow the procedure to activate or deactivate call ringers for Private Calls on your radio.



- 1 Press  to access the menu.

- 2 Press  or  to Utilities. Press  to select.

- 3 Press  or  to Radio Settings. Press  to select.



- 4 Press  or  to Tones/Alerts. Press  to select.

- 5 Press  or  to Call Ringers. Press  to select.

- 6 Press  or  to Private Call. Press  to select.

The display shows ✓ beside On if Private Call ringing tones are enabled.

The display shows ✓ beside Off if Private Call ringing tones are disabled.



- 7 Press  or  to the required tone. Press  to select.

If enabled, ✓ appears beside Enabled. If disabled, ✓ disappears beside Enabled.



Activating or Deactivating Call Ringers for Selective Calls



Follow the procedure to activate or deactivate call ringers for Selective Calls on your radio.



- 1 Press  to access the menu.

2 Press  or  to Utilities. Press  to select.





3 Press  or  to Radio Settings. Press  to select.

4 Press  or  to Tones/Alerts. Press  to select.

5 Press  or  to Call Ringers. Press  to select.

6 Press  or  to Selective Call. Press  to select.



The display shows  and the current tone.



7 Press  or  to the required tone. Press  to select. The display shows  beside the selected tone.



Activating or Deactivating Call Ringers for Text Messages



Follow the procedure to activate or deactivate call ringers for text messages on your radio.



1 Press  to access the menu.

2 Press  or  to Utilities. Press  to select.



3 Press  or  to Radio Settings. Press  to select.

4 Press  or  to Tones/Alerts. Press  to select.

5 Press  or  to Call Ringers. Press  to select.

- 6 Press  or  to Text Message. Press  to select.

The display shows  and the current tone.



- 7 Press  or  to the required tone. Press  to select.



The display shows  beside the newly selected tone.



Activating or Deactivating Call Ringers for Telemetry Status with Text



Follow the procedure to activate or deactivate call ringers for telemetry status with text on your radio.



- 1 Press  to access the menu.
-

- 2 Press  or  to Utilities. Press  to select.
-

- 3 Press  or  to Radio Settings. Press  to select.
-

- 4 Press  or  to Tones/Alert. Press  to select.
-

- 5 Press  or  to Call Ringers. Press  to select.
-

- 6 Press  or  to Telemetry. Press  to select.



The current tone is indicated by a .



Assigning Ring Styles



The radio can be programmed to sound one of eleven predefined ringing tones when receiving a Private Call, a Call Alert, or a Text Message from a particular contact. The radio sounds out each ring style as you navigate through



the list. Follow the procedure to assign ring styles on your radio.





- 1 Press  to access the menu.

- 2 Press  or  to **Contacts**. Press  to select.
The entries are alphabetically sorted.

- 3 Press  or  to the required alias or ID.
Press  to select.

- 4 Press  or  to **View/Edit**. Press  to select.

- 5 Press  until display shows **Ringer** menu
A  indicates the current selected tone.

- 6 Press  or  to the required tone. Press  to select.
A  appears beside the selected tone.
-

Escalating Alarm Tone Volume

The radio can be programmed to continually alert, when a radio call remains unanswered. This is done by automatically increasing the alarm tone volume over time. This feature is known as Escalart.

Call Log Features

Your radio keeps track of all recent outgoing, answered, and missed Private Calls. The call log feature is used to view and manage recent calls.

Missed Call Alerts may be included in the call logs, depending on the system configuration on your radio. You can perform the following tasks in each of your call lists:



- Store Alias or ID to Contacts
- Delete Call



- Delete All Calls
- View Details

Viewing Recent Calls

Follow the procedure to view recent calls on your radio.



- 1 Press  to access the menu.

- 2 Press  or  to Call Log. Press  to select.

- 3 Press  or  to the preferred list. The options are Missed, Answered, and Outgoing lists.

Press  to select.

The display shows the most recent entry.



- 4 Press  or  to view the list.



You can start a call with the alias or ID the display is currently showing by pressing the **PTT** button.

Deleting Calls from the Call List



Follow the procedure to delete calls from the Call list.

- 1 Press  to access the menu.



- 2 Press  or  to Call Log. Press  to select.

- 3 Press  or  to the required list. Press  to select.





If the list is empty:
 - A tone sounds.
 - The display shows List Empty.



- 4 Press  or  to the required alias or ID.

Press  to select.



- 5 Press  or  to Delete Entry?. Press  to select.

6 Do one of the following:

- Press  to select Yes to delete the entry. The display shows Entry Deleted.
 - Press  or  to No. Press  to select. The radio returns to the previous screen.
-

4 Press  or  to the required alias or ID.

Press  to select.



5 Press  or  to View Details. Press  to select.



The display shows the call details.

Viewing Call List Details

Follow the procedure to view call details on your radio.

1 Press  to access the menu.



2 Press  or  to Call Log. Press  to select.



3 Press  or  to the required list. Press  to select.







Storing Aliases or IDs from the Call List

Follow the procedure to store aliases or IDs on your radio from the Call list.

1 Press  to access the menu.

2 Press  or  to Call Log. Press  to select.

3 Press  or  to the required list. Press  to select.

- 4 Press  or  to the required alias or ID.
Press  to select.
-
- 5 Press  or  to Store. Press  to select.
The display shows a blinking cursor.
-
- 6 Enter the rest of the characters of the required alias.
Press  to select.
You can store an ID without an alias.
The display shows a positive mini notice.
-

Call Alert Operation

Call Alert paging enables you to alert a specific radio user to call you back.

This feature is applicable for subscriber aliases or IDs only and is accessible through the menu using Contacts, manual dial, or a programmed **One Touch Access** button.

Making Call Alerts



Follow the procedure to make Call Alerts on your radio.



- 1 Press the programmed **One Touch Access** button.
The display shows `Call Alert` and the subscriber alias or ID. The green LED lights up.
 - 2 Wait for acknowledgment.
If the Call Alert acknowledgment is received, the display shows a positive mini notice.
If the Call Alert acknowledgment is not received, the display shows a negative mini notice.
-



Making Call Alerts by Using the Contacts List

Follow the procedure to make Call Alerts on your radio by using the Contacts list.

- 1 Press  to access the menu.
-

2 Press  or  to **Contacts**. Press  to select.

3 Press  or  to the required alias or ID.
Press  to select.

4 Press  or  to **Call Alert**. Press  to select.
The display shows **Call Alert** and the subscriber alias or ID. The green LED lights up.



5 Wait for acknowledgment.



- If the Call Alert acknowledgment is received, the display shows a positive mini notice.
- If the Call Alert acknowledgment is not received, the display shows a negative mini notice.

Making Call Alerts by Using the Manual Dial

Follow the procedure to make Call Alerts on your radio by using the manual dial.



1 Press  to access the menu.

2 Press  or  to **Contacts**. Press  to select.

3 Press  or  to **Manual Dial**. Press  to select.

The display shows a blinking cursor.

4 Enter the subscriber ID and press  to proceed.

5 Press  or  to **Call Alert**. Press  to select.

The display shows **Call Alert** and the subscriber alias or ID. The green LED lights up.

- 6 Wait for acknowledgment.
 - If the Call Alert acknowledgment is received, the display shows a positive mini notice.
 - If the Call Alert acknowledgment is not received, the display shows a negative mini notice.
-

- Press the **PTT** button to continue normal talkgroup communication. The Call Alert is moved to the Missed Call option at the Call Log menu. You can respond to the caller from the Missed Called log.
-

See [Notification List on page 180](#) and [Call Log Features on page 122](#) for more information.

Responding to Call Alerts

Follow the procedure to respond to Call Alerts on your radio.

When you receive a Call Alert:

- A repetitive tone sounds.
- The yellow LED blinks.
- The display shows the notification list listing a Call Alert with the alias or ID of the calling radio.

Depending on the configuration by your dealer or system administrator, you can respond to a Call Alert by doing one of the following:

- Press the **PTT** button and respond with a Private Call directly to the caller.

Mute Mode

Mute Mode provides an option to the user to silence all audio indicators of the radio.

Once Mute Mode feature is initiated, all audio indicators are muted except higher priority features such as Emergency operations.

When Mute Mode is exited, the radio resumes playing ongoing tones and audio transmissions.



NOTICE:

This is a purchasable feature. Check with your dealer or system administrator for more information.

Turning On Mute Mode

Follow the procedure to turn on Mute Mode.

Access this feature by using the programmed **Mute Mode** button.

The following occurs when Mute mode is enabled:



- Positive Indicator Tone sounds.
- Display shows Mute Mode On.
- The red LED light starts blinking and remains blinking until Mute Mode is exited.
- Display shows **Mute Mode** icon on home screen.
- Radio is muted.
- Mute Mode Timer begins counting down the duration that is configured.

Setting Mute Mode Timer

Mute Mode feature can be enabled for a pre-configured amount of time by setting the Mute Mode Timer. The timer duration is configured in the radio menu and can range between 0.5–6 hours. Mute Mode is exited once the timer expires.



If the timer is left at 0, the radio remains in Mute mode for an indefinite period until the programmed **Mute Mode** button is pressed.

- 1 Press  to access the menu.

- 2 Press  or  to Utilities. Press  to select.

- 3 Press  or  to Radio Settings. Press  to select.

- 4 Press  or  to Mute Timer. Press  to select.

- 5 Press  or  to edit the numeric value of each digit, and press .

Exiting Mute Mode

This feature can be exited automatically once the Mute Mode Timer expires.

Do one of the following to exit Mute mode manually:

- Press the programmed **Mute Mode** button.
- Press the **PTT** button on any entry.

The following occurs when Mute mode is disabled:

- Negative Indicator Tone sounds.
- Display shows `Mute Mode Off`.
- The blinking red LED turns off.
- **Mute Mode** icon disappears from home screen.
- Your radio unmutes and speaker state is restored.
- If the timer has not expired, Mute mode timer is stopped.



NOTICE:

Mute Mode is also exited if the user transmits voice or switches to an unprogrammed channel.

Emergency Operation

An Emergency Alarm is used to indicate a critical situation. You are able to initiate an Emergency at any time even when there is activity on the current channel.

Your dealer can set the duration of a button press for the programmed **Emergency** button, except for long press, which is similar with all other buttons:

Short Press

Duration between 0.05 seconds and 0.75 seconds.

Long Press

Duration between 1.00 second and 3.75 seconds.

The **Emergency** button is assigned with the Emergency On/Off feature. Check with your dealer for the assigned operation of the **Emergency** button.



NOTICE:

If a short press to the **Emergency** button initiates Emergency mode, then a long press to the same enables the radio to exit Emergency mode.

If a long press to the **Emergency** button initiates Emergency mode, then a short press to the same enables the radio to exit Emergency mode.

Your radio supports three Emergency Alarms:

- Emergency Alarm

- Emergency Alarm with Call
- Emergency Alarm with Voice to Follow 



NOTICE:

Only one of the Emergency Alarms above can be assigned to the programmed **Emergency** button or the Emergency footswitch.

In addition, each alarm has the following types:

Regular

Radio transmits an alarm signal and shows audio and/or visual indicators.

Silent

Radio transmits an alarm signal without any audio or visual indicators. Radio receives calls without any sound through the speaker, until the programmed *hot mic* transmission period is over and/or you press the **PTT** button.

Silent with Voice

Radio transmits an alarm signal without any audio or visual indicators, but allow incoming calls to sound through the speaker.





Receiving Emergency Alarms

Follow the procedure to receive Emergency Alarms on your radio.

When you receive an Emergency Alarm:

- A tone sounds.
- The red LED blinks.
- The display shows the **Emergency** icon, and the Emergency caller alias or if there is more than one alarm, all emergency caller aliases are displayed in an Alarm List.

1 Do one of the following:

- If only one alarm, press  to view more details.
- If more than one alarm, press  or  to the required alias, and press  to view more details.

2 Press to view the action options.

- 3 Press  and select Yes to exit the Alarm list.



- 4 Press  to access the menu.

- 5 Select `Alarm List` to revisit the Alarm list.

- 6 The tone sounds and the LED blinks red until you exit the Emergency mode. However, the tone can be silenced. Do one of the following:
 - Press the **PTT** button to call the group of radios which received the Emergency Alarm.
 - Press any programmable button.
 - Exit Emergency mode. See [Exiting Emergency Mode After Receiving the Emergency Alarm on page 398](#).

Responding to Emergency Alarms

Follow the procedure to respond to Emergency Alarms on your radio.

- 1 Make sure the display shows the Alarm List. Press  or  to the required alias or ID.

- 2  If the Channel Free Indication feature is enabled, you hear a short alert tone the moment the transmitting radio releases the **PTT** button, indicating the channel is free for you to respond. Press the **PTT** button to transmit non-emergency voice to the same group the Emergency Alarm targeted.
The green LED lights up. Your radio remains in the Emergency mode.

- 3 Do one of the following:
 - Wait for the Talk Permit Tone to end and speak clearly into the microphone if enabled.
 -  Wait for the **PTT** Sidetone to end and speak clearly into the microphone if enabled.

- 4 Release the **PTT** button to listen.
When the emergency initiating radio responds:
 - The green LED blinks.

- The display shows the **Group Call** icon and ID, transmitting radio ID, and the Alarm list.

Emergency voice can only be transmitted by the emergency initiating radio. All other radios, including the emergency receiving radio, transmit non-emergency voice.

Exiting Emergency Mode After Receiving the Emergency Alarm

Do one of the following to exit Emergency mode after receiving Emergency alarm:

- Delete the alarm items.
- Power down the radio.

Sending Emergency Alarms

This feature allows you to send an Emergency Alarm, a non-voice signal, which triggers an alert indication on a group of radios. Your radio does not display any audio or visual indicators during Emergency mode when it is set to Silent.

Follow the procedure to send Emergency Alarms on your radio.

- 1 Press the programmed **Emergency On** button.

You see one of these results:

- The display shows Tx Alarms and the destination alias.
-  The display shows Tx Telegram and the destination alias.

The green LED lights up. The **Emergency** icon appears.



NOTICE:

If programmed, the Emergency Search tone sounds. This tone is muted when the radio transmits or receives voice, and stops when the radio exits Emergency mode. The Emergency Search tone can be programmed through CPS.

- 2 Wait for acknowledgment.

If successful:

- The Emergency tone sounds.
- The red LED blinks.
- The display shows Alarm Sent.

If unsuccessful after all retries have been exhausted:

- A tone sounds.
- The display shows `Alarm Failed`.

The radio exits the Emergency Alarm mode and returns to the Home screen.



NOTICE:

If programmed, the Emergency Search tone sounds. This tone is muted when the radio transmits or receives voice, and stops when the radio exits Emergency mode. The Emergency Search tone can be programmed by your dealer or system administrator.

Sending Emergency Alarms with Call

This feature allows you to send an Emergency Alarm with Call to a group of radios. Upon acknowledgement by a radio within the group, the group of radios can communicate over a programmed Emergency channel. Follow the procedure to send Emergency Alarms with call on your radio.

- 1 Press the programmed **Emergency On** button or the **Emergency** footswitch. The display shows Sending Alarm, which alternates with your radio ID.

You see the following:

- The display shows `Tx Telegram` and the destination alias.

The green LED lights up. The **Emergency** icon appears.

[Send Feedback](#)

- 2 Wait for acknowledgment.

If successful:

- The Emergency tone sounds.
- The red LED blinks.
- The display shows `Alarm Sent`.
- Your radio enters the Emergency call mode when the display shows `Emergency` and the destination group alias.

- 3 Press the **PTT** button to make the call.

The green LED lights up. The display shows the **Group Call** icon.

- 4 Do one of the following:

- Wait for the Talk Permit Tone to end and speak clearly into the microphone if enabled.
-  Wait for the **PTT** Sidetone to end and speak clearly into the microphone if enabled.

5 Release the **PTT** button to listen.

The display shows the caller and group aliases.

-
- #### 6 If the Channel Free Indication feature is enabled, you hear a short alert tone the moment the transmitting radio releases the **PTT** button, indicating the channel is free for you to respond. Press the **PTT** button to respond to the call.

-
- #### 7 To exit the Emergency mode once the call ends, press the **Emergency Off** button.

The radio returns to the Home screen.

Emergency Alarms with Voice to Follow

This feature allows you to send an Emergency Alarm with Voice to Follow to a group of radios. Your radio microphone

is automatically activated, allowing you to communicate with the group of radios without pressing the **PTT** button. This activated microphone state is also known as *hot mic*.



NOTICE:

Your radio cannot detect a non-IMPRES microphone that is attached to the rear accessory connector.

When no microphone is detected at the specified programmed connector, your radio checks the alternative connector. Here, your radio gives priority to the detected microphone.

If your radio has Emergency Cycle Mode enabled, repetitions of *hot mic* and receiving period are made for a programmed duration. During Emergency Cycle Mode, received calls sound through the speaker.

If you press the **PTT** button during the programmed receiving period, you hear a prohibit tone, indicating that you should release the **PTT** button. The radio ignores the **PTT** button press and remains in Emergency mode.

If you press the **PTT** button during *hot mic*, and continue to press it after the *hot mic* duration expires, the radio continues to transmit until you release the **PTT** button.

If the Emergency Alarm request fails, the radio does not retry to send the request, and enters the *hot mic* state directly.



NOTICE:

Some accessories may not support *hot mic*. Check with your dealer or system administrator for more information.

Sending Emergency Alarms with Voice to Follow

Follow the procedure to send Emergency Alarms with voice to follow on your radio.

- 1 Press the programmed **Emergency On** button or the **Emergency** footswitch.

You see one of these results:

- The display shows Tx Alarm and the destination alias.
- The display shows Tx Telegram and the destination alias.

The green LED lights up. The **Emergency** icon appears.

- 2 Once the display shows Alarm Sent, speak clearly into the microphone.

The radio automatically stops transmitting when:

- The cycling duration between *hot mic* and receiving calls expires, if Emergency Cycle Mode is enabled.
- The *hot mic* duration expires, if Emergency Cycle Mode is disabled.

-
- 3 Press the **Emergency Off** button to exit the Emergency mode.

The radio returns to the Home screen.

Reinitiating Emergency Mode

This feature is only applicable to the radio sending the Emergency Alarm. Follow the procedure to reinitiate Emergency mode on your radio.

Do one of the following:

- Change the channel while the radio is in Emergency mode. The radio exits the Emergency

mode, and reinitiates Emergency, if Emergency Alarm is enabled on the new channel.

- Press the programmed **Emergency On** button during an Emergency initiation or transmission state. The radio exits this state, and reinitiates Emergency.

Exiting Emergency Mode After Sending the Emergency Alarm

This feature is only applicable to the radio sending the Emergency Alarm.

Your radio exits Emergency mode when:

- An acknowledgment is received (for Emergency Alarm only).
- All retries to send the alarm have been exhausted.



NOTICE:

If your radio is powered off, it exits the Emergency mode. The radio does not reinitiate the Emergency mode automatically when it is turned on again.







Follow the procedure to exit Emergency mode on your radio.

Do one of the following:

- Press the programmed **Emergency Off** button.
- Change the channel to a new channel that has no emergency system configured.
The display shows No Emergency.

Deleting an Alarm Item from the Alarm List

Follow the procedure to delete the alarm items from the Alarm List, to exit Emergency mode.

- 1 Press  to access the menu.
-
- 2 Press  or  to Alarm List. Press  to select.
-
- 3 Press  or  to the required alarm item.
Press  to select.

- 4 Press  or  to Delete. Press  to select.
-

Text Messaging

Your radio is able to receive data, for example a text message, from another radio or a text message application.

There are two types of text messages, Digital Mobile Radio (DMR) Short Text Message and text message. The maximum length of a DMR Short Text Message is 23 characters. The maximum length of a text message is 280 characters, including the subject line. The subject line only appears when you receive messages from e-mail applications.



NOTICE:

The maximum character length is only applicable for models with the latest software and hardware. For radio models with older software and hardware, the maximum length of a text message is 140 characters. Check with your dealer or system administrator for more information.



Text Messages



The text messages are stored in an Inbox, and sorted according to the most recently received.



Viewing Text Messages

Follow the procedure to view text messages on your radio.

- 1 Press  to access the menu.

 - 2 Press  or  to Messages. Press  to select.











 - 3 Press  or  to Inbox. Press  to select.
If the Inbox is empty:
 - The display shows List Empty.
 - A tone sounds, if the Keypad Tone is turned on.
-

- 4 Press  or  to the required message. Press  to select.

The display shows a subject line if the message is from an e-mail application.

Viewing Telemetry Status Text Messages

Follow the procedure to view a telemetry status text message from the inbox.

- 1 Press  to access the menu.
-
- 2 Press  or  to Messages. Press  to select.
-
- 3 Press  or  to Inbox. Press  to select.
-
- 4 Press  or  to the required message. Press  to select.

You cannot reply to a Telemetry Status text message.

The display shows Telemetry: <Status Text Message>.

- 5 Long press  to return to the Home screen.

Responding to Text Messages

Follow the procedure to respond to text messages on your radio.

When you receive a text message:









- The display shows the Notification list with the alias or ID of the sender.
- The display shows the **Message** icon.





NOTICE:

The radio exits the Text Message alert screen and sets up a Private or Group Call to the sender of the message if the **PTT** button is pressed.

- 1 Do one of the following:

- Press  or  to Read. Press  to select.
The display shows the text message. The display shows a subject line if the message is from an e-mail application.
- Press  or  to Read Later. Press  to select.
The radio returns to the screen you were on prior to receiving the text message.
- Press  or  to Delete. Press  to select.

2 Do one of the following:

- Press  to return to inbox.
 - Press  a second time to reply, forward, or delete the text message.
-



Responding to Text Messages with Quick Text

Follow the procedure to respond to text messages with Quick Text messages on your radio.

1 Do one of the following:

- Press the programmed **Text Message** button.
Proceed to Step [step 3](#).
- Press  to access the menu.



2

Press  or  to Messages. Press  to select.

3



Press  or  to Inbox. Press  to select.



4



Press  or  to the required message. Press  to select.

The display shows a subject line if the message is from an e-mail application.

5 Press  to access the sub-menu.

6 Press  or  to Reply. Press  to select.

7 Press  or  to Quick Reply. Press  to select.

8 Press  or  to the required message. Press  to select.

The display shows a transitional mini notice, confirming the message is being sent.

9 Wait for acknowledgment.

If successful:

- A tone sounds.
- The display shows a positive mini notice.

If unsuccessful:

- A tone sounds.
- The display shows a negative mini notice.

- The radio returns to the Resend option screen.
-

Resending Text Messages

Follow the procedure to resend text messages on your radio.

When you are at the Resend option screen:

Press  to resend the same message to the same subscriber or group alias or ID.

If successful:

- A positive indicator tone sounds.
- The display shows a positive mini notice.



If unsuccessful:



- A negative indicator tone sounds.
 - The display shows a negative mini notice.
 - The radio returns to the Resend option screen.
-

Forwarding Text Messages

Follow the procedure to forward text messages on your radio.

When you are at the **Resend** option screen:

- 1 Press  or  to **Forward**, and press  to send the same message to another subscriber or group alias or ID.

- 2 Press  or  to the required alias or ID.
Press  to select.

The display shows a transitional mini notice, confirming your message is being sent.

- 3 Wait for acknowledgment.

If successful:

- A positive indicator tone sounds.
- The display shows a positive mini notice.

If unsuccessful:

- A negative indicator tone sounds.

- The display shows a negative mini notice.



NOTICE:



You can also manually select a target radio address (see [Forwarding Text Messages by Using the Manual Dial on page 407](#)).

Forwarding Text Messages by Using the Manual Dial

Follow the procedure to forward text messages by using the manual dial on your radio.

- 1 Press  or  to **Forward**. Press  to select.

- 2 Press  to send the same message to another subscriber or group alias or ID.

- 3 Press  or  to **Manual Dial**. Press  to select.

The display shows **Radio Number:.**

- 4 Enter the subscriber ID, and press  to proceed.
The display shows a transitional mini notice, confirming your message is being sent.
-

- 5 Wait for acknowledgment.

If successful:

- A tone sounds.
- The display shows a positive mini notice.

If unsuccessful:

- A tone sounds.
 - The display shows a negative mini notice.
-



Editing Text Messages

Select **Edit** to edit the message.









NOTICE:

If a subject line is present (for messages received from an e-mail application), you cannot edit it.







- 1 Press  or  to **Edit**. Press  to select.
The display shows a blinking cursor.
-

- 2 Use the keypad to edit your message.

- Press  to move one space to the left.
 - Press  or  to move one space to the right.
 - Press  to delete any unwanted characters.
 - Long press  to change text entry method.
-

- 3 Press  once message is composed.
-

- 4 Do one of the following:



- Press  or  to **Send** and press  to send the message.
- Press  or  to **Save** and press  to save the message to the Drafts folder.
- Press  to edit the message.

- Press  to choose between deleting the message or saving it to the Drafts folder.

Writing Text Messages

Follow the procedure to write text message on your radio.

- 1 Do one of the following:
 - Press the programmed **Text Message** button. Proceed to [step 3](#).
 - Press  to access the menu.

- 2 Press  or  to Messages. Press  to select.

- 3 Press  or  to Compose. Press  to select.

A blinking cursor appears.

- 4 Use the keypad to type your message.

Press  to move one space to the left.





Press  or  to move one space to the right.

Press  to delete any unwanted characters.

Long press  to change text entry method.

- 5 Press  once message is composed.

Do one of the following:







- Press  to send the message.
- Press . Press  or  to choose among editing, deleting, or saving the message. Press  to select.

Sending Text Messages

Follow the procedure to send text message on your radio.

It is assumed that you have a newly written text message or a saved text message.

Select the message recipient. Do one of the following:

- Press  or  to the required alias or ID. Press  to select.
- Press  or  to Manual Dial. Press  to select. Key in the subscriber ID. The first line of the display shows `Radio Number:`. The second line of the display shows a blinking cursor. Key in the subscriber alias or ID. Press .

The display shows transitional mini notice, confirming your message is being sent.

If successful:

- A tone sounds.
- The display shows positive mini notice.

If unsuccessful:

- A low tone sounds.
- The display shows negative mini notice.
- The message is moved to the Sent Items folder.
- The message is marked with a Send Failed icon.



NOTICE:

For a newly written text message, the radio returns you to the Resend option screen.

Deleting Text Messages from the Inbox

Follow the procedure to delete text messages from the Inbox on your radio.

1 Do one of the following:



- Press the programmed **Text Message** button. Proceed to [step 3](#).
- Press  to access the menu.

2 Press or to Messages. Press to select.

3 Press or to Inbox. Press to select.

If the Inbox is empty:



- The display shows `List Empty`.
 - A tone sounds.
-

- 4 Press  or  to the required message. Press  to select.

The display shows a subject line if the message is from an e-mail application.

- 5 Press  to access the sub-menu.
-

- 6 Press  or  to Delete. Press  to select.
-

- 7 Press  or  to Yes. Press  to select.

The display shows a positive mini notice. The screen returns to the Inbox.

Deleting All Text Messages from the Inbox









Follow the procedure to delete all text messages from the Inbox on your radio.

- 1 Do one of the following:



- Press the programmed **Text Message** button. Proceed to [step 3](#).



- Press  to access the menu.
-

- 2 Press  or  to Messages. Press  to select.
-

- 3 Press  or  to Inbox. Press  to select. If the Inbox is empty:

- The display shows List Empty.
 - A tone sounds.
-

- 4 Press  or  to Delete All. Press  to select.
-

- 5 Press  or  to Yes. Press  to select. The display shows a positive mini notice.
-

Sent Text Messages

Once a message is sent to another radio, it is saved in Sent Items folder. The most recent sent text message is always added to the top of the Sent Items folder. You can resend, forward, edit, or delete a Sent text message.

The Sent Items folder is capable of storing a maximum of 30 last sent messages. When the folder is full, the next sent text message automatically replaces the oldest text message in the folder.

If you exit the message sending screen while the message is being sent, the radio updates the status of the message in the Sent Items folder without providing any indication in the display or via sound.

If the radio changes mode or powers down before the status of the message in Sent Items folder is updated, the radio cannot complete any In-Progress messages and automatically marks it with a **Send Failed** icon.

The radio supports a maximum of five In-Progress messages at one time. During this period, the radio cannot send any new message and automatically marks it with a **Send Failed** icon.

If you long press  at any time, the radio returns to the Home screen.







NOTICE:



If the channel type, for example a conventional digital or Capacity Plus channel, is not a match, you can only edit, forward, or delete a Sent message.

Viewing Sent Text Messages

Follow the procedure to view sent text messages on your radio.

- 1 Do one of the following:
 - Press the programmed **Text Message** button. Proceed to [step 3](#).
 - Press  to access the menu.



-
- 2 Press  or  to Messages. Press  to select.

-
- 3 Press  or  to Sent Items. Press  to select.

If the Sent Items folder is empty:

- The display shows `List Empty`.

- A low tone sounds, if the Keypad Tone is turned on.



-
- 4 Press  or  to the required message. Press  to select.



The icon at the top right corner of the screen indicates the status of the message. See [Sent Item Icons](#).

Sending Sent Text Messages

Follow the procedure to send a sent text message on your radio.

When you are viewing a Sent message:

- 1 Press  while viewing the message.
-
- 2 You can either resend or forward the sent text message. Do one of the following:
 -  to Resend. Press  to select.

-  to Forward. Press  to select.

The display shows a transitional mini notice, confirming your message is being sent.

- 3 Wait for acknowledgment.

If successful:

- A positive indicator tone sounds.
- The display shows a positive mini notice.

If unsuccessful:



- A negative indicator tone sounds.
 - The display shows a negative mini notice.
 - The radio proceeds to the Resend option screen. See [Resending Text Messages on page 146](#) for more information.
-

Deleting Sent Text Messages from the Sent Items Folder

Follow the procedure to delete sent text messages from the Sent Items folder on your radio.

When you are viewing a Sent message:



- 1 Press  .



- 2 Press  or  to Delete. Press  to select.

Deleting All Sent Text Messages from the Sent Items Folder

Follow the procedure to delete all sent text messages from the Sent Items folder on your radio.



- 1 Do one of the following:
 - Press the programmed **Text Message** button. Proceed to [step 3](#).
 - Press  to access the menu.







- 2 Press  or  to Messages. Press  to select.

- 3 Press  or  to Sent Items. Press  to select.

If the Sent Items folder is empty:

- The display shows List Empty.
- A tone sounds.

- 4 Press  or  to Delete All. Press  to select.

- 5 Do one of the following:
 - Press  or  to Yes. Press  to select.
The display shows a positive mini notice.
 - Press  or  to No. Press  to select.
The radio returns to the previous screen.

Saved Text Messages

You can save a text message to send it at a later time.

If a **PTT** button press or a mode change causes the radio to exit the text message writing/editing screen while you are in the process of writing or editing a text message, your current text message is automatically saved to the Drafts folder.



The most recent saved text message is always added to the top of the Drafts list.

The Drafts folder stores a maximum of 10 last saved messages. When the folder is full, the next saved text message automatically replaces the oldest text message in the folder.



Viewing Saved Text Messages

Follow the procedure to view saved text message on your radio.

- 1 Do one of the following:
 - Press the programmed **Text Message** button. Proceed to [step 3](#).
 - Press  to access the menu.





- 2 Press  or  to Messages. Press  to select.

- 3 Press  or  to Drafts. Press  to select.

- 4 Press  or  to the required message. Press  to select.

Editing Saved Text Messages

Follow the procedure to edit saved text message on your radio.

- 1 Press  while viewing the message.
- 2 Press  or  to Edit. Press  to select. A blinking cursor appears.
- 3 Use the keypad to type your message.

Press  to move one space to the left.







Press  or  to move one space to the right.

Press  to delete any unwanted characters.

Long press  to change text entry method.

4 Press  once message is composed.

Do one of the following:

- Press  or  to Send. Press  to send the message.
- Press . Press  or  to choose between saving or deleting the message. Press  to select.

Deleting Saved Text Messages from the Drafts Folder



Follow the procedure to delete saved text message from drafts on your radio.



1 Do one of the following:

- Press the programmed **Text Message** button. Proceed to [step 3](#).
- Press  to access the menu.

2 Press  or  to Messages. Press  to select.

3 Press  or  to Drafts. Press  to select.

4 Press  or  to the required message. Press  to select.

5 Press  or  to Delete. Press  to delete the text message.

Quick Text Messages



Your radio supports a maximum of 50 Quick Text messages as programmed by your dealer.



While Quick Text messages are predefined, you can edit each message before sending it.



Sending Quick Text Messages

Follow the procedure to send predefined Quick Text messages on your radio to a predefined alias.

- 1 Do one of the following:
 - Press the programmed **Text Message** button. Proceed to [step 6](#).
 - Press the programmed **One Touch Access** button.
The display shows a transitional mini notice, confirming your message is being sent.
Proceed to [step 6](#).
 - Press  to access the menu.
-

- 2 Press  or  to **Messages**. Press  to select.
-

- 3 Press  or  to **Quick Text**. Press  to select.
-

- 4 Press  or  to the required Quick Text message. Press  to select.
-

- 5 Do the following to select the recipient and send the message.

The display shows a transitional mini notice, confirming that your message is being sent.

- 6 Wait for acknowledgment.

If successful:

- A positive indicator tone sounds.
- The display shows a positive mini notice.

If unsuccessful:

- A negative indicator tone sounds.

- The display shows a negative mini notice.
- The radio proceeds to the Resend option screen. See [Resending Text Messages on page 146](#) for more information.

Text Entry Configuration

Your radio allows you to configure different text.

You can configure the following settings for entering text on your radio:



- Word Predict
- Word Correct
- Sentence Cap
- My Words

Your radio supports the following text entry methods:

- Numbers
- Symbols
- Predictive or Multi-Tap
- Language (If programmed)















NOTICE:

Press  at any time to return to the previous screen or long press  to return to the Home Screen. The radio exits the current screen once the inactivity timer expires.



Enabling or Disabling Word Correct

Supplies alternative word choices when the word entered into the text editor is not recognized by the in-built dictionary.

- 1 Press  to access the menu.
- 2 Press  or  to Utilities. Press  to select.
- 3 Press  or  to Radio Settings. Press  to select.
- 4 Press  or  to Text Entry. Press  to select.

5 Press  or  to Word Correct. Press  to select.



6 Do one of the following:

- Press  or  to Word Correct. Press  to select.
 - Press to enable Word Correct. If enabled, ✓ appears beside Enabled.
 - Press to disable Word Correct. If disabled, ✓ disappears beside Enabled.
-



Enabling or Disabling Word Predict



Word Predict: Your radio can learn common word sequences that you often enter. It then predicts the next word you may want to use after you enter the first word of a common word sequence into the text editor.

1 Press  to access the menu.



2 Press  or  to Utilities. Press  to select.

3 Press  or  to Radio Settings. Press  to select.

4 Press  or  to Text Entry. Press  to select.

5 Press  or  to Word Predict. Press  to select.



6 Do one of the following:



- Press  to enable the Word Predict. If enabled, ✓ appears beside Enabled.
 - Press  to disable Microphone Dynamic Distortion Control. If disabled, ✓ disappears beside Enabled.
-



Sentence Cap



This feature is used to automatically enable capitalization of the first letter in the first word for every new sentence.

- 1 Press  **OK** to access the menu.



- 2 Press  or  to Utilities. Press  **OK** to select.

- 3 Press  or  to Radio Settings. Press  **OK** to select.

- 4 Press  or  to Text Entry. Press  **OK** to select.

- 5 Press  or  to Sentence Cap. Press  **OK** to select.



- 6 Do one of the following:



- Press  **OK** to enable Sentence Cap. If enabled, ✓ appears beside Enabled.
- Press  **OK** to disable Sentence Cap. If disabled, ✓ disappears beside Enabled.



Viewing Custom Words



You can add your own custom words into the in-built dictionary of your radio. Your radio maintains a list to contain these words.



- 1 Press  **OK** to access the menu.

- 2 Press  or  to Utilities. Press  **OK** to select.

- 3 Press  or  to Radio Settings. Press  **OK** to select.

4 Press  or  to Text Entry. Press  to select.



5 Press  or  to My Words. Press  to select.



6 Press  or  to List of Words. Press  to select.
The display shows the list of custom words.



Editing Custom Words



You can edit custom words saved in your radio.



1 Press  to access the menu.



2 Press  or  to Utilities. Press  to select.

3 Press  or  to Radio Settings. Press  to select.

4 Press  or  to Text Entry. Press  to select.





5 Press  or  to My Words. Press  to select.

6 Press  or  to List of Words. Press  to select.
Display shows the list of custom words.

7 Press  or  to the required word. Press  to select.

8 Press  or  to Edit. Press  to select.

9 Use the keypad to edit your custom word.

- Press  to move one space to the left.
- Press  key to move one space to the right.
- Press the  key to delete any unwanted characters.
- Long press  to change text entry method.

10 Press  once your custom word is completed.



The display shows transitional mini notice, confirming your custom word is being saved.

- If the custom word is saved, a tone sounds and the display shows positive mini notice.
- If the custom word is not saved, a low tone sounds and the display show negative mini notice.



Adding Custom Words



You can add custom words into the in-built radio dictionary.



1 Press  to access the menu.

2 Press  or  to Utilities. Press  to select.

3 Press  or  to Radio Settings. Press  to select.



4 Press  or  to Text Entry. Press  to select.



5 Press  or  to My Words. Press  to select.

6 Press  or  to Add New Word. Press  to select.

Display shows the list of custom words.

7 Use the keypad to edit your custom word.

- Press  to move one space to the left.
- Press  key to move one space to the right.

- Press the  key to delete any unwanted characters.
- Long press  to change text entry method.

8 Press  once your custom word is completed.



The display shows transitional mini notice, confirming your custom word is being saved.



- If the custom word is saved, a tone sounds and the display show positive mini notice.
- If the custom word is not saved, a low tone sounds and the display show negative mini notice.



Deleting a Custom Word



Follow the procedure to delete the custom words saved in your radio.



1 Press  to access the menu.

2 Press  or  to Utilities. Press  to select.

3 Press  or  to Radio Settings. Press  to select.





4 Press  or  to Text Entry. Press  to select.

5 Press  or  to My Words. Press  to select.

6 Press  or  to the required word. Press  to select.

7 Press  or  to Delete. Press  to select.



8 Choose one of the following.



- At Delete Entry?, press  to select Yes. The display shows Entry Deleted.
- Press  or  to No. Press  to return to the previous screen.



Deleting All Custom Words



Follow the procedure to delete all custom words from the in-built dictionary of your radio.



- 1 Press  to access the menu.

- 2 Press  or  to Utilities. Press  to select.





- 3 Press  or  to Radio Settings. Press  to select.

- 4 Press  or  to Text Entry. Press  to select.

- 5 Press  or  to My Words. Press  to select.

- 6 Press  or  to Delete All. Press  to select.

7 Do one of the following:

- At Delete Entry?, press  to select Yes. The display shows All Entries Deleted.
 - Press  or  to No to return to the previous screen. Press  to select.
-

Job Tickets

This feature allows your radio to receive messages from the dispatcher listing out tasks to perform.



NOTICE:

This feature can be customized through CPS according to user requirements. Check with your dealer or system administrator for more information.

There are two folders that contain different Job Tickets:

My Tasks folder

Personalized Job Tickets assigned to your signed in user ID.

Shared Tasks folder

Shared Job Tickets assigned to a group of individuals.

You can respond to Job Tickets in order to sort them into Job Ticket Folders. By default, the folders are **All**, **New**, **Started**, and **Completed**. Check with your dealer or system administrator for an additional 10 folders.



NOTICE:

Job Tickets are retained even after the radio is powered down and powered up again.

All Job Tickets are located in the **All** folder. Depending on how your radio is programmed, Job Tickets are sort by their priority level followed by time received. New Job Tickets, Job Tickets with recent changes in state, and Job Tickets with the highest priority are listed first. Upon reaching the maximum number of Job Tickets, the next Job Ticket automatically replaces the last Job Ticket in your radio. Your radio supports a maximum of 100 or 500 Job Tickets, depending on your radio model. Check with your dealer or system administrator for more information. Your radio automatically detects and discards duplicated Job Tickets with the same Job Ticket ID.

Depending on the importance of the Job Tickets, the dispatcher adds a Priority Level to them. There are three priority levels: Priority 1, Priority 2, and Priority 3. Priority 1 has the highest priority and Priority 3 has the lowest priority. There are also Job Tickets with no priority.

Your radio updates accordingly when dispatcher makes the following changes:

- Modify content of Job Tickets.
- Add or edit Priority Level of Job Tickets.
- Move Job Tickets from folder to folder.
- Canceling of Job Tickets.



Accessing the Job Ticket Folder



Follow the procedure to access the Job Ticket folder.

1 Do one of the following:

- Press the programmed **Job Ticket** button. Proceed to [step 3](#).
- Press  to access the menu.





2 Press  or  to Job Tickets. Press  to select.

3 Press  or  to the required folder. Press  to select.

- 4 Press  or  to the required Job Ticket.
Press  to select.
-

Logging In or Out of the Remote Server

This feature allows you to log in and log out of the remote server by using your user ID.

- 1 Press  to access the menu.
-
- 2 Press  or  to Log In. Press  to select.
If you are already logged in, menu displays Log Out.
The display shows a transitional mini notice, indicating the request is in progress.
-

- 3 Wait for acknowledgment.
If successful:
- A positive indicator tone sounds.
 - The display shows a positive mini notice.







If unsuccessful:

- A negative indicator tone sounds.
 - The display shows a negative mini notice.
-

Creating Job Tickets

Your radio is able to create Job Tickets, which are based on a Job Ticket template and send out tasks that need to be performed.



CPS programming software is required to configure the Job Ticket template.



- 1 Press  to access the menu.
-
- 2 Press  or  to Job Tickets. Press  to select.
-
- 3 Press  or  to Create Ticket. Press  to select.
-



Responding to Job Tickets

Follow the procedure to respond to job tickets on your radio.



- 1 Press  to access the menu.

- 2 Press  or  to Job Tickets. Press  to select.

- 3 Press  or  to the required folder. Press  to select.

- 4 Press  or  to the required job ticket. Press  to select.

- 5 Press  once more to access the sub-menu.
You can also press the corresponding number key (1–9) to **Quick Reply**.

- 6 Press  or  to the required job ticket. Press  to select.

The display shows a transitional mini notice, indicating the request is in progress.

- 7 Wait for acknowledgment.

If successful:

- A positive indicator tone sounds.
- The display shows a positive mini notice.

If unsuccessful:

- A negative indicator tone sounds.
- The display shows a negative mini notice.



Sending Job Tickets Using One Job Ticket Template

If your radio is configured with one Job Ticket template, perform the following actions to send the Job Ticket.

- 1 Use the keypad to type the required room number.

Press  to select.

- 2 Press  or  to Room Status. Press  to select.
-

- 3 Press  or  to the required option. Press  to select.
-

- 4 Press  or  to Send. Press  to select.

The display shows a transitional mini notice, indicating the request is in progress.

- 5 Wait for acknowledgment.

If successful:



- A positive indicator tone sounds.
- The display shows a positive mini notice.

If unsuccessful:

- A negative indicator tone sounds.
 - The display shows a negative mini notice.
-

Sending Job Tickets Using More Than One Job Ticket Template

If your radio is configured with more than one Job Ticket template, perform the following actions to send the Job Tickets.

- 1 Press  or  to the required option. Press  to select.
-

- 2 Press  or  to Send. Press  to select.

The display shows a transitional mini notice, indicating the request is in progress.

3 Wait for acknowledgment.

If successful:

- A positive indicator tone sounds.
- The display shows a positive mini notice.

If unsuccessful:

- A negative indicator tone sounds.
 - The display shows a negative mini notice.
-

Deleting Job Tickets

Follow the procedure to delete job tickets on your radio.

1 Do one of the following:

- Press the programmed **Job Ticket** button.
Proceed to [step 4](#)
 - Press  to access the menu.
-

2 Press or to Job Tickets. Press to select.

3 Press or to the required folder. Press to select.

4 Press or to All folder. Press to select.

5 Press or to the required Job Ticket. Press to select.

6 Press again while viewing the Job Ticket.

7 Press or to Delete. Press to select.

The display shows a transitional mini notice, indicating the request is in progress.

8 Wait for acknowledgment.

If successful:

- A positive indicator tone sounds.
- The display shows a positive mini notice.

If unsuccessful:



- A negative indicator tone sounds.
- The display shows a negative mini notice.



Deleting All Job Tickets



Follow the procedure to delete all job tickets on your radio.



1 Do one of the following:

- Press the programmed **Job Ticket** button. Proceed to [step 3](#).
- Press  to access the menu.







2 Press  or  to Job Tickets. Press  to select.

3 Press  or  to the required folder. Press  to select.

4 Press  or  to All folder. Press  to select.

5 Press  or  to Delete All. Press  to select.

6 Do one of the following:

- Press  or  to Yes. Press  to select.
The display shows a positive mini notice.
- Press  or  to No. Press  to select.
The radio returns to the previous screen.

Privacy

This feature helps to prevent eavesdropping by unauthorized users on a channel by the use of a software-based scrambling solution. The signaling and user identification portions of a transmission are not scrambled.

Your radio must have privacy enabled on the channel to send a privacy-enabled transmission, although this is not a necessary requirement for receiving a transmission. While

on a privacy-enabled channel, the radio is still able to receive clear or unscrambled transmissions.

Some radio models may not offer Privacy feature, or may have a different configuration. Check with your dealer or system administrator for more information.

Your radio supports two types of privacy, but only one can be assigned to your radio. They are:

- Basic Privacy
- Enhanced Privacy

To unscramble a privacy-enabled call or data transmission, your radio must be programmed to have the same Privacy Key for Basic Privacy, or the same Key Value and Key ID for Enhanced Privacy as the transmitting radio.

If your radio receives a scrambled call that is of a different Privacy Key, or different Key Value and Key ID, you either hear a garbled transmission for Basic Privacy or nothing at all for Enhanced Privacy.

On a privacy-enabled channel, your radio is able to receive clear or unscrambled calls, depending on how your radio is programmed. In addition, your radio may play a warning tone or not, depending on how it is programmed.

The green LED lights up when the radio is transmitting, and blinks rapidly when the radio is receiving an ongoing privacy-enabled transmission.







NOTICE:



This feature is not applicable in Citizens Band channels that are in the same frequency.



Turning Privacy On or Off

Follow the procedure to turn privacy on or off on your radio.









- 1 Do one of the following:
 - Press the programmed **Privacy** button. Skip the steps below.
 - Press  to access the menu.

- 2 Press  or  to Utilities. Press  to select.

- 3 Press  or  to Radio Settings. Press  to select.

- 4 Press  or  to **Privacy**. Press  to select.

5 Do one of the following:

- Press  or  to **On**. Press  to select. The display shows  beside **On**.
- Press  or  to **Off**. Press  to select. The display shows  beside **Off**.

Multi-Site Controls

These features are applicable when your current radio channel is part of an IP Site Connect or Capacity Plus–Multi-Site configuration.

Starting Manual Site Search

Follow the procedure to start manual site search when the received signal strength is poor in order to attempt to find a site with better signal.

If the radio finds a new site:

- A positive indicator tone sounds.
- If the radio fails to find a new site:
- A negative indicator tone sounds.

Site Lock On/Off

When toggled on, the radio searches the current site only. When toggled off, the radio searches other sites in addition to the current site.

Press the programmed **Site Lock** button.

If the **Site Lock** function is toggled on:

- You hear a positive indicator tone, indicating the radio has locked to the current site.
- The display shows **Site Locked**.



If the **Site Lock** function is toggled off:



- You hear a negative indicator tone, indicating the radio is unlocked.
- The display shows **Site Unlocked**.



Accessing Neighbor Sites List

This feature allows the user to check the adjacent sites list of the current home site. Follow the procedure to access the Neighbor Sites List:

- 1 Press  to access the menu.

- 2 Press  or  to Utilities. Press  to select.

- 3 Press  or  to Radio Info. Press  to select.

- 4 Press  or  to Neighbor Sites. Press  to select.

Security

This feature allows you to enable or disable any radio in the system.

For example, you may want to disable a stolen radio to prevent unauthorized users from using it, and enable the radio when it is recovered.

You will not receive an acknowledgment if you press  during Radio Enable or Radio Disable operation.





NOTICE:

Check with your dealer or system administrator for more information.

Disabling Radios

Follow the procedure to disable your radio.

- 1 Press the programmed **Radio Disable** button.

- 2 Press  or  to the required alias or ID.

- 3 Press  to select.

The display shows a transitional mini notice, indicating the request is in progress. The green LED blinks.

4 Wait for acknowledgment.

If successful:

- A positive indicator tone sounds.
- The display shows a positive mini notice.



If unsuccessful:



- A negative indicator tone sounds.
 - The display shows a negative mini notice.
-

Disabling Radios by Using the Contacts List

Follow the procedure to disable your radio by using the Contacts list.

1 Press  to access the menu.

2 Press  or  to **Contacts**. Press  to select.

3 Press  or  to the required alias or ID.

Press  to select.

4 Press  or  to **Radio Disable**.

5 Press  to select.

The display shows a transitional mini notice, indicating the request is in progress. The green LED blinks.

6 Wait for acknowledgment.

If successful:

- A positive indicator tone sounds.
- The display shows a positive mini notice.



If unsuccessful:



- A negative indicator tone sounds.
 - The display shows a negative mini notice.
-



Disabling Radios by Using the Manual Dial

Follow the procedure to disable your radio by using the manual dial.



- 1 Press  to access the menu.

- 2 Press  or  to Contacts. Press  to select.

- 3 Press  or  to Manual Dial. Press  to select.

- 4 Press  or  to Radio Number. Press  to select.
The first text line shows Radio Number:.

- 5 Enter the subscriber ID, and press  to proceed.

- 6 Press  or  to Radio Disable.

- 7 Press  to select.

The display shows a transitional mini notice, indicating the request is in progress. The green LED blinks.

- 8 Wait for acknowledgment.

If successful:

- A positive indicator tone sounds.
- The display shows a positive mini notice.

If unsuccessful:

- A negative indicator tone sounds.
 - The display shows a negative mini notice.
-

Enabling Radios

Follow the procedure to enable your radio.

- 1 Press the programmed **Radio Enable** button.

- 2 Press  or  to the required alias or ID.

3 Press  to select.
The display shows **Radio Enable** and the subscriber alias or ID. The green LED lights up.

4 Wait for acknowledgment.

If successful:

- A positive indicator tone sounds.
- The display shows a positive mini notice.



If unsuccessful:



- A negative indicator tone sounds.
 - The display shows a negative mini notice.
-

Enabling Radios by Using the Contacts List

Follow the procedure to enable your radio by using the Contacts list.

1 Press  to access the menu.

2 Press  or  to **Contacts**. Press  to select.

3 Press  or  to the required alias or ID.
Press  to select.

4 Press  or  to **Radio Enable**.

5 Press  to select.
The green LED blinks. The display shows **Radio Enable** and the subscriber alias or ID. The green LED lights up.

6 Wait for acknowledgment.
If successful:

- A positive indicator tone sounds.
- The display shows a positive mini notice.











If unsuccessful:

- A negative indicator tone sounds.

- The display shows a negative mini notice.

Enabling Radios by Using the Manual Dial

Follow the procedure to enable your radio by using the manual dial.

- 1 Press  to access the menu.
- 2 Press  or  to `Contacts`. Press  to select.
- 3 Press  or  to `Manual Dial`. Press  to select.
- 4 Press  or  to `Private Call`. Press  to select.
The first text line shows `Radio Number:`.
- 5 Enter the subscriber ID, and press  to proceed.

- 6 Press  or  to `Radio Enable`.

- 7 Press  to select.
The green LED blinks. The display shows `Radio Enable` and the subscriber alias or ID. The green LED lights up.

- 8 Wait for acknowledgment.
If successful:
 - A positive indicator tone sounds.
 - The display shows a positive mini notice.
 If unsuccessful:
 - A negative indicator tone sounds.
 - The display shows a negative mini notice.

Lone Worker

This feature prompts an emergency to be raised if there is no user activity, such as any radio button press or channel selection, for a predefined time.

Following no user activity for a programmed duration, the radio pre-warns you using an audio indicator once the inactivity timer expires.

If there is still no acknowledgment by you before the predefined reminder timer expires, the radio initiates an Emergency Alarm.

Only one of the following Emergency Alarms is assigned to this feature:

- Emergency Alarm
- Emergency Alarm with Call
- Emergency Alarm with Voice to Follow 

The radio remains in the emergency state, allowing voice messages to proceed until action is taken. See [Emergency Operation on page 395](#) for more information on ways to exit Emergency.



NOTICE:

This feature is limited to radios with this function enabled. Check with your dealer or system administrator for more information.

Bluetooth

This feature allows you to use your radio with a Bluetooth-enabled device (accessory) through a Bluetooth connection. Your radio supports both Motorola Solutions and Commercially available Off-The-Shelf (COTS) Bluetooth-enabled devices.

Bluetooth operates within a range of 10 m (32 ft) line of sight. This is an unobstructed path between your radio and your Bluetooth-enabled device. For high degree of reliability, Motorola Solutions recommends to not separate the radio and the accessory.

At the fringe areas of reception, both voice and tone quality start to sound "garbled" or "broken". To correct this problem, position your radio and Bluetooth-enabled device closer to each other (within the 10 m defined range) to re-establish clear audio reception. The Bluetooth function of your radio has maximum power of 2.5 mW (4 dBm) at the 10 m range.

Your radio can support up to three simultaneous Bluetooth connections with Bluetooth-enabled devices of unique types. For example, a headset, a scanner, and a PTT-Only Device (POD). Multiple connections with Bluetooth-enabled devices of the same type are not supported.

Refer to the user manual of your respective Bluetooth-enabled device for more details on the full capabilities of your Bluetooth-enabled device.







NOTICE:



If disabled through CPS, all Bluetooth-related features are disabled and the Bluetooth device database is erased.

Turning Bluetooth On and Off

Follow the procedure to turn Bluetooth on and off.









- 1 Press  to access the menu.

- 2 Press  or  to Bluetooth. Press  to select.

- 3 Press  or  to My Status. Press  to select.

The display shows On and Off. The current status is indicated by a .

- 4 Do one of the following:



- Press  or  to On. Press  to select. The display shows  beside On.
- Press  or  to Off. Press  to select. The display shows  beside Off.

Connecting to Bluetooth Devices

Follow the procedure to connect to Bluetooth devices.









Turn on your Bluetooth-enabled device and place it in pairing mode.

- 1 Press  to access the menu.

2 Press  or  to Bluetooth. Press  to select.

3 Press  or  to Devices. Press  to select.

4 Do one of the following:

- Press  or  to the required device. Press  to select.
 - Press  or  to Find Devices to locate available devices. Press  or  to the required device. Press  to select.
-

5 Press  or  to Connect. Press  to select.

Your Bluetooth-enabled device may require additional steps to complete the pairing. Refer to the user manual of your Bluetooth-enabled device.

The display shows Connecting to <Device>.

Wait for acknowledgment.

If successful:

- A positive indicator tone sounds.
- The display shows <Device> Connected and the **Bluetooth Connected** icon.
- The display shows  beside the connected device.

If unsuccessful:

- A negative indicator tone sounds.
- The display shows Connecting Failed.



NOTICE:



If pin code is required, see [Accessing Radios by Using Passwords on page 177](#).



Connecting to Bluetooth Devices in Discoverable Mode

Follow the procedure to connect to Bluetooth devices in discoverable mode.

Turn on your Bluetooth-enabled device and place it in pairing mode.

- 1 Press  to access the menu.

- 2 Press  or  to Bluetooth. Press  to select.

- 3 Press  or  to Find Me. Press  to select. The radio can now be found by other Bluetooth-enabled devices for a programmed duration. This is called Discoverable Mode.

Wait for acknowledgment.

If successful:

- A positive indicator tone sounds.
- The display shows <Device> Connected and the **Bluetooth Connected** icon.

- The display shows  beside the connected device.



If unsuccessful:



- A negative indicator tone sounds.
- The display shows **Connecting Failed**.



Disconnecting from Bluetooth Devices



Follow the procedure to disconnect from Bluetooth devices.

- 1 Press  to access the menu.

- 2 Press  or  to Bluetooth. Press  to select.

- 3 Press  or  to Devices. Press  to select.

- 4 Press  or  to the required device. Press  to select.

- 5 Press  or  to Disconnect. Press  to select.

The display shows Disconnecting from <Device>.



NOTICE:

Your Bluetooth-enabled device may require additional steps to disconnect. Refer to respective user manuals of any Bluetooth-enabled devices.

Wait for acknowledgment.

- A tone sounds.
- The display shows <Device> Disconnected and the **Bluetooth Connected** icon disappears.
- The  disappears beside the connected device.

Switching Audio Route between Internal Radio Speaker and Bluetooth Device

Follow the procedure to toggle audio routing between internal radio speaker and external Bluetooth device.







Press the programmed **Bluetooth Audio Switch** button.



The display shows one of the following results:



- A tone sounds. The display shows Route Audio to Radio.
- A tone sounds. The display shows Route Audio to Bluetooth.

Viewing Device Details

Follow the procedure to view device details on your radio.

- 1 Press  to access the menu.
- 2 Press  or  to Bluetooth. Press  to select.
- 3 Press  or  to Devices. Press  to select.



4 Press  or  to the required device. Press  to select.



5 Press  or  to View Details. Press  to select.



Deleting Device Name



You can remove a disconnected device from the list of Bluetooth-enabled devices.

1 Press  to access the menu.

2 Press  or  to Bluetooth. Press  to select.

3 Press  or  to Devices. Press  to select.



4 Press  or  to the required device. Press  to select.



5 Press  or  to Delete. Press  to select. The display shows Device Deleted.



Bluetooth Mic Gain



This feature allows the user to control the microphone gain value of the connected Bluetooth-enabled device.

1 Press  to access the menu.

2 Press  or  to Bluetooth. Press  to select.

3 Press  or  to BT Mic Gain. Press  to select.

4 Press  or  to the BT Mic Gain type and the current values. Press  to select. You can edit the values here.

- 5 Press  or  to increase or to decrease values. Press  to select.

Indoor Location



NOTICE:





Indoor Location feature is applicable for models with the latest software and hardware. Check with your dealer or system administrator for more information.

Indoor Location is be used to keep track of the location of radio users. When Indoor Location is activated, the radio is in a limited discoverable mode. Dedicated beacons are used to locate the radio and determine its position.

Turning Indoor Location On or Off

You can turn on or turn off Indoor Location by performing one of the following actions.

- Access this feature through the menu.
 - a. Press  to access the menu.

- b. Press  or  to Bluetooth and press  to select.
- c. Press  or  to Indoor Location and press  to select.
- d. Press  to turn on Indoor Location.

The display shows Indoor Location On. You hear a positive indicator tone.

One of the following scenarios occurs.

- If successful, the Indoor Location Available icon appears on the Home screen display.
- If unsuccessful, the display shows Turning On Failed. You hear a negative indicator tone.

- e. Press  to turn off Indoor Location.

The display shows Indoor Location Off. You hear a positive indicator tone.

One of the following scenarios occurs.

- If successful, the Indoor Location Available icon disappears on the Home screen display.

- If unsuccessful, the display shows `Turning Off Failed`. You hear a negative indicator tone.
- Access this feature by using the programmed button.
 - a. Long press the programmed **Indoor Location** button to turn on Indoor Location.

The display shows `Indoor Location On`. You hear a positive indicator tone.

One of the following scenarios occurs.

- If successful, the Indoor Location Available icon appears on the Home screen display.
 - If unsuccessful, the display shows `Turning On Failed`. If unsuccessful, you hear a negative indicator tone.
- b. Press the programmed **Indoor Location** button to turn off Indoor Location.

The display shows `Indoor Location Off`. You hear a positive indicator tone.

One of the following scenarios occurs.



- If successful, the Indoor Location Available icon disappears on the Home screen display.



- If unsuccessful, the display shows `Turning Off Failed`. If unsuccessful, you hear a negative indicator tone.



Accessing Indoor Location Beacons Information

Follow the procedure to access Indoor Location beacons information.

- 1 Press  to access the menu.

- 2 Press  or  to Bluetooth and press  to select.

- 3 Press  or  to Indoor Location and press  to select.

- 4 Press  or  to Beacons and press  to select.

The display shows the beacons information.

Notification List

Your radio has a Notification list that collects all your unread events on the channel, such as unread text messages, telemetry messages, missed calls, and call alerts.

The display shows the **Notification** icon when the Notification list has one or more events.



The list supports a maximum of 40 unread events. When the list is full, the next event automatically replaces the oldest event. After the events are read, they are removed from the Notification list.



For text messages, missed calls, and call alert events, the maximum number of notifications are 30 text messages and 10 missed calls or call alerts. This maximum number depends on individual feature (job tickets or text messages or missed calls or call alerts) list capability.

Accessing Notification List

Follow the procedure to access the Notification list on your radio.

- 1 Press  to access the menu.
-

- 2 Press  or  to Notification. Press  to select.
-

- 3 Press  or  to the required event. Press  to select.

Long press  to return to the Home screen.

Auto-Range Transponder System

The Auto-Range Transponder System (ARTS) is an analog-only feature designed to inform you when your radio is out-of-range of other ARTS-equipped radios.

ARTS-equipped radios transmit or receive signals periodically to confirm that they are within range of each other.

Your radio provides indications of states as follows:

First-Time Alert

A tone sounds.

The display shows **In Range** after the channel alias.

ARTS-in-Range Alert

A tone sounds, if programmed.

The display shows `In Range` after the channel alias.

ARTS-Out-of-Range Alert

A tone sounds. The red LED rapidly blinks.

The display shows `Out of Range` alternating with the Home screen.



NOTICE:

Check with your dealer or system administrator for more information.

Over-the-Air Programming

Your dealer can remotely update your radio through Over-the-Air Programming (OTAP) without any physical connection. Additionally, some settings can also be configured by using OTAP.

When your radio undergoes OTAP, the green LED blinks.

When your radio receives high volume data:

- The display shows the **High Volume Data** icon.
- The channel becomes busy.
- A negative tone sounds if you press the **PTT** button.

When OTAP completes, depending on the configuration:

- A tone sounds. The display shows `Updating Restarting`. Your radio restarts by powering off and on again.
- You can select `Restart Now` or `Postpone`. When you select `Postpone`, your radio returns to the previous screen. The display shows the **OTAP Delay Timer** icon until the automatic restart occurs.

When your radio powers up after automatic restart:

- If successful, the display shows `Sw Update Completed`.
- If unsuccessful, the display shows `Sw Update Failed`.

See [Checking Software Update Information on page 209](#) for the updated software version.



Selecting Third-Party Peripherals Connection Modes



Follow the procedure to select one of the following third-party peripherals connection modes:



- Motorola Solutions
- PC and Audio
- Data Accessory



- Telemetry
- Generic

1 Press  to access the menu.

2 Press  or  to Utilities. Press  to select.

3 Press  or  to Radio Settings. Press  to select.

4 Press  or  to Cable Type. Press  to select.

5 Press  or  to the required connection mode. Press  to select.

The display shows the selected connection mode.
The screen returns to the previous menu.

Received Signal Strength Indicator



This feature allows you to view the Received Signal Strength Indicator (RSSI) values.

The display shows the **RSSI** icon at the top right corner. See [Display Icons](#) for more information on the **RSSI** icon.

Viewing RSSI Values

Follow the procedure to view RSSI values on your radio.

When you are at the Home screen:

1 Press  three times and immediately press  three times, all in 5 seconds.

The display shows the current RSSI values.

2 Long press  to return to the Home screen.

Password Lock Features

This feature allows you to restrict access to the radio by asking for a password when the device is turned on.

You can use a keypad microphone or **Scroll Up/Down** buttons to enter the password.

Accessing Radios by Using Passwords



Follow the procedure to access your radio by using a password.

- 1 Enter the current four-digit password.



NOTICE:

The use of **Emergency** footswitch cancels out password input to access the radio.

- Use a keypad microphone.
- Press  or  to edit the numeric value of each digit, and press  to enter and move to the next digit.

- 2 Press  to enter the password.

If successful, the radio powers up.

[Send Feedback](#)

If unsuccessful:

- After the first and second attempt, the display shows **Wrong Password**. Repeat [step 1](#).
- After the third attempt, the display shows **Wrong Password** and then, **Radio Locked**. A tone sounds. The yellow LED double blinks. Your radio enters into locked state for 15 minutes.



NOTICE:

In locked state, your radio responds to inputs from the **On/Off/Volume Control Knob** and programmed **Backlight** button only.

Unlocking Radios in Locked State

Your radio is unable to receive calls in locked state. Follow the procedure to unlock your radio in locked state.

Do one of the following:

- If the radio is powered on, wait for 15 minutes and then repeat the steps in [Accessing Radios by Using Passwords on page 177](#) to access the radio.
- If the radio is powered off, power up the radio. Your radio restarts the 15-minute timer for locked state.



A tone sounds. The yellow LED double blinks. The display shows **Radio Locked**.



Wait for 15 minutes and then repeat the steps in [Accessing Radios by Using Passwords on page 177](#) to access the radio.



Turning Password Lock On or Off

Follow the procedure to turn password lock on or off on your radio.



- 1 Press  to access the menu.

- 2 Press  or  to **Utilities**. Press  to select.









- 3 Press  or  to **Radio Settings**. Press  to select.

- 4 Press  or  to **Passwd Lock**. Press  to select.

- 5 Enter the current four-digit password.

- Use a keypad microphone.
- Press  or  to edit the numeric value of each digit, and press  to enter and move to the next digit.
A positive indicator tone sounds for every digit pressed.



- 6 Press  to enter the password.
If the password is incorrect, the display shows **Wrong Password** and automatically returns to the previous menu.



- 7 Do one of the following:
 - Press  or  to **Turn On**. Press  to select.
The display shows  beside **Turn On**.
 - Press  or  to **Turn Off**. Press  to select.
The display shows  beside **Turn Off**.



Changing Passwords

Follow the procedure to change passwords on your radio.



- 1 Press  to access the menu.

- 2 Press  or  to Utilities. Press  to select.

- 3 Press  or  to Radio Settings. Press  to select.

- 4 Press  or  to Passwd Lock. Press  to select.

- 5 Enter the current four-digit password, and press  to proceed.
If the password is incorrect, the display shows Wrong Password and automatically returns to the previous menu.

- 6 Press  or  to Change PWD. Press  to select.

- 7 Enter a new four-digit password, and press  to proceed.

- 8 Re-enter the new four-digit password, and press  to proceed.

If successful, the display shows Password Changed. If unsuccessful, the display shows Passwords Do Not Match.

The screen automatically returns to the previous menu.

Front Panel Configuration



You are able to customize certain feature parameters in Front Panel Configuration (FPC) to enhance the use of your radio.



Entering Front Panel Configuration Mode

Follow the procedure to enter front panel programming mode on your radio.

Long press  at any time to return to the Home screen.



- 1 Press  to access the menu.



- 2 Press  or  to Utilities. Press  to select.

- 3 Press  or  to Program Radio. Press  to select.

Editing FPC Mode Parameters

Use the following buttons as required while navigating through the feature parameters.

-  ,  – Scroll through options, increase/decrease values, or navigate vertically.

-  – Select the option or enter a sub-menu.
-  – Short-press to return to previous menu or to exit the selection screen. Long-press to return to Home screen.

Wi-Fi Operation

This feature allows you to set up and connect to a Wi-Fi network. Wi-Fi supports updates for radio firmware, codeplug, and resources such as language packs and voice announcement.



NOTICE:

This feature is applicable to XPR 5550e/XPR 5580e only.

Wi-Fi® is a registered trademark of Wi-Fi Alliance®.

Your radio supports WEP/WPA/WPA2-Personal and WPA/WPA2-Enterprise Wi-Fi networks.

WEP/WPA/WPA2-Personal Wi-Fi network

Uses pre-shared key (password) based authentication.

Pre-shared key can be entered by using the menu or CPS/RM.

WPA/WPA2-Enterprise Wi-Fi network

Uses certificate-based authentication.

Your radio must be pre-configured with a certificate.



NOTICE:

Check with your dealer or system administrator to connect to WPA/WPA2-Enterprise Wi-Fi network.







Turning Wi-Fi On or Off

The programmed **Wi-Fi On or Off** button is assigned by default. Check with your dealer or system administrator to determine how your radio has been programmed.



Voice Announcements for the programmed **Wi-Fi On or Off** button can be customized through CPS according to user requirements. Check with your dealer or system administrator for more information.

You can turn on or turn off Wi-Fi by performing one of the following actions.

- Press the programmed **Wi-Fi On or Off** button. Voice Announcement sounds Turning On Wi-Fi or Turning Off Wi-Fi.
- Access this feature using the menu.

- Press  **OK** to access the menu.
- Press  or  to **WiFi** and press  **OK** to select.
- Press  or  to **WiFi On** and press  **OK** to select.

Press  **OK** to turn on Wi-Fi. The display shows  beside **Enabled**.

Press  **OK** to turn off Wi-Fi. The  disappears from beside **Enabled**.

Connecting to a Network Access Point

When you turn on Wi-Fi, the radio scans and connects to a network access point.









NOTICE:





You can also connect to a network access point using the menu.



The WPA-Enterprise Wi-Fi network access points are pre-configured. Check with your dealer or system administrator to determine how your radio has been programmed.

- 1 Press  to access the menu.

- 2 Press  or  to WiFi and press  to select.

- 3 Press  or  to Networks and press  to select.

- 4 Press  or  to a network access point and press  to select.
 **NOTICE:**
For WPA-Enterprise Wi-Fi, if a network access point is not preconfigured, the Connect option is not available.

- 5 Press  or  to Connect and press  to select.

- 6 For WPA-Personal Wi-Fi, enter the password and press  .

- 7 For WPA-Enterprise Wi-Fi, password is configured by using RM.

If the preconfigured password is correct, your radio automatically connects to the selected network access point.

If the preconfigured password is incorrect, the display shows Authentication Failure, and automatically returns to the previous menu.

If the connection is successful, the radio displays a notice and the network access point is saved into the profile list.

If the connection is unsuccessful, the radio displays shows the failure notice screen momentarily and automatically returns to the previous menu.

Checking Wi-Fi Connection Status

Follow the procedure to check the Wi-Fi Connection status.

Press the programmed **Wi-Fi Status Query** button for the connection status by using Voice Announcement. Voice

Announcement sounds Wi-Fi is Off, Wi-Fi is On but No Connection, or Wi-Fi is On with Connection.

- The display shows `WiFi Off` when the Wi-Fi is turned off.
- The display shows `WiFi On, Connected` when the radio is connected to a network.
- The display shows `WiFi On, Disconnected` when the Wi-Fi is turned on but the radio is not connected to any network.

Voice Announcements for the Wi-Fi status query results can be customized through CPS according to user requirements. Check with your dealer or system administrator for more information.









NOTICE:

The programmed **Wi-Fi Status Query** button is assigned by default. Check with your dealer or system administrator to determine how your radio has been programmed.



Refreshing the Network List

Follow the procedure to refresh the network list.

- Perform the following actions to refresh the network list through the menu.
 - a. Press  to access the menu.
 - b. Press  or  to `WiFi` and press  to select.
 - c. Press  or  to `Networks` and press  to select.

When you enter the Networks menu, the radio automatically refreshes the network list.

- If you are already in the Networks menu, perform the following action to refresh the network list.

Press  or  to `Refresh` and press  to select.

The radio refreshes and displays the latest network list.

Adding a Network









NOTICE:



This task is not applicable to WPA-Enterprise Wi-Fi networks.

If a preferred network is not in the available network list, perform the following actions to add a network.

- 1 Press  to access the menu.

- 2 Press  or  to WiFi and press  to select.

- 3 Press  or  to Networks and press  to select.

- 4 Press  or  to Add Network and press  to select.

- 5 Enter the Service Set Identifier (SSID) and press .



- 6 Press  or  to Open and press  to select.



- 7 Enter the password and press  .
The radio displays a positive mini notice to indicate that the network is successfully saved.



Viewing Details of Network Access Points



You can view details of network access points.

- 1 Press  to access the menu.

- 2 Press  or  to WiFi and press  to select.

- 3 Press  or  to Networks and press  to select.

- 4 Press  or  to a network access point and press  to select.
-

- 5 Press  or  to View Details and press  to select.



NOTICE:

WPA-Personal Wi-Fi and WPA-Enterprise Wi-Fi display different details of Network Access Points.

WPA-Personal Wi-Fi

For a connected network access point, your radio displays Service Set Identifier (SSID), Security Mode, Media Access Control (MAC) address, and Internet Protocol (IP) address.

For a non-connected network access point, your radio displays SSID and Security Mode.

WPA-Enterprise Wi-Fi

For a connected network access point, your radio displays SSID, Security Mode, Identity, Extended Authentication Protocol (EAP) Method, Phase 2 Authentication, Cert Name, MAC address, IP address, Gateway, DNS1, and DNS2.

For a non-connected network access point, your radio displays SSID, Security Mode, Identity, EAP Method, Phase 2 Authentication, and Cert Name.

Removing Network Access Points









NOTICE:



This task is not applicable to Enterprise Wi-Fi networks.



Perform the following actions to remove network access points from the profile list.

- 1 Press  to access the menu.

- 2 Press  or  to WiFi and press  to select.

- 3 Press  or  to Networks and press  to select.

4 Press  or  to the selected network access point and press  to select.

5 Press  or  to Remove and press  to select.

6 Press  or  to Yes and press  to select.

The radio displays a positive mini notice to indicate that the selected network access point is successfully removed.

Utilities

This chapter explains the operations of the utility functions available in your radio.

Squelch Levels

You can adjust the squelch level to filter out unwanted calls with low signal strength or channels with noise higher than normal background.

Normal

This is the default setting.

Tight

This setting filters out unwanted calls and/or background noise. Calls from remote locations may also be filtered out.







NOTICE:



This feature is not applicable in Citizens Band channels that are in the same frequency.

Setting Squelch Levels

Follow the procedure to set the squelch levels on your radio.



- 1 Do one of the following:
 - Press the programmed **Squelch** button. Skip the following steps.
 - Press  to access the menu.
-

- 2 Press  or  to Utilities. Press  to select.
-

3 Press  or  to Radio Settings. Press  to select.

4 Press  or  to Squelch. Press  to select.

5 Do one of the following:

- Press  or  to Normal. Press  to select.

The display shows  beside Normal.

- Press  or  to Tight. Press  to select.

The display shows  beside Tight.

The screen automatically returns to the previous menu.

Power Levels

You can customize the power setting to high or low for each channel.

High

This enables communication with radios located at a considerable distance from you.

Low

This enables communication with radios in closer proximity.



NOTICE:



This feature is not applicable in Citizens Band channels that are in the same frequency.



Setting Power Levels

Follow the procedure to set the power levels on your radio.

1 Do one of the following:









- Press the programmed **Power Level** button. Skip the steps below.
 - Press  to access the menu.
-

2 Press  or  to Utilities. Press  to select.

3 Press  or  to Radio Settings. Press  to select.

4 Press  or  to Power. Press  to select.

5 Do one of the following:

- Press  or  to High. Press  to select.
The display shows  beside High.
 - Press  or  to Low. Press  to select.
The display shows  beside Low.
-

6 Long press  to return to the Home screen.



Turning Radio Tones/Alerts On or Off

You can enable and disable all radio tones and alerts, if needed, except for incoming Emergency alert tone . Follow



the procedure to turn tones and alerts on or off on your radio.



1 Do one of the following:

- Press the programmed **Tones/Alerts** button. Skip the following steps.
 - Press  to access the menu.
-

2 Press  or  to Utilities. Press  to select.

3 Press  or  to Radio Settings. Press  to select.











4 Press  or  to Tones/Alerts. Press  to select.



5 Press  or  to All Tones. Press  to select.

- 6 Press  to enable or disable all tones and alerts. The display shows one of the following results:
- If enabled, ✓ appears beside Enabled.
 - If disabled, ✓ disappears beside Enabled.
-

Turning Keypad Tones On or Off

Follow the procedure to turn keypad tones on or off on your radio.



- 1 Press  to access the menu.
-
- 2 Press  or  to Utilities. Press  to select.
-
- 3 Press  or  to Radio Settings. Press  to select.
-
- 4 Press  or  to Tones/Alerts. Press  to select.
-



- 5 Press  or  to Keypad Tones. Press  to select.
-



- 6 Press  to enable or disable keypad tones. The display shows one of the following results:
- If enabled, ✓ appears beside Enabled.
 - If disabled, ✓ disappears beside Enabled.
-



Setting Tones/Alerts Volume Offset Levels



This feature adjusts the volume of the tones or alerts, allowing it to be higher or lower than the voice volume. Follow the procedure to set the tones and alerts volume offset levels on your radio.

- 1 Press  to access the menu.
-
- 2 Press  or  to Utilities. Press  to select.
-

3 Press  or  to Radio Settings. Press  to select.



4 Press  or  to Tones/Alerts. Press  to select.

5 Press  or  to Vol. Offset. Press  to select.

6 Press  or  to the required volume offset level.

A feedback tone sounds with each corresponding volume offset level.



7 Do one of the following:



- Press  to select. The required volume offset level is saved.
 - Press  to exit. The changes are discarded.
-



Turning Talk Permit Tone On or Off



Follow the procedure to turn Talk Permit Tone on or off on your radio.

1 Press  to access the menu.

2 Press  or  to Utilities. Press  to select.

3 Press  or  to Radio Settings. Press  to select.

4 Press  or  to Tones/Alerts. Press  to select.

5 Press  or  to Talk Permit. Press  to select.













6 Press  to enable or disable the Talk Permit Tone.

The display shows one of the following results:

- If enabled, ✓ appears beside Enabled.
- If disabled, ✓ disappears beside Enabled.

Turning Power Up Tone On or Off

Follow the procedure to turn Power Up Tone on or off on your radio.







- 1 Press  to access the menu.
- 2 Press  or  to Utilities. Press  to select.
- 3 Press  or  to Radio Settings. Press  to select.
- 4 Press  or  to Tones/Alerts. Press  to select.
- 5 Press  or  to Power Up. Press  to select.



[Send Feedback](#)

- 6 Press  to enable or disable the Power Up Tone. The display shows one of the following results:
 - If enabled, ✓ appears beside Enabled.
 - If disabled, ✓ disappears beside Enabled.
-









Setting Text Message Alert Tones

You can customize the text message alert tone to Momentary or Repetitive for each entry in the Contacts list. Follow the procedure to set the text message alert tones on your radio.

- 1 Press  to access the menu.
 - 2 Press  or  to Contacts. Press  to select.
 - 3 Press  or  to the required alias or ID. Press  to select.
-

4 Press  or  to Message Alert. Press  to select.

5 Do one of the following:

- Press  or  to Momentary. Press  to select.
The display shows  beside Momentary.
 - Press  or  to Repetitive. Press  to select.
The display shows  beside Repetitive.
-



Changing Display Modes



You can change the display mode of the radio between Day or Night, as needed. This feature affects the color palette of the display. Follow the procedure to change the display mode of your radio.

1 Do one of the following:

- Press the programmed **Display Mode** button.
Skip the following steps.



- Press  to access the menu.
-

2 Press  or  to Utilities. Press  to select.

3 Press  or  to Radio Settings. Press  to select.

4 Press  or  to Display. Press  to select.

The display shows Day Mode and Night Mode.



5 Press  or  to the required setting. Press  to select.



The display shows  beside the selected setting.



Adjusting Display Brightness



Follow the procedure to adjust the display brightness on your radio. Display brightness cannot be adjusted when Auto Brightness is enabled.

- 1 Do one of the following:
 - Press the programmed **Brightness** button. Skip the following steps.
 - Press  to access the menu.

-
- 2 Press  or  to Utilities. Press  to select.

-
- 3 Press  or  to Radio Settings. Press  to select.



-
- 4 Press  or  to Brightness. Press  to select.
The display shows the progress bar.



-
- 5 Press  or  to decrease or increase the display brightness. Press  to select.
The setting value is varied from 1 to 8.



Turning Horns/Lights On or Off

Your radio is able to notify you of an incoming call through the horns and lights feature. When activated, an incoming call sounds the horn and turns on the lights of your vehicle. This feature needs to be installed through your radio rear accessory connector by your dealer. Follow the procedure to turn all horns and lights on or off on your radio.

- 1 Do one of the following:
 - Press the programmed **Horns/Lights** button. Skip the steps below.
 - Press  to access the menu.



-
- 2 Press  or  to Utilities. Press  to select.



3 Press  or  to Radio Settings. Press  to select.

4 Press  or  to Horns/Lights. Press  to select.

5 Press  to enable or disable Horns/Lights. The display shows one of the following results:

- If enabled, ✓ appears beside Enabled.
 - If disabled, ✓ disappears beside Enabled.
-

3 Press  or  to Radio Settings. Press  to select.

4 Press  or  to LED Indicator. Press  to select.



5 Press  to enable or disable the LED indicator. The display shows one of the following results:

- If enabled, ✓ appears beside Enabled.
 - If disabled, ✓ disappears beside Enabled.
-

Turning LED Indicators On or Off

Follow the procedure to turn the LED indicators on or off on your radio.

1 Press  to access the menu.



2 Press  or  to Utilities. Press  to select.



Turning Public Address System On or Off



Follow the procedure to enable or disable the internal public address (PA) system of your radio.

- 1 Do one of the following:
 - Press the programmed **Public Address** button. Skip the following steps.



- Press  to access the menu.

2 Press  or  to Utilities. Press  to select.

3 Press  or  to Radio Settings. Press  to select.

4 Press  or  to Public Address. Press  to select.

5 Press  to enable or disable Public Address.

- If enabled,  appears beside Enabled.
- If disabled,  disappears beside Enabled.



Turning External Public Address System On or Off



Follow the procedure to enable or disable the external public address (PA) system of your radio.



1 Do one of the following:

- Press the programmed **Ext Public Address** button. Skip the following steps.

- Press  to access the menu.

2 Press  or  to Utilities. Press  to select.







3 Press  or  to Radio Settings. Press  to select.

4 Press  or  to External Public Address. Press  to select.



- 5 Press  to enable or disable external public address.
 - If enabled, ✓ appears beside Enabled.
 - If disabled, ✓ disappears beside Enabled.
-

Turning Introduction Screen On or Off

You can enable and disable the Introduction Screen by following the procedure.

- 1 Press  to access the menu.
 - 2 Press  or  to Utilities. Press  to select.
 - 3 Press  or  to Radio Settings. Press  to select.
-

- 4 Press  or  to Display. Press  to select.
-

- 5 Press  or  to Intro Screen. Press  to select.
-





- 6 Press  to enable or disable the Introduction Screen.



The display shows one of the following results:



- If enabled, ✓ appears beside Enabled.
 - If disabled, ✓ disappears beside Enabled.
-





Setting Languages

Follow the procedure to set the languages on your radio.

- 1 Press  to access the menu.
 - 2 Press  or  to Utilities. Press  to select.
-

3 Press  or  to Radio Settings. Press  to select.



4 Press  or  to Languages. Press  to select.



5 Press  or  to the required language. Press  to select.
The display shows  beside the selected language.



Identifying Cable Type

Do the following steps to select the type of cable your radio uses.

1 Press  to access the menu.

2 Press  or  to Utilities. Press  to select.

3 Press  or  to Radio Settings. Press  to select.

4 Press  or  to Cable Type. Press  to select.

5 The current cable type is indicated by a .

Voice Operating Transmission

The Voice Operating Transmission (VOX) allows you to initiate a hands-free voice-activated call on a programmed channel. The radio automatically transmits, for a programmed period, whenever the microphone on the VOX-capable accessory detects voice.



NOTICE:

This feature is not applicable in Citizens Band channels that are in the same frequency.

You can enable or disable VOX by doing one of the following:

- Turn the radio off and then power it on again to enable VOX.

- Change the channel by using the **Scroll Up/Down** buttons to enable VOX.
- Change the channel by using the **Volume/Channel Knob** to enable VOX.
- Turn VOX on or off by using the programmed **VOX** button or menu to enable or disable VOX.
- Press the **PTT** button during radio operation to disable VOX.







NOTICE:

Turning this feature on or off is limited to radios with this function enabled. Check with your dealer or system administrator for more information.



Turning Voice Operating Transmission On or Off

Follow the procedure to turn VOX on or off on your radio.

- 1 Do one of the following:
 - Press the programmed **VOX** button. Skip the steps below.
 - Press  to access the menu.

- 2 Press  or  to Utilities. Press  to select.

- 3 Press  or  to Radio Settings. Press  to select.

- 4 Press  or  to VOX. Press  to select.

- 5 Press  to enable or disable **VOX**.



NOTICE:

If the Talk Permit Tone is enabled, use a trigger word to initiate the call. Wait for the Talk Permit Tone to finish before speaking clearly into the microphone. See [Turning Talk Permit Tone On or Off on page 192](#) for more information.

Turning Voice Announcement On or Off

This feature enables the radio to audibly indicate the current zone or channel the user has just assigned, or the programmable button the user has just pressed.

This is typically useful when the user has difficulty reading the content shown on the display.

This audio indicator can be customized according to customer requirements. Follow the procedure to turn Voice Announcement on or off on your radio.

Turning Option Board On or Off

Option board capabilities within each channel can be assigned to programmable buttons. A channel can support up to 6 option board features. Follow the procedure to turn option board on or off on your radio.

Press the programmed **Option Board** button.

Text-to-Speech

The Text-to-Speech feature can only be enabled by your dealer or system administrator. If Text-to-Speech is enabled, the Voice Announcement feature is automatically disabled. If Voice Announcement is enabled, then the Text-to-Speech feature is automatically disabled.

This feature enables the radio to audibly indicate the following features:



- Current Channel
- Current Zone
- Programmed button feature on or off
- Content of received text messages
- Content of received Job Tickets



This audio indicator can be customized per customer requirements. This feature is typically useful when the user is in a difficult condition to read the content shown on the display.



Setting Text-to-Speech



Follow the procedure to set the Text-to-Speech feature.

- 1 Press  to access the menu.

- 2 Press  or  to Utilities. Press  to select.

- 3 Press  or  to Radio Settings. Press  to select.

- 4 Press  or  to Voice Announcement.
Press  to select.
-

- 5 Press  or  to any of the following features.
Press  to select.

The available features are as follows:



- All
- Messages
- Job Tickets
- Channel
- Zone
- Program Button



✓ appears beside the selected setting.



Turning Automatic Call Forwarding On or Off

You can enable your radio to automatically forward voice calls to another radio.



- 1 Press  to access the menu.
-



- 2 Press  or  to Utilities. Press  to select.
-

- 3 Press  or  to Radio Settings. Press  to select.
-

- 4 Press  or  to Call Forward. Press  to select.
-

- 5 Do one of the following:



- Press  or  to enable Call Forwarding. If enabled, ✓ appears beside Enabled.



- Press  or  to disable Call Forwarding. If disabled, ✓ disappears beside Enabled.
-



Setting Menu Timer



You can set the time your radio stays in the menu before it automatically switches to the Home screen. Follow the procedure to set the menu timer.



- 1 Press  to access the menu.

- 2 Press  or  to Utilities. Press  to select.

- 3 Press  or  to Radio Settings. Press  to select.

- 4 Press  or  to Display. Press  to select.

- 5 Press  or  to Menu Timer. Press  to select.

- 6 Press  or  to the required setting. Press  to select.



Turning Analog Microphone AGC On or Off



The Analog Microphone Automatic Gain Control (AGC) controls the microphone gain of the radio automatically while transmitting on an analog system.

This feature suppresses loud audio or boosts soft audio to a preset value in order to provide a consistent level of audio. Follow the procedure to turn Analog Microphone AGC on or off on your radio.

- 1 Press  to access the menu.

- 2 Press  or  to Utilities. Press  to select.

3 Press  or  to Radio Settings. Press  to select.

4 Press  or  to Mic AGC-A. Press  to select.

5 Press  to enable or disable Analog Microphone AGC.

The display shows one of the following results:

- If enabled, ✓ appears beside Enabled.
 - If disabled, ✓ disappears beside Enabled.
-



Turning Digital Microphone AGC On or Off



The Digital Microphone Automatic Gain Control (AGC) controls the microphone gain of the radio automatically while transmitting on a digital system.



This feature suppresses loud audio or boosts soft audio to a preset value in order to provide a consistent level of

audio. Follow the procedure to turn Digital Microphone AGC on or off on your radio.

1 Press  to access the menu.

2 Press  or  to Utilities. Press  to select.

3 Press  or  to Radio Settings. Press  to select.

4 Press  or  to Mic AGC-D. Press  to select.

5 Press  to enable or disable Digital Microphone AGC.

The display shows one of the following results:

- If enabled, ✓ appears beside Enabled.
 - If disabled, ✓ disappears beside Enabled.
-

Turning Intelligent Audio On or Off



Your radio automatically adjusts the audio volume to overcome current background noise in the environment, inclusive of both stationary and non-stationary noise sources. This is a receive-only feature and does not affect transmission audio. Follow the procedure to turn Intelligent Audio on or off on your radio.







NOTICE:

This feature is not applicable during a Bluetooth session.







- 1 Do one of the following:
 - Press the programmed **Intelligent Audio** button. Skip the steps below.
 - Press  to access the menu.

- 2 Press  or  to Utilities. Press  to select.

- 3 Press  or  to Radio Settings. Press  to select.

- 4 Press  or  to Intelligent Audio. Press  to select.



- 5 Do one of the following:

- Press  or  to On. Press  to select. The display shows ✓ beside On.
- Press  or  to Off. Press  to select. The display shows ✓ beside Off.

Turning the Acoustic Feedback Suppressor Feature On or Off

This feature allows you to minimize Acoustic Feedback Suppressor in received calls. Follow the procedure to turn the Acoustic Feedback Suppressor on or off on your radio.

- 1 Press  to access the menu.

2 Press  or  to Utilities. Press  to select.

3 Press  or  to Radio Settings. Press  to select.

4 Press  or  to AF Suppressor. Press  to select.

5 Do one of the following:



- Press to enable Acoustic Feedback Suppressor. If enabled, ✓ appears beside Enabled.
 - Press to disable Acoustic Feedback Suppressor. If disabled, ✓ disappears beside Enabled.
-



Turning Trill Enhancement On or Off



You can enable this feature when you are speaking in a language that contains many words with alveolar trill (rolling "R") pronunciations. Follow the procedure to turn Trill Enhancement on or off on your radio.

1 Do one of the following:







- Press the programmed **Trill Enhancement** button. Skip the steps below.
 - Press  to access the menu.
-

2 Press  or  to Utilities. Press  to select.

3 Press  or  to Radio Settings. Press  to select.

4 Press  or  to Trill Enhance. Press  to select.

5 Do one of the following:

- Press  or  to On. Press  to select. The display shows ✓ beside On.
 - Press  or  to Off. Press  to select. The display shows ✓ beside Off.
-

Audio Ambience

You can customize the audio ambience for your radio according to your environment.

Default

This is the default setting.

Loud

This setting enables Noise Suppressor and increases speaker loudness for use in noisy surroundings.

Work Group



This setting enables AF Suppressor and disables AGC for use when a group of radios are near to each other.



Setting Audio Ambience



Follow the procedure to set the audio ambience on your radio according to your environment.

- 1 Press  to access the menu.

- 2 Press  or  to Utilities. Press  to select.

- 3 Press  or  to Radio Settings. Press  to select.

- 4 Press  or  to Audio Ambience. Press  to select.

- 5 Press  or  to the required setting. Press  to select.

The settings are as follows.

- Choose **Default** for the default factory settings.
- Choose **Loud** to increase speaker loudness when using in noisy surroundings.
- Choose **Work Group** to reduce acoustic feedback when using with a group of radios that are near to each other.

The display shows  beside the selected setting.

Audio Profiles

You can customize the audio profiles for your radio according to your preference.

Default

This is the default setting.

Level 1, Level 2, and Level 3

These settings are intended to compensate for noise-induced hearing loss that is typical for adults in their 40's, 50's, and 60's or over.



Treble Boost, Mid Boost, and Bass Boost



These settings are intended for a tinnier sound, a more nasal sound, and a deeper sound.



Setting Audio Profiles



Follow the procedure to set audio profiles on your radio.

- 1 Press  to access the menu.

- 2 Press  or  to Utilities. Press  to select.

- 3 Press  or  to Radio Settings. Press  to select.

- 4 Press  or  to Audio Profiles. Press  to select.

- 5 Press  or  to the required setting. Press  to select.

The settings are as follows.

- Choose **Default** to disable the previously selected audio profile and return to the default factory settings.
- Choose **Level 1**, **Level 2**, or **Level 3** for audio profiles intended to compensate for noise-induced hearing loss that is typical for adults over 40 years of age.
- Choose **Treble Boost**, **Mid Boost**, or **Bass Boost** for audio profiles that align with your

preference for tinnier, more nasal, or deeper sounds.

The display shows ✓ beside the selected setting.

Turning Global Navigation Satellite System On or Off

Global Navigation Satellite System (GNSS) is a satellite navigation system that determines the radio precise location. GNSS includes Global Positioning System (GPS), Global Navigation Satellite System (GLONASS), and BeiDou Navigation Satellite System (BDS).









NOTICE:

Selected radio models may offer GPS, GLONASS, and BDS. GNSS constellation is configured by using CPS. Check with your dealer or system administrator to determine how your radio has been programmed.

- 1 Do one of the following steps to toggle GNSS on or off on your radio.
 - Press the programmed **GNSS** button.

- Press  to access the menu. Proceed to the next step.

- 2 Press  or  to Utilities. Press  to select.

- 3 Press  or  to Radio Settings. Press  to select.

- 4 Press  or  to GNSS. Press  to select.

- 5 Press  to enable or disable GNSS.
If enabled, ✓ appears beside Enabled.
If disabled, ✓ disappears beside Enabled.

Flexible Receive List



Flexible Receive List is a feature that allows you to create and assign members on the receive talkgroup list. Your radio can support a maximum of 16 members in the list. This feature is supported in Capacity Plus.

Turning Flexible Receive List On or Off







Follow the procedure to turn Flexible Receive List on or off.

1 Do one of the following:

- Press the programmed **Flexible Receive List** button. Skip the following steps.
- Press  to access the menu.

2 Press  or  to Flexible Rx List. Press  to select.

3 Do one of the following:

- Press  or  to Turn On. Press  to select.
A positive indicator tone sounds.
The display shows a positive mini notice.
- Press  or  to Turn Off. Press  to select.
A negative indicator tone sounds.
The display shows a negative mini notice.

General Radio Information



Your radio contains information on various general parameters.

The general information of your radio is as follows:

- Radio alias and ID.
- Firmware and Codeplug versions.
- Software update.
- GNSS information.
- Site information.



NOTICE:

Press  to return to the previous screen. Long press  to return to the Home screen. The radio exits the current screen once the inactivity timer expires.

Checking Radio Alias and ID



Follow the procedure to check the radio alias and ID on your radio.



1 Do one of the following:



- Press the programmed **Radio Alias and ID** button. Skip the following steps. A positive indicator tone sounds.

You can press the programmed **Radio Alias and ID** button to return to the previous screen.

- Press  to access the menu.

2 Press  or  to Utilities. Press  to select.

3 Press  or  to Radio Info. Press  to select.



4 Press  or  to My ID. Press  to select.
The first text line shows the radio alias. The second text line shows the radio ID.



Checking Firmware and Codeplug Versions



Follow the procedure to check the firmware and codeplug versions on your radio.

[Send Feedback](#)

1 Press  to access the menu.

2 Press  or  to Utilities. Press  to select.

3 Press  or  to Radio Info. Press  to select.



4 Press  or  to Versions. Press  to select.



The display shows the current firmware and codeplug versions.



Checking Software Update Information

This feature shows the date and time of the latest software update carried out through OTAP or Wi-Fi. Follow the procedure to check the software update information on your radio.

1 Press  to access the menu.

2 Press  or  to Utilities. Press  to select.

3 Press  or  to Radio Info. Press  to select.

4 Press  or  to SW Update. Press  to select.

The display shows the date and time of the latest software update.

Software Update menu is only available after at least one successful OTAP or Wi-Fi session. See [Over-the-Air Programming on page 447](#) for more information.



Checking GNSS Information

Displays the GNSS information on your radio, such as values of:



- Latitude
- Longitude
- Altitude



- Direction
- Velocity
- Horizontal Dilution of Precision (HDOP)
- Satellites
- Version

1 Press  to access the menu.

2 Press  or  to Utilities. Press  to select.

3 Press  or  to Radio Info. Press  to select.



4 Press  or  to GNSS Info. Press  to select.



5 Press  or  to the required item. Press  to select. The display shows the requested GNSS information.



Displaying Site Information

Follow the procedure to display the current site name your radio is on.

- 1 Press  to access the menu.

- 2 Press  or  to Utilities. Press  to select.

- 3 Press  or  to Radio Info. Press  to select.



- 4 Press  or  to Site Info. Press  to select.



The display shows the current site name.



Viewing Enterprise Wi-Fi Certificate Details

You can view the details of the selected Enterprise Wi-Fi Certificate.

- 1 Press  to access the menu.

- 2 Press  or  to Utilities. Press  to select.

- 3 Press  or  to Certificate Menu. Press  to select.
 ✓ appears beside ready certificates.

- 4 Press  or  to the required certificate.
 Press  to select.

Your radio displays the full details of the certificate.



NOTICE:

For unready certificates, the display shows only Status.

Authorized Accessories List

Motorola Solutions provides a list of accessories to improve the productivity of your radio.

Antenna

- VHF, 136–144 MHz, 1/4 Wave, Through-Hole Mount, Mini-U (HAD4006_)
- VHF, 146–150.8 MHz, 1/4 Wave, Through-Hole Mount, Mini-U (HAD4007_)
- VHF, 150.8–162 MHz, 1/4 Wave, Through-Hole Mount, Mini-U (HAD4008_)
- VHF, 162–174 MHz, 1/4 Wave, Through-Hole Mount, Mini-U (HAD4009_)
- UHF, 403–430 MHz, 1/4 Wave, Through-Hole Mount, Mini-U (HAE4002_)
- UHF, 450–470 MHz, 1/4 Wave, Through-Hole Mount, Mini-U (HAE4003_)
- UHF, 470–527 MHz, 1/4 Wave, Through-Hole Mount, Mini-U (HAE4004_)
- UHF, 406–420 MHz, 3.5 dB Gain, Through-Hole Mount, Mini-U (HAE4010_)
- UHF, 450–470 MHz, 3.5 dB Gain, Through-Hole Mount, Mini-U (HAE4011_)
- UHF, 470–494 MHz, 3.5 dB Gain, Through-Hole Mount, Mini-U (HAE4012_)
- UHF, 494–512 MHz, 3.5 dB Gain, Through-Hole Mount, Mini-U (HAE4013_)
- Combination GPS/UHF, 403–527 MHz, 2.0 dB Gain, Through-Hole Mount, Mini-U (HAE6019_)
- Combination GPS/UHF, 470–527 MHz, 1/4 Wave, Through-Hole Mount, Mini-U (HAE6020_)
- UHF, 403–527 MHz, 2.0 dB Gain, Through-Hole Mount, Mini-U (HAE6022_)
- Combination GPS/UHF, 470–494 MHz, 3.0 dB Gain, Through-Hole Mount, Mini-U (HAE6024_)
- Combination GPS/UHF, 494–512 MHz, 3.0 dB Gain, Through-Hole Mount, Mini-U (HAE6026_)
- 800/900, 806–941 MHz, 5.0dB Gain, Through-Hole Mount, Mini-U (HAF4027_)
- Combination GPS+RF, 806–941 MHz, 1/4 Wave, Through-Hole Mount, Mini-U (HAF4029_)
- Combination GPS+RF, 806–941 MHz, 3.0 dB Gain, Through-Hole Mount, Mini-U (HAF4030_)

- Combination GPS+RF, 806–941 MHz, 5.0 dB Gain, Through-Hole Mount, Mini-U (HAF4032_)
 - Combination GPS+RF, 806–941 MHz, 5.0 dB Gain, Through-Hole Mount, Mini-U (HAF4033_)
 - Combination GPS/UHF, 403–430 MHz, 1/4 Wave, Through-Hole Mount, Mini-U (PMAE4030_)
 - Combination GPS/UHF, 450–470 MHz, 1/4 Wave, Through-Hole Mount, Mini-U (PMAE4031_)
 - Combination GPS/UHF, 406–420 MHz, 3.5 dB Gain, Through-Hole Mount, Mini-U (PMAE4032_)
 - Combination GPS/UHF, 450–470 MHz, 3.5 dB Gain, Through-Hole Mount, Mini-U (PMAE4033_)
 - Combination GPS/UHF, 450–470 MHz, 5.0 dB Gain, Through-Hole Mount, Mini-U (PMAE4034_)
 - Fixed Mount GPS Active Antenna (PMAN4000_)
 - Window Mount GPS Active Antenna (PMAN4001_)
 - Magnetic Mount GPS Active Antenna (PMAN4002_)
 - Combination GPS+RF, Base Only, Through-hole Mount, Mini-U (PMAN4004_)
 - Combination GPS/VHF, 136–144 MHz, 1/4 Wave, Through-Hole Mount, Mini-U (RAD4214_)
 - Combination GPS/VHF, 146–150.8 MHz, 1/4 Wave, Through-Hole Mount, Mini-U (RAD4215_)
 - Combination GPS/VHF, 150.8–162 MHz, 1/4 Wave, Through-Hole Mount, Mini-U (RAD4216_)
 - Combination GPS/VHF, 162–174 MHz, 1/4 Wave, Through-Hole Mount, Mini-U (RAD4217_)
 - Combination GPS/VHF, 146–172 MHz, 3.0 dB Gain, Through-Hole Mount, Mini-U (RAD4218_)
 - UHF, 445–470 MHz, 5.0 dB Gain, Through-Hole Moun, Mini-U (with base) (RAE4004_RB)
 - UHF, 445–470 MHz, 5.0 dB Gain, Through-Hole Mount, Mini-U (without base) (RAE4004_)
- For use with base PMAN4004_ only:**
- UHF, 494–512 MHz, 3.0 dB Gain, Through-Hole Mount (HAE6027_)
 - UHF, 470–494 MHz, 3.0 dB Gain, Through-Hole Mount (HAE6028_)
 - UHF, 403–527 MHz, 2.0 dB Gain, Through-Hole Mount (HAE6029_)
 - UHF, 470–527 MHz, 1/4 Wave, Through-Hole Mount (HAE6030_)
 - UHF, 403–430 MHz, 1/4 Wave (PMAE4039_)

- UHF, 450–470 MHz, 1/4 Wave (PMAE4041_)
- UHF, 406–420 MHz, 3.5 dB Gain (PMAE4040_)
- UHF, 450–470 MHz, 3.5 dB Gain (PMAE4042_)
- UHF, 450–470 MHz, 5.0 dB Gain (PMAE4043_)
- VHF, 162–174 MHz, 1/4 Wave (RAD4223_)
- VHF, 150.8–162 MHz, 1/4 Wave (RAD4224_)
- VHF, 146–150.8 MHz, 1/4 Wave (RAD4225_)
- VHF, 136–144 MHz, 1/4 Wave (RAD4226_)
- VHF, 146–172 MHz, 3.0 dB Gain (RAD4227_)
- Non-Secure Wireless Headset & Push-to-Talk Device with Push-to-Talk Audio, 12-Inch Cable (NNTN8189_)
- Bluetooth Accessory Kit, SP, 9.5 in. Cable (NNTN8190_)
- Wireless Covert Kit, includes two sets of 2-Wire Earbuds (1 Black and 1 White), 1-Wire Earbud (Black), and a 3.5 mm Adapter to plug into any off-the-shelf headphones (NNTN8296_) ¹¹
- Wireless Neckloop Y-adapter and retention hook for Completely Discreet Kit (NNTN8385_) ¹³

Audio Accessories

- HK200 Bluetooth Headset (89409N)
- Telephone Style Handset (HMN4098_)
- Operations Critical Wireless Earpiece, 12 in. Cable (NNTN8125_)
- Operations Critical Wireless Earpiece, 9.5 in. Cable (NNTN8126_)
- Operations Critical Wireless Push-to-Talk POD (NNTN8127_)
- Flexible Fit Swivel Earpiece with Boom Mic (PMLN7181_) ¹³
- Flexible Fit Swivel Earpiece with Boom Mic, Multipack (PMLN7203_) ¹³
- Completely Discreet Earpiece Kit (RLN4922_) ¹³
- XBT Behind-the-Neck, Non-secure Wireless Heavy Duty Headset (RLN6490_)
- XBT Overhead, Non-secure Wireless Heavy Duty Headset (RLN6491_)
- MOTOTRBO Bluetooth Accessory Kit with NA Power Supply (RLN6500_)

¹¹ Your radio is compatible with the accessories listed here. Contact your dealer for details.

- Swivel Earpiece with In-Line Microphone for Bluetooth Accessory Kit Pod, Pack of 3 (RLN6550_) ¹³
- Desktop Microphone (RMN5050_)
- Compact Microphone (RMN5052_)
- IMPRES 4-Way Navigation Keypad Microphone (RMN5127_)
- Heavy Duty Microphone with Enhanced Audio (RMN5053_)
- Visor Microphone with Enhanced Audio (RMN5054_)

Cables

- Compact Microphone Replacement Cable (3075336B07)
- Heavy Duty/Keypad Microphone Replacement Cable (3075336B10)
- Power Cable to Battery, 10-foot (3-metre) Cable, 15 amp (1–25 Watt) (HKN4137_)
- Power Cable to Battery, 10-foot (3-metre) Cable, 20 amp (1–45 Watt) (HKN4191_)
- Power Cable to Battery, 20-foot (6-metre) Cable, 20 amp (1–45 Watt) (HKN4192_)
- Mobile Front (MMP) Programming Cable (HKN6184_)

[Send Feedback](#)

- MAP Programming Cable (PMKN4010_)
- MAP Programming and Test Cable (PMKN4016_)
- Mobile and Repeater Rear Accessory Connector Universal Cable (PMKN4018_)
- Mobile Mic Extension Cable, 10 feet (PMKN4033_)
- Mobile Mic Extension Cable, 20 feet (PMKN4034_)
- Remote Mount (3-metre) Cable (PMKN4143_)
- Remote Mount (5-metre) Cable (PMKN4144_)
- Ignition Sense Cable (RKN4136_)

Desktop Accessories

- US Line Cord (3060665A04)
- Radio Power Cable for GPN6145 (GKN6266_)
- Desktop Tray without Speaker (GLN7318_)
- Switchmode Power Supply (1 – 25 Watt Models) (CE marked) (GPN6145_)
- Power Supply and Cable (HPN4007_)
- Hardware Kit for Rear Accessory Connector (PMLN5072_)
- Desktop Tray with Speaker (RSN4005_)

Mounting Kits

- Screen Protector, Clear (single pack contains one unit) (AY000269A01_) ¹²
- In Dash (DIN) Mounting Kit (RLN6465_)
- Low Profile Trunnion Kit (RLN6466_)
- High Profile Trunnion Kit (RLN6467_)
- Key Lock Trunnion Kit (RLN6468_)
- Low Profile Trunnion – Bag (RLN6469_)
- Remote Mount Transceiver Interface (PMLN6402_)
- Remote Mount Control Head Interface (PMLN6403_)

Miscellaneous Accessories

- Surge Protector, Tower Mount Kit (DQT1)
- Surge Protector, Coax Protector Bulkhead (DSISB50LNC2MA)
- PL259/Mini-U Antenna Adapter, 8 feet (2.4 metre) Cable (HKN9557_)

- Microphone Hang Up Clip (All Microphones) (HLN9073_)
- Universal Microphone Hang Up Clip (All Microphones) (HLN9414_)
- IMPRES Mobile MMP Non-PC Adapter (PMKN4072_)
- IMPRES Mobile MAP Non-PC Adapter (PMKN4070_)
- Generic Option Board (PMLN5718_S)
- Operations Critical Wireless 1-Wire Surveillance Kit with translucent tube (PMLN7052_) ¹³
- Push Button PTT (RLN5926_)
- Emergency Footswitch (RLN5929_)
-

Speakers

- 13 W External Speaker (RSN4002_)
- 7.5 W External Speaker (RSN4003_)
- 5 W External Speaker (RSN4004_)

¹² Your radio is compatible with the accessories listed here. Contact your dealer for details.

¹³ Your radio is compatible with the accessories listed here. Contact your dealer for details.

Maritime Radio Use in the VHF Frequency Range

Special Channel Assignments

Emergency Channel

If you are in imminent and grave danger at sea and require emergency assistance, use VHF Channel 16 to send a distress call to nearby vessels and the United States Coast Guard. Transmit the following information, in this order:

- 1 "MAYDAY, MAYDAY, MAYDAY."
- 2 "THIS IS _____, CALL SIGN _____." State the name of the vessel in distress 3 times, followed by the call sign or other identification of the vessel, stated 3 times.
- 3 Repeat "MAYDAY" and the name of the vessel.
- 4 "WE ARE LOCATED AT _____." State the position of the vessel in distress, using any information that will help responders to locate you, e.g.:
 - latitude and longitude

- bearing (state whether you are using true or magnetic north)
- distance to a well-known landmark
- vessel course, speed or destination

- 5 State the nature of the distress.
- 6 Specify what kind of assistance you need.
- 7 State the number of persons on board and the number needing medical attention, if any.
- 8 Mention any other information that would be helpful to responders, such as type of vessel, vessel length and/or tonnage, hull color, etc.
- 9 "OVER."
- 10 Wait for a response.
- 11 If you do not receive an immediate response, remain by the radio and repeat the transmission at intervals until you receive a response. Be prepared to follow any instructions given to you.

Non-Commercial Call Channel

For non-commercial transmissions, such as fishing reports, rendezvous arrangements, repair scheduling, or berthing information, use **VHF Channel 9**.

Operating Frequency Requirements

A radio designated for shipboard use must comply with Federal Communications Commission Rule Part 80 as follows:

- on ships subject to Part II of Title III of the Communications Act, the radio must be capable of operating on the 156.800 MHz frequency.
- on ships subject to the Safety Convention, the radio must be capable of operating:
 - in the simplex mode on the ship station transmitting frequencies specified in the 156.025–157.425 MHz frequency band, and
 - in the semiduplex mode on the two frequency channels specified in the table below.



NOTICE:

Simplex channels 3, 21, 23, 61, 64, 81, 82, and 83 cannot be lawfully used by the general public in US waters.

Additional information about operating requirements in the Maritime Services can be obtained from the full text of FCC Rule Part 80 and from the US Coast Guard.

Table 16: VHF Marine Channel List

Channel Number	Frequency (MHz)	
	Transmit	Receive
1	156.050	160.650
2	156.100	160.700
*	156.150	160.750
4	156.200	160.800
5	156.250	160.850
6	156.300	–
7	156.350	160.950
8	156.400	–
9	156.450	156.450
10	156.500	156.500
11	156.550	156.550
12	156.600	156.600
13**	156.650	156.650
14	156.700	156.700
15**	156.750	156.750

16	156.800	156.800
17**	156.850	156.850
18	156.900	161.500
19	156.950	161.550
20	157.000	161.600
*	157.050	161.650
22	157.100	161.700
*	157.150	161.750
24	157.200	161.800
25	157.250	161.850
26	157.300	161.900
27	157.350	161.950
28	157.400	162.000
60	156.025	160.625
*	156.075	160.675
62	156.125	160.725
63	156.175	160.775
*	156.225	160.825

65	156.275	160.875
66	156.325	160.925
67**	156.375	156.375
68	156.425	156.425
69	156.475	156.475
71	156.575	156.575
72	156.625	–
73	156.675	156.675
74	156.725	156.725
75	***	***
76	***	***
77**	156.875	–
78	156.925	161.525
79	156.975	161.575
80	157.025	161.625
*	157.075	161.675
*	157.125	161.725
*	157.175	161.775

84	157.225	161.825
85	157.275	161.875
86	157.325	161.925
87	157.375	161.975
88	157.425	162.025

use when it operates on the distress and safety frequencies specified in RSS-182 Section 7.3.

Technical Parameters for Interfacing External Data Sources

	RS232	USB	SB9600
Input Voltage (Volts Peak-to-peak)	18V	3.6V	5V
Max Data Rate	28 kb/s	12 Mb/s	9.6 kb/s
Impedance	5000 ohm	90 ohm	120 ohm



NOTICE:

* Simplex channels 3, 21, 23, 61, 64, 81, 82, and 83 cannot be **lawfully used** by the general public in US waters.

** Low power (1 W) only.

*** Guard band.



NOTICE:

A – in the Receive column indicates that the channel is transmit only.

Declaration of Compliance for the Use of Distress and Safety Frequencies

The radio equipment does not employ a modulation other than the internationally adopted modulation for maritime

Limited Warranty

MOTOROLA SOLUTIONS COMMUNICATION PRODUCTS

I. WHAT THIS WARRANTY COVERS AND FOR HOW LONG:

Motorola Solutions, Inc. ("Motorola Solutions") warrants the Motorola Solutions manufactured Communication Products listed below ("Product") against defects in material and workmanship under normal use and service for a period of time from the date of purchase as scheduled below:

Mobile Radios	Two (2) Years
Product Accessories	One (1) Year

Motorola Solutions, at its option, will at no charge either repair the Product (with new or reconditioned parts), replace it (with a new or reconditioned Product), or refund the purchase price of the Product during the warranty period provided it is returned in accordance with the terms of this warranty. Replaced parts or boards are warranted

for the balance of the original applicable warranty period. All replaced parts of Product shall become the property of Motorola Solutions.

This express limited warranty is extended by Motorola Solutions to the original end user purchaser only and is not assignable or transferable to any other party. This is the complete warranty for the Product manufactured by Motorola Solutions. Motorola Solutions assumes no obligations or liability for additions or modifications to this warranty unless made in writing and signed by an officer of Motorola Solutions.

Unless made in a separate agreement between Motorola Solutions and the original end user purchaser, Motorola Solutions does not warrant the installation, maintenance or service of the Product.

Motorola Solutions cannot be responsible in any way for any ancillary equipment not furnished by Motorola Solutions which is attached to or used in connection with the Product, or for operation of the Product with any ancillary equipment, and all such equipment is expressly excluded from this warranty. Because each system which may use the Product is unique, Motorola Solutions disclaims liability for range, coverage, or operation of the system as a whole under this warranty.

II. GENERAL PROVISIONS

This warranty sets forth the full extent of Motorola Solutions responsibilities regarding the Product. Repair, replacement or refund of the purchase price, at Motorola Solutions option, is the exclusive remedy. THIS WARRANTY IS GIVEN IN LIEU OF ALL OTHER EXPRESS WARRANTIES. IMPLIED WARRANTIES, INCLUDING WITHOUT LIMITATION, IMPLIED WARRANTIES OF MERCHANTABILITY AND FITNESS FOR A PARTICULAR PURPOSE, ARE LIMITED TO THE DURATION OF THIS LIMITED WARRANTY. IN NO EVENT SHALL MOTOROLA SOLUTIONS BE LIABLE FOR DAMAGES IN EXCESS OF THE PURCHASE PRICE OF THE PRODUCT, FOR ANY LOSS OF USE, LOSS OF TIME, INCONVENIENCE, COMMERCIAL LOSS, LOST PROFITS OR SAVINGS OR OTHER INCIDENTAL, SPECIAL OR CONSEQUENTIAL DAMAGES ARISING OUT OF THE USE OR INABILITY TO USE SUCH PRODUCT, TO THE FULL EXTENT SUCH MAY BE DISCLAIMED BY LAW.

III. STATE LAW RIGHTS:

SOME STATES DO NOT ALLOW THE EXCLUSION OR LIMITATION OF INCIDENTAL OR CONSEQUENTIAL DAMAGES OR LIMITATION ON HOW LONG AN IMPLIED

WARRANTY LASTS, SO THE ABOVE LIMITATION OR EXCLUSIONS MAY NOT APPLY.

This warranty gives specific legal rights, and there may be other rights which may vary from state to state.

IV. HOW TO GET WARRANTY SERVICE

You must provide proof of purchase (bearing the date of purchase and Product item serial number) in order to receive warranty service and, also, deliver or send the Product item, transportation and insurance prepaid, to an authorized warranty service location. Warranty service will be provided by Motorola Solutions through one of its authorized warranty service locations. If you first contact the company which sold you the Product (for example, dealer or communication service provider), it can facilitate your obtaining warranty service. You can also call Motorola Solutions at 1-800-927-2744.

V. WHAT THIS WARRANTY DOES NOT COVER

- 1 Defects or damage resulting from use of the Product in other than its normal and customary manner.

- 2 Defects or damage from misuse, accident, water, or neglect.
- 3 Defects or damage from improper testing, operation, maintenance, installation, alteration, modification, or adjustment.
- 4 Breakage or damage to antennas unless caused directly by defects in material workmanship.
- 5 A Product subjected to unauthorized Product modifications, disassembles or repairs (including, without limitation, the addition to the Product of non-Motorola Solutions supplied equipment) which adversely affect performance of the Product or interfere with Motorola Solutions normal warranty inspection and testing of the Product to verify any warranty claim.
- 6 Product which has had the serial number removed or made illegible.
- 7 Rechargeable batteries if:
 - any of the seals on the battery enclosure of cells are broken or show evidence of tampering.
 - the damage or defect is caused by charging or using the battery in equipment or service other than the Product for which it is specified.
- 8 Freight costs to the repair depot.
- 9 A Product which, due to illegal or unauthorized alteration of the software/firmware in the Product, does not function in accordance with Motorola Solutions published specifications or the FCC certification labeling in effect for the Product at the time the Product was initially distributed from Motorola Solutions.
- 10 Scratches or other cosmetic damage to Product surfaces that does not affect the operation of the Product.
- 11 Normal and customary wear and tear.

VI. PATENT AND SOFTWARE PROVISIONS

Motorola Solutions will defend, at its own expense, any suit brought against the end user purchaser to the extent that it is based on a claim that the Product or parts infringe a United States patent, and Motorola Solutions will pay those costs and damages finally awarded against the end user purchaser in any such suit which are attributable to any such claim, but such defense and payments are conditioned on the following:

- 1 Motorola Solutions will be notified promptly in writing by such purchaser of any notice of such claim,

- 2 Motorola Solutions will have sole control of the defense of such suit and all negotiations for its settlement or compromise, and
- 3 Should the Product or parts become, or in Motorola Solutions opinion be likely to become, the subject of a claim of infringement of a United States patent, that such purchaser will permit Motorola Solutions, at its option and expense, either to procure for such purchaser the right to continue using the Product or parts or to replace or modify the same so that it becomes non-infringing or to grant such purchaser a credit for the Product or parts as depreciated and accept its return. The depreciation will be an equal amount per year over the lifetime of the Product or parts as established by Motorola Solutions.

Motorola Solutions will have no liability with respect to any claim of patent infringement which is based upon the combination of the Product or parts furnished hereunder with software, apparatus or devices not furnished by Motorola Solutions, nor will Motorola Solutions have any liability for the use of ancillary equipment or software not furnished by Motorola Solutions which is attached to or used in connection with the Product. The foregoing states the entire liability of Motorola Solutions with respect to infringement of patents by the Product or any parts thereof.

Laws in the United States and other countries preserve for Motorola Solutions certain exclusive rights for copyrighted Motorola Solutions software such as the exclusive rights to reproduce in copies and distribute copies of such Motorola Solutions software. Motorola Solutions software may be used in only the Product in which the software was originally embodied and such software in such Product may not be replaced, copied, distributed, modified in any way, or used to produce any derivative thereof. No other use including, without limitation, alteration, modification, reproduction, distribution, or reverse engineering of such Motorola Solutions software or exercise of rights in such Motorola Solutions software is permitted. No license is granted by implication, estoppel or otherwise under Motorola Solutions patent rights or copyrights.

VII. GOVERNING LAW

This Warranty is governed by the laws of the State of Illinois, U.S.A.

Déclaration de conformité

Cette déclaration est applicable à votre radio uniquement si elle porte l'étiquette du logo de la FCC ci-dessous.

Déclaration de conformité

Règlement CFR 47 partie 2 section 2.1077(a) de la FCC



Partie responsable

Nom : Motorola Solutions, Inc.

Adresse : 1303 East Algonquin Road, Schaumburg, IL 60196-1078, U.S.A.

Numéro de téléphone : 1 800 927-2744.

Déclare par les présentes que le produit :

Nom de modèle : **XPR 5550/XPR 5580/XPR 5550e/XPR 5580e**

sont conformes aux réglementations suivantes :

Partie 15, sous-partie B, section 15.107(a), 15.107(d) et section 15.109(a) des règlements de la FCC

Appareil numérique de Classe B

En tant que périphérique d'ordinateur personnel, cet appareil est conforme aux stipulations de la partie 15 des règlements de la FCC. Cet appareil est conforme aux CNR d'Industrie Canada applicables aux appareils radio exempts de licence. Son utilisation est assujettie aux deux conditions suivantes :

- 1 Cet appareil ne doit pas causer d'interférence nuisible.
- 2 Cet appareil doit accepter toute interférence reçue, y compris les interférences pouvant entraîner un fonctionnement indésirable.

**AVIS:**

Cet équipement a fait l'objet de tests et a été déclaré conforme aux limites établies pour un appareil numérique de classe B, conformément à la section 15 des règlements de la FCC. Ces limites sont fixées afin d'offrir une protection suffisante contre des interférences nuisibles dans une installation résidentielle. Cet équipement génère, utilise et peut émettre de l'énergie de radiofréquence et, s'il n'est pas installé ou utilisé conformément aux instructions, il peut provoquer un brouillage nuisible aux communications radio. Cependant, il est impossible de garantir qu'il n'y aura aucune interférence dans une installation particulière.

Si cet appareil cause une interférence nuisible à la réception de la radio ou de la télévision, ce qui peut être déterminé en éteignant et en allumant l'appareil, vous êtes encouragé à remédier à la situation en prenant une ou plusieurs des mesures suivantes :

- Réorienter ou déplacer l'antenne réceptrice.
- Augmenter la distance entre l'équipement et le récepteur.
- Brancher l'appareil dans une autre prise sur un circuit différent de celui du récepteur.
- Consulter un revendeur ou un technicien de radio ou de télévision chevronné pour obtenir de l'aide.

Table des matières

Déclaration de conformité.....	2	Afficher l'information de points d'extrémité WAVE.....	47
Consignes de sécurité importantes.....	32	Changer la configuration WAVE.....	48
Avis aux utilisateurs (FCC et Industrie Canada).....	33	Appels de groupe.....	49
Version logicielle.....	34	Section I: Opérations Capacity Max.....	51
Droits d'auteur.....	35	Bouton d'émission (PTT).....	51
Droits d'auteur du logiciel.....	37	Touches programmables.....	51
Précautions de manipulation.....	38	Fonctions attribuables de la radio.....	52
Chapitre 1: Opérations de base.....	40	Réglages ou fonctions attribuables.....	54
Mise en marche de la radio.....	40	Accès aux fonctions programmées.....	55
Éteindre la radio.....	40	Indicateurs d'état.....	55
Réglage du volume.....	40	Icônes.....	55
Chapitre 2: Commandes de la radio.....	42	Voyant lumineux.....	62
Bouton Volume/Canal.....	42	Tonalités.....	63
Régler les préférences d'utilisation du sélecteur double.....	43	Tonalités audio.....	63
Touches du microphone à clavier.....	43	Tonalités d'avertissement.....	63
Chapitre 3: WAVE.....	46	Enregistrement.....	64
Régler le canal actif WAVE.....	46	Sélection des zones et des canaux.....	65
Afficher l'information de canal WAVE.....	47	Sélection des zones.....	65
		Sélection des zones à l'aide de la recherche d'alias.....	66
		Sélection d'un type d'appel.....	66

Sélectionner un site.....	67	Réception d'appels de diffusion...	79
Demande d'itinérance.....	67	Appel individuel.....	80
Verrouillage de site activé/désactivé.....	67	Exécution d'un appel individuel....	80
Restriction de site.....	68	Appels individuels faits à l'aide de la touche numérique programmable	81
ADF de site.....	68	Appels individuels faits à l'aide de la recherche d'alias	82
Appels.....	69	Appel individuel fait à l'aide du bouton de composition à une touche.....	84
Appels de groupe.....	70	Appels individuels faits à l'aide de la numérotation manuelle	85
Appels de groupe.....	70	Réception d'un appel individuel...	86
Appels de groupe faits à l'aide de la liste de contacts.....	71	Accepter des appels individuels...	86
Appels de groupe faits à l'aide de la touche numérique programmable	72	Refus des appels individuels.....	87
Appels de groupe faits à l'aide de la recherche d'alias	73	Appels généraux.....	88
Réponse à un appel de groupe....	76	Appel général.....	88
Appel de diffusion.....	77	Appels généraux faits à l'aide de de la touche numérique programmable	89
Appels de diffusion.....	77	Appels généraux faits à l'aide de de la recherche d'alias.....	89
Appels de diffusion faits à l'aide de la liste de contacts.....	78		
Appels de diffusion faits à l'aide de la touche numérique programmable.....	78		

Réception d'un appel général.....	91	Réponse à un appel	
Appels téléphoniques.....	92	téléphonique en mode Appel	
Exécution d'un appel		individuel.....	105
téléphonique.....	92	Priorité d'appel.....	106
Acheminement d'appels		Interruption vocale.....	106
téléphoniques à l'aide de la		Activation de l'interruption	
touche programmable 	93	vocale.....	106
Appels téléphoniques faits à		Fonctions avancées.....	107
l'aide de la liste de contacts	96	Files d'attente d'appels.....	107
Appels téléphoniques faits à		Appel prioritaire.....	108
l'aide de la recherche d'alias.....	98	Balayage de groupe d'appels.....	109
Appels téléphoniques faits à		Activer ou désactiver le	
l'aide de la numérotation		balayage de groupe.....	109
manuelle.....	101	Liste de groupe de réception.....	110
Multifréquence à deux tonalités.	103	Surv. prioritaire.....	111
Exécution d'un appel		Modifier l'ordre de priorité d'un	
DTMF.....	103	groupe d'appels.....	111
Réponse à un appel		Affiliation de groupes multiples.....	112
téléphonique en mode appel		Ajout d'affiliation de groupe.....	113
général.....	104	Suppression de l'affiliation de	
Réponse à un appel		groupe.....	114
téléphonique en mode appel de		TalkBack (réponse).....	115
groupe.....	104	Bluetooth.....	115

Activer ou désactiver Bluetooth. 116	Lancer une recherche de site manuelle..... 123
Connexion aux dispositifs Bluetooth..... 117	Verrouillage de site activé/désactivé..... 124
Connexion aux dispositifs Bluetooth en mode Détection..... 118	Accès à la liste de sites voisins.. 124
Déconnexion de dispositifs Bluetooth..... 118	Rappel du canal d'accueil..... 124
Changer l'acheminement du signal audio entre le haut-parleur interne de la radio et le dispositif Bluetooth..... 119	Mettre en sourdine le rappel du canal d'accueil..... 125
Affichage de renseignements détaillés sur les appareils..... 120	Réglage de nouveaux canaux d'accueil..... 125
Supprimer le nom d'un dispositif 120	Écoute à distance..... 126
Gain du micro Bluetooth..... 121	Lancer la fonction Écoute ambiance..... 126
Localisation interne..... 121	Activation de l'Écoute ambiance à l'aide de la liste de contacts ... 127
Activation ou désactivation de la fonction Positionnement à l'intérieur..... 121	Activation de l'écoute à distance à l'aide de la numérotation manuelle..... 128
Accès aux données sur l'emplacement des balises de positionnement à l'intérieur..... 123	Réglages des contacts..... 129
Réglages multisite..... 123	Association d'une entrée à une touche numérique programmable..... 129

Dissociation d'une entrée et de la touche numérique programmable.....	131	Fonctions du Journal des appels.....	138
Ajout d'un nouveau contact.....	131	Affichage des derniers appels....	138
Réglages de l'indicateur d'appel.....	132	Stockage des alias ou des ID de la liste d'appels.....	138
Activation ou désactivation des sonneries d'appel des appels privés.....	132	Suppression des appels de la liste d'appel.....	139
Activation ou désactivation des sonneries d'appel des messages textes.....	133	Suppression d'un appel général de la liste d'appel.....	140
Activation ou désactivation des sonneries d'appel des avertissements d'appel.....	134	Affichage des détails de la liste d'appels.....	141
Activation ou désactivation des sonneries d'appel des appels sélectifs.....	135	Fonction Avertissement d'appel.....	141
Activer ou désactiver les sonneries d'appel des états de téléométrie avec message texte..	136	Exécution d'une alerte d'appel...	142
Attribuer des styles de sonneries.....	136	Avis d'appels faits à l'aide de la liste de contacts.....	143
Augmenter le volume de la tonalité d'alarme.....	137	Réponse à un avertissement d'appel.....	143
		Mode Muet.....	144
		Activation du mode muet.....	144
		Réglage de la minuterie du mode muet.....	145
		Quitter le mode muet.....	145
		Fonctionnement d'urgence.....	146
		Envoi des alarmes d'urgence.....	147

Envoi d'une alarme d'urgence avec un appel.....	148	Suppression de tous les messages d'état.....	161
Envoi d'une alarme d'urgence suivie d'un appel vocal.....	150	Messagerie texte.....	161
Réception d'une alarme d'urgence.....	152	Messages texte.....	162
Réponse à une alarme d'urgence	153	Affichage des messages texte.....	162
Répondre à des alarmes d'urgence par un appel.....	154	Afficher des messages texte d'état de télémétrie.	163
Message d'état.....	155	Réponse à des messages texte.....	163
Envoi de messages d'état.....	155	Réponse à des messages texte par un texte rapide.....	164
Envoi de message d'état à l'aide de la touche programmable.....	156	Renvoi des messages texte.....	165
Envoi d'un message d'état en utilisant la liste de contacts.....	157	Transfère des messages texte.....	166
Envoi de message d'état à l'aide de la numérotation manuelle.....	157	Transfère des messages texte à l'aide de la numérotation manuelle....	166
Affichage des messages d'état..	158	Modification de messages texte.....	167
Réponse à des messages d'état	159	Rédaction de messages texte.....	168
Suppression d'un message d'état.....	160		

Envoi de messages texte	169	Modification de messages texte enregistrés.....	176
Suppression des messages texte de la boîte de réception.....	170	Suppression de messages texte enregistrés du dossier brouillons.....	177
Suppression de tous les messages texte de la boîte de réception.....	171	Message texte rapide	177
Messages texte envoyés.....	172	Envoi de messages texte rapides	177
Affichage des messages texte envoyés.....	172	Configuration de saisie de texte.....	178
Envoi de messages texte envoyés.....	173	Activation ou désactivation du mot correct.....	179
Suppression d'un message texte envoyé à partir du dossier messages envoyés.....	174	Activation ou désactivation de la prédiction du texte.....	180
Suppression de tous les messages texte envoyés du dossier messages envoyés.....	174	Majuscule en début de phrase... ..	180
Messages texte enregistrés.....	175	Afficher des mots personnalisés	181
Affichage de messages texte enregistrés.....	175	Modifier des mots personnalisés	182
		Ajouter des mots personnalisés.	183
		Supprimer un mot personnalisé.	184
		Supprimer tous les mots personnalisés.....	185

Tickets de tâche.....	186	Interruption d'une radio à l'aide de la liste de contacts.....	196
Accès au dossier Tickets de tâche.....	187	Désactiver une radio à l'aide de la numérotation manuelle.....	196
Connexion ou déconnexion du serveur distant.....	188	Relance d'une radio.....	197
Création de tickets de tâche.....	188	Relance d'une radio à l'aide de la liste de contacts.....	198
Répondre à des tickets de tâche.....	189	Rallumer une radio à l'aide de la numérotation manuelle.....	198
Envoi de tickets de tâche en utilisant un modèle de ticket de tâche.....	190	Désactivation permanente de la radio..	200
Envoi de tickets de tâche en utilisant plus d'un modèle de ticket de tâche.....	191	Travailleur solitaire.....	200
Suppression de tickets de tâche	191	Fonctions de verrouillage par mot de passe.....	200
Supprimer tous les tickets de tâche.....	192	Accès aux radios à l'aide des mots de passe.....	201
Cryptage.....	193	Déverrouillage de la radio.....	201
Activer ou désactiver le cryptage.....	194	Activation/désactivation du verrouillage par mot de passe...	202
Interrompre/Raviver.....	194	Changement de mot de passe...	203
Interrompre une radio.....	195	Liste de notifications.....	204
		Accès à liste de notification.....	204
		Programmation par onde radio.....	205

Sélection de modes de connexion de périphériques tiers.....	205	Retrait de points d'accès réseau	213
Indicateur d'intensité du signal reçu.....	206	Utilitaires.....	214
Affichage des valeurs RSSI (indicateur d'intensité de réception du signal).....	206	Niveaux de puissance.....	214
Configuration du panneau avant.....	207	Configuration de la puissance.....	214
Entrée dans la Mode de configuration du panneau avant.	207	Activation ou désactivation des sonneries et alertes de la radio.....	215
Modifier les paramètres de mode FPC	207	Activer ou désactiver les tonalités du clavier.....	216
Fonctionnement Wi-Fi.....	208	Configuration de la compensation de volume des sonneries et des alertes....	217
Activer ou désactiver la fonction Wi-Fi.....	208	Activation ou désactivation de la tonalité d'autorisation de parler.....	218
Connexion à un point d'accès réseau.....	209	Activation et désactivation de la tonalité de mise sous tension.....	219
Vérification de l'état de la connexion Wi-Fi.....	210	Configuration des sonneries d'avis de messages texte.....	220
Actualisation de la liste de réseaux.....	211	Changement des modes d'affichage....	220
Ajout d'un réseau.....	212	Configuration de la luminosité de l'affichage.....	221
Affichage des détails de points d'accès réseau.....	212	Activation ou désactivation de l'avertisseur / des phares.....	222
		Activation ou désactivation des voyants DEL.....	223

Activer et désactiver le système de diffusion publique.....	223	Activer ou désactiver l'amélioration de la vibration.....	232
Activer et désactiver le système de diffusion publique externe.....	224	Ambiance audio.....	233
Activer ou désactiver l'écran d'introduction.....	225	Configuration de l'ambiance audio.....	233
Sélection de la langue.....	226	Profils audio.....	234
Déterminer le type de câble.....	226	Configuration des profils audio..	234
Activation ou désactivation de l'assistance parlée.....	227	Activer et désactiver le système de système satellite de navigation mondial.....	235
Activation ou désactivation de la carte d'option.....	227	Renseignements généraux sur la radio	236
Synthèse texte-parole.....	227	Vérification de l'alias et l'ID de la radio.....	236
Réglage de la synthèse texte-parole.....	228	Vérification des versions du micrologiciel et de la codeplug...	237
Réglage du délai menu.....	229	Vérification des informations de mise à jour du logiciel.....	237
Activation ou désactivation du microphone numérique.....	229	Consulter les informations du GNSS.....	238
Activation ou désactivation de la fonction Audio intelligent.....	230	Affichage de l'information sur le site.....	239
Activer ou désactiver la fonction de suppression des réactions acoustiques	231	Affichage des détails du certificat Wi-Fi d'entreprise.....	239

Section II: Fonctionnement Connect Plus.....	241	Sélectionner un site.....	251
Autres commandes de la radio en mode		Demande d'itinérance.....	251
Connect Plus.....	241	Verrouillage de site activé/ désactivé.....	252
Bouton d'émission (PTT).....	241	Restriction de site.....	252
Touches programmables.....	241	Sélection d'une zone.....	252
Fonctions attribuables de la radio.....	242	Utilisation de réseaux multiples.....	254
Réglages ou fonctions attribuables.....	244	Sélection d'un type d'appel.....	254
Description des indicateurs d'état en mode Connect Plus.....	244	Réception et réponse à un appel.....	254
Icônes d'affichage.....	244	Recevoir un appel de groupe et y répondre.....	255
Icônes d'appels.....	247	Recevoir un appel individuel et y répondre.....	255
Icônes de menu avancé.....	248	Réception d'un appel général....	256
Icônes de messages envoyés....	248	Réception d'un appel téléphonique individuel entrant..	256
Icônes de dispositif Bluetooth....	249	Composition surnuméraire en mémoire tampon lors d'un appel téléphonique individuel entrant.....	257
Voyant lumineux.....	249	Composition surnuméraire en direct	
Tonalités d'avertissement.....	250		
Tonalités d'alerte.....	250		
Sélection des modes Connect Plus et non Connect Plus.....	251		
Recevoir et faire des appels en mode Connect Plus.....	251		

lors d'un appel téléphonique individuel entrant.....	258	Passer un appel individuel.....	263
Réception d'un appel de Talkgroup entrant.....	258	Faire un appel téléphonique individuel sortant à l'aide du bouton programmable de numérotation manuelle.....	264
Appel téléphonique multigroupe entrant.....	258	Faire un appel téléphonique individuel sortant au moyen du menu du téléphone.....	264
Faire un appel radio.....	258	Faire un appel téléphonique individuel sortant à partir des Contacts.....	265
Faire un appel à l'aide du bouton sélecteur de canal.....	259	Attente d'autorisation de canal lors d'un appel individuel sortant	267
Pour passer un appel de groupe.....	259	Composition surnuméraire en mémoire tampon en cours d'appel téléphonique individuel sortant.....	267
Passer un appel individuel.....	260	Composition surnuméraire en direct en cours d'appel téléphonique individuel sortant..	268
Faire un appel général de site.....	261	Fonctions avancées en mode Connect Plus...	268
Appel multigroupe.....	261	Rappel du canal d'accueil.....	269
Appel individuel fait à l'aide du bouton de composition à une touche.....	262	Plan de secours automatique.....	269
Passer un appel au moyen de la touche programmable de composition manuelle.....	263		













Indications de mode de reprise d'appel automatique.....	269	Modifier l'ordre de priorité d'un groupe d'appels.....	282
Recevoir et passer des appels en mode de reprise.....	270	Réglages des contacts.....	284
Retour au fonctionnement normal.....	271	Passer un appel individuel à partir des contacts.....	284
Vérification de la radio.....	271	Faire un appel à l'aide de la recherche d'alias.....	285
Envoyer une vérification radio....	272	Ajout d'un nouveau contact.....	286
Écoute à distance.....	273	Réglages de l'indicateur d'appel.....	287
Lancer la fonction Écoute ambiance.....	273	Activer ou désactiver les sonneries d'appel des avertissements d'appel.....	287
Balayage.....	275	Activer et désactiver les sonneries d'appel des appels individuels.....	288
Démarrer et arrêter le balayage.	275	Activer et désactiver les sonneries d'appel des messages texte.....	288
Répondre à une transmission pendant un balayage.....	276	Sélection d'un type de sonnerie d'avertissement.....	289
Balayage configurable par l'utilisateur..	276	Augmenter le volume de la tonalité d'alarme.....	290
Activer ou désactiver le balayage.....	277	Journal des appels.....	290
Modifier la liste de balayage.....	278	Affichage des derniers appels....	290
Ajouter ou supprimer un groupe à partir du menu Ajouter membre.....	279		
Comprendre la fonction de balayage....	281		
Réponse de balayage.....	282		















Supprimer un appel d'une liste d'appels.....	291	Supprimer les détails de l'urgence.....	299
Afficher les détails d'une liste d'appels.....	291	Réponse à un appel d'urgence..	299
Fonction Avertissement d'appel.....	292	Répondre à une alerte d'urgence.....	300
Réponse à un avertissement d'appel.....	292	Ignorer Appel d'annulation d'urgence.....	300
Envoyer un avertissement d'appel à partir de la liste des contacts.....	293	Initiation d'un appel d'urgence...	301
Envoyer un avertissement d'appel au moyen de la touche d'accès direct.....	294	Lancement d'un appel d'urgence suivi d'un appel vocal.....	301
Mode Muet.....	294	Lancement d'une alerte d'urgence.....	302
Activation du mode muet.....	294	Quitter le mode d'urgence.....	302
Réglage de la minuterie du mode muet.....	295	Messagerie texte.....	303
Quitter le mode muet.....	295	Envoyer un message texte rapide.....	303
Fonctionnement d'urgence.....	296	Envoyer un message texte rapide au moyen de la touche d'accès direct.....	304
Recevoir un appel d'urgence entrant.....	298	Accès au dossier Brouillons.....	305
Enregistrement des détails de l'urgence dans la liste des alarmes.....	298	Afficher un message texte enregistré.....	305

Modifier et envoyer un message texte enregistré	306	Afficher un message texte à partir de la boîte de réception.....	313
Supprimer un message texte enregistré dans les brouillons.....	307	Répondre à un message texte à partir de la boîte de réception.....	314
Gérer les échecs d'envoi de message texte.....	308	Supprimer un message texte de la boîte de réception.....	315
Renvoyer un message texte.....	308	Suppression de tous les messages texte de la boîte de réception.....	316
Transférer un message texte.....	308	Cryptage.....	317
Gestion de messages texte envoyés.....	309	Faire un appel crypté.....	318
Affichage d'un message texte envoyé.....	309	Sécurité.....	319
Envoi d'un message texte envoyé.....	310	Désactiver la radio.....	319
Supprimer tous les messages envoyés du dossier des messages envoyés.....	311	Activer la radio.....	321
Recevoir un message texte.....	312	Bluetooth.....	323
Lire un message texte.....	312	Activer ou désactiver Bluetooth.	324
Gérer les messages texte reçus	313	Détecter un dispositif Bluetooth et établir la connexion.....	325
		Détecter un dispositif Bluetooth et établir la connexion (Mode détection).....	326







Se déconnecter d'un dispositif Bluetooth.....	326	Connexion à un point d'accès réseau.....	333
Changer l'acheminement du signal audio entre le haut-parleur interne de la radio et le dispositif Bluetooth.....	327	Vérification de l'état de la connexion Wi-Fi.....	335
Affichage de renseignements détaillés sur les appareils.....	327	Actualisation de la liste de réseaux.....	335
Supprimer le nom d'un dispositif	328	Ajout d'un réseau.....	336
Gain du micro Bluetooth.....	328	Affichage des détails de points d'accès réseau.....	337
Localisation interne.....	329	Retrait de points d'accès réseau	338
Activation ou désactivation de la fonction Positionnement à l'intérieur.....	329	Utilitaires.....	338
Accès aux données sur l'emplacement des balises de positionnement à l'intérieur.....	331	Activer ou désactiver les tonalités et les avertissements de la radio.....	339
Liste de notifications.....	331	Régler l'écart de volume des tonalités d'avertissement.....	339
Accéder à la liste de notifications.....	332	Activer ou désactiver la tonalité d'autorisation de parler.....	340
Fonctionnement Wi-Fi.....	332	Activer ou désactiver la tonalité d'alerte de mise sous tension.....	341
Activer ou désactiver la fonction Wi-Fi.....	333	Régler le niveau de puissance...	342
		Changer le mode d'affichage.....	342
		Régler la luminosité de l'écran...	343









Activer ou désactiver l'écran d'introduction.....	344	Vérifier l'index de numéro de modèle de la radio.....	354
Language.....	344	Vérification fichier de codeplug de carte d'option OTA CRC.....	354
Activer ou désactiver le voyant DEL.....	345	Affichage de l'ID du site (numéro du site).....	355
Déterminer le type de câble.....	346	Vérification de l'info du site.....	355
Annonce vocale.....	346	Vérifier l'ID de la radio.....	356
Délai de menu.....	347	Vérifier les versions du micrologiciel et de la fiche de code.....	357
Activation ou désactivation de l'avertisseur / des phares.....	347	Recherche des mises à jour.....	357
Régler les préférences d'utilisation du sélecteur double.	348	Affichage des détails du certificat Wi-Fi d'entreprise.....	366
Contrôle de gain automatique de microphone numérique (Mic. CGA-D).....	349	Section III: Autres systèmes.....	367
Audio intelligent.....	349	Bouton PTT.....	367
Activer ou désactiver la fonction de suppression des réactions acoustiques.....	351	Touches programmables.....	367
Activation ou désactivation du GNSS.....	352	Fonctions attribuables de la radio.....	368
Accès aux renseignements généraux sur la radio.....	353	Réglages ou fonctions attribuables.....	371
		Accès aux fonctions programmées.....	371





Indicateurs d'état.....	372		
Icônes.....	372		
Voyants DEL.....	379		
Tonalités.....	380		
Tonalités d'avertissement.....	380		
Tonalités audio.....	380		
Mode analogique ou numérique classique.....	381		
Information relative aux icônes.....	381		
Sites IP interconnectés 	382		
Capacity Plus – site unique 	383		
Capacity Plus – multisite 	383		
Sélection des zones et des canaux.....	384		
Sélection des zones.....	384		
Sélection des zones à l'aide de la recherche d'alias.....	385		
Sélection des canaux.....	385		
Appels.....	386		
Appels de groupe.....	387		
Appels de groupe.....	387		
Appels de groupe faits à l'aide de la liste de contacts.....	388		
			Appels de groupe faits à l'aide de la touche numérique programmable  
			389
			Réponse à un appel de groupe..
			389
		Appels privés 
			390
		Exécution d'un appel individuel 
			391
		Appels privés faits à l'aide de la liste de contacts 
			392
		Appels individuels faits à l'aide de la numérotation manuelle 
			393
		Appels individuels faits à l'aide de la touche numérique programmable  
			394
		Réponse à des appels individuels 
			395
		Appels généraux.....	395
		Réception d'un appel général....	395
		Appel général.....	396
		Appels généraux faits à l'aide de la touche numérique programmable 
			397









Appels sélectifs 	398	Réponse à un appel téléphonique en mode appel général 	410
Exécution d'un appel sélectif.....	398	Réponse à un appel téléphonique en mode Appel individuel 	410
Réponse à un appel sélectif 	398	Interruption d'un appel radio 	411
Appels téléphoniques 	399	Mode Direct.....	412
Exécution d'un appel téléphonique 	400	Basculement entre les modes Répéteur et Direct.....	412
Appels téléphoniques faits à l'aide de la liste de contacts 	401	Fonctions avancées.....	413
Appels téléphoniques faits à l'aide de la numérotation manuelle 	404	Rappel du canal d'accueil.....	413
Pour passer des appels de groupe, individuels, téléphoniques ou généraux à l'aide de la recherche d'alias 	406	Mettre en sourdine le rappel du canal d'accueil.....	413
Multifréquence à deux tonalités.	408	Réglage de nouveaux canaux d'accueil.....	413
Exécution d'un appel DTMF.....	409	Vérification de la radio 	414
Réponse à un appel téléphonique en mode appel de groupe 	409	Envoi des vérifications radio 	414
		Envoi des vérifications radio à l'aide de la numérotation manuelle 	415
		Écoute à distance.....	416



Lancer la fonction Écoute ambiance.....	416	Activer ou désactiver le balayage.....	426
Activation de l'Écoute ambiance à l'aide de la liste de contacts ...	417	Réponse à une transmission pendant un balayage.....	426
Activation de l'écoute à distance à l'aide de la numérotation manuelle 📞	418	Suppression des canaux nuisibles.....	427
Listes de balayage.....	419	Restauration des canaux nuisibles.....	427
Affichage d'une entrée de la liste de balayage.....	420	Balayage par vote : 🗳️	428
Affichage des entrées de la liste de balayage à l'aide de la recherche d'alias	420	Réglages des contacts.....	428
Ajout d'entrées à la liste de balayage.....	421	Appels de groupe faits à l'aide de la liste de contacts.....	429
Ajout d'entrées à la liste de balayage à l'aide de la recherche d'alias 📞	422	Appels privés faits à l'aide de la liste de contacts📞	430
Suppression d'une entrée de la liste de balayage.....	423	Association d'une entrée à une touche numérique programmable 📞	431
Configuration de l'ordre de priorité des entrées de la liste de balayage.....	424	Dissociation d'une entrée et de la touche numérique programmable 📞	432
Balayage.....	425	Ajout d'un nouveau contact.....	433
		Configuration du contact par défaut 🗳️	433

Réglages de l'indicateur d'appel.....	434	Afficher les détails de la liste d'appel 	441
Activation ou désactivation des sonneries d'appel des avertissements d'appel.....	434	Stockage des alias ou des ID de la liste d'appels 	442
Activation ou désactivation des sonneries d'appel des appels privés 	435	Fonction Avertissement d'appel.....	443
Activation ou désactivation des sonneries d'appel des appels sélectifs 	436	Exécution d'une alerte d'appel...	443
Activation ou désactivation des sonneries d'appel des messages textes 	437	Avis d'appels faits à l'aide de la liste de contacts.....	443
Activer ou désactiver les sonneries d'appel des états de télémétrie avec message texte..	438	Avis d'appel fait à l'aide de la numérotation manuelle.....	444
Attribuer des styles de sonneries.....	438	Réponse à un avertissement d'appel.....	445
Augmenter le volume de la tonalité d'alarme.....	439	Mode Muet.....	445
Fonctions du Journal des appels.....	440	Activation du mode muet.....	446
Affichage des derniers appels....	440	Réglage de la minuterie du mode muet.....	446
Suppression des appels de la liste d'appel 	440	Quitter le mode muet.....	447
		Fonctionnement d'urgence.....	447
		Réception d'une alarme d'urgence.....	448
		Réponse à une alarme d'urgence.....	449

Sortie du mode d'urgence après réception de l'alarme d'urgence.....	450	Réponse à des messages texte par un texte rapide 	458
Envoi des alarmes d'urgence.....	450	Renvoi des messages texte.....	460
Envoi d'une alarme d'urgence avec un appel.....	451	Transfère des messages texte 	460
Alarmes d'urgence suivies d'un appel vocal.....	453	Transfère des messages texte à l'aide de la numérotation manuelle 	461
Envoi d'une alarme d'urgence suivie d'un appel vocal 	454	Modification de messages texte.....	462
Réactivation du mode d'urgence.....	454	Rédaction de messages texte.....	463
Quitter le mode d'urgence après l'envoi de l'alarme d'urgence.....	455	Envoi de messages texte	463
Supprimez l'alarme de la liste d'alarmes.....	455	Suppression des messages texte de la boîte de réception.....	464
Messagerie texte.....	456	Suppression de tous les messages texte de la boîte de réception 	465
Messages texte 	456	Messages texte envoyés 	466
Affichage des messages texte.....	456		
Afficher des messages texte d'état de télémétrie.	457		
Réponse à des messages texte 	458		

Affichage des messages texte envoyés 	467	Envoi de messages texte rapides 	472
Envoi de messages texte envoyés 	467	Configuration de saisie de texte.....	473
Suppression d'un message texte envoyé à partir du dossier messages envoyés 	468	Activation ou désactivation du mot correct.....	473
Suppression de tous les messages texte envoyés du dossier messages envoyés.....	469	Activation ou désactivation de la prédiction du texte.....	474
Messages texte enregistrés.....	469	Majuscule en début de phrase...	475
Affichage de messages texte enregistrés.....	470	Afficher des mots personnalisés	476
Modification de messages texte enregistrés.....	470	Modifier des mots personnalisés	476
Suppression de messages texte enregistrés du dossier brouillons.....	471	Ajouter des mots personnalisés.	478
Message texte rapide 	472	Supprimer un mot personnalisé.	479
		Supprimer tous les mots personnalisés.....	480
		Tickets de tâche.....	481
		Accès au dossier Tickets de tâche.....	482
		Connexion ou déconnexion du serveur distant.....	482
		Création de tickets de tâche.....	483
		Répondre à des tickets de tâche	483

Envoi de tickets de tâche en utilisant un modèle de ticket de tâche.....	484	Désactivation des radios à l'aide de la numérotation manuelle 	492
Envoi de tickets de tâche en utilisant plus d'un modèle de ticket de tâche.....	485	Activation des radios 	493
Suppression de tickets de tâche	486	Activation des radios à l'aide de la liste de contacts 	494
Supprimer tous les tickets de tâche.....	487	Activation des radios à l'aide de la numérotation manuelle 	494
Cryptage 	487	Travailleur solitaire.....	495
Activer ou désactiver le cryptage 	488	Bluetooth.....	496
Réglages multisite.....	489	Activer ou désactiver Bluetooth.	497
Lancer une recherche de site manuelle.....	489	Connexion aux dispositifs Bluetooth.....	497
Verrouillage de site activé/désactivé.....	490	Connexion aux dispositifs Bluetooth en mode Détection.....	499
Accès à la liste de sites voisins..	490	Déconnexion de dispositifs Bluetooth.....	499
Sécurité 	490	Changer l'acheminement du signal audio entre le haut-parleur interne de la radio et le dispositif Bluetooth.....	500
Désactivation des radios 	491	Affichage de renseignements détaillés sur les appareils.....	500
Désactivation des radios à l'aide de la liste de contacts 	491	Supprimer le nom d'un dispositif	501

Gain du micro Bluetooth.....	501	Activation/désactivation du verrouillage par mot de passe....	509
Localisation interne.....	502	Changement de mot de passe...510	
Activation ou désactivation de la fonction Positionnement à l'intérieur.....	502	Configuration du panneau avant.....	511
Accès aux données sur l'emplacement des balises de positionnement à l'intérieur.....	504	Entrée dans la Mode de configuration du panneau avant.	511
Liste de notifications.....	504	Modifier les paramètres de mode FPC	512
Accès à liste de notification.....	505	Fonctionnement Wi-Fi.....	512
Système ARTS 	505	Activer ou désactiver la fonction Wi-Fi.....	513
Programmation par onde radio 	506	Connexion à un point d'accès réseau.....	514
Sélection de modes de connexion de périphériques tiers.....	507	Vérification de l'état de la connexion Wi-Fi.....	515
Indicateur d'intensité du signal reçu.....	507	Actualisation de la liste de réseaux.....	515
Affichage des valeurs RSSI (indicateur d'intensité de réception du signal).....	507	Ajout d'un réseau.....	516
Fonctions de verrouillage par mot de passe.....	508	Affichage des détails de points d'accès réseau.....	517
Accès aux radios à l'aide des mots de passe.....	508	Retrait de points d'accès réseau	518
Déverrouillage de la radio.....	509	Utilitaires.....	519
		Niveau de silencieux.....	519

Configuration du niveau du silencieux.....	519	Activer et désactiver le système de diffusion publique.....	529
Niveaux de puissance.....	520	Activer et désactiver le système de diffusion publique externe.....	530
Configuration de la puissance....	520	Activer ou désactiver l'écran d'introduction.....	530
Activation ou désactivation des sonneries et alertes de la radio.....	521	Sélection de la langue.....	531
Activer ou désactiver les tonalités du clavier.....	522	Déterminer le type de câble.....	532
Configuration de la compensation de volume des sonneries et des alertes....	523	Transmission vocale.....	532
Activation ou désactivation de la tonalité d'autorisation de parler.....	524	Activation ou désactivation de l'émission commandée par la voix (VOX).....	533
Activation et désactivation de la tonalité de mise sous tension.....	525	Activation ou désactivation de l'assistance parlée.....	534
Configuration des sonneries d'avis de messages texte.....	525	Activation ou désactivation de la carte d'option.....	534
Changement des modes d'affichage....	526	Synthèse texte-parole.....	534
Configuration de la luminosité de l'affichage.....	527	Réglage de la synthèse texte-parole.....	535
Activation ou désactivation de l'avertisseur / des phares.....	528	Activer ou désactiver le renvoi d'appel automatique.....	536
Activation ou désactivation des voyants DEL.....	528	Réglage du délai menu.....	536

Activation ou désactivation du microphone analogique.....	537	Vérification de l'alias et l'ID de la radio.....	545
Activation ou désactivation du microphone numérique.....	538	Vérification des versions du micrologiciel et de la codeplug... 546	
Activation ou désactivation de la fonction Audio intelligent.....	538	Vérification des informations de mise à jour du logiciel.....	546
Activer ou désactiver la fonction de suppression des réactions acoustiques	539	Consulter les informations du GNSS.....	547
Activer ou désactiver l'amélioration de la vibration.....	540	Affichage de l'information sur le site.....	548
Ambiance audio.....	541	Affichage des détails du certificat Wi-Fi d'entreprise.....	548
Configuration de l'ambiance audio.....	541	Section IV: Liste des accessoires approuvés.....	550
Profils audio.....	542	Utilisation de la radio maritime dans la gamme de fréquence VHF.....	556
Configuration des profils audio..	542	Assignations des canaux spéciaux.....	556
Activer et désactiver le système de système satellite de navigation mondial.....	543	Canal d'urgence.....	556
Liste de réception flexible 	544	Canal d'appel non commercial.....	557
Activer ou désactiver la liste de réception flexible.....	544	Exigences relatives à la fréquence de fonctionnement.....	557
Renseignements généraux sur la radio	545	Déclaration de conformité pour utilisation des fréquences de détresse et de sécurité.....	559

Paramètres techniques d'interface avec des sources de données externes.....	559
Garantie limitée.....	561
PRODUITS DE COMMUNICATIONS MOTOROLA SOLUTIONS.....	561
I. PROTECTION ASSURÉE PAR LA PRÉSENTE GARANTIE ET DURÉE DE CELLE-CI :.....	561
II. CONDITIONS GÉNÉRALES.....	562
III. DROITS PRÉVUS PAR LES LOIS PROVINCIALES :.....	562
IV. ENTRETIEN COUVERT PAR LA GARANTIE.....	563
V. CE QUI N'EST PAS COUVERT PAR CETTE GARANTIE.....	563
VI. DISPOSITIONS RELATIVES AUX BREVETS ET AUX LOGICIELS.....	564
VII. LOI APPLICABLE.....	565

Consignes de sécurité importantes

Radios bidirectionnelles mobiles : exposition aux radiofréquences et sécurité du produit

ATTENTION!

Cette radio ne doit être utilisée qu'à des fins professionnelles. Avant d'utiliser la radio, lisez le guide Radios bidirectionnelles portatives : exposition aux radiofréquences et sécurité du produit, qui contient d'importantes instructions de fonctionnement pour une utilisation sécuritaire et des informations sur l'exposition aux fréquences radioélectriques, dans le but d'assurer votre conformité aux normes et règlements en vigueur.

Visitez le site Web suivant pour obtenir la liste des antennes et autres accessoires approuvés par Motorola Solutions :

<http://www.motorolasolutions.com>

Toute modification effectuée à cet appareil sans l'autorisation explicite de Motorola Solutions peut annuler l'autorisation d'utiliser cet appareil.

Selon la réglementation d'Industrie Canada, cet émetteur radio ne peut être utilisé qu'avec une antenne dont le type et le gain maximal (ou minimal) sont approuvés par Industrie Canada pour cet émetteur. Afin de limiter les interférences radio pour les autres utilisateurs, le type et le gain de l'antenne doivent être choisis de façon à ce que la puissance isotrope rayonnée équivalente (P.I.R.E.) ne soit pas plus forte qu'il ne le faut pour établir la communication.

Cet émetteur radio a été approuvé par Industrie Canada pour utilisation avec une antenne approuvée par Motorola Solutions offrant le gain maximal autorisé et l'impédance requise pour le type d'antenne indiqué. Il est strictement interdit d'utiliser avec cet appareil tout type d'antenne ne figurant pas dans cette liste et présentant un gain supérieur au maximum indiqué pour le type.

Avis aux utilisateurs (FCC et Industrie Canada)

Le présent appareil est conforme aux CNR d'Industrie Canada applicables aux appareils radio exempts de licence et à la partie 15 des règlements de la FCC :

- Cet appareil ne doit pas causer d'interférence nuisible.
- Cet appareil doit accepter toute interférence reçue, y compris les interférences pouvant entraîner un fonctionnement indésirable.
- Toute modification effectuée à cet appareil sans l'autorisation explicite de Motorola Solutions peut annuler l'autorisation d'utiliser cet appareil.

Version logicielle

Toutes les fonctions décrites dans les sections suivantes sont prises en charge par les versions logicielles

R02.09.00.0000 ou ultérieures.

Reportez-vous à [Vérification des versions du micrologiciel et de la codeplug à la page 237](#) pour déterminer la version logicielle de votre radio.

Pour obtenir des renseignements supplémentaires, adressez-vous à votre détaillant ou à votre administrateur de système.

Droits d'auteur

Les produits de Motorola Solutions décrits dans ce document peuvent inclure des programmes informatiques protégés par des droits d'auteur de Motorola Solutions. Les lois des États-Unis et d'autres pays réservent à Motorola Solutions certains droits exclusifs pour les programmes informatiques protégés par droits d'auteur. Par conséquent, tout programme informatique protégé par droits d'auteur de Motorola Solutions compris dans les produits Motorola Solutions décrits dans le présent document ne peut être copié ni reproduit de quelque manière que ce soit sans l'autorisation écrite expresse de Motorola Solutions.

© Motorola Solutions, Inc., 2018. Tous droits réservés

Aucune partie du présent document ne peut être reproduite, transmise, stockée dans un système de recherche documentaire ou traduite dans une autre langue ou dans un langage informatique, sous quelque forme ou par quelque moyen que ce soit, sans l'autorisation écrite préalable de Motorola Solutions, Inc.

De plus, l'achat de produits Motorola ne peut être considéré comme une transaction octroyant directement, par inférence, estoppel ou autrement une licence en vertu des droits d'auteur, des droits de brevets ou d'une demande de brevet de Motorola Solutions, à l'exception

d'une licence d'utilisation normale et non exclusive, libre de toute redevance, prévue par la loi lors de la vente d'un produit.

Avis de non-responsabilité

Veillez noter que certaines fonctionnalités, installations et capacités décrites dans ce document pourraient ne pas s'appliquer ou être accordées sous licence pour l'utilisation sur un système particulier, ou pourraient dépendre des caractéristiques d'une unité mobile d'abonné ou d'une configuration de certains paramètres. Veuillez consulter votre personne-ressource chez Motorola Solutions pour en savoir plus.

Marques de commerce

MOTOROLA, MOTO, MOTOROLA SOLUTIONS et le logo au M stylisé sont des marques de commerce ou des marques déposées de Motorola Trademark Holdings LLC et sont utilisées sous licence. Toutes les autres marques de commerce sont la propriété de leurs titulaires respectifs.

Directive sur la mise au rebut des équipements électriques et électroniques de l'Union européenne (UE) (WEEE)



■ La directive WEEE de l'Union européenne exige que les produits vendus dans les pays de l'UE portent l'étiquette de la poubelle barrée (ou leur emballage, dans certains cas).

Comme le définit la directive WEEE, cette étiquette de poubelle barrée signifie que les clients et les utilisateurs finaux dans les pays de l'UE ne doivent pas jeter les équipements électriques et électroniques ou leurs accessoires dans les ordures domestiques.

Les clients ou les utilisateurs finaux dans les pays de l'UE doivent communiquer avec le représentant ou le centre de service de leur fournisseur d'équipement pour obtenir des renseignements sur le système de collecte des déchets de leur pays.

Droits d'auteur du logiciel

Les produits Motorola Solutions décrits dans ce manuel peuvent inclure des logiciels Motorola Solutions protégés en vertu de la loi sur le droit d'auteur enregistrés dans des mémoires à semi-conducteurs ou dans d'autres supports. Les lois du Canada, des États-Unis et d'autres pays protègent, au nom de Motorola Solutions, certains droits exclusifs visant les logiciels, notamment les droits exclusifs de copie et de reproduction sous toute forme que ce soit des logiciels protégés par la loi sur le droit d'auteur. Par conséquent, la loi sur le droit d'auteur protégeant tous les logiciels de Motorola Solutions inclus avec les produits de Motorola Solutions décrits dans ce manuel interdit toute copie, reproduction, modification, ingénierie à rebours ou distribution de ces logiciels sans l'autorisation écrite expresse de Motorola Solutions. De plus, l'achat de produits Motorola Solutions ne peut être considéré comme une transaction octroyant directement, par inférence, estoppel ou autrement une licence en vertu des droits d'auteur, des droits de brevets ou d'une demande de brevet de Motorola Solutions, à l'exception d'une licence d'utilisation normale et non exclusive prévue par la loi lors de la vente d'un produit.

La technologie de codage vocal AMBE+2™ incluse dans ce produit est protégée par les droits de propriété

intellectuelle, notamment les droits de brevet, les droits d'auteur et les secrets industriels de Digital Voice Systems, Inc.

Cette technologie de codage vocal n'est concédée sous licence que pour une utilisation avec cet équipement de télécommunication. Il est explicitement interdit à tout utilisateur de cette technologie de tenter de décompiler, de faire l'ingénierie à rebours ou de désassembler le code exécutable, ou encore de convertir de toute autre manière le code exécutable dans un format lisible par l'utilisateur.

Brevets des États-Unis n° 5,870,405, n° 5,826,222, n° 5,754,974, n° 5,701,390, n° 5,715,365, n° 5,649,050, n° 5,630,011, n° 5,581,656, n° 5,517,511, n° 5,491,772, n° 5,247,579, n° 5,226,084 et n° 5,195,166.

Précautions de manipulation

La radio numérique portable de série MOTOTRBO répond aux normes IP67. Elle peut ainsi résister aux conditions difficiles sur le terrain, par exemple le fait d'être plongée dans l'eau. Cette section décrit certaines précautions de base à prendre.



MISE EN GARDE:

Ne désassemblez pas votre radio. Cela pourrait endommager les joints de l'appareil et occasionner des chemins de fuite vers la radio. L'entretien de la radio devrait être effectué uniquement dans un centre de réparations équipé pour mettre à l'essai et replacer le joint sur l'appareil.

- Si la radio a été submergée, secouez-la afin d'évacuer l'eau susceptible d'être emprisonnée dans la grille du haut-parleur et le port du microphone. L'eau ainsi emprisonnée risque d'entraîner une réduction de la qualité audio.
- Si la zone de contact de la batterie de la radio est exposée à l'eau, nettoyez et séchez les contacts de la radio et de la batterie avant de connecter cette dernière à l'appareil. L'eau résiduelle pourrait court-circuiter la radio.
- Si la radio a été plongée dans un liquide corrosif (par exemple de l'eau salée), rincez la radio et la batterie à l'eau douce, puis séchez-les.
- Pour nettoyer les surfaces extérieures de la radio, utilisez une solution diluée d'eau et de détergent liquide pour vaisselle (p. ex. une cuillerée à thé de détergent dans environ quatre litres d'eau).
- N'enfoncez rien dans l'ouverture située sur le châssis de la radio, sous le contact de la batterie. Cette ouverture permet d'équilibrer la pression dans la radio. Le fait d'enfoncer un objet dans cette ouverture risque de provoquer des infiltrations d'eau dans la radio, qui ne serait alors plus submersible.
- N'obstruez jamais ou ne couvrez jamais cette ouverture, même avec une étiquette.
- Assurez-vous qu'aucune substance huileuse n'entre en contact avec cette ouverture.
- La radio, dont l'antenne est correctement rattachée, est conçue pour être submersible à une profondeur maximale de un mètre (3,28 pieds), pendant une durée maximale de 30 minutes. Une utilisation excessive, supérieure à la limite maximale, ou sans antenne pourrait endommager la radio.

- Lorsque vous nettoyez la radio, n'utilisez pas de jet à haute pression, car la pression de l'eau serait alors supérieure à la pression correspondant à une profondeur de un mètre et l'eau risquerait de s'infiltrer dans la radio.

Opérations de base

Ce chapitre décrit les opérations de base vous permettant d'utiliser votre radio.

Mise en marche de la radio

Suivez la procédure suivante pour mettre votre radio sous tension.

Appuyez sur la touche **Marche/Arrêt**.

En cas de réussite :

- Une tonalité se fait entendre.
- Le voyant DEL vert s'allume.
- L'écran affiche MOTOTRBO (TM), suivi d'une image ou d'un message de bienvenue.
- L'écran d'accueil s'allume.

Si la fonction Tonalités/alertes est désactivée, il n'y a aucune tonalité lors de la mise sous tension.

Vérifiez auprès de votre détaillant si la radio ne s'allume pas. Assurez-vous que la batterie est chargée et

correctement insérée. Contactez votre détaillant si la radio ne s'allume toujours pas.

Éteindre la radio

Suivez la procédure suivante pour éteindre votre radio.

Maintenez le bouton **Marche/Arrêt** enfoncé.

Il peut s'écouler jusqu'à 7 secondes avant que votre radio soit complètement éteinte.

L'écran affiche Mise hors tension.

Réglage du volume

Suivez la procédure suivante pour modifier le niveau de puissance de la radio.

Faites un des suivants :

- Tournez le bouton **Marche/Arrêt/Volume** dans le sens horaire pour augmenter le volume.
- Tournez le bouton **Marche/Arrêt/Volume** dans le sens anti-horaire pour diminuer le volume.

**AVIS:**

Vous pouvez programmer un écart de volume minimal afin d'empêcher le réglage du volume à un niveau plus faible que le niveau minimum programmé. Pour obtenir des renseignements supplémentaires, adressez-vous à votre détaillant ou à votre administrateur de système.

Commandes de la radio

Ce chapitre décrit les touches de commande et les fonctions de la radio.

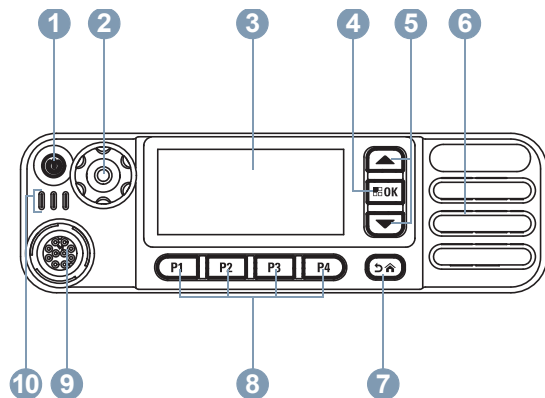

- 1 Bouton Marche/Arrêt/Information
- 2 Bouton Volume/Canal
- 3 Affichage
- 4 Touche Menu/OK
- 5 Boutons de défilement haut/bas
- 6 Haut-parleur



- 7 Bouton Retour/Accueil
- 8 Boutons programmables du panneau avant
- 9 Connecteur accessoire
- 10 Voyants DEL

Bouton Volume/Canal

Le **bouton Volume/Canal** peut être programmé comme un bouton à double fonction pour le volume et le canal, ou comme commande de volume seulement.

Pour régler le volume, consultez la section [Réglage du volume à la page 40](#).



Pour changer les canaux, appuyez et maintenez le **bouton Volume/Canal** jusqu'à ce que l'état de sélection de canal s'affiche. Tournez le **bouton Volume/Canal** pour sélectionner le canal. Effectuez l'une des opérations suivantes pour quitter le mode de sélection de canal :



- Appuyez sur le **bouton Volume/Canal**.
- Appuyez sur .
- Appuyez sur .
- Attendez que la minuterie du menu arrive à son terme.

Régler les préférences d'utilisation du sélecteur double

Suivez la procédure suivante pour configurer les préférences d'utilisation du sélecteur double de la radio.



- 1 Appuyez sur  pour accéder au menu.



- 2 Appuyez sur  ou  jusqu'à Utilitaires. Appuyez sur  pour effectuer la sélection.

- 3 Appuyez sur  ou  jusqu'au Paramètres de la radio. Appuyez sur  pour effectuer la sélection.

Touches du microphone à clavier









Le clavier alphanumérique 3 x 4 (7,6 sur 10,2 cm) du microphone à clavier à navigation multidirectionnelle (numéro de pièce Motorola Solutions RMN5127_) vous permet d'accéder aux fonctions de la radio. Appuyez plusieurs fois sur la

- 4 Appuyez sur  ou  jusqu'à Double sélect. Appuyez sur  pour effectuer la sélection. L'écran affiche Volume uniq. et Volume & canal.

- 5 Appuyez sur  ou  jusqu'au profil voulu. Appuyez sur  pour effectuer la sélection. L'icône ✓ s'affiche à côté des réglages sélectionnés. L'écran revient au menu précédent.

même touche pour entrer certains caractères. Le tableau indique le nombre de pressions requises pour la saisie du caractère voulu.

Touche	Nombre de pressions sur la touche												
	1	2	3	4	5	6	7	8	9	10	11	12	13
1 .,?	1	.	,	?	!	@	&	'	%	—	:	*	#
2 ABC	A	B	C	2									
DEF 3	D	E	F	3									
4 GHI	G	H	I	4									
5 JKL	J	K	L	5									
MNO 6	M	N	O	6									

Touche	Nombre de pressions sur la touche												
	1	2	3	4	5	6	7	8	9	10	11	12	13
 7 PARS	P	Q	R	S	7								
 8 TUV	T	U	V	8									
 WXYZ 9	W	X	Y	Z	9								
 0	0		AVIS: Appuyez sur cette touche une fois pour entrer « 0 » et maintenez-la enfoncée pour activer le verrouillage des majuscules. Pour désactiver le verrouillage des majuscules, maintenez-la enfoncée de nouveau.										
 * ou del	* ou del		AVIS: Pour supprimer un caractère entré, appuyez sur cette touche pendant la saisie du texte. Pour entrer « * », appuyez sur cette touche en mode de saisie numérique.										
 # ou espace	# ou espace		AVIS: Pour insérer une espace, appuyez sur cette touche pendant la saisie de texte. Pour entrer « # », appuyez sur cette touche en mode de saisie numérique.										

WAVE

L'environnement de voix à réseau étendu (Wide Area Voice Environment [WAVE™]) fournit une nouvelle méthode de faire des appels entre deux radios.

Cette fonction prend également en charge les appels entre les radios et d'autres dispositifs avec les capacités WAVE. Toutefois, un canal WAVE doit être configuré pour utiliser cette fonction.

Lorsque dans un canal WAVE, la radio est incapable de recevoir des appels à partir d'autres systèmes et ne peut recevoir des appels WAVE.

Si la radio est sur un canal WAVE, la radio permet la connexion Wi-Fi et se déroule automatiquement pour vous connecter au serveur WAVE. Les appels WAVE sont effectués lorsque la radio est connectée à un réseau IP par Wi-Fi.





AVIS:

Cette fonction s'applique aux modèles XPR 5550e/XPR 5580e uniquement.

Tableau 1: Icônes d'affichage WAVE



Les icônes suivantes apparaissent momentanément sur l'écran lorsque le mode WAVE est activé.



	WAVE connecté WAVE est connecté.
	WAVE déconnecté WAVE est déconnecté.

Régler le canal actif WAVE

Les canaux WAVE sont configurés par le CPS. Suivez la procédure suivante pour sélectionner le canal WAVE .

- 1 Appuyez sur  pour accéder au menu.

- 2 Appuyez sur  ou  jusqu'à `Canaux WAVE`. Appuyez sur  pour effectuer la sélection.

- 3 Appuyez sur  ou  jusqu'au canal WAVE voulu. Appuyez sur  pour effectuer la sélection.



- 4 Appuyez sur  ou  jusqu'à Régler comme actif. Appuyez sur  pour effectuer la sélection.

L'écran affiche  à côté du canal sélectionné.



Afficher l'information de canal WAVE

Suivez la procédure suivante pour afficher l'information de canal WAVE.

- Faites un des suivants :
 - Appuyez sur la touche programmée **Liste de canaux WAVE**. Ignorez les étapes suivantes.
 - Appuyez sur  pour accéder au menu.

- Appuyez sur  ou  jusqu'à Canaux WAVE. Appuyez sur  pour effectuer la sélection.

- 3 Appuyez sur  ou  jusqu'au canal WAVE voulu. Appuyez sur  pour effectuer la sélection.



- 4 Appuyez sur  ou  jusqu'à Afficher les détails. Appuyez sur  pour effectuer la sélection.



L'écran affiche les détails du canal WAVE.

Afficher l'information de points d'extrémité WAVE

Suivez la procédure suivante pour afficher l'information des points d'extrémité WAVE.

- Faites un des suivants :
 - Appuyez sur la touche programmée **Contact**. Passez à [étape 3](#).
 - Appuyez sur  pour accéder au menu.

2 Appuyez sur  ou  jusqu'à Points d'extrémité. Appuyez sur  pour effectuer la sélection.

3 Appuyez sur  ou  jusqu'au point d'extrémité WAVE voulu. Appuyez sur  pour effectuer la sélection.



4 Appuyez sur  pour sélectionner Afficher les détails.



L'écran affiche les détails du point d'extrémité WAVE.



Changer la configuration WAVE



Suivez la procédure suivante pour configurer l'adresse IP du serveur, l'ID utilisateur et le mot de passe du serveur WAVE.



1 Appuyez sur  pour accéder au menu.



2 Appuyez sur  ou  jusqu'à Utilitaires. Appuyez sur  pour effectuer la sélection.



3 Appuyez sur  ou  jusqu'au Paramètres de la radio. Appuyez sur  pour effectuer la sélection.

4 Appuyez sur  ou  jusqu'à WAVE. Appuyez sur  pour effectuer la sélection.

5 Appuyez sur  pour sélectionner Adresse du serveur. Appuyez sur  pour changer l'adresse du serveur. Appuyez sur  pour effectuer la sélection.

6 Appuyez sur  pour un ID utilisateur. Appuyez sur  pour changer l'ID d'utilisateur. Appuyez sur  pour effectuer la sélection.

7 Appuyez sur  jusqu'au Mot de passe. Appuyez sur  pour afficher ou modifier le mot de passe WAVE. Appuyez sur  pour effectuer la sélection.

8 Appuyez sur  jusqu'à Appliquer. Appuyez sur  pour appliquer toutes les modifications apportées.

L'écran affiche un mini-avis positif avant de revenir momentanément à l'écran Paramètres de la radio.

Appels de groupe

Suivez la procédure suivante pour faire des appels de groupe à partir d'un canal WAVE.

1 Sélectionnez le canal WAVE qui correspond à l'alias ou à l'ID de groupe voulu.

2 Pour passer l'appel, appuyez sur le bouton de conversation **PTT**.

Le voyant DEL vert s'allume. L'icône **Appel de groupe** et l'alias s'affichent sur la première ligne de l'écran. L'alias du groupe WAVE s'affiche sur la deuxième ligne de l'écran.

3 Faites un des suivants :

- Attendez la fin de la tonalité d'autorisation de parler (si elle est activée) et parlez clairement dans le microphone.
 - Attendez la fin de l'effet local **PTT** (s'il est activé) et parlez clairement dans le microphone.
-

4 Relâchez le bouton **PTT** pour écouter.

Le voyant DEL vert s'allume lorsque la radio cible répond. L'écran affiche l'icône **Appel de groupe**, et l'alias ou l'ID ainsi que l'alias ou l'ID de la radio émettrice.

5 Si l'indicateur Canal libre est activé, une courte tonalité d'avertissement se fait entendre lorsque l'utilisateur de la radio émettrice cesse d'appuyer sur le bouton **PTT**, vous indiquant que le canal est libre

et que vous pouvez répondre. Pour prendre l'appel, appuyez sur le bouton **PTT**.

L'appel se termine lorsqu'il n'y a aucune activité vocale pendant une durée préprogrammée. La radio revient à l'écran affiché avant la tentative d'appel.

Opérations Capacity Max

Capacity Max est un système radio ADF basé sur des canaux. Les fonctions qui sont disponibles pour les utilisateurs radio en vertu de ce système sont disponibles dans le présent chapitre.

Bouton d'émission (PTT)

Le bouton **PTT** a deux fonctions principales.

- Le bouton **PTT** permet à la radio de transmettre un message aux autres radios pendant un appel. Lorsque vous appuyez sur le bouton **PTT**, le microphone se met sous tension.
- Lorsque vous n'êtes pas déjà en cours d'appel, vous pouvez vous servir du bouton **PTT** pour faire un nouvel appel.

Pour parler, maintenez le bouton **PTT** enfoncé. Relâchez le bouton **PTT** pour écouter.

Si la tonalité d'autorisation ou l'effet local **PTT** est activé, attendez la fin de la brève tonalité pour parler.

Si l'indicateur Canal libre est activé (programmé par le détaillant), une courte tonalité d'avertissement retentit lorsque l'utilisateur de la radio cible (la radio qui reçoit la

transmission) relâche le bouton **PTT**, vous indiquant que le canal est libre et que vous pouvez répondre.

La tonalité continue d'un signal d'interdiction se fait entendre si votre appel est interrompu, par exemple si la radio reçoit un appel d'urgence. Dans ce cas, relâchez le bouton **PTT**.

Touches programmables

Selon la durée pendant laquelle vous appuyez sur une touche, votre revendeur peut programmer les touches programmables pour en faire des raccourcis permettant d'accéder aux fonctions de la radio.

Appui bref

Appuyer et relâcher rapidement.

Appui long

Appuyez et maintenez enfoncé pour la durée programmée.



AVIS:

Voir [Fonctionnement d'urgence à la page 447](#) pour en savoir plus sur la durée de programmation pour la touche **Urgence**.

Fonctions attribuables de la radio

Les fonctions suivantes de la radio peuvent être attribuées aux boutons programmables par le détaillant ou administrateur de système.

Ambiance audio

Permet à l'utilisateur de sélectionner un environnement dans lequel la radio fonctionne.

Profils audio

Permet à l'utilisateur de sélectionner le profil audio préféré.

Commutateur® audio Bluetooth

Permet de faire alterner l'acheminement du signal audio entre le haut-parleur de la radio ou par un accessoire Bluetooth externe.

Connexion Bluetooth

Permet de lancer l'exécution d'une opération de recherche et de connexion Bluetooth.

Déconnexion Bluetooth

Met fin à toutes les connexions Bluetooth entre votre radio et tout dispositif Bluetooth.

Détection Bluetooth

Permet à votre radio de passer en mode Détection Bluetooth.

Contacts

Permet l'accès direct à la liste des contacts.

Avertissement d'appel

Permet l'accès direct à la liste des contacts de la radio afin de sélectionner le destinataire d'un avertissement d'appel.

Journal des appels

Permet d'ouvrir le journal des appels.

Urgence

Selon la programmation choisie, déclenche ou annule une urgence.

Quitter la diffusion publique (PA)

Faire basculer le routage de l'audio entre l'amplificateur/haut-parleur PA connecté et le système de sonorisation interne de la radio.

Réinitialiser le canal d'accueil

Définit un nouveau canal d'accueil.

Mettre en sourdine le Rappel du canal d'accueil

Mets en sourdine le rappel du canal d'accueil.

Localisation interne

Activation ou désactivation de la fonction de localisation interne.

Audio intelligent

Active ou désactive la fonction Audio intelligent.

Num. manuelle

Permet d'effectuer un appel individuel en entrant un ID d'abonné.

Itinérance de site manuelle

Lance une recherche de site manuelle.

CGA Mic.

Permet d'activer et de désactiver la fonction de contrôle de gain automatique du microphone.

Notifications

Permet l'accès direct à la liste des notifications.

Accès direct

Lance directement un appel de diffusion, individuel, téléphonique ou de groupe, un avertissement d'appel ou un message texte rapide prédéfini.

Fonction de carte d'option

Active ou désactive les fonctions de la carte d'option sur les canaux qui les utilisent.

Téléphone

Permet l'accès direct à la liste des contacts du téléphone.

Cryptage

Active ou désactive la fonction de cryptage.

Diffusion publique (PA)

Active/désactive le système PA interne de la radio.

Alias et ID de la radio

Indique l'alias et l'ID de la radio.

Écoute à distance

Active le microphone d'une radio cible sans indication.

Info site

Affiche le nom et l'ID du site Capacity Max actuel.

Transmet les messages vocaux pour le site actuel pour le site actuel lorsque l'Annonce vocale est activée.

Verrouillage de site

Lorsque cette fonction est activée, la radio ne recherche que le site courant. Lorsqu'elle est désactivée, la radio recherche d'autres sites en plus du site courant.

Contrôle de la télémétrie

Permet de contrôler la broche de sortie sur une radio locale ou distante.

Message texte

Sélectionne le menu de la messagerie texte.

Basculement entre les niveaux de priorité d'appel

Permet à votre radio de passer au niveau de priorité d'appel élevé/normal.

Amélioration de la vibration

Permet d'activer et de désactiver l'amélioration de la vibration.

Annonce vocale activée/désactivée

Active ou désactive la fonction d'annonce vocale.

Annonces vocales pour canal

Transmet des messages vocaux pour une zone et un canal sur le canal sélectionné. Cette fonction n'est pas accessible si les annonces vocales ne sont pas activées.

Wi-Fi

Permet d'activer ou de désactiver la fonction Wi-Fi.

Sélection de zone

Permet de sélectionner une zone dans une liste.

Réglages ou fonctions attribuables

Les fonctions ou paramètres radio suivants peuvent être attribués aux touches programmables.

Sonneries/alertes

Permet d'activer et de désactiver les sonneries et les avertissements.

Rétroéclairage

Active ou désactive le rétroéclairage de l'écran.

Canal précédent/suivant

Selon la programmation, passe au canal précédent ou suivant.

Mode d'affichage







Permet d'alterner entre l'activation et la désactivation des modes d'affichage Jour et Nuit.

Niveau de puissance

Alterne entre un niveau de puissance haut ou bas.

Accès aux fonctions programmées

Suivez la procédure suivante pour accéder aux fonctions programmées de votre radio.

- 1 Faites un des suivants :
 - Appuyez sur la touche programmée. Passez à [étape 3](#).
 - Appuyez sur  pour accéder au menu.
-
- 2 Appuyez sur  ou  jusqu'à la fonction du menu et appuyez sur  pour sélectionner une fonction ou entrer dans un sous-menu.
-
- 3 Faites un des suivants :
 - Appuyez sur  pour revenir à l'écran précédent.
 - Maintenez enfoncée la touche  pour revenir à l'écran d'accueil.

La radio quitte automatiquement le menu et revient à l'écran d'accueil après une période d'inactivité.

Des touches de navigation se trouvent également sur le microphone à clavier. Voir [Touches du microphone à clavier à la page 43](#).

Indicateurs d'état

Ce chapitre explique les indicateurs d'état et les tonalités audio utilisés par la radio.

Icônes

L'affichage à cristaux liquides (ACL) présente l'état de la radio, les entrées de texte et des menus.





Tableau 2: Icônes d'affichage





Vous trouverez ci-dessous les icônes s'affichant dans la barre d'état qui apparaît au haut de l'écran. Les icônes sont classées par ordre d'utilisation ou d'apparition à partir de la gauche et sont spécifiques au canal.







Bluetooth connecté









La fonction Bluetooth est activée.
L'icône demeure allumée tant qu'un

	dispositif Bluetooth distant est connecté.
	Bluetooth non connecté La fonction Bluetooth est activée, mais aucun appareil Bluetooth à distance n'est connecté.
	Urgence La radio est en mode d'urgence.
	Fonction GNSS disponible La fonction GNSS est activée. L'icône demeure allumée tant que la réception d'une position est disponible.
	Fonction GNSS non disponible La fonction GNSS est activée, mais ne reçoit aucune donnée du satellite.
	Données à volume élevé La radio reçoit des données à volume élevé et le canal est occupé.

	Localisation interne disponible¹ L'état de la localisation intérieure est activé et disponible.
	Positionnement à l'intérieur non disponible¹ L'état de la localisation intérieure est activé, mais non disponible parce que la fonction Bluetooth est désactivée ou parce que la détection des balises a été suspendue par Bluetooth.
	Mode Muet Le mode Muet est activé et le haut-parleur est coupé.
	Notification La liste de notifications comprend au moins un événement manqué.
	Carte d'option La fonction Carte d'option est activée. (Modèles dotés de la fonction Carte d'option uniquement.)

¹ Ne s'applique qu'aux logiciels et au matériel les plus récents.

	<p>Absence de fonction de la carte d'option La fonction Carte d'option est désactivée.</p>
	<p>Retardateur de programmation par radiocommunication Indique le temps restant avant le redémarrage automatique de la radio.</p>
	<p>Priorité 1 Indique le Groupe de priorité 1.</p>
	<p>Priorité 2 Indique le Groupe de priorité 2.</p>
	<p>Indicateur de puissance de signal reçu (RSSI) Le nombre de barres représente l'intensité du signal radio. L'affichage de quatre barres indique une intensité de signal maximale. Cette icône ne s'affiche qu'en mode de réception.</p>

	<p>Suppr. réponse La suppression de réponse est activée.</p>
	<p>Sonnerie seulement Le mode sonnerie est activé.</p>
	<p>Sécurisée La fonction Cryptage est activée.</p>
	<p>Fréquence partagée Indique que la radio se connecte au canal de contrôle partagé.</p>
	<p>Sonnerie silencieuse Le mode de sonnerie silencieuse est activé.</p>
	<p>Itinérance de site La fonction d'itinérance de site est activée.</p>
	<p>État Indique un nouveau message d'état.</p>
	<p>Désactivation des tonalités Les tonalités sont désactivées.</p>







	Non sécurisée La fonction Cryptage est désactivée.
	Wi-Fi Excellent² Le signal Wi-Fi est excellent.
	Wi-Fi bon² Le signal Wi-Fi est bon.
	Wi-Fi moyen² Le signal Wi-Fi est moyen.
	Wi-Fi faible² Le signal Wi-Fi est faible.
	Wi-Fi non disponible² Le signal Wi-Fi n'est pas disponible.

Tableau 3: Icônes de menu avancé

Les icônes suivantes s'affichent près des éléments de menu qui offrent un choix entre deux options ou qui présentent un sous-menu offrant aussi deux options.

² Applicable uniquement pour les modèles XPR 5550e/XPR 5580e.





	Case à cocher (cochée) Indique que l'option est sélectionnée.
	Case à cocher (vide) Indique que l'option n'est pas sélectionnée.
	Case noire Indique que l'option sélectionnée dans le menu comporte un sous-menu.

Tableau 4: Icônes de dispositif Bluetooth

Les icônes suivantes accompagnent les éléments de la liste de dispositifs Bluetooth afin de vous informer sur le type du dispositif.

	Dispositif audio Bluetooth Il s'agit d'un dispositif audio compatible avec la technologie Bluetooth, comme un casque d'écoute.
---	--







	<p>Dispositif de données Bluetooth Dispositif de transfert de données Bluetooth, par exemple, un lecteur de codes à barres.</p>
	<p>Dispositif PTT Bluetooth Il s'agit d'un dispositif PTT (messagerie vocale instantanée) compatible avec la technologie Bluetooth, comme un dispositif à fonction PTT uniquement (POD).</p>

Tableau 5: Icônes d'appels

Vous trouverez ci-dessous les icônes s'affichant à l'écran de la radio pendant un appel. Ces icônes apparaissent également dans la liste de contacts pour indiquer le type d'alias ou d'ID.

	<p>Appel PC par Bluetooth Indique qu'un appel PC par Bluetooth est en cours.</p> <p>Dans la liste de contacts, elle indique l'alias (nom) ou l'ID (numéro) de l'appel PC par Bluetooth.</p>
---	--

	<p>Priorité d'appel élevée Indique que le niveau de priorité d'appel élevé est activé.</p>
	<p>Appel de répartition Le type de contact d'appel de répartition sert à envoyer un message texte à un PC répartiteur par le biais d'un serveur de messagerie texte de tiers.</p>
	<p>Appel de groupe/appel général Cette icône s'affiche lorsqu'un appel de groupe ou un appel général est en cours.</p> <p>Dans la liste de contacts, elle indique l'alias (nom) ou l'ID (numéro) du groupe.</p>
	<p>Appel individuel Cette icône s'affiche lorsqu'un appel individuel est en cours.</p> <p>Dans la liste de contacts, elle indique l'alias (nom) ou l'ID (numéro) de l'abonné.</p>

	<p>Appel de groupe comme étant un appel de groupe/général</p> <p>Indique un appel téléphonique comme étant un appel de groupe/général en cours.</p> <p>Dans la liste de contacts, elle indique l'alias (nom) ou l'ID (numéro) du groupe.</p>
	<p>Appel téléphonique comme étant un appel individuel</p> <p>Indique un appel téléphonique comme étant un Appel individuel en cours.</p> <p>Dans la liste de contacts, elle indique l'alias (nom) ou l'ID (numéro) du téléphone.</p>

Tableau 6: Icônes de tickets de tâche

Les icônes suivantes apparaissent momentanément sur l'écran dans le dossier Tickets de tâche.

	<p>Toutes les tâches</p> <p>Indique toutes les tâches de la liste.</p>
--	---

	<p>Nouvelles tâches</p> <p>Indique les nouvelles tâches.</p>
	<p>En cours</p> <p>Les travaux sont en cours de transmission. Ceci s'affiche avant l'indication d'échec ou de réussite d'envoi de tickets tâche.</p>
	<p>Échec de l'envoi</p> <p>Les travaux ne peuvent être envoyés.</p>
	<p>Réussite de l'envoi</p> <p>Les travaux ont été envoyés avec succès.</p>
	<p>Priorité 1</p> <p>Indique le niveau de priorité 1 pour les travaux.</p>
	<p>Priorité 2</p> <p>Indique le niveau de priorité 2 pour les travaux.</p>



Priorité 3

Indique le niveau de priorité 3 pour les travaux.

Tableau 7: Icônes d'avertissement

Les icônes décrites ci-dessous s'affichent momentanément à l'écran de la radio lors de l'exécution d'une tâche.



Échec de transmission (négatif)

L'action exécutée n'a pas réussi.



Transmission réussie (positif)

L'action exécutée a réussi.



Transmission en cours (transitoire)

Transmission en cours. Cette icône s'affiche avant l'indication de réussite ou d'échec de la transmission.



En cours

Le message texte destiné à un alias ou à un ID d'abonné est en attente de transmission et sera ensuite en attente de confirmation.

Le message texte destiné à un alias ou à un ID de groupe est en attente de transmission.



Message personnel ou de groupe lu

Le message texte a été lu.



Message personnel ou de groupe non lu

Le message texte n'a pas été lu.



Échec de l'envoi

Le message texte ne peut être envoyé.

Tableau 8: Icônes des éléments envoyés

Les icônes ci-dessous apparaissent dans le coin supérieur droit de l'écran dans le dossier Messages envoyés.



ou



Réussite de l'envoi

Le message texte a été envoyé.

Voyant lumineux

Le voyant DEL indique l'état de fonctionnement de la radio.

Rouge clignotant

La radio n'a pas réussi l'autovérification à la mise sous tension.

La radio reçoit une transmission d'urgence.

La radio effectue une transmission avec un niveau de batterie faible.

La radio est maintenant hors de la zone de couverture si la fonction ARTS est configurée.

Mode Muet est activé.

Vert continu

La radio est en cours de mise sous tension.

La radio effectue une transmission.

La radio envoie un avertissement d'appel ou une transmission d'urgence.

Vert clignotant

La radio est en train de recevoir un appel ou des données.

La radio récupère des transmissions de programmation par radiocommunication.

La radio détecte de l'activité de radiocommunication.



AVIS:

Cette activité peut influencer ou non le canal programmé de la radio en raison de la nature du protocole relatif aux données numériques.

Vert à clignotement double

La radio reçoit un appel ou des données cryptées.

Jaune continu

La radio est en mode Détection Bluetooth.

Jaune clignotant

La radio n'a pas encore répondu à un avertissement d'appel.

Jaune à clignotement double

La fonction Itinérance automatique est activée.

La radio recherche activement un nouveau site.

La radio n'a pas encore répondu à un avertissement d'appel de groupe.

La radio est verrouillée.

Tonalités

Vous trouverez ci-dessous les tonalités émises par le haut-parleur de la radio.



Tonalité aiguë



Tonalité grave

Tonalités audio

La fonction Tonalités audio vous informe de manière audible de l'état ou répond à la réception de données sur la radio.



Tonalité continue

La radio émet un signal monophonique. Il retentit de manière continue jusqu'à ce qu'il cesse.



Tonalité périodique

Le signal sonore retentit de manière périodique en fonction des réglages de la radio. Il démarre, s'arrête, puis reprend.



Tonalité répétitive

Le signal sonore unique retentit et se répète jusqu'à ce que l'utilisateur y mette fin.



Tonalité temporaire

Son entendu une fois pendant une courte période définie par la radio.

Tonalités d'avertissement

Les tonalités d'avertissement vous informent de manière audible de l'état d'une tâche après l'avoir initiée.



Tonalité de réussite



Tonalité d'échec

Enregistrement

Il y a un certain nombre de messages liés à l'enregistrement que vous pouvez recevoir.

Enregistrement

En règle générale, l'enregistrement est envoyé au système lors de la mise sous tension, d'un changement de groupe d'appels ou durant l'itinérance de site. Si une radio ne parvient pas s'enregistrer sur un site, la radio tente automatiquement de se connecter à un autre site. La radio supprime temporairement le site où l'enregistrement a été tenté de la liste d'itinérance.

L'indication signifie que la radio est occupée à chercher un site pour l'itinérance ou qu'elle a réussi à trouver un site, mais est en attente d'une réponse aux messages d'enregistrement de la radio.

Lorsque **Enregistrement** est affiché sur la radio, une tonalité retentit et le voyant DEL jaune clignote en double pour indiquer une recherche de site.

Si les indications persistent, l'utilisateur doit changer d'emplacements ou s'il est autorisé, manuellement se connecter à un autre site.

Hors de portée

Une radio est jugée hors de portée lorsqu'elle est incapable de détecter un signal provenant du système ou du site actuel. Règle générale, cette indication signifie que la radio est à l'extérieur de la zone de couverture radio de la radiofréquence sortante géographique.

Lorsque **Hors de portée** s'affiche sur la radio, une tonalité répétitive retentit et le voyant DEL rouge clignote.

Contactez votre détaillant ou administrateur de système si la radio reçoit encore des indications comme étant hors de portée tout en étant dans une zone bénéficiant d'une bonne couverture RF.

Échec d'affiliation au groupe d'appels

Une radio tente de s'affilier au groupe d'appels spécifié dans les canaux ou la position du bouton unifiée (UKP) au cours de l'enregistrement.

Une radio qui est dans un état d'échec d'affiliation ne peut pas émettre ou recevoir des appels du groupe d'appels auquel la radio tente de s'affilier.

Lorsqu'une radio est incapable de s'affilier à un groupe d'appels, UKP alias (alias KP) s'affiche dans l'écran d'accueil avec un arrière-plan en surbrillance.

Contactez votre détaillant ou administrateur de système si la radio reçoit des indications d'échec d'affiliation.

Enregistrement refusé

Les indicateurs d'enregistrement refusé sont reçus lorsque l'enregistrement avec le système n'est pas accepté.

La radio n'indique pas à l'utilisateur radio la raison exacte du refus de l'enregistrement. Normalement, un enregistrement est refusé lorsque l'opérateur du système a désactivé l'accès de la radio au système.

Lorsque l'enregistrement est refusé à la radio, Refus enregistrem. est affiché sur la radio et le voyant DEL jaune clignote en double pour indiquer une recherche de site.

Sélection des zones et des canaux





Ce chapitre décrit la procédure pour sélectionner une zone ou un canal sur votre radio.



La radio peut être programmée avec un maximum de 250 zones Capacity Max avec un maximum de 160 canaux par zone. Chaque zone Capacity Max contient un maximum de 16 positions attribuables.

Sélection des zones

Suivez la procédure suivante pour sélectionner la zone requise sur votre radio.

- 1 Faites un des suivants :
 - Appuyez sur la touche programmée **Sélection de zone**. Passez à [étape 3](#).
 - Appuyez sur  pour accéder au menu.





- 2 Appuyez sur  ou  jusqu'à Zone. Appuyez sur  pour effectuer la sélection.
L'écran affiche  et la zone courante.

- 3 Appuyez sur  ou  jusqu'à la zone voulue.
Appuyez sur  pour effectuer la sélection.
L'écran affiche <Zone> sélectionnée pendant un moment et revient à l'écran de la zone sélectionnée.

Sélection des zones à l'aide de la recherche d'alias

Suivez la procédure suivante pour sélectionner la zone voulue à l'aide de la recherche d'alias.

- 1 Appuyez sur  pour accéder au menu.

- 2 Appuyez sur  ou  jusqu'à Zone. Appuyez sur  pour effectuer la sélection.
L'écran affiche  et la zone actuelle.

- 3 Entrez le premier caractère de l'alias voulu.
L'écran affiche un curseur clignotant.

- 4 Entrez le reste des caractères de l'alias voulu.

La recherche d'alias n'est pas sensible à la casse. Si deux entrées ou plus portent le même nom, la radio affiche l'entrée figurant en premier dans la liste.

La première ligne de texte affiche les caractères que vous avez entrés. La ligne de texte suivante affiche les résultats de la recherche.

-
- 5 Appuyez sur  pour effectuer la sélection.
L'écran affiche <Zone> sélectionnée pendant un moment et revient à l'écran de la zone sélectionnée.
-

Sélection d'un type d'appel

Utilisez le bouton sélecteur de canal pour sélectionner un type d'appel. Il peut s'agir d'un appel de groupe, d'un appel de diffusion, d'un appel général ou d'un appel individuel, selon la programmation de votre radio. Si vous modifiez la position du bouton de sélection de canaux (à une position à laquelle un type d'appel est affecté), la radio s'enregistrera à nouveau sur le système Capacity Max. La radio s'enregistre en utilisant l'ID de groupe d'appels qui a été programmé pour le nouveau type d'appel de la position du bouton de sélection de canal.

Étant donné que votre radio ne peut pas fonctionner lorsqu'un canal non programmé est sélectionné, utilisez le bouton sélecteur de canal pour sélectionner un canal programmé.

Lorsque la zone requise est affichée (si vous avez plusieurs zones sur votre radio), tournez le bouton sélecteur de canal pour sélectionner le type d'appel.

Sélectionner un site

Un site fournit la couverture pour une zone particulière. Dans les réseaux multisites, la radio Capacity Max recherche automatiquement un nouveau site lorsque la puissance du signal du site courant chute sous un niveau inacceptable.

Le système Capacity Max peut prendre en charge jusqu'à 250 sites.

Demande d'itinérance

Une demande d'itinérance dit à la radio de rechercher un autre site, même si le signal du site courant est acceptable.

Si aucun site n'est disponible :

- L'écran de la radio affiche le message Recherche et poursuit la recherche dans la liste des sites.
- La radio reviendra au site précédent si celui-ci est toujours disponible.



AVIS:

Ceci est programmé par votre détaillant.

Appuyez sur la touche programmée **Itinérance de site manuelle**.

Une tonalité retentit pour indiquer que la radio est passée à un nouveau site. L'écran affiche ID du site <Numéro du site>.

Verrouillage de site activé/désactivé

Lorsque cette fonction est activée, la radio ne recherche que le site courant. Lorsqu'elle est désactivée, la radio recherche d'autres sites en plus du site courant.

Appuyez sur la touche programmée **Verr. Site**.

Si la fonction **Verrouillage de site** est activée :

- Une tonalité de réussite retentit pour indiquer que la radio s'est verrouillée sur le site courant.

- L'écran affiche `Site verrouillé`.

Si la fonction **Verrouillage du site** est désactivée :

- Une tonalité d'échec retentit pour indiquer que la radio est déverrouillée.
- L'écran affiche `Site Déverrouillé`.

Restriction de site

Pour les systèmes Capacity Max, votre administrateur de système radio est en mesure de décider quels sites réseau sont autorisés ou non.

Il n'est pas nécessaire de reprogrammer votre radio pour modifier la liste des sites autorisés et non autorisés. Si votre radio tente de s'inscrire sur un site non autorisé, votre radio reçoit l'indication que le site est refusé. La radio recherche alors un autre site réseau.

Lorsque vous rencontrez des restrictions de site, votre radio affiche `Refus enregistrement` et le voyant DEL jaune clignote en double pour indiquer une recherche de site.

ADF de site

Un site doit être en mesure de communiquer avec le contrôleur de site ADF pour être considéré comme un système ADF.

Si le site ne parvient pas à communiquer avec le tronçon contrôleur de site ADF, alors la radio entre en mode ADF de site. Lorsqu'en mode ADF de site, la radio envoie une indication audible et visuelle périodiquement pour informer l'utilisateur de sa fonctionnalité limitée.

Lorsqu'une radio est en ADF de site, la radio affiche `Res. partag. Site` et une tonalité répétitive se fait entendre.

Les radios en mode ADF de site sont toujours en mesure de passer des appels vocaux, individuels ou de groupe ainsi que d'envoyer des messages texte à d'autres radios du même site. Les consoles vocales, les enregistreurs de journalisation, les passerelles de téléphone et les applications de données ne peuvent communiquer avec les radios sur le site.

Une fois qu'elle est en mode ADF de site, une radio qui participe à des appels sur des sites multiples ne sera en mesure de communiquer qu'avec d'autres radios au sein d'un même site. La communication à en provenance et en destination d'autres sites pourraient être perdues.

**AVIS:**

S'il y a plusieurs sites qui couvrent l'emplacement actuel de la radio et l'un des sites passe en mode ADF de site, les radios vont se connecter à un autre site dans la couverture.

Appels

Ce chapitre décrit les opérations pour recevoir et répondre à des appels, en faire et y mettre fin.

Vous pouvez choisir un alias ou un ID d'abonné, ou un alias ou un ID de groupe une fois que vous avez sélectionné un canal à l'aide d'une de ces fonctions :

Recherche d'alias

Cette méthode est utilisée uniquement pour faire un appel de groupe, un appel individuel ou un appel général à partir du microphone à clavier.

Liste de contacts

Cette méthode permet d'accéder directement à la liste des contacts.

Numérotation manuelle (à partir de Contacts)

Cette méthode est utilisée uniquement pour faire un appel individuel ou un appel téléphonique à partir du microphone à clavier.

Touches numériques programmées

Cette méthode est utilisée uniquement pour faire un appel de groupe, un appel individuel ou un appel général à partir du microphone à clavier.

**AVIS:**

Vous ne pouvez attribuer qu'un seul alias ou ID à une touche numérique, mais vous pouvez attribuer plus d'une touche numérique à un alias ou à un ID. Toutes les touches numériques du microphone à clavier peuvent être attribuées. Pour obtenir plus de renseignements à ce sujet, consultez la section [Association d'une entrée à une touche numérique programmable à la page 431](#).

Touche programmée d'accès direct

Cette méthode est utilisée uniquement pour faire des appels de groupe, individuel et téléphonique.

Vous pouvez attribuer uniquement un ID à une **touche d'accès direct** programmable avec un appui prolongé ou bref. Vous pouvez programmer plusieurs touches **d'accès direct** sur la radio.

Bouton programmable

Cette méthode est utilisée uniquement pour faire un appel téléphonique.

Bouton Volume/Canal

Cette méthode sélectionne manuellement un alias ou un ID d'abonné, ou un alias ou un ID de groupe.

Le voyant DEL passe au vert continu lorsque la radio est en cours de transmission et clignote en vert lorsque la radio est en cours de réception.



AVIS:

Le voyant DEL passe au vert continu durant la transmission d'un appel crypté et émet un clignotement double en vert durant la réception d'un appel crypté.

Pour décoder un appel crypté, votre radio doit être dotée de la même clé de confidentialité ou des mêmes valeurs et ID de clé (programmés par le détaillant) que la radio émettrice (la radio de laquelle vous recevez l'appel).

Pour obtenir plus de renseignements à ce sujet, consultez la section [Cryptage à la page 487](#).

Appels de groupe

Votre radio doit avoir été configurée comme faisant partie d'un groupe pour être en mesure de recevoir un appel provenant d'un groupe d'utilisateurs ou de passer un appel à un groupe d'utilisateurs.

Appels de groupe

Pour être en mesure de faire un appel à un groupe d'utilisateurs, votre radio doit avoir été préalablement définie comme partie intégrante de ce groupe. Suivez la procédure suivante pour faire des appels de groupe à partir de la radio.

1 Faites un des suivants :

- Sélectionnez le canal qui correspond à l'alias ou à l'ID de groupe. Voir [Sélection d'un type d'appel à la page 66](#).
- Appuyez sur la touche d'**accès direct** programmée.

2 Pour passer l'appel, appuyez sur le bouton de conversation **PTT**.

Le voyant DEL vert s'allume. L'icône **Appel de groupe** et l'alias s'affichent sur la première ligne de l'écran.

3 Faites un des suivants :

- Attendez la fin de la tonalité d'autorisation de parler (si elle est activée) et parlez clairement dans le microphone.

- Attendez la fin de l'effet local **PTT** (s'il est activé) et parlez clairement dans le microphone.

4 Relâchez le bouton **PTT** pour écouter.

Le voyant DEL vert s'allume lorsque la radio cible répond. L'écran affiche l'icône **Appel de groupe**, et l'alias ou l'ID ainsi que l'alias ou l'ID de la radio émettrice.

5 Si l'indicateur Canal libre est activé, une courte tonalité d'avertissement se fait entendre lorsque l'utilisateur de la radio émettrice cesse d'appuyer sur le bouton **PTT**, vous indiquant que le canal est libre et que vous pouvez répondre. Pour prendre l'appel, appuyez sur le bouton **PTT**.



L'appel se termine lorsqu'il n'y a aucune activité vocale pendant une durée préprogrammée.



L'initiateur de l'appel peut appuyer sur  pour mettre fin à un appel de groupe.

Appels de groupe faits à l'aide de la liste de contacts

Suivez la procédure suivante pour passer des appels de groupe à l'aide de la liste de contacts à partir de la radio.

1 Appuyez sur  pour accéder au menu.

2 Appuyez sur  ou  jusqu'à **Contacts**.
Appuyez sur  pour effectuer la sélection.

3 Appuyez sur  ou  jusqu'à l'alias ou l'ID voulu. Appuyez sur  pour effectuer la sélection.

4 Pour passer l'appel, appuyez sur le bouton de conversation **PTT**.

Le voyant DEL vert s'allume.

L'alias ou l'ID de l'abonné s'affiche sur la première ligne de l'écran. Le message **Appel de groupe** et l'icône **Appel de groupe** s'affichent sur la deuxième ligne.

5 Faites un des suivants :

- Attendez la fin de la tonalité d'autorisation de parler (si elle est activée) et parlez clairement dans le microphone.
- Attendez la fin de l'effet local **PTT** (s'il est activé) et parlez clairement dans le microphone.

6 Relâchez le bouton **PTT** pour écouter.

Le voyant DEL vert clignote lorsqu'un utilisateur du groupe répond. L'écran affiche l'icône **Appel de groupe**, et l'alias ou l'ID ainsi que l'alias ou l'ID de la radio émettrice.

- 7 Si l'indicateur Canal libre est activé, une courte tonalité d'avertissement se fait entendre lorsque l'utilisateur de la radio émettrice cesse d'appuyer sur le bouton **PTT**, vous indiquant que le canal est libre et que vous pouvez répondre. Pour prendre l'appel, appuyez sur le bouton **PTT**.

L'appel se termine lorsqu'il n'y a aucune activité vocale pendant une durée préprogrammée.

L'initiateur de l'appel peut appuyer sur  pour mettre fin à un appel de groupe.

Une courte tonalité retentit. L'écran affiche Appel terminé.

Appels de groupe faits à l'aide de la touche numérique programmable

Suivez la procédure suivante pour passer des appels de groupe à l'aide de la touche numérique programmable.

- 1 À partir de l'écran d'accueil, appuyez longuement sur la touche numérique programmée jusqu'à l'alias ou à l'ID prédéfini.

Si une touche numérique a été attribuée à une entrée dans un mode particulier, la fonction n'est pas prise en charge lorsque vous appuyez longuement sur la touche numérique dans un autre mode.

Une tonalité d'échec se fait entendre si la touche numérique n'a pas été attribuée à une entrée.

- 2 Pour passer l'appel, appuyez sur le bouton de conversation **PTT**.

Le voyant DEL vert s'allume.

- 3 Relâchez le bouton **PTT** pour écouter.

Le voyant DEL vert clignote lorsqu'un utilisateur du groupe répond.

- 4 Si l'indicateur Canal libre est activé, une courte tonalité d'avertissement se fait entendre lorsque l'utilisateur de la radio émettrice cesse d'appuyer sur le bouton **PTT**, vous indiquant que le canal est libre et que vous pouvez répondre. Pour prendre l'appel, appuyez sur le bouton **PTT**.

L'appel se termine lorsqu'il n'y a aucune activité vocale pendant une durée préprogrammée. La radio revient à l'écran affiché avant la tentative d'appel.



L'initiateur de l'appel peut appuyer sur  pour mettre fin à un appel de groupe.

Pour obtenir plus de renseignements à ce sujet, consultez la section [Association d'une entrée à une touche numérique programmable à la page 431](#).

Appels de groupe faits à l'aide de la recherche d'alias



Vous pouvez également utiliser un alias ou une recherche alphanumérique pour récupérer l'alias d'un abonné. Cette fonction n'est accessible qu'au moyen de la liste des contacts. Suivez la procédure suivante pour passer n'importe quel type d'appel à l'aide de la recherche d'alias.







- 1 Appuyez sur  pour accéder au menu.

- 2 Appuyez sur  ou  jusqu'à **Contacts**.

Appuyez sur  pour effectuer la sélection.

L'écran affiche les entrées dans l'ordre alphabétique.

- 3 Appuyez sur  ou  jusqu'à l'alias ou l'ID d'abonné voulu. La première ligne de l'écran affiche le message **Numéro de téléphone :**. La deuxième ligne de l'écran affiche un curseur clignotant. Utilisez le clavier pour entrer un numéro de téléphone.

- 4 Appuyez sur  pour effectuer la sélection. Si l'entrée sélectionnée est vide, une tonalité d'indication négative se fait entendre et l'écran indique No. tél. invalide.
-
- 5 Appuyez sur  ou  pour un appel téléphonique, puis sur Appuyez sur  pour effectuer la sélection.. Si le code d'accès n'est pas préconfiguré dans la liste de contacts, la première ligne de l'écran indique Code d'accès :. La deuxième ligne de l'écran affiche un curseur clignotant. Entrez le code d'accès, puis appuyez sur  pour continuer. En cas de réussite, la tonalité DTMF se fait entendre. Vous entendrez la tonalité de composition du téléphone de l'utilisateur. La première ligne de l'écran affiche l'alias ou l'ID d'abonné et l'icône RSSI. La deuxième ligne de l'écran affiche Appel tél. et l'icône d'appel téléphonique. En cas d'échec, une tonalité se fait entendre et l'écran affiche le message Appel tél. échoué. Votre radio retourne à l'écran de code d'accès. Si le code d'accès est préconfiguré dans la
- liste de contacts, la radio revient à l'écran affiché avant la tentative d'appel.
-
- 6 Appuyez sur la touche **PTT** pour parler et relâchez la touche pour écouter. L'icône **RSSI** disparaît lors de la transmission.
-
- 7 Pour entrer d'autres chiffres, si demandé durant l'appel, procédez de l'une des façons suivantes.
- Appuyez sur n'importe quelle touche pour commencer à entrer de nouveaux chiffres. La première ligne de l'écran affiche le message Chiffres suppl. :. La deuxième ligne de l'écran affiche un curseur clignotant. Entrez les chiffres supplémentaires, puis appuyez sur  pour continuer. La tonalité DTMF se fait entendre et la radio revient à l'écran précédent.
 - Appuyez sur la touche d'**accès direct**. La tonalité DTMF se fait entendre. Si la touche d'**accès direct** n'est pas programmée, une tonalité d'échec se fait entendre.
-
- 8 Appuyez sur  pour mettre fin à l'appel. Si le code de libération n'est pas préconfiguré dans la

liste de contacts, la première ligne de l'écran indique Code de libération :. La deuxième ligne de l'écran affiche un curseur clignotant. Entrez le code

de retrait d'accès, puis appuyez sur  pour continuer. La radio revient à l'écran précédent. La tonalité DTMF se fait entendre et l'écran affiche Fin de l'appel tél.. En cas de réussite, une tonalité se fait entendre et l'écran affiche le message Appel tél. terminé. Votre radio retourne à l'écran d'appel téléphonique. En cas d'échec, votre radio retourne à l'écran d'appel téléphonique. Quand vous appuyez sur la touche **PTT** à l'écran Contacts tél, une tonalité se fait entendre et l'écran affiche le message App. OK pour placer appel. Lorsque l'utilisateur a terminé d'utiliser le téléphone, une tonalité se fait entendre et l'écran affiche le message Fin appel tél.. Si l'appel se termine pendant que vous entrez les autres chiffres demandés par l'appel téléphonique, la radio revient à l'écran affiché avant la tentative d'appel.

-
- 9 Si l'indicateur Canal libre est activé, une courte tonalité d'avertissement se fait entendre lorsque l'utilisateur de la radio émettrice cesse d'appuyer sur le bouton **PTT**, vous indiquant que le canal est libre

et que vous pouvez répondre. Pour prendre l'appel, appuyez sur le bouton **PTT**.



L'appel se termine lorsqu'il n'y a aucune activité vocale pendant une durée préprogrammée. Une tonalité se fait entendre. L'écran affiche Appel terminé.

L'initiateur de l'appel peut appuyer sur  pour mettre fin à un appel de groupe.



AVIS:

Pendant l'accès à un canal, appuyez sur  pour mettre fin à la tentative d'appel et une tonalité se fait entendre ou pour quitter la recherche d'alias.

Appuyez sur la touche  ou  pour quitter la recherche d'alias. Pendant l'appel, lorsque vous appuyez sur la touche d'**accès direct**, si le code de non-accès est préconfiguré ou si vous entrez le code de non-accès en entrée pour les autres chiffres, la radio tentera de mettre fin à l'appel. Pendant l'accès à un canal, à un code d'accès/retrait d'accès ou encore lors d'une transmission d'autres chiffres, seuls les boutons Marche/Arrêt, Réglage du volume et le sélecteur de canal sont actifs. Une tonalité se fait entendre pour toutes les entrées non valides.

Réponse à un appel de groupe

Suivez la procédure suivante pour répondre à un appel de groupe sur votre radio.

Lorsque vous recevez un appel de groupe :

- Le voyant DEL vert clignote.

- L'icône **Appel de groupe** s'affiche dans le coin droit supérieur de l'écran.
 - L'alias de l'appelant s'affiche sur la première ligne de l'écran.
 - L'alias du groupe s'affiche sur la deuxième ligne de l'écran.
 - Votre radio désactive la sourdine et l'appel entrant se fait entendre sur le haut-parleur.
- 1 Faites un des suivants :
- Si l'indicateur Canal libre est activé, une courte tonalité d'avertissement se fait entendre lorsque l'utilisateur de la radio émettrice cesse d'appuyer sur le bouton **PTT**, vous indiquant que le canal est libre et que vous pouvez répondre. Pour prendre l'appel, appuyez sur le bouton **PTT**.
 - Si la fonction Interruption vocale est activée, appuyez sur le bouton **PTT** pour mettre interrompre le son sur la radio qui émet la transmission et libérer le canal afin de vous permettre de répondre.
- Le voyant DEL vert s'allume.

-
- 2 Faites un des suivants :

- Attendez la fin de la tonalité d'autorisation de parler (si elle est activée) et parlez clairement dans le microphone.
- Attendez la fin de l'effet local **PTT** (s'il est activé) et parlez clairement dans le microphone.

3 Relâchez le bouton **PTT** pour écouter.

L'appel se termine lorsqu'il n'y a aucune activité vocale pendant une durée préprogrammée.

Appel de diffusion

Un appel de diffusion est un appel vocal de n'importe quel utilisateur à un groupe d'appels en entier.

La fonction Appel de diffusion permet uniquement au lanceur d'appel de transmettre au groupe d'appels, mais les destinataires de l'appel ne peuvent pas répondre.

L'initiateur de la diffusion peut également mettre fin à l'appel de diffusion. Pour être en mesure de recevoir un appel d'un groupe d'utilisateurs ou pour appeler ce dernier, votre radio doit avoir été configurée comme faisant partie de ce groupe.

Appels de diffusion

Suivez la procédure suivante pour faire des appels de diffusion à partir de la radio.

1 Faites un des suivants :

- Sélectionnez le canal qui correspond à l'alias ou à l'ID de groupe. Voir [Sélection d'un type d'appel à la page 66](#).
 - Appuyez sur la touche d'**accès direct** programmée.
-

2 Pour passer l'appel, appuyez sur le bouton de conversation **PTT**.

Le voyant DEL vert s'allume. L'écran affiche l'icône et l'alias **Appel groupe**.







3 Faites un des suivants :

- Attendez la fin de la tonalité d'autorisation de parler (si elle est activée) et parlez clairement dans le microphone.
- Attendez la fin de l'effet local **PTT** (s'il est activé) et parlez clairement dans le microphone.

L'initiateur de l'appel peut appuyer sur  pour mettre fin à l'appel de diffusion.

Appels de diffusion faits à l'aide de la liste de contacts

Suivez la procédure suivante pour passer des appels de diffusion à l'aide de la liste de contacts.

- 1 Appuyez sur  pour accéder au menu.
- 2 Appuyez sur  ou  jusqu'à **Contacts**.
Appuyez sur  pour effectuer la sélection.
- 3 Appuyez sur  ou  jusqu'à l'alias ou l'ID voulu. Appuyez sur  pour effectuer la sélection.
- 4 Pour passer l'appel, appuyez sur le bouton de conversation **PTT**.
Le voyant DEL vert clignote.

L'alias ou l'ID de l'abonné s'affiche sur la première ligne de l'écran. Le message **Appel de groupe** et l'icône **Appel de groupe** s'affichent sur la deuxième ligne.

- 5 Faites un des suivants :
 - Attendez la fin de la tonalité d'autorisation de parler (si elle est activée) et parlez clairement dans le microphone.
 - Attendez la fin de l'effet local **PTT** (s'il est activé) et parlez clairement dans le microphone.

L'initiateur de l'appel peut appuyer sur  pour mettre fin à l'appel de diffusion.

Appels de diffusion faits à l'aide de la touche numérique programmable

Suivez la procédure suivante pour passer des appels de diffusion à l'aide de la touche numérique programmable.

- 1 À partir de l'écran d'accueil, appuyez longuement sur la touche numérique programmée jusqu'à l'alias ou à l'ID prédéfini.

Si une touche numérique a été attribuée à une entrée dans un mode particulier, la fonction n'est pas prise en charge lorsque vous appuyez longuement sur la touche numérique dans un autre mode.

Une tonalité d'échec se fait entendre si la touche numérique n'a pas été attribuée à une entrée.

-
- 2** Pour passer l'appel, appuyez sur le bouton de conversation **PTT**.

Le voyant DEL vert s'allume. L'icône **Appel de groupe** s'affiche dans le coin droit supérieur de l'écran. L'alias de l'appelant s'affiche sur la première ligne de l'écran.

-
- 3** Faites un des suivants :

- Attendez la fin de la tonalité d'autorisation de parler (si elle est activée) et parlez clairement dans le microphone.
- Attendez la fin de l'effet local **PTT** (s'il est activé) et parlez clairement dans le microphone.

L'initiateur de l'appel peut appuyer sur  pour mettre fin à l'appel de diffusion.

Réception d'appels de diffusion

Suivez la procédure suivante pour recevoir des appels de diffusion sur votre radio.

Si vous recevez un Appel de diffusion :

- Le voyant DEL vert clignote.
- L'icône **Appel de groupe** s'affiche dans le coin droit supérieur de l'écran.
- L'alias de l'appelant s'affiche sur la première ligne de l'écran.
- L'alias du groupe s'affiche sur la deuxième ligne de l'écran.
- Votre radio désactive la sourdine et l'appel entrant se fait entendre sur le haut-parleur.



AVIS:

Les destinataires ne sont pas en mesure de répondre lors d'un appel de diffusion. L'écran affiche Réponse interdite. La tonalité de réponse interdite retentit pendant un court instant si l'utilisateur appuie sur le bouton **PTT** pendant un appel de diffusion.

Appel individuel

Un Appel individuel est un appel effectué à partir d'une radio individuelle vers une autre radio individuelle.

Il existe deux manières de configurer un appel individuel.

- Le premier type d'appel est appelé appel individuel en mode établissement d'une connexion sans émission (OACSU). Le mode OACSU définit l'appel après avoir effectué une vérification de présence radio et met fin automatiquement à l'appel.
- Le second type est appelé établissement d'une connexion sans émission intégrale (FOACSU). Le mode FOACSU définit également l'appel après avoir effectué une vérification de présence radio. Cependant, un accusé de réception de l'utilisateur est requis pour les appels FOACSU afin de terminer l'appel et permettre à l'utilisateur d'accepter ou de refuser l'appel.

Le type d'appel est configuré par l'administrateur système.



AVIS:

Le lanceur d'appel et le destinataire sont en mesure de mettre fin à un appel individuel en cours en appuyant sur le bouton  .

Exécution d'un appel individuel

Votre radio doit avoir été préalablement programmée pour vous permettre de faire un appel individuel. Si cette fonction n'est pas activée, vous entendrez une tonalité d'indication négative lorsque vous lancez l'appel. Suivez la procédure suivante pour faire des appels privés à partir de la radio. Si la radio cible n'est pas disponible, une courte tonalité retentit et l'écran affiche Appelé non disponible.

1 Faites un des suivants :

- Sélectionnez un canal qui correspond à l'alias ou à l'ID d'abonné. Voir [Sélection d'un type d'appel à la page 66](#).
- Appuyez sur la touche d'**accès direct** programmée.

- 2 Pour passer l'appel, appuyez sur le bouton de conversation **PTT**.

Le voyant DEL vert s'allume. L'écran affiche l'icône d'**appel individuel**, l'alias de l'abonné et l'état de l'appel.

- 3 Attendez la fin de la tonalité d'autorisation de parler (si elle est activée) et parlez clairement dans le microphone.

- 4 Relâchez le bouton **PTT** pour écouter.

Le voyant DEL vert s'allume lorsque la radio cible répond.

- 5 L'appel se termine lorsqu'il n'y a aucune activité vocale pendant une durée préprogrammée. Une courte tonalité retentit. L'écran affiche Appel terminé.

Le lanceur d'appel et le destinataire sont en mesure de mettre fin à un appel individuel en cours en

appuyant sur le bouton .

Appels individuels faits à l'aide de la touche numérique programmable

Suivez la procédure suivante pour passer des appels privés à l'aide de la touche numérique programmable.

- 1 À partir de l'écran d'accueil, appuyez longuement sur la touche numérique programmée jusqu'à l'alias ou à l'ID prédéfini.

Si une touche numérique a été attribuée à une entrée dans un mode particulier, la fonction n'est pas prise en charge lorsque vous appuyez longuement sur la touche numérique dans un autre mode.

Une tonalité d'échec se fait entendre si la touche numérique n'a pas été attribuée à une entrée.

- 2 Pour passer l'appel, appuyez sur le bouton de conversation **PTT**.

Le voyant DEL vert s'allume. L'écran affiche l'icône **Appel indiv.** dans le coin supérieur droit. L'alias de l'appelant s'affiche sur la première ligne de l'écran. L'état de l'appel s'affiche sur la deuxième ligne de l'écran.

3 Relâchez le bouton **PTT** pour écouter.

Le voyant DEL vert clignote lorsque la radio cible répond. L'écran affiche l'alias de destination.

4 L'appel se termine lorsqu'il n'y a aucune activité vocale pendant une durée préprogrammée. Une courte tonalité retentit. L'écran affiche Appel terminé.

Le lanceur d'appel et le destinataire sont en mesure de mettre fin à un appel individuel en cours en appuyant sur .

Pour obtenir plus de renseignements à ce sujet, consultez la section [Association d'une entrée à une touche numérique programmable à la page 431](#).

Appels individuels faits à l'aide de la recherche d'alias

1 Appuyez sur pour accéder au menu.

2 Appuyez sur ou jusqu'à **Contacts**.

Appuyez sur  pour effectuer la sélection.

L'écran affiche les entrées dans l'ordre alphabétique.

3 Appuyez sur ou jusqu'à l'alias ou l'ID d'abonné voulu. La première ligne de l'écran affiche le message **Numéro de téléphone** :. La deuxième ligne de l'écran affiche un curseur clignotant. Utilisez le clavier pour entrer un numéro de téléphone.

4 Appuyez sur pour effectuer la sélection. Si l'entrée sélectionnée est vide, une tonalité d'indication négative se fait entendre et l'écran indique **No. Tél. Invalide**.

5 Appuyez sur ou pour un appel téléphonique, puis sur pour effectuer la sélection.. Si le code d'accès n'est pas préconfiguré dans la liste de contacts, la première ligne de l'écran indique **Code d'accès** :. La deuxième ligne de l'écran affiche un curseur clignotant. Entrez le code d'accès, puis appuyez sur

 pour continuer. En cas de réussite, la tonalité DTMF se fait entendre. Vous entendrez la tonalité de composition du téléphone de l'utilisateur. La première ligne de l'écran affiche l'alias ou l'ID d'abonné et l'icône **RSSI**. La deuxième ligne de l'écran affiche Appel tél. et l'icône d'**appel téléphonique**. En cas d'échec, une tonalité se fait entendre et l'écran affiche le message Appel tél. échoué. Votre radio retourne à l'écran de code d'accès. Si le code d'accès est préconfiguré dans la liste de contacts, la radio revient à l'écran affiché avant la tentative d'appel.

6 Appuyez sur la touche **PTT** pour parler et relâchez la touche pour écouter. L'icône **RSSI** disparaît lors de la transmission.

7 Pour entrer d'autres chiffres, si demandé durant l'appel, procédez de l'une des façons suivantes.

- Appuyez sur n'importe quelle touche pour commencer à entrer de nouveaux chiffres. La première ligne de l'écran affiche le message Chiffres suppl. :. La deuxième ligne de l'écran affiche un curseur clignotant. Entrez les chiffres supplémentaires, puis appuyez sur 

pour continuer. La tonalité DTMF se fait entendre et la radio revient à l'écran précédent.

- Appuyez sur la touche **Accès une touche**. La tonalité DTMF se fait entendre. Si la touche **Accès une touche** n'est pas programmée, une tonalité d'échec se fait entendre.

8 Appuyez sur  pour mettre fin à l'appel. Si le code de libération n'est pas préconfiguré dans la liste de contacts, la première ligne de l'écran indique Code de libération :. La deuxième ligne de l'écran affiche un curseur clignotant. Entrez le code

de libération, puis appuyez sur  pour continuer. La radio revient à l'écran précédent. La tonalité DTMF se fait entendre et l'écran affiche Fin de l'appel tél. En cas de réussite, une tonalité se fait entendre et l'écran affiche le message Appel tél. terminé. Votre radio retourne à l'écran d'appel téléphonique. En cas d'échec, votre radio retourne à l'écran d'appel téléphonique. Quand vous appuyez sur la touche **PTT** à l'écran Contacts tél, une tonalité se fait entendre et l'écran affiche le message App. OK pour placer appel. Lorsque l'utilisateur a terminé d'utiliser le téléphone, une tonalité se fait entendre et l'écran affiche le message

Fin appel tél. Si l'appel se termine pendant que vous entrez les autres chiffres demandés par l'appel téléphonique, la radio revient à l'écran affiché avant la tentative d'appel.



- 9 L'appel se termine lorsqu'il n'y a aucune activité vocale pendant une durée préprogrammée. Une courte tonalité retentit. L'écran affiche Appel terminé.

Le lanceur d'appel et le destinataire sont en mesure de mettre fin à un appel individuel en cours en appuyant sur .



AVIS:

Pendant l'accès à un canal, appuyez sur  pour mettre fin à la tentative d'appel et une tonalité se fait entendre ou pour quitter la recherche d'alias.

Appuyez sur la touche  ou  pour quitter la recherche d'alias. Pendant l'appel, lorsque vous appuyez sur la touche **Accès une touche**, si le code de non-accès est préconfiguré ou si vous entrez le code de non-accès en entrée pour les autres chiffres, la radio tentera de mettre fin à l'appel.

Appel individuel fait à l'aide du bouton de composition à une touche

La fonction d'appel direct vous permet de passer aisément un appel individuel à un alias ou ID d'appel individuel prédéfini. Vous pouvez attribuer cette fonction à une touche programmable avec une brève ou une longue pression.

Vous ne pouvez attribuer qu'un seul alias ou ID à un bouton d'appel direct. Vous pouvez programmer plusieurs boutons d'appel directs pour votre radio.

- 1 Appuyez sur le bouton d'**appel direct** programmé pour passer un appel individuel à un alias ou ID d'appel individuel prédéfini.
- 2 Pour passer l'appel, appuyez sur le bouton de conversation **PTT**.
Le voyant DEL passe au vert continu.
L'écran affiche l'alias ou l'ID d'appel individuel.
- 3 Attendez la fin de la tonalité d'autorisation de parler (si elle est activée) et parlez clairement dans le microphone.

4 Relâchez le bouton **PTT** pour écouter.

Lorsque la radio cible répond, le voyant DEL clignote en vert.

S'il n'y a aucune activité vocale pendant une durée préprogrammée, l'appel prend fin.



Le lanceur d'appel et le destinataire sont en mesure de mettre fin à un appel individuel en cours en



appuyant sur le bouton .

Appels individuels faits à l'aide de la numérotation manuelle

Suivez la procédure suivante pour passer des appels privés à l'aide de la numérotation manuelle à partir de la radio.



1 Appuyez sur  pour accéder au menu.

2 Appuyez sur  ou  jusqu'à **Contacts**.
Appuyez sur  pour effectuer la sélection.

3 Appuyez sur  ou  jusqu'à **Num. manuelle**. Appuyez sur  pour effectuer la sélection.

4 Appuyez sur  ou  jusqu'au **Numéro de la radio**. Appuyez sur  pour effectuer la sélection.

5 Faites un des suivants :

- Entrez l'ID de l'abonné et appuyez sur  pour continuer.
- Modifier les ID d'abonné composés précédemment et appuyez sur  pour continuer.

6 Pour passer l'appel, appuyez sur le bouton de conversation **PTT**.

Le voyant DEL vert s'allume. L'écran affiche l'alias de destination.

7 Attendez la fin de la tonalité d'autorisation de parler (si elle est activée) et parlez clairement dans le microphone.

8 Relâchez le bouton **PTT** pour écouter.

Le voyant DEL vert s'allume lorsque la radio cible répond. L'écran affiche l'alias ou l'ID de la radio émettrice.

9 Si l'indicateur Canal libre est activé, une courte tonalité d'avertissement se fait entendre lorsque l'utilisateur de la radio émettrice cesse d'appuyer sur le bouton **PTT**, vous indiquant que le canal est libre et que vous pouvez répondre. Pour prendre l'appel, appuyez sur le bouton **PTT**.

L'appel se termine lorsqu'il n'y a aucune activité vocale pendant une durée préprogrammée. Une tonalité se fait entendre. L'écran affiche Appel terminé.

Le lanceur d'appel et le destinataire sont en mesure de mettre fin à un appel individuel en cours en appuyant sur .

Réception d'un appel individuel

Lorsque vous recevez des appels individuels configurés comme un appel en mode établissement d'une connexion sans émission intégrale (OACSU) :

- Le voyant DEL vert clignote.
- Votre radio désactive la sourdine et l'appel entrant se fait entendre sur le haut-parleur.





AVIS:

Selon la configuration de votre radio, soit en mode appel individuel OACSU, soit en mode établissement d'une connexion sans émission intégrale (FOACSU), répondre à des appels individuels peut nécessiter ou non un accusé de réception de l'utilisateur.

Pour la configuration OACSU, la sourdine est désactivée et l'appel se connecte automatiquement.

Accepter des appels individuels

Lorsque vous recevez des appels individuels configurés comme un appel en mode établissement d'une connexion sans émission intégrale (FOACSU) :

- Le voyant DEL vert clignote.
- 1 Pour accepter un appel individuel configuré comme FOACSU, effectuez l'une des opérations suivantes :
 - Appuyez sur  ou  Accepter, puis appuyez sur  pour répondre à un appel individuel.
 - Appuyez sur le bouton **PTT** pour n'importe quelle entrée.

Le voyant DEL vert s'allume.

- 2 Attendez la fin de la tonalité d'autorisation de parler (si elle est activée) et parlez clairement dans le microphone.

- 3 Relâchez le bouton **PTT** pour écouter.

L'appel se termine lorsqu'il n'y a aucune activité vocale pendant une durée préprogrammée. Une tonalité se fait entendre. L'écran affiche Appel terminé.



AVIS:





Le lanceur d'appel et le destinataire sont en mesure de mettre fin à un appel individuel en cours en appuyant sur .

Refus des appels individuels

Lorsque vous recevez des appels individuels configurés comme un appel en mode établissement d'une connexion sans émission intégrale (FOACSU) :

- Le voyant DEL vert clignote.

Pour refuser un appel individuel configuré comme FOACSU, effectuez l'une des opérations suivantes :

- Appuyez sur  ou  Rejeter, puis appuyez sur  pour refuser un appel individuel.
- Appuyez sur  pour refuser un appel individuel.

Appels généraux

Un appel général est un appel effectué à partir d'une radio individuelle et destiné à toutes les radios présentes sur le site ou toutes les radios sur un groupe de sites, selon la configuration du système.

Un appel général sert à diffuser des annonces importantes qui sollicitent toute l'attention des utilisateurs. Les utilisateurs du système ne peuvent pas répondre à un appel général.

Le mode Capacity Max prend en charge l'appel général de site et appel général multisite. L'administrateur système peut configurer une ou les deux actions dans votre radio.



AVIS:

Les abonnés peuvent prendre en charge tous les appels de l'ensemble du système, mais l'infrastructure Motorola Solutions ne prend pas en charge tous les appels de l'ensemble du système.

Appel général

Votre radio doit avoir été préalablement programmée pour vous permettre de faire un appel général. Suivez la procédure suivante pour faire des appels généraux à partir de la radio.

- 1 Sélectionnez le canal qui correspond à l'alias ou à l'ID de groupe Appel général en surbrillance. Voir [Sélection d'un type d'appel à la page 66](#).
-

- 2 Pour passer l'appel, appuyez sur le bouton de conversation **PTT**.

Le voyant DEL vert s'allume. L'écran affiche l'icône **Appel de groupe** et Appel général, Appel général de site ou Appel multi-sites selon le type de configuration.

- 3 Faites un des suivants :

- Attendez la fin de la tonalité d'autorisation de parler (si elle est activée) et parlez clairement dans le microphone.
- Attendez la fin de l'effet local **PTT** (s'il est activé) et parlez clairement dans le microphone.

Les utilisateurs du canal ne peuvent pas répondre à l'appel général.

L'initiateur de l'appel peut appuyer sur  pour mettre fin à tous les appels.

Appels généraux faits à l'aide de la touche numérique programmable

Suivez la procédure suivante pour passer des appels généraux à l'aide de la touche numérique programmable.

- 1 À partir de l'écran d'accueil, appuyez longuement sur la touche numérique programmée jusqu'à l'alias ou à l'ID prédéfini.

Si une touche numérique a été attribuée à une entrée dans un mode particulier, la fonction n'est pas prise en charge lorsque vous appuyez longuement sur la touche numérique dans un autre mode.

Une tonalité d'échec se fait entendre si la touche numérique n'a pas été attribuée à une entrée.

- 2 Pour passer l'appel, appuyez sur le bouton de conversation **PTT**.

Le voyant DEL vert s'allume. L'écran affiche **Appel de groupe** et Appel général, Appel général de site ou Appel multisite selon le type de configuration.

- 3 Faites un des suivants :



- Attendez la fin de la tonalité d'autorisation de parler (si elle est activée) et parlez clairement dans le microphone.
- Attendez la fin de l'effet local **PTT** (s'il est activé) et parlez clairement dans le microphone.

L'initiateur de l'appel peut appuyer sur  pour mettre fin à tous les appels.

Pour obtenir plus de renseignements à ce sujet, consultez la section [Association d'une entrée à une touche numérique programmable](#) à la page 431.









Appels généraux faits à l'aide de la recherche d'alias

- 1 Appuyez sur  pour accéder au menu.

- 2 Appuyez sur  ou  jusqu'à Contacts.

Appuyez sur  pour effectuer la sélection.

L'écran affiche les entrées dans l'ordre alphabétique.

- 3** Appuyez sur  ou  jusqu'à l'alias ou l'ID d'abonné voulu. La première ligne de l'écran affiche le message `Numéro de téléphone :`. La deuxième ligne de l'écran affiche un curseur clignotant. Utilisez le clavier pour entrer un numéro de téléphone.
-
- 4** Appuyez sur  pour effectuer la sélection. Si l'entrée sélectionnée est vide, une tonalité d'indication négative se fait entendre et l'écran indique `No. Tél. Invalide`.
-
- 5** Appuyez sur  ou  jusqu'à Appeler. Appuyez sur  pour effectuer la sélection. Si le code d'accès n'est pas préconfiguré dans la liste de contacts, la première ligne de l'écran indique `Code d'accès :`. La deuxième ligne de l'écran affiche un curseur clignotant. Entrez le code d'accès, puis appuyez sur  pour continuer. En cas de réussite, la tonalité DTMF se fait entendre. Vous entendrez la tonalité de composition du téléphone de l'utilisateur. La première ligne de l'écran affiche l'alias ou l'ID d'abonné et l'icône RSSI. La deuxième ligne de l'écran affiche `Appel tél.` et l'icône
- d'appel téléphonique. En cas d'échec, une tonalité se fait entendre et l'écran affiche le message `Appel tél. échoué`. Votre radio retourne à l'écran de code d'accès. Si le code d'accès est préconfiguré dans la liste de contacts, la radio revient à l'écran affiché avant la tentative d'appel.
-
- 6** Appuyez sur la touche **PTT** pour parler et relâchez la touche pour écouter. L'icône RSSI disparaît lors de la transmission.
-
- 7** Pour entrer d'autres chiffres, si demandé durant l'appel, procédez de l'une des façons suivantes.
- Appuyez sur n'importe quelle touche pour commencer à entrer de nouveaux chiffres. La première ligne de l'écran affiche le message `Chiffres suppl. :`. La deuxième ligne de l'écran affiche un curseur clignotant. Entrez les chiffres supplémentaires, puis appuyez sur  pour continuer. La tonalité DTMF se fait entendre et la radio revient à l'écran précédent.
 - Appuyez sur la touche **Accès une touche**. La tonalité DTMF se fait entendre. Si la touche **Accès une touche** n'est pas programmée, une tonalité d'échec se fait entendre.
-

8 Appuyez sur  pour mettre fin à l'appel. Si le code de libération n'est pas préconfiguré dans la liste de contacts, la première ligne de l'écran indique Code de libération :. La deuxième ligne de l'écran affiche un curseur clignotant. Entrez le code

de libération, puis appuyez sur  pour continuer. La radio revient à l'écran précédent. La tonalité DTMF se fait entendre et l'écran affiche Fin de l'appel tél. En cas de réussite, une tonalité se fait entendre et l'écran affiche le message Appel tél. terminé. Votre radio retourne à l'écran d'appel téléphonique. En cas d'échec, votre radio retourne à l'écran d'appel téléphonique. Quand vous appuyez sur la touche **PTT** à l'écran Contacts tél, une tonalité se fait entendre et l'écran affiche le message App. OK pour placer appel. Lorsque l'utilisateur a terminé d'utiliser le téléphone, une tonalité se fait entendre et l'écran affiche le message Fin appel tél. Si l'appel se termine pendant que vous entrez les autres chiffres demandés par l'appel téléphonique, la radio revient à l'écran affiché avant la tentative d'appel.



AVIS:

L'initiateur de l'appel peut appuyer sur  pour mettre fin à tous les appels.

Réception d'un appel général

Lorsque vous recevez un appel général, voici ce qui arrive :

- Une tonalité se fait entendre.
- Le voyant DEL vert clignote.
- L'icône **Appel de groupe** s'affiche dans le coin droit supérieur de l'écran.
- L'ID de l'appelant s'affiche sur la première ligne de l'écran.
- La deuxième ligne affiche Appel général, Appel général de site ou Appel multisite selon le type de configuration.
- Votre radio désactive la sourdine et l'appel entrant se fait entendre sur le haut-parleur.

À la fin de l'appel, la radio revient à l'écran affiché avant la réception de l'appel général.

Si l'indicateur Canal libre est activé, une courte tonalité d'avertissement se fait entendre lorsque l'utilisateur de la

radio émettrice cesse d'appuyer sur le bouton **PTT**, ce qui indique que le canal est libre et que vous pouvez répondre. Vous ne pouvez pas répondre à un appel général.



AVIS:

La radio interrompt la réception de l'appel général si vous changez de canal pendant l'appel. Pendant un appel général, vous ne pouvez pas naviguer ni faire de changements tant que l'appel est en cours.

Appels téléphoniques

Un appel téléphonique est un appel entre une radio individuelle ou un groupe de radios et un téléphone.

Selon la façon dont la radio est configurée, les fonctions suivantes peuvent être disponibles ou non :

- Doubles tonalités multi-fréquence (DTMF)
- Code de non-accès
- Affichage de l'alias ou de l'ID de l'appelant sur réception d'un appel téléphonique
- Possibilité de refuser ou d'accepter un appel téléphonique

La capacité d'appel téléphonique peut être activée par l'attribution et la configuration des numéros de téléphone

sur le système. Vérifiez auprès de votre administrateur système pour savoir de quelle façon votre radio a été programmée.

Exécution d'un appel téléphonique

Suivez la procédure suivante pour faire des appels téléphoniques à partir de la radio.

- 1 Appuyez sur la touche programmée **Accès une touche** pour l'alias ou l'ID prédéfini.

Si la touche **Accès une touche** n'est pas programmée, une tonalité d'échec se fait entendre.

Si le code d'accès n'est pas préconfiguré dans la liste de contacts, l'écran affiche le message `Code d'accès :`.

- 2 Entrez le code d'accès, puis appuyez sur  pour continuer.

Le code d'accès ou de non-accès ne peut dépasser 10 caractères.

- 3 Pour prendre l'appel, appuyez sur le bouton **PTT**.
-

4 Relâchez le bouton **PTT** pour écouter.

5 Saisissez des chiffres supplémentaires à l'aide du clavier si l'appel le demande et appuyez sur  pour continuer.

Si l'appel se termine pendant que vous entrez les autres chiffres demandés par l'appel, la radio revient à l'écran affiché avant la tentative d'appel.

La tonalité DTMF se fait entendre. La radio revient à l'écran précédent.

6 Appuyez sur  pour mettre fin à l'appel.

7 Faites un des suivants :

- Si le code de non-accès n'est pas préconfiguré, entrez le code de non-accès lorsque l'écran affiche `Code de non-accès :`, puis appuyez sur  pour continuer. La radio revient à l'écran précédent.
- Appuyez sur la touche d'**accès direct** programmée. Si la touche **Accès une touche**

n'est pas programmée, une tonalité d'échec se fait entendre.

La tonalité DTMF se fait entendre et l'écran affiche `Fin de l'appel téléphonique.`

Si l'appel se termine avec succès :



- Une tonalité se fait entendre.
- L'écran affiche `Appel terminé.`

Si l'appel échoue, la radio revient à l'écran d'appel téléphonique. Répétez les deux dernières étapes qui précèdent ou attendez que l'utilisateur du téléphone mette fin à l'appel.

Acheminement d'appels téléphoniques à l'aide de la touche programmable

Suivez la procédure pour passer un appel téléphonique à l'aide de la touche programmable.

- 1 Appuyez sur la touche programmée **Téléphone** pour accéder au répertoire téléphonique.
-

2 Appuyez sur  ou  jusqu'à l'alias ou l'ID voulu. Appuyez sur  pour effectuer la sélection.

Si le code d'accès n'est pas préconfiguré dans la liste de contacts, l'écran affiche le message **Code d'accès:**. Entrez le code d'accès, puis appuyez sur  pour continuer.

Le voyant DEL vert s'allume. L'écran affiche l'icône **Appel tél**, l'alias de l'abonné ou son ID et l'état de l'appel.

Si la configuration d'appel réussit :

- La tonalité DTMF se fait entendre.
- Vous entendrez la tonalité d'appel en attente de l'utilisateur du téléphone.
- L'écran affiche l'icône **Appel tél**, l'alias de l'abonné ou son ID, **Appel tél** et l'état de l'appel.

Si la configuration d'appel échoue :

- Une tonalité se fait entendre.
- L'écran affiche **Appel tél. échoué**.

- Votre radio retourne à l'écran de code d'accès. Si le code d'accès est préconfiguré dans la liste de contacts, la radio revient à l'écran affiché avant la tentative d'appel.

3 Appuyez sur la touche **PTT** pour parler. Relâchez le bouton **PTT** pour écouter. L'icône RSSI disparaît lors de la transmission.

4 Pour entrer d'autres chiffres, si demandé durant l'appel. Faites un des suivants :

- Appuyez sur n'importe quelle touche pour commencer à entrer de nouveaux chiffres. L'écran affiche **Chiffres suppl.:** et un curseur clignotant. Entrez les chiffres supplémentaires, puis appuyez sur  pour continuer. La tonalité DTMF se fait entendre et la radio revient à l'écran précédent.
 - Appuyez sur la touche **Accès une touche**. La tonalité DTMF se fait entendre. Si la touche **Accès une touche** n'est pas programmée, une tonalité d'échec se fait entendre.
-

5 Appuyez sur  pour mettre fin à l'appel.

Si le code de nonaccès n'est pas préconfiguré dans la liste de contacts, l'écran affiche `Code de libération:`. Entrez le code de retrait d'accès, puis appuyez sur  pour continuer.

La tonalité DTMF se fait entendre et l'écran affiche `Fin de l'appel tél.`

En cas de réussite de la configuration de fin d'appel, une tonalité se fait entendre et l'écran affiche le message `Appel tél. terminé.`

En cas d'échec de la préparation de l'appel, votre radio retourne à l'écran d'appel téléphonique.

Quand vous appuyez sur la touche **PTT** lorsque l'écran des contacts téléphoniques est affiché, une tonalité se fait entendre et l'écran affiche le message `App. OK pour placer appel.`

Lorsque l'utilisateur a terminé d'utiliser le téléphone, une tonalité se fait entendre et l'écran affiche le message `Fin appel tél.`

Si l'appel se termine pendant que vous entrez les autres chiffres demandés par l'appel téléphonique, la radio revient à l'écran affiché avant la tentative d'appel.



AVIS:

Pendant un accès à un canal, appuyez sur

 pour mettre fin à la tentative d'appel (une tonalité se fait entendre).

Pendant l'appel, lorsque vous appuyez sur la touche **Accès une touche**, si le code de nonaccès est préconfiguré ou si vous entrez le code de nonaccès en entrée pour les autres chiffres, la radio tentera de mettre fin à l'appel.

Pendant l'accès à un canal et la transmission du code d'accès/nonaccès ou d'chiffres, seuls les boutons **Marche/Arrêt**, **Volume/ Marche/Arrêt Bouton de volume** et **Canal précédent/suivantSélecteur de canal** répondent. Une tonalité se fait entendre pour toutes les entrées non valides.

Appels téléphoniques faits à l'aide de la liste de contacts

Suivez la procédure suivante pour passer des appels téléphoniques à l'aide de la liste de contacts à partir de la radio.

1 Appuyez sur  pour accéder au menu.

2 Appuyez sur  ou  jusqu'à

Contacts. Appuyez sur  pour effectuer la sélection.

L'écran affiche les entrées dans l'ordre alphabétique.



3 Appuyez sur  ou  jusqu'à l'alias ou l'ID voulu. Appuyez sur  pour effectuer la sélection.

Lorsque vous appuyez sur le bouton **PTT** pendant que vous êtes sur l'écran Contacts téléphoniques :

- Une tonalité d'échec se fait entendre.
- L'écran affiche App. OK pour placer appel.

Si l'entrée sélectionnée est vide :

- Une tonalité d'échec se fait entendre.
- L'écran affiche No d'appel téléphonique non valide.

4 Appuyez sur  ou  jusqu'à Appeler.

Appuyez sur  pour effectuer la sélection.

L'écran affiche Code d'accès : si le code d'accès n'est pas préconfiguré.

5 Entrez le code d'accès, puis appuyez sur  pour continuer.

Le code d'accès ou de nonaccès ne peut dépasser 10 caractères.

L'écran affiche Appels, l'alias ou l'ID de l'abonné et l'icône **Appel tél.**

Si l'appel est réussi :

- La tonalité DTMF se fait entendre.
- Vous entendrez la tonalité d'appel en attente de l'utilisateur du téléphone.

- L'écran affiche l'alias ou l'ID de l'abonné, l'icône **Appel tél** et Appel tél.

Si l'appel n'est pas réussi :

- Une tonalité se fait entendre.
- L'écran affiche Échec de l'appel téléphonique, puis, Code d'accès :.
- Si le code d'accès a été préconfiguré dans la liste de contacts, la radio revient à l'écran précédent la tentative d'appel.

6 Pour prendre l'appel, appuyez sur le bouton **PTT**.
L'icône **RSSI** disparaît.

7 Relâchez le bouton **PTT** pour écouter.

8 Saisissez des chiffres supplémentaires à l'aide du clavier si l'appel le demande et appuyez sur  pour continuer.
Si l'appel se termine pendant que vous entrez les autres chiffres demandés par l'appel téléphonique, la

radio revient à l'écran affiché avant la tentative d'appel.

La tonalité DTMF se fait entendre. La radio revient à l'écran précédent.

9 Appuyez sur  pour mettre fin à l'appel.

10 Si le code de non-accès n'est pas préconfiguré, entrez le code de non-accès lorsque l'écran affiche

Code de non-accès :, puis appuyez sur  pour continuer.

La radio revient à l'écran précédent. La tonalité DTMF se fait entendre et l'écran affiche Fin de l'appel téléphonique.

Si l'appel se termine avec succès :

- Une tonalité se fait entendre.
- L'écran affiche Appel terminé.

Si l'appel échoue, la radio revient à l'écran d'appel téléphonique. Répétez [étape 9](#) et [étape 10](#) ou attendez que l'utilisateur du téléphone ait terminé l'appel. Quand vous appuyez sur la touche PTT lorsque l'écran des contacts téléphoniques est

affiché, une tonalité se fait entendre et l'écran affiche App. OK pour placer appel.

Lorsque l'utilisateur a terminé d'utiliser le téléphone, une tonalité se fait entendre et l'écran affiche le message Fin appel tél.

Si l'appel se termine pendant que vous entrez les autres chiffres demandés par l'appel téléphonique, la radio revient à l'écran affiché avant la tentative d'appel.



AVIS:

Pendant un accès à un canal, appuyez sur  pour mettre fin à la tentative d'appel (une tonalité se fait entendre).



Pendant l'appel, lorsque vous appuyez sur la touche **Accès une touche**, si le code de non-accès est préconfiguré ou si vous entrez le code de non-accès en entrée pour les autres chiffres, la radio tentera de mettre fin à l'appel.



Pendant l'accès à un canal, à un code d'accès/de libération ou encore lors d'une transmission d'autres chiffres, seuls les boutons **Marche/Arrêt**, **Réglage du volume** et le **sélecteur de canal** sont actifs. Une tonalité se fait entendre pour toutes les entrées non valides.

Appels téléphoniques faits à l'aide de la recherche d'alias



Vous pouvez également utiliser un alias ou une recherche alphanumérique pour récupérer l'alias d'un abonné. Cette fonction n'est accessible qu'au moyen de la liste des contacts. Suivez la procédure suivante pour passer des appels à l'aide de la recherche d'alias à partir de la radio.

- 1 Appuyez sur  pour accéder au menu.

- 2 Appuyez sur  ou  jusqu'à `Contacts`. Appuyez sur  pour effectuer la sélection.
L'écran affiche les entrées dans l'ordre alphabétique.

- 3 Appuyez sur  ou  jusqu'à l'alias ou l'ID d'abonné voulu.

- 4 Appuyez sur  pour effectuer la sélection. Si l'entrée sélectionnée est vide, une tonalité d'indication négative se fait entendre et l'écran indique `No. Tél. Invalide`.

- 5 Appuyez sur  ou  jusqu'à Appeler.
Appuyez sur  pour effectuer la sélection.
Si le code d'accès n'est pas préconfiguré dans la liste des contacts, l'écran affiche `Code d'accès:` et

un curseur clignotant. Entrez le code d'accès, puis appuyez sur  pour continuer.

En cas de réussite :

- La tonalité DTMF se fait entendre.
- Vous entendrez la tonalité d'appel en attente de l'utilisateur du téléphone.
- L'écran affiche l'alias ou l'ID de l'abonné, l'icône **RSSI**, `Appel tél` et l'icône **Appel tél**.

En cas d'échec :

- Une tonalité se fait entendre.
- L'écran affiche `Appel tél. échoué`.
- Votre radio retourne à l'écran de code d'accès. Si le code d'accès est préconfiguré dans la liste de contacts, la radio revient à l'écran affiché avant la tentative d'appel.

-
- 6 Appuyez sur la touche **PTT** pour parler et relâchez la touche pour écouter. L'icône **RSSI** disparaît lors de la transmission.
-

- 7 Pour entrer d'autres chiffres, si demandé durant l'appel, procédez de l'une des façons suivantes.

- Appuyez sur n'importe quelle touche pour commencer à entrer de nouveaux chiffres. L'écran affiche `Chiffres suppl.:` et un curseur clignotant. Entrez les chiffres supplémentaires, puis appuyez sur  pour continuer. La tonalité DTMF se fait entendre
- Appuyez sur la touche **Accès une touche**. La tonalité DTMF se fait entendre. Si l'entrée de la touche **Accès une touche** est vide, une tonalité d'échec se fait entendre et la radio revient à l'écran précédent.

8 Appuyez sur  pour mettre fin à l'appel.

Si le code de nonaccès n'est pas préconfiguré dans la liste des contacts, l'écran affiche `Code de libération:` et un curseur clignotant. Entrez le code de retrait d'accès, puis appuyez sur  pour continuer.

La radio revient à l'écran précédent. La tonalité DTMF se fait entendre et l'écran affiche `Fin de l'appel tél.`

En cas de réussite :



- Une tonalité se fait entendre.
- L'écran affiche `Appel tél. terminé.`
- Votre radio retourne à l'écran d'appel téléphonique.

En cas d'échec :

- Votre radio retourne à l'écran d'appel téléphonique.
- Quand vous appuyez sur la touche **PTT** à l'écran `Contacts tél`, une tonalité se fait entendre et l'écran affiche le message `App. OK pour placer appel.`
- Lorsque l'utilisateur a terminé d'utiliser le téléphone, une tonalité se fait entendre et l'écran affiche le message `Fin appel tél.`
- Si l'appel se termine pendant que vous entrez les autres chiffres demandés par l'appel téléphonique, la radio revient à l'écran affiché avant la tentative d'appel.

**AVIS:**



Pendant l'accès à un canal, appuyez sur  pour mettre fin à la tentative d'appel et une tonalité se fait entendre ou pour quitter la recherche d'alias.



Appuyez sur la touche  ou  pour quitter la recherche d'alias. Pendant l'appel, lorsque vous appuyez sur la touche **Accès une touche**, si le code de non-accès est préconfiguré ou si vous entrez le code de non-accès en entrée pour les autres chiffres, la radio tentera de mettre fin à l'appel. Pendant l'accès à un canal, à un code d'accès/retrait d'accès ou encore lors d'une transmission d'autres chiffres, seuls les boutons Marche/Arrêt, Réglage du volume et le sélecteur de canal sont actifs. Une tonalité se fait entendre pour toutes les entrées non valides.



Appels téléphoniques faits à l'aide de la numérotation manuelle

Suivez la procédure suivante pour passer des appels téléphoniques à l'aide de la numérotation manuelle à partir de la radio.

- 1 Appuyez sur  pour accéder au menu.

- 2 Appuyez sur  ou  jusqu'à Contacts. Appuyez sur  pour effectuer la sélection.

- 3 Appuyez sur  ou  jusqu'à Numérotation manuelle. Appuyez sur  pour effectuer la sélection.

- 4 Appuyez sur  ou  jusqu'au Numéro de téléphone. Appuyez sur  pour effectuer la sélection.
L'écran affiche Numéro : et un curseur clignotant.

- 5 Saisissez le numéro de téléphone, puis appuyez sur  pour continuer.
L'écran affiche Code d'accès : et un curseur clignotant si le code d'accès n'est pas préconfiguré.

- 6 Entrez le code d'accès, puis appuyez sur  pour continuer. Le code d'accès ou de non-accès ne peut dépasser 10 caractères.

Le voyant DEL vert s'allume. L'écran affiche l'icône **Appel tél.**, l'alias de l'abonné et l'état de l'appel.

Si l'appel est réussi :

- La tonalité DTMF se fait entendre.
- Vous entendrez la tonalité d'appel en attente de l'utilisateur du téléphone.
- L'écran affiche l'alias de l'abonné et l'icône **Appel tél.**

Si l'appel n'est pas réussi :

- Une tonalité se fait entendre.
- L'écran affiche Échec de l'appel téléphonique, puis, Code d'accès :.
- Si le code d'accès a été préconfiguré dans la liste de contacts, la radio revient à l'écran précédant la tentative d'appel.

-
- 7 Appuyez sur  pour mettre fin à l'appel.
-

- 8 Faites un des suivants :

- Si le code de non-accès n'est pas préconfiguré, entrez le code de non-accès lorsque l'écran affiche Code de non-accès :, puis appuyez sur  pour continuer. La radio revient à l'écran précédent.
- Appuyez sur la touche d'**accès direct** programmée. Si la touche **Accès une touche** n'est pas programmée, une tonalité d'échec se fait entendre.

La tonalité DTMF se fait entendre et l'écran affiche Fin de l'appel téléphonique.

Si l'appel se termine avec succès :

- Une tonalité se fait entendre.
- L'écran affiche Appel terminé.

Si l'appel échoue, la radio revient à l'écran d'appel téléphonique. Répétez [étape 7](#) ou attendez que l'utilisateur du téléphone mette fin à l'appel.

**AVIS:**

Quand vous appuyez sur la touche **PTT** lorsque vous êtes dans l'écran de contacts, une tonalité de réussite se fait entendre et l'écran affiche le message Appuyez sur OK pour placer appel.

Lorsque l'utilisateur a terminé d'utiliser le téléphone, une tonalité de réussite se fait entendre et l'écran affiche le message Appel terminé.

Si l'appel se termine pendant que vous entrez les autres chiffres demandés par l'appel téléphonique, la radio revient à l'écran affiché avant la tentative d'appel.

Pendant un accès à un canal, appuyez sur

 pour mettre fin à la tentative d'appel (une tonalité se fait entendre).

Pendant l'appel, lorsque vous appuyez sur la touche **Accès une touche**, si le code de nonaccès est préconfiguré ou si vous entrez le code de nonaccès en entrée pour les autres chiffres, la radio tentera de mettre fin à l'appel.

Pendant l'accès à un canal, à un code d'accès/de libération ou encore lors d'une transmission d'autres chiffres, seuls les boutons **Marche/Arrêt**, **Réglage du volume** et le **sélecteur de canal** sont actifs. Une tonalité se fait entendre pour toutes les entrées non valides.

Multifréquence à deux tonalités

La fonction Multifréquence à deux tonalités (DTMF) permet d'utiliser un système radio doté d'une interface de système téléphonique.



Vous pouvez désactiver la tonalité DTMF en désactivant toutes les tonalités et alertes de la radio. Pour obtenir plus de renseignements à ce sujet, consultez la section [Activation ou désactivation des sonneries et alertes de la radio à la page 215](#).

Exécution d'un appel DTMF

Suivez la procédure suivante pour faire des appels DTMF à partir de la radio.

1 Maintenez le bouton de transmission **PTT** enfoncé.

2 Faites un des suivants :

- Entrez le numéro voulu pour faire un appel DTMF.
 - Appuyez sur  pour faire un appel DTMF.
 - Appuyez sur  pour faire un appel DTMF.
-

Réponse à un appel téléphonique en mode appel général

Lorsque vous recevez un appel téléphonique en tant qu'appel général, la radio réceptrice ne peut pas parler ou répondre. L'utilisateur destinataire n'est pas non plus autorisé à mettre fin à l'appel général.

Si vous recevez un appel téléphonique en tant qu'appel général :

- L'écran affiche l'icône **Appel téléphonique** dans le coin supérieur droit.
- L'écran affiche Appel général, Appel général de site ou Appel multisite selon le type de configuration et l'Appel téléphonique.

- Le voyant DEL vert clignote.
- Votre radio désactive la sourdine et l'appel entrant se fait entendre sur le haut-parleur.

Réponse à un appel téléphonique en mode appel de groupe

Suivez la procédure suivante pour répondre à un appel téléphonique en mode appel de groupe sur votre radio.

Si vous recevez un appel téléphonique en tant qu'appel de groupe :

- L'écran affiche l'icône **Appel tél** et Appel tél.
- Le voyant DEL vert clignote.
- Votre radio désactive la sourdine et l'appel entrant se fait entendre sur le haut-parleur.

1 Pour prendre l'appel, appuyez sur le bouton **PTT**.

2 Relâchez le bouton **PTT** pour écouter.

3 Appuyez sur  pour mettre fin à l'appel.

**AVIS:**

Votre radio n'est pas en mesure de mettre fin à un appel téléphonique en tant qu'appel de groupe. L'utilisateur du téléphone doit mettre fin à l'appel. L'utilisateur destinataire est uniquement autorisé à répondre au cours de l'appel.

L'écran affiche `Fin de l'appel tél.`

Si l'appel se termine avec succès :

- Une tonalité se fait entendre.
- L'écran affiche `Appel terminé.`

Si l'appel échoue, la radio revient à l'écran d'appel téléphonique. Répétez [étape 3](#) ou attendez que l'utilisateur du téléphone mette fin à l'appel.

- L'écran affiche l'icône **Appel tél** et `Appel tél.`
- Le voyant DEL vert clignote.
- Votre radio désactive la sourdine et l'appel entrant se fait entendre sur le haut-parleur.

1 Pour prendre l'appel, appuyez sur le bouton **PTT**.

2 Relâchez le bouton **PTT** pour écouter.

3 Appuyez sur  pour mettre fin à l'appel.

**AVIS:**

Votre radio n'est pas en mesure de mettre fin à un appel téléphonique en tant qu'appel de groupe. L'utilisateur du téléphone doit mettre fin à l'appel. L'utilisateur destinataire est uniquement autorisé à répondre au cours de l'appel.

L'écran affiche `Fin de l'appel tél.`

Si l'appel se termine avec succès :

- Une tonalité se fait entendre.
- L'écran affiche `Appel terminé.`

Réponse à un appel téléphonique en mode Appel individuel

Suivez la procédure suivante pour répondre à un appel téléphonique en mode Appel individuel sur votre radio.

Si vous recevez un appel téléphonique en tant qu'appel individuel :

Si l'appel échoue, la radio revient à l'écran d'appel téléphonique. Répétez [étape 3](#) ou attendez que l'utilisateur du téléphone mette fin à l'appel.

Priorité d'appel

La Priorité d'appel permet à une radio d'arrêter toute transmission vocale en cours et de lancer une transmission prioritaire.

Grâce à la fonction Priorité d'appel, le système des interrompt et place en priorité des appels en cours dans les cas où les canaux de ressources partagées sont indisponibles.

Des appels de priorité plus élevée, comme un appel d'urgence ou un appel général passent en priorité sur la radio à l'origine de la transmission afin de répondre à l'appel de priorité supérieure. En l'absence d'autres canaux de radiofréquence (RF) disponibles, un appel d'urgence passe en priorité sur un appel général aussi.

Interruption vocale

L'interruption vocale permet à l'utilisateur d'arrêter une transmission vocale en cours.

Cette fonction utilise la composition de canal inverse pour arrêter la transmission vocale en cours d'une radio, si la radio interrompue est configurée pour l'interruption vocale et que la radio émettrice est configurée pour pouvoir interrompre un appel vocal. La radio interrompue est alors autorisée à émettre une transmission vocale vers le participant dont l'appel est arrêté.

La fonction Interruption vocale améliore considérablement la probabilité de fournir une nouvelle transmission selon aux parties visées lorsqu'un appel est en cours.

L'utilisateur a accès à l'interruption vocale uniquement si cette fonction a été configurée. Pour obtenir des renseignements supplémentaires, adressez-vous à votre détaillant ou à votre administrateur de système.

Activation de l'interruption vocale

Suivez la procédure pour activer la fonction Interruption vocale sur votre radio.

Votre radio doit être programmée de manière à vous permettre d'utiliser cette fonction. Pour obtenir des renseignements supplémentaires, adressez-vous à votre détaillant ou à votre administrateur de système.

- 1 Pour interrompre la transmission pendant un appel, appuyez sur le bouton **PTT**.

Sur la radio interrompue, l'écran affiche `Appel terminé`. Une tonalité d'échec retentit tant que le bouton **PTT** n'est pas relâché.

- 2 Attendez la confirmation.

En cas de réussite :

- Une tonalité de réussite se fait entendre.

En cas d'échec :

- Une tonalité d'échec se fait entendre.
-

- 3 Faites un des suivants :

- Attendez la fin de la tonalité d'autorisation de parler (si elle est activée) et parlez clairement dans le microphone.
 - Attendez la fin de l'effet local **PTT** (s'il est activé) et parlez clairement dans le microphone.
-

Fonctions avancées

Ce chapitre décrit le fonctionnement des fonctions disponibles sur votre radio.

Cependant, votre détaillant ou l'administrateur de votre système peut avoir personnalisé votre radio en fonction de vos besoins particuliers. Pour obtenir des renseignements supplémentaires, adressez-vous à votre détaillant ou à votre administrateur de système.

Files d'attente d'appels

Lorsqu'il n'y a pas de ressources disponibles pour traiter un appel, les files d'attente d'appels permettent de placer la demande d'appel dans la file d'attente du système pour les prochaines ressources disponibles.

Vous entendez une tonalité de file d'attente d'appels après avoir appuyé sur le bouton **PTT** et l'écran de la radio affiche `Attente appel`, ce qui indique que la radio est passée à l'état de file d'attente d'appels. Le bouton **PTT** peut être relâché dès que la tonalité de File d'attente d'appels se fait entendre.

Si la configuration de l'appel est établie, ce qui suit se produit :

- Le voyant DEL vert clignote.
- Si cette option est activée, la tonalité d'autorisation se fait entendre.
- L'écran affiche l'icône du type d'appel, l'ID ou l'alias.
- L'utilisateur de la radio a jusqu'à 4 secondes pour appuyer sur le bouton **PTT** pour commencer transmission vocale.

Si la configuration de l'appel échoue, ce qui suit se produit :

- Si cette option est activée, la tonalité de rejet se fait entendre.
- L'écran affiche l'avis d'échec pendant un court instant.
- L'appel est terminé et la radio quitte la configuration des appels.

Appel prioritaire

La fonction d'appel prioritaire permet au système de traiter en priorité un des appels non prioritaires sortants et d'initier l'appel à priorité élevée demandé lorsque tous les canaux sont occupés.

Quand tous les canaux sont occupés à traiter des appels à priorité élevée, le système ne traite aucun appel en priorité et place l'appel à priorité élevée d'origine dans la file

d'attente des appels. Si le système ne réussit pas à placer l'appel à priorité élevée d'origine dans la file d'attente des appels, il génère un avis d'échec.

Les paramètres par défaut pour la fonction d'appel prioritaire sont préconfigurés. Appuyez sur le bouton programmable pour basculer entre les niveaux de priorité normal et élevé. Lorsque vous utilisez les fonctions suivantes, le niveau de priorité de l'appel revient automatiquement au réglage préconfiguré.

- Tous les appels vocaux
- Message texte DMR III/Message texte
- Bon de travail
- Écoute à distance



AVIS:

Vérifiez auprès du détaillant ou de votre administrateur de système pour savoir de quelle façon votre radio a été programmée.

Les éléments suivants sont les types d'appel prioritaire :

Priorité élevée

La radio affiche Appel suivant : Priorité élevée.

L'icône **Priorité d'appel élevée** s'affiche dans le haut de l'écran de votre radio.

L'annonce vocale Appel suivant se fait entendre :
Priorité élevée.

Priorité normale

La radio affiche Appel suivant : Prior. normale.

L'icône **Priorité d'appel élevée** disparaît.

L'annonce vocale Appel suivant se fait entendre :
Priorité normale.

Balayage de groupe d'appels

Cette fonction permet à votre radio d'écouter et de joindre des appels pour des groupes définis dans une liste de groupe d'appels de réception.

Lorsque la fonction de balayage est activée, l'icône de balayage apparaît dans la barre d'état et le voyant DEL clignote en jaune. Votre radio désactive tous les membres de sa liste de groupe de réception.

Lorsque le balayage est désactivé, votre radio ne reçoit pas de transmission d'un membre de la liste de groupe de réception, sauf pour l'appel et le groupe sélectionné.







AVIS:



Balayage de groupe peut être configuré par le CPS. Vérifiez auprès de votre administrateur système pour savoir de quelle façon votre radio a été programmée.



Activer ou désactiver le balayage de groupe

Suivez la procédure suivante pour activer ou désactiver le balayage de groupe sur votre radio.

- 1 Appuyez sur  pour accéder au menu.

- 2 Appuyez sur  ou  jusqu'à Balayer.
Appuyez sur  pour effectuer la sélection.

- 3 Faites un des suivants :
 - Appuyez sur  ou  jusqu'à Activer.
Appuyez sur  pour effectuer la sélection.

- Appuyez sur  ou  jusqu'à Eteindre.
- Appuyez sur  pour effectuer la sélection.

Si le balayage est activé :

- L'écran affiche **Balayage** activé et l'icône **Balayage**.
- Le voyant DEL jaune clignote.
- Une tonalité de réussite se fait entendre.

Si le balayage est désactivé :

- L'écran affiche **Balayage** désactivé.
- L'icône de **balayage** disparaît.
- Le voyant DEL s'éteint.
- Une tonalité d'échec se fait entendre.

Liste de groupe de réception

La Liste de groupe de réception flexible vous permet de créer et d'affecter des membres à la liste de groupe de réception.

Cette liste est créée lors de la programmation de votre radio et détermine les groupes qui peuvent être balayés. Votre radio peut prendre en charge un maximum de 16 membres dans la liste.

Si votre radio a été programmée pour vous permettre de modifier la liste de balayage, vous pouvez :

- Ajouter ou supprimer des groupes.
- Ajouter, supprimer ou modifier la priorité des groupes. Reportez-vous à la section [Modifier l'ordre de priorité d'un groupe d'appels à la page 111](#).
- Ajouter, supprimer ou modifier l'affiliation des groupes. Reportez-vous à [Ajout d'affiliation de groupe à la page 113](#) et à [Suppression de l'affiliation de groupe à la page 114](#).
- Remplacer la liste de balayage avec une nouvelle liste de balayage.



IMPORTANT:

Pour ajouter des membres dans la liste, le groupe doit d'abord être configuré dans la radio.



AVIS:

Cette dernière est programmée par l'administrateur système. Pour obtenir des renseignements supplémentaires, adressez-vous à votre détaillant ou à votre administrateur de système.

Surv. prioritaire

La fonction Surveillance prioritaire permet à la radio de recevoir automatiquement les transmissions de groupes avec une priorité supérieure, même lorsqu'elle est sur appel de groupe.

La radio quitte l'appel de groupe de priorité inférieure pour les appels de groupe de priorité plus élevée.



AVIS:

Cette fonction est accessible uniquement lorsque le balayage de groupe est activé.

La fonction Surveillance prioritaire s'applique uniquement aux membres de la liste de groupe de réception. Il y a deux groupes de priorité : priorité 1 (P1) et priorité 2 (P2). P1 est une priorité supérieure à P2. Dans le système Capacity Max, la radio reçoit une transmission en fonction de l'ordre de priorité ci-dessous :

- 1 Appel d'urgence pour le groupe P1
- 2 Appel d'urgence pour le groupe P2
- 3 Appel d'urgence pour les groupes de conversation non prioritaire dans la liste de groupe de réception
- 4 Tous les appels
- 5 Appel de groupe P1

6 Appel de groupe P2

7 Groupes non prioritaires dans la liste de groupe de réception

Consultez la section [Modifier l'ordre de priorité d'un groupe d'appels à la page 111](#) pour en savoir plus sur la façon d'ajouter, de retirer ou de modifier la priorité pour les groupes dans la liste de balayage.





AVIS:

Cette fonction est programmée par l'administrateur de système. Pour obtenir des renseignements supplémentaires, adressez-vous à votre détaillant ou à votre administrateur de système.

Modifier l'ordre de priorité d'un groupe d'appels



Dans le menu Balayage de groupe, vous pouvez afficher ou modifier la priorité d'un groupe.



- 1 Appuyez sur  pour accéder au menu.





- 2 Appuyez sur  ou  jusqu'à Balayer.

Appuyez sur  pour effectuer la sélection.

3 Appuyez sur  ou  jusqu'à Voir ou modifier la liste. Appuyez sur  pour effectuer la sélection.

4 Appuyez sur  ou  jusqu'au groupe voulu. Appuyez sur  pour effectuer la sélection. La priorité est indiquée par l'icône **Priorité 1** ou **Priorité 2** à côté du groupe.

5 Appuyez sur  ou  jusqu'à Modifier les priorités. Appuyez sur  pour effectuer la sélection.

6 Appuyez sur  ou  jusqu'au niveau de priorité voulu. Appuyez sur  pour effectuer la sélection. Si un autre groupe a été attribué en priorité 1 ou priorité 2, vous pouvez choisir d'écraser la priorité. Lorsque l'écran affiche Remplacer?, appuyez sur  ou sur  pour les options suivantes :

- Non pour retourner à l'étape précédente.
- Oui pour remplacer.

L'écran affiche un bref avis de réussite avant de revenir à l'écran précédent. L'icône de priorité s'affiche à côté du groupe d'appels.

Affiliation de groupes multiples

Dans un système Capacity Max, votre radio peut être configurée pour un maximum de sept groupes à un site.

Des 16 groupes dans la liste de groupe de réception, jusqu'à sept groupes peuvent être attribués à titre de l'affiliation de groupe. Le groupe sélectionné et la priorité des groupes de conversation sont automatiquement affiliés.







AVIS:



Cette fonction est programmée par l'administrateur de système. Pour obtenir des renseignements supplémentaires, adressez-vous à votre détaillant ou à votre administrateur de système.



Ajout d'affiliation de groupe

Suivez la procédure suivante pour ajouter une affiliation de groupe.



- 1 Appuyez sur  pour accéder au menu.

- 2 Appuyez sur  ou  jusqu'à Balayer.
Appuyez sur  pour effectuer la sélection.







- 3 Appuyez sur  ou  jusqu'à Voir ou modifier la liste. Appuyez sur  pour effectuer la sélection.

- 4 Appuyez sur  ou  jusqu'à l'alias ou l'ID de groupe voulu. Appuyez sur  pour effectuer la sélection.

L'état d'affiliation est affiché dans Afficher/modifier la liste. L'écran affiche  à côté de l'alias ou de l'ID du groupe sélectionné.

- 5 Appuyez sur  ou  jusqu'à Modifier affiliation. Appuyez sur  pour effectuer la sélection.

- 6 Faites un des suivants :

- Appuyez sur  ou  jusqu'à Activer. Appuyez sur  pour effectuer la sélection.
- Appuyez sur  ou  jusqu'à Désactiver. Appuyez sur  pour effectuer la sélection.

Lorsque Activer est sélectionné,  apparaît à côté de l'alias ou l'ID de groupe.

Si l'affiliation est réussie, l'écran affiche à  côté de l'alias ou l'ID de groupe.

Si l'affiliation n'est pas réussie,  demeure à côté de l'alias ou l'ID de groupe.



AVIS:

La radio affiche le message *Liste pleine* quand un maximum de sept groupes est sélectionné pour l'affiliation dans la liste de balayage. Pour sélectionner un nouveau groupe pour l'affiliation, supprimer un groupe associé pour faire place à la nouvelle. Pour obtenir plus de renseignements à ce sujet, consultez la section [Suppression de l'affiliation de groupe à la page 114](#).

Suppression de l'affiliation de groupe

Lorsque la liste d'affiliations est pleine et que vous souhaitez sélectionner un nouveau groupe pour l'affiliation, supprimer un groupe déjà associé pour faire place à la nouvelle. Suivez la procédure suivante pour supprimer une affiliation de groupe.

- 1 Appuyez sur pour accéder au menu.

- 2 Appuyez sur ou jusqu'à *Balayer*. Appuyez sur pour effectuer la sélection.

- 3 Appuyez sur ou jusqu'à *Voir* ou *modifier la liste*. Appuyez sur pour effectuer la sélection.

- 4 Appuyez sur ou jusqu'à l'alias ou l'ID de groupe voulu. Appuyez sur pour effectuer la sélection.

L'état d'affiliation est affiché dans *Afficher/*
modifier la liste. L'écran affiche à côté de l'alias ou de l'ID du groupe sélectionné.

- 5 Appuyez sur ou jusqu'à *Modif.* *affiliation*. Appuyez sur pour effectuer la sélection.

- 6 Appuyez sur ou jusqu'à *Désactiver*. Appuyez sur pour effectuer la sélection.

Lorsque *Désactivé* est sélectionné, apparaît à côté de l'alias ou l'ID de groupe.

TalkBack (réponse)

La fonction Talkback vous permet de répondre à une transmission pendant un balayage.

Si votre radio balaye un appel à partir de la liste de balayage de groupe à sélectionner, et si le bouton **PTT** est actionné au cours du balayage d'appel, le fonctionnement de la radio dépendra de l'activation ou de la désactivation de l'option Talkback pendant la programmation de la radio. Pour obtenir des renseignements supplémentaires, adressez-vous à votre détaillant ou à votre administrateur de système.

La fonction Talkback est désactivée

La radio abandonne l'appel balayé et tente de transmettre au contact pour la position de canal sélectionnée. Après expiration du temps de maintien d'appel sur le contact actuellement sélectionné, la radio revient au canal d'accueil et démarre la minuterie de mise en attente du balayage. La radio reprend le balayage de groupe après que le délai d'attente du balayage soit écoulé.

La fonction Talkback est activée

Si le bouton **PTT** est actionné durant le temps de maintien de l'appel de groupe balayé, la radio essaie de transmettre au groupe balayé.



AVIS:

Si vous balayez un appel pour un groupe qui n'est pas associé à une position de canal dans la zone actuellement sélectionnée et que l'appel se termine, vous devez passer à la zone appropriée et sélectionner la position de canal du groupe pour pouvoir répondre à ce groupe.

Bluetooth

Cette fonctionnalité vous permet d'utiliser votre radio avec un appareil compatible Bluetooth (un accessoire) par l'intermédiaire d'une connexion Bluetooth. Votre radio prend en charge les appareils compatibles Bluetooth de marque Motorola Solutions et autres produits commerciaux prêts à l'emploi.

La connectivité Bluetooth fonctionne dans un rayon de 10 m (32 pi) entre deux appareils en ligne directe. C'est-à-dire un chemin sans obstruction entre votre radio et votre dispositif Bluetooth. Pour obtenir un haut degré de fiabilité, Motorola Solutions recommande de ne pas séparer la radio et l'accessoire.

À la périphérie de la zone de couverture, la qualité de la réception diminue, et la voix et la tonalité peuvent devenir brouillées ou saccadées. Pour corriger ce problème, il suffit de rapprocher votre radio et l'appareil Bluetooth (à moins

de 10 m l'un de l'autre) afin de rétablir la réception. La fonction Bluetooth de votre radio a une puissance maximale de 2,5 mW (4 dBm) dans un rayon de 10 m.

Votre radio peut prendre en charge jusqu'à trois connexions Bluetooth simultanées avec des appareils compatibles Bluetooth de différents types. Vous pouvez connecter, par exemple, un écouteur, un scanneur et un appareil PTT. Les connexions Bluetooth simultanées avec plusieurs appareils Bluetooth de même type ne sont pas prises en charge.

Reportez-vous au manuel d'utilisation de votre dispositif Bluetooth pour plus de détails sur l'ensemble des possibilités de votre périphérique compatible Bluetooth.







AVIS:





Si cette option est désactivée par le CPS, toutes les fonctionnalités associées à Bluetooth sont désactivées et la base de données d'appareil Bluetooth est effacée.









Activer ou désactiver Bluetooth

Suivez la procédure suivante pour activer ou désactiver Bluetooth.

- 1 Appuyez sur  pour accéder au menu.

- 2 Appuyez sur  ou  jusqu'à Bluetooth.
Appuyez sur  pour effectuer la sélection.

- 3 Appuyez sur  ou  jusqu'à Mon État.
Appuyez sur  pour effectuer la sélection.
L'écran affiche **Activé et Arrêt**. L'état actuel est indiqué par l'icône .



- 4 Faites un des suivants :
 - Appuyez sur  ou  jusqu'à Activer.
Appuyez sur  pour effectuer la sélection.
L'écran affiche  à côté du message **Activé**.
 - Appuyez sur  ou  jusqu'à Désactiver.
Appuyez sur  pour effectuer la sélection.
L'écran affiche  à côté du message **Désactivé**.



Connexion aux dispositifs Bluetooth



Suivez la procédure pour vous connecter à des appareils Bluetooth disponibles.





Allumez l'appareil Bluetooth et lancez le mode d'appariement.



- 1 Appuyez sur  pour accéder au menu.

- 2 Appuyez sur  ou  jusqu'à Bluetooth.
Appuyez sur  pour effectuer la sélection.

- 3 Appuyez sur  ou  jusqu'à Appareils.
Appuyez sur  pour effectuer la sélection.

- 4 Faites un des suivants :
 - Appuyez sur  ou  jusqu'à l'appareil voulu. Appuyez sur  pour effectuer la sélection.

- Appuyez sur  ou  jusqu'à Recherche pour trouver des appareils disponibles. Appuyez sur  ou  jusqu'à l'appareil voulu.
Appuyez sur  pour effectuer la sélection.

- 5 Appuyez sur  ou  jusqu'à Connecter.
Appuyez sur  pour effectuer la sélection.
Il est possible que l'appariement de votre appareil Bluetooth nécessite d'autres étapes. Reportez-vous aux manuels d'utilisation des appareils compatibles Bluetooth.
L'écran affiche le message Connexion à <appareil>.

Attendez la confirmation.

En cas de réussite :

- Une tonalité de réussite se fait entendre.
- L'écran affiche <appareil> connecté et l'icône de **connexion Bluetooth**.
- L'écran affiche  à côté de l'appareil sélectionné.

En cas d'échec :

- Une tonalité d'échec se fait entendre.
- L'écran affiche le message Connexion échouée.









AVIS:

Si un code NIP est nécessaire, voir la section [Accès aux radios à l'aide des mots de passe à la page 201](#).

Connexion aux dispositifs Bluetooth en mode Détection

Suivez la procédure suivante pour vous connecter à des appareils Bluetooth en mode détection.

Allumez l'appareil Bluetooth et lancez le mode d'appariement.

- 1 Appuyez sur  pour accéder au menu.
- 2 Appuyez sur  ou  jusqu'à Bluetooth.
Appuyez sur  pour effectuer la sélection.
- 3 Appuyez sur  ou  jusqu'à Me chercher.
Appuyez sur  pour effectuer la sélection. Votre

radio peut maintenant être détectée par d'autres appareils Bluetooth pendant une durée programmée. Il s'agit du Mode détection.

Attendez la confirmation.

En cas de réussite :

- Une tonalité de réussite se fait entendre.
- L'écran affiche <appareil> connecté et l'icône de **connexion Bluetooth**.
- L'écran affiche ✓ à côté de l'appareil sélectionné.



En cas d'échec :



- Une tonalité d'échec se fait entendre.
- L'écran affiche le message Connexion échouée.



Déconnexion de dispositifs Bluetooth



Suivez la procédure suivante pour vous déconnecter de dispositifs Bluetooth.

- 1 Appuyez sur  pour accéder au menu.

2 Appuyez sur  ou  jusqu'à Bluetooth.
Appuyez sur  pour effectuer la sélection.

3 Appuyez sur  ou  jusqu'à Appareils.
Appuyez sur  pour effectuer la sélection.

4 Appuyez sur  ou  jusqu'à l'appareil voulu.
Appuyez sur  pour effectuer la sélection.

5 Appuyez sur  ou  jusqu'à Déconnecter.
Appuyez sur  pour effectuer la sélection.
L'écran affiche le message Déconnexion de <appareil>.



AVIS:

Il est possible que la déconnexion de votre appareil Bluetooth nécessite d'autres étapes. Reportez-vous aux manuels d'utilisation des appareils compatibles Bluetooth.

- Une tonalité se fait entendre.
- L'écran affiche <appareil> déconnecté et l'icône **Bluetooth connecté** disparaît.
- Le  disparaît à côté du de l'appareil connecté.

Changer l'acheminement du signal audio entre le haut-parleur interne de la radio et le dispositif Bluetooth

Suivez la procédure pour faire basculer l'acheminement du signal audio entre le haut-parleur interne de la radio et le dispositif Bluetooth externe.

Appuyez sur la touche programmée **Interrupteur audio Bluetooth**.

L'écran affiche un des résultats suivants :



- Une tonalité se fait entendre. L'écran affiche Rout. audio vers radio.
- Une tonalité se fait entendre. L'écran affiche Rout. audio vers Bluetooth.



Attendez la confirmation.



Affichage de renseignements détaillés sur les appareils



Suivez la procédure suivante pour afficher les détails de l'appareil sur votre radio.

- 1 Appuyez sur  pour accéder au menu.

- 2 Appuyez sur  ou  jusqu'à Bluetooth.
Appuyez sur  pour effectuer la sélection.

- 3 Appuyez sur  ou  jusqu'à Appareils.
Appuyez sur  pour effectuer la sélection.



- 4 Appuyez sur  ou  jusqu'à l'appareil voulu.
Appuyez sur  pour effectuer la sélection.



- 5 Appuyez sur  ou  jusqu'à Afficher les détails. Appuyez sur  pour effectuer la sélection.



Supprimer le nom d'un dispositif



Vous pouvez retirer un dispositif déconnecté de la liste des dispositifs Bluetooth.

- 1 Appuyez sur  pour accéder au menu.

- 2 Appuyez sur  ou  jusqu'à Bluetooth.
Appuyez sur  pour effectuer la sélection.

- 3 Appuyez sur  ou  jusqu'à Appareils.
Appuyez sur  pour effectuer la sélection.



- 4 Appuyez sur  ou  jusqu'à l'appareil voulu.
Appuyez sur  pour effectuer la sélection.



- 5 Appuyez sur  ou  jusqu'à Supprimer.
Appuyez sur  pour effectuer la sélection.
L'écran affiche Dispositif supprimé.



Gain du micro Bluetooth



Cette fonction permet à l'utilisateur de contrôler la valeur du gain du microphone de l'appareil Bluetooth connecté.

- 1 Appuyez sur  pour accéder au menu.

- 2 Appuyez sur  ou  jusqu'à Bluetooth.
Appuyez sur  pour effectuer la sélection.

- 3 Appuyez sur  ou  jusqu'à Gain mic. BT.
Appuyez sur  pour effectuer la sélection.

- 4 Appuyez sur  ou  jusqu'au type de gain du micro Bluetooth et aux valeurs courantes. Appuyez sur  pour effectuer la sélection. Vous pouvez modifier les valeurs ici.

- 5 Appuyez sur  ou  pour augmenter ou diminuer les valeurs. Appuyez sur  pour effectuer la sélection.

Localisation interne



AVIS:







La fonction Localisation interne concerne uniquement les modèles avec la dernière version du logiciel et du matériel. Pour obtenir des renseignements supplémentaires, adressez-vous à votre détaillant ou à votre administrateur de système.

Emplacement doit être utilisé pour assurer le suivi de l'emplacement des utilisateurs de radio. Lorsque cette fonction est activée, la radio est en mode Détection limitée. Des balises dédiées sont utilisées pour localiser la radio et déterminer sa position.

Activation ou désactivation de la fonction Positionnement à l'intérieur

Vous pouvez activer ou désactiver le positionnement à l'intérieur en effectuant l'une des actions suivantes.

- Accédez à cette fonction à partir du menu.
 - a. Appuyez sur  pour accéder au menu.

- b. Appuyez sur  ou  jusqu'à Bluetooth puis sur appuyez sur  pour sélectionner.
- c. Appuyez sur  ou  jusqu'à Localis. interne puis sur appuyez sur  pour sélectionner.
- d. Appuyez sur  pour activer le positionnement à l'intérieur.

L'écran affiche Localis. interne activée.

Une tonalité de réussite se fait entendre.

L'un des événements suivants se produit :

- En cas de réussite, l'icône de positionnement à l'intérieur disponible apparaît sur l'écran d'accueil.
 - En cas d'échec, l'écran affiche Échec activation. Une tonalité d'échec retentit.
- e. Appuyez sur  pour désactiver le positionnement à l'intérieur.

L'écran affiche Localis. interne désactivée.

Une tonalité de réussite se fait entendre.

L'un des événements suivants se produit :

- En cas de réussite, l'icône de positionnement à l'intérieur disponible disparaît de l'écran d'accueil.
 - En cas d'échec, l'écran affiche Échec désactivation. Une tonalité d'échec retentit.
- Accédez à cette fonction à partir de la touche programmée.
- a. Appuyez longuement sur la touche programmée **Localis. interne** pour activer cette fonction.
- L'écran affiche Localis. interne activée.
- Une tonalité de réussite se fait entendre.
- L'un des événements suivants se produit :
- En cas de réussite, l'icône de positionnement à l'intérieur disponible apparaît sur l'écran d'accueil.
 - En cas d'échec, l'écran affiche Échec activation. En cas d'échec, vous entendez une tonalité d'indication négative.

- b. Appuyez longuement sur la touche programmée **Localis. interne** pour désactiver cette fonction.

L'écran affiche **Localis. interne désactivée**. Une tonalité de réussite se fait entendre.



L'un des événements suivants se produit :

- En cas de réussite, l'icône de positionnement à l'intérieur disponible disparaît de l'écran d'accueil.
- En cas d'échec, l'écran affiche **Échec désactivation**. En cas d'échec, vous entendez une tonalité d'indication négative.



Accès aux données sur l'emplacement des balises de positionnement à l'intérieur

Suivez la procédure suivante pour accéder à l'information des balises d'emplacement intérieur.

- 1 Appuyez sur  pour accéder au menu.

- 2 Appuyez sur  ou  jusqu'à **Bluetooth** puis sur appuyez sur  pour sélectionner.

- 3 Appuyez sur  ou  jusqu'à **Localis. interne** puis sur appuyez sur  pour sélectionner.

- 4 Appuyez sur  ou  jusqu'à **Balises**, puis sur appuyez sur  pour sélectionner.

L'écran affiche les informations sur les balises.

Réglages multisite

Ces fonctions s'appliquent lorsque le canal courant de la radio est configuré pour un système Capacity Max.

Lancer une recherche de site manuelle

Suivez la procédure pour démarrer la recherche de site manuelle lorsque la puissance du signal de réception est de mauvaise qualité afin d'essayer de trouver un site avec meilleur signal.

Si la radio détecte un nouveau site :

- Une tonalité de réussite se fait entendre.

Si la radio ne détecte pas de nouveau site :

- Une tonalité d'échec se fait entendre.

Verrouillage de site activé/désactivé

Lorsque cette fonction est activée, la radio ne recherche que le site courant. Lorsqu'elle est désactivée, la radio recherche d'autres sites en plus du site courant.

Appuyez sur la touche programmée **Verr. Site**.

Si la fonction **Verrouillage de site** est activée :

- Une tonalité de réussite retentit pour indiquer que la radio s'est verrouillée sur le site courant.
- L'écran affiche Site verrouillé.



Si la fonction **Verrouillage du site** est désactivée :



- Une tonalité d'échec retentit pour indiquer que la radio est déverrouillée.
- L'écran affiche Site Déverrouillé.



Accès à la liste de sites voisins

Cette fonction permet à l'utilisateur de vérifier la liste des sites adjacents du site d'accueil actuel. Suivez la procédure pour accéder à la liste des sites voisins :

- 1 Appuyez sur  pour accéder au menu.

- 2 Appuyez sur  ou  jusqu'à Utilitaires. Appuyez sur  pour effectuer la sélection.

- 3 Appuyez sur  ou  jusqu'à Info de la radio. Appuyez sur  pour effectuer la sélection.

- 4 Appuyez sur  ou  pour voir les sites voisins. Appuyez sur  pour effectuer la sélection.

Rappel du canal d'accueil

Cette fonction permet d'émettre un rappel si la radio n'est pas réglée sur le canal d'accueil pendant un certain temps.

Si cette fonction est activée lorsque la radio n'est pas réglée sur le canal d'accueil pendant un certain laps de temps, voici ce qui se produit périodiquement :

- La tonalité de Rappel de canal d'accueil et l'annonce sonore retentissent.
- La première ligne de l'écran affiche le message Non.
- La deuxième ligne affiche Canal d'accueil.

Mettre en sourdine le rappel du canal d'accueil

Lorsque survient le rappel du canal d'accueil, vous pouvez le mettre en sourdine.

Appuyez sur la touche programmée **Rappel du canal d'accueil en sourdine**.

La première ligne de l'écran affiche HCR et la deuxième en sourdine.

Réglage de nouveaux canaux d'accueil



Lorsque le rappel du canal d'accueil retentit, vous pouvez définir un nouveau canal d'accueil.



1 Faites un des suivants :





- Appuyez sur la touche programmable **Réinitialiser canal d'accueil** pour régler le canal courant comme nouveau canal d'accueil. Ignorez les étapes suivantes. La première ligne de l'écran affiche l'alias du canal et la deuxième Nouv. canal acc.
- Appuyez sur  pour accéder au menu.

2 Appuyez sur  ou  jusqu'à

Utilitaires. Appuyez sur  pour effectuer la sélection.

3 Appuyez sur  ou  jusqu'au Paramètres de la radio. Appuyez sur  pour effectuer la sélection.

4 Appuyez sur  ou  jusqu'à Canal d'accueil. Appuyez sur  pour effectuer la sélection.

- 5 Appuyez sur  ou  jusqu'à l'alias du nouveau canal d'accueil. Appuyez sur  pour effectuer la sélection.
- L'écran affiche  à côté de l'alias de canal d'accueil sélectionné.
-

Écoute à distance

Cette fonction est utilisée pour activer le microphone d'une radio cible avec un alias ou un ID d'abonné. Vous pouvez utiliser cette fonction pour écouter à distance toute activité audible entourant la radio cible.



Votre radio et la radio cible doivent être programmées de manière à vous permettre d'utiliser cette fonction.

Si la fonction est amorcée, le voyant DEL vert clignote une fois sur la radio cible. Cette fonction s'arrête automatiquement après une durée programmée ou dès qu'une fonction de la radio cible est utilisée.

Lancer la fonction Écoute ambiance

Suivez la procédure pour activer la fonction de surveillance à distance sur votre radio.

- 1 Appuyez sur la touche programmée **Écoute à distance**.
-

- 2 Appuyez sur  ou  jusqu'à l'alias ou l'ID voulu. Appuyez sur  pour effectuer la sélection.
- L'écran affiche un bref avis indiquant que l'exécution de la requête est en cours. Le voyant DEL vert s'allume.
-

- 3 Attendez la confirmation.

En cas de réussite :

- Une tonalité de réussite se fait entendre.
- L'écran affiche un bref avis de réussite.
- L'écoute des sons ambiants de la radio surveillée commence pour la durée programmée et l'écran affiche *Écoute à distance*. Lorsque la minuterie s'arrête, une tonalité d'avertissement est émise et le voyant DEL s'éteint.







En cas d'échec :

- Une tonalité d'échec se fait entendre.

- L'écran affiche un bref avis d'échec.

Activation de l'Écoute ambiance à l'aide de la liste de contacts

Suivez la procédure suivante pour activer la fonction d'écoute à distance à l'aide de la liste de contacts de la radio.

- 1 Appuyez sur  pour accéder au menu.
- 2 Appuyez sur  ou  jusqu'à **Contacts**. Appuyez sur  pour effectuer la sélection.
- 3 Appuyez sur  ou  jusqu'à l'alias ou l'ID voulu. Appuyez sur  pour effectuer la sélection.

- 4 Appuyez sur  ou  jusqu'à **Écoute à distance**. Appuyez sur  pour effectuer la sélection.

L'écran affiche un bref avis indiquant que l'exécution de la requête est en cours. Le voyant DEL vert s'allume.

- 5 Attendez la confirmation.

En cas de réussite :

- Une tonalité de réussite se fait entendre.
- L'écran affiche un bref avis de réussite.
- L'écoute des sons ambiants de la radio surveillée commence pour la durée programmée et l'écran affiche **Écoute à distance**. Lorsque la minuterie s'arrête, une tonalité d'avertissement est émise et le voyant DEL s'éteint.



En cas d'échec :



- Une tonalité d'échec se fait entendre.
- L'écran affiche un bref avis d'échec.



Activation de l'écoute à distance à l'aide de la numérotation manuelle

Suivez la procédure suivante pour activer la fonction d'écoute à distance à l'aide de la numérotation manuelle.

- 1 Appuyez sur  pour accéder au menu.



- 2 Appuyez sur  ou  jusqu'à **Contacts**. Appuyez sur  pour effectuer la sélection.

- 3 Appuyez sur  ou  jusqu'à **Num. manuelle**. Appuyez sur  pour effectuer la sélection.

- 4 Appuyez sur  ou  jusqu'au **Numéro de la radio**. Appuyez sur  pour effectuer la sélection.

- 5 Faites un des suivants :
 - Entrez l'ID ou l'alias de l'abonné et appuyez sur  pour continuer.

- Modifiez les ID composés précédemment et appuyez sur  pour continuer.

- 6 Appuyez sur  ou  jusqu'à **Écoute à distance**. Appuyez sur  pour effectuer la sélection.

L'écran affiche un bref avis indiquant que l'exécution de la requête est en cours. Le voyant DEL vert s'allume.

- 7 Attendez la confirmation.

En cas de réussite :

- Une tonalité de réussite se fait entendre.
- L'écran affiche un bref avis de réussite.
- L'écoute des sons ambiants de la radio surveillée commence pour la durée programmée et l'écran affiche **Écoute à distance**. Lorsque la minuterie s'arrête, une tonalité d'avertissement est émise et le voyant DEL s'éteint.

En cas d'échec :

- Une tonalité d'échec se fait entendre.

- L'écran affiche un bref avis d'échec.

Réglages des contacts

La fonction Contacts constitue le carnet d'adresses de votre radio. Chaque entrée est associée à un alias ou à un ID que vous utilisez pour passer un appel. Les entrées sont classées alphabétiquement.

Chaque entrée, selon le contexte, correspond à différents types d'appels : Appel de groupe, appel individuel, appel de diffusion, appel général de site, appel général multisite, appel PC ou appel de répartition.

Les appels PC et les appels console répartiteur sont des appels de données. Ils ne sont disponibles qu'avec les applications. Pour plus de détails, reportez-vous à la documentation sur les applications de données.

De plus, le menu Contacts vous permet d'attribuer à chaque entrée une ou plusieurs touches numériques programmables sur un microphone à clavier. Si une touche numérique est attribuée à une entrée, votre radio peut exécuter la composition rapide de l'entrée.



AVIS:

Un crochet précède chaque touche numérique attribuée à une entrée. Si le crochet précède le mot Vide, aucune touche numérique n'a été attribuée à l'entrée.

Chaque entrée des contacts affiche les renseignements suivants :

- Type d'appel
- Alias d'appel
- ID d'appel







AVIS:



Si la fonction Cryptage est activée sur un canal, vous pouvez passer des appels de groupe, individuels, généraux ou téléphoniques cryptés sur ce canal. Seule une radio cible dotée de la même clé de cryptage OU des mêmes valeurs et ID de clé que votre radio peut décoder la transmission.



Association d'une entrée à une touche numérique programmable



Suivez la procédure suivante pour associer des entrées aux touches numériques programmables de votre radio.

- 1 Appuyez sur  pour accéder au menu.



- 2 Appuyez sur  ou  jusqu'à Contacts.
Appuyez sur  pour effectuer la sélection.

- 3 Appuyez sur  ou  jusqu'à l'alias ou l'ID voulu. Appuyez sur  pour effectuer la sélection.

- 4 Appuyez sur  ou  jusqu'à Touche programmable. Appuyez sur  pour effectuer la sélection.

- 5 Faites un des suivants :
 - Si la touche numérique voulue n'a été attribuée à une entrée, appuyez sur  ou  jusqu'à la touche numérique voulue. Appuyez sur  pour effectuer la sélection.
 - Si la touche numérique voulue a été attribuée à une entrée, l'écran affiche La clé est déjà

affecté et puis, la première ligne de texte affiche Remplacer?. Faites un des suivants :

Appuyez sur  ou  jusqu'à Oui.

Appuyez sur  pour effectuer la sélection.

La radio fait entendre une tonalité de réussite et l'écran affiche Contact enregistré et un bref avis de réussite.

Appuyez sur  ou  jusqu'à Non pour revenir à l'écran précédent.

Différentes touches numériques peuvent être attribuées à chaque entrée. Le signe ✓ précède chaque touche numérique attribuée à une entrée. Si le signe ✓ précède Vide, la touche numérique n'est pas attribuée.

Si une touche numérique a été attribuée à une entrée dans un mode particulier, la fonction n'est pas prise en charge lorsque vous appuyez longuement sur la touche numérique dans un autre mode.



L'écran revient automatiquement au menu précédent.

Dissociation d'une entrée et de la touche numérique programmable



Suivez la procédure pour dissocier les entrées des touches numériques programmables de votre radio.



1 Faites un des suivants :



- Appuyez longuement sur la touche numérique programmée jusqu'à l'alias ou l'ID voulu. Passez à [étape 4](#).
- Appuyez sur  pour accéder au menu.

2 Appuyez sur  ou  jusqu'à `Contacts`.



Appuyez sur  pour effectuer la sélection.

3 Appuyez sur  ou  jusqu'à l'alias ou l'ID voulu. Appuyez sur  pour effectuer la sélection.

4 Appuyez sur  ou  jusqu'à `Touche programmable`. Appuyez sur  pour effectuer la sélection.

5 Appuyez sur  ou  jusqu'à `Vide`. Appuyez sur  pour effectuer la sélection.

La première ligne de texte affiche `Supprimer de toutes les touches`.

6 Appuyez sur  ou  jusqu'à `Oui`. Appuyez sur  pour effectuer la sélection.



AVIS:



Lorsqu'une entrée est supprimée, l'association entre l'entrée et les touches numériques programmées est supprimée.



Une tonalité de réussite se fait entendre. L'écran affiche le message `Contact enregistré`. L'écran revient automatiquement au menu précédent.



Ajout d'un nouveau contact

Suivez la procédure suivante pour ajouter de nouveaux contacts sur votre radio.

- 1 Appuyez sur  pour accéder au menu.



- 2 Appuyez sur  ou  jusqu'à **Contacts**. Appuyez sur  pour effectuer la sélection.

- 3 Appuyez sur  ou  jusqu'à **Nouveau contact**. Appuyez sur  pour effectuer la sélection.

- 4 Appuyez sur  ou  pour sélectionner le type de contact, soit **Contact Radio**, soit **Contact tél.** Appuyez sur  pour effectuer la sélection.

- 5 Entrer le numéro du contact à l'aide du clavier et appuyez sur  pour continuer.

- 6 Entrer le nom du contact à l'aide du clavier et appuyez sur  pour continuer.

- 7 Appuyez sur  ou  jusqu'à la sonnerie voulue. Appuyez sur  pour effectuer la sélection.
Une tonalité de réussite se fait entendre. L'écran affiche un bref avis de réussite.



Réglages de l'indicateur d'appel



Cette fonction permet aux utilisateurs radio de configurer un appel ou un message texte sonneries.



Activation ou désactivation des sonneries d'appel des appels privés

Suivez la procédure suivante pour activer ou désactiver les sonneries d'appel des appels privés de la radio.



- 1 Appuyez sur  pour accéder au menu.



- 2 Appuyez sur  ou  jusqu'à **Utilitaires**. Appuyez sur  pour effectuer la sélection.



3 Appuyez sur  ou  jusqu'au Paramètres de la radio. Appuyez sur  pour effectuer la sélection.

4 Appuyez sur  ou  jusqu'à Trinités/Alertes. Appuyez sur  pour effectuer la sélection.

5 Appuyez sur  ou  jusqu'à Sonn. d'appels. Appuyez sur  pour effectuer la sélection.

6 Appuyez sur  ou  jusqu'à Appel indiv.. Appuyez sur  pour effectuer la sélection.



7 Appuyez sur  ou  jusqu'à la sonnerie voulue. Appuyez sur  pour effectuer la sélection.



Si la fonction est activée,  apparaît à côté d'Activé. Si cette option est désactivée, le  ne s'affiche plus à côté de Activé.



Activation ou désactivation des sonneries d'appel des messages textes

Suivez la procédure suivante pour activer ou désactiver les sonneries de messages texte sur votre radio.





1 Appuyez sur  pour accéder au menu.



2 Appuyez sur  ou  jusqu'à Utilitaires. Appuyez sur  pour effectuer la sélection.

3 Appuyez sur  ou  jusqu'au Paramètres de la radio. Appuyez sur  pour effectuer la sélection.

4 Appuyez sur  ou  jusqu'à Trinités/Avert... Appuyez sur  pour effectuer la sélection.

5 Appuyez sur  ou  jusqu'à Sonn. d'appels. Appuyez sur  pour effectuer la sélection.

6 Appuyez sur  ou  jusqu'à Message texte. Appuyez sur  pour effectuer la sélection. L'écran affiche  et la sonnerie actuelle.



7 Appuyez sur  ou  jusqu'à la sonnerie voulue. Appuyez sur  pour effectuer la



sélection. L'écran affiche  à côté de la sonnerie sélectionnée.



Activation ou désactivation des sonneries d'appel des avertissements d'appel

Suivez la procédure suivante pour activer ou désactiver les sonneries d'appel des appels d'urgence sur votre radio.



1 Appuyez sur  pour accéder au menu.





2 Appuyez sur  ou  jusqu'à Utilitaires. Appuyez sur  pour effectuer la sélection.

3 Appuyez sur  ou  jusqu'au Paramètres de la radio. Appuyez sur  pour effectuer la sélection.

4 Appuyez sur  ou  jusqu'à Trinités/Avert... Appuyez sur  pour effectuer la sélection.

5 Appuyez sur  ou  jusqu'à **Sonn.**
d'appels. Appuyez sur  pour effectuer la sélection.



6 Appuyez sur  ou  jusqu'à **Aver.**
d'appel. Appuyez sur  pour effectuer la sélection.



7 Appuyez sur  ou  jusqu'à la sonnerie
voulue. Appuyez sur  pour effectuer la
sélection. L'écran affiche  à côté de la sonnerie
sélectionnée.



Activation ou désactivation des sonneries d'appel des appels sélectifs

Suivez la procédure suivante pour activer ou désactiver les sonneries d'appel des appels sélectifs de la radio.





1 Appuyez sur  pour accéder au menu.





2 Appuyez sur  ou  jusqu'à **Utilitaires.**
Appuyez sur  pour effectuer la sélection.

3 Appuyez sur  ou  jusqu'au **Paramètres**
de la radio. Appuyez sur  pour effectuer la
sélection.

4 Appuyez sur  ou  jusqu'à **Trités/**
Avert.. Appuyez sur  pour effectuer la
sélection.





5 Appuyez sur  ou  jusqu'à **Sonn.**
d'appels. Appuyez sur  pour effectuer la
sélection.



6 Appuyez sur  ou  jusqu'à **Appel**
sélectif. Appuyez sur  pour effectuer la
sélection.
L'écran affiche  et la sonnerie actuelle.



- 7 Appuyez sur  ou  jusqu'à la sonnerie voulue. Appuyez sur  pour effectuer la sélection. L'écran affiche  à côté de la sonnerie sélectionnée.
-

Activer ou désactiver les sonneries d'appel des états de télémétrie avec message texte





Suivez la procédure suivante pour activer ou désactiver les sonneries d'appel d'état de télémétrie avec message texte sur votre radio.

- 1 Appuyez sur  pour accéder au menu.
-
- 2 Appuyez sur  ou  jusqu'à Utilitaires. Appuyez sur  pour effectuer la sélection.
-

- 3 Appuyez sur  ou  jusqu'au Paramètres de la radio. Appuyez sur  pour effectuer la sélection.
-

- 4 Appuyez sur  ou  jusqu'à Trinités/Avert. Appuyez sur  pour effectuer la sélection.
-

- 5 Appuyez sur  ou  jusqu'à Sonn. d'appels. Appuyez sur  pour effectuer la sélection.
-



- 6 Appuyez sur  ou  jusqu'à Télémétrie. Appuyez sur  pour effectuer la sélection. La tonalité sélectionnée est indiquée par l'icône .
-



Attribuer des styles de sonneries



Vous pouvez programmer votre radio pour qu'elle émette une sonnerie particulière parmi les onze sonneries prédéfinies lorsque vous recevez un appel privé, un

avertissement d'appel ou un message texte de la part d'un contact particulier. La radio fait entendre chaque style de sonnerie lorsque vous parcourez la liste. Suivez la procédure pour attribuer des styles de sonnerie sur votre radio.

- 1 Appuyez sur  pour accéder au menu.



- 2 Appuyez sur  ou  jusqu'à **Contacts**. Appuyez sur  pour effectuer la sélection.
Les entrées sont classées alphabétiquement.

- 3 Appuyez sur  ou  jusqu'à l'alias ou l'ID voulu. Appuyez sur  pour effectuer la sélection.

- 4 Appuyez sur  ou  jusqu'à **Voix** Modifier. Appuyez sur  pour effectuer la sélection.

- 5 Appuyez sur  jusqu'à ce que l'écran affiche le menu **Sonnerie**

L'icône  indique la tonalité actuellement sélectionnée.

- 6 Appuyez sur  ou  jusqu'à la tonalité voulue. Appuyez sur  pour effectuer la sélection.

L'icône  s'affiche à côté de celui sélectionné.

Augmenter le volume de la tonalité d'alarme

Votre détaillant peut programmer la radio pour vous alerter de façon continue lorsqu'un appel radio reste sans réponse. Le volume de la tonalité d'alarme augmente alors graduellement. Cette fonction porte le nom d'avertissement croissant.

Fonctions du Journal des appels

Votre radio fait le suivi des appels individuels que vous avez faits, que vous avez reçus et que vous avez manqués récemment. Utilisez le journal des appels pour afficher et gérer les derniers appels.



Les Alertes d'appels manqués peuvent être incluses dans les journaux d'appels, selon la configuration du système sur votre radio. Dans chacune des listes d'appels, vous pouvez exécuter les tâches suivantes :



- Stocker l'alias ou l'ID dans les contacts
- Supprimer un appel
- Supprimer tous les appels
- Afficher les détails

Affichage des derniers appels

Suivez la procédure suivante pour afficher les derniers appels sur votre radio.

- 1 Appuyez sur  pour accéder au menu.
-

- 2 Appuyez sur  ou  jusqu'à Journal des appels. Appuyez sur  pour effectuer la sélection.
-

- 3 Appuyez sur  ou  jusqu'à la liste voulue. Les listes offertes sont Manqués, Répondus et Sortants.



Appuyez sur  pour effectuer la sélection.
L'écran affiche l'entrée la plus récente.



- 4 Appuyez sur  ou  pour voir la liste.
Vous pouvez lancer un Appel individuel avec l'alias ou l'ID affiché à l'écran en appuyant sur la touche **PTT**.
-



Stockage des alias ou des ID de la liste d'appels



Suivez la procédure suivante pour stocker les alias ou les ID de la liste d'appels sur votre radio.

- 1 Appuyez sur  pour accéder au menu.

- 2 Appuyez sur  ou  jusqu'à Journal des appels. Appuyez sur  pour effectuer la sélection.

- 3 Appuyez sur  ou  jusqu'à la liste voulue. Appuyez sur  pour effectuer la sélection.

- 4 Appuyez sur  ou  jusqu'à l'alias ou l'ID voulu. Appuyez sur  pour effectuer la sélection.

- 5 Appuyez sur  ou  jusqu'à Stocker. Appuyez sur  pour effectuer la sélection. L'écran affiche un curseur clignotant.

- 6 Entrez le reste des caractères de l'alias voulu. Appuyez sur  pour effectuer la sélection.



Vous pouvez également enregistrer un ID sans un alias.



L'écran affiche un bref avis de réussite.

Suppression des appels de la liste d'appel

Suivez la procédure suivante pour supprimer des appels de la liste d'appel.



- 1 Appuyez sur  pour accéder au menu.

- 2 Appuyez sur  ou  jusqu'à Journal des appels. Appuyez sur  pour effectuer la sélection.





- 3 Appuyez sur  ou  jusqu'à la liste voulue. Appuyez sur  pour effectuer la sélection. Si la liste est vide :
 - Une tonalité se fait entendre.

- L'écran affiche Liste vide.

4 Appuyez sur  ou  jusqu'à l'alias ou l'ID voulu. Appuyez sur  pour effectuer la sélection.

5 Appuyez sur  ou  jusqu'à Supprimer l'entrée?. Appuyez sur  pour effectuer la sélection.



6 Faites un des suivants :



- Appuyez sur  pour sélectionner Oui et supprimer l'entrée.
L'écran affiche Entrée supprimée.
- Appuyez sur  ou  jusqu'à Non.
Appuyez sur  pour effectuer la sélection.
La radio revient à l'écran précédent.



Suppression d'un appel général de la liste d'appel



Suivez la procédure suivante pour supprimer tous les appels de la liste d'appel.

1 Appuyez sur  pour accéder au menu.





2 Appuyez sur  ou  jusqu'à Journal des appels. Appuyez sur  pour effectuer la sélection.

3 Appuyez sur  ou  jusqu'à la liste voulue. Appuyez sur  pour effectuer la sélection.

4 Appuyez sur  ou  jusqu'à l'alias ou l'ID voulu. Appuyez sur  pour effectuer la sélection.

5 Appuyez sur  ou  jusqu'à Tout supprimer. Appuyez sur  pour effectuer la sélection.



6 Faites un des suivants :



- Appuyez sur  pour sélectionner Oui pour supprimer toutes les entrées. L'écran affiche un bref avis de réussite.
 - Appuyez sur  ou  jusqu'à Non. Appuyez sur  pour effectuer la sélection. La radio revient à l'écran précédent.
-

Affichage des détails de la liste d'appels



Suivez la procédure suivante pour afficher des détails de la liste d'appels sur la radio.

1 Appuyez sur  pour accéder au menu.

2 Appuyez sur  ou  jusqu'à Journal des appels. Appuyez sur  pour effectuer la sélection.

3 Appuyez sur  ou  jusqu'à la liste voulue. Appuyez sur  pour effectuer la sélection.

4 Appuyez sur  ou  jusqu'à l'alias ou l'ID voulu. Appuyez sur  pour effectuer la sélection.

5 Appuyez sur  ou  jusqu'à Afficher les détails. Appuyez sur  pour effectuer la sélection. L'écran affiche les détails.

Fonction Avertissement d'appel

L'envoi d'un avertissement d'appel vous permet de faire savoir à un utilisateur de radio particulier que vous

souhaitez qu'il vous rappelle lorsqu'il lui sera possible de le faire.

Cette fonction est offerte uniquement pour les alias ou les ID d'abonné et est accessible par le menu Contacts, la numérotation manuelle ou la touche d'**accès direct** programmée.

En mode Capacity Max, la fonction Avertissement d'appel permet à un utilisateur radio ou à un répartiteur d'envoyer une alerte à un autre utilisateur radio lui demandant de rappeler l'utilisateur radio qui a lancé l'alerte lorsqu'il est disponible. La communication vocale n'est pas concernée par cette fonction.

La Fonction Avertissement d'appel peut être configurée par le fournisseur ou par l'administrateur système de deux manières :

- La radio est configurée pour permettre à l'utilisateur d'appuyer sur le bouton **PTT** pour répondre directement au lanceur d'appel par la fonction Appel individuel.
- La radio est configurée pour permettre à l'utilisateur d'appuyer sur le bouton **PTT** et de poursuivre avec d'autres groupes de communication. Appuyer sur le bouton **PTT** lors de l'entrée de l'avertissement d'appel ne permettra pas à l'utilisateur de répondre au lanceur d'appel. L'utilisateur doit naviguer sur l'option Journal

des appels manqués dans le menu Journal d'appels et répondre à l'avertissement d'appel à partir de là.

Un appel individuel en mode établissement d'une connexion sans émission (OACSU) permet à l'utilisateur de répondre immédiatement, tandis que l'utilisateur doit accuser réception d'un appel individuel en mode établissement d'une connexion sans émission intégrale (FOACSU). Par conséquent, il est recommandé d'utiliser la fonction Avertissement d'appel pour les appels de type OACSU. Voir [Appel individuel à la page 80](#).

Exécution d'une alerte d'appel

Suivez la procédure suivante pour lancer des alertes d'appel à partir de votre radio.

- 1 Appuyez sur la touche d'**accès direct** programmée. L'écran affiche Avert. d'appel ainsi que l'alias ou l'ID d'abonné. Le voyant DEL vert s'allume.



- 2 Attendez la confirmation.
Si la radio reçoit la confirmation de l'avis d'appel, l'écran affiche un bref avis de réussite.



Dans le cas contraire, l'écran affiche un bref avis d'échec.



Avis d'appels faits à l'aide de la liste de contacts

Suivez la procédure suivante pour passer des avis d'appel à l'aide de la liste de contacts à partir de votre radio.

- 1 Appuyez sur  pour accéder au menu.

- 2 Appuyez sur  ou  jusqu'à **Contacts**.
Appuyez sur  pour effectuer la sélection.

- 3 Appuyez sur  ou  jusqu'à l'alias ou l'ID voulu. Appuyez sur  pour effectuer la sélection.

- 4 Appuyez sur  ou  jusqu'à **Avert.** d'appel. Appuyez sur  pour effectuer la sélection.

L'écran affiche **Avert.** d'appel ainsi que l'alias ou l'ID d'abonné. Le voyant DEL vert s'allume.

- 5 Attendez la confirmation.
 - Si la radio reçoit la confirmation de l'avis d'appel, l'écran affiche un bref avis de réussite.
 - Dans le cas contraire, l'écran affiche un bref avis d'échec.

Réponse à un avertissement d'appel

Suivez la procédure suivante pour répondre à un avertissement d'appel sur votre radio.

Lorsque vous recevez un avertissement d'appel :

- Une tonalité répétitive se fait entendre.
- Le voyant DEL jaune clignote.

- L'écran affiche la liste des notifications d'avertissement d'appel accompagnée de l'alias ou de l'ID de la radio de l'appelant.

Selon la configuration par votre détaillant ou administrateur de système, vous pouvez répondre à un avertissement d'appel en procédant de l'une des manières suivantes :

- Appuyez sur le bouton **PTT** et répondez par un appel individuel directement à l'appelant.
- Appuyez sur le bouton **PTT** pour continuer la communication de groupe d'appels normale. L'avertissement d'appel est déplacé vers l'option Appel manqué dans le menu du Journal d'appels. Vous pouvez répondre à l'appelant à partir du journal Appel manqué.

Pour plus d'informations à ce sujet, reportez-vous à [Liste de notifications à la page 204](#) et à [Fonctions du Journal des appels à la page 138](#).

Mode Muet

Le mode muet propose une option à l'utilisateur de couper tous les indicateurs audio de la radio.

Une fois le mode muet activé, tous les indicateurs sonores sont désactivés à l'exception des fonctions de priorité élevée, comme les opérations d'urgence.

Lorsque l'on quitte le mode muet, la radio reprend la lecture des tonalités et de transmissions audio.



AVIS:

Ceci est une fonction pouvant être achetée. Pour obtenir des renseignements supplémentaires, adressez-vous à votre détaillant ou à votre administrateur de système.

Activation du mode muet

Suivez la procédure suivante pour activer le mode muet.

Accédez à cette fonction à partir de la touche programmée **Mode muet**.

Les éléments suivants se produisent lorsque le mode muet est activé :





- Une tonalité de réussite se fait entendre.
- L'écran affiche `Mode muet activé`.
- Le voyant rouge clignote et continue de clignoter jusqu'à ce que l'on quitte le mode muet.



- L'écran affiche le **Mode muet** sur l'écran d'accueil.
- La radio est en sourdine.
- La minuterie de mode muet commence pour toute la durée configurée.



Réglage de la minuterie du mode muet



La fonction Mode muet peut être activée pour une durée prédéterminée en réglant la minuterie du mode muet. La durée de la minuterie est configurée dans le menu de la radio et peut être comprise entre 0,5 et 6 heures. Le mode muet est quitté lorsque la minuterie expire.

Si la minuterie est laissée à 0, la radio reste en mode muet pendant une période indéfinie jusqu'à ce que l'on appuie sur la touche programmée **Mode muet**.

- 1 Appuyez sur  pour accéder au menu.
- 2 Appuyez sur  ou  jusqu'à Utilitaires.
Appuyez sur  pour effectuer la sélection.

- 3 Appuyez sur  ou  jusqu'au Paramètres de la radio. Appuyez sur  pour effectuer la sélection.

- 4 Appuyez sur  ou  jusqu'à Mode muet.
Appuyez sur  pour effectuer la sélection.

- 5 Appuyez sur  ou  pour modifier la valeur numérique de chaque chiffre, puis appuyez sur .

Quitter le mode muet

Cette fonction peut être quittée automatiquement une fois l'expiration de la minuterie de mode muet.

Effectuez l'une des opérations suivantes pour quitter le mode muet manuellement :

- Appuyez sur la touche programmée **Mode muet**.

- Appuyez sur le bouton **PTT** pour n'importe quelle entrée.

Les éléments suivants se produisent lorsque le mode muet est désactivé :

- Une tonalité d'échec se fait entendre.
- L'écran affiche Mode muet désactivé.
- Le voyant DEL rouge clignotant s'éteint.
- L'icône **Mode muet** disparaît de l'écran d'accueil.
- Votre radio désactive le mode muet et l'état du haut-parleur est rétabli.
- Si la minuterie n'est pas expirée, cette dernière est arrêtée.



AVIS:

Mode muet est également abandonné si l'utilisateur transmet par la voix ou passa à un canal non programmé.

Fonctionnement d'urgence

Une alarme d'urgence est employée pour signaler une situation critique. Vous pouvez signaler une urgence en tout temps même si de l'activité se déroule sur le canal en cours d'utilisation.

En mode Capacity Max, la radio réceptrice peut prendre uniquement en charge une seule alarme d'urgence à la fois. Si amorcée, une deuxième alarme d'urgence a priorité sur la première alarme.

Lorsqu'une alarme d'urgence est reçue, le destinataire peut choisir de supprimer l'alarme et quitter la liste des alarmes, ou il peut répondre à une alarme d'urgence en appuyant sur le bouton **PTT** et la transmission voix sans urgence.

Votre détaillant ou administrateur de site peut définir la durée d'appui sur la touche **Urgence** programmée, sauf l'appui prolongé, qui est semblable à celui de tous les autres boutons :

Appui bref

De 0,05 à 0,75 seconde.

Appui long

De 1,00 à 3,75 secondes.

La fonction Urgence act./dés. est attribuée à la touche **Urgence**. Vérifiez auprès de votre détaillant le fonctionnement de la touche **Urgence**.

**AVIS:**

Si l'appui bref sur la touche **Urgence** permet d'activer le mode d'urgence, alors l'appui prolongé sur la touche **Urgence** permet de quitter le mode d'urgence.

Si l'appui prolongé sur la touche **Urgence** permet d'activer le mode d'urgence, alors l'appui bref sur la touche **Urgence** permet de quitter le mode d'urgence.

Votre radio prend en charge trois alarmes d'urgence :

- Alarme d'urgence
- Alarme d'urgence avec appel
- Alarme d'urgence suivie d'un appel vocal

De plus, chaque alarme comprend les types suivants :

Régulier

La radio transmet un signal d'alarme et active des indicateurs sonores ou visuels.

Silencieux

La radio transmet un signal d'alarme sans indicateurs sonores ou visuels. La radio reçoit les appels sans qu'aucun son ne se fasse entendre sur le haut-parleur, jusqu'à ce que la période de transmission *micro ouvert*

programmée se termine ou que vous appuyiez sur le bouton **PTT**.

Silencieux avec voix

La radio transmet un signal d'alarme sans indicateurs sonores ou visuels, mais permet aux appels entrants de se faire entendre sur le haut-parleur.

**AVIS:**

Une seule des alarmes d'urgence ci-dessus peut être associée à la touche d'**urgence** programmée ou à l'interrupteur d'**urgence** au pied.

Envoi des alarmes d'urgence

Cette fonction vous permet d'envoyer une alarme d'urgence (un signal sans voix) qui déclenche une indication d'alerte sur un groupe de radios. Suivez la procédure suivante pour envoyer des alertes d'urgence à partir de votre radio.

Votre radio n'affiche aucun indicateur sonore ou visuel durant le mode d'urgence lorsque celui-ci est réglé sur silencieux.

- 1 Appuyez sur la touche programmée **Urgence activée**.

Vous voyez l'un des résultats suivants :

- L'écran affiche le message `Alarme Tx` et l'alias de destination.
- L'écran affiche le message `Télégram Tx` et l'alias de destination.

Le voyant DEL vert s'allume. L'icône **Urgence** s'affiche.



AVIS:

Si programmée, la tonalité de recherche d'urgence se fait entendre. Cette tonalité est silencieuse lorsque la radio transmet ou reçoit des messages vocaux, et s'arrête lorsque la radio quitte le mode d'urgence. La tonalité de recherche d'urgence peut être programmée par le détaillant ou votre administrateur de système.

2 Attendez la confirmation.

En cas de réussite :

- La tonalité d'urgence se fait entendre.
- Le voyant DEL vert clignote.
- L'écran affiche le message `Alarme envoyée`

En cas d'échec après que toutes les tentatives ont été utilisées :

- Une tonalité se fait entendre.
- L'écran affiche le message `Échec de l'alarme`.

La radio quitte le mode d'alarme d'urgence et revient à l'écran d'accueil.



AVIS:

Lorsque la radio est configurée pour une alarme d'urgence seulement, le processus d'urgence consiste uniquement à l'envoi de l'alarme d'urgence. L'urgence se termine lorsqu'un accusé de réception est reçu du système ou lorsque les tentatives d'accès au canal sont épuisées.

Aucun appel vocal n'est associé à l'envoi d'une alarme d'urgence lorsque la radio fonctionne en mode Alarme d'urgence seulement.

Envoi d'une alarme d'urgence avec un appel

Cette fonction vous permet d'envoyer une alarme d'urgence avec un appel à un groupe de radios ou à un répartiteur. Lorsqu'une infrastructure du groupe accuse

réception de l'alarme d'urgence, le groupe de radios peut communiquer sur un canal d'urgence programmé.

La radio doit être configurée avec pour l'alarme et l'appel d'urgence pour effectuer un appel d'urgence après le processus d'alarme.

1 Appuyez sur la touche programmée **Urgence activée**.

L'écran affiche le message **Alarme Tx** et l'alias de destination. L'icône **Urgence** s'affiche. Le voyant DEL vert s'allume.



AVIS:

Si programmée, la tonalité de recherche d'urgence se fait entendre. Cette tonalité est silencieuse lorsque la radio transmet ou reçoit des messages vocaux, et s'arrête lorsque la radio quitte le mode d'urgence.

Si un accusé de réception de l'alarme d'urgence est reçu :

- La tonalité d'urgence se fait entendre.
- Le voyant DEL vert clignote.
- L'écran affiche le message **Alarme envoyée**

- Votre radio passe en mode d'appel d'urgence lorsque l'écran affiche le message **Urgence** et l'alias du groupe de destination.

Si un accusé de réception de l'alarme d'urgence n'est pas reçu :

- Toutes les tentatives sont épuisées.
- Une tonalité grave retentit.
- L'écran affiche le message **Échec de l'alarme**.
- La radio quitte alors le mode d'alarme d'urgence.

2 Appuyez sur le bouton **PTT** pour lancer une transmission vocale.

Le voyant DEL vert s'allume. L'écran affiche l'icône **Appel de groupe**.

3 Faites un des suivants :

- Attendez la fin de la tonalité d'autorisation de parler (si elle est activée) et parlez clairement dans le microphone.
 - Attendez la fin de l'effet local **PTT** (s'il est activé) et parlez clairement dans le microphone.
-

- 4 Relâchez le bouton **PTT** pour écouter.
L'écran affiche l'alias de l'appelant et l'alias de groupe.

- 5 Si l'indicateur Canal libre est activé, une courte tonalité d'avertissement se fait entendre lorsque l'utilisateur de la radio émettrice cesse d'appuyer sur le bouton **PTT**, vous indiquant que le canal est libre et que vous pouvez répondre. Pour prendre l'appel, appuyez sur le bouton **PTT**.

- 6 Appuyez sur la touche **Urgence désact.** pour quitter le mode d'urgence.
La radio revient à l'écran d'accueil.



AVIS:

Selon la configuration de votre radio, vous entendrez peut-être une tonalité d'autorisation de parler. Votre détaillant ou administrateur de site peut vous fournir plus d'information sur la façon dont votre radio a été programmée pour les urgences.

L'initiateur de l'appel d'urgence peut appuyer sur la touche programmée  pour mettre fin à l'appel d'urgence en cours. La radio revient à un état d'attente d'appel, mais l'écran d'appel d'urgence reste ouvert.

Envoi d'une alarme d'urgence suivie d'un appel vocal

Cette fonction vous permet d'envoyer une alarme d'urgence suivie d'un appel vocal à un groupe de radios. Le microphone de votre radio est automatiquement activé, vous permettant de communiquer avec le groupe de radios sans avoir à appuyer sur le bouton **PTT**. Cet état de microphone activé est aussi appelé « *microphone branché* ».

**AVIS:**

Votre radio ne peut pas détecter un microphone non IMPRES qui est attaché au connecteur d'accessoire arrière.

Si aucun microphone n'est détecté sur le connecteur programmé indiqué, votre radio vérifie l'autre connecteur. Ainsi votre radio donne la priorité au microphone détecté.

Si le mode de cycle d'urgence de votre radio est activé, les répétitions de *microphone branché* et de période de réception s'appliquent pendant la durée programmée. Pendant le mode de cycle d'urgence, le son des appels reçus est diffusé sur le haut-parleur de la radio.

Si vous appuyez sur le bouton **PTT** pendant la période de réception programmée, une tonalité d'interdiction se fait entendre, indiquant que vous devez libérer le bouton **PTT**. La radio ne tient pas compte du fait que le bouton **PTT** est enfoncé et demeure en mode d'urgence.

Si vous appuyez sur le bouton **PTT** pendant la période de *microphone branché* programmée et si vous maintenez le bouton enfoncé après l'expiration de la durée de *microphone branché*, la radio continue de transmettre jusqu'à ce que vous relâchiez le bouton **PTT**.

Si la demande d'alarme d'urgence échoue, la radio ne fait pas d'autre tentative et passe directement à l'état de *microphone branché*.

**AVIS:**

Certains accessoires ne prennent pas en charge la fonction *microphone branché*. Pour obtenir des renseignements supplémentaires, adressez-vous à votre détaillant ou à votre administrateur de système.

Suivez la procédure suivante pour envoyer un message d'urgence suivi d'un appel vocal.

- 1 Appuyez sur la touche programmée **Urgence Act.** ou sur la **pédale d'urgence**.

Vous voyez un des résultats suivants :

- L'écran affiche le message **Alarme Tx** et l'alias de destination.
- L'écran affiche le message **Télégram Tx** et l'alias de destination.

Le voyant DEL vert s'allume. L'icône **Urgence** s'affiche.

- 2 Lorsque l'écran affiche le message **Alarme** envoyée, parlez clairement dans le micro.

La radio cesse automatiquement de transmettre dans les cas suivants :

- Si le mode Cycle d'urgence est activé, la durée du cycle entre *micro ouvert* et réception d'appels arrive à son terme.
- Après l'expiration de la durée de *micro ouvert*, le mode cycle d'urgence est désactivé.

-
- 3 Appuyez sur la touche **Urgence désact.** pour quitter le mode d'urgence.

La radio revient à l'écran d'accueil.

Réception d'une alarme d'urgence

La radio réceptrice peut prendre uniquement en charge une seule alarme d'urgence à la fois. Si amorcée, une deuxième alarme d'urgence a priorité sur la première alarme. Suivez la procédure suivante pour recevoir et voir des alertes d'urgence sur votre radio.

Lorsque vous recevez une alarme d'urgence :

- Une tonalité se fait entendre.
- Le voyant DEL rouge clignote.
- L'écran affiche la liste des alarmes d'urgence, l'alias ou l'ID du groupe d'appels d'urgence et l'ID ou l'alias de la radio à l'origine de la transmission.

- 1 Appuyez sur  pour afficher l'alarme.
-

- 2 Appuyez sur  pour afficher les options d'action et les détails de l'entrée dans la liste des alarmes.
-

- 3 Appuyez sur  et sélectionnez **Oui** pour quitter la liste des alarmes.

La radio revient à l'écran d'accueil avec une **icône d'urgence** affichée dans le haut, indiquant une alarme d'urgence non résolue. L' **icône d'urgence** disparaît une fois que l'entrée dans la liste des alarmes est supprimée.

- 4 Appuyez sur  pour accéder au menu.
-

5 Sélectionnez *Liste des alarmes* pour consulter de nouveau la liste des alarmes.



6 La tonalité retentit et le voyant DEL rouge clignote jusqu'à ce que vous quittiez le mode d'urgence. Cependant, la tonalité peut être coupée. Faites un des suivants :

- Appuyez sur le bouton **PTT** pour appeler le groupe de radios pour lequel une alarme d'urgence a été émise.
 - Appuyez sur n'importe quelle touche programmable.
-

Réponse à une alarme d'urgence

Lorsqu'une alarme d'urgence est reçue, le destinataire peut choisir de supprimer l'alarme et quitter la liste des alarmes, ou il peut répondre à une alarme d'urgence en appuyant sur le bouton **PTT** et la transmission voix sans urgence. Suivez la procédure suivante pour répondre à une alarme d'urgence à partir de votre radio.

1 Si l'indication d'alarme d'urgence est activée, la liste des alarmes d'urgence s'affiche lorsque la radio

reçoit une alarme d'urgence. Appuyez sur  ou  jusqu'à l'alias ou l'ID voulu.

2 Si l'indicateur Canal libre est activé, une courte tonalité d'avertissement se fait entendre lorsque l'utilisateur de la radio émettrice cesse d'appuyer sur le bouton **PTT**, vous indiquant que le canal est libre et que vous pouvez répondre. Appuyez sur le bouton **PTT** pour transmettre un message vocal sans urgence au groupe ciblé par l'alarme d'urgence. Le voyant DEL vert s'allume.

3 Faites un des suivants :

- Attendez la fin de la tonalité d'autorisation de parler (si elle est activée) et parlez clairement dans le microphone.
 - Attendez la fin de l'effet local **PTT** (s'il est activé) et parlez clairement dans le microphone.
-

4 Relâchez le bouton **PTT** pour écouter.

Lorsque la radio à l'origine de la transmission d'urgence répond :

- Le voyant DEL rouge clignote.

- L'écran affiche l'icône **Appel d'urgence**, l'alias ou l'ID du groupe d'appels d'urgence et l'ID ou l'alias de la radio à l'origine de la transmission.
- La ligne de texte affiche l'ID ou l'alias du groupe d'appels d'urgence et l'ID ou l'alias de la radio à l'origine de la transmission.



AVIS:

Si l'indication d'appel d'urgence n'est pas activée, l'écran affiche l'icône **Appel de groupe**, l'alias ou l'ID du groupe d'appels d'urgence et l'ID ou l'alias de la radio à l'origine de la transmission.

Répondre à des alarmes d'urgence par un appel

Suivez la procédure suivante pour répondre à un message d'urgence avec appel à partir de votre radio.

Lorsque vous recevez un appel d'urgence :

- La tonalité d'appel d'urgence retentit si l'indication d'appel d'urgence et la tonalité de déchiffrement d'appel d'urgence sont activées. La tonalité d'appel d'urgence ne retentira pas si seulement que l'indication d'appel d'urgence est activée.
- L'icône **Appel d'urgence** s'affiche dans le coin droit supérieur de l'écran.

- Votre radio désactive la sourdine et l'appel entrant se fait entendre sur le haut-parleur.
 - 1 Si l'indicateur Canal libre est activé, une courte tonalité d'avertissement se fait entendre lorsque l'utilisateur de la radio émettrice cesse d'appuyer sur le bouton **PTT**, vous indiquant que le canal est libre et que vous pouvez répondre. Pour prendre l'appel, appuyez sur le bouton **PTT**.
Le voyant DEL vert s'allume.

-
- 2 Attendez la fin de la tonalité d'autorisation de parler (si elle est activée) et parlez clairement dans le microphone.

-
- 3 Relâchez le bouton **PTT** pour écouter.

Lorsque la radio à l'origine de la transmission d'urgence répond :

- Le voyant DEL rouge clignote.

- L'écran affiche l'icône **Appel d'urgence**, l'alias ou l'ID du groupe d'appels d'urgence et l'ID ou l'alias de la radio à l'origine de la transmission.

**AVIS:**

Si l'indication d'appel d'urgence n'est pas activée, l'écran affiche l'icône **Appel de groupe**, l'alias ou l'ID du groupe d'appels d'urgence et l'ID ou l'alias de la radio à l'origine de la transmission.

Message d'état

Cette fonction permet à l'utilisateur d'envoyer des messages d'état à d'autres radios.

La liste d'états rapides est configurée dans le CPS-RM et comprend un maximum de 99 états.











Un message texte peut comporter au maximum 16 caractères.



**AVIS:**

Chaque état a une valeur numérique correspondante allant de 0 à 99. Un alias peut être spécifié pour chaque état pour plus de commodité.

Envoi de messages d'état

Suivez la procédure ci-dessous pour envoyer un message d'état.

- 1 Faites un des suivants :
 - Appuyez sur la touche d'**accès direct** programmée. Ignorez les étapes suivantes.
 - Appuyez sur  pour accéder au menu.
- 2 Appuyez sur  ou  jusqu'à **État**. Appuyez sur  pour effectuer la sélection.
- 3 Appuyez sur  ou  jusqu'à **État rapide**. Appuyez sur  pour effectuer la sélection.
- 4 Appuyez sur  ou  jusqu'au message d'état voulu. Appuyez sur  pour effectuer la sélection.

- 5 Appuyez sur  ou  jusqu'à l'alias ou l'ID d'abonné ou de groupe voulu. Appuyez sur  pour effectuer la sélection.
-

En cas de réussite :

- Une tonalité de réussite se fait entendre.
- Le voyant DEL s'éteint.
- L'écran affiche un bref avis de réussite avant de revenir à l'écran `État rapide`.
- L'écran affiche  à côté du message d'état envoyé.



En cas d'échec :



- Une tonalité d'échec se fait entendre.
- Le voyant DEL s'éteint.
- L'écran affiche un bref avis d'échec avant de revenir à l'écran `État rapide`.

Envoi de message d'état à l'aide de la touche programmable

Suivez la procédure suivante pour envoyer un message d'état à l'aide de la touche programmable.

- 1 Appuyez sur la touche programmée **Message d'état**.
-

- 2 Appuyez sur  ou  jusqu'au message d'état voulu. Appuyez sur  pour effectuer la sélection. La liste de contacts est affichée.
-

- 3 Appuyez sur  ou  jusqu'à l'alias ou l'ID d'abonné ou de groupe voulu. Appuyez sur  pour effectuer la sélection.
-

En cas de réussite :

- Une tonalité de réussite se fait entendre.
- Le voyant DEL s'éteint.
- L'écran affiche un bref avis de réussite avant de revenir à l'écran `État rapide`.
- L'écran affiche  à côté du message d'état envoyé.

En cas d'échec :



- Une tonalité d'échec se fait entendre.
- Le voyant DEL s'éteint.



- L'écran affiche un bref avis d'échec avant de revenir à l'écran État rapide.



Envoi d'un message d'état en utilisant la liste de contacts

Suivez la procédure suivante pour envoyer un message d'état à l'aide de la liste de contacts.

- 1 Appuyez sur  pour accéder au menu.

- 2 Appuyez sur  ou  jusqu'à **Contacts**.
Appuyez sur  pour effectuer la sélection.

- 3 Appuyez sur  ou  jusqu'à l'alias ou l'ID d'abonné ou de groupe voulu. Appuyez sur  pour effectuer la sélection.

- 4 Appuyez sur  ou  jusqu'à **Envoyer état**.
Appuyez sur  pour effectuer la sélection.

- 5 Appuyez sur  ou  jusqu'au message d'état voulu. Appuyez sur  pour effectuer la sélection.

En cas de réussite :

- Une tonalité de réussite se fait entendre.
- Le voyant DEL s'éteint.
- L'écran affiche un bref avis de réussite avant de revenir à l'écran État rapide.
- L'écran affiche  à côté du message d'état envoyé.



En cas d'échec :



- Une tonalité d'échec se fait entendre.
- Le voyant DEL s'éteint.
- L'écran affiche un bref avis d'échec avant de revenir à l'écran État rapide.



Envoi de message d'état à l'aide de la numérotation manuelle

Suivez la procédure suivante pour envoyer un message d'état à l'aide de la numérotation manuelle.



- 1 Appuyez sur  pour accéder au menu.

- 2 Appuyez sur  ou  jusqu'à Contacts.
Appuyez sur  pour effectuer la sélection.

- 3 Appuyez sur  ou  jusqu'à Num. manuelle. Appuyez sur  pour effectuer la sélection.

- 4 Appuyez sur  ou  jusqu'au Numéro de la radio. Appuyez sur  pour effectuer la sélection.

- 5 Entrez l'ID ou l'alias de l'abonné ou du groupe et appuyez sur  pour continuer.

- 6 Appuyez sur  ou  jusqu'à Envoyer état.
Appuyez sur  pour effectuer la sélection.

- 7 Appuyez sur  ou  jusqu'au message d'état voulu. Appuyez sur  pour effectuer la sélection.

En cas de réussite :

- Une tonalité de réussite se fait entendre.
- Le voyant DEL s'éteint.
- L'écran affiche un bref avis de réussite avant de revenir à l'écran État rapide.
- L'écran affiche  à côté du message d'état envoyé.



En cas d'échec :



- Une tonalité d'échec se fait entendre.
- Le voyant DEL s'éteint.
- L'écran affiche un bref avis d'échec avant de revenir à l'écran État rapide.



Affichage des messages d'état

Suivez la procédure ci-dessous pour voir des messages d'état.

- 1 Appuyez sur  pour accéder au menu.

- 2 Appuyez sur  ou  jusqu'à État. Appuyez sur  pour effectuer la sélection.

- 3 Appuyez sur  ou  jusqu'à Boîte de réception. Appuyez sur  pour effectuer la sélection.



- 4 Appuyez sur  ou  jusqu'au message d'état voulu. Appuyez sur  pour effectuer la sélection. Le contenu du message d'état est affiché à l'utilisateur radio.



Les messages d'état reçus peuvent également être consultés en accédant à la liste de notification. Pour obtenir plus de renseignements à ce sujet, consultez la section [Liste de notifications à la page 204](#).



Réponse à des messages d'état

Suivez la procédure ci-dessous pour répondre aux messages d'état.



- 1 Appuyez sur  pour accéder au menu.

- 2 Appuyez sur  ou  jusqu'à État. Appuyez sur  pour effectuer la sélection.

- 3 Appuyez sur  ou  jusqu'à Boîte de réception. Appuyez sur  pour effectuer la sélection.

- 4 Appuyez sur  ou  jusqu'au message d'état voulu. Appuyez sur  pour effectuer la sélection.

- 5 Le contenu de l'état est affiché. Appuyez sur  pour effectuer la sélection.

- 6 Appuyez sur  ou  jusqu'à Répondre. Appuyez sur  pour effectuer la sélection.

- 7 Appuyez sur  ou  jusqu'au message d'état voulu. Appuyez sur  pour effectuer la sélection.
-

En cas de réussite :

- Une tonalité de réussite se fait entendre.
- Le voyant DEL s'éteint.
- L'écran affiche un bref avis de réussite avant de revenir à l'écran Boîte de réception.
- L'écran affiche  à côté du message d'état envoyé.



En cas d'échec :



- Une tonalité d'échec se fait entendre.
- Le voyant DEL s'éteint.
- L'écran affiche un bref avis d'échec avant de revenir à l'écran Boîte de réception.

Suppression d'un message d'état

Suivez la procédure suivante pour supprimer un message d'état de la radio.



- 1 Appuyez sur  pour accéder au menu.
-



- 2 Appuyez sur  ou  jusqu'à État. Appuyez sur  pour effectuer la sélection.
-

- 3 Appuyez sur  ou  jusqu'à Boîte de réception. Appuyez sur  pour effectuer la sélection.
-

- 4 Appuyez sur  ou  jusqu'au message d'état voulu. Appuyez sur  pour effectuer la sélection.
-

- 5 Le contenu de l'état est affiché. Appuyez sur  pour effectuer la sélection.
-

- 6 Appuyez sur  ou  jusqu'à Supprimer. Appuyez sur  pour effectuer la sélection.
-



7 Appuyez sur  ou  jusqu'à Oui. Appuyez sur  pour effectuer la sélection.



- L'écran affiche un bref avis de réussite avant de revenir à l'écran Boîte de réception.



Suppression de tous les messages d'état



Suivez la procédure suivante pour supprimer tous les messages d'état de la radio.

1 Appuyez sur  pour accéder au menu.

2 Appuyez sur  ou  jusqu'à État. Appuyez sur  pour effectuer la sélection.

3 Appuyez sur  ou  jusqu'à Boîte de réception. Appuyez sur  pour effectuer la sélection.

4 Appuyez sur  ou  jusqu'à Tout supprimer. Appuyez sur  pour effectuer la sélection.

5 Appuyez sur  ou  jusqu'à Oui. Appuyez sur  pour effectuer la sélection.

- L'écran affiche Liste vide.

Messagerie texte

Votre radio peut recevoir des données, par exemple un message texte, en provenance d'une autre radio ou d'une application de messagerie texte.

Il existe deux types de messages texte : court message texte et message texte de radio mobile numérique (DMR). La longueur maximale d'un message texte court DMR est de 23 caractères. En mode transmission, un message texte peut comporter un maximum de 280 caractères, ce qui inclut la ligne d'objet. Vous voyez la ligne d'objet lorsque vous recevez un message provenant d'une application courriel.



AVIS:

La longueur maximale de 280 caractères s'applique uniquement pour les modèles avec la dernière version du logiciel et du matériel. Pour les modèles de radio avec les anciens logiciels et matériels, la longueur maximale d'un message texte est de 140 caractères. Pour obtenir des renseignements supplémentaires, adressez-vous à votre détaillant ou à votre administrateur de système.

Messages texte

Les messages texte sont enregistrés de la boîte de réception et classés du plus récent au plus ancien.



Lorsqu'il n'y a aucune activité pendant une durée prédéfinie, la radio quitte l'écran en cours. Vous pouvez revenir à l'écran d'accueil à tout moment en maintenant la



touche  enfoncée.

Affichage des messages texte



Suivez la procédure suivante pour afficher les messages texte sur la radio.

- 1 Appuyez sur  pour accéder au menu.

- 2 Appuyez sur  ou  jusqu'à Messages.
Appuyez sur  pour effectuer la sélection.

- 3 Appuyez sur  ou  jusqu'à Boîte de réception. Appuyez sur  pour effectuer la sélection.

Si la boîte de réception est vide :
 - L'écran affiche Liste vide.
 - Une sonnerie se fait entendre, si la sonnerie du pavé numérique est activée.



- 4 Appuyez sur  ou  jusqu'au message voulu. Appuyez sur  pour effectuer la sélection.



La ligne d'objet pourrait s'afficher si le message provient d'une application de courriel.



Afficher des messages texte d'état de télémétrie

Suivez la procédure permettant d'afficher un message texte d'état de télémétrie à partir de la boîte de réception.

- 1 Appuyez sur  pour accéder au menu.

- 2 Appuyez sur  ou  jusqu'à Messages.
Appuyez sur  pour effectuer la sélection.

- 3 Appuyez sur  ou  jusqu'à Boîte de réception. Appuyez sur  pour effectuer la sélection.

- 4 Appuyez sur  ou  jusqu'au message voulu. Appuyez sur  pour effectuer la sélection.

Vous ne pouvez pas répondre à un message texte d'état de télémétrie.

L'écran affiche Télémétrie : <Status Text Message>.

- 5 Maintenez enfoncée la touche  pour revenir à l'écran d'accueil.

Réponse à des messages texte

Suivez la procédure suivante pour répondre aux messages texte à partir de votre radio.

Lorsque vous recevez un message texte :









- L'écran affiche la liste de notification comprenant l'alias ou l'ID de l'expéditeur.
- L'écran affiche l'icône **Message**.





AVIS:

La radio quitte l'écran d'alerte de message texte et achemine un Appel individuel ou de groupe à l'expéditeur du message si le bouton **PTT** est enfoncé.

- 1 Faites un des suivants :

- Appuyez sur  ou  jusqu'à Lire.
Appuyez sur  pour effectuer la sélection. L'écran affiche le message texte. La ligne d'objet pourrait s'afficher si le message provient d'une application de courriel.
- Appuyez sur  ou  jusqu'à Lire plus tard. Appuyez sur  pour effectuer la sélection. La radio revient à l'écran affiché précédant la réception du message texte.
- Appuyez sur  ou  jusqu'à Supprimer.
Appuyez sur  pour effectuer la sélection.

2 Faites un des suivants :

- Appuyez sur  pour revenir à la boîte de réception.
 - Appuyez à nouveau sur  pour répondre au message texte, le transférer ou le supprimer.
-



Réponse à des messages texte par un texte rapide

Suivez la procédure suivante pour répondre aux messages texte par messages texte rapides à partir de votre radio.



1 Faites un des suivants :

- Appuyez sur la touche programmée **Message texte**. Passez à l'étape 3.
 - Appuyez sur  pour accéder au menu.
-

2

- Appuyez sur  ou  jusqu'à Messages.
Appuyez sur  pour effectuer la sélection.
-



3



- Appuyez sur  ou  jusqu'à Boîte de réception. Appuyez sur  pour effectuer la sélection.
-



4 Appuyez sur  ou  jusqu'au message voulu. Appuyez sur  pour effectuer la sélection.

La ligne d'objet pourrait s'afficher si le message provient d'une application de courriel.

5 Appuyez sur  pour accéder au sous-menu.

6 Appuyez sur  ou  jusqu'à Répondre. Appuyez sur  pour effectuer la sélection.

7 Appuyez sur  ou  jusqu'à Réponse rapide. Appuyez sur  pour effectuer la sélection.

8 Appuyez sur  ou  jusqu'au message voulu. Appuyez sur  pour effectuer la sélection. L'écran affiche un bref avis indiquant que l'envoi du message est en cours.

9 Attendez la confirmation.

En cas de réussite :

- Une tonalité se fait entendre.
- L'écran affiche un bref avis de réussite.

En cas d'échec :

- Une tonalité se fait entendre.
 - L'écran affiche un bref avis d'échec.
 - La radio revient à l'écran d'option Renvoyer.
-

Renvoi des messages texte

Suivez la procédure pour renvoyer des messages texte à partir de votre radio.

Depuis l'écran d'option Renvoyer :

Appuyez sur  pour renvoyer le même message au même alias ou ID d'abonné ou de groupe.

En cas de réussite :

- Une tonalité de réussite se fait entendre.
- L'écran affiche un bref avis de réussite.







En cas d'échec :

- Une tonalité d'échec se fait entendre.
- L'écran affiche un bref avis d'échec.
- La radio revient à l'écran d'option Renvoyer.

Transfère des messages texte

Suivez la procédure suivante pour transférer les messages texte à partir de votre radio.

Depuis l'écran d'option Renvoyer :

- 1 Appuyez sur  ou  jusqu'à Transférer et appuyez sur  pour envoyer le même message à un autre abonné ou un alias de groupe ou un ID.
- 2 Appuyez sur  ou  jusqu'à l'alias ou l'ID voulu. Appuyez sur  pour effectuer la sélection. L'écran affiche un bref avis indiquant que l'envoi du message est en cours.

- 3 Attendez la confirmation.

En cas de réussite :

- Une tonalité se fait entendre.
- L'écran affiche un bref avis de réussite.

En cas d'échec :

- Une tonalité se fait entendre.
- L'écran affiche un bref avis d'échec.





AVIS:

Vous pouvez également sélectionner manuellement l'adresse de la radio cible (consultez la section [Transfère des messages texte à l'aide de la numérotation manuelle à la page 461](#)).

Transfère des messages texte à l'aide de la numérotation manuelle

Suivez la procédure suivante pour transférer les messages texte à l'aide de la numérotation manuelle de votre radio.

1 Appuyez sur  ou  jusqu'à Transférer.

Appuyez sur  pour effectuer la sélection.

2 Appuyez sur  pour envoyer le même message au même alias ou ID d'abonné ou de groupe.

3 Appuyez sur  ou  jusqu'à Num.

manuelle. Appuyez sur  pour effectuer la sélection.

L'écran affiche Numéro de la radio :.

4 Entrez l'ID de l'abonné et appuyez sur  pour continuer.

L'écran affiche un bref avis indiquant que l'envoi du message est en cours.

5 Attendez la confirmation.

En cas de réussite :

- Une tonalité se fait entendre.
- L'écran affiche un bref avis de réussite.

En cas d'échec :

- Une tonalité se fait entendre.
 - L'écran affiche un bref avis d'échec.
-



Modification de messages texte

Sélectionnez **Modifier** pour modifier le message.



AVIS:

Si le message comporte une ligne d'objet (s'il a été envoyé à partir d'une application de courriel), il est impossible de la modifier.





1 Appuyez sur  ou  jusqu'à Modifier.

Appuyez sur  pour effectuer la sélection.

L'écran affiche un curseur clignotant.

2 Utilisez les touches du clavier pour modifier le message.

- Appuyez sur  pour déplacer le curseur d'une espace vers la gauche.







- Appuyez sur  ou  pour déplacer le curseur d'une espace vers la droite.
- Appuyez sur  pour supprimer les caractères inutiles.
- Appuyez longuement sur  pour modifier le mode de saisie de texte.

3 Une fois votre message composé, appuyez sur



.

4 Faites un des suivants :

- Appuyez sur  ou  jusqu'à Envoyer, puis appuyez sur  pour envoyer le message.
- Appuyez sur  ou  jusqu'à Enregistrer, puis appuyez sur  pour enregistrer le message dans le dossier Brouillons.
- Appuyez sur  pour modifier le message.



- Appuyez sur  pour choisir entre la suppression du message ou son enregistrement dans le dossier Brouillons.



Rédaction de messages texte

Suivez la procédure suivante pour rédiger des messages texte sur la radio.

1 Faites un des suivants :

- Appuyez sur la touche programmée **Message texte**. Passez à [étape 3](#).
- Appuyez sur  pour accéder au menu.

2 Appuyez sur  ou  jusqu'à Messages. Appuyez sur  pour effectuer la sélection.

3 Appuyez sur  ou  jusqu'à Composer. Appuyez sur  pour effectuer la sélection. Un curseur clignotant apparaît.

4 Utilisez le clavier pour taper votre message.

Appuyez sur  pour déplacer le curseur d'une espace vers la gauche.

Appuyez sur  ou  pour déplacer le curseur d'une espace vers la droite.





Appuyez sur  pour supprimer les caractères inutiles.

Appuyez longuement sur  pour modifier le mode de saisie de texte.

5 Une fois votre message composé, appuyez sur

.

Faites un des suivants :







- Appuyez sur  pour envoyer le message.
- Appuyez sur . Appuyez sur  ou  pour modifier, supprimer ou enregistrer le message. Appuyez sur  pour effectuer la sélection.

Envoi de messages texte

Suivez la procédure pour envoyer des messages texte sur votre radio.

Supposons que vous avez récemment écrit ou enregistré un message texte.

Sélectionnez le destinataire du message. Faites un des suivants :

- Appuyez sur  ou  Sélectionnez le destinataire du message. Appuyez sur  pour effectuer la sélection.
- Appuyez sur  ou  jusqu'à Num. manuelle. Appuyez sur  pour effectuer la sélection. Entrez l'ID d'abonné. La première ligne de l'écran affiche le message Numéro radio :. La deuxième ligne de l'écran affiche un curseur clignotant. Entrez l'alias ou l'ID d'abonné.
Appuyez sur .

L'écran affiche un bref avis indiquant que l'envoi du message est en cours.

En cas de réussite :

- Une tonalité se fait entendre.
- L'écran affiche un bref avis de réussite.

En cas d'échec :

- Une tonalité faible retentit.
- L'écran affiche un bref avis d'échec.
- Le message est déplacé dans le dossier Messages envoyés.
- Le message est marqué avec une icône Échec d'envoi.



AVIS:



Pour un nouveau message texte écrit, la radio vous renvoie à l'écran d'option Renvoyer.



Suppression des messages texte de la boîte de réception

Suivez la procédure suivante pour supprimer les messages texte de la boîte de réception de la radio.

- 1 Faites un des suivants :

- Appuyez sur la touche programmée **Message texte**. Passez à [étape 3](#).
- Appuyez sur  pour accéder au menu.

-
- 2 Appuyez sur  ou  jusqu'à Messages. Appuyez sur  pour effectuer la sélection.

-
- 3 Appuyez sur  ou  jusqu'à Boîte de réception. Appuyez sur  pour effectuer la sélection.



Si la boîte de réception est vide :



- L'écran affiche Liste vide.
- Une tonalité se fait entendre.

-
- 4 Appuyez sur  ou  jusqu'au message voulu. Appuyez sur  pour effectuer la sélection.

La ligne d'objet pourrait s'afficher si le message provient d'une application de courriel.

5 Appuyez sur  pour accéder au sous-menu.



6 Appuyez sur  ou  jusqu'à Supprimer.
Appuyez sur  pour effectuer la sélection.



7 Appuyez sur  ou  jusqu'à Oui. Appuyez sur  pour effectuer la sélection.
L'écran affiche un bref avis de réussite. L'écran revient à la boîte de réception.

Suppression de tous les messages texte de la boîte de réception



Suivez la procédure suivante pour supprimer tous les messages texte de la boîte de réception de la radio.



- 1 Faites un des suivants :
 - Appuyez sur la touche programmée **Message texte**. Passez à [étape 3](#).
 - Appuyez sur  pour accéder au menu.
-

2 Appuyez sur  ou  jusqu'à Messages.
Appuyez sur  pour effectuer la sélection.

3 Appuyez sur  ou  jusqu'à Boîte de réception. Appuyez sur  pour effectuer la sélection.
Si la boîte de réception est vide :

- L'écran affiche Liste vide.
- Une tonalité se fait entendre.

4 Appuyez sur  ou  jusqu'à Tout supprimer. Appuyez sur  pour effectuer la sélection.

5 Appuyez sur  ou  jusqu'à Oui. Appuyez sur  pour effectuer la sélection.
L'écran affiche un bref avis de réussite.

Messages texte envoyés

Une fois qu'un message texte est envoyé vers une autre radio, il est enregistré dans les messages envoyés. Le dernier message texte envoyé s'affiche toujours en haut de la liste des messages envoyés. Vous pouvez renvoyer, transférer, modifier ou supprimer un message texte envoyé.

Le dossier des messages envoyés peut contenir au maximum les 30 derniers messages envoyés. Une fois le dossier plein, le prochain message envoyé remplace automatiquement le plus ancien message enregistré dans le dossier.

Si vous quittez l'écran d'envoi de message pendant que l'envoi du message est en cours, la radio met à jour l'état du message dans le dossier des messages envoyés sans fournir d'indication sonore ou visuelle.

Si la radio change de mode ou est mise hors tension avant que l'état du message ne soit mis à jour dans le dossier des messages envoyés, la radio ne peut terminer l'envoi du message en cours et marque automatiquement celui-ci d'une icône **Échec de l'envoi**.

La radio prend en charge un maximum de cinq envois de message en cours à la fois. Pendant ce temps, la radio ne peut envoyer aucun autre message et marque

automatiquement les nouveaux messages de l'icône **Échec de l'envoi**.

Vous pouvez revenir à l'écran d'accueil à tout moment en appuyant longuement sur la touche .









AVIS:

Si le type de canal (p. ex. numérique conventionnel, Capacity Plus) ne correspond pas, vous pouvez uniquement modifier, transférer ou supprimer un message envoyé.

Affichage des messages texte envoyés



Suivez la procédure suivante pour afficher des messages texte envoyés à partir de votre radio.

- 1 Faites un des suivants :
 - Appuyez sur la touche programmée **Message texte**. Passez à [étape 3](#).
 - Appuyez sur  pour accéder au menu.
-
- 2 Appuyez sur  ou  jusqu'à **Messages**. Appuyez sur  pour effectuer la sélection.
-

3 Appuyez sur  ou  jusqu'à Messages envoyés. Appuyez sur  pour effectuer la sélection.

Si le dossier Messages envoyés est vide :





- L'écran affiche Liste vide.
- Une tonalité grave se fait entendre, si la sonnerie du pavé numérique est activée.

4 Appuyez sur  ou  jusqu'au message voulu. Appuyez sur  pour effectuer la sélection. L'icône qui s'affiche dans le coin supérieur droit de l'écran indique le statut du message. Voir [Icônes des éléments envoyés](#).

Envoi de messages texte envoyés

Suivez la procédure suivante pour envoyer un message texte envoyé sur votre radio.

Lorsque vous affichez un message envoyé :

- 1 Appuyez sur  .
- 2 Vous pouvez soit renvoyer ou transférer le message texte envoyé. Faites un des suivants :
 -  pour Renvoyer. Appuyez sur  pour effectuer la sélection.
 -  pour Transférer. Appuyez sur  pour effectuer la sélection.

L'écran affiche un bref avis indiquant que l'envoi du message est en cours.

- 3 Attendez la confirmation.

En cas de réussite :

- Une tonalité se fait entendre.
- L'écran affiche un bref avis de réussite.

En cas d'échec :

- Une tonalité se fait entendre.
- L'écran affiche un bref avis d'échec.



- La radio passe à l'écran d'option **Renvoyer**. Pour obtenir plus de renseignements à ce sujet, consultez la section [Renvoi des messages texte à la page 165](#).

Suppression d'un message texte envoyé à partir du dossier messages envoyés

Suivez la procédure suivante pour supprimer les messages texte du dossier des messages envoyés à partir de votre radio.

Lorsque vous affichez un message envoyé :



1 Appuyez sur  .



2 Appuyez sur  ou  jusqu'à **Supprimer**.
Appuyez sur  pour effectuer la sélection.

Suppression de tous les messages texte envoyés du dossier messages envoyés

Suivez la procédure suivante pour supprimer tous les messages texte du dossier des messages envoyés.



- 1 Faites un des suivants :
 - Appuyez sur la touche programmée **Message texte**. Passez à [étape 3](#).
 - Appuyez sur  pour accéder au menu.
-

- 2 Appuyez sur  ou  jusqu'à **Messages**.
Appuyez sur  pour effectuer la sélection.
-







- 3 Appuyez sur  ou  jusqu'à **Messages envoyés**. Appuyez sur  pour effectuer la sélection.

Si le dossier **Messages envoyés** est vide :

- L'écran affiche **Liste vide**.
 - Une tonalité se fait entendre.
-

- 4 Appuyez sur  ou  jusqu'à Tout supprimer. Appuyez sur  pour effectuer la sélection.
-

5 Faites un des suivants :

- Appuyez sur  ou  jusqu'à Oui. Appuyez sur  pour effectuer la sélection. L'écran affiche un bref avis de réussite.
 - Appuyez sur  ou  jusqu'à Non. Appuyez sur  pour effectuer la sélection. La radio revient à l'écran précédent.
-

Messages texte enregistrés

Vous pouvez enregistrer un message texte afin de l'envoyer plus tard.

Si l'écran de rédaction ou de modification de message se ferme pendant que vous rédigez ou modifiez un message texte, par exemple si vous avez appuyé sur le bouton **PTT** ou changé de mode, votre message est automatiquement enregistré dans les brouillons.

Le message texte le plus récent figure toujours en haut de la liste des brouillons.



Le dossier Brouillons permet de stocker au maximum les 10 derniers messages enregistrés. Une fois le dossier plein, le prochain message enregistré remplace automatiquement le plus ancien message enregistré dans le dossier.



Affichage de messages texte enregistrés

Suivez la procédure suivante pour afficher des messages texte enregistrés envoyés à partir de votre radio.

1 Faites un des suivants :

- Appuyez sur la touche programmée **Message texte**. Passez à [étape 3](#).
 - Appuyez sur  pour accéder au menu.
-

2 Appuyez sur  ou  jusqu'à Messages. Appuyez sur  pour effectuer la sélection.



- 3 Appuyez sur  ou  jusqu'à Brouillons.
Appuyez sur  pour effectuer la sélection.
-

- 4 Appuyez sur  ou  jusqu'au message voulu. Appuyez sur  pour effectuer la sélection.
-

Modification de messages texte enregistrés

Suivez la procédure suivante pour modifier des messages texte enregistrés envoyés à partir de votre radio.

- 1 Pendant que vous visualisez le message, appuyez sur .
-

- 2 Appuyez sur  ou  jusqu'à Modifier.
Appuyez sur  pour effectuer la sélection.
Un curseur clignotant apparaît.
-

- 3 Utilisez le clavier pour taper votre message.

Appuyez sur  pour déplacer le curseur d'une espace vers la gauche.







Appuyez sur  ou  pour déplacer le curseur d'une espace vers la droite.

Appuyez sur  pour supprimer les caractères inutiles.

Appuyez longuement sur  pour modifier le mode de saisie de texte.

- 4 Une fois votre message composé, appuyez sur .



Faites un des suivants :



- Appuyez sur  ou  jusqu'à Envoyer.
Appuyez sur  pour envoyer le message.
 - Appuyez sur . Appuyez sur  ou  pour choisir entre supprimer ou enregistrer le message. Appuyez sur  pour effectuer la sélection.
-



Suppression de messages texte enregistrés du dossier brouillons

Suivez la procédure suivante pour supprimer des messages texte enregistrés dans les brouillons sur votre radio.

- 1 Faites un des suivants :
 - Appuyez sur la touche programmée **Message texte**. Passez à [étape 3](#).
 - Appuyez sur  pour accéder au menu.

- 2 Appuyez sur  ou  jusqu'à Messages.
Appuyez sur  pour effectuer la sélection.

- 3 Appuyez sur  ou  jusqu'à Brouillons.
Appuyez sur  pour effectuer la sélection.

- 4 Appuyez sur  ou  jusqu'au message voulu. Appuyez sur  pour effectuer la sélection.

- 5 Appuyez sur  ou  jusqu'à Supprimer.
Sélectionnez  pour supprimer le message texte.

Message texte rapide

Votre radio prend en charge un maximum de 50 messages texte rapides selon la programmation effectuée par votre détaillant.



Les messages texte rapides sont prédéfinis, mais vous pouvez modifier chaque message avant de l'envoyer.

Envoi de messages texte rapides

Suivez la procédure suivante pour envoyer des messages texte rapides prédéfinis sur votre radio à un alias prédéfini.

- 1 Faites un des suivants :
 - Appuyez sur la touche programmée **Message texte**. Passez à [étape 3](#).
 - Appuyez sur la touche d'**accès direct** programmée. Passez à [étape 6](#).
L'écran affiche un bref avis indiquant que l'envoi du message est en cours.



- Appuyez sur  pour accéder au menu.
-

2 Appuyez sur  ou  jusqu'à Messages.

Appuyez sur  pour effectuer la sélection.

3 Appuyez sur  ou  jusqu'à Texte rapide.

Appuyez sur  pour effectuer la sélection.

4 Appuyez sur  ou  jusqu'au texte rapide voulu. Appuyez sur  pour effectuer la sélection.

5 Procédez comme suit pour sélectionner le destinataire et envoyer le message.

L'écran affiche un bref avis indiquant que l'envoi du message est en cours.

6 Attendez la confirmation.

En cas de réussite :

- Une tonalité de réussite se fait entendre.
- L'écran affiche un bref avis de réussite.

En cas d'échec :

- Une tonalité d'échec se fait entendre.
 - L'écran affiche un bref avis d'échec.
 - La radio passe à l'écran d'option Renvoyer. Pour obtenir plus de renseignements à ce sujet, consultez la section [Renvoi des messages texte à la page 165](#).
-

Configuration de saisie de texte

Votre radio vous permet de configurer différents textes.

Vous pouvez configurer les paramètres suivants pour la saisie de texte dans votre radio :

- Prédiction de texte
- Mot correct
- Majuscule en début de phrase
- Mes mots

Votre radio prend en charge les méthodes de saisie de texte suivantes :

- Chiffres
- Symboles

- Frappe prédictive ou multiple
- Langue (si programmée)





**AVIS:**



Appuyez sur  en tout temps pour revenir à l'écran précédent ou maintenez enfoncée la touche



 pour revenir à l'écran d'accueil. Lorsqu'il n'y a aucune activité pendant une durée prédéfinie, la radio quitte l'écran en cours.



Activation ou désactivation du mot correct

Cette option fournit d'autres choix de mots quand le mot entré dans l'éditeur de texte n'est pas reconnu par le dictionnaire intégré.





- 1 Appuyez sur  pour accéder au menu.
- 2 Appuyez sur  ou  jusqu'à Utilitaires.
Appuyez sur  pour effectuer la sélection.



- 3 Appuyez sur  ou  jusqu'au Paramètres de la radio. Appuyez sur  pour effectuer la sélection.

- 4 Appuyez sur  ou  jusqu'à Saisie texte. Appuyez sur  pour effectuer la sélection.

- 5 Appuyez sur  ou  pour désactiver Correction ortho. Appuyez sur  pour effectuer la sélection.

- 6 Faites un des suivants :



- Appuyez sur  ou  pour désactiver Correction ortho. Appuyez sur  pour effectuer la sélection.
- Appuyez sur  pour activer la correction orthographique. Si la fonction est activée, ✓ apparaît à côté d'Activé.



- Appuyez sur  pour désactiver la correction orthographique. Si cette option est désactivée, le  ne s'affiche plus à côté de **Activé**.
-



Activation ou désactivation de la prédiction du texte

Prédiction de texte : Votre radio peut apprendre des séquences de mots courantes que vous entrez souvent. Elle peut alors prédire le prochain mot que vous désirez utiliser après la saisie du premier mot d'une séquence de mots courante dans l'éditeur de texte.

- 1 Appuyez sur  pour accéder au menu.





 - 2 Appuyez sur  ou  jusqu'à **Utilitaires**. Appuyez sur  pour effectuer la sélection.

 - 3 Appuyez sur  ou  jusqu'au **Paramètres de la radio**. Appuyez sur  pour effectuer la sélection.
-

- 4 Appuyez sur  ou  jusqu'à **Saisie texte**. Appuyez sur  pour effectuer la sélection.
-





- 5 Appuyez sur  ou  jusqu'à **Prédiction de texte**. Appuyez sur  pour effectuer la sélection.
-



- 6 Faites un des suivants :



- Appuyez sur  pour activer la prédiction de texte. Si la fonction est activée,  apparaît à côté de **Activé**.
 - Appuyez sur  pour désactiver le contrôle dynamique de la distorsion du microphone. Si cette option est désactivée, le  ne s'affiche plus à côté de **Activé**.
-



Majuscule en début de phrase

Cette fonction met automatiquement la première lettre du premier mot en majuscule pour chaque nouvelle phrase.

- 1 Appuyez sur  pour accéder au menu.
- 2 Appuyez sur  ou  jusqu'à Utilitaires.
Appuyez sur  pour effectuer la sélection.

- 3 Appuyez sur  ou  jusqu'au Paramètres de la radio. Appuyez sur  pour effectuer la sélection.

- 4 Appuyez sur  ou  jusqu'à Saisie texte.
Appuyez sur  pour effectuer la sélection.

- 5 Appuyez sur  ou  pour désactiver Maj. Phrase. Appuyez sur  pour effectuer la sélection.

- 6 Faites un des suivants :



- Appuyez sur  pour activer Maj. phrase. Si la fonction est activée, ✓ apparaît à côté d'Activé.



- Appuyez sur  pour désactiver Maj. phrase. Si cette option est désactivée, le ✓ ne s'affiche plus à côté de Activé.



Afficher des mots personnalisés



Vous pouvez ajouter vos propres mots personnalisés dans le dictionnaire intégré de votre radio. Votre radio contient une liste de ces mots.



- 1 Appuyez sur  pour accéder au menu.

- 2 Appuyez sur  ou  jusqu'à Utilitaires.
Appuyez sur  pour effectuer la sélection.

- 3 Appuyez sur  ou  jusqu'au Paramètres de la radio. Appuyez sur  pour effectuer la sélection.

4 Appuyez sur  ou  jusqu'à Saisie texte.
Appuyez sur  pour effectuer la sélection.



5 Appuyez sur  ou  jusqu'à Mes mots.
Appuyez sur  pour effectuer la sélection.



6 Appuyez sur  ou  jusqu'à Liste de mots. Appuyez sur  pour effectuer la sélection.
L'écran affiche la liste des mots personnalisés.



Modifier des mots personnalisés



Vous pouvez modifier les mots personnalisés enregistrés dans votre radio.



1 Appuyez sur  pour accéder au menu.



2 Appuyez sur  ou  jusqu'à Utilitaires.
Appuyez sur  pour effectuer la sélection.



3 Appuyez sur  ou  jusqu'au Paramètres de la radio. Appuyez sur  pour effectuer la sélection.

4 Appuyez sur  ou  jusqu'à Saisie texte.
Appuyez sur  pour effectuer la sélection.





5 Appuyez sur  ou  jusqu'à Mes mots.
Appuyez sur  pour effectuer la sélection.

6 Appuyez sur  ou  jusqu'à Liste de mots. Appuyez sur  pour effectuer la sélection.
L'écran affiche la liste des mots personnalisés.

7 Appuyez sur  ou  jusqu'au mot voulu.
Appuyez sur  pour effectuer la sélection.

- 8 Appuyez sur  ou  jusqu'à Modifier.
Appuyez sur  pour effectuer la sélection.
-

- 9 Utilisez le clavier pour modifier votre mot personnalisé.

- Appuyez sur  pour déplacer le curseur d'une espace vers la gauche.
 - Appuyez sur la touche  pour déplacer le curseur d'une espace vers la droite.
 - Appuyez sur la touche  pour supprimer les caractères inutiles.
 - Appuyez longuement sur  pour modifier le mode de saisie de texte.
-

- 10 Appuyez sur  une fois que votre mot personnalisé est terminé.
-



L'écran affiche un bref avis indiquant que l'enregistrement de votre mot personnalisé est en cours.



- Si le mot personnalisé est sauvegardé, une tonalité de réussite se fait entendre et l'écran affiche un bref avis de réussite.
- Sinon, une tonalité grave se fait entendre et l'écran affiche un bref avis d'échec.

Ajouter des mots personnalisés

Vous pouvez ajouter des mots personnalisés dans le dictionnaire intégré de la radio.



- 1 Appuyez sur  pour accéder au menu.
-

- 2 Appuyez sur  ou  jusqu'à Utilitaires.
Appuyez sur  pour effectuer la sélection.
-

- 3 Appuyez sur  ou  jusqu'au Paramètres de la radio. Appuyez sur  pour effectuer la sélection.
-

4 Appuyez sur  ou  jusqu'à Saisie texte.

Appuyez sur  pour effectuer la sélection.

5 Appuyez sur  ou  jusqu'à Mes mots.



Appuyez sur  pour effectuer la sélection.

6 Appuyez sur  ou  jusqu'à Ajouter mot.

Appuyez sur  pour effectuer la sélection.

L'écran affiche la liste des mots personnalisés.

7 Utilisez le clavier pour modifier votre mot personnalisé.

- Appuyez sur  pour déplacer le curseur d'une espace vers la gauche.
- Appuyez sur la touche  pour déplacer le curseur d'une espace vers la droite.
- Appuyez sur la touche  pour supprimer les caractères inutiles.

- Appuyez longuement sur  pour modifier le mode de saisie de texte.
-

8 Appuyez sur  une fois que votre mot personnalisé est terminé.



L'écran affiche un bref avis indiquant que l'enregistrement de votre mot personnalisé est en cours.



- Si le mot personnalisé est sauvegardé, une tonalité de réussite se fait entendre et l'écran affiche un bref avis de réussite.
- Sinon, une tonalité grave se fait entendre et l'écran affiche un bref avis d'échec.



Supprimer un mot personnalisé



Suivez la procédure suivante pour supprimer les mots personnalisés enregistrés sur votre radio.



1 Appuyez sur  pour accéder au menu.



2 Appuyez sur  ou  jusqu'à Utilitaires. Appuyez sur  pour effectuer la sélection.

3 Appuyez sur  ou  jusqu'au Paramètres de la radio. Appuyez sur  pour effectuer la sélection.





4 Appuyez sur  ou  jusqu'à Saisie texte. Appuyez sur  pour effectuer la sélection.

5 Appuyez sur  ou  jusqu'à Mes mots. Appuyez sur  pour effectuer la sélection.

6 Appuyez sur  ou  jusqu'au mot voulu. Appuyez sur  pour effectuer la sélection.

7 Appuyez sur  ou  jusqu'à Supprimer. Appuyez sur  pour effectuer la sélection.



8 Sélectionnez un des éléments suivants :



- Au message Supprimer l'entrée?, appuyez sur  pour sélectionner Oui. L'écran affiche Entrée supprimée.
 - Appuyez sur  ou  jusqu'à Non. Appuyez sur  pour revenir à l'écran précédent.
-



Supprimer tous les mots personnalisés



Suivez la procédure suivante pour supprimer tous les mots personnalisés du dictionnaire intégré de votre radio.



1 Appuyez sur  pour accéder au menu.

2 Appuyez sur  ou  jusqu'à Utilitaires. Appuyez sur  pour effectuer la sélection.

3 Appuyez sur  ou  jusqu'au Paramètres de la radio. Appuyez sur  pour effectuer la sélection.



4 Appuyez sur  ou  jusqu'à Saisie texte. Appuyez sur  pour effectuer la sélection.

5 Appuyez sur  ou  jusqu'à Mes mots. Appuyez sur  pour effectuer la sélection.

6 Appuyez sur  ou  jusqu'à Tout supprimer. Appuyez sur  pour effectuer la sélection.

7 Faites un des suivants :

- Au message Supprimer l'entrée?, appuyez sur  pour sélectionner Oui. L'écran affiche Ttes entrées supprimées.

- Appuyez sur  ou  jusqu'à Non pour revenir à l'écran précédent. Appuyez sur  pour effectuer la sélection.

Tickets de tâche

Cette fonction permet à votre radio de recevoir des messages du répartiteur dressant la liste des tâches à effectuer.



AVIS:

Cette fonction peut être personnalisée grâce au CPS selon les exigences des utilisateurs. Pour obtenir des renseignements supplémentaires, adressez-vous à votre détaillant ou à votre administrateur de système.

Il y a deux dossiers qui contiennent différents tickets de tâche :

Le dossier Mes tâches

Les tickets de tâche personnalisés attribués à votre signature dans l'ID utilisateur.

Le dossier Tâches partagées

Les tickets de tâche partagés attribués à un groupe de personnes.

Vous pouvez répondre aux tickets de tâche afin de les classer dans les dossiers de tickets de tâche. Par défaut, les dossiers sont **Tous**, **Nouveaux**, **Commencés** et **Terminés**. Pour obtenir dix autres dossiers, adressez-vous à votre détaillant ou à votre administrateur de système.



AVIS:

Les tickets de tâche sont conservés même lorsque la radio est mise hors tension, puis remise sous tension.

Tous les tickets de tâche sont situés dans le dossier **Tous**. Selon la façon dont votre radio est programmée, les tickets de tâche sont triés par leur niveau de priorité suivi par l'heure de réception. Les nouveaux tickets de tâche, ceux avec les plus récents changements à l'état et ceux avec la plus haute priorité sont affichés en premier. Lorsque le nombre maximum de tickets de tâche est atteint, le prochain ticket de tâche remplace automatiquement le dernier ticket de tâche sur la radio. Votre radio prend en charge un maximum de 100 ou 500 tickets de tâche, selon le modèle de radio. Pour obtenir des renseignements supplémentaires, adressez-vous à votre détaillant ou à votre administrateur de système. Votre radio détectera et annulera automatiquement les tickets de tâche dupliqués qui possèdent le même ID de ticket de tâche.

Selon l'importance du ticket de tâche, le répartiteur ajoute un niveau de priorité pour eux. Il existe trois niveaux de priorité : Priorité 1, Priorité 2 et Priorité 3. La Priorité 1 est la plus haute priorité et la Priorité 3 est la priorité la plus basse. Il existe également des tickets de tâche sans aucune priorité.

Votre radio est mise à jour conformément lorsque le répartiteur effectue les changements suivants :

- Modifier le contenu de tickets de tâche.
- Ajouter ou modifier le niveau de priorité de tickets de tâche.
- Déplacer les tickets de tâche d'un dossier à un autre dossier.
- Annuler des tickets de tâche.



Accès au dossier Tickets de tâche



Suivez la procédure d'accès au dossier Tickets de tâche.



1 Faites un des suivants :

- Appuyez sur la touche programmée **Tickets de tâche**. Passez à [étape 3](#).

- Appuyez sur  pour accéder au menu.
-

2 Appuyez sur  ou  pour voir les Tickets de tâche. Appuyez sur  pour effectuer la sélection.



3 Appuyez sur  ou  jusqu'au dossier voulu. Appuyez sur  pour effectuer la sélection.

4 Appuyez sur  ou  jusqu'au ticket de tâche voulu. Appuyez sur  pour effectuer la sélection.

Connexion ou déconnexion du serveur distant

Cette fonction permet de se connecter et de se déconnecter du serveur distant en utilisant votre ID utilisateur.

1 Appuyez sur  pour accéder au menu.

2 Appuyez sur  ou  jusqu'à Connexion.

Appuyez sur  pour effectuer la sélection.

Si vous êtes déjà connecté, l'option Déconnexion s'affiche dans le menu.

L'écran affiche un bref avis indiquant que l'exécution de la requête est en cours.

3 Attendez la confirmation.

En cas de réussite :

- Une tonalité de réussite se fait entendre.
- L'écran affiche un bref avis de réussite.

En cas d'échec :



- Une tonalité d'échec se fait entendre.
 - L'écran affiche un bref avis d'échec.
-



Création de tickets de tâche

Votre radio peut créer des tickets de tâche, basés sur un modèle de ticket de tâche, et envoyer la liste des tâches à accomplir.

Un logiciel de programmation CPS est nécessaire pour configurer le modèle de ticket de tâche.

- 1 Appuyez sur  pour accéder au menu.



- 2 Appuyez sur  ou  jusqu'aux Tickets de tâche. Appuyez sur  pour effectuer la sélection.



- 3 Appuyez sur  ou  jusqu'à Créer un ticket. Appuyez sur  pour effectuer la sélection.



Répondre à des tickets de tâche

Suivez la procédure suivante pour répondre à des tickets de tâche sur votre radio.



- 1 Appuyez sur  pour accéder au menu.

- 2 Appuyez sur  ou  jusqu'aux Tickets de tâche. Appuyez sur  pour effectuer la sélection.

- 3 Appuyez sur  ou  jusqu'au dossier voulu. Appuyez sur  pour effectuer la sélection.

- 4 Appuyez sur  ou  jusqu'au ticket de tâche voulu. Appuyez sur  pour effectuer la sélection.

- 5 Appuyez de nouveau sur  pour accéder au sous-menu.
 Vous pouvez également appuyer sur la touche numérique correspondante (de 1 à 9) jusqu'à **Réponse rapide**.

- 6 Appuyez sur  ou  jusqu'au ticket de tâche voulu. Appuyez sur  pour effectuer la sélection.
 L'écran affiche un bref avis indiquant que l'exécution de la requête est en cours.

- 7 Attendez la confirmation.
 En cas de réussite :
 - Une tonalité de réussite se fait entendre.

- L'écran affiche un bref avis de réussite.

En cas d'échec :



- Une tonalité d'échec se fait entendre.
 - L'écran affiche un bref avis d'échec.
-



Envoi de tickets de tâche en utilisant un modèle de ticket de tâche

Si votre radio est configurée avec un modèle de ticket de tâche, effectuez les opérations suivantes pour envoyer le ticket de tâche.

- 1 Utilisez le clavier numérique pour saisir le numéro de salle requis. Appuyez sur  pour effectuer la sélection.
-

- 2 Appuyez sur  ou  jusqu'à État de salle. Appuyez sur  pour effectuer la sélection.
-

- 3 Appuyez sur  ou  jusqu'à l'option voulue. Appuyez sur  pour effectuer la sélection.
-

- 4 Appuyez sur  ou  jusqu'à Envoyer. Appuyez sur  pour effectuer la sélection.

L'écran affiche un bref avis indiquant que l'exécution de la requête est en cours.

- 5 Attendez la confirmation.

En cas de réussite :

- Une tonalité de réussite se fait entendre.
- L'écran affiche un bref avis de réussite.

En cas d'échec :



- Une tonalité d'échec se fait entendre.
 - L'écran affiche un bref avis d'échec.
-

Envoi de tickets de tâche en utilisant plus d'un modèle de ticket de tâche

Si votre radio est configurée avec plus d'un modèle de ticket de tâche, effectuez les opérations suivantes pour envoyer les tickets de tâche.

1 Appuyez sur  ou  jusqu'à l'option voulue.

Appuyez sur  pour effectuer la sélection.

2 Appuyez sur  ou  jusqu'à Envoyer.

Appuyez sur  pour effectuer la sélection.

L'écran affiche un bref avis indiquant que l'exécution de la requête est en cours.

3 Attendez la confirmation.

En cas de réussite :

- Une tonalité de réussite se fait entendre.
- L'écran affiche un bref avis de réussite.

En cas d'échec :

- Une tonalité d'échec se fait entendre.

- L'écran affiche un bref avis d'échec.
-



Suppression de tickets de tâche



Suivez la procédure suivante pour supprimer des tickets de tâche de votre radio.



1 Faites un des suivants :

- Appuyez sur la touche programmée **Tickets de tâche**. Passez à [étape 4](#)
 - Appuyez sur  pour accéder au menu.
-



2 Appuyez sur  ou  jusqu'aux Tickets de tâche. Appuyez sur  pour effectuer la sélection.

3 Appuyez sur  ou  jusqu'au dossier voulu. Appuyez sur  pour effectuer la sélection.

4 Appuyez sur  ou  jusqu'au dossier Tous. Appuyez sur  pour effectuer la sélection.

5 Appuyez sur  ou  jusqu'au ticket de tâche voulu. Appuyez sur  pour effectuer la sélection.

6 Appuyez de nouveau sur  pendant que le bon de travail est affiché.

7 Appuyez sur  ou  jusqu'à Supprimer.
Appuyez sur  pour effectuer la sélection.
L'écran affiche un bref avis indiquant que l'exécution de la requête est en cours.

- 8 Attendez la confirmation.
- En cas de réussite :
- Une tonalité de réussite se fait entendre.
 - L'écran affiche un bref avis de réussite.
- En cas d'échec :
- Une tonalité d'échec se fait entendre.
 - L'écran affiche un bref avis d'échec.
-



Supprimer tous les tickets de tâche



Suivez la procédure suivante pour supprimer tous les tickets de tâche de votre radio.



- 1 Faites un des suivants :
- Appuyez sur la touche programmée **Tickets de tâche**. Passez à [étape 3](#).

- Appuyez sur  pour accéder au menu.
-







- 2 Appuyez sur  ou  jusqu'aux Tickets de tâche. Appuyez sur  pour effectuer la sélection.
-

- 3 Appuyez sur  ou  jusqu'au dossier voulu. Appuyez sur  pour effectuer la sélection.
-

- 4 Appuyez sur  ou  jusqu'au dossier Tous. Appuyez sur  pour effectuer la sélection.
-

- 5 Appuyez sur  ou  jusqu'à Tout supprimer. Appuyez sur  pour effectuer la sélection.

- 6 Faites un des suivants :

- Appuyez sur  ou  jusqu'à Oui.
Appuyez sur  pour effectuer la sélection.
L'écran affiche un bref avis de réussite.
- Appuyez sur  ou  jusqu'à Non.
Appuyez sur  pour effectuer la sélection.
La radio revient à l'écran précédent.

Cryptage

Cette fonction fait appel à une solution de brouillage logiciel pour prévenir l'écoute d'un canal par des utilisateurs non autorisés. Les parties de la transmission correspondant au signal et à l'identification de l'utilisateur ne sont pas brouillées.

Sur votre radio, la fonction de cryptage doit être activée sur le canal pour envoyer une transmission cryptée; l'activation

de la fonction n'est cependant pas nécessaire à la réception d'une telle transmission. Pendant qu'un canal crypté est sélectionné, la radio continue d'être en mesure de recevoir des transmissions non brouillées.

Votre radio prend uniquement en charge le cryptage amélioré. Pour décoder un appel crypté, votre radio doit être programmée de façon à utiliser les mêmes valeurs et ID de clé (pour le cryptage amélioré) que la radio émettrice.

Si votre radio reçoit un appel brouillé correspondant à des valeurs et ID de clé différentes, vous n'entendrez rien du tout (pour le cryptage amélioré).

Sur un canal crypté, votre radio est en mesure de recevoir des appels débrouillés, selon la façon dont votre radio est programmée. En outre, votre radio peut jouer un avertissement ou non, selon la façon dont elle est programmée.



AVIS:

Cette fonction n'est pas offerte dans les canaux de bandes citoyennes qui se trouvent dans la même fréquence.

Le voyant DEL vert s'allume pendant que la radio envoie une transmission cryptée et émet un clignotement rapide lorsque la radio reçoit une transmission cryptée.



AVIS:



Certains modèles de radio n'offrent pas cette fonction de cryptage, ou peuvent avoir une configuration différente. Pour obtenir des renseignements supplémentaires, adressez-vous à votre détaillant ou à votre administrateur de système.



Activer ou désactiver le cryptage



Suivez la procédure suivante pour activer ou désactiver la fonction confidentialité de votre radio.

1 Faites un des suivants :









- Appuyez sur la touche programmée **Confidentialité**. Passez les étapes ci-dessous.
- Appuyez sur  pour accéder au menu.

2 Appuyez sur  ou  jusqu'à Utilitaires.
Appuyez sur  pour effectuer la sélection.

3 Appuyez sur  ou  jusqu'au Paramètres de la radio. Appuyez sur  pour effectuer la sélection.

4 Appuyez sur  ou  jusqu'à Confidentialité. Appuyez sur  pour effectuer la sélection.

5 Faites un des suivants :

- Appuyez sur  ou  jusqu'à Activer.
Appuyez sur  pour effectuer la sélection.
L'écran affiche  à côté du message Activé.
- Appuyez sur  ou  jusqu'à Désactiver.
Appuyez sur  pour effectuer la sélection.
L'écran affiche  à côté du message Désactivé.

Interrompre/Raviver

Cette fonction vous permet d'activer ou désactiver n'importe quelle radio du réseau. Par exemple, le détaillant

ou l'administrateur du système pourrait vouloir désactiver une radio volée pour empêcher le voleur de s'en servir, puis la réactiver une fois qu'elle est de nouveau en votre possession.

Une radio peut être désactivée (interrompue) ou activée (ravivé) soit par la console, soit par une commande initiée par une autre radio.

Une fois la radio désactivée, la radio émet une tonalité d'échec et l'écran d'accueil affiche `Canal refusé`.

Lorsqu'une radio est désactivée temporairement, elle ne peut plus demander ni recevoir de services initiés par l'utilisateur sur le système qui a effectué la procédure d'interruption. Cependant, la radio peut basculer vers un autre système. La radio continue d'envoyer des rapports de position GNSS et peut être surveillée à distance lorsqu'elle a été interrompue.





AVIS:

Le détaillant ou l'administrateur de système peut désactiver en permanence une radio. Pour obtenir plus de renseignements à ce sujet, consultez la section [Désactivation permanente de la radio à la page 200](#).

Interrompre une radio

Suivez la procédure suivante pour désactiver votre radio.

1 Appuyez sur la touche programmée **Désac radio**.

2 Appuyez sur  ou  jusqu'à l'alias ou l'ID voulu. Appuyez sur  pour effectuer la sélection. L'écran affiche un bref avis indiquant que l'exécution de la requête est en cours. Le voyant DEL vert clignote.

3 Attendez la confirmation.

En cas de réussite :

- Une tonalité de réussite se fait entendre.
- L'écran affiche un bref avis de réussite.



En cas d'échec :



- Une tonalité d'échec se fait entendre.
 - L'écran affiche un bref avis d'échec.
-



Interruption d'une radio à l'aide de la liste de contacts

Suivez la procédure suivante pour désactiver votre radio à l'aide de la liste de contacts.

- 1 Appuyez sur  pour accéder au menu.

- 2 Appuyez sur  ou  jusqu'à **Contacts**. Appuyez sur  pour effectuer la sélection.

- 3 Appuyez sur  ou  jusqu'à **l'alias ou l'ID voulu**. Appuyez sur  pour effectuer la sélection.

- 4 Appuyez sur  ou  jusqu'à **Désactiver la radio**. Appuyez sur  pour effectuer la sélection. L'écran affiche un bref avis indiquant que l'exécution de la requête est en cours. Le voyant DEL vert clignote.

- 5 Attendez la confirmation.

En cas de réussite :

- Une tonalité de réussite se fait entendre.
- L'écran affiche un bref avis de réussite.



En cas d'échec :

- Une tonalité d'échec se fait entendre.
- L'écran affiche un bref avis d'échec.



Désactiver une radio à l'aide de la numérotation manuelle

Suivez la procédure suivante pour désactiver votre radio à l'aide de la numérotation manuelle.



- 1 Appuyez sur  pour accéder au menu.

- 2 Appuyez sur  ou  jusqu'à **Contacts**. Appuyez sur  pour effectuer la sélection.

3 Appuyez sur  ou  jusqu'à Num. manuelle. Appuyez sur  pour effectuer la sélection.

4 Appuyez sur  ou  jusqu'au Numéro de la radio. Appuyez sur  pour effectuer la sélection. La première ligne de l'écran affiche Numéro de la radio :

5 Entrez l'ID de l'abonné et appuyez sur  pour continuer.

6 Appuyez sur  ou  jusqu'à Désactiver la radio. Appuyez sur  pour effectuer la sélection. L'écran affiche un bref avis indiquant que l'exécution de la requête est en cours. Le voyant DEL vert clignote.

7 Attendez la confirmation.
En cas de réussite :

- Une tonalité de réussite se fait entendre.
- L'écran affiche un bref avis de réussite.



En cas d'échec :

- Une tonalité d'échec se fait entendre.
 - L'écran affiche un bref avis d'échec.
-

Relance d'une radio

Suivez la procédure suivante pour activer la radio.

1 Appuyez sur la touche programmée **Activer la radio**.

2 Appuyez sur  ou  jusqu'à l'alias ou l'ID voulu. Appuyez sur  pour effectuer la sélection. L'écran affiche Activer la radio ainsi que l'alias ou l'ID d'abonné. Le voyant DEL vert s'allume.

3 Attendez la confirmation.

En cas de réussite :

- Une tonalité de réussite se fait entendre.







- L'écran affiche un bref avis de réussite.



En cas d'échec :

- Une tonalité d'échec se fait entendre.
- L'écran affiche un bref avis d'échec.

Relance d'une radio à l'aide de la liste de contacts

Suivez la procédure suivante pour activer votre radio à l'aide de la liste de contacts.

- 1 Appuyez sur  pour accéder au menu.
- 2 Appuyez sur  ou  jusqu'à Contacts. Appuyez sur  pour effectuer la sélection.
- 3 Appuyez sur  ou  jusqu'à l'alias ou l'ID voulu. Appuyez sur  pour effectuer la sélection.



- 4 Appuyez sur  ou  pour activer la radio. Appuyez sur  pour effectuer la sélection. Le voyant DEL vert clignote. L'écran affiche Activer la radio ainsi que l'alias ou l'ID d'abonné. Le voyant DEL vert s'allume.



- 5 Attendez la confirmation.
En cas de réussite :
 - Une tonalité se fait entendre.
 - L'écran affiche Activer la radio réussie.En cas d'échec :
 - Une tonalité se fait entendre.
 - L'écran affiche Échec de l'activation de la radio.



Rallumer une radio à l'aide de la numérotation manuelle

Suivez la procédure suivante pour activer la radio à l'aide de la numérotation manuelle.



- 1 Appuyez sur  pour accéder au menu.

- 2 Appuyez sur  ou  jusqu'à Contacts.
Appuyez sur  pour effectuer la sélection.

- 3 Appuyez sur  ou  jusqu'à Num.
manuelle. Appuyez sur  pour effectuer la sélection.

- 4 Appuyez sur  ou  jusqu'à Appel indiv..
Appuyez sur  pour effectuer la sélection.
La première ligne de l'écran affiche Numéro de la radio :

- 5 Entrez l'ID de l'abonné et appuyez sur  pour continuer.

- 6 Appuyez sur  ou  pour activer la radio. Appuyez sur  pour effectuer la sélection.
Le voyant DEL vert clignote.
L'écran affiche Activer la radio ainsi que l'alias ou l'ID d'abonné. Le voyant DEL vert s'allume.

- 7 Attendez la confirmation.
En cas de réussite :
 - Une tonalité se fait entendre.
 - L'écran affiche Activer la radio réussie.En cas d'échec :
 - Une tonalité se fait entendre.
 - L'écran affiche Échec de l'activation de la radio.

Désactivation permanente de la radio

Cette fonction est une mesure de sécurité améliorée qui restreint l'accès non autorisé à une radio.

La désactivation permanente de la radio rend la radio inutilisable. Par exemple, le détaillant ou l'administrateur de système peut vouloir désactiver une radio perdue ou volée pour en empêcher toute utilisation non autorisée.

Lors de la mise sous tension, une radio désactivée de manière permanente affiche des services Radio arrêtée sur l'écran pendant un moment pour indiquer l'état de désactivation.



AVIS:

La radio désactivée peut uniquement être réactivée dans un centre de réparation de Motorola Solutions. Pour obtenir des renseignements supplémentaires, adressez-vous à votre détaillant ou à votre administrateur de système.

Travailleur solitaire

Cette fonction déclenche le mode d'urgence s'il n'y a aucun signe d'activité par l'utilisateur, tel qu'appuyer sur une

quelconque touche de la radio ou activer le sélecteur de canal, pendant une durée prédéfinie.

Si aucune activité n'est détectée pendant la durée prédéfinie, la radio avertit l'utilisateur de l'expiration du délai d'inactivité au moyen d'un signal sonore.

Si l'utilisateur ne donne aucune réponse à l'avertissement avant l'expiration du délai prédéfini subséquent, la radio active une situation d'urgence selon la programmation du détaillant ou de l'administrateur de site.

Pour obtenir plus de renseignements à ce sujet, consultez la section [Fonctionnement d'urgence à la page 146](#).



AVIS:

Pour obtenir des renseignements supplémentaires, adressez-vous à votre détaillant ou à votre administrateur de système.

Fonctions de verrouillage par mot de passe

Cette fonction vous permet de restreindre l'accès à la radio en demandant un mot de passe lorsqu'elle est allumée.

Vous pouvez utiliser un microphone à clavier ou les touches de **défilement vers le haut/bas** pour entrer le mot de passe.

Accès aux radios à l'aide des mots de passe



Suivez la procédure suivante pour accéder à votre radio en utilisant un mot de passe.

- 1 Entrez le mot de passe à quatre chiffres.



AVIS:

L'utilisation de l'interrupteur d'**urgence** au pied permet d'accéder à la radio sans devoir entrer un mot de passe.

- Utilisez le microphone à clavier.
- Appuyez sur  ou  pour modifier la valeur numérique de chaque chiffre, puis

appuyez sur  pour valider et passer au chiffre suivant.

- 2 Appuyez sur  pour saisir le mot de passe.

En cas de réussite, la radio est mise sous tension.

En cas d'échec :

- Après la première et seconde tentative, l'écran affiche Mot de passe erroné. Répétez l'étape [étape 1](#).
- Après une troisième tentative incorrecte, l'écran affiche Mot de passe erroné puis, Verrouillage radio. Une tonalité se fait entendre. Le voyant DEL jaune clignote en double. La radio se verrouille pendant 15 minutes.



AVIS:

En état de verrouillage, la radio réagit uniquement aux commandes du bouton **Marche/Arrêt/Volume** et de la touche programmée **Rétroéclairage**.

Déverrouillage de la radio

Lorsqu'elle est verrouillée, la radio ne peut recevoir aucun appel. Suivez la procédure suivante pour déverrouiller une radio verrouillée.

Faites un des suivants :



- Si la radio est allumée, patientez 15 minutes et répétez les étapes de la section [Accès aux radios à l'aide des mots de passe à la page 201](#) pour accéder à la radio.
- Si la radio est éteinte, allumez-la. La radio redémarre la minuterie de verrouillage de 15 minutes. Une tonalité se fait entendre. Le voyant DEL jaune clignote en double. L'écran affiche Radio verrouillée.



Patientez 15 minutes et répétez les étapes de la section [Accès aux radios à l'aide des mots de passe à la page 201](#) pour accéder à la radio.



Activation/désactivation du verrouillage par mot de passe



Suivez la procédure suivante pour activer ou désactiver le verrouillage par mot de passe de votre radio.

- 1 Appuyez sur  pour accéder au menu.

- 2 Appuyez sur  ou  jusqu'à Utilitaires.
Appuyez sur  pour effectuer la sélection.









- 3 Appuyez sur  ou  jusqu'au Paramètres de la radio. Appuyez sur  pour effectuer la sélection.

- 4 Appuyez sur  ou  jusqu'à Mot de passe verr.. Appuyez sur  pour effectuer la sélection.

- 5 Entrez le mot de passe à quatre chiffres.
 - Utilisez le microphone à clavier.
 - Appuyez sur  ou  pour modifier la valeur numérique de chaque chiffre, puis appuyez sur  pour valider et passer au chiffre suivant.
Vous entendrez une tonalité de réussite chaque fois que vous appuyez sur un chiffre.





- 6 Appuyez sur  pour saisir le mot de passe.
Si le mot de passe n'est pas valide, l'écran affiche Mot de passe erroné et revient automatiquement au menu précédent.



7 Faites un des suivants :



- Appuyez sur  ou  jusqu'à Activer.
Appuyez sur  pour effectuer la sélection.
L'écran affiche  à côté de Allumer.
- Appuyez sur  ou  jusqu'à Eteindre.
Appuyez sur  pour effectuer la sélection.
L'écran affiche  à côté de Eteindre.

Changement de mot de passe

Suivez la procédure suivante pour modifier le mot de passe sur votre radio.



- 1 Appuyez sur  pour accéder au menu.
- 2 Appuyez sur  ou  jusqu'à Utilitaires.
Appuyez sur  pour effectuer la sélection.

- 3 Appuyez sur  ou  jusqu'au Paramètres de la radio. Appuyez sur  pour effectuer la sélection.

- 4 Appuyez sur  ou  jusqu'à Mot de passe verr.. Appuyez sur  pour effectuer la sélection.

- 5 Entrez le mot de passe actuel à quatre chiffres, puis appuyez sur  pour continuer.

Si le mot de passe n'est pas valide, l'écran affiche Mot de passe erroné et revient automatiquement au menu précédent.

- 6 Appuyez sur  ou  jusqu'à Changer le MdP. Appuyez sur  pour effectuer la sélection.

- 7 Entrez un nouveau mot de passe à quatre chiffres, puis appuyez sur  pour continuer.

- Entrez de nouveau le mot de passe à quatre chiffres, puis appuyez sur  pour continuer.

En cas de réussite, l'écran affiche Mot de passe changé.

En cas d'échec, l'écran affiche Mots de passe incorrects.

L'écran revient automatiquement au menu précédent.

Liste de notifications

Votre radio offre une liste de notification qui rassemble tous les événements « non lus » sur le canal, par exemple les messages texte, les messages de télémétrie, les appels manqués et les avertissements d'appel.







L'écran affiche l'icône **Notification** lorsque la liste de notification comprend au moins un événement.

La liste prend en charge au maximum quarante (40) événements non lus. Une fois la liste pleine, le prochain événement remplace automatiquement l'événement le plus ancien. Une fois les événements lus, ils sont retirés de la liste de notifications.

Dans le cas de messages texte, d'appels manqués ou d'événements d'avertissement d'appel, le nombre maximum est de 30 messages texte et 10 appels manqués ou avertissements d'appel. Ce nombre maximum est fonction des capacités de liste de chaque fonction (tickets de tâche, message texte ou appels manqués et avertissements d'appel).

Accès à liste de notification

Suivez la procédure suivante pour accéder à la liste de notification sur votre radio.

- Appuyez sur  pour accéder au menu.
- Appuyez sur  ou  jusqu'à Notifications. Appuyez sur  pour effectuer la sélection.
- Appuyez sur  ou  jusqu'à l'évènement voulu. Appuyez sur  pour effectuer la sélection.

Maintenez enfoncée la touche  pour revenir à l'écran d'accueil.

Programmation par onde radio

Votre détaillant peut mettre à jour à distance votre radio à partir de la programmation par radiocommunication (OTAP) sans connexion physique. De plus, certains paramètres peuvent être configurés à partir de la programmation par radiocommunication.

Lorsque votre radio est programmée par OTAP, le voyant DEL vert clignote.

Lorsque votre radio reçoit des données à volume élevé :

- L'écran affiche l'icône **Données à volume élevé**.
- Le canal devient occupé.
- Une tonalité d'échec se fait entendre si vous appuyez sur le bouton **PTT**.

Lorsque l'OTAP est terminée, selon la configuration :

- Une tonalité se fait entendre. L'écran affiche `Actualisation Redémarrage`. La radio redémarre en se mettant hors tension puis à nouveau sous tension.

- Vous pouvez sélectionner `Redémarrer maintenant` ou `Reporter`. Lorsque vous sélectionnez `Reporter`, votre radio revient à l'écran précédent. L'écran affiche l'icône **Retardateur OTAP** jusqu'à ce que le démarrage automatique se produise.

Lorsque votre radio se met sous tension après un redémarrage automatique :

- En cas de réussite, l'écran affiche `MàJ logiciel réussie`.
- En cas d'échec, l'écran affiche `Échec de la MàJ logiciel`.

Reportez-vous à [Vérification des informations de mise à jour du logiciel à la page 237](#) pour connaître la version logicielle mise à jour.



Sélection de modes de connexion de périphériques tiers



Suivez la procédure suivante pour sélectionner l'un des modes de connexion de périphériques tiers :



- Motorola Solutions
- PC et audio
- Accès aux données



- Télémétrie
- Générique

1 Appuyez sur  pour accéder au menu.

2 Appuyez sur  ou  jusqu'à Utilitaires.
Appuyez sur  pour effectuer la sélection.

3 Appuyez sur  ou  jusqu'au Paramètres de la radio. Appuyez sur  pour effectuer la sélection.

4 Appuyez sur  ou  jusqu'à Type câble.
Appuyez sur  pour effectuer la sélection.

5 Appuyez sur  ou  jusqu'au mode de connexion voulu. Appuyez sur  pour effectuer la sélection.

Cet écran montre le mode de connexion sélectionné. L'écran revient au menu précédent.

Indicateur d'intensité du signal reçu



Cette fonction vous permet de prendre connaissance des valeurs de l'indicateur d'intensité du signal reçu (RSSI).

L'écran affiche l'icône **RSSI** dans le coin supérieur droit. Consultez la section [Icônes d'affichage](#) pour des détails sur l'icône **RSSI**.

Affichage des valeurs RSSI (indicateur d'intensité de réception du signal)

Suivez la procédure suivante pour afficher les valeurs RSSI sur votre radio.

Lorsque vous êtes à l'écran d'accueil :

- 1 Appuyez trois fois sur la touche  et appuyez immédiatement trois fois sur la touche , le tout en 5 secondes.

L'écran affiche les valeurs RSSI courantes.

- 2 Maintenez enfoncée la touche  pour revenir à l'écran d'accueil.

Configuration du panneau avant



Il est possible de personnaliser certains paramètres des fonctions de Configuration du panneau avant (FPC) afin d'améliorer l'utilisation de votre radio.



Entrée dans la Mode de configuration du panneau avant

Suivez la procédure suivante pour entrer en mode programmation à partir du panneau avant de votre radio.

Vous pouvez revenir à l'écran d'accueil à tout moment en maintenant la touche  enfoncée.



- 1 Appuyez sur  pour accéder au menu.

- 2 Appuyez sur  ou  jusqu'à Utilitaires. Appuyez sur  pour effectuer la sélection.

- 3 Appuyez sur  ou  jusqu'à Programmer la radio. Appuyez sur  pour effectuer la sélection.

Modifier les paramètres de mode FPC

Utilisez les touches suivantes au besoin pendant la navigation dans les paramètres.

- ,  – Pour parcourir les options, augmenter ou réduire les valeurs ou naviguer verticalement.
-  – Pour sélectionnez l'option ou entrer dans un sous-menu.

-  – Appuyez brièvement pour revenir au menu précédent ou quitter l'écran de sélection. Maintenez cette touche enfoncée pour revenir à l'écran d'accueil.

Fonctionnement Wi-Fi

Cette fonction vous permet de configurer un réseau Wi-Fi et de vous connecter à ce réseau. Le Wi-Fi prend en charge les mises à jour de micrologiciel de la radio, de la codeplug, et des ressources telles que les modules de langues et les annonces vocales.



AVIS:

Cette fonction s'applique aux modèles XPR 5550e/XPR 5580e uniquement.

Wi-Fi® est une marque déposée de Wi-Fi Alliance®.

Votre radio prend en charge les réseaux Wi-Fi d'entreprise WEP/WPA/WPA2 personnels et WPA/WPA2 d'entreprise.

Réseau Wi-Fi WEP/WPA/WPA2 personnel

Utilise l'authentification basée sur clé prépartagée (mot de passe).

La clé prépartagée peut être saisie à partir du menu ou du CPS/RM.

Réseau Wi-Fi WPA/WPA2 d'entreprise

Utilise l'authentification basée sur certificat.

Votre radio doit être préconfigurée avec un certificat.



AVIS:

Vérifiez auprès de votre détaillant ou de votre administrateur de système la procédure de connexion à un réseau Wi-Fi WPA/WPA2 d'entreprise.

Activer ou désactiver la fonction Wi-Fi



La touche programmée **Wi-Fi Off** ou **On** est attribuée par défaut. Vérifiez auprès du détaillant ou de votre administrateur de système pour savoir de quelle façon votre radio a été programmée.



Les annonces vocales pour la touche programmée **Wi-Fi On** ou **Off** peut être personnalisé par le CPS selon les exigences des utilisateurs. Pour obtenir des renseignements supplémentaires, adressez-vous à votre détaillant ou à votre administrateur de système.



Vous pouvez activer ou désactiver le Wi-Fi en effectuant l'une des actions suivantes.



- Appuyez sur la touche programmée **Wi-Fi activé ou désactivé**. L'annonce vocale Activation du Wi-Fi ou Désactivation du Wi-Fi se fait entendre.
- Accédez à cette fonction à partir du menu.

a. Appuyez sur  pour accéder au menu.

b. Appuyez sur  ou  pour choisir le Wi-Fi, puis sur appuyez sur  pour sélectionner.

c. Appuyez sur  ou  pour choisir le Wi-Fi On, puis sur appuyez sur  pour sélectionner.

Appuyez sur  pour activer le Wi-Fi. L'écran affiche  à côté du message Activé.

Appuyez sur  pour désactiver le Wi-Fi. L'icône  ne s'affiche plus à côté du message Activé.

Connexion à un point d'accès réseau

Lorsque vous activez le Wi-Fi, la radio recherche un point d'accès réseau et s'y connecte.









AVIS:



Vous pouvez également vous connecter à un point d'accès réseau à partir du menu.

Les points d'accès réseau Wi-Fi WPA d'entreprise sont préconfigurés. Vérifiez auprès du détaillant ou de votre administrateur de système pour savoir de quelle façon votre radio a été programmée.

1 Appuyez sur  pour accéder au menu.

2 Appuyez sur  ou  pour choisir le Wi-Fi, puis sur appuyez sur  pour sélectionner.



3 Appuyez sur  ou  pour les Réseaux, puis sur appuyez sur  pour sélectionner.

- 4 Appuyez sur  ou  pour un point d'accès réseau, puis sur appuyez sur  pour sélectionner.



AVIS:

Pour un réseau Wi-Fi WPA d'entreprise, si un point d'accès réseau n'est pas préconfiguré, l'option *Connecter* n'est pas disponible.

- 5 Appuyez sur  ou  pour se *Connecter*, puis sur appuyez sur  pour sélectionner.

- 6 Pour un réseau Wi-Fi WPA personnel, entrez le mot de passe et appuyez sur  .

- 7 Pour un réseau Wi-Fi WPA d'entreprise, le mot de passe est configuré à partir de RM.
Si le mot de passe préconfiguré est correct, votre radio se connecte automatiquement au point d'accès réseau sélectionné.

Si le mot de passe préconfiguré n'est pas valide, l'écran affiche *Authenticat. - Échec* et revient automatiquement au menu précédent.

Lorsque la connexion est réussie, la radio affiche un avis et le point d'accès réseau est enregistré dans la liste des profils.

Si la connexion échoue, la radio affiche l'écran d'avis d'échec pendant un moment et revient automatiquement au menu précédent.

Vérification de l'état de la connexion Wi-Fi

Suivez la procédure suivante pour vérifier l'état de la connexion Wi-Fi.

Appuyez sur la touche programmée **Requête d'état Wi-Fi** pour connaître l'état de la connexion avec l'annonce vocale. L'annonce vocale indique *Le Wi-Fi est désactivé*, *Le Wi-Fi est activé*, mais il n'y a pas de connexion ou *Le Wi-Fi est activé avec connexion*.

- L'écran affiche *Wi-Fi désactivé* lorsque le Wi-Fi est désactivé.

- L'écran affiche Wi-Fi activé, connecté lorsque la radio est connectée à un réseau.
- L'écran affiche Wi-Fi activé, déconnectée lorsque le Wi-Fi est activé, mais que la radio n'est pas connectée à un réseau.

Les annonces vocales pour la touche programmée Requête d'état Wi-Fi peuvent être personnalisées par le CPS selon les exigences des utilisateurs. Pour obtenir des renseignements supplémentaires, adressez-vous à votre détaillant ou à votre administrateur de système.









AVIS:

La touche programmée **Requête d'état Wi-Fi** est affectée par défaut. Vérifiez auprès du détaillant ou de votre administrateur de système pour savoir de quelle façon votre radio a été programmée.



Actualisation de la liste de réseaux

Suivez la procédure pour actualiser la liste de réseaux.

- Effectuez les opérations suivantes pour actualiser la liste de réseaux à partir du menu.

- Appuyez sur  pour accéder au menu.
- Appuyez sur  ou  pour choisir le Wi-Fi, puis sur appuyez sur  pour sélectionner
- Appuyez sur  ou  pour les Réseaux, puis sur appuyez sur  pour sélectionner. Quand vous entrez dans le menu Réseaux, la radio actualise automatiquement la liste des réseaux.

- Si vous êtes déjà dans le menu Réseaux, effectuez l'action suivante pour actualiser la liste de réseaux.

Appuyez sur  ou  pour Actualiser, puis sur appuyez sur  pour sélectionner.

La radio s'actualise et affiche la dernière liste de réseaux.

Ajout d'un réseau









AVIS:



Cette tâche n'est pas applicable aux réseaux Wi-Fi WPA d'entreprise.

Si un réseau préféré n'est pas dans la liste de réseaux disponibles, effectuez les opérations suivantes pour ajouter un réseau.

- 1 Appuyez sur  pour accéder au menu.

- 2 Appuyez sur  ou  pour choisir le Wi-Fi, puis sur appuyez sur  pour sélectionner.

- 3 Appuyez sur  ou  pour les Réseaux, puis sur appuyez sur  pour sélectionner.

- 4 Appuyez sur  ou  pour Ajouter un réseau, puis sur appuyez sur  pour sélectionner.

- 5 Entrez l'identifiant SSID (Service Set Identifier), puis appuyez sur  .



- 6 Appuyez sur  ou  pour l'Ouvrir, puis sur appuyez sur  pour sélectionner.

- 7 Entrez le mot de passe et appuyez sur  .
La radio affiche un mini-avis positif pour indiquer que le réseau est correctement enregistré.



Affichage des détails de points d'accès réseau



Vous pouvez afficher les détails des points d'accès réseau.

- 1 Appuyez sur  pour accéder au menu.

- 2 Appuyez sur  ou  pour choisir le Wi-Fi, puis sur appuyez sur  pour sélectionner.

3 Appuyez sur  ou  pour les Réseaux, puis sur appuyez sur  pour sélectionner.

4 Appuyez sur  ou  pour un point d'accès réseau, puis sur appuyez sur  pour sélectionner.

5 Appuyez sur  ou  pour afficher les détails, puis sur appuyez sur  pour sélectionner.



AVIS:

L'écran affiche des détails différents pour les points d'accès réseau Wi-Fi WPA personnel et Wi-Fi WPA d'entreprise.

Wi-Fi WPA personnel

Pour un point d'accès réseau connecté, votre radio affiche l'identifiant Service Set Identifier (SSID), le mode de sécurité, l'adresse Media Access Control (MAC) et l'adresse Internet Protocol (IP).

Pour un point d'accès réseau non connecté, votre radio affiche le SSID et le mode de sécurité.

Wi-Fi WPA d'entreprise

Pour un point d'accès réseau connecté, votre radio affiche le SSID, le mode de sécurité, l'identité, la méthode Extended Authentication Protocol (EAP), l'authentification de phase 2, le nom du certificat, l'adresse MAC, l'adresse IP, la passerelle, le DNS1 et le DNS2.

Pour un point d'accès réseau non connecté, votre radio affiche le SSID, le mode de sécurité, l'identité, la méthode EAP, l'authentification de phase 2 et le nom du certificat.

Retrait de points d'accès réseau



AVIS:

Cette tâche n'est pas applicable aux réseaux Wi-Fi d'entreprise.



Effectuez les opérations suivantes pour supprimer des points d'accès réseau dans la liste de profils.

1 Appuyez sur  pour accéder au menu.

- 2 Appuyez sur  ou  pour choisir le Wi-Fi, puis sur appuyez sur  pour sélectionner.

- 3 Appuyez sur  ou  pour les Réseaux, puis sur appuyez sur  pour sélectionner.

- 4 Appuyez sur  ou  pour sélectionner un point d'accès réseau, puis sur appuyez sur  pour sélectionner.

- 5 Appuyez sur  ou  pour le Supprimer, puis sur appuyez sur  pour sélectionner.

- 6 Appuyez sur  ou  pour choisir Oui, puis sur appuyez sur  pour sélectionner.
La radio affiche un mini-avis positif pour indiquer que le point d'accès réseau sélectionné est supprimé avec succès.

Utilitaires

Ce chapitre décrit le fonctionnement des fonctions utilitaires disponibles sur votre radio.

Niveaux de puissance

Vous pouvez personnaliser le niveau de puissance de votre radio en réglant celui-ci à Haut ou Bas pour chaque canal.

Haute

Ce réglage permet la communication avec des radios considérablement éloignées.

Faible

Ce réglage permet la communication avec des radios situées à proximité.



AVIS:

Cette fonction n'est pas offerte dans les canaux de bandes citoyennes qui se trouvent dans la même fréquence.

Configuration de la puissance



Suivez la procédure suivante pour configurer la puissance de votre radio.



1 Faites un des suivants :

- Appuyez sur la touche programmée **Niveau de puissance**. Passez les étapes ci-dessous.
- Appuyez sur  pour accéder au menu.



2 Appuyez sur  ou  jusqu'à

Utilitaires. Appuyez sur  pour effectuer la sélection.



3 Appuyez sur  ou  jusqu'au Paramètres de la radio. Appuyez sur  pour effectuer la sélection.



4 Appuyez sur  ou  jusqu'à Puissance. Appuyez sur  pour effectuer la sélection.

5 Faites un des suivants :

- Appuyez sur  ou  jusqu'à Haut. Appuyez sur  pour effectuer la sélection.

L'écran affiche  à côté de Haut.

- Appuyez sur  ou  jusqu'à Basse.

Appuyez sur  pour effectuer la sélection. L'écran affiche  à côté de Basse.



6 Maintenez enfoncée la touche  pour revenir à l'écran d'accueil.



Activation ou désactivation des sonneries et alertes de la radio



Vous pouvez activer ou désactiver toutes les tonalités et alertes, si nécessaire, à l'exception de la tonalité d'alerte entrante. Suivez la procédure suivante pour activer ou désactiver les sonneries et les alertes sur votre radio.



1 Faites un des suivants :

- Appuyez sur le bouton programmé **Sonneries/Alertes**. Ignorez les étapes suivantes.
- Appuyez sur  pour accéder au menu.



2 Appuyez sur  ou  jusqu'à Utilitaires.Appuyez sur  pour effectuer la sélection.

3 Appuyez sur  ou  jusqu'au Paramètres de la radio.Appuyez sur  pour effectuer la sélection.

4 Appuyez sur  ou  jusqu'à Tonalités/Avertissements.Appuyez sur  pour effectuer la sélection.

5 Appuyez sur  ou  jusqu'à Toutes les tonalités et tous les avertissements.Appuyez sur  pour effectuer la sélection.



6 Appuyez sur  pour activer ou désactiver toutes les tonalités et tous les avertissements. L'écran affiche un des résultats suivants :



- Si la fonction est activée,  apparaît à côté d'Activé.
 - Si cette option est désactivée, le  ne s'affiche plus à côté de Activé.
-



Activer ou désactiver les tonalités du clavier



Suivez la procédure suivante pour activer ou désactiver les tonalités du clavier sur votre radio.

1 Appuyez sur  pour accéder au menu.



2 Appuyez sur  ou  jusqu'à Utilitaires.Appuyez sur  pour effectuer la sélection.

3 Appuyez sur  ou  jusqu'au Paramètres de la radio.Appuyez sur  pour effectuer la sélection.

4 Appuyez sur  ou  jusqu'à Trinités/Alertes. Appuyez sur  pour effectuer la sélection.

5 Appuyez sur  ou  jusqu'à Tonalités du clavier numérique. Appuyez sur  pour effectuer la sélection.



6 Appuyez sur  pour activer ou désactiver les tonalités du clavier. L'écran affiche un des résultats suivants :



- Si la fonction est activée,  apparaît à côté d'Activé.
- Si cette option est désactivée, le  ne s'affiche plus à côté de Activé.



Configuration de la compensation de volume des sonneries et des alertes



Cette fonction permet de configurer le niveau sonore des sonneries et des alertes de manière à ce qu'il soit plus ou moins haut que celui de la voix. Suivez la procédure suivante pour configurer la compensation de volume des sonneries et des alertes de votre radio.



1 Appuyez sur  pour accéder au menu.

2 Appuyez sur  ou  jusqu'à Utilitaires. Appuyez sur  pour effectuer la sélection.

3 Appuyez sur  ou  jusqu'au Paramètres de la radio. Appuyez sur  pour effectuer la sélection.



4 Appuyez sur  ou  jusqu'à **Sonneries et alertes**. Appuyez sur  pour effectuer la sélection.

5 Appuyez sur  ou  jusqu'à **Écart Vol.**. Appuyez sur  pour effectuer la sélection.

6 Appuyez sur  ou  jusqu'au niveau de compensation voulu.

Une tonalité se fait entendre correspondant à chaque niveau de compensation de volume.



7 Faites un des suivants :



- Appuyez sur  pour effectuer la sélection. Le niveau d'écart de volume est enregistré.
 - Appuyez sur  pour quitter. Les changements sont supprimés.
-



Activation ou désactivation de la tonalité d'autorisation de parler



Suivez la procédure suivante pour activer ou désactiver la tonalité d'autorisation de parler sur votre radio.

1 Appuyez sur  pour accéder au menu.

2 Appuyez sur  ou  jusqu'à **Utilitaires**. Appuyez sur  pour effectuer la sélection.

3 Appuyez sur  ou  jusqu'au **Paramètres de la radio**. Appuyez sur  pour effectuer la sélection.

4 Appuyez sur  ou  jusqu'à **Tonalités/Alert.** Appuyez sur  pour effectuer la sélection.

5 Appuyez sur  ou  jusqu'à Autorisation de parler. Appuyez sur  pour effectuer la sélection.

6 Appuyez sur  pour activer ou désactiver la tonalité d'autorisation de parler.



L'écran affiche un des résultats suivants :



- Si la fonction est activée, ✓ apparaît à côté d'Activé.
 - Si cette option est désactivée, le ✓ ne s'affiche plus à côté de Activé.
-



Activation et désactivation de la tonalité de mise sous tension



Suivez la procédure suivante pour activer ou désactiver la tonalité de mise sous tension de votre radio.

1 Appuyez sur  pour accéder au menu.

2 Appuyez sur  ou  jusqu'à Utilitaires. Appuyez sur  pour effectuer la sélection.

3 Appuyez sur  ou  jusqu'au Paramètres de la radio. Appuyez sur  pour effectuer la sélection.

4 Appuyez sur  ou  jusqu'à Tntités/ Avert... Appuyez sur  pour effectuer la sélection.

5 Appuyez sur  ou  jusqu'à Sous tension. Appuyez sur  pour effectuer la sélection.







6 Appuyez sur  pour activer ou désactiver la tonalité de mise sous tension. L'écran affiche un des résultats suivants :



- Si la fonction est activée, ✓ apparaît à côté d'Activé.

- Si cette option est désactivée, le ✓ ne s'affiche plus à côté de Activé.







Configuration des sonneries d'avis de messages texte

Vous pouvez personnaliser la tonalité d'alerte de message texte sur Temporaire ou Répétitive pour chaque entrée dans la liste de contacts. Suivez la procédure suivante pour configurer les sonneries d'avis de messages de votre radio.

- 1 Appuyez sur  pour accéder au menu.
- 2 Appuyez sur  ou  jusqu'à Contacts. Appuyez sur  pour effectuer la sélection.
- 3 Appuyez sur  ou  jusqu'à l'alias ou l'ID voulu. Appuyez sur  pour effectuer la sélection.

- 4 Appuyez sur  ou  jusqu'à Avis de message. Appuyez sur  pour effectuer la sélection.

- 5 Faites un des suivants :



- Appuyez sur  ou  jusqu'à Temporaire. Appuyez sur  pour effectuer la sélection. L'écran affiche ✓ à côté de Temporaire.
- Appuyez sur  ou  jusqu'à Répétitive. Appuyez sur  pour effectuer la sélection. L'écran affiche ✓ à côté de Répétitive.



Changement des modes d'affichage



Vous pouvez changer le mode d'affichage de la radio entre le mode Jour ou mode Nuit au besoin. Ce réglage modifie la palette de couleurs de l'écran. Suivez la procédure suivante pour modifier le mode d'affichage de la radio.





- 1 Faites un des suivants :

- Appuyez sur la touche programmée **Mode d'affichage**. Ignorez les étapes suivantes.
- Appuyez sur  pour accéder au menu.

2 Appuyez sur  ou  jusqu'à Utilitaires.
Appuyez sur  pour effectuer la sélection.

3 Appuyez sur  ou  jusqu'au Paramètres de la radio. Appuyez sur  pour effectuer la sélection.

4 Appuyez sur  ou  jusqu'à Afficheur.
Appuyez sur  pour effectuer la sélection.
L'écran affiche Mode Jour et Mode Nuit.



5 Appuyez sur  ou  jusqu'au profil voulu.
Appuyez sur  pour effectuer la sélection.
L'écran affiche  à côté du profil sélectionné.



Configuration de la luminosité de l'affichage



Suivez la procédure de régler la luminosité de l'affichage sur votre radio. La luminosité de l'écran ne peut être ajustée lorsque la fonction « Luminosité auto » est activée.



1 Faites un des suivants :

- Appuyez sur la touche programmée **Luminosité**. Ignorez les étapes suivantes.
- Appuyez sur  pour accéder au menu.

2 Appuyez sur  ou  jusqu'à Utilitaires.
Appuyez sur  pour effectuer la sélection.











3 Appuyez sur  ou  jusqu'au Paramètres de la radio. Appuyez sur  pour effectuer la sélection.

- 4 Appuyez sur  ou  jusqu'à Luminosité. Appuyez sur  pour effectuer la sélection. L'écran affiche une barre de progression.
-

- 5 Appuyez sur  ou  pour augmenter ou réduire la luminosité de l'affichage. Appuyez sur  pour effectuer la sélection. La valeur du paramètre varie de 1 à 8.
-

Activation ou désactivation de l'avertisseur / des phares







Votre radio peut vous aviser d'un appel entrant en actionnant l'avertisseur et les phares. Lorsque cette fonction est activée, les appels entrants font s'activer l'avertisseur et les phares de votre véhicule. Cette fonction passe par le connecteur d'accessoire à l'arrière de votre radio et doit être installée par votre détaillant. Suivez la procédure suivante pour activer ou désactiver l'avertisseur et les phares de votre véhicule.

- 1 Faites un des suivants :
- Appuyez sur la touche programmée **Avert./ phares**. Passez les étapes ci-dessous.
 - Appuyez sur  pour accéder au menu.
-
- 2 Appuyez sur  ou  jusqu'à Utilitaires. Appuyez sur  pour effectuer la sélection.
-
- 3 Appuyez sur  ou  jusqu'au Paramètres de la radio. Appuyez sur  pour effectuer la sélection.
-
- 4 Appuyez sur  ou  jusqu'à Avert./ phares. Appuyez sur  pour effectuer la sélection.
-
- 5 Appuyez sur  pour activer ou désactiver l'avertisseur ou les phares. L'écran affiche un des résultats suivants :

- Si la fonction est activée, ✓ apparaît à côté d'Activé.
- Si cette option est désactivée, le ✓ ne s'affiche plus à côté de Activé.

Activation ou désactivation des voyants DEL

Suivez la procédure suivante pour activer ou désactiver les voyants DEL sur votre radio.

- 1 Appuyez sur  pour accéder au menu.
- 2 Appuyez sur  ou  jusqu'à Utilitaires. Appuyez sur  pour effectuer la sélection.
- 3 Appuyez sur  ou  jusqu'au Paramètres de la radio. Appuyez sur  pour effectuer la sélection.

- 4 Appuyez sur  ou  jusqu'à Indicateur DEL. Appuyez sur  pour effectuer la sélection.

- 5 Appuyez sur  pour activer ou désactiver le voyant DEL.

L'écran affiche un des résultats suivants :



- Si la fonction est activée, ✓ apparaît à côté d'Activé.
- Si cette option est désactivée, le ✓ ne s'affiche plus à côté de Activé.



Activer et désactiver le système de diffusion publique



Suivez la procédure suivante pour activer ou désactiver la diffusion publique interne (PA) de votre radio.

- 1 Faites un des suivants :
 - Appuyez sur la touche programmée **Diffusion publique**. Ignorez les étapes suivantes.



- Appuyez sur  pour accéder au menu.
-

2 Appuyez sur  ou  jusqu'à Utilitaires.
Appuyez sur  pour effectuer la sélection.

3 Appuyez sur  ou  jusqu'au Paramètres de la radio. Appuyez sur  pour effectuer la sélection.

4 Appuyez sur  ou  jusqu'à Diffusion publique. Appuyez sur  pour effectuer la sélection.



5 Appuyez sur  pour activer ou désactiver la diffusion publique.



- Si la fonction est activée,  apparaît à côté d'Activé.
- Si cette option est désactivée, le  ne s'affiche plus à côté de Activé.

Activer et désactiver le système de diffusion publique externe

Suivez la procédure suivante pour activer ou désactiver la diffusion publique externe (PA) de votre radio.

- 1 Faites un des suivants :
 - Appuyez sur la touche programmée **Diffusion publique ext.** Ignorez les étapes suivantes.
 - Appuyez sur  pour accéder au menu.
-

2 Appuyez sur  ou  jusqu'à Utilitaires.
Appuyez sur  pour effectuer la sélection.





3 Appuyez sur  ou  jusqu'au Paramètres de la radio. Appuyez sur  pour effectuer la sélection.



4 Appuyez sur  ou  jusqu'à Diffusion publique externe. Appuyez sur  pour effectuer la sélection.



- 5 Appuyez sur  pour activer ou désactiver la diffusion publique externe.
- Si la fonction est activée, ✓ apparaît à côté d'Activé.
 - Si cette option est désactivée, le ✓ ne s'affiche plus à côté de Activé.
-



Activer ou désactiver l'écran d'introduction

Vous pouvez activer ou désactiver l'écran d'introduction selon la procédure suivante.

- 1 Appuyez sur  pour accéder au menu.
-
- 2 Appuyez sur  ou  jusqu'à Utilitaires.
Appuyez sur  pour effectuer la sélection.
-

- 3 Appuyez sur  ou  jusqu'au Paramètres de la radio. Appuyez sur  pour effectuer la sélection.
-

- 4 Appuyez sur  ou  jusqu'à Afficheur.
Appuyez sur  pour effectuer la sélection.
-



- 5 Appuyez sur  ou  jusqu'à Écran intro.
Appuyez sur  pour effectuer la sélection.
-



- 6 Appuyez sur  pour activer ou désactiver l'écran d'introduction.
- L'écran affiche un des résultats suivants :
- Si la fonction est activée, ✓ apparaît à côté d'Activé.
 - Si cette option est désactivée, le ✓ ne s'affiche plus à côté de Activé.
-



Sélection de la langue





Suivez la procédure suivante pour choisir la langue de votre radio.

- 1 Appuyez sur  pour accéder au menu.

- 2 Appuyez sur  ou  jusqu'à Utilitaires.
Appuyez sur  pour effectuer la sélection.

- 3 Appuyez sur  ou  jusqu'au Paramètres de la radio. Appuyez sur  pour effectuer la sélection.



- 4 Appuyez sur  ou  jusqu'à Langues.
Appuyez sur  pour effectuer la sélection.



- 5 Appuyez sur  ou  jusqu'à la langue voulue. Appuyez sur  pour effectuer la sélection.
L'écran affiche  à côté de la langue sélectionnée.



Déterminer le type de câble

Procédez comme suit pour sélectionner le type de câble utilisé par votre radio.

- 1 Appuyez sur  pour accéder au menu.

- 2 Appuyez sur  ou  jusqu'à Utilitaires.
Appuyez sur  pour effectuer la sélection.

- 3 Appuyez sur  ou  jusqu'au Paramètres de la radio. Appuyez sur  pour effectuer la sélection.

4 Appuyez sur  ou  jusqu'à Type câble.

Appuyez sur  pour effectuer la sélection.

5 Le type de câble actuel est indiqué par l'icône  .

Activation ou désactivation de l'assistance parlée

Cette fonction permet à la radio de confirmer vocalement le code ou le nom de la zone ou du canal que l'utilisateur vient d'entrer ou la touche programmable sur laquelle il vient d'appuyer.

Cette option est particulièrement utile lorsqu'il est difficile de lire le contenu affiché à l'écran.

L'assistance parlée peut être personnalisée en fonction des exigences du client. Suivez la procédure suivante pour activer ou désactiver l'assistance parlée de votre radio.

Activation ou désactivation de la carte d'option

Les capacités de carte d'option de chaque canal peuvent être attribuées aux touches programmables. Un canal peut prendre en charge jusqu'à six fonctions de carte d'option. Suivez la procédure suivante pour activer ou désactiver la carte d'option sur votre radio.

Appuyez sur la touche programmée **Carte d'option**.

Synthèse texte-parole

La fonction de synthèse vocale peut être activée uniquement par votre détaillant ou administrateur de système. Si la synthèse texte-parole est activée, l'Annonce vocale est automatiquement désactivée. Si cette option est activée, la fonction de synthèse texte-parole est automatiquement désactivée.

Cette fonction permet à la radio de faire entendre les fonctionnalités suivantes :

- Canal actuel
- Zone actuelle



- Activation ou désactivation de la fonction de bouton programmé
- Contenu des messages texte reçus
- Contenu des fiches de travail reçues



L'indicateur audio peut être personnalisé en fonction des exigences du client. Cette fonction est particulièrement utile lorsqu'il est difficile de lire le contenu affiché à l'écran.



Réglage de la synthèse texte-parole



Suivez la procédure pour définir la fonction de synthèse vocale.

- 1 Appuyez sur  pour accéder au menu.

- 2 Appuyez sur  ou  jusqu'à Utilitaires.
Appuyez sur  pour effectuer la sélection.

- 3 Appuyez sur  ou  jusqu'au Paramètres de la radio. Appuyez sur  pour effectuer la sélection.

- 4 Appuyez sur  ou  jusqu'à Assistance parlée. Appuyez sur  pour effectuer la sélection.

- 5 Appuyez sur  ou  pour n'importe laquelle des fonctions suivantes. Appuyez sur  pour effectuer la sélection.

Voici les options disponibles :

- Tout
 - Messages
 - Tickets de tâche
 - Canal
 - Zone
 - Touche de programmation
- ✓ L'icône s'affiche à côté du réglage sélectionné.
-

Réglage du délai menu

Vous pouvez régler la durée pendant laquelle la radio affiche le menu avant de revenir automatiquement à l'écran d'accueil. Suivez la procédure suivante pour configurer le délai menu.



- 1 Appuyez sur  pour accéder au menu.

- 2 Appuyez sur  ou  jusqu'à Utilitaires.
Appuyez sur  pour effectuer la sélection.

- 3 Appuyez sur  ou  jusqu'au Paramètres de la radio. Appuyez sur  pour effectuer la sélection.

- 4 Appuyez sur  ou  jusqu'à Afficheur.
Appuyez sur  pour effectuer la sélection.

- 5 Appuyez sur  ou  jusqu'à Délai Menu.
Appuyez sur  pour effectuer la sélection.



- 6 Appuyez sur  ou  jusqu'au profil voulu.
Appuyez sur  pour effectuer la sélection.



Activation ou désactivation du microphone numérique



Le contrôle de gain automatique du microphone numérique (CGA) permet de réguler automatiquement le gain du microphone de la radio durant la transmission sur un système numérique.

Cette fonction élimine l'audio fort ou augmente l'audio faible en fonction d'une valeur prédéterminée afin d'assurer un niveau audio uniforme. Suivez la procédure pour activer ou désactiver le CGA du microphone de votre radio.

- 1 Appuyez sur  pour accéder au menu.



- 2 Appuyez sur  ou  jusqu'à Utilitaires.
Appuyez sur  pour effectuer la sélection.

3 Appuyez sur  ou  jusqu'au Paramètres de la radio. Appuyez sur  pour effectuer la sélection.

4 Appuyez sur  ou  jusqu'à Mic. CGA-N. Appuyez sur  pour effectuer la sélection.

5 Appuyez sur  pour activer la fonction CGA Mic. numérique.

L'écran affiche un des résultats suivants :

- Si la fonction est activée,  apparaît à côté de **Activé**.
 - Si cette option est désactivée, le  ne s'affiche plus à côté de **Activé**.
-

Activation ou désactivation de la fonction Audio intelligent

Votre radio règle automatiquement le volume audio pour compenser le bruit de fond actuel dans l'environnement, y

compris les sources de bruit mobiles et immobiles. Cette fonction est une fonction de réception uniquement et ne touche pas l'audio de transmission. Suivez la procédure suivante pour activer ou désactiver l'audio intelligent sur votre radio.









AVIS:



Cette fonction ne s'applique pas à la technologie Bluetooth.

1 Faites un des suivants :









- Appuyez sur la touche programmée **Audio intelligent**. Passez les étapes ci-dessous.
 - Appuyez sur  pour accéder au menu.
-

2 Appuyez sur  ou  jusqu'à Utilitaires. Appuyez sur  pour effectuer la sélection.

3 Appuyez sur  ou  jusqu'au Paramètres de la radio. Appuyez sur  pour effectuer la sélection.

- 4 Appuyez sur  ou  jusqu'à Audio intelligent. Appuyez sur  pour effectuer la sélection.
-



5 Faites un des suivants :



- Appuyez sur  ou  jusqu'à Activer. Appuyez sur  pour effectuer la sélection. L'écran affiche  à côté du message Activé.
 - Appuyez sur  ou  jusqu'à Désactiver. Appuyez sur  pour effectuer la sélection. L'écran affiche  à côté du message Désactivé.
-





Activer ou désactiver la fonction de suppression des réactions acoustiques

Cette fonction vous permet de réduire la réaction acoustique reçue lors de la réception d'appels.



- 1 Appuyez sur  pour accéder au menu.

- 2 Appuyez sur  ou  Utilitaires, puis sur appuyez sur  pour sélectionner.

- 3 Appuyez sur  ou  Paramètres radio, puis sur appuyez sur  pour sélectionner.

- 4 Appuyez sur  ou  jusqu'à Réducteur de bruit, puis sur appuyez sur  pour sélectionner. Vous pouvez également utiliser les touches  ou  pour changer l'option sélectionnée.



- 5 Effectuez l'une des opérations suivantes.



- Appuyez sur  pour activer la suppression de la réaction acoustique. L'écran affiche ✓ à côté du message **Activé**.
 - Appuyez sur  pour désactiver la suppression de la réaction acoustique. L'icône ✓ ne s'affiche plus à côté du message **Activé**.
-



Activer ou désactiver l'amélioration de la vibration

Vous pouvez activer cette fonction lorsque vous parlez une langue qui contient beaucoup de consonnes vibrantes alvéolaires (« R » roulés). Suivez la procédure pour activer ou désactiver l'amélioration de la vibration sur votre radio.







- 1 Faites un des suivants :
 - Appuyez sur la touche programmée **Amélioration de la vibration**. Passez les étapes ci-dessous.
 - Appuyez sur  pour accéder au menu.
-

- 2 Appuyez sur  ou  jusqu'à **Utilitaires**. Appuyez sur  pour effectuer la sélection.
-

- 3 Appuyez sur  ou  jusqu'au **Paramètres de la radio**. Appuyez sur  pour effectuer la sélection.
-

- 4 Appuyez sur  ou  jusqu'à **Amélioration de la vibration**. Appuyez sur  pour effectuer la sélection.
-

- 5 Faites un des suivants :

- Appuyez sur  ou  jusqu'à **Activer**. Appuyez sur  pour effectuer la sélection. L'écran affiche ✓ à côté du message **Activé**.
 - Appuyez sur  ou  jusqu'à **Désactiver**. Appuyez sur  pour effectuer la sélection. L'écran affiche ✓ à côté du message **Désactivé**.
-

Ambiance audio

Vous pouvez personnaliser l'ambiance audio de votre radio selon vos préférences.

Par défaut

Il s'agit de la valeur par défaut.

Fort

Cette configuration active la suppression du bruit et augmente le volume du haut-parleur pour une utilisation dans un environnement bruyant.



Groupe de travail



Cette configuration permet d'activer la réduction du bruit et de désactiver l'AGC pour utilisation lorsqu'un groupe de radios sont à proximité les unes des autres.

Configuration de l'ambiance audio



Suivez la procédure pour définir l'ambiance audio sur votre radio en fonction de votre environnement.

- 1 Appuyez sur  pour accéder au menu.
-

- 2 Appuyez sur  ou  jusqu'à Utilitaires.
Appuyez sur  pour effectuer la sélection.
-

- 3 Appuyez sur  ou  jusqu'au Paramètres de la radio. Appuyez sur  pour effectuer la sélection.
-

- 4 Appuyez sur  ou  jusqu'à Ambiance audio. Appuyez sur  pour effectuer la sélection.
-

- 5 Appuyez sur  ou  jusqu'au profil voulu.
Appuyez sur  pour effectuer la sélection.

Les paramètres sont les suivants.

- Choisissez **Par défaut** pour activer les paramètres d'origine par défaut.
- Choisissez **Fort** pour augmenter le volume lorsque vous utilisez la radio dans un environnement bruyant.
- Choisissez **Groupe travail** afin de réduire la rétroaction acoustique lors de l'utilisation de la

radio en combinaison avec un groupe de radios qui sont à proximité de l'autre.

L'écran affiche ✓ à côté du profil sélectionné.

Profils audio

Vous pouvez personnaliser les profils audio de votre radio selon vos préférences.

Par défaut

Il s'agit de la valeur par défaut.

Niveau 1, niveau 2 et niveau 3













Ces paramètres sont des profils audio destinés à compenser la perte auditive causée par le bruit qui est typique chez les adultes dans la quarantaine, la cinquantaine, la soixantaine ou plus.

Amplification des fréquences aiguës, moyennes et basses

Ces paramètres sont prévus pour des sons plus ténus, ou nasillards, ou graves.

Configuration des profils audio

Suivez la procédure suivante pour configurer les profils audio par défaut de votre radio.

- 1 Appuyez sur  pour accéder au menu.
- 2 Appuyez sur  ou  jusqu'à Utilitaires. Appuyez sur  pour effectuer la sélection.
- 3 Appuyez sur  ou  jusqu'au Paramètres de la radio. Appuyez sur  pour effectuer la sélection.
- 4 Appuyez sur  ou  jusqu'à Profils audio. Appuyez sur  pour effectuer la sélection.
- 5 Appuyez sur  ou  jusqu'au profil voulu. Appuyez sur  pour effectuer la sélection. Les paramètres sont les suivants.
 - Choisissez Par défaut pour désactiver le profil audio sélectionné précédemment et revenir aux paramètres par défaut.

- Choisissez Niveau 1, Niveau 2 ou Niveau 3 pour les profils audio destinés à compenser la perte auditive due au bruit qui est habituelle pour les adultes de plus de 40 ans.
- Choisissez Ampli. aigus, Ampli. médiums, ou Ampli. basses pour les profils audio qui s'alignent avec votre préférence pour des sons plus métalliques, plus nasillards ou plus profonds.

L'écran affiche ✓ à côté du profil sélectionné.







Activer et désactiver le système de système satellite de navigation mondial



Le système mondial de navigation par satellite (GNSS) est un système de navigation par satellite qui permet de déterminer l'emplacement précis de la radio. Le GNSS comprend le système de positionnement global (GPS), le système mondial de satellites de navigation (GLONASS) et le système de satellite de navigation BeiDou (BDS). Le





AVIS:

Certains modèles de radio peuvent offrir le GPS, le GLONASS et le BDS. La constellation GNSS est configurée dans le CPS. Vérifiez auprès du détaillant ou de votre administrateur de système pour savoir de quelle façon votre radio a été programmée.

- 1 Effectuez une des étapes suivantes pour activer ou désactiver le mode GNSS sur votre radio.
 - Appuyez sur le bouton programmé **GNSS**.
 - Appuyez sur  pour accéder au menu. Passez à l'étape suivante.
- 2 Appuyez sur  ou  jusqu'à Utilitaires. Appuyez sur  pour effectuer la sélection.
- 3 Appuyez sur  ou  jusqu'au Paramètres de la radio. Appuyez sur  pour effectuer la sélection.

4 Appuyez sur  ou  jusqu'à GNSS. Appuyez sur  pour effectuer la sélection.

5 Appuyez sur  pour activer ou désactiver le GNSS.

Si la fonction est activée,  apparaît à côté d'Activé.

Si cette option est désactivée, le  ne s'affiche plus à côté de Activé.

Renseignements généraux sur la radio

Votre radio contient des renseignements sur différents paramètres.

Les informations générales de votre radio sont les suivantes :

- Alias et ID de la radio.
- Versions du micrologiciel et de la fiche de codes.
- Mise à jour du logiciel.

- Informations du système GNSS.
- Information sur le site.



AVIS:

Appuyez sur  pour revenir à l'écran précédent.

Maintenez enfoncée la touche  pour revenir à l'écran d'accueil. Lorsqu'il n'y a aucune activité pendant une durée prédéfinie, la radio quitte l'écran en cours.

Vérification de l'alias et l'ID de la radio



Suivez la procédure suivante pour vérifier l'alias et l'ID de la radio sur votre radio.

1 Faites un des suivants :



- Appuyez sur la touche programmée **Alias et ID de la radio**. Ignorez les étapes suivantes. Une tonalité de réussite se fait entendre.



Appuyez sur la touche programmée **Alias et ID de la radio** pour revenir à l'écran précédent.



- Appuyez sur  pour accéder au menu.
-



2 Appuyez sur  ou  jusqu'à Utilitaires.
Appuyez sur  pour effectuer la sélection.

3 Appuyez sur  ou  jusqu'à Info de la radio. Appuyez sur  pour effectuer la sélection.

4 Appuyez sur  ou  jusqu'à Mon ID.
Appuyez sur  pour effectuer la sélection.
L'alias de la radio s'affiche sur la première ligne de l'écran. L'ID de la radio s'affiche sur la deuxième ligne de l'écran.

2 Appuyez sur  ou  jusqu'à Utilitaires.
Appuyez sur  pour effectuer la sélection.

3 Appuyez sur  ou  jusqu'à Info de la radio. Appuyez sur  pour effectuer la sélection.

4 Appuyez sur  ou  jusqu'à Version.
Appuyez sur  pour effectuer la sélection.
L'écran affiche la version actuelle du micrologiciel et celle de la fiche de code.

Vérification des versions du micrologiciel et de la codeplug



Suivez la procédure suivante pour vérifier les versions du micrologiciel et de la fiche de code sur votre radio.

1 Appuyez sur  pour accéder au menu.



Vérification des informations de mise à jour du logiciel

Affiche la date et l'heure de la dernière mise à jour logicielle effectuée par l'intermédiaire de la Programmation par radiocommunication (OTAP) ou Wi-Fi. Suivez la procédure suivante pour vérifier les informations de mise à jour du logiciel de votre radio.

1 Appuyez sur  pour accéder au menu.

2 Appuyez sur  ou  jusqu'à Utilitaires.
Appuyez sur  pour effectuer la sélection.

3 Appuyez sur  ou  jusqu'à Info de la radio. Appuyez sur  pour effectuer la sélection.

4 Appuyez sur  ou  jusqu'à M. à j. logicielle. Appuyez sur  pour effectuer la sélection.
L'écran affiche la date et l'heure de la dernière mise à jour logicielle.



Le menu de mise à jour logicielle est uniquement disponible après au moins une session OTAP ou Wi-Fi réussie. Pour obtenir plus de renseignements à ce sujet, consultez la section [Programmation par onde radio à la page 506](#).

Consulter les informations du GNSS



Affiche les informations GNSS sur votre radio, par exemple, les valeurs suivantes :



- Latitude
- Longitude
- Altitude
- Direction
- Vitesse
- Affaiblissement de la précision horizontale (Horizontal Dilution of Precision, ou HDOP)
- Satellites
- Version

1 Appuyez sur  pour accéder au menu.

2 Appuyez sur  ou  jusqu'à Utilitaires.
Appuyez sur  pour effectuer la sélection.

3 Appuyez sur  ou  jusqu'à Info de la radio. Appuyez sur  pour effectuer la sélection.



4 Appuyez sur  ou  jusqu'à Info GNSS. Appuyez sur  pour effectuer la sélection.

5 Appuyez sur  ou  jusqu'à l'élément voulu. Appuyez sur  pour effectuer la sélection. L'écran affiche les informations GNSS demandées.



Affichage de l'information sur le site

Suivez la procédure suivante pour afficher le nom du site sur lequel se trouve actuellement votre radio.

1 Appuyez sur  pour accéder au menu.

2 Appuyez sur  ou  jusqu'à Utilitaires. Appuyez sur  pour effectuer la sélection.

3 Appuyez sur  ou  jusqu'à Info de la radio. Appuyez sur  pour effectuer la sélection.



4 Appuyez sur  ou  jusqu'à Info site. Appuyez sur  pour effectuer la sélection.



L'écran affiche le nom du site actuel.

Affichage des détails du certificat Wi-Fi d'entreprise



Vous pouvez afficher les détails du certificat Wi-Fi d'entreprise sélectionné.

1 Appuyez sur  pour accéder au menu.

2 Appuyez sur  ou  jusqu'à Utilitaires. Appuyez sur  pour effectuer la sélection.

- 3 Appuyez sur  ou  pour Menu
Certificat. Appuyez sur  pour effectuer la
sélection.

✓ s'affiche vis-à-vis des certificats prêts.

- 4 Appuyez sur  ou  jusqu'au certificat voulu.
Appuyez sur  pour effectuer la sélection.
-

Votre radio affiche les détails complets du certificat.



AVIS:

Pour les certificats non prêts, l'écran affiche
uniquement l'état.

Fonctionnement Connect Plus

Le mode Connect Plus est une solution ADF basée sur la technologie DMR. Le mode Connect Plus utilise un canal de contrôle réservé pour les requêtes de canal et les attributions. Les fonctions qui sont disponibles pour les utilisateurs radio en vertu de ce système sont disponibles dans le présent chapitre.

Autres commandes de la radio en mode Connect Plus

Ce chapitre décrit les commandes radio supplémentaires disponibles pour l'utilisateur de la radio à l'aide de moyens préprogrammés tels que les touches programmables et les fonctions attribuables de la radio.

Bouton d'émission (PTT)

Le bouton **PTT** situé sur le côté de la radio a deux fonctions principales :

- Le bouton **PTT** permet à la radio de transmettre un message aux autres radios pendant un appel.

Pour parler, maintenez le bouton **PTT** enfoncé. Relâchez le bouton **PTT** pour écouter.

Lorsque vous appuyez sur le bouton **PTT**, le microphone se met sous tension.

- Lorsque vous n'êtes pas déjà en cours d'appel, vous pouvez vous servir du bouton **PTT** pour faire un nouvel appel (voir [Faire un appel radio à la page 258](#)).

Si la tonalité d'autorisation est activée, attendez la fin de la brève tonalité pour parler.

Touches programmables

Votre détaillant peut programmer les touches pour en faire des raccourcis permettant d'accéder aux fonctions de la radio selon la durée pendant laquelle vous appuyez sur ces boutons :

Appui bref

Appuyer et relâcher rapidement.

Appui long

Appuyez et maintenez enfoncé pour la durée programmée.



AVIS:

La durée programmée pour la pression d'un bouton peut s'appliquer à tous les réglages et à toutes les fonctions attribuables de la radio. Voir [Fonctionnement d'urgence à la page 296](#) pour en savoir plus sur la durée de programmation pour la touche *Urgence*.

Fonctions attribuables de la radio

Commutateur® audio Bluetooth

Permet de faire alterner l'acheminement du signal audio entre le haut-parleur de la radio ou par un accessoire Bluetooth externe.

Connexion Bluetooth

Permet de lancer l'exécution d'une opération de recherche et de connexion Bluetooth.

Déconnexion Bluetooth

Met fin à toutes les connexions Bluetooth entre votre radio et tout dispositif Bluetooth.

Détection Bluetooth

Permet à votre radio de passer en mode Détection Bluetooth.

Annulation de file d'attente occupée

La radio quitte le mode Occupé quand un appel non urgent de la file d'attente Occupé est effectué. Les appels d'urgence, une fois qu'ils sont acceptés dans la file d'attente Occupé, ne peuvent pas être annulés.

Journal des appels

Permet d'ouvrir le journal des appels.

Annnonce du canal

Transmet des messages vocaux pour une zone et un canal sur le canal sélectionné.

Contacts

Permet l'accès direct à la liste des contacts.

Urgence activée/désactivée

Selon la programmation choisie, déclenche ou annule une urgence.

Avertisseur/phares

Active ou désactive la fonction d'avertisseurs et de phares.

Localisation interne

Activation ou désactivation de la fonction de localisation interne.

Audio intelligent

Active ou désactive la fonction Audio intelligent.

Num. manuelle

Selon la programmation choisie, permet d'effectuer un appel individuel ou un appel téléphonique en entrant un ID d'abonné ou un numéro de téléphone.

Accès direct

Permet de lancer un appel de groupe ou individuel prédéfini et d'envoyer un avis d'appel, un message texte rapide automatiquement ou de revenir au mode Accueil.

Cryptage

Active ou désactive la fonction de cryptage.

Vérification de la radio

Détermine si une radio est active dans un système.

Activer la radio

Permet d'activer une radio cible à distance.

Désactiver la radio

Permet de désactiver une radio cible à distance.

Écoute à distance

Active le microphone d'une radio cible sans indication.

Réinitialiser le canal d'accueil

Définit un nouveau canal d'accueil.

Type de sonnerie d'avertissement

Fournit un accès direct au réglage du type de sonnerie d'avertissement.

Demande d'itinérance

Demande de recherche d'un autre site.

Balayage

Permet d'activer et de désactiver la fonction de balayage.

Mettre en sourdine le Rappel du canal d'accueil

Mets en sourdine le rappel du canal d'accueil.

Verrouillage de site activé/désactivé

Lorsque cette fonction est activée, la radio ne recherche que le site courant. Lorsqu'elle est désactivée, la radio recherche d'autres sites en plus du site courant.

Message texte

Sélectionne le menu de la messagerie texte.

Annonce vocale activée/désactivée

Active ou désactive la fonction d'annonce vocale.

Wi-Fi

Permet d'activer ou de désactiver la fonction Wi-Fi.

Zone

Permet de sélectionner une zone dans une liste.

Réglages ou fonctions attribuables

FRéduction bruit

Active ou désactive la fonction de suppression des réactions acoustiques

Toutes les tonalités/alertes

Permet d'activer et de désactiver les sonneries et les avertissements.

Luminosité du rétroéclairage

Règle le niveau de luminosité.

Canal précédent/suivant

Selon la programmation, passe au canal précédent ou suivant.

Mode d'affichage

Permet d'alterner entre l'activation et la désactivation des modes d'affichage Jour et Nuit.

Système satellite de navigation mondial (GNSS)

Permet d'activer ou désactiver le système de navigation par satellite.

Niveau de puissance

Alterne entre un niveau de puissance haut ou bas.

Non attribué

Indique que la fonction du bouton n'a pas encore été attribuée.

Description des indicateurs d'état en mode Connect Plus

Icônes d'affichage

Vous trouverez ci-dessous les icônes s'affichant à l'écran de la radio.



Indicateur de puissance de signal reçu (RSSI)

Le nombre de barres représente l'intensité du signal radio. L'affichage de quatre barres indique une intensité de signal maximale. Cette icône ne s'affiche qu'en mode de réception.













Bluetooth non connecté





La fonction Bluetooth est activée, mais aucun appareil Bluetooth à distance n'est connecté.











Bluetooth connecté

	La fonction Bluetooth est activée. L'icône demeure allumée tant qu'un dispositif Bluetooth distant est connecté.	 Notification La liste de notifications contient des éléments à passer en revue.
	Données à volume élevé La radio reçoit des données à volume élevé et le canal est occupé.	 Niveau de puissance La radio est réglée à Faible tension ou à Haute puissance.
	Localisation intérieure disponible³ L'état de la localisation intérieure est activé et disponible.	 Désactivation des tonalités Les tonalités sont désactivées.
	Localisation intérieure non disponible³ L'état de la localisation intérieure est activé, mais non disponible parce que la fonction Bluetooth est désactivée ou parce que la détection des balises a été suspendue par Bluetooth.	 Carte d'option La fonction Carte d'option est activée.
	Mode Muet Le mode Muet est activé et le haut-parleur est coupé.	 Absence de fonction de la carte d'option La fonction Carte d'option est désactivée.
		 Fonction GNSS disponible La fonction GPS/GNSS est activée. L'icône demeure allumée tant que la réception d'une position est disponible.

³ Applicable uniquement pour les modèles avec la dernière version du logiciel et du matériel

	<p>Fonction GNSS non disponible/hors de portée</p> <p>La fonction GPS/GNSS est activée, mais ne reçoit aucune donnée du satellite.</p>
	<p>Balayage</p> <p>La fonction de balayage est activée.</p>
	<p>Urgence</p> <p>La radio est en mode d'urgence.</p>
	<p>Sécurisée</p> <p>La fonction Cryptage est activée.</p>
	<p>Non sécurisée</p> <p>La fonction Cryptage est désactivée.</p>
	<p>Itinérance de site</p> <p>La fonction d'itinérance de site est activée.</p>
	<p>Contact</p> <p>Le contact radio est disponible.</p>
	<p>Journal des appels</p> <p>Journal des appels radio.</p>

	<p>Message</p> <p>Arrivée d'un message entrant.</p>
	<p>Sonnerie seulement</p> <p>Le mode sonnerie est activé.</p>
	<p>Sonnerie silencieuse</p> <p>Le mode de sonnerie silencieuse est activé.</p>
	<p>Vibration</p> <p>Le mode vibration est activé.</p>
	<p>Vibration et sonnerie</p> <p>Le mode vibration et sonnerie est activé.</p>
	<p>Wi-Fi excellent⁴</p> <p>Le signal Wi-Fi est excellent.</p>
	<p>Wi-Fi bon⁴</p> <p>Le signal Wi-Fi est bon.</p>
	<p>Wi-Fi moyen⁴</p> <p>Le signal Wi-Fi est moyen.</p>

**Wi-Fi faible⁴**

Le signal Wi-Fi est faible.

**Wi-Fi non disponible⁴**

Le signal Wi-Fi n'est pas disponible.

Icônes d'appels

Vous trouverez ci-dessous les icônes s'affichant à l'écran de la radio pendant un appel. Ces icônes apparaissent également dans la liste de contacts pour indiquer le type d'ID.

**Appel individuel**

Cette icône s'affiche lorsqu'un appel individuel est en cours. Dans la liste de contacts, elle indique l'alias (nom) ou l'ID (numéro) de l'abonné.

**Appel de groupe/Appel général de site****Appel téléphonique comme étant un Appel individuel**

Indique un appel téléphonique comme étant un Appel individuel en cours.

**Appel PC par Bluetooth**

Indique qu'un appel PC par Bluetooth est en cours.

**Appel de répartition**

Le type de contact d'appel de répartition sert à envoyer un message texte à un PC répartiteur par le biais d'un serveur de messagerie texte de tiers.

⁴ Ne s'applique qu'aux modèles XPR 5550e/XPR 5580e

Icônes de menu avancé

Les icônes suivantes s'affichent près des éléments de menu qui offrent un choix entre deux options ou qui présentent un sous-menu offrant aussi deux options.

	Case à cocher (vide)
Indique que l'option n'est pas sélectionnée.	
	Case à cocher (cochée)
Indique que l'option est sélectionnée.	
	Case noire
Indique que l'option sélectionnée dans le menu comporte un sous-menu.	

Icônes de messages envoyés

Les icônes ci-dessous apparaissent dans le coin supérieur droit de l'écran dans le dossier Msges envoyés.

	Réussite de l'envoi
Le message texte a été envoyé.	
OU	
	En cours
<ul style="list-style-type: none"> • Le message texte destiné à un alias ou à un ID de groupe est en attente de transmission. • Le message texte destiné à un alias ou à un ID d'abonné est en attente de transmission et sera ensuite en attente de confirmation. 	
	Message personnel ou de groupe lu
Le message texte a été lu.	
OU	
OU	Message personnel ou de groupe non lu
	Le message texte n'a pas été lu.



Échec de l'envoi

Le message texte n'a pas été envoyé.

OU



Il s'agit d'un dispositif PTT (messagerie vocale instantanée) compatible avec la technologie Bluetooth, comme un dispositif à fonction PTT uniquement (POD).

Icônes de dispositif Bluetooth

Les icônes suivantes accompagnent les éléments de la liste de dispositifs Bluetooth afin de vous informer sur le type du dispositif.



Dispositif de données Bluetooth

Dispositif de transfert de données Bluetooth, par exemple, un lecteur de codes à barres.



Dispositif audio Bluetooth

Il s'agit d'un dispositif audio compatible avec la technologie Bluetooth, comme un casque d'écoute.



Dispositif PTT Bluetooth

Voyant lumineux

Le voyant DEL indique l'état de fonctionnement de la radio.

Rouge clignotant

La radio émet alors que le niveau de charge de la batterie est faible, reçoit une transmission d'urgence ou n'a pas réussi l'auto-vérification à la mise sous tension, ou a quitté la zone de couverture si la radio est configurée avec le système ARTS (Auto-Range Transponder System). Mode Muet est activé.

Rouge à clignotement rapide

La radio reçoit un transfert de fichier par radiocommunication (fichier de micrologiciel de carte d'option, fichier de fréquence réseau ou fichier de codeplug de carte d'option) ou la radio



	met à niveau un nouveau fichier de micrologiciel de carte d'option.
Clignotement vert et jaune	La radio reçoit une alerte d'appel, a reçu un message texte ou le balayage est activé et elle reçoit de l'activité.
Jaune continu	La radio est en mode Détection Bluetooth.
Clignotement jaune double	La radio recherche activement un nouveau site.
Jaune clignotant	La radio reçoit une alerte d'appel ou le balayage est activé alors qu'elle est inactive (ne désactive pas la sourdine pour toute activité).
Vert continu	La radio est s'allume ou transmet.
Clignotement vert	La radio est en train de s'allumer, de recevoir un appel ou des données.
Clignotement vert rapide	La radio reçoit un appel crypté.

Tonalités d'avertissement

Vous trouverez ci-dessous les tonalités émises par le haut-parleur de la radio.

Tonalité aiguë Tonalité grave



Les tonalités d'avertissement vous informent de manière audible de l'état d'une tâche après l'avoir initiée.

	Tonalité de réussite
	Tonalité d'échec

Tonalités d'alerte

La fonction Tonalités d'alerte vous informe de manière audible de l'état ou répond à la réception de données sur la radio.

Tonalité continue 	La radio émet un signal monophonique. Il retentit de manière continue jusqu'à ce qu'il cesse.
---	---

Tonalité périodique	Le signal sonore retentit de manière périodique en fonction des réglages de la radio. Il démarre, s'arrête, puis reprend.
	
Tonalité répétitive	Le signal sonore unique retentit et se répète jusqu'à ce que l'utilisateur y mette fin.
	
Tonalité temporaire	Le signal sonore retentit une fois pendant une courte période, selon les réglages de la radio.
	

Sélection des modes Connect Plus et non Connect Plus

Pour passer à un mode non Connect Plus, vous devez changer de zone, si la programmation par le détaillant ou votre administrateur de système le prévoit. Vérifiez auprès du détaillant ou de votre administrateur de système pour savoir si votre radio a été programmée avec des zones non Connect Plus, et quelles fonctions sont disponibles lors de l'utilisation dans des zones non Connect Plus.

Recevoir et faire des appels en mode Connect Plus

Cette section explique le fonctionnement général de la radio et les fonctions d'appel qui sont disponibles sur votre radio.

Sélectionner un site

Un site fournit la couverture pour une zone particulière. Un site Connect Plus est doté d'un contrôleur de site et d'un maximum de 15 répéteurs. Dans les réseaux multisites, la radio Connect Plus recherche automatiquement un nouveau site lorsque la puissance du signal du site courant chute sous un niveau inacceptable.

Demande d'itinérance

Une demande d'itinérance dit à la radio de rechercher un autre site, même si le signal du site courant est acceptable.

Si aucun site n'est disponible :

- La radio affiche la recherche et l'alias du canal sélectionné et poursuit la recherche dans la liste des sites.

- La radio reviendra au site précédent si celui-ci est toujours disponible.



AVIS:

Ceci est programmé par votre détaillant.

Appuyez sur la touche programmée **Demande d'itinérance**.

Une tonalité retentit pour indiquer que la radio est passée à un nouveau site. L'écran affiche ID du site <Numéro du site>.

Verrouillage de site activé/désactivé

Lorsque cette fonction est activée, la radio ne recherche que le site courant. Lorsqu'elle est désactivée, la radio recherche d'autres sites en plus du site courant.

Appuyez sur la touche programmée **Verr. Site**.

Si la fonction **Verrouillage de site** est activée :

- Une tonalité de réussite retentit pour indiquer que la radio s'est verrouillée sur le site courant.
- L'écran affiche Site verrouillé.

Si la fonction **Verrouillage du site** est désactivée :

- Une tonalité d'échec retentit pour indiquer que la radio est déverrouillée.
- L'écran affiche Site Déverrouillé.

Restriction de site

Votre administrateur de système radio Connect Plus est en mesure de décider quels sites du réseau sont autorisés ou non. Il n'est pas nécessaire de reprogrammer votre radio pour modifier la liste des sites autorisés et non autorisés. Si votre radio tente de s'inscrire sur un site non autorisé, un bref message s'affiche pour indiquer : Site <numéro donné> non autorisé. La radio recherche alors un autre site réseau.

Sélection d'une zone



La radio peut être programmée pour un maximum de 16 zones Connect Plus, et chaque zone contient un maximum de 16 positions assignables sur le bouton de sélection de canaux.

Chaque position assignable du bouton peut être utilisée pour démarrer l'un des types d'appels vocaux suivants :

- Appel de groupe

- Appel multigroupe
- Appel général de site
- Appel individuel





- 1 Accédez à la fonction Zone en effectuant les commandes suivantes :

Commandes de la radio	Étapes à suivre
Touche programmée Sélection de zone	Appuyez sur la touche programmée Sélection de zone .
Menu de la radio	<p>a Appuyez sur  pour accéder au menu.</p> <p>b Appuyez sur  ou  jusqu'à Répondre,</p>

Commandes de la radio	Étapes à suivre
	puis sur appuyez sur  pour sélectionner.

La zone sélectionnée est affichée et indiquée par l'icône ✓.

- 2 Sélectionnez la zone requise.

Commande radio	Étapes à suivre
 ou 	Appuyez sur  ou  , puis faites défiler jusqu'à la zone requise.

- 3 Appuyez sur  pour effectuer la sélection.

L'écran affiche <Zone> sélectionnée pendant un moment et revient à l'écran de la zone sélectionnée.

Utilisation de réseaux multiples

Si votre radio a été programmée pour utiliser plusieurs réseaux Connect Plus, vous pouvez sélectionner un autre réseau en passant à la zone Connect Plus attribuée au réseau désiré. Ces attributions réseau-à-zone sont configurées par votre détaillant par le biais de la programmation de la radio.

Sélection d'un type d'appel

Utilisez le bouton sélecteur de canal pour sélectionner un type d'appel. Il peut s'agir d'un appel de groupe, d'un appel multigroupe, d'un appel général ou d'un appel individuel, selon la programmation de votre radio. Si vous changez la position du bouton de sélection de canaux (pour une position à laquelle un type d'appel est affecté), la radio s'enregistrera à nouveau sur le site Connect Plus. La radio s'enregistre en utilisant l'ID de groupe d'enregistrement qui a été programmé pour la nouvelle position du bouton de sélection de canal le nouveau type d'appel.

Si vous sélectionnez une position à laquelle aucun type d'appel n'est attribué, votre radio émet une tonalité continue et l'écran affiche **Non programmé**. Étant donné que votre radio ne peut pas fonctionner lorsqu'un canal non

programmé est sélectionné, utilisez le bouton sélecteur de canal pour sélectionner un canal programmé.

Lorsque la zone requise est affichée (si vous avez plusieurs zones sur votre radio), tournez le bouton sélecteur de canal pour sélectionner le type d'appel.

Réception et réponse à un appel

Une fois le canal, l'ID d'abonné ou le type d'appel affiché, vous pouvez recevoir des appels et y répondre.

Le voyant DEL passe au vert continu lorsque la radio est en cours de transmission et clignote en vert lorsque la radio est en cours de réception.



AVIS:

Le voyant DEL passe au vert continu lorsque la radio est en cours de transmission et émet un clignotement double en vert durant la réception d'un appel crypté. Pour décoder un appel crypté, votre radio doit être dotée de la même clé de cryptage OU des mêmes valeurs et ID de clé (programmés par le détaillant) que la radio émettrice (la radio de laquelle vous recevez l'appel).

Pour obtenir plus de renseignements à ce sujet, consultez la section [Cryptage à la page 317](#).

Recevoir un appel de groupe et y répondre

Pour être en mesure de recevoir un appel provenant d'un groupe d'utilisateurs, votre radio doit avoir été préalablement définie comme partie intégrante de ce groupe.

Si vous recevez un appel de groupe (à partir de l'écran d'accueil), le voyant DEL clignote en vert. L'icône d'appel de groupe apparaît dans le coin supérieur droit. L'alias de l'appelant s'affiche sur la première ligne de l'écran. L'alias du groupe s'affiche sur la deuxième ligne de l'écran. Votre radio désactive la sourdine et l'appel entrant se fait entendre sur le haut-parleur.

- 1 Tenez le microphone à une distance de 2,5 cm à 5 cm de votre bouche.

Le voyant DEL passe au vert continu.

- 2 Attendez la fin de la tonalité d'autorisation de conversation (si elle est activée) et parlez clairement dans le microphone.

- 3 Relâchez le bouton **PTT** pour écouter.

S'il n'y a aucune activité vocale pendant une durée préprogrammée, l'appel prend fin.



AVIS:

Pour en savoir davantage sur la fonction d'appel de groupe, consultez la section [Pour passer un appel de groupe à la page 259](#).

Recevoir un appel individuel et y répondre

Un Appel individuel est un appel effectué à partir d'une radio individuelle vers une autre radio individuelle.

Lorsque vous recevez un Appel individuel, le voyant DEL clignote en vert. La première ligne de l'écran affiche l'alias ou l'ID d'abonné et l'icône RSSI. Le message Appel indiv. et l'icône d'appel individuel s'affichent sur la deuxième ligne. Votre radio désactive la sourdine et l'appel entrant se fait entendre sur le haut-parleur de la radio.

- 1 Tenez le microphone à une distance de 2,5 cm à 5 cm de votre bouche.

- 2 Pour prendre l'appel, appuyez sur le bouton **PTT**.

Le voyant DEL passe au vert continu.

- 3 Attendez la fin de la tonalité d'autorisation de conversation (si elle est activée) et parlez clairement dans le microphone.

- 4 Relâchez le bouton **PTT** pour écouter.

S'il n'y a aucune activité vocale pendant une durée préprogrammée, l'appel prend fin.

L'écran affiche Appel terminé.

Pour en savoir davantage sur la fonction d'appel individuel, consultez la section [Passer un appel individuel à la page 260](#).

Réception d'un appel général

Un appel général est un appel provenant d'une radio individuelle et transmis à toutes les radios du site. On l'utilise surtout pour faire une annonce importante exigeant toute l'attention de l'utilisateur.

Lors de la réception d'un appel général de site, une tonalité retentit et le voyant DEL clignote en vert.

L'icône d'appel de groupe apparaît dans le coin supérieur droit. L'alias de l'appelant s'affiche sur la première ligne de l'écran. Appel général de site s'affiche sur la deuxième ligne de l'écran. Votre radio désactive la sourdine et l'appel entrant se fait entendre sur le haut-parleur.

Une fois que l'appel général est terminé, la radio revient à l'écran où elle était avant de recevoir l'appel. Les appels généraux n'attendent pas pendant un temps prédéterminé avant de se terminer.

Vous ne pouvez pas répondre à un appel général de site.



AVIS:

Voir [Faire un appel général de site à la page 261](#) pour savoir comment faire un appel général de site.

La radio interrompt la réception de l'appel général si vous changez de canal pendant l'appel. Pendant un appel général, vous ne pouvez pas utiliser les fonctions des touches programmées tant que l'appel est en cours.

Réception d'un appel téléphonique individuel entrant

Lorsque vous recevez un appel individuel entrant, l'icône d'appel téléphonique en tant qu'appel individuel s'affiche

dans le coin supérieur droit. La première ligne de texte affiche Appel tél.

- 1 Pour répondre et parler, maintenez le bouton **PTT** enfoncé. Relâchez le bouton **PTT** pour écouter.
-

- 2 Appuyez longuement sur  pour mettre fin à l'appel.



La première ligne de l'écran affiche le message Fin.
La deuxième ligne de l'écran affiche Appel tél.
L'écran d'appel téléphonique s'affiche.
L'écran affiche Appel tél. terminé.

Composition surnuméraire en mémoire tampon lors d'un appel téléphonique individuel entrant

Pendant l'appel, l'icône Appel téléphonique en tant qu'appel individuel s'affiche dans le coin supérieur droit de

l'écran. La première ligne de l'écran affiche le message Appel tél.

- 1 Utilisez le clavier pour entrer les chiffres et appuyez sur le bouton  .

Appuyez sur  , suivi de  dans les 2 secondes, pour insérer une pause. Le P remplace * et # sur l'afficheur.

L'icône Appel téléphonique en tant qu'appel individuel s'affiche dans le coin supérieur droit de l'écran. La première ligne de l'écran affiche les chiffres saisis.

- 2 Appuyez longuement sur  pour mettre fin à l'appel.

La première ligne de l'écran affiche le message Fin.
La deuxième ligne de l'écran affiche Appel tél.
L'écran d'appel téléphonique s'affiche.
L'écran affiche Appel tél. terminé.

Composition surnuméraire en direct lors d'un appel téléphonique individuel entrant

Pendant l'appel, l'icône Appel téléphonique en tant qu'appel individuel s'affiche dans le coin supérieur droit de l'écran. La première ligne de l'écran affiche le message Appel tél.

- 1 Appuyez sur le bouton **PTT** et utilisez le clavier pour saisir les chiffres.

L'icône Appel téléphonique en tant qu'appel individuel s'affiche dans le coin supérieur droit de l'écran. La première ligne de l'écran affiche les chiffres de composition en direct.

- 2 Appuyez longuement sur  pour mettre fin à l'appel.

La première ligne de l'écran affiche le message Fin.
La deuxième ligne de l'écran affiche Appel tél.
L'écran d'appel téléphonique s'affiche.

L'écran affiche Appel tél. terminé.

Réception d'un appel de Talkgroup entrant

Lorsque vous recevez un appel de Talkgroup, l'icône d'appel de groupe s'affiche dans le coin supérieur droit. La première ligne de l'écran affiche Appel1

Appuyez sur la touche **PTT** pour parler et relâchez la touche pour écouter.

Appel téléphonique multigroupe entrant

Lorsque vous recevez un appel multigroupe, l'icône d'appel de groupe s'affiche dans le coin supérieur droit. La première ligne affiche Appel multigroupe. La radio désactive la sourdine et la tonalité d'appel multigroupe entrant se fait entendre sur le haut-parleur.

Faire un appel radio

Après avoir sélectionné un canal, vous pouvez choisir un alias ou un ID d'abonné ou de groupe à l'aide des éléments suivants :

- Le bouton de sélection de canaux.

- Une touche programmée d'**accès direct** – La fonction d'accès direct vous permet de passer aisément un appel individuel vers un ID prédéfini. Vous pouvez attribuer cette fonction à une touche programmable avec une brève ou une longue pression. Vous ne pouvez attribuer qu'un seul ID à une touche d'**accès direct**. Vous pouvez programmer plusieurs touches d'**accès direct** sur la radio.
- La liste de contacts (voir [Réglages des contacts à la page 284](#)).

**AVIS:**

La fonction de cryptage de votre radio doit être activée pour que ce canal soit en mesure d'envoyer des transmissions cryptées. Seule une radio cible dotée des mêmes valeurs et ID de clé que votre radio peut décoder la transmission.

Pour obtenir plus de renseignements à ce sujet, consultez la section [Cryptage à la page 317](#).

Faire un appel à l'aide du bouton sélecteur de canal

Cette fonction permet aux utilisateurs radio de passer différents types d'appels : Appel de groupe, appel individuel, appel général de site, appel multigroupe.

Pour passer un appel de groupe

Pour être en mesure de faire un appel à un groupe d'utilisateurs, votre radio doit avoir été préalablement définie comme partie intégrante de ce groupe.

1 Sélectionnez le canal qui correspond à l'alias ou à l'ID de groupe en surbrillance. Voir [Sélection d'un type d'appel à la page 254](#).

2 Tenez le microphone à une distance de 2,5 cm à 5 cm de votre bouche.

3 Pour passer l'appel, appuyez sur le bouton de conversation **PTT**.

Le témoin DEL s'allume en vert continu. L'icône d'appel de groupe s'affiche dans le coin supérieur droit de l'écran. L'alias d'appel de groupe s'affiche sur la première ligne de texte.

4 Attendez la fin de la tonalité d'autorisation de conversation (si elle est activée) et parlez clairement dans le microphone.

5 Relâchez le bouton **PTT** pour écouter.

Lorsque la radio cible répond, le voyant DEL clignote en vert, la radio désactive la sourdine et la réponse se fait entendre sur le haut-parleur. L'icône d'appel de groupe, l'alias ou l'ID du groupe ainsi que l'alias ou l'ID de la radio à l'origine de la transmission s'affichent à l'écran.

S'il n'y a aucune activité vocale pendant une durée préprogrammée, l'appel prend fin. La radio revient à l'écran où vous étiez avant de faire l'appel.

Passer un appel individuel

Bien que vous puissiez recevoir un appel individuel effectué par une radio individuelle autorisée et y répondre, votre radio doit avoir été préalablement programmée pour vous permettre de passer un appel individuel.

Si cette fonction n'a pas été activée, une tonalité d'échec se fait entendre lorsque vous tentez de faire un appel individuel en passant par la touche **d'accès direct**, ou le bouton de sélection de canaux,.

- 1 Effectuez l'une des opérations suivantes.
 - Sélectionnez le canal qui correspond à l'alias ou à l'ID d'abonné en surbrillance. Voir [Sélection d'un type d'appel à la page 254](#).

- Appuyez sur la touche d'**accès direct** programmée.

-
- 2 Tenez le microphone à une distance de 2,5 cm à 5 cm de votre bouche.

-
- 3 Pour passer l'appel, appuyez sur le bouton de conversation **PTT**.

Le voyant DEL passe au vert continu. L'icône d'appel individuel s'affiche dans le coin supérieur droit de l'écran. L'alias de l'abonné s'affiche sur la première ligne de l'écran. L'état de l'appel s'affiche sur la deuxième ligne de l'écran..

-
- 4 Attendez la fin de la tonalité d'autorisation de conversation (si elle est activée) et parlez clairement dans le microphone.

-
- 5 Relâchez le bouton **PTT** pour écouter.

Lorsque la radio cible répond, le voyant DEL clignote en vert, .

S'il n'y a aucune activité vocale pendant une durée préprogrammée, l'appel prend fin. Une courte tonalité retentit. L'écran affiche Appel terminé.

Votre radio peut être programmée de manière à faire une vérification de présence radio avant d'établir l'appel individuel. Si la radio cible n'est pas disponible, une courte tonalité se fait entendre et un bref avis d'échec s'affiche à l'écran.

Faire un appel général de site

Cette fonction vous permet de transmettre un appel à tous les utilisateurs du site qui ne sont pas actuellement en communication pour un autre appel. Votre radio doit être programmée de manière à vous permettre d'utiliser cette fonction.

Les utilisateurs du canal ou du site ne peuvent pas répondre à l'appel général de site.

- 1 Sélectionnez le canal qui correspond à l'alias de groupe Appel général de site en surbrillance. Voir [Sélection d'un type d'appel à la page 254](#).
- 2 Tenez le microphone à une distance de 2,5 cm à 5 cm de votre bouche.

- 3 Pour passer l'appel, appuyez sur le bouton de conversation **PTT**.

Le voyant DEL passe au vert continu. L'icône d'appel de groupe s'affiche dans le coin supérieur droit de l'écran. La première ligne de l'écran affiche Appel général de site.

- 4 Attendez la fin de la tonalité d'autorisation de conversation (si elle est activée) et parlez clairement dans le microphone.

Appel multigroupe

Cette fonction vous permet de transmettre à tous les utilisateurs de groupes multiples. Votre radio doit être programmée de manière à vous permettre d'utiliser cette fonction.



AVIS:

Les utilisateurs des groupes ne peuvent pas répondre à un appel multigroupe.

- 1 Tournez le bouton de sélection de canaux pour sélectionner l'alias ou l'ID multigroupe.

- 2 Pour passer l'appel, appuyez sur le bouton de conversation **PTT**.

Le voyant DEL passe au vert continu. L'écran affiche l'alias ou l'ID multigroupe.

Attendez la fin de la tonalité d'autorisation de parler (si elle est activée) et parlez clairement dans le microphone.

Appel individuel fait à l'aide du bouton de composition à une touche



AVIS:

Les boutons programmables doivent être enfoncés à partir de l'écran d'accueil.

La fonction d'appel direct vous permet de passer aisément un appel individuel à un alias ou ID d'appel individuel prédéfini. Vous pouvez attribuer cette fonction à une touche programmable avec une brève ou une longue pression.

Vous ne pouvez attribuer qu'UN SEUL alias ou ID à un bouton d'appel direct. Vous pouvez programmer plusieurs boutons d'appel directs pour votre radio.

- 1 Appuyez sur le bouton d'**appel direct** programmé pour passer un appel individuel à un alias ou ID d'appel individuel prédéfini.

-
- 2 Tenez le microphone à une distance de 2,5 cm à 5 cm de votre bouche.

-
- 3 Pour passer l'appel, appuyez sur le bouton de conversation **PTT**.

Le voyant DEL passe au vert continu.

L'écran affiche l'alias ou l'ID d'appel individuel.

-
- 4 Attendez la fin de la tonalité d'autorisation de parler (si elle est activée) et parlez clairement dans le microphone.

-
- 5 Relâchez le bouton **PTT** pour écouter.

Lorsque la radio cible répond, le voyant DEL clignote en vert.

S'il n'y a aucune activité vocale pendant une durée préprogrammée, l'appel prend fin.

Passer un appel au moyen de la touche programmable de composition manuelle

Cette fonction permet à l'utilisateur radio de faire des appels privés à l'aide de la touche programmable de composition manuelle.

Passer un appel individuel

- 1 Appuyez sur la touche programmée **Num. manuelle** pour afficher l'écran de composition manuelle.

L'écran affiche Numéro : .

- 2 Utilisez le clavier pour entrer un ID privé ou un alias d'abonné.
-

- 3 Tenez le microphone à une distance de 2,5 cm à 5 cm de votre bouche.
-

- 4 Pour passer l'appel, appuyez sur le bouton de conversation **PTT**.

Le voyant DEL passe au vert continu. L'icône d'appel individuel s'affiche dans le coin supérieur droit de l'écran. L'alias de l'abonné s'affiche sur la première ligne de l'écran. L'état de l'appel s'affiche sur la deuxième ligne de l'écran.

- 5 Attendez la fin de la tonalité d'autorisation de parler (si elle est activée) et parlez clairement dans le microphone.
-

- 6 Relâchez le bouton **PTT** pour écouter.

Lorsque la radio cible répond, le voyant DEL clignote en vert.

S'il n'y a aucune activité vocale pendant une durée préprogrammée, l'appel prend fin. Une courte tonalité retentit. L'écran affiche Appel terminé.

Faire un appel téléphonique individuel sortant à l'aide du bouton



programmable de numérotation manuelle

- 1 Appuyez sur la touche programmée **Num. manuelle** pour afficher l'écran de composition manuelle.

L'écran affiche Numéro :.

- 2 Utilisez le clavier pour saisir un numéro de téléphone et appuyez sur  pour passer l'appel vers ce numéro.

Appuyez sur  pour supprimer les caractères

inutiles. Appuyez sur  , suivi de  dans les 2 secondes, pour insérer une pause. Le P remplace * et # sur l'afficheur.

En cas de réussite, la première ligne de l'écran affiche Appel tél. La deuxième ligne de l'écran affiche le numéro de téléphone composé.

Si un numéro de téléphone incorrect est sélectionné, l'écran affiche un mini-avis négatif, Appel tél. échoué, Ressource indisponible, ou Autorisations invalides.

Si vous appuyez sur  et qu'aucun numéro de téléphone n'a été saisi, la radio fait entendre une tonalité d'indication positive suivie d'une tonalité négative. L'afficheur ne change pas.



- 3 Appuyez longuement sur  pour mettre fin à l'appel.

La première ligne de l'écran affiche le message Fin. La deuxième ligne de l'écran affiche Appel tél.

L'écran affiche Appel tél. terminé.

Faire un appel téléphonique individuel sortant au moyen du menu du téléphone

- 1 Appuyez sur  pour accéder au menu.



- 2 Appuyez sur  ou  jusqu'à Téléphone, puis sur appuyez sur  pour sélectionner.

- 3 Appuyez sur  pour sélectionner Numérotation manuelle.

La première ligne de l'écran affiche le Numéro et la deuxième ligne affiche un curseur clignotant.

- 4 Utilisez le clavier pour saisir un numéro de téléphone et appuyez sur  pour passer l'appel vers ce numéro.

Appuyez sur  pour supprimer les caractères

inutiles. Appuyez sur , suivi de  dans les 2 secondes, pour insérer une pause. Le P remplace * et # sur l'afficheur.

En cas de réussite, la première ligne de l'écran affiche Appel tél. La deuxième ligne de l'écran affiche le numéro de téléphone composé.

Si un numéro de téléphone incorrect est sélectionné, l'écran affiche un mini-avis négatif, Appel tél. échoué, Ressource indisponible, ou Autorisations invalides.

Si vous appuyez sur  et qu'aucun numéro de téléphone n'a été saisi, la radio fait entendre une

tonalité d'indication positive suivie d'une tonalité négative. L'afficheur ne change pas.

- 5 Appuyez longuement sur  pour mettre fin à l'appel.

La première ligne de l'écran affiche le message Fin. La deuxième ligne de l'écran affiche Appel tél.

L'écran affiche Appel tél. terminé.











Faire un appel téléphonique individuel sortant à partir des Contacts





AVIS:

Si la numérotation manuelle du téléphone est désactivée dans MOTOTRBRO Connect Plus Option Board CPS, le No. téléphone ne s'affichera **pas** dans le menu.

- 1 Appuyez sur  pour accéder au menu.

- 2 Appuyez sur  ou  Contacts, puis sur  pour sélectionner.
-
- 3 Appuyez sur  ou  jusqu'à Numérotation manuelle, puis sur  pour sélectionner.
-
- 4 Appuyez sur  ou  jusqu'à Numéro de téléphone, puis sur  pour sélectionner.
- La première ligne de l'écran affiche le Numéro et la deuxième ligne affiche un curseur clignotant.
-
- 5 Utilisez le clavier pour saisir un numéro de téléphone et appuyez sur  pour passer l'appel vers ce numéro.
- Si le bouton **PTT** est enfoncé, l'écran affiche un mini-avis négatif Appuyez sur OK pour envoyer et revient à l'écran précédent.

Appuyez sur  pour supprimer les caractères inutiles. Appuyez sur  , suivi de  dans les 2 secondes, pour insérer une pause. Le P remplace * et # sur l'afficheur.

En cas de réussite, la première ligne de l'écran affiche Appel tél. La deuxième ligne de l'écran affiche le numéro de téléphone composé.

Si vous appuyez sur  et qu'aucun numéro de téléphone n'a été saisi, la radio fait entendre une tonalité d'indication positive suivie d'une tonalité négative. L'afficheur ne change pas.

-
- 6 Appuyez longuement sur  pour mettre fin à l'appel.
- La première ligne de l'écran affiche le message Fin. La deuxième ligne de l'écran affiche Appel tél.
- L'écran affiche Appel tél. terminé.
-

Attente d'autorisation de canal lors d'un appel individuel sortant

Lorsque vous passez un appel individuel, la première ligne de l'écran affiche Appel tél. La deuxième ligne de l'écran affiche le numéro de téléphone composé.

Une fois l'appel connecté, l'icône Appel téléphonique en tant qu'appel individuel s'affiche dans le coin supérieur droit de l'écran. La première ligne de l'écran affiche le numéro de téléphone.

En cas d'échec, l'écran affiche un mini-avis négatif, Appel tél. échoué, Ressource indisponible, ou Invalid Permissions (Autorisations invalides).



Appuyez longuement sur  pour mettre fin à l'appel.

La radio revient à l'écran précédent.

Composition surnuméraire en mémoire tampon en cours d'appel téléphonique individuel sortant

Pendant l'appel, l'icône Appel téléphonique en tant qu'appel individuel s'affiche dans le coin supérieur droit de l'écran. La première ligne de texte sur l'écran affiche le numéro de téléphone.

- 1 Utilisez le clavier pour entrer les chiffres.

Appuyez sur  pour supprimer les caractères inutiles. Appuyez sur , suivi de  dans les 2 secondes, pour insérer une pause. Le P remplace * et # sur l'afficheur.



La première ligne de l'écran affiche le texte Chiffres suppl. et la deuxième ligne de l'écran affiche les chiffres supplémentaires.

- 2 Appuyez sur le bouton  .

Si le bouton **PTT** est enfoncé, l'écran affiche un mini-avis négatif Appuyez sur OK pour envoyer et revient à l'écran précédent.

L'icône Appel téléphonique en tant qu'appel individuel s'affiche dans le coin supérieur droit de l'écran. La première ligne de texte de l'écran affiche le numéro de téléphone avec les chiffres supplémentaires (composition surnuméraire).

3 Effectuez l'une des opérations suivantes.

- Appuyez sur  pour revenir à l'écran d'appel téléphonique.
- Appuyez longuement sur  pour mettre fin à l'appel.

Composition surnuméraire en direct en cours d'appel téléphonique individuel sortant

Pendant l'appel, l'icône Appel téléphonique en tant qu'appel individuel s'affiche dans le coin supérieur droit de

l'écran. La première ligne de texte sur l'écran affiche le numéro de téléphone.

- 1 Appuyez sur le bouton **PTT** et utilisez le clavier pour saisir les chiffres.

L'icône Appel téléphonique en tant qu'appel individuel s'affiche dans le coin supérieur droit de l'écran. La première ligne de texte de l'écran affiche le numéro de téléphone avec les chiffres supplémentaires (composition surnuméraire).

-
- 2 Appuyez longuement sur  pour mettre fin à l'appel.

La première ligne de l'écran affiche le message Fin. La deuxième ligne de l'écran affiche Appel tél.

L'écran affiche Appel tél. terminé.

Fonctions avancées en mode Connect Plus

Ce chapitre décrit le fonctionnement des fonctions disponibles sur votre radio.

Rappel du canal d'accueil

Cette fonction permet d'émettre un rappel si la radio n'est pas réglée sur le canal d'accueil pendant un certain temps.

Si cette fonction est activée par le CPS, la tonalité de rappel du canal d'accueil et l'avertissement sonore retentissent. De plus, la première ligne de l'écran affiche **Non** et la deuxième **Canal d'accueil** de manière répétée lorsque la radio n'est pas réglée sur le canal d'accueil pendant un certain temps.

Vous pouvez interrompre la diffusion du rappel en effectuant l'une des actions suivantes :

- Retourner au canal d'accueil.
- Mettre temporairement en sourdine l'avertissement à l'aide du bouton programmable.
- Définir un nouveau canal d'accueil à l'aide du bouton programmable.

Plan de secours automatique

Le plan de secours automatique est une fonction du système qui permet de continuer à effectuer et à recevoir des appels non urgents dans le groupe de contacts

sélectionné s'il se produit certains types de défaillance du système Connect Plus.

Si une telle défaillance se produit, votre radio tente de s'accéder à un autre site Connect Plus. Ce processus de recherche peut amener votre radio à trouver un site Connect Plus fonctionnel ou un « canal de secours » (si le plan de secours automatique est activé sur votre radio). Un canal de secours est un répéteur qui fait habituellement partie d'un site Connect Plus fonctionnel, mais qui n'est pas en mesure de communiquer pour l'instant ni avec son contrôleur de site ni avec le réseau Connect Plus. En mode de reprise d'appel automatique, le répéteur fonctionne en tant que répéteur numérique « autonome ». Le mode de secours automatique ne prend en charge que les appels de groupe non urgents. Aucun autre type d'appel n'est pris en charge en mode de secours.

Indications de mode de reprise d'appel automatique

Lorsque votre radio utilise un canal de reprise d'appel, vous pouvez entendre une « tonalité de reprise » intermittente à peu près toutes les quinze secondes (sauf durant la transmission). L'écran affiche brièvement le message « Canal de reprise d'appel » de manière périodique. Votre radio ne permet d'utiliser le PTT qu'avec le groupe de

contacts sélectionné (appel de groupe, appel multigroupe ou appel général de site). Elle ne vous permet pas de passer d'autres types d'appels.

Recevoir et passer des appels en mode de reprise



AVIS:

Les appels ne sont entendus que par les radios qui écoutent le même canal de reprise et qui ont sélectionné le même groupe. Les appels ne sont pas mis en réseau avec d'autres sites ou d'autres relais.

Ni les appels vocaux d'urgence ni les alertes d'urgence ne sont disponibles en mode de reprise. Si vous appuyez sur le bouton d'urgence en mode de reprise, la radio émet une tonalité de touche non valide. Les radios dotées d'un écran affichent aussi le message « Fonction non disponible ».

Les appels privés (de radio à radio) et les appels téléphoniques ne sont pas disponibles en mode reprise. Si vous tentez d'appeler un contact individuel, vous recevrez une tonalité de refus. À ce moment, vous devez sélectionner un contact du groupe désiré. Voici d'autres types d'appels non pris en charge : écoute ambiance, avertissement d'appel, vérification de la radio, activation de la radio, désactivation de la radio, messagerie texte, actualisation d'emplacement et appels de données en paquets.

L'accès amélioré au canal de trafic (ETCA) n'est pas pris en charge en mode de reprise automatique. Si deux utilisateurs de radio ou plus appuient sur le bouton **PTT** en même temps (ou presque en même temps), il est possible que les deux radios émettent jusqu'à ce que le bouton **PTT** soit relâché. Dans ce cas, il est possible qu'aucune transmission ne soit comprise par les radios réceptrices.

Pour passer des appels en mode de reprise, procédez comme pour le fonctionnement normal. Sélectionnez simplement le contact de groupe que vous désirez utiliser (en utilisant la méthode de sélection habituelle de canal de la radio), puis appuyez sur le bouton **PTT** pour faire votre appel. Il est possible que le canal soit déjà utilisé par un autre groupe. Si le canal est déjà utilisé, une tonalité « occupé » retentit et l'écran affiche « Canal occupé ». Vous pouvez sélectionner des contacts de groupe, multigroupe ou d'appel général de site en utilisant la méthode de sélection habituelle de canal de la radio. Lorsque la radio est utilisée sur le canal de reprise, les groupes multiples fonctionnent comme les autres groupes. Elle ne peut être entendue que par les radios qui ont sélectionné le même multigroupe.

Retour au fonctionnement normal

Si le site revient au fonctionnement ADF normal pendant que vous vous trouvez à portée du répéteur de secours, votre radio quitte automatiquement le mode de secours automatique. Un bip retentit lorsque votre radio est enregistrée. Si vous êtes à portée d'un site fonctionnel (qui n'est pas en mode de secours), vous pouvez appuyer sur le bouton de demande d'itinérance (si cette fonction est programmée dans votre radio) pour forcer votre radio à rechercher un site disponible et à s'y enregistrer. Si aucun autre site n'est disponible, votre radio retourne au mode de secours automatique une fois la recherche terminée. Si vous sortez de la zone de couverture de votre répéteur de secours, votre radio se met en mode de recherche (l'écran affiche Recherche).







Vérification de la radio







Lorsqu'activée, la fonction Vérif. radio vous permet de déterminer si une autre radio est en fonction au sein d'un système, sans importuner l'utilisateur de cette radio. Aucune notification sonore ou visuelle ne se manifeste sur la radio cible.

Cette fonction n'est offerte que pour les alias ou ID d'abonné.

Envoyer une vérification radio

- 1 Accédez à la fonction Vérification de la radio.

Commande radio	Étapes à suivre
Touche programmée Vérif. radio	<p>a Appuyez sur la touche programmée Vérif. radio.</p> <p>b Appuyez sur  ou  jusqu'à l'alias ou l'ID d'abonné requis, puis sur  pour sélectionner.</p>
Menu	<p>a Appuyez sur  pour accéder au menu.</p> <p>b Appuyez sur  ou  Contacts, puis sur  pour sélectionner.</p>

Commande radio	Étapes à suivre
	<p>c Appuyez sur  ou  jusqu'à l'alias ou l'ID d'abonné requis, puis sur  pour sélectionner.</p> <p>d Appuyez sur  ou  Vérification radio, puis sur  pour sélectionner.</p>

L'écran affiche l'alias cible indiquant que l'exécution de la requête est en cours. Le voyant DEL passe au vert continu.

- 2 Attendez la confirmation.

Si la radio cible est active dans le système, une tonalité retentit et l'écran affiche brièvement le message Radio cible disponible.

Si la radio cible n'est pas active dans le système, une tonalité retentit et l'écran affiche brièvement le message **Radio cible Non disponible**.

La radio revient à l'écran d'alias ou d'ID d'abonné lorsque la commande est activée à partir du menu.

La radio revient à l'écran d'accueil si la commande est activée à partir du bouton programmable.

Écoute à distance

Utilisez la fonction Écoute ambiance pour activer le microphone d'une radio cible (alias ou ID d'abonné seulement). Le voyant DEL clignotera une fois en vert sur l'abonné visé. Vous pouvez utiliser cette fonction pour écouter à distance toute activité audible entourant la radio cible.

Votre radio doit être programmée de manière à vous permettre d'utiliser cette fonction.





Lancer la fonction Écoute ambiance















AVIS:

Le moniteur à distance s'arrête automatiquement après une durée programmée ou lors d'une tentative de transmission, de changement de canal ou de mise hors tension de la radio.

- 1 Accédez à la fonction Écoute ambiance.

Commande radio	Étapes à suivre
Touche programmée Écoute ambiance.	<p>a Appuyez sur la touche programmée Écoute à distance.</p> <p>b Appuyez sur  ou  jusqu'à l'alias ou l'ID d'abonné requis, puis sur  pour sélectionner.</p>
Menu	<p>a Appuyez sur  pour accéder au menu.</p>

Commande radio	Étapes à suivre
	<p>b Appuyez sur  ou  Contacts, puis sur  pour sélectionner.</p> <p>c Appuyez sur  ou  jusqu'à l'alias ou l'ID d'abonné requis, puis sur  pour sélectionner.</p> <p>d Appuyez sur  ou  jusqu'à Numérotation manuelle, puis sur  pour sélectionner.</p> <p>e Appuyez sur  ou  jusqu'à Écoute amb., puis</p>

Commande radio	Étapes à suivre
	<p>sur appuyez sur  pour sélectionner.</p>

La première ligne de l'écran affiche Écoute. à distance. La deuxième ligne affiche l'alias cible, indiquant que l'exécution de la requête est en cours. Le voyant DEL passe au vert clignotant.

2 Attendez la confirmation.

En cas de réussite, une tonalité de réussite se fait entendre et l'écran affiche le message Écoute amb. Écoute réussie. Votre radio fait entendre l'audio provenant de la radio écoutée pendant une durée programmée, et l'écran affiche Écoute Moniteur, suivi par l'alias cible. Lorsque la minuterie s'arrête, la radio fait entendre une tonalité d'avertissement et le voyant DEL s'éteint.

En cas d'échec, une tonalité d'indication négative se fait entendre et l'écran affiche le message Écoute amb. Échec d'écoute.

Balayage

Cette fonction permet à votre radio d'écouter et de joindre des appels pour des groupes/canaux définis dans une liste de balayage préprogrammée. Lorsque la fonction de balayage est activée, l'icône de balayage apparaît dans la barre d'état. Le voyant DEL clignote en jaune si le balayage devient inactif.

Démarrer et arrêter le balayage









AVIS:

Cette procédure active ou désactive le balayage pour toutes zones Connect Plus avec la même ID réseau que la zone actuellement sélectionnée. Il est important de noter que même lorsque la fonction de balayage est activée au moyen de cette procédure, le balayage peut encore être désactivé pour certains groupes (ou tous) de votre liste de balayage. Pour obtenir plus de renseignements à ce sujet, consultez la section [Modifier la liste de balayage à la page 278](#).

Vous pouvez lancer et arrêter un balayage en appuyant sur la touche programmée **Balayage OU** en suivant la procédure ci-dessous.

- 1 Appuyez sur  pour accéder au menu.

- 2 Appuyez sur  ou  jusqu'à l'option Balayage, puis sur appuyez sur  pour sélectionner.

- 3 Appuyez sur  ou  jusqu'à Allumer ou Éteindre, puis sur appuyez sur  pour sélectionner.
 - L'écran affiche Scan Activé lorsque le balayage est activé.
 - Le menu Balayage affiche le message Éteindre si le balayage est activé.
 - L'écran affiche Scan désactivé lorsque le balayage est désactivé.
 - Le menu Balayage affiche le message Allumer si le balayage est désactivé.

Répondre à une transmission pendant un balayage

Lorsqu'elle exécute un balayage, votre radio s'arrête sur un groupe si elle y détecte de l'activité. La radio balaie en continu pour détecter des membres de la liste de balayage lorsqu'elle se trouve sur le canal de contrôle.

1 Tenez le microphone à une distance de 2,5 cm à 5 cm de votre bouche.

2 Appuyez sur le bouton **PTT** pendant la période d'attente.

Le voyant DEL passe au vert continu.

3 Attendez la fin de la tonalité d'autorisation de conversation (si elle est activée) et parlez clairement dans le microphone.

4 Relâchez le bouton **PTT** pour écouter.

Si vous ne répondez pas avant que la période d'attente soit écoulée, la radio reprend le balayage des autres groupes.

Balayage configurable par l'utilisateur

Si le menu Modifier liste est activé, l'utilisateur peut ajouter ou supprimer des membres de la liste de balayage à partir du menu Ajouter membre. Un membre de la liste de balayage doit être un contact de groupe régulier (p. ex. non pas un contact multigroupe ou d'appel général de site/de réseau) qui est actuellement affecté à une position du sélecteur de canal dans une zone Connect Plus avec le même ID réseau que la zone actuellement sélectionnée. De plus, l'alias du groupe ne doit concorder avec aucun groupe déjà inclus dans la liste de balayage de la zone courante.

Le balayage peut être activé ou désactivé au moyen du menu ou en appuyant sur un **balayage activé/désactivé** programmé.

Cette fonction n'est accessible que si la radio n'a pas d'appel en cours. Si vous avez un appel en cours, votre radio ne peut pas effectuer de balayage pour rechercher d'autres appels de groupe et n'en perçoit donc pas. Une fois l'appel terminé, votre radio retourne au créneau temporel du canal de contrôle et est en mesure de balayer pour repérer les groupes de la liste de balayage.

Activer ou désactiver le balayage





AVIS:



Cette procédure active ou désactive le balayage pour toutes les zones avec la même ID réseau que la zone actuellement sélectionnée. Il est important de noter que même lorsque la fonction de balayage est activée au moyen de cette procédure, le balayage peut encore être désactivé pour certains groupes (ou tous) de votre liste de balayage. Pour obtenir plus de renseignements, consultez la section suivante.

Lorsque le balayage est activé, l'icône de balayage s'affiche à l'écran. Lorsque le balayage est activé et que vous n'avez pas d'appel en cours, le voyant DEL clignote en vert et jaune.

La procédure pour activer ou désactiver le balayage dépend de la façon dont votre radio est programmée. Si elle a été programmée avec un bouton de balayage activé/désactivé, utilisez-le pour activer ou désactiver la fonction. Si votre radio a été programmée pour que le balayage puisse être activé ou désactivé au moyen du menu, procédez comme suit.

- 1 Appuyez sur  pour accéder au menu.
-

- 2 Appuyez sur  ou  jusqu'à l'option **Balayage**, puis sur appuyez sur  pour sélectionner.
-

- 3 Appuyez sur  ou  jusqu'à **Allumer** ou **Éteindre**, puis sur appuyez sur  pour sélectionner.
 - L'écran affiche **Balayage activé** pendant un moment lorsque le balayage est désactivé.
 - L'écran affiche **Balayage désactivé** pendant un moment lorsque le balayage est activé.
-

Modifier la liste de balayage



AVIS:

Si l'entrée de la liste de balayage se trouve à être dans le groupe actuellement sélectionné, la radio vérifie s'il y a de l'activité dans ce groupe, qu'il y ait ou non un crochet devant l'entrée de la liste. Quand une radio n'a pas d'appel en cours, la radio vérifie s'il y a de l'activité dans le groupe sélectionné, le multigroupe, l'appel général de site et son groupe d'annulation d'urgence par défaut (s'il y en a un de configuré). Cette opération ne peut pas être désactivée. Si le balayage est activé, la radio vérifie également s'il y a de l'activité auprès des membres activés de la liste de balayage de zone.

Votre liste de balayage détermine les groupes qui peuvent être balayés. La liste est créée lors de la programmation de votre radio. Si votre radio a été programmée pour vous permettre de modifier la liste de balayage, vous pouvez :

- Activer ou désactiver le balayage de groupes individuels dans la liste.
- Ajouter ou supprimer des membres de la liste de balayage à partir du menu Ajouter membre. Reportez-vous à la section [Ajouter ou supprimer un groupe à partir du menu Ajouter membre à la page 279](#).







AVIS:

Un membre de la liste de balayage doit être un contact de groupe régulier (et non pas un contact multigroupe ou d'appel général de site/de réseau) qui est actuellement affecté à une position du sélecteur de canal dans une zone Connect Plus avec le même ID réseau que la zone actuellement sélectionnée.

De plus, l'alias du groupe ne doit concorder avec aucun groupe déjà inclus dans la liste de balayage de la zone courante.

- 1 Appuyez sur  pour accéder au menu.

- 2 Appuyez sur  ou  jusqu'à Voir/Modif liste, puis sur appuyez sur  pour sélectionner.

- 3 Appuyez sur  ou  jusqu'au nom de groupe voulu.
 S'il y a un crochet devant le nom du groupe, le balayage est actuellement activé pour ce groupe.
 S'il n'y a pas de crochet devant le nom du groupe, le balayage est actuellement désactivé pour ce groupe.

- 4  pour sélectionner le groupe voulu.

L'écran affiche **Activer** si le balayage est désactivé pour le groupe.

L'écran affiche **Désactiver** si le balayage est activé pour le groupe.

- 5 Sélectionnez l'option affichée (**Activer** ou **Désactiver**), puis appuyez sur  pour sélectionner.

Selon l'option qui a été sélectionnée, la radio affiche brièvement **Balayage activé** ou **Balayage désactivé** en guise de confirmation.



La radio affiche de nouveau la liste de balayage de la zone. Si le balayage est activé pour le groupe, le crochet est affiché devant le nom du groupe. Si le balayage est désactivé pour le groupe, le crochet est supprimé devant le nom du groupe.



Ajouter ou supprimer un groupe à partir du menu **Ajouter membre**

La radio Connect Plus n'autorise pas les numéros ou les alias de groupe en double à être insérés dans une liste de balayage de zone (ou à être affichés en tant que « candidats pour le balayage »). Ainsi, la liste des « candidats pour le balayage » décrite aux étapes [étape 6](#) et [étape 7](#) change parfois après l'ajout ou la suppression d'un groupe dans la liste de balayage de zone.



Si votre radio a été programmée pour vous permettre de modifier la liste de balayage, vous pouvez utiliser le menu **Ajouter membre** pour ajouter un groupe à la liste de balayage de la zone actuellement sélectionnée ou pour supprimer un groupe de la liste de balayage de la zone actuellement sélectionnée.

- 1 Appuyez sur  pour accéder au menu.

- 2 Appuyez sur  ou  jusqu'à l'option **Balayage**, puis appuyez sur  pour sélectionner.

3 Appuyez sur  ou  pour <Ajouter membre>, puis appuyez sur  pour sélectionner. L'écran affiche le message *Ajouter membre de la zone n* (où n = le numéro de zone Connect Plus de la première zone Connect Plus de votre radio possédant le même ID réseau que votre zone actuellement sélectionnée).



- 4 Effectuez l'une des opérations suivantes.
- Si le groupe que vous souhaitez ajouter à la liste de balayage est affecté à une position du sélecteur de canaux dans cette zone, passez à [étape 6](#).
 - Si le groupe que vous souhaitez ajouter à la liste de balayage est affecté à une position du sélecteur de canaux dans une autre zone Connect Plus, passez [étape 5](#).
-

5 Appuyez sur  ou  pour faire défiler une liste de zones Connect Plus possédant le même ID réseau que la zone actuellement sélectionnée.

6 Après avoir localisé la zone Connect Plus dans laquelle le groupe désiré est affecté à une position du sélecteur de canal, appuyez sur  pour sélectionner.

Votre radio affiche la première entrée d'une liste de groupes affectés à une position du sélecteur de canal dans cette zone. Les groupes de la liste sont appelés « candidats pour le balayage » parce qu'ils peuvent être ajoutés à la liste de balayage de votre zone actuellement sélectionnée (ou qu'ils se trouvent déjà dans la liste de balayage de la zone).

Si la zone ne comprend aucun groupe pouvant être ajouté à la liste de balayage, la radio affiche le message *Aucun candidat*.

7 Appuyez sur  ou  pour faire défiler la liste des groupes candidats.

Si un signe plus (+) est affiché immédiatement avant l'alias d'un groupe, cela indique que le groupe figure actuellement dans la liste de balayage de la zone sélectionnée.

Si le signe plus (+) n'est pas affiché immédiatement avant l'alias d'un groupe, cela signifie que le groupe

ne figure actuellement pas dans la liste de balayage, mais qu'il peut être ajouté.

- 8 Appuyez sur  lorsque l'alias de groupe désiré s'affiche.

Si ce groupe ne figure pas actuellement dans la liste de balayage de la zone actuellement sélectionnée, le message *Ajouter* (alias du groupe) s'affiche.

Si ce groupe figure déjà dans la liste de balayage de la zone actuellement sélectionnée, le message *Supprimer* (alias du groupe) s'affiche.

- 9 Appuyez sur  pour accepter le message affiché (*Ajouter* ou *Supprimer*).

Si vous supprimez un groupe de la liste, vous saurez que l'opération a réussi lorsque le signe plus (+) n'apparaîtra plus immédiatement devant l'alias.

Si vous ajoutez un groupe de la liste, vous saurez que l'opération a réussi lorsque le signe plus (+) apparaîtra immédiatement devant l'alias.

Si vous tentez d'ajouter un groupe et que la liste est déjà pleine, la radio affiche le message *Liste pleine*. Dans une telle éventualité, vous devrez

supprimer un groupe de la liste de balayage avant d'en ajouter un nouveau.

- 10 Lorsque vous avez terminé, appuyez sur  autant de fois que nécessaire pour revenir au menu désiré.

Comprendre la fonction de balayage



AVIS:

Si la radio se joint à un appel passé à un membre de zone de liste de balayage à partir d'une zone différente et que le minuteur de mise en attente d'appel expire avant que vous puissiez répondre, vous devez alors atteindre la zone et le canal du membre de la liste de balayage et passer un nouvel appel.

Il y a des circonstances dans lesquelles vous pouvez manquer des appels de groupe qui se trouvent dans votre liste de balayage. Si vous manquez un appel pour l'une des raisons suivantes, cela n'indique pas que votre radio présente un problème. Il s'agit du fonctionnement normal du balayage en mode Connect Plus.

- La fonction de balayage n'est pas activée (recherchez l'icône de balayage à l'écran).

- Un canal membre de la liste de balayage a été désactivé par le biais du menu (consultez la section [Modifier la liste de balayage à la page 278](#)).
- Vous avez déjà un appel en cours.
- Aucun membre du groupe balayé n'est enregistré auprès de votre site (systèmes multisite seulement).

Réponse de balayage

Si votre radio balaye un appel à partir de la liste de balayage de groupe à sélectionner, et si le bouton **PTT** est actionné au cours du balayage d'appel, le fonctionnement de la radio dépendra de l'activation ou de la désactivation de l'option de réponse de balayage pendant la programmation de la radio. Pour obtenir des renseignements supplémentaires, adressez-vous à votre détaillant ou à votre administrateur de système.

Réponse de balayage désactivée

La radio abandonne l'appel balayé et tente de transmettre au contact pour la position de canal sélectionnée. Après expiration du temps de maintien d'appel sur le contact actuellement sélectionné, la radio revient au canal d'accueil et démarre la minuterie de mise en attente du balayage. La radio reprend le

balayage de groupe après que le délai d'attente du balayage soit écoulé.

Réponse de balayage activée

Si le bouton **PTT** est actionné durant le temps de maintien de l'appel de groupe balayé, la radio essaie de transmettre au groupe balayé.



AVIS:

Si vous balayez un appel pour un groupe qui n'est pas associé à une position de canal dans la zone actuellement sélectionnée et que vous manquez le temps de maintien d'appel, vous devez passer à la zone appropriée et sélectionner la position de canal du groupe pour pouvoir répondre à ce groupe.



Modifier l'ordre de priorité d'un groupe d'appels



La fonction Surveillance prioritaire permet à la radio d'automatiquement recevoir les transmissions du groupe d'appels avec une priorité supérieure lorsqu'elle est sur un autre appel. Une tonalité se fait entendre lorsque la radio passe à l'appel à la priorité plus élevée. Il existe deux niveaux de priorité pour les groupes d'appels : P1 et P2. P1 est une priorité supérieure à P2.



**AVIS:**



Si l'ID de groupe d'annulation d'urgence par défaut est configuré dans le CPS de la carte d'option MOTOTRBO Connect Plus, il existe trois niveaux de priorité pour des groupes d'appels : P0, P1 et P2. P0 est l'ID de groupe d'annulation d'urgence permanente et la priorité la plus élevée. Pour obtenir des renseignements supplémentaires, adressez-vous à votre détaillant ou à votre administrateur de système.



- 1 Appuyez sur  pour accéder au menu.

- 2 Appuyez sur  ou  jusqu'à l'option Balayage, puis sur appuyez sur  pour sélectionner.

- 3 Appuyez sur  ou  jusqu'à Voir/Modif liste, puis sur appuyez sur  pour sélectionner.

- 4 Appuyez sur  ou  jusqu'au groupe voulu, puis sur appuyez sur  pour sélectionner.

- 5 Appuyez sur  ou  jusqu'à Modif. priorité, puis sur appuyez sur  pour sélectionner.

- 6 Appuyez sur  ou  jusqu'au niveau de priorité requis, puis sur appuyez sur  pour sélectionner.

L'écran affiche un bref avis de réussite avant de revenir à l'écran précédent. L'icône de priorité s'affiche à la gauche du groupe d'appels.

Réglages des contacts



AVIS:

Vous pouvez ajouter ou modifier des ID d'abonné pour les contacts Connect Plus. La suppression des ID d'abonné ne peut être effectuée que par votre détaillant.

La fonction de cryptage est activée sur un canal; vous pouvez passer un appel vocal crypté sur ce canal. Seule une radio cible dotée de la même clé de cryptage ou des mêmes valeurs et ID de clé que votre radio peut décoder la transmission.

L'accès à des listes de contacts dépend de la configuration de zone :

- Si seulement un fuseau horaire est configuré dans la radio, la liste de contacts affiche directement la liste à partir de la zone sélectionnée.
- Si plusieurs zones sont configurés dans la radio, le dossier de contacts de la zone affiche toutes les zones avec les mêmes ID réseau que la zone sélectionnée. L'utilisateur peut accéder aux contacts dans ces zones.





La fonction Contacts correspond au carnet d'adresses de votre radio. Chaque entrée est associée à un alias ou à un ID que vous utilisez pour passer un appel.

Chaque zone permet d'avoir une liste pouvant contenir jusqu'à 100 contacts. Les types de contacts suivants sont disponibles :

- Appel individuel
- Appel de groupe
- Appel multigroupe
- Appel général de site vocal
- Appel général de site texte
- Appel de répartition

Le type de contact d'appel de répartition sert à envoyer un message texte à un PC répartiteur par le biais d'un serveur de messagerie texte de tiers.

Passer un appel individuel à partir des contacts

- 1 Appuyez sur  pour accéder au menu.
-
- 2 Appuyez sur  ou  Contacts, puis sur  pour sélectionner.

Les entrées sont classées alphabétiquement.

3 Tenez le microphone à une distance de 2,5 cm à 5 cm de votre bouche.

4 Pour passer l'appel, appuyez sur le bouton de conversation **PTT**.

Le voyant DEL passe au vert continu.

5 Attendez la fin de la tonalité d'autorisation de conversation (si elle est activée) et parlez clairement dans le microphone.

6 Relâchez le bouton **PTT** pour écouter.

Lorsque l'utilisateur de la radio cible répond, le voyant DEL clignote en vert et l'écran affiche l'ID de l'utilisateur qui effectue la transmission.

S'il n'y a aucune activité vocale pendant une durée préprogrammée, l'appel prend fin.



Une courte tonalité retentit. L'écran affiche Appel terminé.

Faire un appel à l'aide de la recherche d'alias



Vous pouvez également utiliser un alias ou une recherche alphanumérique pour récupérer l'alias d'un abonné.

Cette fonction n'est accessible qu'au moyen de la liste des contacts.

1 Appuyez sur  pour accéder au menu.

2 Appuyez sur  ou  Contacts, puis sur  pour sélectionner.

Les entrées sont classées alphabétiquement.

3 Entrez le premier caractère de l'alias requis, puis appuyez sur la touche  ou  pour localiser l'alias requis.

4 Tenez le microphone à une distance de 2,5 cm à 5 cm de votre bouche.

- 5 Pour passer l'appel, appuyez sur le bouton de conversation **PTT**.

Le voyant DEL passe au vert continu. L'écran affiche l'alias de destination.

- 6 Attendez la fin de la tonalité d'autorisation de conversation (si elle est activée) et parlez clairement dans le microphone.
-

- 7 Relâchez le bouton **PTT** pour écouter.



Lorsque la radio cible répond, le voyant DEL clignote en vert.



S'il n'y a aucune activité vocale pendant une durée préprogrammée, l'appel prend fin.

L'écran affiche Appel terminé.

Ajout d'un nouveau contact



- 1 Appuyez sur  pour accéder au menu.
-

- 2 Appuyez sur  ou  Contacts, puis sur appuyez sur  pour sélectionner.
-

- 3 Appuyez sur  ou  jusqu'à Nouveau contact, puis sur appuyez sur  pour sélectionner.
-

- 4 Utilisez le clavier pour entrer le numéro du contact et appuyez sur  pour confirmer.
-

- 5 Utilisez le clavier pour entrer le nom du contact et appuyez sur  pour confirmer.
-

- 6 Si vous ajoutez un contact radio, appuyez sur  ou  jusqu'au type de sonnerie voulu, puis sur appuyez sur  pour sélectionner.
La radio fait entendre une tonalité de réussite et l'écran affiche le message Contact enregistré.
-



Réglages de l'indicateur d'appel



Cette fonction permet aux utilisateurs radio de configurer un appel ou un message texte sonneries.



Activer ou désactiver les sonneries d'appel des avertissements d'appel



Vous pouvez sélectionner, activer ou désactiver les sonneries des avertissements d'appel que vous recevez.



- 1 Appuyez sur  pour accéder au menu.

- 2 Appuyez sur  ou  Utilitaires, puis sur  pour sélectionner.



- 3 Appuyez sur  ou  Paramètres radio, puis sur  pour sélectionner.

- 4 Appuyez sur  ou  Tntés/Avert., puis sur  pour sélectionner.

- 5 Appuyez sur  ou  jusqu'à Sonn. d'appels, puis sur  pour sélectionner.

- 6 Appuyez sur  ou  jusqu'à Avert. d'appel, puis sur  pour sélectionner.













La tonalité sélectionnée est indiquée par l'icône ✓.



- 7 Appuyez sur  ou  jusqu'à la tonalité voulue, puis sur  pour sélectionner.



✓ L'icône s'affiche à côté de la tonalité sélectionnée.

Activer et désactiver les sonneries d'appel des appels individuels

Vous pouvez activer ou désactiver les sonneries des appels individuels que vous recevez.

- 1 Appuyez sur  pour accéder au menu.
- 2 Appuyez sur  ou  Utilitaires, puis sur  pour sélectionner.
- 3 Appuyez sur  ou  Paramètres radio, puis sur  pour sélectionner.
- 4 Appuyez sur  ou  Tonalités/alertes, puis sur  pour sélectionner.
- 5 Appuyez sur  ou  jusqu'à Sonn. d'appels, puis sur  pour sélectionner.

















- 6 Appuyez sur  ou  jusqu'à Appel individuel, puis sur  pour sélectionner.





- 7 Appuyez sur  pour activer ou désactiver les sonneries d'appel individuel.
Si les sonneries d'appel individuel sont activées, l'écran affiche  à côté du message Activé.
Le symbole  n'est pas affiché lorsque les tonalités d'appel individuel sont désactivées.

Activer et désactiver les sonneries d'appel des messages texte

Vous pouvez activer ou désactiver les sonneries d'appel des messages texte que vous recevez.

- 1 Appuyez sur  pour accéder au menu.

- 2 Appuyez sur  ou  Utilitaires, puis sur  pour sélectionner.
-
- 3 Appuyez sur  ou  Paramètres radio, puis sur  pour sélectionner.
-
- 4 Appuyez sur  ou  Tonalités/alertes, puis sur  pour sélectionner.
-
- 5 Appuyez sur  ou  jusqu'à Sonn. d'appels, puis sur  pour sélectionner.
-
- 6 Appuyez sur  ou  jusqu'à Message texte, puis sur  pour sélectionner. La tonalité sélectionnée est indiquée par l'icône .
-

- 7 Appuyez sur  ou  jusqu'à la tonalité voulue, puis sur  pour sélectionner.
-  L'icône s'affiche à côté de la tonalité sélectionnée.
-

Sélection d'un type de sonnerie d'avertissement



AVIS:

La touche programmée **Type de sonnerie d'avertissement** est attribuée par votre détaillant ou administrateur de système. Vérifiez auprès du détaillant ou de votre administrateur de système pour savoir de quelle façon votre radio a été programmée.

Vous pouvez programmer une alerte par vibration unique prédéterminée pour les appels radio. Si l'état Toutes Tonalités est désactivé, la radio affiche l'icône Toutes Tonalités désactivées. Si l'état Toutes les tonalités est activé, le type de sonnerie d'alerte est affiché.

La radio vibre une fois s'il s'agit d'un style de sonnerie momentané. La radio vibre de façon répétitive s'il s'agit

d'un style de sonnerie répétitif. Lorsque l'option Sonnerie et vibration est sélectionnée, la radio émet une sonnerie particulière lors d'une communication radio entrante (p. ex. alerte d'appel ou message). Elle ressemble à une tonalité d'indication positive ou à un appel manqué.

Augmenter le volume de la tonalité d'alarme

Vous pouvez programmer la radio pour qu'elle émette une alarme continue lorsqu'un appel radio reste sans réponse. Le volume de la tonalité d'alarme augmente alors graduellement. Cette fonction porte le nom d'avertissement croissant.

Journal des appels

Votre radio fait le suivi des appels individuels que vous avez faits, que vous avez reçus et que vous avez manqués récemment. Utilisez le journal des appels pour afficher et gérer les derniers appels.

Dans chacune des listes d'appels, vous pouvez exécuter les tâches suivantes :



- Suppression



- Afficher les détails
- Magasin



Affichage des derniers appels

Les listes offertes sont : Manqués, Répondus et Sortants.

1 Appuyez sur  pour accéder au menu.



2 Appuyez sur  ou  jusqu'à Journal d'appels, puis sur appuyez sur  pour sélectionner.



3 Appuyez sur  ou  jusqu'à la liste voulue, puis sur appuyez sur  pour sélectionner.
L'écran affiche l'entrée la plus récente au sommet de la liste.



4 Appuyez sur  ou  pour voir la liste.
Appuyez sur le bouton **PTT** pour passer un appel individuel à l'alias ou l'ID sélectionné.



Supprimer un appel d'une liste d'appels





- 1 Appuyez sur  pour accéder au menu.

- 2 Appuyez sur  ou  jusqu'à Journal d'appels, puis sur appuyez sur  pour sélectionner.

- 3 Appuyez sur  ou  jusqu'à la liste voulue, puis sur appuyez sur  pour sélectionner.
Lorsque vous sélectionnez une liste et qu'elle ne contient aucune entrée, l'écran affiche Liste vide, , et une tonalité grave se fait entendre si les tonalités du clavier sont activées.



- 4 Appuyez sur  ou  jusqu'à l'alias ou l'ID requis, puis sur appuyez sur  pour sélectionner.



- 5 Appuyez sur  ou  jusqu'à Supprimer, puis sur appuyez sur  pour sélectionner.

- 6 Faites un des suivants :
 - Appuyez sur  pour sélectionner Oui et supprimer l'entrée. L'écran affiche Entrée supprimée.
 - Appuyez sur  ou  jusqu'à Non, puis appuyez sur appuyez sur la touche  pour retourner à la fenêtre précédente.



Afficher les détails d'une liste d'appels

- 1 Appuyez sur  pour accéder au menu.

- 2 Appuyez sur  ou  jusqu'à Journal d'appels, puis sur appuyez sur  pour sélectionner.

3 Appuyez sur  ou  jusqu'à la liste voulue, puis sur appuyez sur  pour sélectionner.

4 Appuyez sur  ou  jusqu'à l'alias ou l'ID requis, puis sur appuyez sur  pour sélectionner.

5 Appuyez sur  ou  pour afficher les détails, puis sur appuyez sur  pour sélectionner.

L'écran affiche les détails de la liste d'appel.

Fonction Avertissement d'appel

L'envoi d'un avertissement d'appel vous permet de faire savoir à un utilisateur de radio particulier que vous souhaitez qu'il vous rappelle lorsqu'il lui sera possible de le faire.

Cette fonction est accessible à partir du menu en allant sur Contacts, numérotation manuelle ou ou par la touche programmée **d'accès direct**.

Réponse à un avertissement d'appel

Suivez la procédure suivante pour répondre à un avertissement d'appel sur votre radio.

Lorsque vous recevez un avertissement d'appel :

- Une tonalité répétitive se fait entendre.
- Le voyant DEL jaune clignote.
- L'écran affiche la liste des notifications d'avertissement d'appel accompagnée de l'alias ou de l'ID de la radio de l'appelant.



Selon la configuration par votre détaillant ou administrateur de système, vous pouvez répondre à un avertissement d'appel en procédant de l'une des manières suivantes :



- Appuyez sur le bouton **PTT** et répondez par un appel individuel directement à l'appelant.
 - Appuyez sur le bouton **PTT** pour continuer la communication de groupe d'appels normale. L'avertissement d'appel est déplacé vers l'option Appel manqué dans le menu du Journal d'appels. Vous pouvez répondre à l'appelant à partir du journal Appel manqué.
-





Pour plus d'informations à ce sujet, reportez-vous à [Liste de notifications à la page 204](#) et à [Fonctions du Journal des appels à la page 138](#).



Envoyer un avertissement d'appel à partir de la liste des contacts

- 1 Appuyez sur  pour accéder au menu.

- 2 Appuyez sur  ou  Contacts, puis sur  pour sélectionner.

- 3 Suivez une des étapes ci-dessous pour sélectionner l'alias ou l'ID de l'abonné voulu :
 - sélectionner l'alias d'abonné directement
 - Appuyez sur  ou  jusqu'à l'alias d'abonné requis, puis sur  pour sélectionner.
 - utiliser le menu Num. manuelle

- Appuyez sur  ou  jusqu'à Numérotation manuelle, puis sur  pour sélectionner.
- L'écran de saisie de texte de numérotation manuelle doit être affiché. Entrez l'ID d'abonné, puis appuyez sur  .

- 4 Appuyez sur  ou  jusqu'à Avert. d'appel, puis sur  pour sélectionner.

L'écran affiche Avert. d'appel : <alias ou ID d'abonné>Avert. d'appel et l'alias ou l'ID d'abonné, indiquant que l'avertissement d'appel a été envoyé.

Le voyant DEL passe au vert continu pendant l'envoi de l'avertissement d'appel.

Si la radio reçoit l'accusé de réception de l'avertissement d'appel, l'écran affiche Avert. appel réussi.

Sinon, l'écran affiche Avert. appel échoué.

Envoyer un avertissement d'appel au moyen de la touche d'accès direct

Appuyez sur la touche programmée **Accès direct** pour envoyer un avertissement d'appel à l'ID prédéfini.

L'écran affiche Avert. d'appel ainsi que l'alias ou l'ID de l'abonné pour vous aviser que l'avertissement a été envoyé.

Le voyant DEL passe au vert continu pendant l'envoi de l'avertissement d'appel.

Si la confirmation d'avertissement d'appel est reçue, l'écran indique Avert. d'appel réussi.

Si la confirmation de l'avis d'appel n'est pas reçue, l'écran indique Avert. d'appel échoué.

Mode Muet

Le mode muet propose une option à l'utilisateur de couper tous les indicateurs audio de la radio.

Une fois le mode muet activé, tous les indicateurs sonores sont désactivés à l'exception des fonctions de priorité élevée, comme les opérations d'urgence.

Lorsque l'on quitte le mode muet, la radio reprend la lecture des tonalités et de transmissions audio.



AVIS:

Ceci est une fonction pouvant être achetée. Pour obtenir des renseignements supplémentaires, adressez-vous à votre détaillant ou à votre administrateur de système.

Activation du mode muet

Suivez la procédure suivante pour activer le mode muet.

Accédez à cette fonction à partir de la touche programmée **Mode muet**.

Les éléments suivants se produisent lorsque le mode muet est activé :

- Une tonalité de réussite se fait entendre.
- L'écran affiche Mode muet activé.
- Le voyant rouge clignote et continue de clignoter jusqu'à ce que l'on quitte le mode muet.
- L'écran affiche le **Mode muet** sur l'écran d'accueil.
- La radio est en sourdine.



- La minuterie de mode muet commence pour toute la durée configurée.



Réglage de la minuterie du mode muet



La fonction Mode muet peut être activée pour une durée prédéterminée en réglant la minuterie du mode muet. La durée de la minuterie est configurée dans le menu de la radio et peut être comprise entre 0,5 et 6 heures. Le mode muet est quitté lorsque la minuterie expire.



Si la minuterie est laissée à 0, la radio reste en mode muet pendant une période indéfinie jusqu'à ce que l'on appuie sur la touche programmée **Mode muet**.

- 1 Appuyez sur  pour accéder au menu.

- 2 Appuyez sur  ou  jusqu'à Utilitaires.
Appuyez sur  pour effectuer la sélection.

- 3 Appuyez sur  ou  jusqu'au Paramètres de la radio. Appuyez sur  pour effectuer la sélection.

- 4 Appuyez sur  ou  jusqu'à Mode muet.
Appuyez sur  pour effectuer la sélection.

- 5 Appuyez sur  ou  pour modifier la valeur numérique de chaque chiffre, puis appuyez sur .

Quitter le mode muet

Cette fonction peut être quittée automatiquement une fois l'expiration de la minuterie de mode muet.

Effectuez l'une des opérations suivantes pour quitter le mode muet manuellement :

- Appuyez sur la touche programmée **Mode muet**.
 - Appuyez sur le bouton **PTT** pour n'importe quelle entrée.
-

Les éléments suivants se produisent lorsque le mode muet est désactivé :

- Une tonalité d'échec se fait entendre.
- L'écran affiche Mode muet désactivé.

- Le voyant DEL rouge clignotant s'éteint.
- L'icône **Mode muet** disparaît de l'écran d'accueil.
- Votre radio désactive le mode muet et l'état du haut-parleur est rétabli.
- Si la minuterie n'est pas expirée, cette dernière est arrêtée.



AVIS:

Mode muet est également abandonné si l'utilisateur transmet par la voix ou passa à un canal non programmé.

Fonctionnement d'urgence



AVIS:

Si votre radio est programmée pour l'activation du mode d'urgence « Silencieux » ou « Silencieux avec voix », elle quitte automatiquement le mode silencieux dans la plupart des cas après la fin de l'appel d'urgence ou de l'alerte d'urgence.

L'exception à cette règle est le cas où « Alerte d'urgence » est le mode d'urgence configuré et « Silencieux » est le type d'urgence configuré. Si votre radio est programmée de cette manière, le mode silencieux est maintenu jusqu'à ce que vous l'annuliez en appuyant sur le bouton **PTT** ou sur le bouton configuré pour « Urgence désactivée ».

Ni les appels vocaux d'urgence ni les alertes d'urgence ne sont pris en charge en mode de secours automatique Connect Plus. Pour de plus amples renseignements, voir [Plan de secours automatique à la page 269](#).

Une alerte d'urgence est employée pour signaler une situation critique. Vous pouvez signaler une urgence en tout temps, à partir de n'importe quel écran, même si de l'activité se déroule sur le canal actuel. Le mode d'urgence programmé se déclenche lorsque vous appuyez sur le bouton **Urgence**. Le mode d'urgence programmé peut

aussi être déclenché en activant la fonction de situation de détresse en option. La fonction d'urgence peut être désactivée sur votre radio.

Votre détaillant peut définir la durée d'appui sur la touche **Urgence** programmée, sauf la durée d'appui prolongé, qui est semblable à celui de tous les autres boutons.

Appui bref

De 0,05 à 0,75 seconde.

Appui long

De 1,00 à 3,75 secondes.

La fonction Urgence act./dés. est attribuée à la touche **Urgence**. Vérifiez auprès de votre détaillant le fonctionnement de la touche **Urgence**.

- Si l'appui bref sur la touche **Urgence** permet d'activer le mode d'urgence, alors l'appui prolongé sur la touche **Urgence** permet de quitter le mode d'urgence.
- Si l'appui prolongé sur la touche **Urgence** permet d'activer le mode d'urgence, alors l'appui bref sur la touche **Urgence** permet de quitter le mode d'urgence.

Lorsqu'une zone Connect Plus est sélectionnée, votre radio prend en charge trois modes d'urgence :

Appel d'urgence

Vous devez appuyer sur le bouton **PTT** pour parler dans le créneau temporel d'urgence attribué.

Appel d'urgence suivi d'un appel vocal

Lors de la première transmission dans le créneau temporel d'urgence attribué, la sourdine du microphone est désactivée et vous pouvez parler sans avoir à appuyer sur le bouton **PTT**. De cette façon, le microphone est « branché » pendant la durée programmée dans la radio. Pour les transmissions subséquentes du même appel d'urgence, vous devez appuyer sur le bouton **PTT**.

Alerte d'urgence

Une alerte d'urgence n'est pas un appel vocal. Il s'agit d'une notification d'urgence qui est envoyée aux radios configurées pour recevoir de type d'alerte. La radio envoie une alerte d'urgence par le canal de contrôle du site actuellement enregistré. L'alerte d'urgence est reçue par les radios du réseau Connect Plus qui sont programmées pour les recevoir (quel que soit le site réseau auprès duquel elles sont enregistrées).

Seul un des modes d'urgence peut être affecté au bouton Urgence pour chaque zone. De plus, chaque mode d'urgence comprend les types suivants :

Régulier

La radio émet une alarme et active des indicateurs sonores et/ou visuels.

Silencieux

La radio lance une urgence sans indication sonore ou visuelle. La radio coupe toutes les indications sonores ou visuelles relatives à l'urgence jusqu'à ce que vous appuyiez sur le bouton **PTT** pour amorcer une transmission vocale.

Silencieux avec voix

Identique au mode Silencieux, sauf que la sourdine de la radio se désactive également pour certaines transmissions vocales.

Recevoir un appel d'urgence entrant

Votre radio peut être programmée pour émettre une tonalité d'alerte et afficher de l'information au sujet de l'avis d'urgence entrant. Si la radio est programmée de cette façon, à la réception de l'avertissement d'urgence entrant, l'écran affiche les détails de l'urgence avec l'icône d'urgence, l'alias ou de l'ID de la radio qui a fait la demande d'urgence, le contact du groupe utilisé pour l'urgence et une ligne additionnelle d'information. L'information supplémentaire est le nom de la zone qui contient le contact de groupe.

Pour le moment, la radio n'affiche que la plus récente urgence à avoir été décodée. Si une nouvelle urgence est reçue avant que l'urgence précédente soit effacée, les détails de la nouvelle urgence remplacent ceux de l'urgence précédente.



Selon la façon dont votre radio a été programmée, l'écran des détails de l'urgence (ou de la liste des alarmes) reste affiché même après la fin de l'urgence. Vous pouvez enregistrer les détails de l'urgence dans la liste des alarmes ou les supprimer de la façon décrite dans les sections suivantes :

Enregistrement des détails de l'urgence dans la liste des alarmes

L'enregistrement des détails de l'urgence dans la liste des alarmes permet d'afficher les détails plus tard en sélectionnant la liste des alarmes dans le menu principal.

- 1 Pendant que l'écran des détails de l'urgence (ou la liste des alarmes) est affiché, appuyez sur  . L'écran **Quitter la liste des alarmes** s'affiche.



-
- 2 Effectuez l'une des actions suivantes :

- Sélectionnez **Oui**, puis appuyez sur  pour enregistrer les détails de l'urgence dans la liste des alarmes et pour quitter l'écran des détails de l'urgence (ou la liste des alarmes).
- Sélectionnez **Non**, puis appuyez sur  pour revenir à l'écran des détails de l'urgence (ou à la liste des alarmes).

Supprimer les détails de l'urgence

- 1 Pendant que l'écran des détails de l'urgence est affiché, appuyez sur  .

L'écran **Supprimer** s'affiche.

- 2 Effectuez l'une des actions suivantes :
 - Sélectionnez **Oui**, puis appuyez sur  pour supprimer les détails de l'urgence.
 - Sélectionnez **Non**, puis appuyez sur  pour revenir à l'écran des détails de l'urgence.

Réponse à un appel d'urgence



AVIS:

Si vous ne répondez pas à l'appel d'urgence dans le délai de réponse prévu, l'appel d'urgence prend fin. Si vous désirez parler au groupe après l'expiration du délai d'appel d'urgence, vous devez d'abord sélectionner la position du canal attribuée au groupe (si elle n'est pas déjà sélectionnée). Appuyez ensuite sur le bouton **PTT** pour effectuer un appel non urgent au groupe.

- 1 Lors de la réception d'un appel d'urgence, appuyez sur n'importe quelle touche pour interrompre toutes les indications de réception d'appel d'urgence.
- 2 Appuyez sur le bouton **PTT** pour diffuser une transmission vocale dans le groupe d'urgence. Toutes les radios qui écoutent ce groupe entendront votre transmission.
- 3 Attendez la fin de la tonalité d'autorisation de parler (si elle est activée) et parlez clairement dans le microphone.
Le voyant DEL s'allume en vert.

- 4 Relâchez le bouton **PTT** pour écouter.

Lorsque la radio émettrice de l'appel d'urgence répond, le voyant DEL clignote en vert. L'icône d'appel de groupe, l'ID du groupe ainsi que l'ID de la radio émettrice s'affichent à l'écran.

Répondre à une alerte d'urgence



AVIS:

Le contact du groupe utilisé pour l'alerte d'urgence ne doit pas être utilisé pour les communications vocales. Cela aurait pour effet d'empêcher d'autres radios d'envoyer et de recevoir des alertes d'urgence dans ce groupe.

Une alerte d'urgence provenant d'une radio indique que l'utilisateur se trouve dans une situation d'urgence. Vous pouvez réagir à l'alerte en faisant un Appel individuel à la radio qui a déclaré l'urgence, en faisant un appel de groupe au groupe d'appel désigné, en envoyant une alerte d'appel à la radio, en amorçant la surveillance à distance de radio, etc. La réponse appropriée est déterminée par votre organisation et par la situation particulière.

Ignorer Appel d'annulation d'urgence

Cette amélioration de fonctionnalité sert à fournir une option pour la radio d'ignorer un appel d'annulation d'urgence.

Pour activer la fonction Ignorer Appel d'annulation d'urgence, la radio doit être configurée avec le CPCPS.

Lorsque la fonction est activée, la radio n'affiche pas les indications d'appel d'urgence et elle ne reçoit pas le signal audio de l'ID de groupe d'annulation d'urgence par défaut.

Pour obtenir des renseignements supplémentaires, adressez-vous à votre détaillant ou à votre administrateur de système.

Initiation d'un appel d'urgence



AVIS:

Si votre radio est réglée à Silencieux, elle ne fournit aucune indication sonore ou visuelle durant l'urgence jusqu'à ce que vous appuyiez sur le bouton **PTT** pour amorcer une transmission vocale. Si votre radio est réglée à Silencieux avec voix, elle ne fournit aucune indication sonore ou visuelle de mode d'urgence. Cependant, votre radio débloque le son pour les transmissions des radios qui répondent à votre urgence. Les indicateurs d'urgence ne se manifestent que lorsque vous appuyez sur le bouton **PTT** pour amorcer une transmission vocale.

Tant en mode « Silencieux » que « Silencieux avec voix », la radio quitte automatiquement le mode silencieux après la fin de l'appel d'urgence.

1 Appuyez sur la touche programmée **Urgence**.

2 Appuyez sur le bouton **PTT** pour diffuser une transmission vocale dans le groupe d'urgence.

Lorsque vous relâchez le bouton **PTT**, l'appel d'urgence se poursuit pendant la période allouée comme délai d'appel d'urgence.

Si vous appuyez sur le bouton **PTT** pendant ce temps, l'appel d'urgence se poursuit.

Lancement d'un appel d'urgence suivi d'un appel vocal

Votre radio doit être programmée pour ce mode.

Dans ce mode, lorsque vous appuyez sur le bouton programmé **Urgence** et que votre radio reçoit un créneau temporel, le microphone est automatiquement activé sans que vous ayez à appuyer sur le bouton **PTT**. Cet état de microphone activé est aussi appelé « microphone branché ». Le « microphone branché » s'applique à la première transmission vocale de votre radio durant l'appel d'urgence. Pour les transmissions subséquentes du même appel d'urgence, vous devez appuyer sur le bouton **PTT**.

1 Appuyez sur la touche programmée **Urgence**.

2 Le microphone reste actif pendant la durée de « microphone branché » précisée dans la programmation de la codeplug radio.

Pendant ce temps, le voyant DEL s'allume en vert.

- Maintenez le bouton **PTT** enfoncé pour parler plus longtemps que la durée programmée.

Lancement d'une alerte d'urgence



AVIS:

Si votre radio est programmée pour « Silencieux » ou « Silencieux avec voix », elle ne fournit aucune indication sonore ou visuelle qu'elle est en train d'envoyer une alerte d'urgence. Si elle est programmée pour « Silencieux », le mode silencieux est maintenu indéfiniment jusqu'à ce que vous appuyiez sur le bouton PTT ou sur le bouton configuré pour « Urg. Dés. ». Si elle est programmée pour « Silencieux avec voix », la radio annule automatiquement le mode silencieux lorsque le contrôleur de site diffuse l'alerte d'urgence.

Appuyez sur le bouton **Urgence** orange.

Une fois l'alerte d'urgence transmise au contrôleur de site, l'écran de la radio affiche l'icône d'urgence,

le contact du groupe utilisé pour l'alerte d'urgence l'alarme TX.

Une fois que l'alerte d'urgence est envoyée avec succès et qu'elle est diffusée à l'intention des autres radios, une tonalité de réussite retentit et l'écran de la radio affiche **Alerte envoyée**. Si l'alerte d'urgence est sans succès, une tonalité d'échec se fait entendre et la radio affiche **Échec alerte**.

Quitter le mode d'urgence



AVIS:

Si l'appel d'urgence prend fin en raison de l'expiration du délai d'appel d'urgence alors que la situation d'urgence existe toujours, appuyez de nouveau sur le bouton **Urgence** pour redémarrer le processus.

Si vous lancez une alerte d'urgence en appuyant sur le bouton programmé **Urgence**, la radio quitte automatiquement le mode d'urgence après avoir reçu une réponse du système Connect Plus.

Si vous lancez un appel d'urgence en appuyant sur le bouton programmé **Urgence**, votre radio est automatiquement associée à un canal dès qu'il y en a un

de disponible. Une fois que votre radio a transmis un message pour signaler une urgence, vous ne pouvez pas annuler votre appel d'urgence. Cependant, si vous avez appuyé par accident sur le bouton ou si l'urgence n'existe plus, vous pourriez vouloir le dire sur le canal associé. Lorsque vous relâchez le bouton **PTT**, l'appel d'urgence est coupé après l'expiration du délai d'appel d'urgence.

Si votre radio est configurée pour la fonction Urgence suivi d'un appel vocal, utilisez la période de « micro ouvert » pour expliquer votre erreur, puis appuyez brièvement sur le bouton **PTT** pour mettre fin à la transmission. L'appel d'urgence est coupé après l'expiration du délai d'appel d'urgence.

Messagerie texte

Votre radio peut recevoir des données, par exemple un message texte, en provenance d'une autre radio ou d'une application de messagerie texte.

Il existe deux types de messages texte : court message texte et message texte de radio mobile numérique (DMR). La longueur maximale d'un message texte court DMR est de 23 caractères. En mode transmission, un message texte peut comporter un maximum de 280 caractères, ce qui inclut la ligne d'objet. Vous voyez la ligne d'objet lorsque

vous recevez un message provenant d'une application courriel.



AVIS:







La longueur maximale de 280 caractères s'applique uniquement pour les modèles avec la dernière version du logiciel et du matériel. Pour les modèles de radio avec les anciens logiciels et matériels, la longueur maximale d'un message texte est de 140 caractères. Pour obtenir des renseignements supplémentaires, adressez-vous à votre détaillant ou à votre administrateur de système.

Envoyer un message texte rapide

Votre radio prend en charge un maximum de 10 messages texte rapides, selon la programmation effectuée par votre détaillant.

Les messages texte rapides sont prédéfinis, mais vous pouvez modifier chaque message avant de l'envoyer.

Si vous envoyez le message, effectuez les opérations suivantes pour sélectionner un destinataire :

- Appuyez sur  ou  jusqu'à la Alias voulu, puis sur appuyez sur  pour sélectionner.
- Appuyez sur  ou  jusqu'à Numérotation manuelle, puis sur appuyez sur  pour sélectionner. La première ligne de l'écran affiche le message Numéro :. La deuxième ligne de l'écran affiche un curseur clignotant. Entrez l'alias ou l'ID d'abonné, puis appuyez sur  .

L'écran affiche *Envoi de message*, confirmant que votre message est en cours d'envoi.

Si le message est envoyé, une tonalité retentit et l'écran affiche *Message envoyé*.

Si le message n'a pas pu être envoyé, une tonalité grave se fait entendre et l'écran affiche *Échec de l'envoi du message*.

En cas d'échec de l'envoi du message texte, l'écran d'option *Renvoyer* s'affiche (consultez la section

[Gérer les échecs d'envoi de message texte à la page 308](#)).

Envoyer un message texte rapide au moyen de la touche d'accès direct

Vous pouvez envoyer des messages texte rapides en utilisant le bouton programmable programmé par votre détaillant.

Appuyez sur la touche programmée d'**accès direct** pour envoyer un message texte rapide prédéfini à un ID prédéfini.

L'écran affiche *Envoi de message*, confirmant que votre message est en cours d'envoi.

Si le message est envoyé, une tonalité retentit et l'écran affiche *Message envoyé*.

Si le message n'a pas pu être envoyé, une tonalité grave se fait entendre et l'écran affiche *Échec de l'envoi du message*.

En cas d'échec de l'envoi du message texte, l'écran d'option **Renvoyer** s'affiche (consultez la section [Gérer les échecs d'envoi de message texte à la page 308](#)).

Accès au dossier Brouillons

Le dossier Brouillons permet de stocker au maximum les dix (10) derniers messages enregistrés. Une fois le dossier plein, le prochain message enregistré remplace automatiquement le plus ancien message enregistré dans le dossier.













AVIS:

Vous pouvez modifier un message texte enregistré avant de l'envoyer. Cette fonction ne peut être utilisée qu'avec un microphone à clavier (consultez la section [Modifier et envoyer un message texte enregistré à la page 306](#)). Vous pouvez revenir à l'écran d'accueil à tout moment en maintenant la touche  enfoncée.

Afficher un message texte enregistré



- 1 Accédez à la fonction **Message texte**.

Commandes de la radio	Étapes à suivre
Touche programmée Message texte	Appuyez sur la touche programmée Message texte .
Menu	<p>a Appuyez sur  pour accéder au menu.</p> <p>b Appuyez sur  ou  Messages, puis sur  pour sélectionner.</p>





- 2 Appuyez sur  ou  jusqu'aux Brouillons, puis sur appuyez sur  pour sélectionner.
- 3 Appuyez sur  ou  jusqu'au message voulu, puis sur appuyez sur  pour sélectionner.

Modifier et envoyer un message texte enregistré

1 Pendant que vous visualisez le message, appuyez sur  .

2 Appuyez sur  ou  jusqu'à Modifier, puis sur appuyez sur  pour sélectionner.
Un curseur clignotant apparaît.







3 Utilisez le clavier pour taper votre message.

Appuyez sur  pour déplacer le curseur d'une espace vers la gauche. Appuyez sur  ou sur la touche  pour déplacer le curseur d'une espace vers la droite. Appuyez sur la touche  pour supprimer les caractères inutiles. Appuyez longuement sur  pour modifier le mode de saisie de texte.

4 Une fois votre message composé, appuyez sur



5 Sélectionnez le destinataire du message en faisant ce qui suit :

- Appuyez sur  ou  jusqu'à la Alias voulu, puis sur appuyez sur  pour sélectionner.
- Appuyez sur  ou  jusqu'à Numérotation manuelle, puis sur appuyez sur  pour sélectionner. La première ligne de l'écran affiche le message Numéro :. La deuxième ligne de l'écran affiche un curseur clignotant. Entrez l'alias ou l'ID d'abonné, puis appuyez sur  .

L'écran affiche Envoi de message, confirmant que votre message est en cours d'envoi.

Si le message est envoyé, une tonalité retentit et l'écran affiche Message envoyé.



Si le message n'a pas pu être envoyé, une tonalité grave se fait entendre et l'écran affiche Échec de l'envoi du message.









Si le message texte ne peut pas être envoyé, il est déplacé dans le dossier des éléments envoyés et marqué d'une icône d'échec d'envoi.

Supprimer un message texte enregistré dans les brouillons

- 1 Accédez à la fonction **Message texte**.

Commandes de la radio	Étapes à suivre
Touche programmée Message texte	Appuyez sur la touche programmée Message texte .
Menu	a Appuyez sur  pour accéder au menu.

Commandes de la radio	Étapes à suivre
	b Appuyez sur  ou  Messages, puis sur appuyez sur  pour sélectionner.

- 2 Appuyez sur  ou  jusqu'aux Brouillons, puis sur appuyez sur  pour sélectionner.
- 3 Appuyez sur  ou  jusqu'au message voulu, puis sur appuyez sur  pour sélectionner.
- 4 Appuyer sur  ou  jusqu'à Supprimer, puis appuyez sur  pour supprimer le message texte.

Gérer les échecs d'envoi de message texte

Vous pouvez sélectionner l'une des options suivantes dans l'écran Renvoyer :

- Renvoyer
- Suivante
- Modifier

Renvoyer un message texte



Appuyez sur  pour renvoyer le même message au même alias ou ID d'abonné ou de groupe.



Si le message a bien été envoyé, une tonalité Se fait entendre et l'écran affiche un bref avis de réussite.

Si le message ne peut pas être envoyé, l'écran affiche un bref avis d'échec.

Transférer un message texte

Sélectionnez Transférer pour envoyer le message à un autre alias ou ID d'abonné ou de groupe.

1 Appuyez sur  ou  jusqu'à Transférer, puis sur appuyez sur  pour sélectionner.

2 Pour sélectionner le destinataire du message, appuyez sur  ou  l'alias ou l'ID requis, puis sur appuyez sur  pour sélectionner.

L'écran affiche Envoi de message, confirmant que votre message est en cours d'envoi.

Si le message est envoyé, une tonalité retentit et l'écran affiche Message envoyé.

Si le message n'a pas pu être envoyé, une tonalité grave se fait entendre et l'écran affiche Échec de l'envoi du message.

Gestion de messages texte envoyés

Une fois qu'un message texte est envoyé vers une autre radio, il est enregistré dans les messages envoyés. Le dernier message texte envoyé s'affiche toujours en haut de la liste des messages envoyés.

Le dossier des messages envoyés peut contenir au maximum les 30 derniers messages envoyés. Une fois le dossier plein, le prochain message envoyé remplace automatiquement le plus ancien message enregistré dans le dossier.







AVIS:







Vous pouvez revenir à l'écran d'accueil à tout moment en maintenant la touche  enfoncée.

Affichage d'un message texte envoyé

- 1 Accédez à la fonction **Message texte**.

Comman des de la radio	Étapes à suivre
Touche program	Appuyez sur la touche programmée Message texte .

Comman des de la radio	Étapes à suivre
mée Message texte	
Menu	<p>a Appuyez sur  pour accéder au menu.</p> <p>b Appuyez sur  ou  Messages, puis sur appuyez sur  pour sélectionner.</p>

- 2 Appuyez sur  ou  jusqu'à **Éléments envoyés**, puis sur appuyez sur  pour sélectionner.
- 3 Appuyez sur  ou  jusqu'au message requis, puis sur appuyez sur  pour sélectionner.



L'icône affichée dans le coin supérieur droit de l'écran indique l'état du message (consultez la section [Icônes de messages envoyés à la page 248](#)).

Envoi d'un message texte envoyé

Vous pouvez sélectionner l'une des options suivantes lorsque vous consultez un message texte envoyé :

- Renvoyer
- Suivante
- Modifier
- Suppression

1 Pendant que vous visualisez le message, appuyez sur  .

2  ou  jusqu'à l'une des options suivantes et appuyez sur  pour sélectionner.

Option	Étapes à suivre
Suivant e	Sélectionnez Transférer pour envoyer le message texte sélectionné à un autre alias ou ID d'abonné ou de groupe (voir Transférer un message texte à la page 308).
Suppression	Sélectionnez Supprimer pour supprimer le message texte.
Renvoyer r	Sélectionnez Renvoyer pour envoyer à nouveau le message texte sélectionné au même alias ou ID d'abonné/de groupe. L'écran affiche Envoi de Message , indiquant que le même message est envoyé à la même radio cible. Si le message est envoyé, une tonalité retentit et l'écran affiche Message envoyé . Si le message n'a pas pu être envoyé, une tonalité grave se fait entendre et l'écran affiche Échec de l'envoi du message .

Option	Étapes à suivre
	<p>Lorsque l'envoi d'un message texte échoue, l'écran d'option Renvoyer s'affiche de nouveau. Appuyez sur  pour renvoyer le message au même alias ou ID d'abonné ou de groupe.</p>





Si vous quittez l'écran d'envoi de message pendant que l'envoi du message est en cours, la radio met à jour l'état du message dans le dossier des messages envoyés sans fournir d'indication sonore ou visuelle.



Si la radio change de mode ou est mise hors tension avant que l'état du message ne soit mis à jour dans le dossier des messages envoyés, la radio ne peut terminer l'envoi du message en cours et marque automatiquement celui-ci d'une icône **Échec de l'envoi**.



La radio prend en charge un maximum de cinq envois de message en cours à la fois. Pendant ce temps, la radio ne peut envoyer aucun autre message et marque automatiquement les nouveaux messages de l'icône **Échec de l'envoi**.







Supprimer tous les messages envoyés du dossier des messages envoyés

- 1 Accédez à la fonction **Message texte**.

Commandes de la radio	Étapes à suivre
Touche programmée Message texte	Appuyez sur la touche programmée Message texte .
Menu	<p>a Appuyez sur  pour accéder au menu.</p> <p>b Appuyez sur  ou  Messages, puis sur  pour sélectionner.</p>

- 2 Appuyez sur  ou  jusqu'à **Éléments envoyés**, puis sur appuyez sur  pour sélectionner.
- Lorsque vous sélectionnez le dossier **Éléments envoyés** et qu'il ne contient aucun message texte, l'écran affiche **Liste vide** et une tonalité grave se fait entendre si les tonalités du clavier sont activées.
-

- 3 Appuyez sur  ou  jusqu'à **Supprimer tout**, puis sur appuyez sur  pour sélectionner.
-

- 4 Sélectionnez un des éléments suivants :
- Appuyez sur  ou  jusqu'à **Oui**, puis appuyez sur  pour sélectionner. L'écran affiche un bref avis de réussite.
 - Appuyez sur  ou  jusqu'à **Non** et appuyez sur  pour revenir à l'écran précédent.
-



Recevoir un message texte

Lorsque votre radio reçoit un message, l'écran affiche la liste de notifications comprenant l'alias ou l'ID de l'expéditeur et l'icône de message.

Vous pouvez sélectionner l'une des options suivantes lorsque vous recevez un message texte :

- Lecture
- Lire plus tard
- Suppression

Lire un message texte

- 1 Appuyez sur  ou  jusqu'à **Lire?**, puis sur appuyez sur  pour sélectionner.

Le message sélectionné dans la boîte de réception s'ouvre.

- 2 Faites un des suivants :

- Appuyez sur  pour revenir à la boîte de réception.

- Appuyez à nouveau sur  pour répondre au message texte, le transférer ou le supprimer.

Gérer les messages texte reçus

Utilisez la boîte de réception pour gérer vos messages texte. La boîte de réception peut contenir au maximum 30 messages.

Les messages texte de la boîte de réception sont classés du plus récent au plus ancien.

Votre radio prend en charge les options de messagerie texte suivantes :











- Répondre (par texte rapide)
- Suivante
- Suppression
- Supprimer tout



AVIS:

Si le type de canal ne correspond pas, vous pouvez uniquement transférer un message, supprimer un message ou supprimer tous les messages reçus. Vous pouvez revenir à l'écran d'accueil à tout moment en maintenant la touche  enfoncée.

Afficher un message texte à partir de la boîte de réception



- 1 Appuyez sur  pour accéder au menu.
- 2 Appuyez sur  ou  Messages, puis sur  pour sélectionner.
- 3 Appuyez sur  ou  pour aller à Boîte de réception, puis sur  pour sélectionner.
- 4 Appuyez sur  ou  pour afficher les messages.
- 5 Faites un des suivants :
 - Appuyez sur  pour sélectionner le message actuel, puis appuyez de nouveau sur  pour répondre au message, envoyer une , transférer le message ou le supprimer.







- Maintenez enfoncée la touche  pour revenir à l'écran d'accueil.

Répondre à un message texte à partir de la boîte de réception

- 1 Accédez à la fonction **Message texte**.

Comman des de la radio	Étapes à suivre
Touche programmée Message texte	Appuyez sur la touche programmée Message texte .
Menu	a Appuyez sur  pour accéder au menu.

Comman des de la radio	Étapes à suivre
	b Appuyez sur  ou  Messages, puis sur appuyez sur  pour sélectionner.

- 2 Appuyez sur  ou  pour aller à Boîte de réception, puis sur appuyez sur  pour sélectionner.
- 3 Appuyez sur  ou  jusqu'au message voulu, puis sur appuyez sur  pour sélectionner.
- 4 Appuyez de nouveau sur  pour accéder au sous-menu.
- 5 Utilisez le clavier pour composer ou modifier votre message.

- 6 Une fois votre message composé, appuyez sur



L'écran affiche *Envoi de message*, confirmant que votre message est en cours d'envoi.

Si le message est envoyé, une tonalité retentit et l'écran affiche *Message envoyé*.

Si le message n'a pas pu être envoyé, une tonalité grave se fait entendre et l'écran affiche *Echec de l'envoi du message*.

En cas d'échec de l'envoi du message, l'écran d'option *Renvoyer* s'affiche (voir [Gérer les échecs d'envoi de message texte à la page 308](#)).

Supprimer un message texte de la boîte de réception



- 1 Accédez à la fonction **Message texte**.



Commandes de la radio	Étapes à suivre
Touche programmée Message texte	Appuyez sur la touche programmée Message texte .
Menu	<p>a Appuyez sur pour accéder au menu.</p> <p>b Appuyez sur ou Messages, puis sur pour sélectionner.</p>

- 2 Appuyez sur ou pour aller à *Boîte de réception*, puis sur pour sélectionner.

- 3 Appuyez sur ou jusqu'au message voulu, puis sur pour sélectionner.

4 Appuyez de nouveau sur  pour accéder au sous-menu.





5 Appuyez sur  ou  jusqu'à Supprimer, puis sur appuyez sur  pour sélectionner.



6 Appuyez sur  ou  jusqu'à Oui, puis appuyez sur  pour Sélectionnez.

L'écran affiche Message supprimé, puis revient à la boîte de réception.

Suppression de tous les messages texte de la boîte de réception



1 Accédez à la fonction **Message texte**.

Commandes de la radio	Étapes à suivre
Touche programmée Message texte	Appuyez sur la touche programmée Message texte .
Menu	<p>a Appuyez sur  pour accéder au menu.</p> <p>b Appuyez sur  ou  Messages, puis sur  pour sélectionner.</p>

2 Appuyez sur  ou  pour aller à Boîte de réception, puis sur appuyez sur  pour sélectionner.

Lorsque vous sélectionnez la Boîte récept. ne contenant aucun message texte, l'écran indique Liste vide et une tonalité grave se fait entendre si les tonalités du clavier sont activées (consultez la

section [Activer ou désactiver les tonalités du clavier à la page 216](#)).

3 Appuyez sur  ou  jusqu'à Supprimer tout, puis sur appuyez sur  pour sélectionner.

4 Appuyez sur  ou  jusqu'à Oui, puis appuyez sur  pour sélectionnez.
L'écran affiche Boîte récept. Vidée.

Cryptage

Si elle est activée, cette fonction fait appel à une solution de brouillage logiciel pour prévenir l'écoute d'un canal par des utilisateurs non autorisés. Les parties de la transmission correspondant au signal et à l'identification de l'utilisateur ne sont pas brouillées.

La fonction de cryptage de votre radio doit être activée à la position courante du sélecteur de canal pour envoyer une transmission cryptée; l'activation de la fonction n'est cependant pas nécessaire à la réception d'une telle transmission. Lorsqu'elle est à une position de sélecteur de

canal crypté, la radio reste en mesure de recevoir des transmissions non brouillées.

Votre radio prend en charge le cryptage amélioré.

Pour décoder un appel crypté, votre radio doit être programmée de façon à utiliser les mêmes valeurs et ID de clé (pour le cryptage amélioré) que la radio émettrice.

Si votre radio reçoit un appel brouillé correspondant à des valeurs et ID de clé différentes, vous n'entendrez rien du tout (cryptage amélioré).

Si un type de cryptage a été attribué à la radio, l'icône de transmission sécurisée ou non s'affiche à l'écran d'accueil, sauf lorsque la radio envoie ou reçoit un appel ou une alarme d'urgence.

Le voyant DEL passe au vert continu pendant que la radio envoie une transmission cryptée et clignote rapidement en vert lorsque la radio reçoit une transmission cryptée.

Vous pouvez accéder à cette fonction en effectuant l'une des actions suivantes :



- Appuyez sur la touche programmée **Cryptage** pour activer ou désactiver la fonction.
- Utilisez le menu de la radio en suivant les étapes suivantes.









AVIS:

Certains modèles de radio n'offrent pas cette fonction de cryptage. Pour obtenir des renseignements supplémentaires, adressez-vous à votre détaillant ou à votre administrateur de système.

1 Appuyez sur  pour accéder au menu.

2 Appuyez sur  ou  Utilitaires, puis sur  pour sélectionner.

3 Appuyez sur  ou  jusqu'à Param. radio ou  ou  jusqu'à Connect Plus, puis sur  pour sélectionner.

4 Appuyez sur  ou  pour le cryptage amélioré.

Si l'écran affiche Allumer, appuyez sur  pour activer le cryptage. La radio affiche un message de confirmation de votre sélection.

Si l'écran affiche Éteindre, appuyez sur  pour désactiver le cryptage. La radio affiche un message de confirmation de votre sélection.

Si un type de cryptage a été attribué à la radio, l'icône de transmission sécurisée ou non s'affiche dans la barre d'état, sauf lorsque la radio envoie ou reçoit une alarme d'urgence.

Faire un appel crypté

Le cryptage peut être activé ou désactivé au moyen de la touche programmée Cryptage ou du menu. La fonction de cryptage de votre radio doit être activée pour que la position du canal actuellement sélectionné envoie des transmissions cryptées. Lorsque le cryptage est activé pour la position du canal actuellement sélectionné, toutes les transmissions vocales effectuées par votre radio sont brouillées. Cela inclut les types d'appels suivants : appel de groupe, appel multigroupe, réplique en cours d'appel balayé, appel général de site, appel d'urgence et appel individuel. Seule une radio cible dotée des mêmes valeurs et ID de clé que votre radio peut décoder la transmission.

Sécurité

Vous pouvez activer ou désactiver n'importe quelle radio du système. Par exemple, vous pourriez vouloir désactiver une radio volée pour empêcher le voleur de s'en servir, puis la réactiver une fois qu'elle est de nouveau en votre possession.









AVIS:







L'exécution des fonctions Désactiver radio et Activer radio est limitée aux radios sur lesquelles ces fonctions sont activées. Pour obtenir des renseignements supplémentaires, adressez-vous à votre détaillant ou à votre administrateur de système.

Désactiver la radio







- 1 Accédez à cette fonction en effectuant l'une des actions suivantes :

Comman des de la radio	Étapes à suivre
Touche Désac radio	<p>a Appuyez sur la touche programmée Désac radio.</p> <p>b Appuyez sur  ou  jusqu'à l'alias ou l'ID requis, puis sur appuyez sur  pour sélectionner.</p>
Menu de la radio	<p>a Appuyez sur  pour accéder au menu.</p> <p>b Appuyez sur  ou  Contacts, puis sur appuyez sur  pour sélectionner. Les entrées sont classées alphabétiquement.</p> <p>c Suivez une des étapes ci-dessous pour sélectionner l'alias ou l'ID de l'abonné voulu :</p>

Comman **Étapes à suivre**
des de la
radio

- Sélectionnez l'alias ou l'ID directement.
- Appuyez sur  ou  jusqu'à l'alias ou l'ID requis, puis sur appuyez sur  pour sélectionner.
- Utilisez le menu Numérotation manuelle.
- Appuyez sur  ou  jusqu'à Numérotation manuelle, puis sur appuyez sur  pour sélectionner.

Comman **Étapes à suivre**
des de la
radio

- Appuyez sur  ou  Numéro de radio, puis sur appuyez sur  pour sélectionner.
 - La première ligne de l'écran affiche le message Numéro radio :. La deuxième ligne de l'écran affiche un curseur clignotant. Utilisez le clavier pour entrer l'ID ou l'alias d'abonné, puis appuyez sur  .
- d** Appuyez sur  ou  Désactiver la radio, puis sur

Comman des de la radio	Étapes à suivre
	appuyez sur  pour sélectionner.

L'écran affiche Désactiver la radio : <Alias ou ID cible > et le voyant DEL clignote en vert.







2 Attendez la confirmation.





En cas de réussite, une tonalité de réussite se fait entendre et l'écran affiche le message Désact. radio réussi.





En cas d'échec, une tonalité d'échec se fait entendre et l'écran affiche le message Désact. radio échoué.



Activer la radio

- 1 Accédez à cette fonction en effectuant l'une des actions suivantes :

Commandes de la radio	Étapes à suivre
Touche Activer radio	<ol style="list-style-type: none"> a Appuyez sur la touche programmée Activer la radio. b Appuyez sur  ou  jusqu'à l'alias ou l'ID requis, puis sur appuyez sur  pour sélectionner.
Menu de la radio	<ol style="list-style-type: none"> a Appuyez sur  pour accéder au menu. b Appuyez sur  ou  Contacts, puis sur appuyez sur  pour sélectionner. Les entrées sont classées alphabétiquement. c Suivez une des étapes ci-dessous pour sélectionner

Commandes de la radio	Étapes à suivre
	<p>l'alias ou l'ID de l'abonné voulu</p> <ul style="list-style-type: none"> • Sélectionnez l'alias ou l'ID directement. • Appuyez sur  ou  jusqu'à l'alias ou l'ID requis, puis sur  pour sélectionner. • Utilisez le menu Numérotation manuelle. • Appuyez sur  ou  jusqu'à Numérotation manuelle, puis sur

Commandes de la radio	Étapes à suivre
	<p>appuyez sur  pour sélectionner.</p> <ul style="list-style-type: none"> • Appuyez sur  ou  Numéro de radio, puis sur  pour sélectionner. • La première ligne de l'écran affiche le message Numéro radio :. La deuxième ligne de l'écran affiche un curseur clignotant. Utilisez le clavier pour entrer l'ID ou l'alias d'abonné, puis appuyez sur .

Commandes de la radio	Étapes à suivre
	<p>d Appuyez sur  ou  Activer la radio, puis sur appuyez sur  pour sélectionner.</p>

L'écran affiche Activer radio : <<Alias ou l'ID d'abonné > et le voyant DEL passent au vert continu.

2 Attendez la confirmation.

En cas de réussite, une tonalité d'indication positive retentit et l'écran affiche le message Désact. radio réussi.

En cas d'échec, une tonalité d'indication négative retentit et l'écran affiche le message Désact. radio échoué.

Bluetooth



AVIS:

Si cette option est désactivée par le CPS, toutes les fonctionnalités associées à Bluetooth sont désactivées et la base de données d'appareil Bluetooth est effacée.

Cette fonctionnalité vous permet d'utiliser votre radio avec un appareil compatible Bluetooth (un accessoire) par l'intermédiaire d'une connexion sans fil Bluetooth. Votre radio prend en charge les appareils compatibles Bluetooth de marque Motorola Solutions et autres produits commerciaux prêts à l'emploi.

La connectivité Bluetooth fonctionne dans un rayon de 10 mètres (32 pi) entre deux appareils en ligne directe. C'est-à-dire un chemin sans obstruction entre votre radio et votre dispositif Bluetooth.

Il n'est pas recommandé de laisser votre radio à l'écart et vous ne devez pas vous attendre à ce que l'appareil Bluetooth offre une fiabilité élevée lorsque les deux appareils sont séparés.

À la périphérie de la zone de couverture, la qualité de la réception diminue, et la voix et la tonalité peuvent devenir brouillées ou saccadées. Pour corriger ce problème, il suffit de rapprocher votre radio et l'appareil Bluetooth à moins de



10 mètres (32 pieds) l'un de l'autre afin de rétablir la réception. La fonctionnalité Bluetooth de votre radio offre une puissance maximale de 2,5 mW (4 dBm) dans un rayon de 10 m (32 pi).

Votre radio peut prendre en charge jusqu'à quatre connexions Bluetooth simultanées avec des appareils compatibles Bluetooth de différents types. Vous pouvez par exemple connecter un casque et un dispositif PTT. Les connexions Bluetooth simultanées avec plusieurs appareils Bluetooth de même type ne sont pas prises en charge.

Pour en savoir plus sur les fonctionnalités complètes de votre appareil compatible Bluetooth, reportez-vous à son guide d'utilisation.

Activer ou désactiver Bluetooth









1 Appuyez sur  pour accéder au menu.

2 Appuyez sur  ou  jusqu'à Bluetooth, puis sur appuyez sur  pour sélectionner.

3 Appuyez sur  ou  pour afficher Mon état, puis sur appuyez sur  pour sélectionner.

L'écran affiche Activé et Arrêt. L'état actuel est indiqué par l'icône .

4 Faites un des suivants :



- Appuyez sur  ou  jusqu'à Activer, puis sur appuyez sur  pour sélectionner. L'écran affiche Activé, puis l'icône  apparaît à gauche de l'état sélectionné.
 - Appuyez sur  ou  jusqu'à Désactiver, puis sur appuyez sur  pour sélectionner. L'écran affiche Désactivé, puis l'icône  apparaît à gauche de l'état sélectionné.
-



Détecter un dispositif Bluetooth et établir la connexion

Il ne faut pas mettre le dispositif Bluetooth hors tension ni appuyer sur  pendant le processus de détection et de connexion, car cela annulerait l'opération.









1 Allumez l'appareil Bluetooth et lancez le mode d'appariement. Reportez-vous au guide d'utilisation de l'appareil Bluetooth.



2 Sur la radio, appuyez sur  pour accéder au menu.

3 Appuyez sur  ou  jusqu'à Bluetooth, puis sur appuyez sur  pour sélectionner.

4 Appuyez sur  ou  jusqu'à Appareils, puis sur appuyez sur  pour sélectionner.

5 Faites un des suivants :

- Appuyez sur  ou  jusqu'à l'appareil requis, puis sur appuyez sur  pour sélectionner.
 - Appuyez sur  ou  ou jusqu'à Recherche d'appareils pour trouver des appareils disponibles. Appuyez sur  ou  jusqu'à l'appareil requis, puis sur appuyez sur  pour sélectionner.
-

6 Appuyez sur  ou  pour se Connecter, puis sur appuyez sur  pour sélectionner. L'écran affiche le message Connexion à <nom dispositif>. Il est possible que l'appariement de votre appareil Bluetooth nécessite d'autres étapes. Reportez-vous au guide d'utilisation de l'appareil Bluetooth.

Si l'appariement réussit, la radio affiche le message <nom dispositif> connecté. Une se fait entendre et 

s'affiche à côté du dispositif connecté. L'icône Bluetooth activé s'affiche dans la barre d'état.

En cas d'échec, la radio affiche `Connexion échouée`.



Détecter un dispositif Bluetooth et établir la connexion (Mode détection)



Évitez de mettre le dispositif Bluetooth ou votre radio hors tension pendant le processus de détection et de connexion, car cela annulerait l'opération.

- 1 Activez Bluetooth.

Voir [Activer ou désactiver Bluetooth à la page 324](#).

- 2 Appuyez sur  pour accéder au menu.
-

- 3 Appuyez sur  ou  jusqu'à Bluetooth, puis sur appuyez sur  pour sélectionner.
-

- 4 Appuyez sur  ou  jusqu'à Me chercher, puis sur appuyez sur  pour sélectionner.



Votre radio peut maintenant être détectée par d'autres dispositifs Bluetooth pendant une durée programmée. Il s'agit du Mode détection.



- 5 Mettez sous tension votre dispositif Bluetooth et appariez-le à votre radio.



Reportez-vous au guide d'utilisation de l'appareil Bluetooth.



Se déconnecter d'un dispositif Bluetooth

- 1 Sur la radio, appuyez sur  pour accéder au menu.
-

- 2 Appuyez sur  ou  jusqu'à Bluetooth, puis sur appuyez sur  pour sélectionner.
-

3 Appuyez sur  ou  jusqu'à Appareils, puis sur appuyez sur  pour sélectionner.

4 Appuyez sur  ou  jusqu'à l'appareil requis, puis sur appuyez sur  pour sélectionner.

5 Appuyez sur  ou  jusqu'à Déconnecter, puis sur appuyez sur  pour sélectionner.

L'écran affiche le message <Déconnexion de l'appareil>. Il est possible que la déconnexion de votre appareil Bluetooth nécessite d'autres étapes. Reportez-vous au guide d'utilisation de l'appareil Bluetooth.

La radio affiche le message <Dispositif> déconnecté. Une tonalité de réussite se fait entendre et l'icône  cesse de s'afficher à côté du dispositif connecté. L'icône Bluetooth activé ne s'affiche plus dans la barre d'état.

Changer l'acheminement du signal audio entre le haut-parleur interne de la radio et le dispositif Bluetooth



Vous pouvez faire alterner l'acheminement du signal audio entre le haut-parleur de la radio ou par un accessoire Bluetooth externe.



Appuyez sur la touche programmée **Interrupteur audio Bluetooth**.



- Une tonalité se fait entendre et l'écran affiche le message Rout. audio vers radio.
- Une tonalité se fait entendre et l'écran affiche le message Rout. audio vers Bluetooth.



Affichage de renseignements détaillés sur les appareils

1 Appuyez sur  pour accéder au menu.

2 Appuyez sur  ou  jusqu'à Bluetooth, puis sur appuyez sur  pour sélectionner.

3 Appuyez sur  ou  jusqu'à Appareils, puis sur appuyez sur  pour sélectionner.



4 Appuyez sur  ou  jusqu'à l'appareil requis, puis sur appuyez sur  pour sélectionner.



5 Appuyez sur  ou  pour afficher les détails, puis sur appuyez sur  pour sélectionner.



Supprimer le nom d'un dispositif

Vous pouvez retirer un dispositif déconnecté de la liste des dispositifs Bluetooth.

1 Appuyez sur  pour accéder au menu.

2 Appuyez sur  ou  jusqu'à Bluetooth, puis sur appuyez sur  pour sélectionner.

3 Appuyez sur  ou  jusqu'à Appareils, puis sur appuyez sur  pour sélectionner.



4 Appuyez sur  ou  jusqu'à l'appareil requis, puis sur appuyez sur  pour sélectionner.



5 Appuyez sur  ou  jusqu'à Supprimer, puis sur appuyez sur  pour sélectionner.
L'écran affiche Dispositif supprimé.

Gain du micro Bluetooth

Permet de contrôler la valeur de gain du microphone d'un dispositif Bluetooth connecté.



1 Appuyez sur  pour accéder au menu.

2 Appuyez sur  ou  jusqu'à Bluetooth, puis sur appuyez sur  pour sélectionner.

3 Appuyez sur  ou  jusqu'à Gain mic. BT, puis sur appuyez sur  pour sélectionner.

4 Appuyez sur  ou  jusqu'au type de gain du micro Bluetooth et aux valeurs courantes.

Pour modifier les valeurs, appuyez sur  pour sélectionner.

5 Appuyez sur  ou  pour augmenter ou diminuer les valeurs, puis appuyez sur  pour sélectionner.

Localisation interne



AVIS:







La fonction Localisation interne concerne uniquement les modèles avec la dernière version du logiciel et du matériel. Pour obtenir des renseignements supplémentaires, adressez-vous à votre détaillant ou à votre administrateur de système.

Emplacement doit être utilisé pour assurer le suivi de l'emplacement des utilisateurs de radio. Lorsque cette fonction est activée, la radio est en mode Détection limitée. Des balises dédiées sont utilisées pour localiser la radio et déterminer sa position.

Activation ou désactivation de la fonction Positionnement à l'intérieur

Vous pouvez activer ou désactiver le positionnement à l'intérieur en effectuant l'une des actions suivantes.

- Accédez à cette fonction à partir du menu.
 - a. Appuyez sur  pour accéder au menu.

- b. Appuyez sur  ou  jusqu'à Bluetooth puis sur appuyez sur  pour sélectionner.
- c. Appuyez sur  ou  jusqu'à Localis. interne puis sur appuyez sur  pour sélectionner.
- d. Appuyez sur  pour activer le positionnement à l'intérieur.

L'écran affiche Localis. interne activée.

Une tonalité de réussite se fait entendre.

L'un des événements suivants se produit :

- En cas de réussite, l'icône de positionnement à l'intérieur disponible apparaît sur l'écran d'accueil.
 - En cas d'échec, l'écran affiche Échec activation. Une tonalité d'échec retentit.
- e. Appuyez sur  pour désactiver le positionnement à l'intérieur.

L'écran affiche Localis. interne désactivée.

Une tonalité de réussite se fait entendre.

L'un des événements suivants se produit :



- En cas de réussite, l'icône de positionnement à l'intérieur disponible disparaît de l'écran d'accueil.
 - En cas d'échec, l'écran affiche Échec désactivation. Une tonalité d'échec retentit.
- Accédez à cette fonction à partir de la touche programmée.
- a. Appuyez longuement sur la touche programmée **Localis. interne** pour activer cette fonction.
- L'écran affiche Localis. interne activée.
- Une tonalité de réussite se fait entendre.
- L'un des événements suivants se produit :
- En cas de réussite, l'icône de positionnement à l'intérieur disponible apparaît sur l'écran d'accueil.
 - En cas d'échec, l'écran affiche Échec activation. En cas d'échec, vous entendez une tonalité d'indication négative.

- b. Appuyez longuement sur la touche programmée **Localis. interne** pour désactiver cette fonction.



L'écran affiche **Localis. interne désactivée**.
Une tonalité de réussite se fait entendre.

L'un des événements suivants se produit :

- En cas de réussite, l'icône de positionnement à l'intérieur disponible disparaît de l'écran d'accueil.
- En cas d'échec, l'écran affiche **Échec désactivation**. En cas d'échec, vous entendez une tonalité d'indication négative.

- 2 Appuyez sur  ou  jusqu'à **Bluetooth** puis sur appuyez sur  pour sélectionner.

- 3 Appuyez sur  ou  jusqu'à **Localis. interne** puis sur appuyez sur  pour sélectionner.

- 4 Appuyez sur  ou  jusqu'à **Balises**, puis sur appuyez sur  pour sélectionner.

L'écran affiche les informations sur les balises.

Accès aux données sur l'emplacement des balises de positionnement à l'intérieur

Suivez la procédure suivante pour accéder à l'information des balises d'emplacement intérieur.

- 1 Appuyez sur  pour accéder au menu.

Liste de notifications

Votre radio comprend une liste de notifications qui rassemble tous les événements « non lus » sur le canal, par exemple les messages texte non lus, les appels manqués et les avertissements d'appel.

L'icône de notification s'affiche dans la barre d'état lorsque la liste de notifications présente au moins un événement.

La liste prend en charge au maximum quarante (40) événements non lus. Une fois la liste pleine, le prochain

événement remplace automatiquement l'événement le plus ancien.







AVIS:



Une fois les événements lus, ils sont retirés de la liste de notifications.

Accéder à la liste de notifications

Suivez la procédure pour actualiser la liste de notification.

- 1 Appuyez sur  pour accéder au menu.

- 2 Appuyez sur  ou  jusqu'à Notification, puis sur appuyez sur  pour sélectionner.

- 3 Appuyez sur  ou  jusqu'à l'événement voulu, puis sur appuyez sur  pour sélectionner.

Maintenez enfoncée la touche  pour revenir à l'écran d'accueil.

Fonctionnement Wi-Fi

Cette fonction vous permet de configurer un réseau Wi-Fi et de vous connecter à ce réseau. Le Wi-Fi prend en charge les mises à jour de micrologiciel de la radio, de la codeplug, et des ressources telles que les modules de langues et les annonces vocales.



AVIS:

Cette fonction s'applique aux modèles XPR 5550e/XPR 5580e uniquement.

Wi-Fi® est une marque déposée de Wi-Fi Alliance®.

Votre radio prend en charge les réseaux Wi-Fi d'entreprise WEP/WPA/WPA2 personnels et WPA/WPA2 d'entreprise.

Réseau Wi-Fi WEP/WPA/WPA2 personnel

Utilise l'authentification basée sur clé prépartagée (mot de passe).

La clé prépartagée peut être saisie à partir du menu ou du CPS/RM.

Réseau Wi-Fi WPA/WPA2 d'entreprise

Utilise l'authentification basée sur certificat.

Votre radio doit être préconfigurée avec un certificat.

**AVIS:**

Vérifiez auprès de votre détaillant ou de votre administrateur de système la procédure de connexion à un réseau Wi-Fi WPA/WPA2 d'entreprise.











Activer ou désactiver la fonction Wi-Fi

La touche programmée **Wi-Fi Off ou On** est attribuée par défaut. Vérifiez auprès du détaillant ou de votre administrateur de système pour savoir de quelle façon votre radio a été programmée.

Les annonces vocales pour la touche programmée **Wi-Fi On ou Off** peut être personnalisé par le CPS selon les exigences des utilisateurs. Pour obtenir des renseignements supplémentaires, adressez-vous à votre détaillant ou à votre administrateur de système.

Vous pouvez activer ou désactiver le Wi-Fi en effectuant l'une des actions suivantes.

- Appuyez sur la touche programmée **Wi-Fi activé ou désactivé**. L'annonce vocale Activation du Wi-Fi ou Désactivation du Wi-Fi se fait entendre.
- Accédez à cette fonction à partir du menu.

- Appuyez sur  pour accéder au menu.
 - Appuyez sur  ou  pour choisir le Wi-Fi, puis sur appuyez sur  pour sélectionner.
 - Appuyez sur  ou  pour choisir le Wi-Fi On, puis sur appuyez sur  pour sélectionner.
- Appuyez sur  pour activer le Wi-Fi. L'écran affiche  à côté du message **Activé**.
- Appuyez sur  pour désactiver le Wi-Fi. L'icône  ne s'affiche plus à côté du message **Activé**.

Connexion à un point d'accès réseau

Lorsque vous activez le Wi-Fi, la radio recherche un point d'accès réseau et s'y connecte.









AVIS:



Vous pouvez également vous connecter à un point d'accès réseau à partir du menu.

Les points d'accès réseau Wi-Fi WPA d'entreprise sont préconfigurés. Vérifiez auprès du détaillant ou de votre administrateur de système pour savoir de quelle façon votre radio a été programmée.

1 Appuyez sur  pour accéder au menu.

2 Appuyez sur  ou  pour choisir le Wi-Fi, puis sur appuyez sur  pour sélectionner.



3 Appuyez sur  ou  pour les Réseaux, puis sur appuyez sur  pour sélectionner.

4 Appuyez sur  ou  pour un point d'accès réseau, puis sur appuyez sur  pour sélectionner.



AVIS:

Pour un réseau Wi-Fi WPA d'entreprise, si un point d'accès réseau n'est pas préconfiguré, l'option *Connecter* n'est pas disponible.

5 Appuyez sur  ou  pour se *Connecter*, puis sur appuyez sur  pour sélectionner.

6 Pour un réseau Wi-Fi WPA personnel, entrez le mot de passe et appuyez sur  .

7 Pour un réseau Wi-Fi WPA d'entreprise, le mot de passe est configuré à partir de RM.

Si le mot de passe préconfiguré est correct, votre radio se connecte automatiquement au point d'accès réseau sélectionné.

Si le mot de passe préconfiguré n'est pas valide, l'écran affiche *Authenticat. - Échec* et revient automatiquement au menu précédent.

Lorsque la connexion est réussie, la radio affiche un avis et le point d'accès réseau est enregistré dans la liste des profils.

Si la connexion échoue, la radio affiche l'écran d'avis d'échec pendant un moment et revient automatiquement au menu précédent.

Vérification de l'état de la connexion Wi-Fi

Suivez la procédure suivante pour vérifier l'état de la connexion Wi-Fi.

Appuyez sur la touche programmée **Requête d'état Wi-Fi** pour connaître l'état de la connexion avec l'annonce vocale. L'annonce vocale indique Le Wi-Fi est désactivé, Le Wi-Fi est activé, mais il n'y a pas de connexion ou Le Wi-Fi est activé avec connexion.

- L'écran affiche **Wi-Fi désactivé** lorsque le Wi-Fi est désactivé.
- L'écran affiche **Wi-Fi activé, connecté** lorsque la radio est connectée à un réseau.
- L'écran affiche **Wi-Fi activé, déconnectée** lorsque le Wi-Fi est activé, mais que la radio n'est pas connectée à un réseau.

Les annonces vocales pour la touche programmée Requête d'état Wi-Fi peuvent être personnalisées

par le CPS selon les exigences des utilisateurs. Pour obtenir des renseignements supplémentaires, adressez-vous à votre détaillant ou à votre administrateur de système.









AVIS:

La touche programmée **Requête d'état Wi-Fi** est affectée par défaut. Vérifiez auprès du détaillant ou de votre administrateur de système pour savoir de quelle façon votre radio a été programmée.

Actualisation de la liste de réseaux



Suivez la procédure pour actualiser la liste de réseaux.

- Effectuez les opérations suivantes pour actualiser la liste de réseaux à partir du menu.
 - a. Appuyez sur  pour accéder au menu.
 - b. Appuyez sur  ou  pour choisir le **Wi-Fi**, puis sur appuyez sur  pour sélectionner

- c. Appuyez sur  ou  pour les Réseaux, puis sur appuyez sur  pour sélectionner.

Quand vous entrez dans le menu Réseaux, la radio actualise automatiquement la liste des réseaux.

- Si vous êtes déjà dans le menu Réseaux, effectuez l'action suivante pour actualiser la liste de réseaux.

Appuyez sur  ou  pour Actualiser, puis sur appuyez sur  pour sélectionner.

La radio s'actualise et affiche la dernière liste de réseaux.

Ajout d'un réseau









AVIS:



Cette tâche n'est pas applicable aux réseaux Wi-Fi WPA d'entreprise.

Si un réseau préféré n'est pas dans la liste de réseaux disponibles, effectuez les opérations suivantes pour ajouter un réseau.



- 1 Appuyez sur  pour accéder au menu.

- 2 Appuyez sur  ou  pour choisir le Wi-Fi, puis sur appuyez sur  pour sélectionner.



- 3 Appuyez sur  ou  pour les Réseaux, puis sur appuyez sur  pour sélectionner.

- 4 Appuyez sur  ou  pour Ajouter un réseau, puis sur appuyez sur  pour sélectionner.

- 5 Entrez l'identifiant SSID (Service Set Identifier), puis appuyez sur  .

6 Appuyez sur  ou  pour l'Ouvrir, puis sur  pour sélectionner.

7 Entrez le mot de passe et appuyez sur  .
La radio affiche un mini-avis positif pour indiquer que le réseau est correctement enregistré.

4 Appuyez sur  ou  pour un point d'accès réseau, puis sur  pour sélectionner.

5 Appuyez sur  ou  pour afficher les détails, puis sur  pour sélectionner.



AVIS:

L'écran affiche des détails différents pour les points d'accès réseau Wi-Fi WPA personnel et Wi-Fi WPA d'entreprise.

Wi-Fi WPA personnel

Pour un point d'accès réseau connecté, votre radio affiche l'identifiant Service Set Identifier (SSID), le mode de sécurité, l'adresse Media Access Control (MAC) et l'adresse Internet Protocol (IP).

Pour un point d'accès réseau non connecté, votre radio affiche le SSID et le mode de sécurité.



Wi-Fi WPA d'entreprise



Pour un point d'accès réseau connecté, votre radio affiche le SSID, le mode de sécurité, l'identité, la méthode Extended Authentication Protocol (EAP),

Affichage des détails de points d'accès réseau

Vous pouvez afficher les détails des points d'accès réseau.

1 Appuyez sur  pour accéder au menu.

2 Appuyez sur  ou  pour choisir le Wi-Fi, puis sur  pour sélectionner.

3 Appuyez sur  ou  pour les Réseaux, puis sur  pour sélectionner.

l'authentification de phase 2, le nom du certificat, l'adresse MAC, l'adresse IP, la passerelle, le DNS1 et le DNS2.

Pour un point d'accès réseau non connecté, votre radio affiche le SSID, le mode de sécurité, l'identité, la méthode EAP, l'authentification de phase 2 et le nom du certificat.





Retrait de points d'accès réseau









AVIS:



Cette tâche n'est pas applicable aux réseaux Wi-Fi d'entreprise.



Effectuez les opérations suivantes pour supprimer des points d'accès réseau dans la liste de profils.

- 1 Appuyez sur  pour accéder au menu.
- 2 Appuyez sur  ou  pour choisir le Wi-Fi, puis sur appuyez sur  pour sélectionner.

- 3 Appuyez sur  ou  pour les Réseaux, puis sur appuyez sur  pour sélectionner.

- 4 Appuyez sur  ou  pour sélectionner un point d'accès réseau, puis sur appuyez sur  pour sélectionner.

- 5 Appuyez sur  ou  pour le Supprimer, puis sur appuyez sur  pour sélectionner.

- 6 Appuyez sur  ou  pour choisir Oui, puis sur appuyez sur  pour sélectionner.

La radio affiche un mini-avis positif pour indiquer que le point d'accès réseau sélectionné est supprimé avec succès.

Utilitaires



Ce chapitre décrit le fonctionnement des fonctions utilitaires disponibles sur votre radio.



Activer ou désactiver les tonalités et les avertissements de la radio



Vous pouvez activer ou désactiver toutes les tonalités et tous les avertissements de la radio (sauf la tonalité d'avertissement d'urgence entrant), au besoin.



Appuyez sur la touche programmée **Toutes Tntés/Avert.** pour activer ou désactiver toutes les tonalités ou suivez la procédure ci-dessous pour accéder à cette fonction depuis le menu de la radio.

- 1 Appuyez sur  pour accéder au menu.

- 2 Appuyez sur  ou  Utilitaires, puis sur  pour sélectionner.

- 3 Appuyez sur  ou  Paramètres radio, puis sur  pour sélectionner.

- 4 Appuyez sur  ou  Tonalités/alertes, puis sur  pour sélectionner.

- 5 Appuyez sur  ou  jusqu'à Toutes les tonalités, puis sur  pour sélectionner.



- 6 Appuyez sur  pour activer ou désactiver toutes les tonalités et alertes.
L'écran affiche ✓ à côté du message Activé.
L'icône ✓ ne s'affiche plus à côté du message Activé.



Régler l'écart de volume des tonalités d'avertissement



Vous pouvez régler l'écart de volume des tonalités d'avertissement au besoin. Cette fonction permet de régler le niveau sonore des tonalités et des avertissements de manière à ce qu'il soit plus élevé ou moins élevé que celui de la voix.

- 1 Appuyez sur  pour accéder au menu.

2 Appuyez sur  ou  Utilitaires, puis sur  pour sélectionner.

3 Appuyez sur  ou  Paramètres radio, puis sur  pour sélectionner.



4 Appuyez sur  ou  Tonalités/alertes, puis sur  pour sélectionner.

5 Appuyez sur  ou  jusqu'à Écart Vol., puis sur  pour sélectionner.

6 Appuyez sur  ou  jusqu'au réglage de volume requis.

La radio émet une tonalité correspondant à chaque réglage de volume.

7 Faites un des suivants :



- Appuyez sur  pour conserver le réglage de volume affiché.
 - Appuyez sur  pour quitter sans modifier les réglages actuels de l'écart de volume.
-



Activer ou désactiver la tonalité d'autorisation de parler



Vous pouvez activer ou désactiver la tonalité d'autorisation de parler, au besoin.

1 Appuyez sur  pour accéder au menu.

2 Appuyez sur  ou  Utilitaires, puis sur  pour sélectionner.

3 Appuyez sur  ou  Paramètres radio, puis sur  pour sélectionner.

4 Appuyez sur  ou  Tonalités/alertes, puis sur appuyez sur  pour sélectionner.

5 Appuyez sur  ou  jusqu'à Tonalité d'autorisation de parler, puis sur appuyez sur  pour sélectionner.

6 Appuyez sur  pour activer ou désactiver la tonalité d'autorisation de parler.

L'écran affiche  à côté du message Activé.



L'icône  ne s'affiche plus à côté du message Activé.



Activer ou désactiver la tonalité d'alerte de mise sous tension

Vous pouvez activer ou désactiver la tonalité d'alerte de mise sous tension au besoin.

1 Appuyez sur  pour accéder au menu.

2 Appuyez sur  ou  Utilitaires, puis sur appuyez sur  pour sélectionner.

3 Appuyez sur  ou  Paramètres radio, puis sur appuyez sur  pour sélectionner.

4 Appuyez sur  ou  Tonalités/alertes, puis sur appuyez sur  pour sélectionner.

5 Appuyez sur  ou  pour activer, puis sur appuyez sur  pour sélectionner.

6 Appuyez sur  pour activer ou désactiver la tonalité d'alerte de mise sous tension.

L'écran affiche  à côté du message Activé.

L'icône  ne s'affiche plus à côté du message Activé.

Régler le niveau de puissance



Vous pouvez personnaliser le niveau de puissance de votre radio en réglant celui-ci à élevé ou bas pour chaque zone Connect Plus.



Haute permet des communications, en mode Connect Plus, avec des sites de tour situés à une distance considérable. **Basse** permet des communications, en mode Connect Plus, avec des sites de tour situés à proximité.



Appuyez sur la touche programmée **Niveau de puissance** pour alterner entre un niveau de puissance élevé ou bas.





Pour accéder à cette fonction à partir de l'écran de la radio, suivez la procédure suivante.

- 1 Appuyez sur  pour accéder au menu.

- 2 Appuyez sur  ou  Utilitaires, puis sur  pour sélectionner.

- 3 Appuyez sur  ou  Paramètres radio, puis sur  pour sélectionner.

- 4 Appuyez sur pour  ou  pour afficher l'alimentation, puis sur  pour sélectionner.



- 5 Appuyez sur  ou  pour choisir , le réglage requis, puis sur  pour sélectionner.
 - ✓ s'affiche à côté du réglage sélectionné. Appuyez longuement sur  à tout moment pour retourner à l'écran d'accueil.
 L'écran revient au menu précédent.



Changer le mode d'affichage



Vous pouvez changer le mode d'affichage de la radio pour le faire passer du mode Jour au mode Nuit et inversement, au besoin. Ce réglage modifie la palette de couleurs de l'écran.

- 1 Appuyez sur  pour accéder au menu.

2 Appuyez sur  ou  Utilitaires, puis sur  pour sélectionner.

3 Appuyez sur  ou  Paramètres radio, puis sur  pour sélectionner.

4 Appuyez sur  ou  jusqu'à Affichage, puis sur  pour sélectionner.
L'écran affiche Mode Jour et Mode Nuit.

5 Appuyez sur  ou  jusqu'au réglage désiré, puis appuyez sur  pour activer la sélection. ✓
L'icône s'affiche à côté du réglage sélectionné.

Régler la luminosité de l'écran

Vous pouvez ajuster la luminosité de l'affichage de la radio selon vos besoins.









AVIS:



La luminosité de l'écran ne peut être ajustée lorsque la fonction « Luminosité auto » est activée.



1 Appuyez sur  pour accéder au menu.

2 Appuyez sur  ou  Utilitaires, puis sur  pour sélectionner.

3 Appuyez sur  ou  Paramètres radio, puis sur  pour sélectionner.

4 Appuyez sur  ou  jusqu'à Affichage, puis sur  pour sélectionner.

5 Appuyez sur  ou  jusqu'à Luminosité, puis sur  pour sélectionner.
L'écran affiche une barre de progression.



- 6 Réduisez la luminosité de l'écran en appuyant sur  ou augmentez-la en appuyant sur .



Sélectionnez un réglage de 1 à 8. Appuyez sur  pour confirmer le réglage.



Activer ou désactiver l'écran d'introduction



Vous pouvez activer ou désactiver l'écran d'introduction, au besoin.

- 1 Appuyez sur  pour accéder au menu.
-

- 2 Appuyez sur  ou  Utilitaires, puis sur  pour sélectionner.
-

- 3 Appuyez sur  ou  Paramètres radio, puis sur  pour sélectionner.
-

- 4 Appuyez sur  ou  jusqu'à Affichage, puis sur  pour sélectionner.
-

- 5 Appuyez sur  ou  jusqu'à Écran intro., puis sur  pour sélectionner.
-

- 6 Appuyez sur  pour activer ou désactiver l'écran d'introduction.

L'écran affiche  à côté du message Activé.



L'icône  ne s'affiche plus à côté du message Activé.



Language



Vous pouvez configurer la langue d'affichage de votre radio.

- 1 Appuyez sur  pour accéder au menu.
-

2 Appuyez sur  ou  Utilitaires, puis sur  pour sélectionner.

3 Appuyez sur  ou  Paramètres radio, puis sur  pour sélectionner.



4 Appuyez sur  ou  jusqu'aux Langues, puis sur  pour sélectionner.



5 Appuyez sur  ou  jusqu'à la langue voulue, puis sur  pour activer la sélection. ✓
L'icône s'affiche à côté de la langue sélectionnée.



Activer ou désactiver le voyant DEL

Vous pouvez activer ou désactiver le voyant DEL, au besoin.

1 Appuyez sur  pour accéder au menu.

2 Appuyez sur  ou  Utilitaires, puis sur  pour sélectionner.

3 Appuyez sur  ou  Paramètres radio, puis sur  pour sélectionner.



4 Appuyez sur  ou  jusqu'à l'indicateur DEL, puis sur  pour sélectionner.



5 Appuyez sur  pour activer ou désactiver le voyant DEL.
L'écran affiche ✓ à côté du message Activé.
L'icône ✓ ne s'affiche plus à côté du message Activé.



Déterminer le type de câble

Vous pouvez sélectionner le type de câble utilisé par votre radio.

- 1 Appuyez sur  pour accéder au menu.

- 2 Appuyez sur  ou  Utilitaires, puis sur  pour sélectionner.

- 3 Appuyez sur  ou  Paramètres radio, puis sur  pour sélectionner.

- 4 Appuyez sur  ou  jusqu'à Type câble, puis sur  pour sélectionner.



- 5 Le type de câble actuel est indiqué par l'icône .



Annonce vocale



Cette fonction permet à la radio de faire entendre la zone ou le canal que l'utilisateur vient d'attribuer, ou de signaler

l'appui sur une touche programmable. L'indicateur audio peut être personnalisé en fonction des exigences du client. Cette option est particulièrement utile lorsqu'il est difficile de lire le contenu affiché à l'écran.

- 1 Appuyez sur  pour accéder au menu.





- 2 Appuyez sur  ou  Utilitaires, puis sur  pour sélectionner.

- 3 Appuyez sur  ou  Paramètres radio, puis sur  pour sélectionner.

- 4 Appuyez sur  ou  jusqu'à Annonce vocale, puis sur  pour sélectionner.







Vous pouvez également utiliser  pour changer l'option sélectionnée.



- 5 Faites un des suivants :



- Appuyez sur  pour activer la fonction d'annonce vocale. L'écran affiche  à côté du message Activé.
- Appuyez sur  pour désactiver la fonction d'annonce vocale. L'icône  ne s'affiche plus à côté du message Activé.



Délai de menu

Réglez la durée pendant laquelle la radio affiche le menu avant de revenir automatiquement à l'écran d'accueil.

- 1 Appuyez sur  pour accéder au menu.
- 2 Appuyez sur  ou  Utilitaires, puis sur  pour sélectionner.
- 3 Appuyez sur  ou  Paramètres radio, puis sur  pour sélectionner.

- 4 Appuyez sur  ou  jusqu'à Affichage, puis sur  pour sélectionner.

- 5 Appuyez sur  ou  jusqu'à Délai de menu, puis sur  pour sélectionner.

- 6 Appuyez sur  ou  jusqu'au paramètre voulu, puis sur  pour sélectionner.



Activation ou désactivation de l'avertisseur / des phares



Cette fonction doit être installée par le connecteur d'accessoire à l'arrière de votre radio par votre détaillant.

Votre radio peut vous aviser d'un appel entrant en actionnant l'avertisseur et les phares. Lorsque cette fonction est activée, les appels entrants font s'activer l'avertisseur et les phares de votre véhicule.



- 1 Faites un des suivants :

- Appuyez sur la touche programmée **Avert./ phares** pour activer ou désactiver la fonction Avert./phares. Ignorez les étapes suivantes.
- Appuyez sur  pour accéder au menu.

2 Appuyez sur  ou  Utilitaires, puis sur  pour sélectionner.

3 Appuyez sur  ou  Paramètres radio, puis sur  pour sélectionner.

4 Appuyez sur  ou  jusqu'à Avert./ phares, puis sur  pour sélectionner.



5 Appuyez sur  pour activer ou désactiver l'avertisseur ou les phares.
L'écran affiche  à côté du message Activé.



L'icône  ne s'affiche plus à côté du message Activé.



Régler les préférences d'utilisation du sélecteur double



Votre radio est dotée d'un sélecteur double **Volume/Canal**. Si vous désactivez l'option de sélecteur double, le sélecteur permet uniquement de régler le volume.

1  pour accéder au menu.

2  ou  jusqu'à Utilitaires, puis appuyez sur  pour sélectionner.

3  ou  jusqu'à Config. radio, puis appuyez sur  pour sélectionner.









4  ou  jusqu'à Double sélect., puis appuyez sur  pour sélectionner.

- 5 L'écran affiche `Volume uniq.` et `Volume & Canal`.
 ou  jusqu'au réglage voulu, puis appuyez sur  pour sélectionner.
 ✓ s'affiche à côté du réglage sélectionné.
 L'écran revient au menu précédent.
-

Contrôle de gain automatique de microphone numérique (Mic. CGA-D)

Cette fonction gère automatiquement le gain du microphone de votre radio pendant la transmission sur un système numérique. La fonction élimine l'audio fort ou augmente l'audio faible en fonction d'une valeur prédéterminée afin d'assurer un niveau audio uniforme.

- 1 Appuyez sur  pour accéder au menu.
-
- 2 Appuyez sur  ou  `Utilitaires`, puis sur  pour sélectionner.
-







- 3 Appuyez sur  ou  `Paramètres radio`, puis sur  pour sélectionner.
-
- 4 Appuyez sur  ou  jusqu'à `Mic. CGA-D`, puis sur  pour sélectionner.
-
- 5 Faites un des suivants :
- Appuyez sur  pour activer **Mic.CGA-D**. L'écran affiche ✓ à côté du message `Activé`.
 - Appuyez sur  pour désactiver **Mic.CGA-D**. Le ✓ ne s'affiche plus à côté d'`Activé`.
-









Audio intelligent

Votre radio peut régler automatiquement le volume audio pour compenser le bruit de fond actuel dans l'environnement, y compris les sources de bruit mobiles et



immobiles. Cette fonction est une fonction de réception uniquement et ne touche pas l'audio de transmission.



- 1 Appuyez sur  pour accéder au menu.



Commande radio Étapes à suivre	
Menu	<p>a Appuyez sur  pour accéder au menu.</p> <p>b Appuyez sur  ou  Paramètres radio, puis sur appuyez sur  pour sélectionner.</p> <p>c Appuyez sur  ou  Paramètres radio, puis sur appuyez sur  pour sélectionner.</p>

Commande radio	Étapes à suivre
	<p>d Appuyez sur  ou  jusqu'à Audio intelligent, puis sur appuyez sur  pour sélectionner.</p> <p> AVIS: Vous pouvez également utiliser  ou  pour changer l'option sélectionnée.</p> <p>e Faites un des suivants :</p> <ul style="list-style-type: none"> Appuyez sur  pour activer la fonction Audio intelligent. L'écran affiche  à côté du message Activé.



Commande radio	Étapes à suivre
	<ul style="list-style-type: none"> Appuyez sur  pour désactiver la fonction Audio intelligent. L'icône ✓ ne s'affiche plus à côté du message Activé.

2 Appuyez sur  ou  Utilitaires, puis sur appuyez sur  pour sélectionner.

3 Appuyez sur  ou  Paramètres radio, puis sur appuyez sur  pour sélectionner.

4 Appuyez sur  ou  jusqu'à Audio intelligent, puis sur appuyez sur  pour sélectionner.

5 Faites un des suivants :



- Appuyez sur  pour activer la fonction Audio intelligent. L'écran affiche ✓ à côté du message Activé.
- Appuyez sur  pour désactiver la fonction Audio intelligent. L'icône ✓ ne s'affiche plus à côté du message Activé.



Consultez la section [Liste des accessoires approuvés](#) pour connaître les accessoires audio Bluetooth recommandés avec réglage de volume automatique intégré permettant d'obtenir un rendement similaire.





Activer ou désactiver la fonction de suppression des réactions acoustiques

Cette fonction vous permet de réduire la réaction acoustique reçue lors de la réception d'appels.





1 Appuyez sur  pour accéder au menu.

2 Appuyez sur  ou  Utilitaires, puis sur appuyez sur  pour sélectionner.

3 Appuyez sur  ou  Paramètres radio, puis sur appuyez sur  pour sélectionner.

4 Appuyez sur  ou  jusqu'à Réducteur de bruit, puis sur appuyez sur  pour sélectionner. Vous pouvez également utiliser  ou  pour changer l'option sélectionnée.

5 Effectuez l'une des opérations suivantes.

- Appuyez sur  pour activer la suppression de la réaction acoustique. L'écran affiche  à côté du message Activé.
 - Appuyez sur  pour désactiver la suppression de la réaction acoustique. L'icône  ne s'affiche plus à côté du message Activé.
-

Activation ou désactivation du GNSS

Le système mondial de navigation par satellite (GNSS) est un système de navigation par satellite qui permet de déterminer l'emplacement précis de la radio. Le GNSS

comprend le système de navigation mondial (GPS), le système mondial de satellites de navigation (GLONASS) et le système satellite de navigation BeiDou (BDS).









AVIS:



Certains modèles de radio peuvent offrir le GPS, le GLONASS et le BDS. La constellation GNSS est configurée dans le CPS. Vérifiez auprès du détaillant ou de votre administrateur de système pour savoir de quelle façon votre radio a été programmée.

1 Faites un des suivants :

- Appuyez sur la touche programmée GNSS pour activer ou désactiver la fonction. Ignorez les étapes suivantes.
 - Appuyez sur  pour accéder au menu.
-

2 Appuyez sur  ou  jusqu'à Utilitaires. Appuyez sur  pour effectuer la sélection.

3 Appuyez sur  ou  jusqu'au Paramètres de la radio. Appuyez sur  pour effectuer la sélection.

4 Appuyez sur  ou jusqu'  à GNSS. Appuyez sur  pour effectuer la sélection.

5 Appuyez sur  pour activer ou désactiver le GNSS.

Si la fonction est activée,  apparaît à côté d'Activé.



Si cette option est désactivée, le  ne s'affiche plus à côté de Activé.

Reportez-vous à la section [Consulter les informations du système GNSS à la page 365](#) sur l'accès aux informations du GNSS.

Accès aux renseignements généraux sur la radio

Votre radio contient des renseignements sur les éléments suivants :



- Batterie
- Degré d'inclinaison (accéléromètre)
- Index de numéro de modèle de la radio
- Codeplug de carte d'option par radiocommunication (OTA) CRC
- Numéro du site
- Info site
- Alias et ID de la radio
- Versions du micrologiciel et de la fiche de codes
- Informations du système GNSS



Appuyez sur  en tout temps pour revenir à l'écran précédent ou maintenez enfoncée la touche  pour revenir à l'écran d'accueil. Lorsqu'il n'y a aucune activité pendant une durée prédéfinie, la radio quitte l'écran en cours.



Vérifier l'index de numéro de modèle de la radio

Ce numéro d'index identifie le matériel propre au modèle de votre radio. Votre administrateur de système radio pourrait vous demander ce numéro lors de la préparation d'une nouvelle codeplug de carte d'option pour votre radio.

- 1 Appuyez sur  pour accéder au menu.

- 2 Appuyez sur  ou  Utilitaires, puis sur appuyez sur  pour sélectionner.



- 3 Appuyez sur  ou  Info radio, puis sur appuyez sur  pour sélectionner.



- 4 Appuyez sur  ou  jusqu'à Index modèle, puis sur appuyez sur  pour sélectionner. L'écran affiche l'index de numéro de modèle.



Vérification fichier de codeplug de carte d'option OTA CRC

Si votre administrateur de système radio vous demande d'afficher la vérification CRC de fichier de codeplug de carte d'option OTA (par radiocommunication) CRC, suivez les instructions ci-dessous. Cette option de menu n'apparaît que si la carte d'option a reçu sa dernière mise à jour de codeplug par radiocommunication.

- 1 Appuyez sur  pour accéder au menu.

- 2 Appuyez sur  ou  Utilitaires, puis sur appuyez sur  pour sélectionner.

- 3 Appuyez sur  ou  Info radio, puis sur appuyez sur  pour sélectionner.

- 4 Appuyez sur  ou  jusqu'à crcCP OTA 0B, puis sur appuyez sur  pour sélectionner. L'écran affiche des chiffres et des lettres. Transmettez cette information à votre administrateur

de système radio exactement telle qu'elle est affichée.

Affichage de l'ID du site (numéro du site)









AVIS:



Si vous n'êtes pas enregistré auprès d'un site, l'écran affiche Non enregistré.

La radio affiche brièvement l'ID du site au moment de son enregistrement comme site Connect Plus. Après l'enregistrement, la radio n'indique habituellement pas le numéro du site. Pour afficher le numéro de site enregistré, procédez comme suit :

- 1 Appuyez sur  pour accéder au menu.

- 2 Appuyez sur  ou  Utilitaires, puis sur  pour sélectionner.

- 3 Appuyez sur  ou  Info radio, puis sur  pour sélectionner.

- 4 Appuyez sur  ou  jusqu'à Numéro du site, puis sur  pour sélectionner. L'écran affiche l'ID du réseau et le numéro du site.
-

Vérification de l'info du site



AVIS:



Si vous n'êtes pas enregistré auprès d'un site, l'écran affiche Non enregistré.



La fonction Info site fournit des renseignements qui peuvent être utiles à un technicien de service. Il s'agit des renseignements suivants :



- Le numéro du relais de canal de contrôle courant.
- RSSI : Dernière valeur de puissance du signal mesurée à partir du relais de canal de contrôle.
- Liste de voisins envoyée par le relais de canal de contrôle (cinq chiffres séparés par des virgules).

Si la radio vous demande d'utiliser cette fonction, veuillez rapporter l'information affichée exactement telle qu'elle apparaît à l'écran.

- 1 Appuyez sur  pour accéder au menu.



- 2 Appuyez sur  ou  Utilitaires, puis sur appuyez sur  pour sélectionner.



- 3 Appuyez sur  ou  Info radio, puis sur appuyez sur  pour sélectionner.



- 4 Appuyez sur  ou  jusqu'à Infos site, puis sur appuyez sur  pour sélectionner.
L'écran affiche l'info du site.

Pour accéder à cette fonction à partir de l'écran de la radio, suivez la procédure ci-dessous.

- 1 Appuyez sur  pour accéder au menu.

- 2 Appuyez sur  ou  Utilitaires, puis sur appuyez sur  pour sélectionner.

- 3 Appuyez sur  ou  Info radio, puis sur appuyez sur  pour sélectionner.

- 4 Appuyez sur  ou  jusqu'à Mon ID, puis sur appuyez sur  pour sélectionner.
L'écran affiche l'ID de la radio.



Vérifier l'ID de la radio



Cette fonction permet d'afficher l'ID de votre radio.



Vérifier les versions du micrologiciel et de la fiche de code

Affiche la version du micrologiciel de la radio.

- 1 Appuyez sur  pour accéder au menu.

- 2 Appuyez sur  ou  Utilitaires, puis sur appuyez sur  pour sélectionner.

- 3 Appuyez sur  ou  Info radio, puis sur appuyez sur  pour sélectionner.

- 4 Appuyez sur  ou  jusqu'aux Versions, puis sur appuyez sur  pour sélectionner.
L'écran affiche une liste avec les renseignements suivants :
 - Version du micrologiciel (radio)
 - Version de codeplug (radio)
 - Version du micrologiciel de la carte d'option

- Version de fréquence de la carte d'option
- Version de matériel de la carte d'option
- Version de codeplug de la carte d'option

Recherche des mises à jour

Connect Plus offre la possibilité de mettre à jour certains fichiers (codeplug de carte d'option, fichier de fréquence réseau et fichier de micrologiciel de carte d'option) par radiocommunication.



AVIS:

Vérifiez auprès du détaillant ou de votre administrateur de système pour savoir si cette fonction a été activée pour votre radio.

L'écran de la radio Connect Plus a la possibilité d'afficher sa codeplug de carte d'option OTA CRC courante, la version du fichier de fréquence ou du micrologiciel de carte d'option à l'aide d'une option de menu. De plus, les radios à afficheur sur lesquelles le transfert de fichier par radiocommunication a été activé peuvent afficher la version des fichiers en attente. Un « fichier en attente » est un fichier de fréquence ou de micrologiciel de carte d'option dont la radio Connect Plus est informée par la messagerie du système, mais dont elle n'a pas encore recueilli tous les

paquets. Si une radio à afficheur Connect Plus a un fichier en attente, le menu offre les options suivantes :

- Afficher le numéro de version du fichier en attente.
- Afficher le pourcentage de paquets de fichiers recueillis jusque-là.
- Demander que la radio Connect Plus reprenne la cueillette des paquets de fichiers.

Si le transfert de fichier par radiocommunication Connect Plus est activé sur la radio, la radio peut parfois amorcer un transfert de fichier sans en aviser au préalable l'utilisateur de la radio. Lorsque la radio recueille des paquets de fichiers, le voyant DEL clignote rapidement en rouge et la radio affiche l'icône Données à volume élevé sur la barre d'état de l'écran d'accueil.



AVIS:

La radio Connect Plus ne peut pas recueillir des paquets de fichiers et recevoir des appels simultanément. Pour annuler le transfert du fichier, appuyez brièvement sur le bouton **PTT**. La radio fait alors une demande d'appel pour le nom du contact sélectionné et annule le transfert de fichier pour cette radio jusqu'à ce que le processus reprenne plus tard.

Plusieurs choses peuvent déclencher la reprise du transfert de fichier. Le premier exemple s'applique à tous les types de fichiers par radiocommunication. Les autres exemples ne s'appliquent qu'au fichier de fréquence réseau et au fichier de micrologiciel de carte d'option :

- L'administrateur de système radio redémarre le transfert du fichier par radiocommunication.
- Le délai de la minuterie prédéfinie de la carte d'option expire, ce qui déclenche la reprise automatique du processus de cueillette des paquets par la carte d'option.
- Le délai de la minuterie n'est pas expiré, mais l'utilisateur de la radio demande la reprise du transfert du fichier à l'aide de l'option du menu.

Une fois que la radio Connect Plus a fini de télécharger tous les paquets de fichiers, elle doit procéder à la mise à niveau vers le fichier nouvellement acquis. Pour le fichier de fréquence réseau, il s'agit d'un processus automatique qui n'exige pas de réinitialisation de la radio. Pour le fichier de codeplug de carte d'option, il s'agit d'un processus automatique qui interrompt temporairement le service pendant que la carte d'option charge l'information de la nouvelle codeplug et acquiert de nouveau un site réseau. La vitesse à laquelle la radio procède à la mise à niveau vers le fichier de micrologiciel de carte d'option dépend de

la façon dont la radio a été configurée par le détaillant ou l'administrateur système. Soit que la radio procédera à la mise à niveau immédiatement après avoir recueilli tous les paquets de fichiers ou qu'elle attendra jusqu'à la mise sous tension de la radio par l'utilisateur.



AVIS:

Vérifiez auprès du détaillant ou de votre administrateur de système pour savoir de quelle façon votre radio a été programmée.

Le processus de mise à niveau vers un nouveau fichier de micrologiciel de carte d'option prend quelques secondes et requiert que la carte d'option Connect Plus réinitialise la radio. Une fois la mise à niveau commencée, la radio ne peut ni faire ni recevoir d'appel tant que le processus n'est pas terminé. Durant ce processus, l'écran de la radio informe les utilisateurs qu'ils ne doivent pas éteindre la radio.

Fichier de micrologiciel

La section suivante fournit des informations sur le micrologiciel de la radio.



Micrologiciel à jour









AVIS:



Si le fichier de micrologiciel de carte d'option n'est pas à jour (et si la radio a récemment recueilli en partie une version plus récente du fichier de micrologiciel de carte d'option version), la radio affiche une liste d'options additionnelles : Version, %reçu et Télécharger.

- 1 Appuyez sur  pour accéder au menu.











- 2 Appuyez sur  ou  jusqu'à Utilitaires, puis sur appuyez sur  pour sélectionner.



- 3 Appuyez sur  ou  Info radio, puis sur appuyez sur  pour sélectionner.



- 4 Appuyez sur  ou  jusqu'à Mises à jour, puis sur appuyez sur  pour sélectionner.

- 5 Appuyez sur  ou  jusqu'à Micrologiciels, puis sur appuyez sur  pour sélectionner.
L'écran affiche Firmware à jour.
-

Firmware en attente – Version

- 1 Appuyez sur  pour accéder au menu.
 - 2 Appuyez sur  ou  Utilitaires, puis sur appuyez sur  pour sélectionner.
 - 3 Appuyez sur  ou  Info radio, puis sur appuyez sur  pour sélectionner.
 - 4 Appuyez sur  ou  jusqu'à Mises à jour, puis sur appuyez sur  pour sélectionner.
-





- 5 Appuyez sur  ou  jusqu'à Micrologiciels, puis sur appuyez sur  pour sélectionner.
-



- 6 Appuyez sur  ou  jusqu'à Version, puis sur appuyez sur  pour sélectionner.



S'il y a un fichier de firmware de carte d'option en attente, l'écran affiche le numéro de version du firmware en attente.



S'il y a un fichier de micrologicielle de carte d'option en attente, l'écran affiche Firmware à jour.





Firmware en attente – % reçu

- 1 Appuyez sur  pour accéder au menu.
 - 2 Appuyez sur  ou  jusqu'à Utilitaires, puis sur appuyez sur  pour sélectionner.
-

- 3 Appuyez sur  ou  Info radio, puis sur appuyez sur  pour sélectionner.

 - 4 Appuyez sur  ou  jusqu'à Mises à jour, puis sur appuyez sur  pour sélectionner.



 - 5 Appuyez sur  ou  jusqu'à Micrologiciels, puis sur appuyez sur  pour sélectionner.



 - 6 Appuyez sur  ou  jusqu'à %reçu, puis sur appuyez sur  pour sélectionner.
L'écran affiche le pourcentage de paquets de fichiers de firmware recueillis jusque-là.
-  **AVIS:** Lorsque le pourcentage est de 100 %, la radio doit être éteinte puis rallumée pour amorcer la mise à niveau du firmware.



Firmware en attente – Téléchargement



Si la radio Connect Plus a préalablement laissé un transfert de fichier de firmware de carte d'option OTA avec un fichier partiel, l'appareil retourne automatiquement au transfert du fichier (s'il est encore en cours) à l'expiration du délai de la minuterie interne. Si vous voulez que l'appareil retourne au transfert d'un fichier de firmware de carte d'option en cours avant l'expiration du délai de cette minuterie interne, utilisez l'option de téléchargement de la façon décrite ci-dessous.



- 1 Appuyez sur  pour accéder au menu.

- 2 Appuyez sur  ou  jusqu'à Utilitaires, puis sur appuyez sur  pour sélectionner.

- 3 Appuyez sur  ou  Info radio, puis sur appuyez sur  pour sélectionner.

- 4 Appuyez sur  ou  jusqu'à Mises à jour, puis sur appuyez sur  pour sélectionner.

5 Appuyez sur  ou  jusqu'à Micrologiciels, puis sur appuyez sur  pour sélectionner.

6 Appuyez sur  ou  jusqu'à Télécharger, puis sur appuyez sur  pour sélectionner.
L'écran affiche les éléments suivants.

Téléchargement disponible	Lancer le téléchargement
Aucun téléchargement disponible	Téléchargement non disponible

7 Faites un des suivants :

- Sélectionnez Oui, puis appuyez sur la touche  pour commencer le téléchargement.

- Sélectionnez Non, puis appuyez sur la touche  pour revenir au menu précédent.

Fichier de fréquence

La section suivante fournit des informations sur le fichier de fréquence de la radio.



Fichier de fréquence à jour





AVIS:

Si le fichier de fréquence n'est pas à jour (et si la radio récemment recueillie en partie une version plus récente du fichier de fréquence) la radio affiche une liste d'options additionnelles : Version, Xregu et Télécharger.

1 Appuyez sur  pour accéder au menu.



2 Appuyez sur  ou  Utilitaires, puis sur appuyez sur  pour sélectionner.



3 Appuyez sur  ou  Info radio, puis sur appuyez sur  pour sélectionner.



4 Appuyez sur  ou  jusqu'à Fréquence, puis sur appuyez sur  pour sélectionner.
L'écran affiche Fichier de fréq. à jour.



Fichier de fréquence en attente – Version



1 Appuyez sur  pour accéder au menu.

2 Appuyez sur  ou  Utilitaires, puis sur appuyez sur  pour sélectionner.

3 Appuyez sur  ou  Info radio, puis sur appuyez sur  pour sélectionner.

4 Appuyez sur  ou  jusqu'à Mises à jour, puis sur appuyez sur  pour sélectionner.



5 Appuyez sur  ou  jusqu'à Fréquence, puis sur appuyez sur  pour sélectionner.



6 Appuyez sur  ou  jusqu'à Version, puis sur appuyez sur  pour sélectionner.



S'il y a un fichier de fréquence en attente, l'écran affiche le numéro de version du fichier de fréquence en attente.



Fichier de fréquence en attente – % reçu

1 Appuyez sur  pour accéder au menu.

2 Appuyez sur  ou  Utilitaires, puis sur appuyez sur  pour sélectionner.

3 Appuyez sur  ou  Info radio, puis sur appuyez sur  pour sélectionner.

4 Appuyez sur  ou  jusqu'à Mises à jour, puis sur appuyez sur  pour sélectionner.



5 Appuyez sur  ou  jusqu'à %reçu, puis sur appuyez sur  pour sélectionner.
L'écran affiche le pourcentage de paquets de fichiers de fréquence recueillis jusque-là.



Fichier de fréquence en attente – Téléchargement



Si la radio Connect Plus a préalablement laissé un transfert de fichier de fréquence réseau OTA avec un fichier partiel, l'appareil retourne automatiquement au transfert du fichier (s'il est encore en cours) à l'expiration du délai de la minuterie interne. Si vous voulez que l'appareil retourne au transfert d'un fichier de fréquence réseau avant l'expiration



du délai de cette minuterie interne, utilisez l'option de téléchargement de la façon décrite ci-dessous.



1 Appuyez sur  pour accéder au menu.

2 Appuyez sur  ou  Utilitaires, puis sur appuyez sur  pour sélectionner.

3 Appuyez sur  ou  Info radio, puis sur appuyez sur  pour sélectionner.

4 Appuyez sur  ou  jusqu'à Mises à jour, puis sur appuyez sur  pour sélectionner.

5 Appuyez sur  ou  jusqu'à Fréquence, puis sur appuyez sur  pour sélectionner.

- 6 Appuyez sur  ou  jusqu'à Télécharger, puis sur appuyez sur  pour sélectionner.

Téléchargement actuellement non disponible	Téléchargement non disponible
Téléchargement actuellement disponible	Lancer le téléchargement

- 7 Faites un des suivants :

- Sélectionnez Oui, puis appuyez sur la touche pour commencer le téléchargement.
- Sélectionnez Non, puis appuyez sur la touche pour revenir au menu précédent.



Consulter les informations du système GNSS



Affiche les informations GNSS sur votre radio, par exemple, les valeurs suivantes :



- Latitude



- Longitude
- Altitude
- Direction
- Vitesse
- Affaiblissement de la précision horizontale (Horizontal Dilution of Precision, ou HDOP)
- Satellites
- Version

- 1 Appuyez sur  pour accéder au menu.

- 2 Appuyez sur  ou  Utilitaires, puis sur appuyez sur  pour sélectionner.

- 3 Appuyez sur  ou  Info radio, puis sur appuyez sur  pour sélectionner.





- 4 Appuyez sur  ou  jusqu'à Infos GNSS, puis sur appuyez sur  pour sélectionner.



- 5 Appuyez sur  ou  jusqu'à l'élément voulu, puis sur  pour sélectionner. L'écran affiche les informations GNSS demandées.
-



Voir [Activation ou désactivation du GNSS à la page 352](#) pour en savoir plus au sujet du système GNSS.

Affichage des détails du certificat Wi-Fi d'entreprise

Vous pouvez afficher les détails du certificat Wi-Fi d'entreprise sélectionné.

- 1 Appuyez sur  pour accéder au menu.
 - 2 Appuyez sur  ou  jusqu'à Utilitaires. Appuyez sur  pour effectuer la sélection.
-

- 3 Appuyez sur  ou  pour Menu Certificat. Appuyez sur  pour effectuer la sélection.
✓ s'affiche vis-à-vis des certificats prêts.
-

- 4 Appuyez sur  ou  jusqu'au certificat voulu. Appuyez sur  pour effectuer la sélection.
-

Votre radio affiche les détails complets du certificat.



AVIS:

Pour les certificats non prêts, l'écran affiche uniquement l'état.

Autres systèmes

Les fonctions qui sont disponibles pour les utilisateurs radio en vertu de ce système sont disponibles dans le présent chapitre.

Bouton PTT

Le bouton **PTT** a deux fonctions principales :

- Le bouton **PTT** permet à la radio de transmettre un message aux autres radios pendant un appel. Lorsque vous appuyez sur le bouton **PTT**, le microphone se met sous tension.
- Lorsque vous n'êtes pas déjà en cours d'appel, vous pouvez vous servir du bouton **PTT** pour faire un nouvel appel.

Appuyez longuement sur la touche **PTT** pour parler. Relâchez le bouton **PTT** pour écouter.

Si la tonalité d'autorisation ou l'effet local PTT  est activé, attendez la fin de la brève tonalité pour parler.

 Si l'indicateur Canal libre est activé (programmé par le détaillant), une courte tonalité d'avertissement retentit lorsque l'utilisateur de la radio cible (la radio qui reçoit la

transmission) relâche le bouton **PTT**, vous indiquant que le canal est libre et que vous pouvez répondre.

 Vous entendez une tonalité d'interdiction de parler en continu si votre appel est interrompu. Vous devez relâcher le bouton **PTT** si vous entendez la tonalité d'interdiction de parler continue.

Touches programmables

Selon la durée pendant laquelle vous appuyez sur une touche, votre revendeur peut programmer les touches programmables pour en faire des raccourcis permettant d'accéder aux fonctions de la radio.

Appui bref

Appuyer et relâcher rapidement.

Appui long

Appuyez et maintenez enfoncé pour la durée programmée.



AVIS:

Voir [Fonctionnement d'urgence à la page 447](#) pour en savoir plus sur la durée de programmation pour la touche **Urgence**.

Fonctions attribuables de la radio

Les fonctions suivantes de la radio peuvent être attribuées aux boutons programmables.

Ambiance audio

Permet à l'utilisateur de sélectionner un environnement dans lequel la radio fonctionne.

Profils audio

Permet à l'utilisateur de sélectionner le profil audio préféré.

Commutateur® audio Bluetooth

Permet de faire alterner l'acheminement du signal audio entre le haut-parleur de la radio ou par un accessoire Bluetooth externe.

Connexion Bluetooth

Permet de lancer l'exécution d'une opération de recherche et de connexion Bluetooth.

Déconnexion Bluetooth

Met fin à toutes les connexions Bluetooth entre votre radio et tout dispositif Bluetooth.

Détection Bluetooth

Permet à votre radio de passer en mode Détection Bluetooth.

Avertissement d'appel

Permet l'accès direct à la liste des contacts de la radio afin de sélectionner le destinataire d'un avertissement d'appel.

Renvoi d'appel

Active ou désactive le renvoi d'appel.

Journal des appels

Permet d'ouvrir le journal des appels.

Annonce du canal

Transmet des messages vocaux pour une zone et un canal sur le canal sélectionné.

Contacts

Permet l'accès direct à la liste des contacts.

Urgence

Selon la programmation choisie, déclenche ou annule une urgence.

Quitter la diffusion publique (PA)

Faire basculer le routage de l'audio entre l'amplificateur/haut-parleur PA connecté et le système de sonorisation interne de la radio.

Localisation interne

Activation ou désactivation de la fonction de localisation interne.

Audio intelligent

Active ou désactive la fonction Audio intelligent.

Num. manuelle 

Permet d'effectuer un appel individuel en entrant un ID d'abonné.

Itinérance de site manuelle ⁵ 

Lance une recherche de site manuelle.

CGA Mic.

Permet d'activer et de désactiver la fonction de contrôle de gain automatique du microphone.

Moniteur

Surveille l'activité du canal sélectionné.

Notifications

Permet l'accès direct à la liste des notifications.

Suppression des nuisances sur le canal⁵

Permet de retirer temporairement un canal nuisible de la liste de balayage, sauf le canal sélectionné. Le canal sélectionné réfère à la zone ou à la combinaison de canaux sélectionnée de l'utilisateur à partir duquel le balayage est effectué.

Accès direct 

Permet de lancer un appel téléphonique, de groupe ou individuel prédéfini et d'envoyer un avis d'appel, un message texte rapide automatiquement ou de revenir au mode Accueil.

Fonction de carte d'option

Active ou désactive les fonctions de la carte d'option sur les canaux qui les utilisent.

Écoute permanente⁵

Surveille le trafic radio d'un canal sélectionné jusqu'à ce que la fonction soit désactivée.

Téléphone 

Permet l'accès direct à la liste des contacts du téléphone.

Cryptage 

Active ou désactive la fonction de cryptage.

Diffusion publique (PA)

Active/désactive le système PA interne de la radio.

Alias et ID de la radio

Indique l'alias et l'ID de la radio.

⁵ Ne s'applique pas à Capacity Plus.

Vérification de la radio

Détermine si une radio est active dans un système.

Désactiver la radio

Permet de désactiver une radio cible à distance.

Activer la radio

Permet d'activer une radio cible à distance.

Écoute à distance

Active le microphone d'une radio cible sans indication.

Relais/Direct⁵

Permet d'alterner entre l'utilisation d'un répéteur et les communications directes avec une autre radio.

Réinitialiser le canal d'accueil

Définit un nouveau canal d'accueil.

Mettre en sourdine le Rappel du canal d'accueil

Mets en sourdine le rappel du canal d'accueil.

Balayage ⁶

Permet d'activer et de désactiver la fonction de balayage.

Info site

Affiche le nom et l'ID du site actuel Capacity Plus - multisite.

Transmet les messages vocaux pour le site actuel pour le site actuel lorsque l'Annonce vocale est activée.

Verrouillage de site⁵

Lorsque cette fonction est activée, la radio ne recherche que le site courant. Lorsqu'elle est désactivée, la radio recherche d'autres sites en plus du site courant.

Contrôle de la télémétrie

Permet de contrôler la broche de sortie sur une radio locale ou distante.

Message texte

Sélectionne le menu de la messagerie texte.

Interruption de transmission

Met fin à un appel interruptible afin de libérer le canal.

Amélioration de la vibration

Permet d'activer et de désactiver l'amélioration de la vibration.

Annonce vocale activée/désactivée

Active ou désactive la fonction d'annonce vocale.

Transmission vocale (VOX)

Permet d'activer et de désactiver la transmission vocale.

⁶ Ne s'applique pas à Capacity Plus-Site unique.

Wi-Fi

Permet d'activer ou de désactiver la fonction Wi-Fi.

Sélection de zone

Permet de sélectionner une zone dans une liste.

Réglages ou fonctions attribuables

Les fonctions ou paramètres radio suivants peuvent être attribués aux touches programmables.

Sonneries/alertes

Permet d'activer et de désactiver les sonneries et les avertissements.

Rétroéclairage

Active ou désactive le rétroéclairage de l'écran.

Canal précédent/suivant

Selon la programmation, passe au canal précédent ou suivant.

Mode d'affichage

Permet d'alterner entre l'activation et la désactivation des modes d'affichage Jour et Nuit.

Niveau de puissance

Alterne entre un niveau de puissance haut ou bas.



Accès aux fonctions programmées

Suivez la procédure suivante pour accéder aux fonctions programmées de votre radio.



1 Faites un des suivants :

- Appuyez sur la touche programmée. Passez à [étape 3](#).
- Appuyez sur  pour accéder au menu.

2

Appuyez sur  ou  jusqu'à la fonction du menu et appuyez sur  pour sélectionner une fonction ou entrer dans un sous-menu.

3 Faites un des suivants :

- Appuyez sur  pour revenir à l'écran précédent.
- Maintenez enfoncée la touche  pour revenir à l'écran d'accueil.

La radio quitte automatiquement le menu et revient à l'écran d'accueil après une période d'inactivité.

Des touches de navigation se trouvent également sur le microphone à clavier. Voir [Touches du microphone à clavier à la page 43](#).

Indicateurs d'état

Ce chapitre explique les indicateurs d'état et les tonalités audio utilisés par la radio.









Icônes











L'affichage à cristaux liquides (ACL) présente l'état de la radio, les entrées de texte et des menus.

Tableau 9: Icônes d'affichage





Vous trouverez ci-dessous les icônes s'affichant dans la barre d'état qui apparaît au haut de l'écran. Les icônes sont classées par ordre d'utilisation ou d'apparition à partir de la gauche et sont spécifiques au canal.







	<p>Bluetooth connecté La fonction Bluetooth est activée. L'icône demeure allumée tant qu'un dispositif Bluetooth distant est connecté.</p>
---	---

	<p>Bluetooth non connecté La fonction Bluetooth est activée, mais aucun appareil Bluetooth à distance n'est connecté.</p>
	<p>Journal des appels Journal des appels radio.</p>
	<p>Contact Le contact radio est disponible.</p>
	<p>Urgence La radio est en mode d'urgence.</p>
	<p>Liste de réception flexible La liste de réception flexible est activée.</p>
	<p>Fonction GNSS disponible  La fonction GNSS est activée. L'icône demeure allumée tant que la réception d'une position est disponible.</p>
	<p>Fonction GNSS non disponible  La fonction GNSS est activée, mais ne reçoit aucune donnée du satellite.</p>

	<p>Données à volume élevé La radio reçoit des données à volume élevé et le canal est occupé.</p>	 <p>Notification La liste de notifications comprend au moins un événement manqué.</p>
	<p>Localisation interne disponible⁷ L'état de la localisation intérieure est activé et disponible.</p>	 <p>Carte d'option La fonction Carte d'option est activée. (Modèles dotés de la fonction Carte d'option uniquement.)</p>
	<p>Positionnement à l'intérieur non disponible⁷ L'état de la localisation intérieure est activé, mais non disponible parce que la fonction Bluetooth est désactivée ou parce que la détection des balises a été suspendue par Bluetooth.</p>	 <p>Absence de fonction de la carte d'option La fonction Carte d'option est désactivée.</p>
	<p>Message Arrivée d'un message entrant.</p>	 <p>Retardateur de programmation par radiocommunication Indique le temps restant avant le redémarrage automatique de la radio.</p>
	<p>Moniteur Le canal sélectionné est surveillé.</p>	 <p>Indicateur de puissance de signal reçu (RSSI) Le nombre de barres représente l'intensité du signal radio. L'affichage de quatre barres indique une intensité</p>
	<p>Mode Muet Le mode Muet est activé et le haut-parleur est coupé.</p>	

⁷ Ne s'applique qu'aux logiciels et au matériel les plus récents.

	de signal maximale. Cette icône ne s'affiche qu'en mode de réception.
	Sonnerie seulement Le mode sonnerie est activé.
	Balayage⁸ La fonction de balayage est activée.
	Balayage – Priorité 1⁸ La radio détecte de l'activité sur le canal ou le groupe de canaux Priorité 1.
	Balayage – Priorité 2⁸ La radio détecte de l'activité sur le canal ou le groupe de canaux Priorité 2.
	Sécurisée La fonction Cryptage est activée.

	Connexion La radio s'est connectée au serveur distant.
	Déconnexion La radio s'est déconnectée du serveur distant.
	Sonnerie silencieuse Le mode de sonnerie silencieuse est activé.
	Itinérance de site⁹ La fonction d'itinérance de site est activée.
	⁸Mode direct En l'absence d'un répéteur, la radio est configurée pour la communication directe radio à radio.
	Désactivation des tonalités Les tonalités sont désactivées.

⁸ Ne s'applique pas à Capacity Plus.

⁹ Ne s'applique pas à Capacity Plus—Ssite unique.











	Non sécurisée La fonction Cryptage est désactivée.
	Balayage par vote : La fonction de balayage par vote est activée.
	Wi-Fi Excellent¹⁰ Le signal Wi-Fi est excellent.
	Wi-Fi bon¹⁰ Le signal Wi-Fi est bon.
	Wi-Fi moyen¹⁰ Le signal Wi-Fi est moyen.
	Wi-Fi faible¹⁰ Le signal Wi-Fi est faible.
	Wi-Fi non disponible¹⁰ Le signal Wi-Fi n'est pas disponible.

Tableau 10: Icônes de menu avancé

Les icônes suivantes s'affichent près des éléments de menu qui offrent un choix entre deux options ou qui présentent un sous-menu offrant aussi deux options.

	Case à cocher (cochée) Indique que l'option est sélectionnée.
	Case à cocher (vide) Indique que l'option n'est pas sélectionnée.
	Case noire Indique que l'option sélectionnée dans le menu comporte un sous-menu.

¹⁰ Applicable uniquement pour les modèles XPR 5550e/XPR 5580e.

Tableau 11: Icônes de dispositif Bluetooth

Les icônes suivantes accompagnent les éléments de la liste de dispositifs Bluetooth afin de vous informer sur le type du dispositif.

	<p>Dispositif audio Bluetooth Il s'agit d'un dispositif audio compatible avec la technologie Bluetooth, comme un casque d'écoute.</p>
	<p>Dispositif de données Bluetooth Dispositif de transfert de données Bluetooth, par exemple, un lecteur de codes à barres.</p>
	<p>Dispositif PTT Bluetooth Il s'agit d'un dispositif PTT (messagerie vocale instantanée) compatible avec la technologie Bluetooth, comme un dispositif à fonction PTT uniquement (POD).</p>

Tableau 12: Icônes d'appels

Vous trouverez ci-dessous les icônes s'affichant à l'écran de la radio pendant un appel. Ces icônes apparaissent

également dans la liste de contacts pour indiquer le type d'alias ou d'ID.

	<p>Appel PC par Bluetooth Indique qu'un appel PC par Bluetooth est en cours. Dans la liste de contacts, elle indique l'alias (nom) ou l'ID (numéro) de l'appel PC par Bluetooth.</p>
	<p>Appel de répartition Le type de contact d'appel de répartition sert à envoyer un message texte à un PC répartiteur par le biais d'un serveur de messagerie texte de tiers.</p>
	<p>Appel de groupe/appel général Cette icône s'affiche lorsqu'un appel de groupe ou un appel général est en cours. Dans la liste de contacts, elle indique l'alias (nom) ou l'ID (numéro) du groupe.</p>









	<p>Appel individuel Cette icône s'affiche lorsqu'un appel individuel est en cours. Dans la liste de contacts, elle indique l'alias (nom) ou l'ID (numéro) de l'abonné.</p>
	<p>Appel de groupe comme étant un appel de groupe/général Indique un appel téléphonique comme étant un appel de groupe/général en cours.</p> <p>Dans la liste de contacts, elle indique l'alias (nom) ou l'ID (numéro) du groupe.</p>
	<p>Appel téléphonique comme étant un appel individuel Indique un appel téléphonique comme étant un Appel individuel en cours.</p> <p>Dans la liste de contacts, elle indique l'alias (nom) ou l'ID (numéro) du téléphone.</p>

Tableau 13: Icônes de tickets de tâche

Les icônes suivantes apparaissent momentanément sur l'écran dans le dossier Tickets de tâche.

	<p>Toutes les tâches Indique toutes les tâches de la liste.</p>
	<p>Nouvelles tâches Indique les nouvelles tâches.</p>
	<p>En cours Les travaux sont en cours de transmission. Ceci s'affiche avant l'indication d'échec ou de réussite d'envoi de tickets tâche.</p>
	<p>Échec de l'envoi Les travaux ne peuvent être envoyés.</p>
	<p>Réussite de l'envoi Les travaux ont été envoyés avec succès.</p>
	<p>Priorité 1 Indique le niveau de priorité 1 pour les travaux.</p>

	<p>Priorité 2 Indique le niveau de priorité 2 pour les travaux.</p>
	<p>Priorité 3 Indique le niveau de priorité 3 pour les travaux.</p>

Tableau 14: Icônes d'avertissement





Les icônes décrites ci-dessous s'affichent momentanément à l'écran de la radio lors de l'exécution d'une tâche.

	<p>Échec de transmission (négatif) L'action exécutée n'a pas réussi.</p>
	<p>Transmission réussie (positif) L'action exécutée a réussi.</p>
	<p>Transmission en cours (transitoire) Transmission en cours. Cette icône s'affiche avant l'indication de réussite ou d'échec de la transmission.</p>

Tableau 15: Icônes des éléments envoyés

Les icônes ci-dessous apparaissent dans le coin supérieur droit de l'écran dans le dossier Messages envoyés.

	<p>En cours Le message texte destiné à un alias ou à un ID d'abonné est en attente de transmission et sera ensuite en attente de confirmation.</p>
	<p>Le message texte destiné à un alias ou à un ID de groupe est en attente de transmission.</p>
	<p>Message personnel ou de groupe lu Le message texte a été lu.</p>
	<p>Message personnel ou de groupe non lu Le message texte n'a pas été lu.</p>

 ou 	<p>Échec de l'envoi Le message texte ne peut être envoyé.</p>
 ou 	<p>Réussite de l'envoi Le message texte a été envoyé.</p>

Voyants DEL

Les voyants DEL indiquent l'état de fonctionnement de la radio.

Rouge clignotant

La radio n'a pas réussi l'autovérification à la mise sous tension.

La radio reçoit une transmission d'urgence.

La radio effectue une transmission avec un niveau de batterie faible.

La radio est maintenant hors de la zone de couverture si la fonction ARTS est configurée.

Mode Muet est activé.

Vert continu

La radio est en cours de mise sous tension.

La radio effectue une transmission.

La radio envoie un avertissement d'appel ou une transmission d'urgence.

Vert clignotant

La radio est en train de recevoir un appel ou des données.

La radio récupère des transmissions de programmation.

La radio détecte de l'activité de radiocommunication.



AVIS:

Cette activité peut influencer ou non le canal programmé de la radio en raison de la nature du protocole relatif aux données numériques.

Le voyant DEL ne s'allume pas si la radio détecte de l'activité de liaison radio Capacity Plus.

Vert à clignotement double

La radio reçoit un appel ou des données cryptées.

Jaune continu

La radio surveille un canal classique.

La radio est en mode Détection Bluetooth.

Jaune clignotant

La radio effectue un balayage pour détecter de l'activité.

La radio n'a pas encore répondu à un avertissement d'appel.

La Liste de réception flexible de la radio est activée.

Tous les canaux Capacity Plus – multi-site sont occupés.

Jaune à clignotement double

La fonction Itinérance automatique est activée.

La radio recherche activement un nouveau site.

La radio n'a pas encore répondu à un avertissement d'appel de groupe.

La radio est verrouillée.

La radio n'est pas connectée au répéteur en mode Capacity Plus.

Tous les canaux Capacity Plus sont occupés.

Tonalités

Vous trouverez ci-dessous les tonalités émises par le haut-parleur de la radio.



Tonalité aiguë



Tonalité grave

Tonalités d'avertissement

Les tonalités d'avertissement vous informent de manière audible de l'état d'une tâche après l'avoir initiée.



Tonalité de réussite



Tonalité d'échec

Tonalités audio

La fonction Tonalités audio vous informe de manière audible de l'état ou répond à la réception de données sur la radio.



Tonalité continue

La radio émet un signal monophonique. Il retentit de manière continue jusqu'à ce qu'il cesse.



Tonalité périodique

Le signal sonore retentit de manière périodique en fonction des réglages de la radio. Il démarre, s'arrête, puis reprend.



Tonalité répétitive

Le signal sonore unique retentit et se répète jusqu'à ce que l'utilisateur y mette fin.



Tonalité temporaire

Son entendu une fois pendant une courte période définie par la radio.

Mode analogique ou numérique classique

Vous pouvez configurer chaque canal de la radio de manière analogique classique ou numérique classique.

Utilisez le **bouton sélecteur de canal** pour alterner entre les canaux analogiques et numériques.

Certaines fonctions ne sont pas disponibles lorsque vous basculez du mode numérique au mode analogique. Les icônes des fonctions numériques non disponibles sont

estompées. Les fonctions désactivées sont masquées dans le menu.

Certaines fonctions de la radio sont accessibles en mode analogique et numérique. Toutefois, les différences mineures de fonctionnement ne nuisent **pas** au rendement de la radio.



AVIS:

La radio peut aussi alterner entre les modes analogique et numérique pendant le balayage bimode. Pour obtenir plus de renseignements à ce sujet, consultez la section [Balayage à la page 425](#).

Information relative aux icônes

Dans le présent document, les icônes décrites sont utilisées pour signaler les fonctions prises en charge en mode analogique classique ou en mode numérique classique ou si elles sont disponibles au moyen d'un microphone à clavier.



Indique une fonction propre au **mode analogique classique** seulement.



Indique une fonction propre au **mode numérique classique** seulement.

Les fonctions offertes en mode conventionnel analogique **et** en mode numérique ne sont accompagnées d'**aucune** icône.

Sites IP interconnectés

Cette fonction permet à votre appareil radio de fonctionner au-delà de la zone de couverture d'un site unique en se connectant à différents sites accessibles par l'intermédiaire d'un réseau IP (Internet Protocol). Il s'agit d'un mode multisite classique.

Lorsque la radio quitte la zone de couverture d'un site et entre dans celle d'un autre site, elle se connecte au répéteur du nouveau site pour envoyer et recevoir les appels ou les transmissions de données. Cette opération s'effectue automatiquement ou manuellement en fonction de vos paramètres.

Si la radio est configurée en mode automatique, elle détecte tous les sites accessibles lorsque le signal du site actuel est faible ou lorsqu'elle ne reçoit aucun signal de ce site. Elle se verrouille alors sur le répéteur du site dont la

valeur RSSI (indicateur d'intensité de réception du signal) est la plus élevée.

Lors d'une recherche manuelle, la radio recherche le premier site actuellement dans la zone de couverture dans la liste des sites disponibles en itinérance, mais qui ne présente pas nécessairement le signal le plus puissant et s'y connecte.



AVIS:

Pour chaque canal, seule l'option Balayage ou Itinérance peut être activée, mais non les deux en même temps.

Les canaux pour lesquels cette fonctionnalité est activée peuvent être ajoutés à une liste d'itinérance particulière. En mode de recherche automatique en itinérance, la radio recherche le ou les canaux dans la liste d'itinérance afin de déterminer le meilleur site. Une liste d'itinérance peut contenir un maximum de 16 canaux, y compris le canal sélectionné.



AVIS:

Il est impossible d'ajouter ou de supprimer manuellement une entrée dans la liste d'itinérance. Pour obtenir des renseignements supplémentaires, adressez-vous à votre détaillant ou à votre administrateur de système.

Capacity Plus – site unique

Capacity Plus – site unique est une configuration de partage de canaux à site unique du système radio MOTOTRBO qui prend en charge des centaines d'utilisateurs et un maximum de 254 groupes à l'aide d'un bassin de canaux. Ainsi, votre radio peut utiliser efficacement tous les canaux programmés disponibles en mode Répéteur.

Une tonalité d'échec retentit lorsque vous tentez d'accéder à une fonction qui n'est pas accessible en mode Capacity Plus – Site unique à l'aide d'une touche programmable.

Certaines fonctions de la radio sont accessibles en mode numérique conventionnel, Sites IP interconnectés et Capacity Plus. Toutefois, les différences mineures de fonctionnement ne nuisent PAS à la performance de la radio.

Pour obtenir davantage de renseignements au sujet de cette configuration, adressez-vous à votre détaillant ou à votre administrateur de système.

Capacity Plus – multisite

Capacity Plus – multisite est une configuration de partage de canaux multisite du système radio MOTOTRBO alliant

les principaux avantages des configurations Capacity Plus et Sites IP interconnectés.

Capacity Plus – Multisite permet à votre appareil radio de fonctionner au-delà de la zone de couverture d'un site unique en se connectant à différents sites accessibles par l'intermédiaire d'un réseau IP. Cette fonction permet également d'accroître la capacité en utilisant efficacement le nombre disponible combiné de canaux programmés pris en charge par chacun des sites disponibles.

Lorsque la radio quitte la zone de couverture d'un site et entre dans celle d'un autre site, elle se connecte au répéteur du nouveau site pour envoyer et recevoir les appels ou les transmissions de données. Selon la configuration choisie, cette opération se fait de façon automatique ou manuelle.

Si la radio est configurée en mode automatique, elle détecte tous les sites accessibles lorsque le signal du site actuel est faible ou lorsqu'elle ne reçoit aucun signal de ce site. Elle se verrouille alors sur le relais du site dont la valeur RSSI.

Lors d'une recherche manuelle, la radio recherche le premier site actuellement à portée dans la liste des sites disponibles en itinérance (qui ne présente pas nécessairement le signal le plus puissant) et s'y connecte.

Les canaux pour lesquels la configuration Capacity Plus – multisite est activée peuvent être ajoutés à une liste d'itinérance particulière. En mode de recherche automatique en itinérance, la radio recherche ces canaux afin d'identifier le meilleur site.



AVIS:

Il est impossible d'ajouter ou de supprimer manuellement une entrée dans la liste d'itinérance. Pour obtenir des renseignements supplémentaires, adressez-vous à votre détaillant ou à votre administrateur de système.

Tout comme pour Capacity Plus – site unique, les icônes des fonctions qui ne sont pas offertes en mode Capacity Plus – multisite ne sont pas disponibles dans le menu. Une tonalité d'échec retentit lorsque vous tentez d'accéder à une fonction qui n'est pas accessible en mode Capacity Plus – multisite à l'aide d'une touche programmable.

Sélection des zones et des canaux

Ce chapitre décrit la procédure pour sélectionner une zone ou un canal sur votre radio. Une zone est un groupe de canaux.

Votre radio prend en charge jusqu'à 99 canaux et 2 zones, avec un maximum de 99 canaux par zone.

Chaque canal peut être programmé avec différentes fonctions ou divers groupes d'utilisateurs.





Sélection des zones



Suivez la procédure suivante pour sélectionner la zone requise sur votre radio.

1 Faites un des suivants :

- Appuyez sur la touche programmée **Sélection de zone**. Passez à [étape 3](#).
- Appuyez sur  pour accéder au menu.





2

Appuyez sur  ou  jusqu'à Zone. Appuyez sur  pour effectuer la sélection. L'écran affiche  et la zone courante.

- 3 Appuyez sur  ou  jusqu'à la zone voulue.
Appuyez sur  pour effectuer la sélection.
L'écran affiche <Zone> sélectionnée pendant un moment et revient à l'écran de la zone sélectionnée.
-

Sélection des zones à l'aide de la recherche d'alias

Suivez la procédure suivante pour sélectionner la zone voulue à l'aide de la recherche d'alias.

- 1 Appuyez sur  pour accéder au menu.
-
- 2 Appuyez sur  ou  jusqu'à Zone. Appuyez sur  pour effectuer la sélection.
L'écran affiche  et la zone actuelle.
-
- 3 Entrez le premier caractère de l'alias voulu.
L'écran affiche un curseur clignotant.
-

- 4 Entrez le reste des caractères de l'alias voulu.
La recherche d'alias n'est pas sensible à la casse. Si deux entrées ou plus portent le même nom, la radio affiche l'entrée figurant en premier dans la liste.
La première ligne de texte affiche les caractères que vous avez entrés. La ligne de texte suivante affiche les résultats de la recherche.
-

- 5 Appuyez sur  pour effectuer la sélection.
L'écran affiche <Zone> sélectionnée pendant un moment et revient à l'écran de la zone sélectionnée.
-

Sélection des canaux

Suivez la procédure suivante pour sélectionner le canal voulu après avoir sélectionné la zone.

Faites un des suivants :

- Appuyez sur la touche de **défilement vers le haut/bas**.
- Utilisez le **bouton Volume/Canal**.

- Appuyez sur les touches programmées **Canal précédent/suivant**.

Appels

Ce chapitre décrit les opérations pour recevoir et répondre à des appels, en faire et y mettre fin.

Vous pouvez choisir un alias ou un ID d'abonné, ou un alias ou un ID de groupe une fois que vous avez sélectionné un canal à l'aide d'une de ces fonctions :

Recherche d'alias

Cette méthode est utilisée uniquement pour faire un appel de groupe, un appel individuel ou un appel général à partir du microphone à clavier.

Liste de contacts

Cette méthode permet d'accéder directement à la liste des contacts.

Numérotation manuelle (à partir de Contacts)

Cette méthode est utilisée uniquement pour faire un appel individuel ou un appel téléphonique à partir du microphone à clavier.

Touches numériques programmées

Cette méthode est utilisée uniquement pour faire un appel de groupe, un appel individuel ou un appel général à partir du microphone à clavier.



AVIS:

Vous ne pouvez attribuer qu'un seul alias ou ID à une touche numérique, mais vous pouvez attribuer plus d'une touche numérique à un alias ou à un ID. Toutes les touches numériques du microphone à clavier peuvent être attribuées. Pour obtenir plus de renseignements à ce sujet, consultez la section [Association d'une entrée à une touche numérique programmable à la page 431](#).

Touche programmée d'accès direct

Cette méthode est utilisée uniquement pour faire des appels de groupe, individuel et téléphonique.

Vous pouvez attribuer uniquement un ID à une **touche d'accès direct** programmable avec un appui prolongé ou bref. Vous pouvez programmer plusieurs touches **d'accès direct** sur la radio.

Bouton programmable

Cette méthode est utilisée uniquement pour faire un appel téléphonique.

Bouton Volume/Canal

Cette méthode sélectionne manuellement un alias ou un ID d'abonné, ou un alias ou un ID de groupe.

Le voyant DEL passe au vert continu lorsque la radio est en cours de transmission et clignote en vert lorsque la radio est en cours de réception.



AVIS:

Le voyant DEL passe au vert continu durant la transmission d'un appel crypté et émet un clignotement double en vert durant la réception d'un appel crypté.

Pour décoder un appel crypté, votre radio doit être dotée de la même clé de confidentialité ou des mêmes valeurs et ID de clé (programmés par le détaillant) que la radio émettrice (la radio de laquelle vous recevez l'appel).

Pour obtenir plus de renseignements à ce sujet, consultez la section [Cryptage à la page 487](#).

Appels de groupe

Votre radio doit avoir été configurée comme faisant partie d'un groupe pour être en mesure de recevoir un appel provenant d'un groupe d'utilisateurs ou de passer un appel à un groupe d'utilisateurs.

Appels de groupe

Suivez la procédure suivante pour faire des appels de groupe à partir de la radio.

- 1 Faites un des suivants :
 - Sélectionnez le canal qui correspond à l'alias ou à l'ID de groupe.
 - Appuyez sur la touche d'**accès direct** programmée.

-
- 2 Pour passer l'appel, appuyez sur le bouton de conversation **PTT**.

Le voyant DEL vert s'allume. L'écran affiche l'icône **Appel de groupe** et l'alias du groupe.

-
- 3 Relâchez le bouton **PTT** pour écouter.

Le voyant DEL vert s'allume lorsque la radio cible répond. L'écran affiche l'icône **Appel de groupe**, et l'alias ou l'ID ainsi que l'alias ou l'ID de la radio émettrice.







-
- 4  Si l'indicateur Canal libre est activé, une courte tonalité d'avertissement se fait entendre lorsque

L'utilisateur de la radio émettrice cesse d'appuyer sur le bouton **PTT**, vous indiquant que le canal est libre et que vous pouvez répondre. Pour prendre l'appel, appuyez sur le bouton **PTT**.

L'appel se termine lorsqu'il n'y a aucune activité vocale pendant une durée préprogrammée. La radio revient à l'écran affiché avant la tentative d'appel.

Appels de groupe faits à l'aide de la liste de contacts

Suivez la procédure suivante pour passer des appels de groupe à l'aide de la liste de contacts à partir de la radio.

- 1 Appuyez sur  pour accéder au menu.
 - 2 Appuyez sur  ou  jusqu'à **Contacts**. Appuyez sur  pour effectuer la sélection.
 - 3 Appuyez sur  ou  jusqu'à l'alias ou l'ID voulu. Appuyez sur  pour effectuer la sélection.
-

- 4 Pour passer l'appel, appuyez sur le bouton de conversation **PTT**.

Le voyant DEL vert s'allume.

- 5 Relâchez le bouton **PTT** pour écouter.

Le voyant DEL vert clignote lorsqu'un utilisateur du groupe répond. L'écran affiche l'icône **Appel de groupe**, et l'alias ou l'ID ainsi que l'alias ou l'ID de la radio émettrice.

- 6  Si l'indicateur Canal libre est activé, une courte tonalité d'avertissement se fait entendre lorsque l'utilisateur de la radio émettrice cesse d'appuyer sur le bouton **PTT**, vous indiquant que le canal est libre et que vous pouvez répondre. Pour prendre l'appel, appuyez sur le bouton **PTT**.

L'appel se termine lorsqu'il n'y a aucune activité vocale pendant une durée préprogrammée.

Appels de groupe faits à l'aide de la touche numérique programmable

Suivez la procédure suivante pour passer des appels de groupe à l'aide de la touche numérique programmable.

- 1 À partir de l'écran d'accueil, appuyez longuement sur la touche numérique programmée jusqu'à l'alias ou à l'ID prédéfini.

Si une touche numérique a été attribuée à une entrée dans un mode particulier, la fonction n'est pas prise en charge lorsque vous appuyez longuement sur la touche numérique dans un autre mode.

Une tonalité d'échec se fait entendre si la touche numérique n'a pas été attribuée à une entrée.

- 2 Pour passer l'appel, appuyez sur le bouton de conversation **PTT**.

Le voyant DEL vert s'allume.

- 3 Relâchez le bouton **PTT** pour écouter.

Le voyant DEL vert clignote lorsqu'un utilisateur du groupe répond.

- 4  Si l'indicateur Canal libre est activé, une courte tonalité d'avertissement se fait entendre lorsque l'utilisateur de la radio émettrice cesse d'appuyer sur le bouton **PTT**, vous indiquant que le canal est libre et que vous pouvez répondre. Pour prendre l'appel, appuyez sur le bouton **PTT**.

L'appel se termine lorsqu'il n'y a aucune activité vocale pendant une durée préprogrammée. La radio revient à l'écran affiché avant la tentative d'appel.

Pour obtenir plus de renseignements à ce sujet, consultez la section [Association d'une entrée à une touche numérique programmable à la page 431](#).

Réponse à un appel de groupe



Pour être en mesure de recevoir un appel provenant d'un groupe d'utilisateurs, votre radio doit avoir été préalablement définie comme partie intégrante de ce groupe. Suivez la procédure suivante pour répondre à un appel de groupe sur votre radio.

Lorsque vous recevez un appel de groupe :

- Le voyant DEL vert clignote.

- L'icône **Appel de groupe** s'affiche dans le coin droit supérieur de l'écran.
- L'alias de l'appelant s'affiche sur la première ligne de l'écran.
- L'alias du groupe s'affiche sur la deuxième ligne de l'écran.
- Votre radio désactive la sourdine et l'appel entrant se fait entendre sur le haut-parleur.

1 Faites un des suivants :

-  Si l'indicateur Canal libre est activé, une courte tonalité d'avertissement se fait entendre lorsque l'utilisateur de la radio émettrice cesse d'appuyer sur le bouton **PTT**, vous indiquant que le canal est libre et que vous pouvez répondre. Pour prendre l'appel, appuyez sur le bouton **PTT**.
-  Si la fonction Interruption vocale est activée, appuyez sur le bouton **PTT** pour mettre interrompre le son sur la radio qui émet la transmission et libérer le canal afin de vous permettre de répondre.

Le voyant DEL vert s'allume.

2 Faites un des suivants :

- Attendez la fin de la tonalité d'autorisation de parler (si elle est activée) et parlez clairement dans le microphone.
 -  Attendez la fin de l'effet local **PTT** (s'il est activé) et parlez clairement dans le microphone.
-

3 Relâchez le bouton **PTT** pour écouter.

L'appel se termine lorsqu'il n'y a aucune activité vocale pendant une durée préprogrammée.

Si la radio affiche un écran autre que l'écran d'accueil et reçoit un appel de groupe, elle continue d'afficher l'écran sélectionné.

Appuyez longuement sur  pour retourner à l'écran d'accueil et afficher l'alias de l'appelant avant de répondre.

Appels privés

Un Appel individuel est un appel effectué à partir d'une radio individuelle vers une autre radio individuelle.

Il existe deux manières de configurer un appel individuel. Le premier type transmet l'appel après avoir effectué une

vérification de présence radio, tandis que le deuxième type transmet l'appel immédiatement. Un seul de ces types d'appels peut être programmé dans votre radio par votre détaillant.

Exécution d'un appel individuel

Votre radio doit avoir été préalablement programmée pour vous permettre de faire un appel individuel. Si cette fonction n'est pas activée, une tonalité d'indication négative se fait entendre lorsque vous lancez l'appel. Suivez la procédure suivante pour faire des appels privés à partir de la radio.

Servez-vous des fonctions de messagerie texte ou d'avertissement d'appel pour communiquer avec une radio individuelle. Pour plus d'informations, reportez-vous à la section [Messagerie texte à la page 161](#) ou [Fonction Avertissement d'appel à la page 443](#).

- 1 Faites un des suivants :
 - Sélectionnez un canal qui correspond à l'alias ou à l'ID d'abonné.
 - Appuyez sur la touche d'**accès direct** programmée.
-

- 2 Pour passer l'appel, appuyez sur le bouton de conversation **PTT**.

Le voyant DEL vert s'allume. L'écran affiche l'icône **Appel indiv.**, l'alias de l'abonné et l'état de l'appel.

- 3 Attendez la fin de la tonalité d'autorisation de parler (si elle est activée) et parlez clairement dans le microphone.
-

- 4 Relâchez le bouton **PTT** pour écouter.







Le voyant DEL vert clignote lorsque la radio cible répond.

- 5  Si l'indicateur Canal libre est activé, une courte tonalité d'avertissement se fait entendre lorsque l'utilisateur de la radio émettrice cesse d'appuyer sur le bouton **PTT**, vous indiquant que le canal est libre et que vous pouvez répondre. Pour prendre l'appel, appuyez sur le bouton **PTT**.

L'appel se termine lorsqu'il n'y a aucune activité vocale pendant une durée préprogrammée. Une tonalité se fait entendre. L'écran affiche **Appel terminé**.

Appels privés faits à l'aide de la liste de contacts

Suivez la procédure suivante pour passer des appels privés à l'aide de la liste de contacts à partir de la radio.

- 1 Appuyez sur  pour accéder au menu.
- 2 Appuyez sur  ou  jusqu'à Contacts. Appuyez sur  pour effectuer la sélection.
- 3 Appuyez sur  ou  jusqu'à l'alias ou l'ID voulu. Appuyez sur  pour effectuer la sélection.
- 4 Pour passer l'appel, appuyez sur le bouton de conversation **PTT**.
Le voyant DEL vert s'allume. L'écran affiche l'alias de destination.

5 Attendez la fin de la tonalité d'autorisation de parler (si elle est activée) et parlez clairement dans le microphone.

6 Relâchez le bouton **PTT** pour écouter.

Le voyant DEL vert clignote lorsque la radio cible répond. L'écran affiche l'alias ou l'ID de la radio émettrice.



7  Si l'indicateur Canal libre est activé, une courte tonalité d'avertissement se fait entendre lorsque l'utilisateur de la radio émettrice cesse d'appuyer sur le bouton **PTT**, vous indiquant que le canal est libre et que vous pouvez répondre. Pour prendre l'appel, appuyez sur le bouton **PTT**.



L'appel se termine lorsqu'il n'y a aucune activité vocale pendant une durée préprogrammée. Une tonalité se fait entendre. L'écran affiche Appel terminé.



Appels individuels faits à l'aide de la numérotation manuelle

Suivez la procédure suivante pour passer des appels privés à l'aide de la numérotation manuelle à partir de la radio.



- 1 Appuyez sur  pour accéder au menu.

- 2 Appuyez sur  ou  jusqu'à **Contacts**.
Appuyez sur  pour effectuer la sélection.

- 3 Appuyez sur  ou  jusqu'à **Num. manuelle**. Appuyez sur  pour effectuer la sélection.

- 4 Appuyez sur  ou  jusqu'au **Numéro de la radio**. Appuyez sur  pour effectuer la sélection.

- 5 Faites un des suivants :

- Entrez l'ID de l'abonné et appuyez sur  pour continuer.
- Modifier les ID d'abonné composés précédemment et appuyez sur  pour continuer.

-
- 6 Pour passer l'appel, appuyez sur le bouton de conversation **PTT**.
Le voyant DEL vert s'allume. L'écran affiche l'alias de destination.

 - 7 Attendez la fin de la tonalité d'autorisation de parler (si elle est activée) et parlez clairement dans le microphone.

 - 8 Relâchez le bouton **PTT** pour écouter.
Le voyant DEL vert s'allume lorsque la radio cible répond. L'écran affiche l'alias ou l'ID de la radio émettrice.

 - 9  Si l'indicateur Canal libre est activé, une courte tonalité d'avertissement se fait entendre lorsque l'utilisateur de la radio émettrice cesse d'appuyer sur

le bouton **PTT**, vous indiquant que le canal est libre et que vous pouvez répondre. Pour prendre l'appel, appuyez sur le bouton **PTT**.

L'appel se termine lorsqu'il n'y a aucune activité vocale pendant une durée préprogrammée. Une tonalité se fait entendre. L'écran affiche Appel terminé.

Appels individuels faits à l'aide de la touche numérique programmable

Suivez la procédure suivante pour passer des appels privés à l'aide de la touche numérique programmable.

- 1 À partir de l'écran d'accueil, appuyez longuement sur la touche numérique programmée jusqu'à l'alias ou à l'ID prédéfini.

Si une touche numérique a été attribuée à une entrée dans un mode particulier, la fonction n'est pas prise en charge lorsque vous appuyez longuement sur la touche numérique dans un autre mode.

Une tonalité d'échec se fait entendre si la touche numérique n'a pas été attribuée à une entrée.

- 2 Pour passer l'appel, appuyez sur le bouton de conversation **PTT**.

Le voyant DEL vert s'allume. L'écran affiche l'icône **Appel indiv.** dans le coin supérieur droit. L'alias de l'appelant s'affiche sur la première ligne de l'écran. L'état de l'appel s'affiche sur la deuxième ligne de l'écran.

- 3 Relâchez le bouton **PTT** pour écouter.

Le voyant DEL vert clignote lorsque la radio cible répond. L'écran affiche l'alias de destination.

- 4  Si l'indicateur Canal libre est activé, une courte tonalité d'avertissement se fait entendre lorsque l'utilisateur de la radio émettrice cesse d'appuyer sur le bouton **PTT**, vous indiquant que le canal est libre et que vous pouvez répondre. Pour prendre l'appel, appuyez sur le bouton **PTT**.

L'appel se termine lorsqu'il n'y a aucune activité vocale pendant une durée préprogrammée. Une tonalité se fait entendre. La radio revient à l'écran affiché avant la tentative d'appel.

Pour obtenir plus de renseignements à ce sujet, consultez la section [Association d'une entrée à une touche numérique programmable à la page 431](#).



Réponse à des appels individuels

Suivez la procédure suivante pour répondre à un Appel individuel sur votre radio.

Si vous recevez un Appel individuel :

- Le voyant DEL vert clignote.
- Votre radio désactive la sourdine et l'appel entrant se fait entendre sur le haut-parleur.

1 Faites un des suivants :

-  Si l'indicateur Canal libre est activé, une courte tonalité d'avertissement se fait entendre lorsque l'utilisateur de la radio émettrice cesse d'appuyer sur le bouton **PTT**, vous indiquant que le canal est libre et que vous pouvez répondre. Pour prendre l'appel, appuyez sur le bouton **PTT**.
-  Si l'interruption de transmission est activée, appuyez sur le bouton **PTT** pour mettre fin à un

appel interruptible afin de libérer le canal pour vous permettre de répondre.

Le voyant DEL vert s'allume.

2 Attendez la fin de la tonalité d'autorisation de parler (si elle est activée) et parlez clairement dans le microphone.

3 Relâchez le bouton **PTT** pour écouter.

L'appel se termine lorsqu'il n'y a aucune activité vocale pendant une durée préprogrammée.

Appels généraux

Un appel général est un appel effectué à partir d'une radio privé et destiné à toutes les radios présentes sur le canal. Un appel général sert à diffuser des annonces importantes qui sollicitent toute l'attention des utilisateurs. Les utilisateurs du canal ne peuvent pas répondre à un appel général.

Réception d'un appel général

Lorsque vous recevez un appel général :

- Une tonalité se fait entendre.
- Le voyant DEL vert clignote.
- L'icône **Appel de groupe** s'affiche dans le coin droit supérieur de l'écran.
- L'ID de l'appelant s'affiche sur la première ligne de l'écran.
- Appel général s'affiche sur la deuxième ligne de l'écran.
- Votre radio désactive la sourdine et l'appel entrant se fait entendre sur le haut-parleur.

À la fin de l'appel, la radio revient à l'écran affiché avant la réception de l'appel général.

Les appels généraux n'attendent pas pendant un temps prédéterminé avant de se terminer.

🔵 Si l'indicateur Canal libre est activé, une courte tonalité d'avertissement se fait entendre lorsque l'utilisateur de la radio émettrice cesse d'appuyer sur le bouton **PTT**, ce qui indique que le canal est libre et que vous pouvez répondre.

Vous ne pouvez pas répondre à un appel général.



AVIS:

La radio interrompt la réception de l'appel général si vous changez de canal pendant l'appel. Pendant un appel général, vous ne pouvez pas naviguer ni faire de changements tant que l'appel est en cours.

Appel général

Votre radio doit avoir été préalablement programmée pour vous permettre de faire un appel général. Suivez la procédure suivante pour faire des appels généraux à partir de la radio.

- 1 Sélectionnez le canal qui correspond à l'alias ou à l'ID de groupe Appel général en surbrillance.
-

- 2 Pour passer l'appel, appuyez sur le bouton de conversation **PTT**.

Le voyant DEL vert s'allume. L'écran affiche l'icône d'**appel de groupe** et Appel général.

- 3 Faites un des suivants :

- Attendez la fin de la tonalité d'autorisation de parler (si elle est activée) et parlez clairement dans le microphone.

-  Attendez la fin de l'effet local **PTT** (s'il est activé) et parlez clairement dans le microphone.

Les utilisateurs du canal ne peuvent pas répondre à l'appel général.

Appels généraux faits à l'aide de la touche numérique programmable

Suivez la procédure suivante pour passer des appels généraux à l'aide de la touche numérique programmable.

- 1 À partir de l'écran d'accueil, appuyez longuement sur la touche numérique programmée jusqu'à l'alias ou à l'ID prédéfini.

Si une touche numérique a été attribuée à une entrée dans un mode particulier, la fonction n'est pas prise en charge lorsque vous appuyez longuement sur la touche numérique dans un autre mode.

Une tonalité d'échec se fait entendre si la touche numérique n'a pas été attribuée à une entrée.

- 2 Pour passer l'appel, appuyez sur le bouton de conversation **PTT**.

Le voyant DEL vert s'allume.

- 3 Relâchez le bouton **PTT** pour écouter.

Le voyant DEL vert s'allume lorsque la radio cible répond. Vous ne pouvez pas répondre à un appel général en ce moment.

- 4  Si l'indicateur Canal libre est activé, une courte tonalité d'avertissement se fait entendre lorsque l'utilisateur de la radio émettrice cesse d'appuyer sur le bouton **PTT**, vous indiquant que le canal est libre et que vous pouvez répondre. Pour prendre l'appel, appuyez sur le bouton **PTT**.

L'appel se termine lorsqu'il n'y a aucune activité vocale pendant une durée préprogrammée. La radio revient à l'écran affiché avant la tentative d'appel. Lorsque l'appel individuel se termine, une courte tonalité retentit.

Pour obtenir plus de renseignements à ce sujet, consultez la section [Association d'une entrée à une touche numérique programmable](#) à la page 431.

Appels sélectifs

Un appel sélectif est un appel effectué à partir d'une radio individuelle vers une autre radio individuelle. Il s'agit d'un appel privé effectué en mode analogique.

Exécution d'un appel sélectif

Votre radio doit avoir été préalablement programmée pour vous permettre de faire un appel sélectif. Suivez la procédure suivante pour faire des appels sélectifs à partir de la radio.

1 Sélectionnez un canal qui correspond à l'alias ou à l'ID d'abonné.

2 Pour passer l'appel, appuyez sur le bouton de conversation **PTT**.

Le voyant DEL vert s'allume. L'écran affiche l'icône **Appel indiv.**, l'alias de l'abonné et l'état de l'appel.

3 Faites un des suivants :

- Attendez la fin de la tonalité d'autorisation de parler (si elle est activée) et parlez clairement dans le microphone.

-  Attendez la fin de l'effet local **PTT** (s'il est activé) et parlez clairement dans le microphone.
-

4 Relâchez le bouton **PTT** pour écouter.

Le voyant DEL vert s'allume lorsque la radio cible répond.

5  Si l'indicateur Canal libre est activé, une courte tonalité d'avertissement se fait entendre lorsque l'utilisateur de la radio émettrice cesse d'appuyer sur le bouton **PTT**, vous indiquant que le canal est libre et que vous pouvez répondre. Pour prendre l'appel, appuyez sur le bouton **PTT**.

L'appel se termine lorsqu'il n'y a aucune activité vocale pendant une durée préprogrammée.

6 L'écran affiche Appel terminé.

Réponse à un appel sélectif

Suivez la procédure suivante pour répondre à un appel sélectif sur votre radio.

Si vous recevez un appel sélectif :

- Le voyant DEL vert clignote.

- La première ligne de texte affiche l'icône **Appel indiv.** et l'alias de l'appelant ou Appel sélectif ou Avert. avec appel.

- Votre radio désactive la sourdine et l'appel entrant se fait entendre sur le haut-parleur.

1 Pour prendre l'appel, appuyez sur le bouton **PTT**.

Le voyant DEL vert s'allume.

2 Attendez la fin de la tonalité d'autorisation de parler (si elle est activée) et parlez clairement dans le microphone.

3 Relâchez le bouton **PTT** pour écouter.

L'appel se termine lorsqu'il n'y a aucune activité vocale pendant une durée préprogrammée. Une tonalité se fait entendre. L'écran affiche Appel terminé.

Si la fonction Appel téléphonique n'est pas activée sur votre radio :

- L'écran affiche Non disponible.
- Votre radio désactive le son de l'appel.
- Lorsque l'appel prend fin, la radio revient à l'écran où vous étiez avant de faire l'appel.

Lors de votre appel téléphonique, votre radio tente de mettre fin à l'appel lorsque :

- Vous appuyez sur la **touche d'accès direct** si le code de nonaccès est préconfiguré.
- Vous entrez le code de nonaccès comme entrée pour les autres chiffres.

Durant l'accès aux canaux, la transmission du code d'accès ou de retrait d'accès ou de chiffres supplémentaires, votre radio répond à la touche **Activé/désactivé**, du **Réglage du volume** et du **sélecteur de canal** seulement. Une tonalité se fait entendre pour toutes les entrées non valides.

Pendant un accès à un canal, appuyez sur  pour mettre fin à la tentative d'appel. Une tonalité se fait entendre.

Appels téléphoniques

Un appel téléphonique est un appel effectué à partir d'une radio individuelle vers un téléphone.



AVIS:

Le code d'accès ou de non-accès ne peut dépasser 10 caractères.

Pour obtenir des renseignements supplémentaires, adressez-vous à votre détaillant ou à votre administrateur de système.

Exécution d'un appel téléphonique

Suivez la procédure suivante pour faire des appels téléphoniques à partir de la radio.

- 1 Appuyez sur la touche programmée d'**accès direct** à l'alias ou à l'ID prédéfini.

Si la touche d'**accès direct** n'est pas programmée, une tonalité d'échec se fait entendre. Si le code d'accès n'est pas préconfiguré dans la liste de contacts, l'écran affiche le message Code d'accès :.

- 2 Entrez le code d'accès, puis appuyez sur  pour continuer.

Le code d'accès ou de non-accès ne peut dépasser 10 caractères.

- 3 Pour prendre l'appel, appuyez sur le bouton **PTT**. Relâchez le bouton **PTT** pour écouter.

- 4 Saisissez des chiffres supplémentaires à l'aide du clavier si l'appel le demande et appuyez sur  pour continuer.

Si l'appel se termine pendant que vous entrez les autres chiffres demandés par l'appel, la radio revient à l'écran affiché avant la tentative d'appel.

La multifréquence à deux tonalités (DTMF) se fait entendre. La radio revient à l'écran précédent.

- 5 Appuyez sur  pour mettre fin à l'appel.

- 6 Faites un des suivants :

- Si le code de non-accès n'est pas préconfiguré, entrez le code de non-accès lorsque l'écran affiche Code de non-accès :, puis appuyez sur  pour continuer. La radio revient à l'écran précédent.
- Appuyez sur la touche d'**accès direct** programmée.

Si la touche d'**accès direct** n'est pas programmée, une tonalité d'échec se fait entendre.

La tonalité DTMF se fait entendre et l'écran affiche
Fin de l'appel téléphonique.

Si l'appel se termine avec succès :



- Une tonalité se fait entendre.
- L'écran affiche Appel terminé.

Si l'appel échoue, la radio revient à l'écran d'appel téléphonique. Répétez les deux dernières étapes qui précèdent ou attendez que l'utilisateur du téléphone mette fin à l'appel.

Appels téléphoniques faits à l'aide de la liste de contacts

Suivez la procédure suivante pour passer des appels téléphoniques à l'aide de la liste de contacts à partir de la radio.

- 1 Appuyez sur  pour accéder au menu.

- 2 Appuyez sur  ou  jusqu'à Contacts.

Appuyez sur  pour effectuer la sélection.

L'écran affiche les entrées dans l'ordre alphabétique.



- 3 Appuyez sur  ou  jusqu'à l'alias ou l'ID voulu. Appuyez sur  pour effectuer la sélection.

Lorsque vous appuyez sur le bouton **PTT** pendant que vous êtes sur l'écran Contacts téléphoniques :

- La première ligne de l'écran affiche le message Numéro de téléphone :.
- La deuxième ligne de l'écran affiche un curseur clignotant.

Si l'entrée sélectionnée est vide :

- Une tonalité d'échec se fait entendre.
- L'écran affiche No d'appel téléphonique non valide.

4 Appuyez sur  ou  jusqu'à Appeler.

Appuyez sur  pour effectuer la sélection.

L'écran affiche Code d'accès : si le code d'accès n'est pas préconfiguré.

5 Entrez le code d'accès, puis appuyez sur  pour continuer.

Le code d'accès ou de nonaccès ne peut dépasser 10 caractères.

La première ligne de l'écran affiche En appel La deuxième ligne de l'écran affiche l'alias ou l'ID d'abonné et l'icône **Appel téléphonique**.

Si l'appel est réussi :

- La tonalité DTMF se fait entendre.
- Vous entendrez la tonalité de composition du téléphone de l'utilisateur.
- La première ligne de l'écran affiche l'alias ou l'ID d'abonné et l'icône **RSSI**.
- La deuxième ligne affiche Appel téléphonique et l'icône **Appel téléphonique**.

Si l'appel n'est pas réussi :

- Une tonalité se fait entendre.
 - L'écran affiche Échec de l'appel téléphonique, puis, Code d'accès :.
 - Si le code d'accès a été préconfiguré dans la liste de contacts, la radio revient à l'écran précédant la tentative d'appel.
-

6 Pour prendre l'appel, appuyez sur le bouton **PTT**.
L'icône **RSSI** disparaît.

7 Relâchez le bouton **PTT** pour écouter.

8 Saisissez des chiffres supplémentaires à l'aide du clavier si l'appel le demande et appuyez sur  pour continuer.
Si l'appel se termine pendant que vous entrez les autres chiffres demandés par l'appel téléphonique, la radio revient à l'écran affiché avant la tentative d'appel.

La tonalité DTMF se fait entendre. La radio revient à l'écran précédent.

9 Appuyez sur  pour mettre fin à l'appel.

10 Si le code de nonaccès n'est pas préconfiguré, entrez le code de nonaccès lorsque l'écran affiche

Code de nonaccès :, puis appuyez sur  pour continuer.

La radio revient à l'écran précédent. La tonalité DTMF se fait entendre et l'écran affiche Fin de l'appel téléphonique.

Si l'appel se termine avec succès :

- Une tonalité se fait entendre.
- L'écran affiche Appel terminé.

Si l'appel échoue, la radio revient à l'écran d'appel téléphonique. Répétez [étape 9](#) et [étape 10](#) ou attendez que l'utilisateur du téléphone ait terminé l'appel. Quand vous appuyez sur la touche **PTT** à l'écran Contacts tél, une tonalité se fait entendre et l'écran affiche le message App. OK pour placer appel.

Lorsque l'utilisateur a terminé d'utiliser le téléphone, une tonalité se fait entendre et l'écran affiche le message Fin appel tél.

Si l'appel se termine pendant que vous entrez les autres chiffres demandés par l'appel téléphonique, la radio revient à l'écran affiché avant la tentative d'appel.



AVIS:

Pendant un accès à un canal, appuyez sur  pour mettre fin à la tentative d'appel (une tonalité se fait entendre).

Pendant l'appel, lorsque vous appuyez sur la touche **Accès une touche**, si le code de nonaccès est préconfiguré ou si vous entrez le code de nonaccès en entrée pour les autres chiffres, la radio tentera de mettre fin à l'appel.

Pendant l'accès à un canal, à un code d'accès/de libération ou encore lors d'une transmission d'autres chiffres, seuls les boutons **Marche/Arrêt**, **Réglage du volume** et le **sélecteur de canal** sont actifs.

Une tonalité se fait entendre pour toutes les entrées non valides.

Appels téléphoniques faits à l'aide de la numérotation manuelle

Suivez la procédure suivante pour passer des appels téléphoniques à l'aide de la numérotation manuelle à partir de la radio.



1 Appuyez sur  pour accéder au menu.

2 Appuyez sur  ou  jusqu'à

Contacts. Appuyez sur  pour effectuer la sélection.

3 Appuyez sur  ou  jusqu'à Num.

manuelle. Appuyez sur  pour effectuer la sélection.

4 Appuyez sur  ou  jusqu'au Numéro de téléphone. Appuyez sur  pour effectuer la sélection.

L'écran affiche Numéro : et un curseur clignotant.

5 Saisissez le numéro de téléphone, puis appuyez sur  pour continuer.

L'écran affiche Code d'accès : et un curseur clignotant si le code d'accès n'est pas préconfiguré.

6 Entrez le code d'accès, puis appuyez sur  pour continuer.

Le code d'accès ou de non-accès ne peut dépasser 10 caractères.

7 Le voyant DEL vert s'allume. L'écran affiche l'icône **Appel téléphonique** dans le coin supérieur droit. L'alias de l'abonné s'affiche sur la première ligne de l'écran. L'état de l'appel s'affiche sur la deuxième ligne de l'écran. Si l'appel est réussi :

- La tonalité DTMF se fait entendre.
- Vous entendrez la tonalité de composition du téléphone de l'utilisateur.
- L'alias de l'abonné s'affiche sur la première ligne de l'écran.

- L'écran continue d'afficher l'icône **Appel téléphonique** dans le coin supérieur droit.

Si l'appel n'est pas réussi :

- Une tonalité se fait entendre.
- L'écran affiche Échec de l'appel téléphonique, puis, Code d'accès :.
- Si le code d'accès a été préconfiguré dans la liste de contacts, la radio revient à l'écran précédant la tentative d'appel.

8 Appuyez sur  pour mettre fin à l'appel.

9 Faites un des suivants :

- Si le code de non-accès n'est pas préconfiguré, entrez le code de non-accès lorsque l'écran affiche Code de non-accès :, puis appuyez sur

 pour continuer.

La radio revient à l'écran précédent.

- Appuyez sur la touche d'**accès direct** programmée.

Si la touche d'**accès direct** n'est pas programmée, une tonalité d'échec se fait entendre.

La tonalité DTMF se fait entendre et l'écran affiche Fin de l'appel téléphonique.

Si l'appel se termine avec succès :

- Une tonalité se fait entendre.
- L'écran affiche Appel terminé.

Si l'appel échoue, la radio revient à l'écran d'appel téléphonique. Répétez [étape 8](#) ou attendez que l'utilisateur du téléphone mette fin à l'appel.



AVIS:

Quand vous appuyez sur la touche **PTT** lorsque vous êtes dans l'écran de contacts, une tonalité de réussite se fait entendre et l'écran affiche le message Appuyez sur OK pour placer appel.

Lorsque l'utilisateur a terminé d'utiliser le téléphone, une tonalité de réussite se fait entendre et l'écran affiche le message Appel terminé.

Si l'appel se termine pendant que vous entrez les autres chiffres demandés par l'appel téléphonique, la radio revient à l'écran affiché avant la tentative d'appel.

Pendant un accès à un canal, appuyez sur





 pour mettre fin à la tentative d'appel (une tonalité se fait entendre).









Pendant l'appel, lorsque vous appuyez sur la touche d'**accès direct**, si le code de non-accès est préconfiguré ou si vous entrez le code de non-accès en entrée pour les autres chiffres, la radio tentera de mettre fin à l'appel.

Pendant l'accès à un canal, à un code d'accès/de libération ou encore lors d'une transmission d'autres chiffres, seuls les boutons **Marche/Arrêt**, **Réglage du volume** et le **sélecteur de canal** sont actifs. Une tonalité se fait entendre pour toutes les entrées non valides.



Pour passer des appels de groupe, individuels, téléphoniques ou généraux à l'aide de la recherche d'alias

Suivez la procédure suivante pour passer n'importe quel type d'appel à l'aide de la recherche d'alias.

- 1 Appuyez sur  pour accéder au menu.
-
- 2 Appuyez sur  ou  jusqu'à **Contacts**.
Appuyez sur  pour effectuer la sélection.
L'écran affiche les entrées dans l'ordre alphabétique.
-

- 3 Appuyez sur  ou  jusqu'à l'alias ou l'ID d'abonné voulu. La première ligne de l'écran affiche le message Numéro de téléphone :. La deuxième ligne de l'écran affiche un curseur clignotant. Utilisez le clavier pour entrer un numéro de téléphone.
-
- 4 Appuyez sur  pour effectuer la sélection. Si l'entrée sélectionnée est vide, une tonalité d'indication négative se fait entendre et l'écran indique No. Tél. Invalide.
-
- 5 Appuyez sur  ou  pour un appel téléphonique, puis sur Appuyez sur  pour effectuer la sélection.. Si le code d'accès n'est pas préconfiguré dans la liste de contacts, la première ligne de l'écran indique Code d'accès :. La deuxième ligne de l'écran affiche un curseur clignotant. Entrez le code d'accès, puis appuyez sur  pour continuer. En cas de réussite, la tonalité DTMF se fait entendre. Vous entendrez la tonalité de composition du téléphone de l'utilisateur. La première ligne de l'écran affiche l'alias ou l'ID d'abonné et l'icône RSSI. La deuxième ligne de
- l'écran affiche Appel tél. et l'icône d'appel téléphonique. En cas d'échec, une tonalité se fait entendre et l'écran affiche le message Appel tél. échoué. Votre radio retourne à l'écran de code d'accès. Si le code d'accès est préconfiguré dans la liste de contacts, la radio revient à l'écran affiché avant la tentative d'appel.
-
- 6 Appuyez sur la touche **PTT** pour parler et relâchez la touche pour écouter. L'icône RSSI disparaît lors de la transmission.
-
- 7 Pour entrer d'autres chiffres, si demandé durant l'appel, procédez de l'une des façons suivantes.
- Appuyez sur n'importe quelle touche pour commencer à entrer de nouveaux chiffres. La première ligne de l'écran affiche le message Chiffres suppl. :. La deuxième ligne de l'écran affiche un curseur clignotant. Entrez les chiffres supplémentaires, puis appuyez sur  pour continuer. La tonalité DTMF se fait entendre et la radio revient à l'écran précédent.
 - Appuyez sur la touche d'**accès direct**. La tonalité DTMF se fait entendre. Si la touche d'**accès**



direct n'est pas programmée, une tonalité d'échec se fait entendre.

- 8 Appuyez sur  pour mettre fin à l'appel. Si le code de libération n'est pas préconfiguré dans la liste de contacts, la première ligne de l'écran indique Code de libération :. La deuxième ligne de l'écran affiche un curseur clignotant. Entrez le code de libération, puis appuyez sur  pour continuer. La radio revient à l'écran précédent. La tonalité DTMF se fait entendre et l'écran affiche Fin de l'appel tél.. En cas de réussite, une tonalité se fait entendre et l'écran affiche le message Appel tél. terminé. Votre radio retourne à l'écran d'appel téléphonique. En cas d'échec, votre radio retourne à l'écran d'appel téléphonique. Quand vous appuyez sur la touche **PTT** à l'écran Contacts tél, une tonalité se fait entendre et l'écran affiche le message App. OK pour placer appel. Lorsque l'utilisateur a terminé d'utiliser le téléphone, une tonalité se fait entendre et l'écran affiche le message Fin appel tél.. Si l'appel se termine pendant que vous entrez les autres chiffres demandés par l'appel téléphonique, la radio revient à l'écran affiché avant la tentative d'appel.
-



AVIS:

Pendant l'accès à un canal, appuyez sur  pour mettre fin à la tentative d'appel et une tonalité se fait entendre ou pour quitter la recherche d'alias.

Appuyez sur  ou  pour quitter la recherche d'alias. Pendant l'appel, lorsque vous appuyez sur la touche d'**accès direct**, si le code de non-accès est préconfiguré ou si vous entrez le code de non-accès en entrée pour les autres chiffres, la radio tentera de mettre fin à l'appel. Pendant l'accès à un canal, à un code d'accès/de libération ou encore lors d'une transmission d'autres chiffres, seuls les boutons Marche/Arrêt, Réglage du volume et le sélecteur de canal sont actifs. Une tonalité se fait entendre pour toutes les entrées non valides.

Multifréquence à deux tonalités

La fonction Multifréquence à deux tonalités (DTMF) permet d'utiliser un système radio doté d'une interface de système téléphonique.

Vous pouvez désactiver la tonalité DTMF en désactivant toutes les tonalités et alertes de la radio. Pour obtenir plus de renseignements à ce sujet, consultez la section



Activation ou désactivation des sonneries et alertes de la radio à la page 215.

Exécution d'un appel DTMF

Suivez la procédure suivante pour faire des appels DTMF à partir de la radio.

1 Maintenez le bouton de transmission **PTT** enfoncé.

2 Faites un des suivants :

- Entrez le numéro voulu pour faire un appel DTMF.
 - Appuyez sur  pour faire un appel DTMF.
 - Appuyez sur  pour faire un appel DTMF.
-

Réponse à un appel téléphonique en mode appel de groupe

Suivez la procédure suivante pour répondre à un appel téléphonique en mode appel de groupe sur votre radio.

Si vous recevez un appel téléphonique en tant qu'appel de groupe :

- L'écran affiche l'icône **Appel téléphonique** dans le coin supérieur droit.
- L'écran affiche l'alias du groupe et Appel tél.

Si la fonctionnalité d'appel téléphonique n'est pas activée, la première ligne de l'écran affiche Indisponible, et votre radio met les appels en sourdine. Lorsque l'appel prend fin, la radio revient à l'écran où vous étiez avant de faire l'appel.

1 Pour prendre l'appel, appuyez sur le bouton **PTT**. Relâchez le bouton **PTT** pour écouter.

2 Appuyez sur  pour mettre fin à l'appel.

L'écran affiche Fin de l'appel tél..

Si l'appel se termine avec succès :

- Une tonalité se fait entendre.
- L'écran affiche Appel terminé.

Si l'appel échoue, la radio revient à l'écran d'appel téléphonique. Répétez l'étape ou attendez que l'utilisateur du téléphone mette fin à l'appel.

Réponse à un appel téléphonique en mode appel général

Lorsque vous recevez un appel téléphonique en mode appel général, vous ne pouvez y répondre ou y mettre fin que si le canal est du type appel général. Suivez la procédure suivante pour répondre à un appel téléphonique en mode appel général sur votre radio.

Si vous recevez un appel téléphonique en tant qu'appel général :

- L'écran affiche l'icône **Appel téléphonique** dans le coin supérieur droit.
- L'écran affiche Appel général et Appel tél.

Si la fonctionnalité d'appel téléphonique n'est pas activée, la première ligne de l'écran affiche Indisponible, et votre radio met les appels en sourdine.

Lorsque l'appel prend fin, la radio revient à l'écran où vous étiez avant de faire l'appel.

1 Pour prendre l'appel, appuyez sur le bouton **PTT**.

2 Relâchez le bouton **PTT** pour écouter.

3 Appuyez sur  pour mettre fin à l'appel.

L'écran affiche Fin de l'appel tél..

Si l'appel se termine avec succès :

- Une tonalité se fait entendre.
- L'écran affiche Appel général et Appel terminé.

Si l'appel échoue, la radio revient à l'écran d'appel téléphonique. Répétez [étape 3](#) ou attendez que l'utilisateur du téléphone mette fin à l'appel.

Réponse à un appel téléphonique en mode Appel individuel

Suivez la procédure suivante pour répondre à un appel téléphonique en mode Appel individuel sur votre radio.

Si vous recevez un appel téléphonique en tant qu'appel individuel :

- L'écran affiche l'icône **Appel téléphonique** dans le coin supérieur droit.
- L'écran affiche l'alias de l'appelant ou Appel tél.

Si la fonctionnalité d'appel téléphonique n'est pas activée, la première ligne de l'écran affiche `Indisponible`, et votre radio met les appels en sourdine. Lorsque l'appel prend fin, la radio revient à l'écran où vous étiez avant de faire l'appel.

- 1 Pour prendre l'appel, appuyez sur le bouton **PTT**. Relâchez le bouton **PTT** pour écouter.

- 2 Appuyez sur  pour mettre fin à l'appel.

L'écran affiche `Fin de l'appel tél..`

Si l'appel se termine avec succès :

- Une tonalité se fait entendre.
- L'écran affiche `Appel terminé.`

Si l'appel échoue, la radio revient à l'écran d'appel téléphonique. Répétez l'étape ou attendez que l'utilisateur du téléphone mette fin à l'appel.

Interruption d'un appel radio

La fonction vous permet de mettre fin à un appel de groupe ou à un appel individuel afin de libérer le canal pour une transmission. Par exemple, lorsque le microphone de la

radio est bloqué, parce que le bouton **PTT** a été enfoncé par inadvertance. Votre radio doit être programmée de manière à vous permettre d'utiliser cette fonction. Suivez la procédure suivante pour mettre fin à un appel sur votre radio.

- 1 Appuyez sur la touche programmée **Interruption de transmission**.

L'écran affiche `Interruption`.

- 2 Attendez la confirmation.

En cas de réussite :

- Une tonalité de réussite se fait entendre.
- L'écran affiche `Interruption réussie.`

En cas d'échec :

- Une tonalité d'échec se fait entendre.
- L'écran affiche `Échec de l'interruption.`



AVIS:

Pour obtenir des renseignements supplémentaires, adressez-vous à votre détaillant ou à votre administrateur de système.

Mode Direct

Cette fonction vous permet de continuer de communiquer lorsque votre répéteur ne fonctionne pas ou lorsque la radio est hors de la portée du répéteur, mais demeure à la portée des autres radios.

Ce réglage demeure activé même après la mise hors tension.



AVIS:

Cette fonction ne s'applique pas aux canaux Capacity Plus – site unique, Capacity Plus – multi-site et Bandes citoyennes qui se trouvent dans la même fréquence.

Basculement entre les modes Répéteur et Direct

Suivez la procédure pour alterner entre les modes Répéteur et Direct sur votre radio.

1 Faites un des suivants :

- Appuyez sur le bouton programmé **Repeater/Talkaround**. Ignorez les étapes suivantes.



- Appuyez sur  pour accéder au menu.

2 Appuyez sur  ou  jusqu'à

Utilitaires.Appuyez sur  pour effectuer la sélection.

3 Appuyez sur  ou  jusqu'au Paramètres

de la radio.Appuyez sur  pour effectuer la sélection.

4 Appuyez sur  ou  jusqu'à Direct.

Appuyez sur  pour effectuer la sélection.

Si la fonction est activée, ✓ apparaît à côté d'Activé.

Si cette option est désactivée, le ✓ ne s'affiche plus à côté de Activé.

L'écran revient automatiquement au menu précédent.

Fonctions avancées

Ce chapitre décrit le fonctionnement des fonctions disponibles sur votre radio.

Cependant, votre détaillant ou l'administrateur de votre système peut avoir personnalisé votre radio en fonction de vos besoins particuliers. Pour obtenir des renseignements supplémentaires, adressez-vous à votre détaillant ou à votre administrateur de système.

Rappel du canal d'accueil

Cette fonction permet d'émettre un rappel si la radio n'est pas réglée sur le canal d'accueil pendant un certain temps.

Si cette fonction est activée via le CPS lorsque la radio n'est pas réglée sur le canal d'accueil pendant un certain temps, voici ce qui se produit périodiquement :

- La tonalité de Rappel de canal d'accueil et l'annonce sonore retentissent.
- La première ligne de l'écran affiche le message Non.
- La deuxième ligne affiche Canal d'accueil.

Vous pouvez interrompre la diffusion du rappel en effectuant l'une des actions suivantes :

- Retourner au canal d'accueil.
- Mettre temporairement en sourdine l'avertissement à l'aide du bouton programmable.
- Définir un nouveau canal d'accueil à l'aide du bouton programmable.

Mettre en sourdine le rappel du canal d'accueil

Lorsque survient le rappel du canal d'accueil, vous pouvez le mettre en sourdine.

Appuyez sur la touche programmée **Rappel du canal d'accueil en sourdine**.



La première ligne de l'écran affiche HCR et la deuxième en sourdine.



Réglage de nouveaux canaux d'accueil



Lorsque le rappel du canal d'accueil retentit, vous pouvez définir un nouveau canal d'accueil.





- 1 Faites un des suivants :

- Appuyez sur la touche programmable **Réinitialiser canal d'accueil** pour régler le canal courant comme nouveau canal d'accueil. Ignorez les étapes suivantes.
La première ligne de l'écran affiche l'alias du canal et la deuxième `Nouv. canal acc.`
- Appuyez sur  pour accéder au menu.

2 Appuyez sur  ou  jusqu'à Utilitaires. Appuyez sur  pour effectuer la sélection.

3 Appuyez sur  ou  jusqu'au Paramètres de la radio. Appuyez sur  pour effectuer la sélection.

4 Appuyez sur  ou  jusqu'à Canal d'accueil. Appuyez sur  pour effectuer la sélection.

- 5 Appuyez sur  ou  jusqu'à l'alias du nouveau canal d'accueil. Appuyez sur  pour effectuer la sélection.
L'écran affiche  à côté de l'alias de canal d'accueil sélectionné.



Vérification de la radio

La fonction Vérification de la radio vous permet de déterminer si une autre radio est en fonction au sein d'un système, sans importuner l'utilisateur de cette radio. Aucune notification sonore ou visuelle ne se manifeste sur la radio cible. Cette fonction n'est offerte que pour les alias ou ID d'abonné. Votre radio doit être programmée de manière à vous permettre d'utiliser cette fonction.

Envoi des vérifications radio

Suivez la procédure suivante pour envoyer des vérifications radio à partir de votre radio.

- 1 Appuyez sur la touche programmée **Vérif. radio**.

- 2 Appuyez sur  ou  jusqu'à l'alias ou l'ID voulu. Appuyez sur  pour effectuer la sélection. L'écran affiche un bref avis indiquant que l'exécution de la requête est en cours. Le voyant DEL vert s'allume.

Attendez la confirmation.

Si vous appuyez sur  pendant l'attente de confirmation, une tonalité se fait entendre, la radio met fin à toutes les tentatives et quitte le mode de vérification de radio.

En cas de réussite :

- Une tonalité de réussite se fait entendre.
- L'écran affiche un bref avis de réussite.











En cas d'échec :

- Une tonalité d'échec se fait entendre.
- L'écran affiche un bref avis d'échec.



La radio revient à l'écran d'alias ou d'ID d'abonné.

Envoi des vérifications radio à l'aide de la numérotation manuelle

Suivez la procédure suivante pour envoyer les vérifications de radio à l'aide de la numérotation manuelle.

- 1 Appuyez sur  pour accéder au menu.
- 2 Appuyez sur  ou  jusqu'à Contacts. Appuyez sur  pour effectuer la sélection.
- 3 Appuyez sur  ou  jusqu'à Num. manuelle. Appuyez sur  pour effectuer la sélection.
- 4 Appuyez sur  ou  jusqu'au Numéro de la radio. Appuyez sur  pour effectuer la sélection.
- 5 Faites un des suivants :
 - Entrez l'ID ou l'alias de l'abonné et appuyez sur  pour continuer.

- Modifiez les ID composés précédemment et appuyez sur  pour continuer.

6 Appuyez sur  ou  jusqu'à Vérifications de radio. Appuyez sur  pour effectuer la sélection.

L'écran affiche un bref avis indiquant que l'exécution de la requête est en cours. Le voyant DEL vert s'allume.

7 Attendez la confirmation.

Si vous appuyez sur  pendant l'attente de confirmation, une tonalité se fait entendre, puis la radio met fin aux tentatives et quitte le mode de vérification de radio.

En cas de réussite :

- Une tonalité de réussite se fait entendre.
- L'écran affiche un bref avis de réussite.

En cas d'échec :

- Une tonalité d'échec se fait entendre.

- L'écran affiche un bref avis d'échec.
La radio revient à l'écran d'alias ou d'ID d'abonné.

Écoute à distance

Cette fonction est utilisée pour activer le microphone d'une radio cible avec un alias ou un ID d'abonné. Vous pouvez utiliser cette fonction pour écouter à distance toute activité audible entourant la radio cible.

Votre radio et la radio cible doivent être programmées de manière à vous permettre d'utiliser cette fonction.

Cette fonction s'arrête après une durée programmée ou dès qu'une fonction de la radio cible est utilisée.

Lancer la fonction Écoute ambiance

Suivez la procédure pour activer la fonction de surveillance à distance sur votre radio.

- 1 Appuyez sur la touche programmée **Écoute à distance**.

2 Appuyez sur  ou  jusqu'à l'alias ou l'ID voulu.

3 Appuyez sur  pour effectuer la sélection.
L'écran affiche un bref avis indiquant que l'exécution de la requête est en cours. Le voyant DEL vert s'allume.

4 Attendez la confirmation.

En cas de réussite :

- Une tonalité de réussite se fait entendre.
- L'écran affiche un bref avis de réussite.
- L'écoute des sons ambiants de la radio surveillée commence pour la durée programmée et l'écran affiche *Écoute à distance*. Lorsque la minuterie s'arrête, une tonalité d'avertissement est émise et le voyant DEL s'éteint.



En cas d'échec :



- Une tonalité d'échec se fait entendre.
 - L'écran affiche un bref avis d'échec.
-



Activation de l'Écoute ambiance à l'aide de la liste de contacts

Suivez la procédure suivante pour activer la fonction d'écoute à distance à l'aide de la liste de contacts de la radio.

1 Appuyez sur  pour accéder au menu.

2 Appuyez sur  ou  jusqu'à *Contacts*.
Appuyez sur  pour effectuer la sélection.

3 Appuyez sur  ou  jusqu'à l'alias ou l'ID voulu. Appuyez sur  pour effectuer la sélection.

4 Appuyez sur  ou  jusqu'à *Écoute à distance*

- 5 Appuyez sur  pour effectuer la sélection.
L'écran affiche un bref avis indiquant que l'exécution de la requête est en cours. Le voyant DEL vert s'allume.
-

- 6 Attendez la confirmation.

En cas de réussite :











- Une tonalité de réussite se fait entendre.
- L'écran affiche un bref avis de réussite.
- L'écoute des sons ambiants de la radio surveillée commence pour la durée programmée et l'écran affiche Écoute à distance. Lorsque la minuterie s'arrête, une tonalité d'avertissement est émise et le voyant DEL s'éteint.

En cas d'échec :



- Une tonalité d'échec se fait entendre.
 - L'écran affiche un bref avis d'échec.
-

Activation de l'écoute à distance à l'aide de la numérotation manuelle

Suivez la procédure suivante pour activer la fonction d'écoute à distance à l'aide de la numérotation manuelle.

- 1 Appuyez sur  pour accéder au menu.
-
- 2 Appuyez sur  ou  jusqu'à Contacts.
Appuyez sur  pour effectuer la sélection.
-
- 3 Appuyez sur  ou  jusqu'à Num. manuelle. Appuyez sur  pour effectuer la sélection.
-
- 4 Appuyez sur  ou  jusqu'au Numéro de la radio. Appuyez sur  pour effectuer la sélection.
-
- 5 Faites un des suivants :
- Entrez l'ID ou l'alias de l'abonné et appuyez sur  pour continuer.

- Modifiez les ID composés précédemment et appuyez sur  pour continuer.

6 Appuyez sur  ou  jusqu'à Écoute à distance

7 Appuyez sur  pour effectuer la sélection.
L'écran affiche un bref avis indiquant que l'exécution de la requête est en cours. Le voyant DEL vert s'allume.

8 Attendez la confirmation.

En cas de réussite :

- Une tonalité de réussite se fait entendre.
- L'écran affiche un bref avis de réussite.
- L'écoute des sons ambiants de la radio surveillée commence pour la durée programmée et l'écran affiche Écoute à distance. Lorsque la minuterie s'arrête, une tonalité d'avertissement est émise et le voyant DEL s'éteint.

En cas d'échec :

- Une tonalité d'échec se fait entendre.
- L'écran affiche un bref avis d'échec.

Listes de balayage

Les listes de balayage sont créées et attribuées à des canaux ou à des groupes. Votre radio recherche l'activité vocale en passant par le cycle complet de la séquence de canaux et de groupes définie dans la liste de balayage du canal ou du groupe actuel.

Votre radio prend en charge jusqu'à 250 listes de balayage, chacune pouvant comprendre jusqu'à 16 membres.

Chaque liste de balayage peut comprendre des entrées analogiques et des entrées numériques.

Lorsque vous modifiez une liste de balayage, vous pouvez ajouter ou supprimer des canaux ou en établir l'ordre de priorité.

Il vous est également possible de joindre une nouvelle liste de balayage à l'aide de la fonction de programmation du clavier. Pour obtenir plus de renseignements à ce sujet, consultez la section [Configuration du panneau avant à la page 207](#).

L'icône **Priorité** s'affiche à gauche de l'alias du membre, s'il est défini, pour indiquer si le membre fait partie d'une liste de canaux de Priorité 1 ou de Priorité 2. Vous ne pouvez pas avoir plusieurs canaux de Priorité 1 ou de Priorité 2 dans une liste de balayage. Aucune icône **Priorité** ne s'affiche si le réglage de la priorité est **Aucun**.







AVIS:

Cette fonction n'est pas offerte en mode Capacity Plus.

Affichage d'une entrée de la liste de balayage

Suivez la procédure suivante pour afficher des entrées de la liste de balayage sur votre radio.





- 1 Appuyez sur  pour accéder au menu.
- 2 Appuyez sur  ou  jusqu'à Balayer.
Appuyez sur  pour effectuer la sélection.

- 3 Appuyez sur  ou  jusqu'à Liste de balayage. Appuyez sur  pour effectuer la sélection.

- 4 Appuyez sur  ou  pour afficher chacun des membres de la liste.

Affichage des entrées de la liste de balayage à l'aide de la recherche d'alias



Suivez la procédure suivante pour afficher des entrées de la liste de balayage de la radio à l'aide de la recherche d'alias.



- 1 Appuyez sur  pour accéder au menu.
- 2 Appuyez sur  ou  jusqu'à Balayer.
Appuyez sur  pour effectuer la sélection.



3 Appuyez sur  ou  jusqu'à Liste de balayage. Appuyez sur  pour effectuer la sélection.

4 Entrez le premier caractère de l'alias voulu. L'écran affiche un curseur clignotant.

5 Entrez le reste des caractères de l'alias voulu. La recherche d'alias n'est pas sensible à la casse. Si deux entrées ou plus portent le même nom, la radio affiche l'entrée figurant en premier dans la liste. La première ligne de texte affiche les caractères que vous avez entrés. La ligne de texte suivante affiche les résultats de la recherche.

2 Appuyez sur  ou  jusqu'à Balayer. Appuyez sur  pour effectuer la sélection.

3 Appuyez sur  ou  jusqu'à Liste de balayage. Appuyez sur  pour effectuer la sélection.



4 Appuyez sur  ou  jusqu'à Ajouter un membre. Appuyez sur  pour effectuer la sélection.

5 Appuyez sur  ou  jusqu'à l'alias ou l'ID voulu. Appuyez sur  pour effectuer la sélection.







Ajout d'entrées à la liste de balayage

Suivez la procédure suivante pour ajouter des entrées à la liste de balayage de votre radio.

1 Appuyez sur  pour accéder au menu.











- 6 Appuyez sur  ou  jusqu'au niveau de priorité voulu. Appuyez sur  pour effectuer la sélection.
- L'écran affiche un bref avis de réussite, immédiatement suivi du message *En ajouter un autre?*.

7 Faites un des suivants :

- Appuyez sur  ou  jusqu'à *Oui* pour ajouter une entrée. Appuyez sur  pour effectuer la sélection. Répétez [étape 5](#) et [étape 6](#).
- Appuyez sur  ou  jusqu'à *Non* pour enregistrer la liste actuelle. Appuyez sur  pour effectuer la sélection.

Ajout d'entrées à la liste de balayage à l'aide de la recherche d'alias





Suivez la procédure suivante pour ajouter des entrées à la liste de balayage de la radio à l'aide de la recherche d'alias.

- 1 Appuyez sur  pour accéder au menu.
- 2 Appuyez sur  ou  jusqu'à *Balayer*. Appuyez sur  pour effectuer la sélection.
- 3 Appuyez sur  ou  jusqu'à *Liste de balayage*. Appuyez sur  pour effectuer la sélection.
- 4 Appuyez sur  ou  jusqu'à *Ajouter un membre*. Appuyez sur  pour effectuer la sélection.
- 5 Entrez le premier caractère de l'alias voulu. L'écran affiche un curseur clignotant.

6 Entrez le reste des caractères de l'alias voulu.



La recherche d'alias n'est pas sensible à la casse. Si deux entrées ou plus portent le même nom, la radio affiche l'entrée figurant en premier dans la liste.

La première ligne de texte affiche les caractères que vous avez entrés. La ligne de texte suivante affiche les résultats de la recherche.



7 Appuyez sur  pour effectuer la sélection.**8** Appuyez sur  ou  jusqu'au niveau de priorité voulu. Appuyez sur  pour effectuer la sélection.

L'écran affiche un bref avis de réussite, immédiatement suivi du message *En ajouter un autre?*.

9 Faites un des suivants :





- Appuyez sur  ou  jusqu'à Oui pour ajouter une entrée. Appuyez sur  pour

effectuer la sélection. Répétez l'étape [étape 8](#) jusqu'à l'étape [étape 5](#).



- Appuyez sur  ou  jusqu'à Non pour enregistrer la liste actuelle. Appuyez sur  pour effectuer la sélection.

Suppression d'une entrée de la liste de balayage







Suivez la procédure suivante pour supprimer les entrées de la liste de balayage.

1 Appuyez sur  pour accéder au menu.**2** Appuyez sur  ou  jusqu'à Balayer. Appuyez sur  pour effectuer la sélection.**3** Appuyez sur  ou  jusqu'à Liste de balayage. Appuyez sur  pour effectuer la sélection.

4 Appuyez sur  ou  jusqu'à l'alias ou l'ID voulu. Appuyez sur  pour effectuer la sélection.

5 Appuyez sur  ou  jusqu'à Supprimer. Appuyez sur  pour effectuer la sélection. L'écran affiche Supprimer l'entrée?.

6 Faites un des suivants :

- Appuyez sur  ou  jusqu'à Oui pour supprimer l'entrée. Appuyez sur  pour effectuer la sélection. L'écran affiche un bref avis de réussite.
 - Appuyez sur  ou  jusqu'à Non pour revenir à l'écran précédent. Appuyez sur  pour effectuer la sélection.
-



7 Répétez [étape 4](#) jusqu'à [étape 6](#) pour supprimer d'autres entrées.



8 Appuyez longuement sur  pour revenir à l'écran d'accueil après avoir supprimé les alias et les ID voulus.

Configuration de l'ordre de priorité des entrées de la liste de balayage



Suivez la procédure suivante pour configurer l'ordre de priorité des entrées de la liste de balayage de votre radio.



1 Appuyez sur  pour accéder au menu.

2 Appuyez sur  ou  jusqu'à Balayer. Appuyez sur  pour effectuer la sélection.

3 Appuyez sur  ou  jusqu'à Liste de balayage. Appuyez sur  pour effectuer la sélection.

4 Appuyez sur  ou  jusqu'à l'alias ou l'ID voulu. Appuyez sur  pour effectuer la sélection.

5 Appuyez sur  ou  jusqu'à Modifier les priorités. Appuyez sur  pour effectuer la sélection.

6 Appuyez sur  ou  jusqu'au niveau de priorité voulu. Appuyez sur  pour effectuer la sélection.

L'écran affiche un bref avis de réussite avant de revenir à l'écran précédent. L'icône **Priorité** s'affiche à la gauche de l'alias du membre.



AVIS:

Cette fonction n'est pas offerte en mode Capacity Plus.

Pendant un balayage bimode, si vous employez un canal numérique et si votre radio capte un canal analogique, votre radio passe automatiquement du mode numérique au mode analogique pendant la durée de la communication. L'inverse est également vrai.

Il y a deux façons de démarrer un balayage :

Balayage du canal principal (manuel)

Votre radio effectue le balayage de tous les canaux et de tous les groupes de votre liste de balayage. Au démarrage du balayage, votre radio peut, selon les réglages définis, commencer automatiquement par le dernier canal ou groupe actif lors du dernier balayage ou par le canal à partir duquel le balayage a été lancé.

Balayage auto (automatique)

Votre radio démarre automatiquement le balayage lorsque vous sélectionnez un canal ou un groupe pour lequel la fonction balayage auto est activée.

Balayage

Lorsque vous démarrez un balayage, votre radio recherche l'activité vocale en passant par le cycle complet de la liste de balayage du canal actuel.







AVIS:



Lorsque vous configurez la **Réception de messages de groupe dans la liste de balayage**, votre radio est en mesure de recevoir des messages de groupe à partir de canaux autres que de l'accueil. Votre radio est en mesure de répondre au groupe des messages sur votre canal d'accueil, mais n'est pas en mesure de répondre à des canaux autres que ceux de l'accueil. Pour obtenir des renseignements supplémentaires, adressez-vous à votre détaillant ou à votre administrateur de système.



Activer ou désactiver le balayage

Suivez la procédure suivante pour activer ou désactiver le balayage sur votre radio.

- 1 Appuyez sur  pour accéder au menu.

- 2 Appuyez sur  ou  jusqu'à Balayer.
Appuyez sur  pour effectuer la sélection.

- 3 Appuyez sur  ou  jusqu'à État scan.
Appuyez sur  pour effectuer la sélection.

- 4 Appuyez sur  ou  jusqu'à l'état de balayage requis, puis appuyez sur  pour le sélectionner.

Si le balayage est activé :

- L'écran affiche Balayage activé et l'icône **Balayage**.
- Le voyant DEL jaune clignote.

Si le balayage est désactivé :

- L'écran affiche Balayage désactivé.
- L'icône de **balayage** disparaît.
- Le voyant DEL s'éteint.

Réponse à une transmission pendant un balayage

Lorsqu'elle exécute un balayage, votre radio s'arrête sur un canal ou un groupe si elle y détecte de l'activité. La radio demeure sur ce canal pendant une durée programmée

appelée « période d'attente ». Suivez la procédure suivante pour répondre à des transmissions pendant le balayage.

- 1  Si l'indicateur Canal libre est activé, une courte tonalité d'avertissement se fait entendre lorsque l'utilisateur de la radio émettrice cesse d'appuyer sur le bouton **PTT**, vous indiquant que le canal est libre et que vous pouvez répondre. Appuyez sur le bouton **PTT** pendant la période d'attente.

Le voyant DEL vert s'allume.

- 2 Relâchez le bouton **PTT** pour écouter.

La radio reprend le balayage des autres canaux ou des groupes si vous ne répondez pas dans le délai de mise en attente.

Suppression des canaux nuisibles

Si un canal émet continuellement des appels indésirables ou du bruit (canal « nuisible »), vous pouvez éliminer temporairement ce canal indésirable de la liste de balayage. Cette possibilité n'existe pas pour le canal employé comme canal sélectionné. Suivez la procédure suivante pour supprimer les canaux nuisibles de votre radio.

- 1 Lorsque votre radio capte un canal indésirable ou nuisible, appuyez sur la touche programmée **Suppr. canal nuisible** et maintenez-la jusqu'à ce qu'une tonalité retentisse.

- 2 Relâchez la touche programmée **Suppr canal nuisible**.

Le canal nuisible est supprimé.

Restauration des canaux nuisibles

Suivez la procédure suivante pour restaurer les canaux nuisibles de votre radio.

Faites un des suivants :

- Éteignez la radio, puis rallumez-la.
- Arrêtez et redémarrez un balayage avec la touche préprogrammée **Balayage** ou du menu.
- Changez de canal à l'aide de la touche **Canal précédent/suivant**.

Balayage par vote :

Le balayage par vote vous permet d'obtenir une zone de couverture étendue là où plusieurs stations de base transmettent des données identiques sur différents canaux analogiques.

Votre radio effectue le balayage des canaux analogiques de plusieurs stations de base et sélectionne le signal reçu le plus fort. Une fois la sélection déterminée, la radio reçoit les transmissions de cette station de base.

Pendant un balayage par vote, le voyant DEL jaune clignote et l'écran affiche l'icône **Balayage par vote**.

Suivez les étapes décrites dans la section [Réponse à une transmission pendant un balayage à la page 426](#) pour répondre à une transmission pendant un balayage par vote.

Réglages des contacts

La fonction Contacts constitue le carnet d'adresses de votre radio. Chaque entrée est associée à un alias ou à un ID que vous utilisez pour passer un appel. Les entrées sont classées alphabétiquement.

Chaque entrée, selon le contexte, correspond à différents types d'appels : appel de groupe, appel individuel, appel général, appel PC ou appel de répartition.

Les appels PC et les appels console répartiteur sont des appels de données. Ils ne sont disponibles qu'avec les applications. Pour plus de détails, reportez-vous à la documentation sur les applications de données.

 De plus, le menu Contacts vous permet d'attribuer à chaque entrée une ou plusieurs touches numériques programmables sur un microphone à clavier. Si une touche numérique est attribuée à une entrée, votre radio peut exécuter la composition rapide de l'entrée.



AVIS:

Un crochet précède chaque touche numérique attribuée à une entrée. Si le crochet précède le mot Vide, aucune touche numérique n'a été attribuée à l'entrée.

Chaque entrée des contacts affiche les renseignements suivants :

- Type d'appel
- Alias d'appel
- ID d'appel



**AVIS:**



Si la fonction Cryptage est activée sur un canal, vous pouvez passer des appels cryptés de type groupe, individuel ou général sur ce canal. Seule une radio cible dotée de la même clé de cryptage OU des mêmes valeurs et ID de clé que votre radio peut décoder la transmission.

Appels de groupe faits à l'aide de la liste de contacts

Suivez la procédure suivante pour passer des appels de groupe à l'aide de la liste de contacts à partir de la radio.

- 1 Appuyez sur  pour accéder au menu.

- 2 Appuyez sur  ou  jusqu'à Contacts. Appuyez sur  pour effectuer la sélection.

- 3 Appuyez sur  ou  jusqu'à l'alias ou l'ID voulu. Appuyez sur  pour effectuer la sélection.

- 4 Pour passer l'appel, appuyez sur le bouton de conversation **PTT**.

Le voyant DEL vert s'allume.

- 5 Relâchez le bouton **PTT** pour écouter.







Le voyant DEL vert clignote lorsqu'un utilisateur du groupe répond. L'écran affiche l'icône **Appel de groupe**, et l'alias ou l'ID ainsi que l'alias ou l'ID de la radio émettrice.

- 6  Si l'indicateur Canal libre est activé, une courte tonalité d'avertissement se fait entendre lorsque l'utilisateur de la radio émettrice cesse d'appuyer sur le bouton **PTT**, vous indiquant que le canal est libre et que vous pouvez répondre. Pour prendre l'appel, appuyez sur le bouton **PTT**.

L'appel se termine lorsqu'il n'y a aucune activité vocale pendant une durée préprogrammée.

Appels privés faits à l'aide de la liste de contacts

Suivez la procédure suivante pour passer des appels privés à l'aide de la liste de contacts à partir de la radio.

- 1 Appuyez sur  pour accéder au menu.
- 2 Appuyez sur  ou  jusqu'à Contacts. Appuyez sur  pour effectuer la sélection.
- 3 Appuyez sur  ou  jusqu'à l'alias ou l'ID voulu. Appuyez sur  pour effectuer la sélection.
- 4 Pour passer l'appel, appuyez sur le bouton de conversation **PTT**.
Le voyant DEL vert s'allume. L'écran affiche l'alias de destination.

5 Attendez la fin de la tonalité d'autorisation de parler (si elle est activée) et parlez clairement dans le microphone.

6 Relâchez le bouton **PTT** pour écouter.

Le voyant DEL vert clignote lorsque la radio cible répond. L'écran affiche l'alias ou l'ID de la radio émettrice.



7  Si l'indicateur Canal libre est activé, une courte tonalité d'avertissement se fait entendre lorsque l'utilisateur de la radio émettrice cesse d'appuyer sur le bouton **PTT**, vous indiquant que le canal est libre et que vous pouvez répondre. Pour prendre l'appel, appuyez sur le bouton **PTT**.



L'appel se termine lorsqu'il n'y a aucune activité vocale pendant une durée préprogrammée. Une tonalité se fait entendre. L'écran affiche Appel terminé.



Association d'une entrée à une touche numérique programmable



Suivez la procédure suivante pour associer des entrées aux touches numériques programmables de votre radio.

- 1 Appuyez sur  pour accéder au menu.

- 2 Appuyez sur  ou  jusqu'à Contacts. Appuyez sur  pour effectuer la sélection.



- 3 Appuyez sur  ou  jusqu'à l'alias ou l'ID voulu. Appuyez sur  pour effectuer la sélection.

- 4 Appuyez sur  ou  jusqu'à Touche programmable. Appuyez sur  pour effectuer la sélection.

- 5 Faites un des suivants :
 - Si la touche numérique voulue n'a été attribuée à une entrée, appuyez sur  ou  jusqu'à la

touche numérique voulue. Appuyez sur  pour effectuer la sélection.



- Si la touche numérique voulue a été attribuée à une entrée, l'écran affiche La clé est déjà affecté et puis, la première ligne de texte affiche Remplacer?. Faites un des suivants :

Appuyez sur  ou  jusqu'à Oui.

Appuyez sur  pour effectuer la sélection.

La radio fait entendre une tonalité de réussite et l'écran affiche Contact enregistré et un bref avis de réussite.

Appuyez sur  ou  jusqu'à Non pour revenir à l'écran précédent.

Différentes touches numériques peuvent être attribuées à chaque entrée. Le signe  précède chaque touche numérique attribuée à une entrée. Si le signe  précède Vide, la touche numérique n'est pas attribuée.

Si une touche numérique a été attribuée à une entrée dans un mode particulier, la fonction n'est pas

prise en charge lorsque vous appuyez longuement sur la touche numérique dans un autre mode.



L'écran revient automatiquement au menu précédent.

Dissociation d'une entrée et de la touche numérique programmable



Suivez la procédure pour dissocier les entrées des touches numériques programmables de votre radio.



1 Faites un des suivants :

- Appuyez longuement sur la touche numérique programmée jusqu'à l'alias ou l'ID voulu. Passez à [étape 4](#).
- Appuyez sur  pour accéder au menu.



2 Appuyez sur  ou  jusqu'à `Contacts`.
Appuyez sur  pour effectuer la sélection.

3 Appuyez sur  ou  jusqu'à l'alias ou l'ID voulu. Appuyez sur  pour effectuer la sélection.

4 Appuyez sur  ou  jusqu'à `Touche programmable`. Appuyez sur  pour effectuer la sélection.

5 Appuyez sur  ou  jusqu'à `Vide`. Appuyez sur  pour effectuer la sélection.

La première ligne de texte affiche `Supprimer de toutes les touches`.

6 Appuyez sur  ou  jusqu'à `Oui`. Appuyez sur  pour effectuer la sélection.



AVIS:

Lorsqu'une entrée est supprimée, l'association entre l'entrée et les touches numériques programmées est supprimée.



Une tonalité de réussite se fait entendre. L'écran affiche le message `Contact enregistré`.



L'écran revient automatiquement au menu précédent.



Ajout d'un nouveau contact

Suivez la procédure suivante pour ajouter de nouveaux contacts sur votre radio.

- 1 Appuyez sur  pour accéder au menu.



- 2 Appuyez sur  ou  jusqu'à Contacts. Appuyez sur  pour effectuer la sélection.

- 3 Appuyez sur  ou  jusqu'à Nouveau contact. Appuyez sur  pour effectuer la sélection.

- 4 Appuyez sur  ou  pour sélectionner le type de contact, soit Contact Radio, soit Contact tél. Appuyez sur  pour effectuer la sélection.

- 5 Entrer le numéro du contact à l'aide du clavier et appuyez sur  pour continuer.

- 6 Entrer le nom du contact à l'aide du clavier et appuyez sur  pour continuer.



- 7 Appuyez sur  ou  jusqu'à la sonnerie voulue. Appuyez sur  pour effectuer la sélection.

Une tonalité de réussite se fait entendre. L'écran affiche un bref avis de réussite.

Configuration du contact par défaut



Suivez la procédure suivante pour configurer le contact par défaut de votre radio.

- 1 Appuyez sur  pour accéder au menu.

2 Appuyez sur  ou  jusqu'à **Contacts**.

Appuyez sur  pour effectuer la sélection.

3 Appuyez sur  ou  jusqu'à l'alias ou l'ID voulu. Appuyez sur  pour effectuer la sélection.

4 Appuyez sur  ou  jusqu'à **Configurer** par défaut. Appuyez sur  pour effectuer la sélection.

Une tonalité de réussite se fait entendre. L'écran affiche un bref avis de réussite. L'écran affiche  à côté de l'alias ou de l'ID sélectionné par défaut.



Réglages de l'indicateur d'appel



Cette fonction permet aux utilisateurs radio de configurer un appel ou un message texte sonneries.

Activation ou désactivation des sonneries d'appel des avertissements d'appel

Suivez la procédure suivante pour activer ou désactiver les sonneries d'appel des appels d'urgence sur votre radio.

1 Appuyez sur  pour accéder au menu.

2 Appuyez sur  ou  jusqu'à **Utilitaires**.
Appuyez sur  pour effectuer la sélection.

3 Appuyez sur  ou  jusqu'au **Paramètres** de la radio. Appuyez sur  pour effectuer la sélection.

4 Appuyez sur  ou  jusqu'à Trinités/Avert.



Appuyez sur  pour effectuer la sélection.



5 Appuyez sur  ou  jusqu'à Sonn.

d'appels. Appuyez sur  pour effectuer la sélection.

6 Appuyez sur  ou  jusqu'à Avert.

d'appel. Appuyez sur  pour effectuer la sélection.

7 Appuyez sur  ou  jusqu'à la sonnerie

voulue. Appuyez sur  pour effectuer la sélection. L'écran affiche  à côté de la sonnerie sélectionnée.



1 Appuyez sur  pour accéder au menu.

2 Appuyez sur  ou  jusqu'à

Utilitaires. Appuyez sur  pour effectuer la sélection.

3 Appuyez sur  ou  jusqu'au Paramètres

de la radio. Appuyez sur  pour effectuer la sélection.

4 Appuyez sur  ou  jusqu'à Trinités/

Avert.. Appuyez sur  pour effectuer la sélection.

5 Appuyez sur  ou  jusqu'à Sonn.

d'appels. Appuyez sur  pour effectuer la sélection.

Activation ou désactivation des sonneries d'appel des appels privés



Suivez la procédure suivante pour activer ou désactiver les sonneries d'appel des appels privés de la radio.

6 Appuyez sur  ou  jusqu'à Appel indiv..



Appuyez sur  pour effectuer la sélection.

Si les sonneries d'appel individuel sont activées, l'écran affiche  à côté du message Allumé.

Si les sonneries d'appel individuel sont activées, l'écran affiche  à côté du message Éteint.

7 Appuyez sur  ou  jusqu'à la sonnerie

voulue. Appuyez sur  pour effectuer la sélection.

Si la fonction est activée,  apparaît à côté d'Activé. Si cette option est désactivée, le  ne s'affiche plus à côté de Activé.



1 Appuyez sur  pour accéder au menu.

2 Appuyez sur  ou  jusqu'à

Utilitaires. Appuyez sur  pour effectuer la sélection.

3 Appuyez sur  ou  jusqu'au Paramètres

de la radio. Appuyez sur  pour effectuer la sélection.

4 Appuyez sur  ou  jusqu'à Trinités/

Avert.. Appuyez sur  pour effectuer la sélection.

5 Appuyez sur  ou  jusqu'à Sonn.

d'appels. Appuyez sur  pour effectuer la sélection.





Activation ou désactivation des sonneries d'appel des appels sélectifs



Suivez la procédure suivante pour activer ou désactiver les sonneries d'appel des appels sélectifs de la radio.

6 Appuyez sur  ou  jusqu'à Appel sélectif. Appuyez sur  pour effectuer la sélection.

L'écran affiche  et la sonnerie actuelle.



7 Appuyez sur  ou  jusqu'à la sonnerie voulue. Appuyez sur  pour effectuer la sélection. L'écran affiche  à côté de la sonnerie sélectionnée.



Activation ou désactivation des sonneries d'appel des messages textes





Suivez la procédure suivante pour activer ou désactiver les sonneries de messages texte sur votre radio.





1 Appuyez sur  pour accéder au menu.





2 Appuyez sur  ou  jusqu'à Utilitaires. Appuyez sur  pour effectuer la sélection.

3 Appuyez sur  ou  jusqu'au Paramètres de la radio. Appuyez sur  pour effectuer la sélection.

4 Appuyez sur  ou  jusqu'à Trinités/ Avert... Appuyez sur  pour effectuer la sélection.





5 Appuyez sur  ou  jusqu'à Sonn. d'appels. Appuyez sur  pour effectuer la sélection.



6 Appuyez sur  ou  jusqu'à Message texte. Appuyez sur  pour effectuer la sélection. L'écran affiche  et la sonnerie actuelle.



- 7 Appuyez sur  ou  jusqu'à la sonnerie voulue. Appuyez sur  pour effectuer la sélection.
- L'écran affiche  à côté de la nouvelle sonnerie sélectionnée.
-

Activer ou désactiver les sonneries d'appel des états de télémétrie avec message texte





Suivez la procédure suivante pour activer ou désactiver les sonneries d'appel d'état de télémétrie avec message texte sur votre radio.

- 1 Appuyez sur  pour accéder au menu.
-
- 2 Appuyez sur  ou  jusqu'à Utilitaires.
- Appuyez sur  pour effectuer la sélection.
-

- 3 Appuyez sur  ou  jusqu'au Paramètres de la radio. Appuyez sur  pour effectuer la sélection.
-

- 4 Appuyez sur  ou  jusqu'à Trinités/Avert.
- Appuyez sur  pour effectuer la sélection.
-

- 5 Appuyez sur  ou  jusqu'à Sonn. d'appels. Appuyez sur  pour effectuer la sélection.
-



- 6 Appuyez sur  ou  jusqu'à Télémétrie.
- Appuyez sur  pour effectuer la sélection.
- La tonalité sélectionnée est indiquée par l'icône .
-



Attribuer des styles de sonneries



Vous pouvez programmer votre radio pour qu'elle émette une sonnerie particulière parmi les onze sonneries prédéfinies lorsque vous recevez un appel privé, un

avertissement d'appel ou un message texte de la part d'un contact particulier. La radio fait entendre chaque style de sonnerie lorsque vous parcourez la liste. Suivez la procédure pour attribuer des styles de sonnerie sur votre radio.

- 1 Appuyez sur  pour accéder au menu.



- 2 Appuyez sur  ou  jusqu'à **Contacts**. Appuyez sur  pour effectuer la sélection.
Les entrées sont classées alphabétiquement.

- 3 Appuyez sur  ou  jusqu'à l'alias ou l'ID voulu. Appuyez sur  pour effectuer la sélection.

- 4 Appuyez sur  ou  jusqu'à **Voix** / **Modifier**. Appuyez sur  pour effectuer la sélection.

- 5 Appuyez sur  jusqu'à ce que l'écran affiche le menu **Sonnerie**

L'icône  indique la tonalité actuellement sélectionnée.

- 6 Appuyez sur  ou  jusqu'à la tonalité voulue. Appuyez sur  pour effectuer la sélection.

L'icône  s'affiche à côté de celui sélectionné.

Augmenter le volume de la tonalité d'alarme

Votre détaillant peut programmer la radio pour vous alerter de façon continue lorsqu'un appel radio reste sans réponse. Le volume de la tonalité d'alarme augmente alors graduellement. Cette fonction porte le nom d'avertissement croissant.

Fonctions du Journal des appels

Votre radio fait le suivi des appels individuels que vous avez faits, que vous avez reçus et que vous avez manqués récemment. Utilisez le journal des appels pour afficher et gérer les derniers appels.



Les Alertes d'appels manqués peuvent être incluses dans les journaux d'appels, selon la configuration du système sur votre radio. Dans chacune des listes d'appels, vous pouvez exécuter les tâches suivantes :



- Stocker l'alias ou l'ID dans les contacts
- Supprimer un appel
- Supprimer tous les appels
- Afficher les détails

Affichage des derniers appels

Suivez la procédure suivante pour afficher les derniers appels sur votre radio.

- 1 Appuyez sur  pour accéder au menu.
-

- 2 Appuyez sur  ou  jusqu'à Journal des appels. Appuyez sur  pour effectuer la sélection.
-

- 3 Appuyez sur  ou  jusqu'à la liste voulue. Les listes offertes sont Manqués, Répondus et Sortants.



Appuyez sur  pour effectuer la sélection.
L'écran affiche l'entrée la plus récente.



- 4 Appuyez sur  ou  pour voir la liste.
Vous pouvez lancer un Appel individuel avec l'alias ou l'ID affiché à l'écran en appuyant sur la touche **PTT**.
-



Suppression des appels de la liste d'appel



Suivez la procédure suivante pour supprimer des appels de la liste d'appel.





- 1 Appuyez sur  pour accéder au menu.

- 2 Appuyez sur  ou  jusqu'à Journal des appels. Appuyez sur  pour effectuer la sélection.

- 3 Appuyez sur  ou  jusqu'à la liste voulue. Appuyez sur  pour effectuer la sélection.
Si la liste est vide :
 - Une tonalité se fait entendre.
 - L'écran affiche Liste vide.

- 4 Appuyez sur  ou  jusqu'à l'alias ou l'ID voulu. Appuyez sur  pour effectuer la sélection.



- 5 Appuyez sur  ou  jusqu'à Supprimer l'entrée?. Appuyez sur  pour effectuer la sélection.



- 6 Faites un des suivants :
 - Appuyez sur  pour sélectionner Oui et supprimer l'entrée.
L'écran affiche Entrée supprimée.
 - Appuyez sur  ou  jusqu'à Non.
Appuyez sur  pour effectuer la sélection.
La radio revient à l'écran précédent.
-



Afficher les détails de la liste d'appel



Suivez la procédure suivante pour afficher les détails de l'appel sur votre radio.

- 1 Appuyez sur  pour accéder au menu.

- 2 Appuyez sur  ou  jusqu'à Journal des appels. Appuyez sur  pour effectuer la sélection.

3 Appuyez sur  ou  jusqu'à la liste voulue.
Appuyez sur  pour effectuer la sélection.



4 Appuyez sur  ou  jusqu'à l'alias ou l'ID voulu. Appuyez sur  pour effectuer la sélection.



5 Appuyez sur  ou  jusqu'à Afficher les détails. Appuyez sur  pour effectuer la sélection.
L'écran affiche les détails d'appel.

Stockage des alias ou des ID de la liste d'appels



Suivez la procédure suivante pour stocker les alias ou les ID de la liste d'appels sur votre radio.

1 Appuyez sur  pour accéder au menu.

2 Appuyez sur  ou  jusqu'à Journal des appels. Appuyez sur  pour effectuer la sélection.

3 Appuyez sur  ou  jusqu'à la liste voulue.
Appuyez sur  pour effectuer la sélection.

4 Appuyez sur  ou  jusqu'à l'alias ou l'ID voulu. Appuyez sur  pour effectuer la sélection.

5 Appuyez sur  ou  jusqu'à Stocker.
Appuyez sur  pour effectuer la sélection.
L'écran affiche un curseur clignotant.

6 Entrez le reste des caractères de l'alias voulu.
Appuyez sur  pour effectuer la sélection.

Vous pouvez également enregistrer un ID sans un alias.

L'écran affiche un bref avis de réussite.

Fonction Avertissement d'appel

L'envoi d'un avertissement d'appel vous permet de faire savoir à un utilisateur de radio particulier que vous souhaitez qu'il vous rappelle.

Cette fonction est offerte uniquement pour les alias ou les ID d'abonné et est accessible par le menu Contacts, la numérotation manuelle ou la touche d'**accès direct** programmée.

Exécution d'une alerte d'appel

Suivez la procédure suivante pour lancer des alertes d'appel à partir de votre radio.

- 1 Appuyez sur la touche d'**accès direct** programmée.
L'écran affiche Avert. d'appel ainsi que l'alias ou l'ID d'abonné. Le voyant DEL vert s'allume.
-







- 2 Attendez la confirmation.



Si la radio reçoit la confirmation de l'avis d'appel, l'écran affiche un bref avis de réussite.

Dans le cas contraire, l'écran affiche un bref avis d'échec.

Avis d'appels faits à l'aide de la liste de contacts

Suivez la procédure suivante pour passer des avis d'appel à l'aide de la liste de contacts à partir de votre radio.

- 1 Appuyez sur  pour accéder au menu.
-
- 2 Appuyez sur  ou  jusqu'à Contacts.
Appuyez sur  pour effectuer la sélection.
-
- 3 Appuyez sur  ou  jusqu'à l'alias ou l'ID voulu. Appuyez sur  pour effectuer la sélection.
-

- 4 Appuyez sur  ou  jusqu'à Avert. d'appel. Appuyez sur  pour effectuer la sélection.



L'écran affiche Avert. d'appel ainsi que l'alias ou l'ID d'abonné. Le voyant DEL vert s'allume.



- 5 Attendez la confirmation.
- Si la radio reçoit la confirmation de l'avis d'appel, l'écran affiche un bref avis de réussite.
 - Dans le cas contraire, l'écran affiche un bref avis d'échec.
-

Avis d'appel fait à l'aide de la numérotation manuelle



Suivez la procédure suivante pour passer des avis d'appel à l'aide de la numérotation manuelle à partir de votre radio.

- 1 Appuyez sur  pour accéder au menu.
-

- 2 Appuyez sur  ou  jusqu'à Contacts. Appuyez sur  pour effectuer la sélection.
-

- 3 Appuyez sur  ou  jusqu'à Num. manuelle. Appuyez sur  pour effectuer la sélection. L'écran affiche un curseur clignotant.
-

- 4 Entrez l'ID de l'abonné et appuyez sur  pour continuer.
-

- 5 Appuyez sur  ou  jusqu'à Avert. d'appel. Appuyez sur  pour effectuer la sélection. L'écran affiche Avert. d'appel ainsi que l'alias ou l'ID d'abonné. Le voyant DEL vert s'allume.
-

- 6 Attendez la confirmation.
- Si la radio reçoit la confirmation de l'avis d'appel, l'écran affiche un bref avis de réussite.

- Dans le cas contraire, l'écran affiche un bref avis d'échec.

Réponse à un avertissement d'appel

Suivez la procédure suivante pour répondre à un avertissement d'appel sur votre radio.

Lorsque vous recevez un avertissement d'appel :

- Une tonalité répétitive se fait entendre.
- Le voyant DEL jaune clignote.
- L'écran affiche la liste des notifications d'avertissement d'appel accompagnée de l'alias ou de l'ID de la radio de l'appelant.

Selon la configuration par votre détaillant ou administrateur de système, vous pouvez répondre à un avertissement d'appel en procédant de l'une des manières suivantes :

- Appuyez sur le bouton **PTT** et répondez par un appel individuel directement à l'appelant.
- Appuyez sur le bouton **PTT** pour continuer la communication de groupe d'appels normale.

L'avertissement d'appel est déplacé vers l'option Appel manqué dans le menu du Journal d'appels. Vous pouvez répondre à l'appelant à partir du journal Appel manqué.

Pour plus d'informations à ce sujet, reportez-vous à [Liste de notifications à la page 204](#) et à [Fonctions du Journal des appels à la page 138](#).

Mode Muet

Le mode muet propose une option à l'utilisateur de couper tous les indicateurs audio de la radio.

Une fois le mode muet activé, tous les indicateurs sonores sont désactivés à l'exception des fonctions de priorité élevée, comme les opérations d'urgence.

Lorsque l'on quitte le mode muet, la radio reprend la lecture des tonalités et de transmissions audio.



AVIS:

Ceci est une fonction pouvant être achetée. Pour obtenir des renseignements supplémentaires, adressez-vous à votre détaillant ou à votre administrateur de système.

Activation du mode muet

Suivez la procédure suivante pour activer le mode muet.

Accédez à cette fonction à partir de la touche programmée **Mode muet**.

Les éléments suivants se produisent lorsque le mode muet est activé :











- Une tonalité de réussite se fait entendre.
- L'écran affiche Mode muet activé.
- Le voyant rouge clignote et continue de clignoter jusqu'à ce que l'on quitte le mode muet.
- L'écran affiche le **Mode muet** sur l'écran d'accueil.
- La radio est en sourdine.
- La minuterie de mode muet commence pour toute la durée configurée.



Réglage de la minuterie du mode muet

La fonction Mode muet peut être activée pour une durée prédéterminée en réglant la minuterie du mode muet. La durée de la minuterie est configurée dans le menu de la

radio et peut être comprise entre 0,5 et 6 heures. Le mode muet est quitté lorsque la minuterie expire.

Si la minuterie est laissée à 0, la radio reste en mode muet pendant une période indéfinie jusqu'à ce que l'on appuie sur la touche programmée **Mode muet**.

- 1 Appuyez sur  pour accéder au menu.
- 2 Appuyez sur  ou  jusqu'à Utilitaires. Appuyez sur  pour effectuer la sélection.
- 3 Appuyez sur  ou  jusqu'au Paramètres de la radio. Appuyez sur  pour effectuer la sélection.
- 4 Appuyez sur  ou  jusqu'à Mode muet. Appuyez sur  pour effectuer la sélection.

- 5 Appuyez sur  ou  pour modifier la valeur numérique de chaque chiffre, puis appuyez sur .

Quitter le mode muet

Cette fonction peut être quittée automatiquement une fois l'expiration de la minuterie de mode muet.

Effectuez l'une des opérations suivantes pour quitter le mode muet manuellement :

- Appuyez sur la touche programmée **Mode muet**.
- Appuyez sur le bouton **PTT** pour n'importe quelle entrée.

Les éléments suivants se produisent lorsque le mode muet est désactivé :

- Une tonalité d'échec se fait entendre.
- L'écran affiche Mode muet désactivé.
- Le voyant DEL rouge clignotant s'éteint.
- L'icône **Mode muet** disparaît de l'écran d'accueil.

- Votre radio désactive le mode muet et l'état du haut-parleur est rétabli.
- Si la minuterie n'est pas expirée, cette dernière est arrêtée.



AVIS:

Mode muet est également abandonné si l'utilisateur transmet par la voix ou passa à un canal non programmé.

Fonctionnement d'urgence

Une alarme d'urgence est employée pour signaler une situation critique. Vous pouvez signaler une urgence en tout temps même si de l'activité se déroule sur le canal en cours d'utilisation.

Votre détaillant peut définir la durée d'appui sur la touche **Urgence** programmée, sauf la durée d'appui prolongé, qui est semblable à celui de tous les autres boutons.

Appui bref

De 0,05 à 0,75 seconde.

Appui long

De 1,00 à 3,75 secondes.

La fonction Urgence act./dés. est attribuée à la touche **Urgence**. Vérifiez auprès de votre détaillant le fonctionnement de la touche **Urgence**.



AVIS:

Si un appui bref sur la touche **Urgence** lance le mode d'urgence, alors une longue pression sur la même touche permet à la radio de quitter le mode d'urgence.

Si un appui long sur la touche **Urgence** lance le mode d'urgence, alors une courte pression sur la même touche permet à la radio de quitter le mode d'urgence.

Votre radio prend en charge trois alarmes d'urgence :

- Alarme d'urgence
- Alarme d'urgence avec appel
- Alarme d'urgence suivie d'un appel vocal 



AVIS:

Une seule des alarmes d'urgence ci-dessus peut être associée à la touche d'**urgence** programmée ou à l'interrupteur d'urgence au pied.

De plus, chaque alarme comprend les types suivants :

Régulier

La radio transmet un signal d'alarme et active des indicateurs sonores ou visuels.

Silencieux

La radio transmet un signal d'alarme sans indicateurs sonores ou visuels. La radio reçoit les appels sans qu'aucun son ne se fasse entendre sur le haut-parleur, jusqu'à ce que la période de transmission *micro ouvert* programmée se termine ou que vous appuyiez sur le bouton **PTT**.

Silencieux avec voix

La radio transmet un signal d'alarme sans indicateurs sonores ou visuels, mais permet aux appels entrants de se faire entendre sur le haut-parleur.

Réception d'une alarme d'urgence





Suivez la procédure suivante pour recevoir des alertes d'urgence sur votre radio.

Lorsque vous recevez une alarme d'urgence :

- Une tonalité se fait entendre.
- Le voyant DEL rouge clignote.
- L'écran affiche l'icône **Urgence** et l'alias de l'émetteur de l'appel d'urgence ou s'il n'y a plus d'une alarme

d'urgence, tous les alias de l'émetteur de l'appel d'urgence sont affichés dans liste des alarmes.

1 Faites un des suivants :

- S'il y a une seule alarme, appuyez sur  pour afficher plus de détails.
- S'il y a plus d'une alarme, appuyez sur  ou  jusqu'à l'alias requis, puis appuyez sur  pour plus de détails.

2 Appuyez sur  pour afficher les options qui s'offrent à vous.

3 Appuyez sur  et sélectionnez Oui pour quitter la liste des alarmes.

4 Appuyez sur  pour accéder au menu.



5 Sélectionnez Liste des alarmes pour consulter de nouveau la liste des alarmes.

6 La tonalité retentit et le voyant DEL clignote en rouge jusqu'à ce que vous quittiez le mode d'urgence. Cependant, la tonalité peut être coupée. Faites un des suivants :

- Appuyez sur le bouton **PTT** pour appeler le groupe de radios pour lequel une alarme d'urgence a été émise.
- Appuyez sur n'importe quelle touche programmable.
- Quittez le mode d'urgence. Voir [Sortie du mode d'urgence après réception de l'alarme d'urgence à la page 450](#).

Réponse à une alarme d'urgence

Suivez la procédure suivante pour répondre à une alarme d'urgence à partir de votre radio.

- 1 Assurez-vous que l'écran affiche la liste des alarmes. Appuyez sur  ou  jusqu'à l'alias ou l'ID voulu.
- 2  Si l'indicateur Canal libre est activé, une courte tonalité d'avertissement se fait entendre lorsque

l'utilisateur de la radio émettrice cesse d'appuyer sur le bouton **PTT**, vous indiquant que le canal est libre et que vous pouvez répondre. Appuyez sur le bouton **PTT** pour transmettre un message vocal sans urgence au groupe ciblé par l'alarme d'urgence.

Le voyant DEL vert s'allume. Votre radio demeure en mode d'urgence.

3 Faites un des suivants :

- Attendez la fin de la tonalité d'autorisation de parler (si elle est activée) et parlez clairement dans le microphone.
-  Attendez la fin de l'effet local **PTT** (s'il est activé) et parlez clairement dans le microphone.

4 Relâchez le bouton **PTT** pour écouter.

Lorsque la radio à l'origine de la transmission d'urgence répond :

- Le voyant DEL vert clignote.
 - L'écran affiche l'icône **Appel de groupe** et l'ID, l'ID de la radio émettrice et la liste des alarmes.
-

La voix d'urgence ne peut être transmise que par la radio à l'origine de la transmission d'urgence. Toutes les autres radios (y compris la radio réceptrice de la transmission d'urgence) transmettent la voix sans urgence.

Sortie du mode d'urgence après réception de l'alarme d'urgence

Suivez la procédure suivante pour quitter le mode d'urgence après avoir reçu une alarme d'urgence :

- Supprimez les alarmes.
- Éteignez la radio.

Envoi des alarmes d'urgence

Cette fonction vous permet d'envoyer une alarme d'urgence (un signal sans voix) qui déclenche une indication d'alerte sur un groupe de radios. Votre radio n'affiche aucun indicateur sonore ou visuel durant le mode d'urgence lorsque celui-ci est réglé sur silencieux.

Suivez la procédure suivante pour envoyer des alertes d'urgence à partir de votre radio.

1 Appuyez sur la touche programmée **Urgence activée**.

Vous voyez un des résultats suivants :

- L'écran affiche le message **Alarme Tx** et l'alias de destination.
-  L'écran affiche le message **Télégram Tx** et l'alias de destination.

Le voyant DEL vert s'allume. L'icône **Urgence** s'affiche.



AVIS:

Si programmée, la tonalité de recherche d'urgence se fait entendre. Cette tonalité est silencieuse lorsque la radio transmet ou reçoit des messages vocaux, et s'arrête lorsque la radio quitte le mode d'urgence. La tonalité Recherche d'urgence peut être programmée à partir du CPS.

2 Attendez la confirmation.

En cas de réussite :

- La tonalité d'urgence se fait entendre.
- Le voyant DEL rouge clignote.

- L'écran affiche le message **Alarme envoyée**

En cas d'échec après que toutes les tentatives ont été utilisées :

- Une tonalité se fait entendre.
- L'écran affiche le message **Échec de l'alarme**.

La radio quitte le mode d'alarme d'urgence et revient à l'écran d'accueil.

Envoi d'une alarme d'urgence avec un appel

Cette fonction vous permet d'envoyer une alarme d'urgence avec un appel à un groupe de radios. Lorsqu'une radio du groupe accuse réception de l'alarme d'urgence, le groupe de radios peut communiquer sur un canal d'urgence programmé.

Suivez la procédure suivante pour envoyer un message d'urgence avec appel à partir de votre radio.

- 1 Appuyez sur la touche programmée **Urgence Act.** ou sur la **pédale d'urgence**. L'écran affiche Envoi d'alarme en alternance avec l'ID de votre radio.

Vous voyez ce qui suit :

- L'écran affiche le message **Télégram Tx** et l'alias de destination.

Le voyant DEL vert s'allume. L'icône **Urgence** s'affiche.



AVIS:

Si programmée, la tonalité de recherche d'urgence se fait entendre. Cette tonalité est silencieuse lorsque la radio transmet ou reçoit des messages vocaux, et s'arrête lorsque la radio quitte le mode d'urgence. La tonalité de la recherche d'urgence peut être programmée par votre détaillant ou votre administrateur système.

2 Attendez la confirmation.

En cas de réussite :

- La tonalité d'urgence se fait entendre.
- Le voyant DEL rouge clignote.
- L'écran affiche le message **Alarme envoyée**
- Votre radio passe en mode d'appel d'urgence lorsque l'écran affiche le message **Urgence** et l'alias du groupe de destination.

3 Pour passer l'appel, appuyez sur le bouton de conversation **PTT**.

Le voyant DEL vert s'allume. L'écran affiche l'icône **Appel de groupe**.

4 Faites un des suivants :

- Attendez la fin de la tonalité d'autorisation de parler (si elle est activée) et parlez clairement dans le microphone.
-  Attendez la fin de l'effet local **PTT** (s'il est activé) et parlez clairement dans le microphone.

5 Relâchez le bouton **PTT** pour écouter.

L'écran affiche l'alias de l'appelant et l'alias de groupe.

-
- ## 6 Si l'indicateur Canal libre est activé, une courte tonalité d'avertissement se fait entendre lorsque l'utilisateur de la radio émettrice cesse d'appuyer sur le bouton **PTT**, vous indiquant que le canal est libre et que vous pouvez répondre. Pour prendre l'appel, appuyez sur le bouton **PTT**.
-

- 7 Pour quitter le mode d'urgence une fois l'appel terminé, appuyez sur la touche **Urgence désactivée**.

La radio revient à l'écran d'accueil.

Alarmes d'urgence suivies d'un appel vocal

Cette fonction vous permet d'envoyer une alarme d'urgence suivie d'un appel vocal à un groupe de radios. Le microphone de votre radio est automatiquement activé, vous permettant de communiquer avec le groupe de radios sans avoir à appuyer sur le bouton **PTT**. Cet état de microphone activé est aussi appelé « *microphone branché* ».



AVIS:

Votre radio ne peut pas détecter un microphone non IMPRES qui est attaché au connecteur d'accessoire arrière.

Si aucun microphone n'est détecté sur le connecteur programmé indiqué, votre radio vérifie l'autre connecteur. Ainsi votre radio donne la priorité au microphone détecté.

Si le mode de cycle d'urgence de votre radio est activé, les répétitions de *microphone branché* et de période de réception s'appliquent pendant la durée programmée. Pendant le mode de cycle d'urgence, le son des appels reçus est diffusé sur le haut-parleur de la radio.

Si vous appuyez sur le bouton **PTT** pendant la période de réception programmée, une tonalité d'interdiction se fait entendre, indiquant que vous devez libérer le bouton **PTT**. La radio ne tient pas compte du fait que le bouton **PTT** est enfoncé et demeure en mode d'urgence.

Si vous appuyez sur le bouton **PTT** pendant la période de *microphone branché* programmée et si vous maintenez le bouton enfoncé après l'expiration de la durée de *microphone branché*, la radio continue de transmettre jusqu'à ce que vous relâchiez le bouton **PTT**.

Si la demande d'alarme d'urgence échoue, la radio ne fait pas d'autre tentative et passe directement à l'état de *microphone branché*.



AVIS:

Certains accessoires ne prennent pas en charge la fonction *microphone branché*. Pour obtenir des renseignements supplémentaires, adressez-vous à votre détaillant ou à votre administrateur de système.

Envoi d'une alarme d'urgence suivie d'un appel vocal

Suivez la procédure suivante pour envoyer un message d'urgence suivi d'un appel vocal.

- 1 Appuyez sur la touche programmée **Urgence Act.** ou sur la **pédale d'urgence**.

Vous voyez un des résultats suivants :

- L'écran affiche le message **Alarme Tx** et l'alias de destination.
- L'écran affiche le message **Télégram Tx** et l'alias de destination.

Le voyant DEL vert s'allume. L'icône **Urgence** s'affiche.

-
- 2 Lorsque l'écran affiche le message **Alarme envoyée**, parlez clairement dans le micro.

La radio cesse automatiquement de transmettre dans les cas suivants :

- Si le mode Cycle d'urgence est activé, la durée du cycle entre *micro ouvert* et réception d'appels arrive à son terme.

- Après l'expiration de la durée de *micro ouvert*, le mode cycle d'urgence est désactivé.

-
- 3 Appuyez sur la touche **Urgence désact.** pour quitter le mode d'urgence.

La radio revient à l'écran d'accueil.

Réactivation du mode d'urgence

Cette fonction n'est offerte que sur la radio qui envoie l'alarme d'urgence. Suivez la procédure suivante pour réactiver une alarme d'urgence sur votre radio.

Faites un des suivants :

- Changez le canal pendant que la radio est en mode d'urgence. La radio quitte le mode d'urgence et réactive le mode d'urgence, si l'alarme d'urgence est activée sur le nouveau canal.
- Appuyez sur la touche programmée **Urg. activé** pendant que la radio est dans un état d'activation du mode d'urgence ou de transmission

d'urgence. La radio quitte alors cet état et réactive le mode d'urgence.

Quitter le mode d'urgence après l'envoi de l'alarme d'urgence

Cette fonction n'est offerte que sur la radio qui envoie l'alarme d'urgence.

Votre radio quitte le mode d'urgence lorsque :

- Un accusé de réception est reçu (dans le cas de l'alarme d'urgence seulement).
- Toutes les tentatives d'envoi de l'alarme ont été effectuées.



AVIS:

Si la radio est mise hors tension, elle quitte le mode d'urgence. La radio ne réactive pas automatiquement le mode d'urgence lorsqu'elle est remise sous tension.







Suivez la procédure suivante pour quitter le mode d'urgence sur votre radio.



Faites un des suivants :

- Appuyez sur la touche programmée **Urg. désactivé**.
- Changez de canal pour un nouveau canal qui n'a pas été configuré avec le mode d'urgence. L'écran affiche Pas d'urgence.

Supprimez l'alarme de la liste d'alarmes

Suivez la procédure pour supprimer les éléments d'alarme de la liste des alarmes, pour quitter le mode d'urgence.

- 1 Appuyez sur  pour accéder au menu.
- 2 Appuyez sur  ou  jusqu'à Liste Alarmes. Appuyez sur  pour effectuer la sélection.
- 3 Appuyez sur  ou  jusqu'à l'alarme voulue. Appuyez sur  pour effectuer la sélection.

- 4 Appuyez sur  ou  jusqu'à Supprimer.
Appuyez sur  pour effectuer la sélection.
-

Messagerie texte

Votre radio peut recevoir des données, par exemple un message texte, en provenance d'une autre radio ou d'une application de messagerie texte.

Il existe deux types de messages texte : court message texte et message texte de radio mobile numérique (DMR). La longueur maximale d'un message texte court DMR est de 23 caractères. En mode transmission, un message texte peut comporter un maximum de 280 caractères, ce qui inclut la ligne d'objet. Vous voyez la ligne d'objet lorsque vous recevez un message provenant d'une application courriel.



AVIS:





La longueur maximale de 280 caractères s'applique uniquement pour les modèles avec la dernière version du logiciel et du matériel. Pour les modèles de radio avec les anciens logiciels et matériels, la longueur maximale d'un message texte est de 140 caractères. Pour obtenir des renseignements supplémentaires, adressez-vous à votre détaillant ou à votre administrateur de système.



Messages texte

Les messages texte sont enregistrés de la boîte de réception et classés du plus récent au plus ancien.

Affichage des messages texte



Suivez la procédure suivante pour afficher les messages texte sur la radio.



- 1 Appuyez sur  pour accéder au menu.
 - 2 Appuyez sur  ou  jusqu'à Messages.
Appuyez sur  pour effectuer la sélection.
-



3 Appuyez sur  ou  jusqu'à Boîte de réception. Appuyez sur  pour effectuer la sélection.



Si la boîte de réception est vide :

- L'écran affiche Liste vide.
- Une sonnerie se fait entendre, si la sonnerie du pavé numérique est activée.

4 Appuyez sur  ou  jusqu'au message voulu. Appuyez sur  pour effectuer la sélection.
La ligne d'objet pourrait s'afficher si le message provient d'une application de courriel.

2 Appuyez sur  ou  jusqu'à Messages.
Appuyez sur  pour effectuer la sélection.

3 Appuyez sur  ou  jusqu'à Boîte de réception. Appuyez sur  pour effectuer la sélection.

4 Appuyez sur  ou  jusqu'au message voulu. Appuyez sur  pour effectuer la sélection.
Vous ne pouvez pas répondre à un message texte d'état de télémétrie.
L'écran affiche Télémétrie : <Status Text Message>.

5 Maintenez enfoncée la touche  pour revenir à l'écran d'accueil.

Afficher des messages texte d'état de télémétrie

Suivez la procédure permettant d'afficher un message texte d'état de télémétrie à partir de la boîte de réception.

1 Appuyez sur  pour accéder au menu.

Réponse à des messages texte

Suivez la procédure suivante pour répondre aux messages texte à partir de votre radio.

Lorsque vous recevez un message texte :



- L'écran affiche la liste de notification comprenant l'alias ou l'ID de l'expéditeur.
- L'écran affiche l'icône **Message**.



AVIS:

La radio quitte l'écran d'alerte de message texte et achemine un Appel individuel ou de groupe à l'expéditeur du message si le bouton **PTT** est enfoncé.



1 Faites un des suivants :

- Appuyez sur  ou  jusqu'à Lire.



Appuyez sur  pour effectuer la sélection. L'écran affiche le message texte. La ligne d'objet pourrait s'afficher si le message provient d'une application de courriel.

- Appuyez sur  ou  jusqu'à Lire plus tard. Appuyez sur  pour effectuer la sélection.

La radio revient à l'écran affiché précédant la réception du message texte.

- Appuyez sur  ou  jusqu'à Supprimer. Appuyez sur  pour effectuer la sélection.

2 Faites un des suivants :



- Appuyez sur  pour revenir à la boîte de réception.
- Appuyez à nouveau sur  pour répondre au message texte, le transférer ou le supprimer.



Réponse à des messages texte par un texte rapide



Suivez la procédure suivante pour répondre aux messages texte par des messages texte rapides sur votre radio.

1 Faites un des suivants :



- Appuyez sur la touche programmée **Message texte**. Passez à l'étape [étape 3](#).
 - Appuyez sur  pour accéder au menu.
-



2 Appuyez sur  ou  jusqu'à Messages.
Appuyez sur  pour effectuer la sélection.



3 Appuyez sur  ou  jusqu'à Boîte de réception. Appuyez sur  pour effectuer la sélection.

4 Appuyez sur  ou  jusqu'au message voulu. Appuyez sur  pour effectuer la sélection.
La ligne d'objet pourrait s'afficher si le message provient d'une application de courriel.

5 Appuyez sur  pour accéder au sous-menu.

6 Appuyez sur  ou  jusqu'à Répondre.
Appuyez sur  pour effectuer la sélection.

7 Appuyez sur  ou  jusqu'à Réponse rapide. Appuyez sur  pour effectuer la sélection.

8 Appuyez sur  ou  jusqu'au message voulu. Appuyez sur  pour effectuer la sélection.
L'écran affiche un bref avis indiquant que l'envoi du message est en cours.

9 Attendez la confirmation.

En cas de réussite :

- Une tonalité se fait entendre.
- L'écran affiche un bref avis de réussite.

En cas d'échec :

- Une tonalité se fait entendre.
- L'écran affiche un bref avis d'échec.

- La radio revient à l'écran d'option Renvoyer.

Renvoi des messages texte

Suivez la procédure pour renvoyer des messages texte à partir de votre radio.

Depuis l'écran d'option Renvoyer :

Appuyez sur  pour renvoyer le même message au même alias ou ID d'abonné ou de groupe.

En cas de réussite :

- Une tonalité de réussite se fait entendre.
- L'écran affiche un bref avis de réussite.



En cas d'échec :



- Une tonalité d'échec se fait entendre.
 - L'écran affiche un bref avis d'échec.
 - La radio revient à l'écran d'option Renvoyer.
-

Transfère des messages texte

Suivez la procédure suivante pour transférer les messages texte à partir de votre radio.

Depuis l'écran d'option Renvoyer :

- 1 Appuyez sur  ou  jusqu'à Transférer et appuyez sur  pour envoyer le même message à un autre abonné ou un alias de groupe ou un ID.
-

- 2 Appuyez sur  ou  jusqu'à l'alias ou l'ID voulu. Appuyez sur  pour effectuer la sélection. L'écran affiche un bref avis indiquant que l'envoi du message est en cours.
-

- 3 Attendez la confirmation.

En cas de réussite :

- Une tonalité de réussite se fait entendre.
- L'écran affiche un bref avis de réussite.

En cas d'échec :

- Une tonalité d'échec se fait entendre.





- L'écran affiche un bref avis d'échec.



**AVIS:**

Vous pouvez également sélectionner manuellement l'adresse de la radio cible (consultez la section [Transfère des messages texte à l'aide de la numérotation manuelle à la page 461](#)).

Transfère des messages texte à l'aide de la numérotation manuelle

Suivez la procédure suivante pour transférer les messages texte à l'aide de la numérotation manuelle de votre radio.

- 1 Appuyez sur  ou  jusqu'à Transférer.
Appuyez sur  pour effectuer la sélection.
- 2 Appuyez sur  pour envoyer le même message au même alias ou ID d'abonné ou de groupe.

- 3 Appuyez sur  ou  jusqu'à Num. manuelle. Appuyez sur  pour effectuer la sélection.
L'écran affiche Numéro de la radio :.

- 4 Entrez l'ID de l'abonné et appuyez sur  pour continuer.
L'écran affiche un bref avis indiquant que l'envoi du message est en cours.

- 5 Attendez la confirmation.
En cas de réussite :
 - Une tonalité se fait entendre.
 - L'écran affiche un bref avis de réussite.
 En cas d'échec :
 - Une tonalité se fait entendre.
 - L'écran affiche un bref avis d'échec.



Modification de messages texte





Sélectionnez **Modifier** pour modifier le message.





AVIS:

Si le message comporte une ligne d'objet (s'il a été envoyé à partir d'une application de courriel), il est impossible de la modifier.







- 1 Appuyez sur  ou  jusqu'à **Modifier**.
Appuyez sur  pour effectuer la sélection.
L'écran affiche un curseur clignotant.

- 2 Utilisez les touches du clavier pour modifier le message.
 - Appuyez sur  pour déplacer le curseur d'une espace vers la gauche.
 - Appuyez sur  ou  pour déplacer le curseur d'une espace vers la droite.
 - Appuyez sur  pour supprimer les caractères inutiles.

- Appuyez longuement sur  pour modifier le mode de saisie de texte.

- 3 Une fois votre message composé, appuyez sur  .

- 4 Faites un des suivants :



- Appuyez sur  ou  jusqu'à **Envoyer**, puis appuyez sur  pour envoyer le message.
- Appuyez sur  ou  jusqu'à **Enregistrer**, puis appuyez sur  pour enregistrer le message dans le dossier **Brouillons**.
- Appuyez sur  pour modifier le message.
- Appuyez sur  pour choisir entre la suppression du message ou son enregistrement dans le dossier **Brouillons**.



Rédaction de messages texte

Suivez la procédure suivante pour rédiger des messages texte sur la radio.

1 Faites un des suivants :

- Appuyez sur la touche programmée **Message texte**. Passez à [étape 3](#).
- Appuyez sur  pour accéder au menu.

2 Appuyez sur  ou  jusqu'à Messages.
Appuyez sur  pour effectuer la sélection.

3 Appuyez sur  ou  jusqu'à Composer.
Appuyez sur  pour effectuer la sélection.
Un curseur clignotant apparaît.

4 Utilisez le clavier pour taper votre message.

Appuyez sur  pour déplacer le curseur d'une espace vers la gauche.





Appuyez sur  ou  pour déplacer le curseur d'une espace vers la droite.

Appuyez sur  pour supprimer les caractères inutiles.

Appuyez longuement sur  pour modifier le mode de saisie de texte.

5 Une fois votre message composé, appuyez sur  .

Faites un des suivants :







- Appuyez sur  pour envoyer le message.
- Appuyez sur  . Appuyez sur  ou  pour modifier, supprimer ou enregistrer le message. Appuyez sur  pour effectuer la sélection.

Envoi de messages texte

Suivez la procédure pour envoyer des messages texte sur votre radio.

Supposons que vous avez récemment écrit ou enregistré un message texte.

Sélectionnez le destinataire du message. Faites un des suivants :

- Appuyez sur  ou  Sélectionnez le destinataire du message. Appuyez sur  pour effectuer la sélection.
- Appuyez sur  ou  jusqu'à Num. manuelle. Appuyez sur  pour effectuer la sélection. Entrez l'ID d'abonné. La première ligne de l'écran affiche le message Numéro radio :. La deuxième ligne de l'écran affiche un curseur clignotant. Entrez l'alias ou l'ID d'abonné.
Appuyez sur .

L'écran affiche un bref avis indiquant que l'envoi du message est en cours.

En cas de réussite :

- Une tonalité se fait entendre.
- L'écran affiche un bref avis de réussite.

En cas d'échec :

- Une tonalité faible retentit.
- L'écran affiche un bref avis d'échec.
- Le message est déplacé dans le dossier Messages envoyés.
- Le message est marqué avec une icône Échec d'envoi.



AVIS:

Pour un nouveau message texte écrit, la radio vous renvoie à l'écran d'option Renvoyer.



Suppression des messages texte de la boîte de réception

Suivez la procédure suivante pour supprimer les messages texte de la boîte de réception de la radio.



1 Faites un des suivants :

- Appuyez sur la touche programmée **Message texte**. Passez à [étape 3](#).

- Appuyez sur  pour accéder au menu.

2 Appuyez sur  ou  jusqu'à Messages.

Appuyez sur  pour effectuer la sélection.

3 Appuyez sur  ou  jusqu'à Boîte de réception. Appuyez sur  pour effectuer la sélection.



Si la boîte de réception est vide :

- L'écran affiche Liste vide.
- Une tonalité se fait entendre.



4 Appuyez sur  ou  jusqu'au message voulu. Appuyez sur  pour effectuer la sélection.

La ligne d'objet pourrait s'afficher si le message provient d'une application de courriel.

5 Appuyez sur  pour accéder au sous-menu.

6 Appuyez sur  ou  jusqu'à Supprimer.

Appuyez sur  pour effectuer la sélection.

7 Appuyez sur  ou  jusqu'à Oui. Appuyez sur  pour effectuer la sélection.



L'écran affiche un bref avis de réussite. L'écran revient à la boîte de réception.

Suppression de tous les messages texte de la boîte de réception



Suivez la procédure suivante pour supprimer tous les messages texte de la boîte de réception de la radio.

1 Faites un des suivants :

- Appuyez sur la touche programmée **Message texte**. Passez à [étape 3](#).
- Appuyez sur  pour accéder au menu.



2 Appuyez sur  ou  jusqu'à Messages.



Appuyez sur  pour effectuer la sélection.

3 Appuyez sur  ou  jusqu'à Boîte de réception. Appuyez sur  pour effectuer la sélection.

Si la boîte de réception est vide :

- L'écran affiche Liste vide.
 - Une tonalité se fait entendre.
-

4 Appuyez sur  ou  jusqu'à Tout supprimer. Appuyez sur  pour effectuer la sélection.

5 Appuyez sur  ou  jusqu'à Oui. Appuyez sur  pour effectuer la sélection.

L'écran affiche un bref avis de réussite.

Messages texte envoyés

Une fois qu'un message texte est envoyé vers une autre radio, il est enregistré dans les messages envoyés. Le dernier message texte envoyé s'affiche toujours en haut de la liste des messages envoyés. Vous pouvez renvoyer, transférer, modifier ou supprimer un message texte envoyé.

Le dossier des messages envoyés peut contenir au maximum les 30 derniers messages envoyés. Une fois le dossier plein, le prochain message envoyé remplace automatiquement le plus ancien message enregistré dans le dossier.

Si vous quittez l'écran d'envoi de message pendant que l'envoi du message est en cours, la radio met à jour l'état du message dans le dossier des messages envoyés sans fournir d'indication sonore ou visuelle.

Si la radio change de mode ou est mise hors tension avant que l'état du message ne soit mis à jour dans le dossier des messages envoyés, la radio ne peut terminer l'envoi du message en cours et marque automatiquement celui-ci d'une icône **Échec de l'envoi**.

La radio prend en charge un maximum de cinq envois de message en cours à la fois. Pendant ce temps, la radio ne peut envoyer aucun autre message et marque

automatiquement les nouveaux messages de l'icône **Échec de l'envoi**.

Vous pouvez revenir à l'écran d'accueil à tout moment en appuyant longuement sur la touche .







AVIS:



Si le type de canal (p. ex. numérique conventionnel, Capacity Plus) ne correspond pas, vous pouvez uniquement modifier, transférer ou supprimer un message envoyé.

Affichage des messages texte envoyés

Suivez la procédure suivante pour afficher des messages texte envoyés à partir de votre radio.



- 1 Faites un des suivants :
 - Appuyez sur la touche programmée **Message texte**. Passez à [étape 3](#).
 - Appuyez sur  pour accéder au menu.

- 2 Appuyez sur  ou  jusqu'à Messages. Appuyez sur  pour effectuer la sélection.

- 3 Appuyez sur  ou  jusqu'à Messages envoyés. Appuyez sur  pour effectuer la sélection.

Si le dossier Messages envoyés est vide :

- L'écran affiche Liste vide.
- Une tonalité grave se fait entendre, si la sonnerie du pavé numérique est activée.





- 4 Appuyez sur  ou  jusqu'au message voulu. Appuyez sur  pour effectuer la sélection. L'icône affichée dans le coin supérieur droit de l'écran indique l'état du message. Voir [Icônes des éléments envoyés](#).

Envoi de messages texte envoyés

Suivez la procédure suivante pour envoyer un message texte envoyé sur votre radio.

Lorsque vous affichez un message envoyé :

- 1 Pendant que vous visualisez le message, appuyez sur  .

- 2 Vous pouvez soit renvoyer ou transférer le message texte envoyé. Faites un des suivants :
 -  pour Renvoyer. Appuyez sur  pour effectuer la sélection.
 -  pour Transférer. Appuyez sur  pour effectuer la sélection.

L'écran affiche un bref avis indiquant que l'envoi du message est en cours.

- 3 Attendez la confirmation.

En cas de réussite :

- Une tonalité de réussite se fait entendre.
- L'écran affiche un bref avis de réussite.

En cas d'échec :

- Une tonalité d'échec se fait entendre.



- L'écran affiche un bref avis d'échec.
- La radio passe à l'écran d'option Renvoyer. Pour obtenir plus de renseignements à ce sujet, consultez la section [Renvoi des messages texte à la page 165](#).

Suppression d'un message texte envoyé à partir du dossier messages envoyés

Suivez la procédure suivante pour supprimer les messages texte du dossier des messages envoyés à partir de votre radio.

Lorsque vous affichez un message envoyé :

- 1 Appuyez sur  .



- 2 Appuyez sur  ou  jusqu'à Supprimer. Appuyez sur  pour effectuer la sélection.



Suppression de tous les messages texte envoyés du dossier messages envoyés

Suivez la procédure suivante pour supprimer tous les messages texte du dossier des messages envoyés.

1 Faites un des suivants :



- Appuyez sur la touche programmée **Message texte**. Passez à [étape 3](#).
- Appuyez sur  pour accéder au menu.

2 Appuyez sur  ou  jusqu'à Messages. Appuyez sur  pour effectuer la sélection.







3 Appuyez sur  ou  jusqu'à Messages envoyés. Appuyez sur  pour effectuer la sélection.

Si le dossier Messages envoyés est vide :

- L'écran affiche Liste vide.
- Une tonalité se fait entendre.

4 Appuyez sur  ou  jusqu'à Tout supprimer. Appuyez sur  pour effectuer la sélection.

5 Faites un des suivants :

- Appuyez sur  ou  jusqu'à Oui. Appuyez sur  pour effectuer la sélection. L'écran affiche un bref avis de réussite.
- Appuyez sur  ou  jusqu'à Non. Appuyez sur  pour effectuer la sélection. La radio revient à l'écran précédent.

Messages texte enregistrés

Vous pouvez enregistrer un message texte afin de l'envoyer plus tard.

Si l'écran de rédaction ou de modification de message se ferme pendant que vous rédigez ou modifiez un message texte, par exemple si vous avez appuyé sur le bouton **PTT** ou changé de mode, votre message est automatiquement enregistré dans les brouillons.



Le message texte le plus récent figure toujours en haut de la liste des brouillons.



Le dossier Brouillons permet de stocker au maximum les 10 derniers messages enregistrés. Une fois le dossier plein, le prochain message enregistré remplace automatiquement le plus ancien message enregistré dans le dossier.



Affichage de messages texte enregistrés

Suivez la procédure suivante pour afficher des messages texte enregistrés envoyés à partir de votre radio.

- 1 Faites un des suivants :
 - Appuyez sur la touche programmée **Message texte**. Passez à [étape 3](#).
 - Appuyez sur  pour accéder au menu.





- 2 Appuyez sur  ou  jusqu'à Messages.
Appuyez sur  pour effectuer la sélection.

- 3 Appuyez sur  ou  jusqu'à Brouillons.
Appuyez sur  pour effectuer la sélection.

- 4 Appuyez sur  ou  jusqu'au message voulu. Appuyez sur  pour effectuer la sélection.

Modification de messages texte enregistrés

Suivez la procédure suivante pour modifier des messages texte enregistrés envoyés à partir de votre radio.

- 1 Pendant que vous visualisez le message, appuyez sur  .
- 2 Appuyez sur  ou  jusqu'à Modifier.
Appuyez sur  pour effectuer la sélection.
Un curseur clignotant apparaît.
- 3 Utilisez le clavier pour taper votre message.

Appuyez sur  pour déplacer le curseur d'une espace vers la gauche.







Appuyez sur  ou  pour déplacer le curseur d'une espace vers la droite.

Appuyez sur  pour supprimer les caractères inutiles.

Appuyez longuement sur  pour modifier le mode de saisie de texte.

4 Une fois votre message composé, appuyez sur  .

Faites un des suivants :



- Appuyez sur  ou  jusqu'à Envoyer. Appuyez sur  pour envoyer le message.
 - Appuyez sur  . Appuyez sur  ou  pour choisir entre supprimer ou enregistrer le message. Appuyez sur  pour effectuer la sélection.
-



Suppression de messages texte enregistrés du dossier brouillons

Suivez la procédure suivante pour supprimer des messages texte enregistrés dans les brouillons sur votre radio.

1 Faites un des suivants :

- Appuyez sur la touche programmée **Message texte**. Passez à [étape 3](#).
 - Appuyez sur  pour accéder au menu.
-

2 Appuyez sur  ou  jusqu'à Messages. Appuyez sur  pour effectuer la sélection.

3 Appuyez sur  ou  jusqu'à Brouillons. Appuyez sur  pour effectuer la sélection.

4 Appuyez sur  ou  jusqu'au message voulu. Appuyez sur  pour effectuer la sélection.

- 5 Appuyez sur  ou  jusqu'à Supprimer.
Sélectionnez  pour supprimer le message texte.
-

Message texte rapide

Votre radio prend en charge un maximum de 50 messages texte rapides, selon la programmation effectuée par votre détaillant.

Les messages texte rapides sont prédéfinis, mais vous pouvez modifier chaque message avant de l'envoyer.



Envoi de messages texte rapides



Suivez la procédure suivante pour envoyer des messages texte rapides prédéfinis sur votre radio à un alias prédéfini.

- 1 Faites un des suivants :
 - Appuyez sur la touche programmée **Message texte**. Passez à [étape 6](#).
 - Appuyez sur la touche d'**accès direct** programmée.
L'écran affiche un bref avis indiquant que l'envoi du message est en cours.

Passez à [étape 6](#).

- Appuyez sur  pour accéder au menu.
-

- 2 Appuyez sur  ou  jusqu'à Messages.
Appuyez sur  pour effectuer la sélection.
-

- 3 Appuyez sur  ou  jusqu'à Texte rapide.
Appuyez sur  pour effectuer la sélection.
-

- 4 Appuyez sur  ou  jusqu'au texte rapide voulu. Appuyez sur  pour effectuer la sélection.
-

- 5 Procédez comme suit pour sélectionner le destinataire et envoyer le message.

L'écran affiche un bref avis indiquant que l'envoi du message est en cours.

- 6 Attendez la confirmation.

En cas de réussite :

- Une tonalité de réussite se fait entendre.

- L'écran affiche un bref avis de réussite.

En cas d'échec :

- Une tonalité d'échec se fait entendre.
- L'écran affiche un bref avis d'échec.
- La radio passe à l'écran d'option **Renvoyer**. Pour obtenir plus de renseignements à ce sujet, consultez la section [Renvoi des messages texte à la page 165](#).

- Symboles
- Frappe prédictive ou multiple
- Langue (si programmée)



AVIS:

Appuyez sur  en tout temps pour revenir à l'écran précédent ou maintenez enfoncée la touche

 pour revenir à l'écran d'accueil. Lorsqu'il n'y a aucune activité pendant une durée prédéfinie, la radio quitte l'écran en cours.

Configuration de saisie de texte

Votre radio vous permet de configurer différents textes.

Vous pouvez configurer les paramètres suivants pour la saisie de texte dans votre radio :

- Prédiction de texte
- Mot correct
- Majuscule en début de phrase
- Mes mots

Votre radio prend en charge les méthodes de saisie de texte suivantes :

- Chiffres



Activation ou désactivation du mot correct



Cette option fournit d'autres choix de mots quand le mot entré dans l'éditeur de texte n'est pas reconnu par le dictionnaire intégré.



1 Appuyez sur  pour accéder au menu.

2 Appuyez sur  ou  jusqu'à **Utilitaires**.





Appuyez sur  pour effectuer la sélection.



3 Appuyez sur  ou  jusqu'au Paramètres de la radio. Appuyez sur  pour effectuer la sélection.

4 Appuyez sur  ou  jusqu'à Saisie texte. Appuyez sur  pour effectuer la sélection.

5 Appuyez sur  ou  pour désactiver Correction ortho. Appuyez sur  pour effectuer la sélection.

6 Faites un des suivants :



- Appuyez sur  ou  pour désactiver Correction ortho. Appuyez sur  pour effectuer la sélection.
- Appuyez sur  pour activer la correction orthographique. Si la fonction est activée,  apparaît à côté d'Activé.



- Appuyez sur  pour désactiver la correction orthographique. Si cette option est désactivée, le  ne s'affiche plus à côté de Activé.
-

Activation ou désactivation de la prédiction du texte

Prédiction de texte : Votre radio peut apprendre des séquences de mots courantes que vous entrez souvent. Elle peut alors prédire le prochain mot que vous désirez utiliser après la saisie du premier mot d'une séquence de mots courante dans l'éditeur de texte.

1 Appuyez sur  pour accéder au menu.

2 Appuyez sur  ou  jusqu'à Utilitaires. Appuyez sur  pour effectuer la sélection.



3 Appuyez sur  ou  jusqu'au Paramètres de la radio. Appuyez sur  pour effectuer la sélection.

4 Appuyez sur  ou  jusqu'à Saisie texte.

Appuyez sur  pour effectuer la sélection.

5 Appuyez sur  ou  jusqu'à Prédict. texte. Appuyez sur  pour effectuer la sélection.

6 Faites un des suivants :

- Appuyez sur  pour activer la prédiction de texte. Si la fonction est activée, ✓ apparaît à côté d'Activé.
 - Appuyez sur  pour désactiver le contrôle dynamique de la distorsion du microphone. Si cette option est désactivée, le ✓ ne s'affiche plus à côté de Activé.
-



Majuscule en début de phrase

Cette fonction met automatiquement la première lettre du premier mot en majuscule pour chaque nouvelle phrase.

1 Appuyez sur  pour accéder au menu.



2 Appuyez sur  ou  jusqu'à Utilitaires.

Appuyez sur  pour effectuer la sélection.

3 Appuyez sur  ou  jusqu'au Paramètres de la radio. Appuyez sur  pour effectuer la sélection.

4 Appuyez sur  ou  jusqu'à Saisie texte.

Appuyez sur  pour effectuer la sélection.

5 Appuyez sur  ou  pour désactiver Maj.

Phrase. Appuyez sur  pour effectuer la sélection.







6 Faites un des suivants :



- Appuyez sur  pour activer Maj. phrase. Si la fonction est activée, ✓ apparaît à côté d'Activé.



- Appuyez sur  pour désactiver Maj. phrase. Si cette option est désactivée, le ✓ ne s'affiche plus à côté de Activé.



Afficher des mots personnalisés

Vous pouvez ajouter vos propres mots personnalisés dans le dictionnaire intégré de votre radio. Votre radio contient une liste de ces mots.

- 1 Appuyez sur  pour accéder au menu.
- 2 Appuyez sur  ou  jusqu'à Utilitaires.
Appuyez sur  pour effectuer la sélection.
- 3 Appuyez sur  ou  jusqu'au Paramètres de la radio. Appuyez sur  pour effectuer la sélection.





- 4 Appuyez sur  ou  jusqu'à Saisie texte.
Appuyez sur  pour effectuer la sélection.



- 5 Appuyez sur  ou  jusqu'à Mes mots.
Appuyez sur  pour effectuer la sélection.



- 6 Appuyez sur  ou  jusqu'à Liste de mots. Appuyez sur  pour effectuer la sélection.
L'écran affiche la liste des mots personnalisés.



Modifier des mots personnalisés



Vous pouvez modifier les mots personnalisés enregistrés dans votre radio.



- 1 Appuyez sur  pour accéder au menu.
- 2 Appuyez sur  ou  jusqu'à Utilitaires.
Appuyez sur  pour effectuer la sélection.



3 Appuyez sur  ou  jusqu'au Paramètres de la radio. Appuyez sur  pour effectuer la sélection.

4 Appuyez sur  ou  jusqu'à Saisie texte. Appuyez sur  pour effectuer la sélection.





5 Appuyez sur  ou  jusqu'à Mes mots. Appuyez sur  pour effectuer la sélection.

6 Appuyez sur  ou  jusqu'à Liste de mots. Appuyez sur  pour effectuer la sélection. L'écran affiche la liste des mots personnalisés.

7 Appuyez sur  ou  jusqu'au mot voulu. Appuyez sur  pour effectuer la sélection.

8 Appuyez sur  ou  jusqu'à Modifier. Appuyez sur  pour effectuer la sélection.

9 Utilisez le clavier pour modifier votre mot personnalisé.

- Appuyez sur  pour déplacer le curseur d'une espace vers la gauche.
 - Appuyez sur la touche  pour déplacer le curseur d'une espace vers la droite.
 - Appuyez sur la touche  pour supprimer les caractères inutiles.
 - Appuyez longuement sur  pour modifier le mode de saisie de texte.
-

10 Appuyez sur  une fois que votre mot personnalisé est terminé.



L'écran affiche un bref avis indiquant que l'enregistrement de votre mot personnalisé est en cours.



- Si le mot personnalisé est sauvegardé, une tonalité de réussite se fait entendre et l'écran affiche un bref avis de réussite.
- Sinon, une tonalité grave se fait entendre et l'écran affiche un bref avis d'échec.



Ajouter des mots personnalisés



Vous pouvez ajouter des mots personnalisés dans le dictionnaire intégré de la radio.



- 1 Appuyez sur  pour accéder au menu.



- 2 Appuyez sur  ou  jusqu'à Utilitaires.
Appuyez sur  pour effectuer la sélection.

- 3 Appuyez sur  ou  jusqu'au Paramètres de la radio. Appuyez sur  pour effectuer la sélection.

- 4 Appuyez sur  ou  jusqu'à Saisie texte.
Appuyez sur  pour effectuer la sélection.

- 5 Appuyez sur  ou  jusqu'à Mes mots.
Appuyez sur  pour effectuer la sélection.

- 6 Appuyez sur  ou  jusqu'à Ajouter mot.
Appuyez sur  pour effectuer la sélection.
L'écran affiche la liste des mots personnalisés.

- 7 Utilisez le clavier pour modifier votre mot personnalisé.
 - Appuyez sur  pour déplacer le curseur d'une espace vers la gauche.
 - Appuyez sur la touche  pour déplacer le curseur d'une espace vers la droite.
 - Appuyez sur la touche  pour supprimer les caractères inutiles.

- Appuyez longuement sur  pour modifier le mode de saisie de texte.

-
- 8 Appuyez sur  une fois que votre mot personnalisé est terminé.
-



L'écran affiche un bref avis indiquant que l'enregistrement de votre mot personnalisé est en cours.



- Si le mot personnalisé est sauvegardé, une tonalité de réussite se fait entendre et l'écran affiche un bref avis de réussite.
- Sinon, une tonalité grave se fait entendre et l'écran affiche un bref avis d'échec.



Supprimer un mot personnalisé



Suivez la procédure suivante pour supprimer les mots personnalisés enregistrés sur votre radio.



- 1 Appuyez sur  pour accéder au menu.
-



- 2 Appuyez sur  ou  jusqu'à Utilitaires. Appuyez sur  pour effectuer la sélection.
-

- 3 Appuyez sur  ou  jusqu'au Paramètres de la radio. Appuyez sur  pour effectuer la sélection.
-





- 4 Appuyez sur  ou  jusqu'à Saisie texte. Appuyez sur  pour effectuer la sélection.
-

- 5 Appuyez sur  ou  jusqu'à Mes mots. Appuyez sur  pour effectuer la sélection.
-

- 6 Appuyez sur  ou  jusqu'au mot voulu. Appuyez sur  pour effectuer la sélection.
-





- 7 Appuyez sur  ou  jusqu'à Supprimer. Appuyez sur  pour effectuer la sélection.
-



8 Sélectionnez un des éléments suivants :



- Au message Supprimer l'entrée?, appuyez sur  pour sélectionner Oui. L'écran affiche Entrée supprimée.
 - Appuyez sur  ou  jusqu'à Non. Appuyez sur  pour revenir à l'écran précédent.
-



Supprimer tous les mots personnalisés



Suivez la procédure suivante pour supprimer tous les mots personnalisés du dictionnaire intégré de votre radio.

- 1 Appuyez sur  pour accéder au menu.
 - 2 Appuyez sur  ou  jusqu'à Utilitaires. Appuyez sur  pour effectuer la sélection.
-



- 3 Appuyez sur  ou  jusqu'au Paramètres de la radio. Appuyez sur  pour effectuer la sélection.
-

- 4 Appuyez sur  ou  jusqu'à Saisie texte. Appuyez sur  pour effectuer la sélection.
-

- 5 Appuyez sur  ou  jusqu'à Mes mots. Appuyez sur  pour effectuer la sélection.
-

- 6 Appuyez sur  ou  jusqu'à Tout supprimer. Appuyez sur  pour effectuer la sélection.
-

- 7 Faites un des suivants :
 - Au message Supprimer l'entrée?, appuyez sur  pour sélectionner Oui. L'écran affiche Ttes entrées supprimées.

- Appuyez sur  ou  jusqu'à **Non** pour revenir à l'écran précédent. Appuyez sur  pour effectuer la sélection.

Tickets de tâche

Cette fonction permet à votre radio de recevoir des messages du répartiteur dressant la liste des tâches à effectuer.



AVIS:

Cette fonction peut être personnalisée grâce au CPS selon les exigences des utilisateurs. Pour obtenir des renseignements supplémentaires, adressez-vous à votre détaillant ou à votre administrateur de système.

Il y a deux dossiers qui contiennent différents tickets de tâche :

Le dossier **Mes tâches**

Les tickets de tâche personnalisés attribués à votre signature dans l'ID utilisateur.

Le dossier **Tâches partagées**

Les tickets de tâche partagés attribués à un groupe de personnes.

Vous pouvez répondre aux tickets de tâche afin de les classer dans les dossiers de tickets de tâche. Par défaut, les dossiers sont **Tous**, **Nouveaux**, **Commencés** et **Terminés**. Pour obtenir dix autres dossiers, adressez-vous à votre détaillant ou à votre administrateur de système.



AVIS:

Les tickets de tâche sont conservés même lorsque la radio est mise hors tension, puis remise sous tension.

Tous les tickets de tâche sont situés dans le dossier **Tous**. Selon la façon dont votre radio est programmée, les tickets de tâche sont triés par leur niveau de priorité suivi par l'heure de réception. Les nouveaux tickets de tâche, ceux avec les plus récents changements à l'état et ceux avec la plus haute priorité sont affichés en premier. Lorsque le nombre maximum de tickets de tâche est atteint, le prochain ticket de tâche remplace automatiquement le dernier ticket de tâche sur la radio. Votre radio prend en charge un maximum de 100 ou 500 tickets de tâche, selon le modèle de radio. Pour obtenir des renseignements supplémentaires, adressez-vous à votre détaillant ou à votre administrateur de système. Votre radio détectera et annulera automatiquement les tickets de tâche dupliqués qui possèdent le même ID de ticket de tâche.

Selon l'importance du ticket de tâche, le répartiteur ajoute un niveau de priorité pour eux. Il existe trois niveaux de priorité : Priorité 1, Priorité 2 et Priorité 3. La Priorité 1 est la plus haute priorité et la Priorité 3 est la priorité la plus basse. Il existe également des tickets de tâche sans aucune priorité.

Votre radio est mise à jour conformément lorsque le répartiteur effectue les changements suivants :



- Modifier le contenu de tickets de tâche.
- Ajouter ou modifier le niveau de priorité de tickets de tâche.
- Déplacer les tickets de tâche d'un dossier à un autre dossier.
- Annuler des tickets de tâche.



Accès au dossier Tickets de tâche



Suivez la procédure d'accès au dossier Tickets de tâche.

- 1 Faites un des suivants :
 - Appuyez sur la touche programmée **Tickets de tâche**. Passez à [étape 3](#).

- Appuyez sur  pour accéder au menu.

-
- 2 Appuyez sur  ou  pour voir les Tickets de tâche. Appuyez sur  pour effectuer la sélection.



-
- 3 Appuyez sur  ou  jusqu'au dossier voulu. Appuyez sur  pour effectuer la sélection.

-
- 4 Appuyez sur  ou  jusqu'au ticket de tâche voulu. Appuyez sur  pour effectuer la sélection.

Connexion ou déconnexion du serveur distant

Cette fonction permet de se connecter et de se déconnecter du serveur distant en utilisant votre ID utilisateur.

- 1 Appuyez sur  pour accéder au menu.

2 Appuyez sur  ou  jusqu'à Connexion.

Appuyez sur  pour effectuer la sélection.

Si vous êtes déjà connecté, l'option Déconnexion s'affiche dans le menu.

L'écran affiche un bref avis indiquant que l'exécution de la requête est en cours.

3 Attendez la confirmation.

En cas de réussite :

- Une tonalité de réussite se fait entendre.
- L'écran affiche un bref avis de réussite.

En cas d'échec :

- Une tonalité d'échec se fait entendre.
- L'écran affiche un bref avis d'échec.



Création de tickets de tâche

Votre radio peut créer des tickets de tâche, basés sur un modèle de ticket de tâche, et envoyer la liste des tâches à accomplir.

Un logiciel de programmation CPS est nécessaire pour configurer le modèle de ticket de tâche.

1 Appuyez sur  pour accéder au menu.

2 Appuyez sur  ou  jusqu'aux Tickets de tâche. Appuyez sur  pour effectuer la sélection.

3 Appuyez sur  ou  jusqu'à Créer un ticket. Appuyez sur  pour effectuer la sélection.

Répondre à des tickets de tâche

Suivez la procédure suivante pour répondre à des tickets de tâche sur votre radio.

1 Appuyez sur  pour accéder au menu.

2 Appuyez sur  ou  jusqu'aux Tickets de tâche. Appuyez sur  pour effectuer la sélection.

3 Appuyez sur  ou  jusqu'au dossier voulu.

Appuyez sur  pour effectuer la sélection.

4 Appuyez sur  ou  jusqu'au ticket de tâche voulu.

Appuyez sur  pour effectuer la sélection.

5 Appuyez de nouveau sur  pour accéder au sous-menu.

Vous pouvez également appuyer sur la touche numérique correspondante (de 1 à 9) jusqu'à

Réponse rapide.

6 Appuyez sur  ou  jusqu'au ticket de tâche voulu.

Appuyez sur  pour effectuer la sélection.

L'écran affiche un bref avis indiquant que l'exécution de la requête est en cours.

7 Attendez la confirmation.

En cas de réussite :

- Une tonalité de réussite se fait entendre.

- L'écran affiche un bref avis de réussite.

En cas d'échec :



- Une tonalité d'échec se fait entendre.
 - L'écran affiche un bref avis d'échec.
-



Envoi de tickets de tâche en utilisant un modèle de ticket de tâche

Si votre radio est configurée avec un modèle de ticket de tâche, effectuez les opérations suivantes pour envoyer le ticket de tâche.

1 Utilisez le clavier numérique pour saisir le numéro de salle requis. Appuyez sur  pour effectuer la sélection.

2 Appuyez sur  ou  jusqu'à État de salle. Appuyez sur  pour effectuer la sélection.







- 3** Appuyez sur  ou  jusqu'à l'option voulue.
Appuyez sur  pour effectuer la sélection.
-

- 4** Appuyez sur  ou  jusqu'à Envoyer.
Appuyez sur  pour effectuer la sélection.
L'écran affiche un bref avis indiquant que l'exécution de la requête est en cours.
-

- 5** Attendez la confirmation.
En cas de réussite :
- Une tonalité de réussite se fait entendre.
 - L'écran affiche un bref avis de réussite.
- En cas d'échec :
- Une tonalité d'échec se fait entendre.
 - L'écran affiche un bref avis d'échec.
-

Envoi de tickets de tâche en utilisant plus d'un modèle de ticket de tâche

Si votre radio est configurée avec plus d'un modèle de ticket de tâche, effectuez les opérations suivantes pour envoyer les tickets de tâche.

- 1** Appuyez sur  ou  jusqu'à l'option voulue.
Appuyez sur  pour effectuer la sélection.
-
- 2** Appuyez sur  ou  jusqu'à Envoyer.
Appuyez sur  pour effectuer la sélection.
L'écran affiche un bref avis indiquant que l'exécution de la requête est en cours.
-
- 3** Attendez la confirmation.
En cas de réussite :
- Une tonalité de réussite se fait entendre.
 - L'écran affiche un bref avis de réussite.
- En cas d'échec :
- Une tonalité d'échec se fait entendre.



- L'écran affiche un bref avis d'échec.



Suppression de tickets de tâche

Suivez la procédure suivante pour supprimer des tickets de tâche de votre radio.

- 1 Faites un des suivants :
 - Appuyez sur la touche programmée **Tickets de tâche**. Passez à **étape 4**
 - Appuyez sur  pour accéder au menu.



-
- 2 Appuyez sur  ou  jusqu'aux Tickets de tâche. Appuyez sur  pour effectuer la sélection.

-
- 3 Appuyez sur  ou  jusqu'au dossier voulu. Appuyez sur  pour effectuer la sélection.

-
- 4 Appuyez sur  ou  jusqu'au dossier Tous. Appuyez sur  pour effectuer la sélection.

-
- 5 Appuyez sur  ou  jusqu'au ticket de tâche voulu. Appuyez sur  pour effectuer la sélection.

-
- 6 Appuyez de nouveau sur  pendant que le bon de travail est affiché.

-
- 7 Appuyez sur  ou  jusqu'à Supprimer. Appuyez sur  pour effectuer la sélection. L'écran affiche un bref avis indiquant que l'exécution de la requête est en cours.

-
- 8 Attendez la confirmation.

En cas de réussite :

- Une tonalité de réussite se fait entendre.
- L'écran affiche un bref avis de réussite.

En cas d'échec :

- Une tonalité d'échec se fait entendre.
 - L'écran affiche un bref avis d'échec.
-



Supprimer tous les tickets de tâche



Suivez la procédure suivante pour supprimer tous les tickets de tâche de votre radio.



1 Faites un des suivants :

- Appuyez sur la touche programmée **Tickets de tâche**. Passez à **étape 3**.
- Appuyez sur  pour accéder au menu.







2 Appuyez sur  ou  jusqu'aux Tickets de tâche. Appuyez sur  pour effectuer la sélection.

3 Appuyez sur  ou  jusqu'au dossier voulu. Appuyez sur  pour effectuer la sélection.

4 Appuyez sur  ou  jusqu'au dossier Tous. Appuyez sur  pour effectuer la sélection.

5 Appuyez sur  ou  jusqu'à Tout supprimer. Appuyez sur  pour effectuer la sélection.

6 Faites un des suivants :

- Appuyez sur  ou  jusqu'à Oui. Appuyez sur  pour effectuer la sélection. L'écran affiche un bref avis de réussite.
- Appuyez sur  ou  jusqu'à Non. Appuyez sur  pour effectuer la sélection. La radio revient à l'écran précédent.

Cryptage

Cette fonction fait appel à une solution de brouillage logiciel pour prévenir l'écoute d'un canal par des utilisateurs non autorisés. Les parties de la transmission correspondant au signal et à l'identification de l'utilisateur ne sont pas brouillées.

Sur votre radio, la fonction de cryptage doit être activée sur le canal pour envoyer une transmission cryptée; l'activation

de la fonction n'est cependant pas nécessaire à la réception d'une telle transmission. Pendant qu'un canal crypté est sélectionné, la radio continue d'être en mesure de recevoir des transmissions non brouillées.

Certains modèles de radio n'offrent pas cette fonction de cryptage, ou peuvent avoir une configuration différente. Pour obtenir des renseignements supplémentaires, adressez-vous à votre détaillant ou à votre administrateur de système.

Votre radio prend en charge deux types de cryptage, mais un seul peut être attribué à votre radio. Ce sont les suivants :

- Cryptage de base
- Cryptage amélioré

Pour décoder un appel ou une transmission de données crypté, votre radio doit être programmée de manière à avoir la même clé de cryptage (cryptage de base) ou la même valeur et le même ID de clé (cryptage amélioré) que la radio à l'origine de la transmission.

Si votre radio reçoit un appel brouillé correspondant à une clé de cryptage différente ou à une valeur et à un ID de clé différents, vous entendrez une transmission brouillée (cryptage de base) ou vous n'entendrez rien du tout (cryptage amélioré).

Sur un canal crypté, votre radio est en mesure de recevoir des appels débrouillés, selon la façon dont votre radio est programmée. En outre, votre radio peut jouer un avertissement ou non, selon la façon dont elle est programmée.

Le voyant DEL vert s'allume pendant que la radio envoie une transmission cryptée et émet un clignotement rapide lorsque la radio reçoit une transmission cryptée.







AVIS:



Cette fonction n'est pas offerte dans les canaux de bandes citoyennes qui se trouvent dans la même fréquence.



Activer ou désactiver le cryptage

Suivez la procédure suivante pour activer ou désactiver la fonction confidentialité de votre radio.









- 1 Faites un des suivants :
 - Appuyez sur la touche programmée **Confidentialité**. Passez les étapes ci-dessous.
 - Appuyez sur  pour accéder au menu.

2 Appuyez sur  ou  jusqu'à Utilitaires. Appuyez sur  pour effectuer la sélection.

3 Appuyez sur  ou  jusqu'au Paramètres de la radio. Appuyez sur  pour effectuer la sélection.

4 Appuyez sur  ou  jusqu'à Confidentialité. Appuyez sur  pour effectuer la sélection.

5 Faites un des suivants :

- Appuyez sur  ou  jusqu'à Activer. Appuyez sur  pour effectuer la sélection. L'écran affiche  à côté du message Activé.
 - Appuyez sur  ou  jusqu'à Désactiver. Appuyez sur  pour effectuer la sélection. L'écran affiche  à côté du message Désactivé.
-

Réglages multisite

Ces fonctions peuvent être utilisées lorsque votre canal de radio actuel fait partie d'une configuration Sites IP interconnectés ou Capacity Plus–Multisite.

Lancer une recherche de site manuelle

Suivez la procédure pour démarrer la recherche de site manuelle lorsque la puissance du signal de réception est de mauvaise qualité afin d'essayer de trouver un site avec meilleur signal.

Si la radio détecte un nouveau site :

- Une tonalité de réussite se fait entendre.

Si la radio ne détecte pas de nouveau site :

- Une tonalité d'échec se fait entendre.

Verrouillage de site activé/désactivé

Lorsque cette fonction est activée, la radio ne recherche que le site courant. Lorsqu'elle est désactivée, la radio recherche d'autres sites en plus du site courant.

Appuyez sur la touche programmée **Verr. Site**.

Si la fonction **Verrouillage de site** est activée :











- Une tonalité de réussite retentit pour indiquer que la radio s'est verrouillée sur le site courant.
- L'écran affiche Site verrouillé.

Si la fonction **Verrouillage du site** est désactivée :

- Une tonalité d'échec retentit pour indiquer que la radio est déverrouillée.
- L'écran affiche Site Déverrouillé.

Accès à la liste de sites voisins

Cette fonction permet à l'utilisateur de vérifier la liste des sites adjacents du site d'accueil actuel. Suivez la procédure pour accéder à la liste des sites voisins :

- 1 Appuyez sur  pour accéder au menu.
- 2 Appuyez sur  ou  jusqu'à Utilitaires. Appuyez sur  pour effectuer la sélection.
- 3 Appuyez sur  ou  jusqu'à Info de la radio. Appuyez sur  pour effectuer la sélection.
- 4 Appuyez sur  ou  pour voir les sites voisins. Appuyez sur  pour effectuer la sélection.

Sécurité

Cette fonction vous permet d'activer ou désactiver n'importe quelle radio du réseau.

Par exemple, vous pourriez vouloir désactiver une radio volée pour empêcher le voleur de s'en servir, puis la réactiver une fois qu'elle est de nouveau en votre possession.

Vous ne recevrez aucune confirmation si vous appuyez sur

 pendant que le processus d'activation ou de désactivation de la radio est en cours.





AVIS:

Pour obtenir des renseignements supplémentaires, adressez-vous à votre détaillant ou à votre administrateur de système.

Désactivation des radios

Suivez la procédure suivante pour désactiver votre radio.

1 Appuyez sur la touche programmée **Désac radio**.

2 Appuyez sur  ou  jusqu'à l'alias ou l'ID voulu.

3 Appuyez sur  pour effectuer la sélection.

L'écran affiche un bref avis indiquant que l'exécution de la requête est en cours. Le voyant DEL vert clignote.

4 Attendez la confirmation.

En cas de réussite :

- Une tonalité de réussite se fait entendre.
- L'écran affiche un bref avis de réussite.



En cas d'échec :

- Une tonalité d'échec se fait entendre.
 - L'écran affiche un bref avis d'échec.
-

Désactivation des radios à l'aide de la liste de contacts

Suivez la procédure suivante pour désactiver votre radio à l'aide de la liste de contacts.

1 Appuyez sur  pour accéder au menu.

2 Appuyez sur  ou  jusqu'à **Contacts**. Appuyez sur  pour effectuer la sélection.

3 Appuyez sur  ou  jusqu'à l'alias ou l'ID voulu. Appuyez sur  pour effectuer la sélection.

4 Appuyez sur  ou  jusqu'à Désactiver la radio.

5 Appuyez sur  pour effectuer la sélection.
L'écran affiche un bref avis indiquant que l'exécution de la requête est en cours. Le voyant DEL vert clignote.

6 Attendez la confirmation.

En cas de réussite :

- Une tonalité de réussite se fait entendre.
- L'écran affiche un bref avis de réussite.



En cas d'échec :

- Une tonalité d'échec se fait entendre.
 - L'écran affiche un bref avis d'échec.
-



Désactivation des radios à l'aide de la numérotation manuelle

Suivez la procédure suivante pour désactiver votre radio à l'aide de la numérotation manuelle.

1 Appuyez sur  pour accéder au menu.

2 Appuyez sur  ou  jusqu'à Contacts. Appuyez sur  pour effectuer la sélection.

3 Appuyez sur  ou  jusqu'à Num. manuelle. Appuyez sur  pour effectuer la sélection.

4 Appuyez sur  ou  jusqu'au Numéro de la radio. Appuyez sur  pour effectuer la sélection.
La première ligne de l'écran affiche Numéro de la radio :

5 Entrez l'ID de l'abonné et appuyez sur  pour continuer.

6 Appuyez sur  ou  jusqu'à Désactiver la radio.

7 Appuyez sur  pour effectuer la sélection.
L'écran affiche un bref avis indiquant que l'exécution de la requête est en cours. Le voyant DEL vert clignote.

8 Attendez la confirmation.

En cas de réussite :

- Une tonalité de réussite se fait entendre.
- L'écran affiche un bref avis de réussite.



En cas d'échec :

- Une tonalité d'échec se fait entendre.
 - L'écran affiche un bref avis d'échec.
-

Activation des radios

Suivez la procédure suivante pour activer la radio.

1 Appuyez sur la touche programmée **Activer la radio**.

2 Appuyez sur  ou  jusqu'à l'alias ou l'ID voulu.

3 Appuyez sur  pour effectuer la sélection.
L'écran affiche le message Radio activée ainsi que l'alias ou l'ID d'abonné. Le voyant DEL vert s'allume.

4 Attendez la confirmation.

En cas de réussite :

- Une tonalité de réussite se fait entendre.
- L'écran affiche un bref avis de réussite.









En cas d'échec :

- Une tonalité d'échec se fait entendre.

- L'écran affiche un bref avis d'échec.

Activation des radios à l'aide de la liste de contacts

Suivez la procédure suivante pour activer votre radio à l'aide de la liste de contacts.

- 1 Appuyez sur  pour accéder au menu.
- 2 Appuyez sur  ou  jusqu'à **Contacts**.
Appuyez sur  pour effectuer la sélection.
- 3 Appuyez sur  ou  jusqu'à l'alias ou l'ID voulu. Appuyez sur  pour effectuer la sélection.
- 4 Appuyez sur  ou  pour activer la radio.

- 5 Appuyez sur  pour effectuer la sélection.

Le voyant DEL vert clignote. L'écran affiche le message **Radio activée** ainsi que l'alias ou l'ID d'abonné. Le voyant DEL vert s'allume.

- 6 Attendez la confirmation.

En cas de réussite :

- Une tonalité de réussite se fait entendre.
- L'écran affiche un bref avis de réussite.



En cas d'échec :

- Une tonalité d'échec se fait entendre.
- L'écran affiche un bref avis d'échec.



Activation des radios à l'aide de la numérotation manuelle

Suivez la procédure suivante pour activer la radio à l'aide de la numérotation manuelle.



- 1 Appuyez sur  pour accéder au menu.

2 Appuyez sur  ou  jusqu'à Contacts.
Appuyez sur  pour effectuer la sélection.

3 Appuyez sur  ou  jusqu'à Num.
manuelle. Appuyez sur  pour effectuer la sélection.

4 Appuyez sur  ou  jusqu'à Appel indiv..
Appuyez sur  pour effectuer la sélection.
La première ligne de l'écran affiche Numéro de la radio :

5 Entrez l'ID de l'abonné et appuyez sur  pour continuer.

6 Appuyez sur  ou  pour activer la radio.

7 Appuyez sur  pour effectuer la sélection.

Le voyant DEL vert clignote. L'écran affiche le message Radio activée ainsi que l'alias ou l'ID d'abonné. Le voyant DEL vert s'allume.

8 Attendez la confirmation.

En cas de réussite :

- Une tonalité de réussite se fait entendre.
- L'écran affiche un bref avis de réussite.

En cas d'échec :

- Une tonalité d'échec se fait entendre.
 - L'écran affiche un bref avis d'échec.
-

Travailleur solitaire

Cette fonction déclenche le mode d'urgence s'il n'y a aucun signe d'activité par l'utilisateur, tel qu'appuyer sur une quelconque touche de la radio ou activer le sélecteur de canal, pendant une durée prédéfinie.

Si aucune activité n'est détectée pendant la durée prédéfinie, la radio avertit l'utilisateur de l'expiration du délai d'inactivité au moyen d'un signal sonore.

Si l'utilisateur ne donne aucune réponse à l'avertissement avant l'expiration du délai prédéfini subséquent, la radio active une alarme d'urgence.

Seulement une des alarmes d'urgence suivantes est associée à cette fonction :

- Alarme d'urgence
- Alarme d'urgence avec appel
- Alarme d'urgence suivie d'un appel vocal 

La radio demeure dans l'état d'urgence, ce qui permet la transmission des messages vocaux, jusqu'à ce qu'une action soit exécutée. Reportez-vous à [Fonctionnement d'urgence à la page 447](#) pour en savoir plus sur les façons de quitter le mode Urgence.



AVIS:

L'exécution de cette fonction est limitée aux radios sur lesquelles la fonction est activée. Pour obtenir des renseignements supplémentaires, adressez-vous à votre détaillant ou à votre administrateur de système.

Bluetooth

Cette fonctionnalité vous permet d'utiliser votre radio avec un appareil compatible Bluetooth (un accessoire) par l'intermédiaire d'une connexion Bluetooth. Votre radio prend en charge les appareils compatibles Bluetooth de marque Motorola Solutions et autres produits commerciaux prêts à l'emploi.

La connectivité Bluetooth fonctionne dans un rayon de 10 m (32 pi) entre deux appareils en ligne directe. C'est-à-dire un chemin sans obstruction entre votre radio et votre dispositif Bluetooth. Pour obtenir un haut degré de fiabilité, Motorola Solutions recommande de ne pas séparer la radio et l'accessoire.

À la périphérie de la zone de couverture, la qualité de la réception diminue, et la voix et la tonalité peuvent devenir brouillées ou saccadées. Pour corriger ce problème, il suffit de rapprocher votre radio et l'appareil Bluetooth (à moins de 10 m l'un de l'autre) afin de rétablir la réception. La fonction Bluetooth de votre radio a une puissance maximale de 2,5 mW (4 dBm) dans un rayon de 10 m.

Votre radio peut prendre en charge jusqu'à trois connexions Bluetooth simultanées avec des appareils compatibles Bluetooth de différents types. Vous pouvez connecter, par exemple, un écouteur, un scanner et un

appareil PTT. Les connexions Bluetooth simultanées avec plusieurs appareils Bluetooth de même type ne sont pas prises en charge.

Reportez-vous au manuel d'utilisation de votre dispositif Bluetooth pour plus de détails sur l'ensemble des possibilités de votre périphérique compatible Bluetooth.







AVIS:





Si cette option est désactivée par le CPS, toutes les fonctionnalités associées à Bluetooth sont désactivées et la base de données d'appareil Bluetooth est effacée.









Activer ou désactiver Bluetooth

Suivez la procédure suivante pour activer ou désactiver Bluetooth.

- 1 Appuyez sur  pour accéder au menu.

- 2 Appuyez sur  ou  jusqu'à Bluetooth.
Appuyez sur  pour effectuer la sélection.

- 3 Appuyez sur  ou  jusqu'à Mon État.
Appuyez sur  pour effectuer la sélection.
L'écran affiche Activé et Arrêt. L'état actuel est indiqué par l'icône .



- 4 Faites un des suivants :
 - Appuyez sur  ou  jusqu'à Activer.
Appuyez sur  pour effectuer la sélection.
L'écran affiche  à côté du message Activé.
 - Appuyez sur  ou  jusqu'à Désactiver.
Appuyez sur  pour effectuer la sélection.
L'écran affiche  à côté du message Désactivé.



Connexion aux dispositifs Bluetooth

Suivez la procédure pour vous connecter à des appareils Bluetooth disponibles.









Allumez l'appareil Bluetooth et lancez le mode d'appariement.



1 Appuyez sur  pour accéder au menu.

2 Appuyez sur  ou  jusqu'à Bluetooth.
Appuyez sur  pour effectuer la sélection.

3 Appuyez sur  ou  jusqu'à Appareils.
Appuyez sur  pour effectuer la sélection.

4 Faites un des suivants :

- Appuyez sur  ou  jusqu'à l'appareil voulu. Appuyez sur  pour effectuer la sélection.
 - Appuyez sur  ou  jusqu'à Recherche pour trouver des appareils disponibles. Appuyez sur  ou  jusqu'à l'appareil voulu.
Appuyez sur  pour effectuer la sélection.
-

5 Appuyez sur  ou  jusqu'à Connecter.

Appuyez sur  pour effectuer la sélection.

Il est possible que l'appariement de votre appareil Bluetooth nécessite d'autres étapes. Reportez-vous aux manuels d'utilisation des appareils compatibles Bluetooth.

L'écran affiche le message Connexion à <appareil>.

Attendez la confirmation.

En cas de réussite :

- Une tonalité de réussite se fait entendre.
- L'écran affiche <appareil> connecté et l'icône de **connexion Bluetooth**.
- L'écran affiche  à côté de l'appareil sélectionné.

En cas d'échec :

- Une tonalité d'échec se fait entendre.
- L'écran affiche le message Connexion échouée.

**AVIS:**



Si un code NIP est nécessaire, voir la section [Accès aux radios à l'aide des mots de passe à la page 201](#).



Connexion aux dispositifs Bluetooth en mode Détection

Suivez la procédure suivante pour vous connecter à des appareils Bluetooth en mode détection.

Allumez l'appareil Bluetooth et lancez le mode d'appariement.

- 1 Appuyez sur  pour accéder au menu.

- 2 Appuyez sur  ou  jusqu'à Bluetooth.
Appuyez sur  pour effectuer la sélection.

- 3 Appuyez sur  ou  jusqu'à Me chercher.
Appuyez sur  pour effectuer la sélection. Votre radio peut maintenant être détectée par d'autres

appareils Bluetooth pendant une durée programmée. Il s'agit du Mode détection.

Attendez la confirmation.

En cas de réussite :

- Une tonalité de réussite se fait entendre.
- L'écran affiche <appareil> connecté et l'icône de **connexion Bluetooth**.
- L'écran affiche ✓ à côté de l'appareil sélectionné.



En cas d'échec :



- Une tonalité d'échec se fait entendre.
- L'écran affiche le message Connexion échouée.

Déconnexion de dispositifs Bluetooth

Suivez la procédure suivante pour vous déconnecter de dispositifs Bluetooth.

- 1 Appuyez sur  pour accéder au menu.

- 2 Appuyez sur  ou  jusqu'à Bluetooth.
Appuyez sur  pour effectuer la sélection.

3 Appuyez sur  ou  jusqu'à Appareils.

Appuyez sur  pour effectuer la sélection.

4 Appuyez sur  ou  jusqu'à l'appareil voulu.

Appuyez sur  pour effectuer la sélection.

5 Appuyez sur  ou  jusqu'à Déconnecter.

Appuyez sur  pour effectuer la sélection.

L'écran affiche le message Déconnexion de <appareil>.



AVIS:

Il est possible que la déconnexion de votre appareil Bluetooth nécessite d'autres étapes. Reportez-vous aux manuels d'utilisation des appareils compatibles Bluetooth.

Attendez la confirmation.

- Une tonalité se fait entendre.
- L'écran affiche <appareil> déconnecté et l'icône **Bluetooth connecté** disparaît.

- Le  disparaît à côté du de l'appareil connecté.

Changer l'acheminement du signal audio entre le haut-parleur interne de la radio et le dispositif Bluetooth

Suivez la procédure pour faire basculer l'acheminement du signal audio entre le haut-parleur interne de la radio et le dispositif Bluetooth externe.

Appuyez sur la touche programmée **Interrupteur audio Bluetooth**.



L'écran affiche un des résultats suivants :



- Une tonalité se fait entendre. L'écran affiche Rout. audio vers radio.
- Une tonalité se fait entendre. L'écran affiche Rout. audio vers Bluetooth.



Affichage de renseignements détaillés sur les appareils



Suivez la procédure suivante pour afficher les détails de l'appareil sur votre radio.

- 1 Appuyez sur  pour accéder au menu.



- 2 Appuyez sur  ou  jusqu'à Bluetooth.
Appuyez sur  pour effectuer la sélection.



- 3 Appuyez sur  ou  jusqu'à Appareils.
Appuyez sur  pour effectuer la sélection.



- 4 Appuyez sur  ou  jusqu'à l'appareil voulu.
Appuyez sur  pour effectuer la sélection.



- 5 Appuyez sur  ou  jusqu'à Afficher les détails. Appuyez sur  pour effectuer la sélection.

- 1 Appuyez sur  pour accéder au menu.

- 2 Appuyez sur  ou  jusqu'à Bluetooth.
Appuyez sur  pour effectuer la sélection.

- 3 Appuyez sur  ou  jusqu'à Appareils.
Appuyez sur  pour effectuer la sélection.

- 4 Appuyez sur  ou  jusqu'à l'appareil voulu.
Appuyez sur  pour effectuer la sélection.

- 5 Appuyez sur  ou  jusqu'à Supprimer.
Appuyez sur  pour effectuer la sélection.
L'écran affiche Dispositif supprimé.



Supprimer le nom d'un dispositif



Vous pouvez retirer un dispositif déconnecté de la liste des dispositifs Bluetooth.



Gain du micro Bluetooth



Cette fonction permet à l'utilisateur de contrôler la valeur du gain du microphone de l'appareil Bluetooth connecté.

- 1 Appuyez sur  pour accéder au menu.

- 2 Appuyez sur  ou  jusqu'à Bluetooth.
Appuyez sur  pour effectuer la sélection.

- 3 Appuyez sur  ou  jusqu'à Gain mic. BT.
Appuyez sur  pour effectuer la sélection.

- 4 Appuyez sur  ou  jusqu'au type de gain du micro Bluetooth et aux valeurs courantes. Appuyez sur  pour effectuer la sélection. Vous pouvez modifier les valeurs ici.

- 5 Appuyez sur  ou  pour augmenter ou diminuer les valeurs. Appuyez sur  pour effectuer la sélection.

Localisation interne



AVIS:







La fonction Localisation interne concerne uniquement les modèles avec la dernière version du logiciel et du matériel. Pour obtenir des renseignements supplémentaires, adressez-vous à votre détaillant ou à votre administrateur de système.

Emplacement doit être utilisé pour assurer le suivi de l'emplacement des utilisateurs de radio. Lorsque cette fonction est activée, la radio est en mode Détection limitée. Des balises dédiées sont utilisées pour localiser la radio et déterminer sa position.

Activation ou désactivation de la fonction Positionnement à l'intérieur

Vous pouvez activer ou désactiver le positionnement à l'intérieur en effectuant l'une des actions suivantes.

- Accédez à cette fonction à partir du menu.
 - a. Appuyez sur  pour accéder au menu.

- b. Appuyez sur  ou  jusqu'à Bluetooth puis sur appuyez sur  pour sélectionner.
- c. Appuyez sur  ou  jusqu'à Localis. interne puis sur appuyez sur  pour sélectionner.
- d. Appuyez sur  pour activer le positionnement à l'intérieur.

L'écran affiche Localis. interne activée.

Une tonalité de réussite se fait entendre.

L'un des événements suivants se produit :

- En cas de réussite, l'icône de positionnement à l'intérieur disponible apparaît sur l'écran d'accueil.
- En cas d'échec, l'écran affiche Échec activation. Une tonalité d'échec retentit.

- e. Appuyez sur  pour désactiver le positionnement à l'intérieur.

L'écran affiche Localis. interne désactivée.

Une tonalité de réussite se fait entendre.

L'un des événements suivants se produit :

- En cas de réussite, l'icône de positionnement à l'intérieur disponible disparaît de l'écran d'accueil.
 - En cas d'échec, l'écran affiche Échec désactivation. Une tonalité d'échec retentit.
- Accédez à cette fonction à partir de la touche programmée.
- a. Appuyez longuement sur la touche programmée **Localis. interne** pour activer cette fonction.
- L'écran affiche Localis. interne activée.
- Une tonalité de réussite se fait entendre.
- L'un des événements suivants se produit :
- En cas de réussite, l'icône de positionnement à l'intérieur disponible apparaît sur l'écran d'accueil.
 - En cas d'échec, l'écran affiche Échec activation. En cas d'échec, vous entendez une tonalité d'indication négative.

- b. Appuyez longuement sur la touche programmée **Localis. interne** pour désactiver cette fonction.

L'écran affiche **Localis. interne désactivée**. Une tonalité de réussite se fait entendre.



L'un des événements suivants se produit :

- En cas de réussite, l'icône de positionnement à l'intérieur disponible disparaît de l'écran d'accueil.
- En cas d'échec, l'écran affiche **Échec désactivation**. En cas d'échec, vous entendez une tonalité d'indication négative.



Accès aux données sur l'emplacement des balises de positionnement à l'intérieur

Suivez la procédure suivante pour accéder à l'information des balises d'emplacement intérieur.

- 1 Appuyez sur  pour accéder au menu.

- 2 Appuyez sur  ou  jusqu'à **Bluetooth** puis sur appuyez sur  pour sélectionner.

- 3 Appuyez sur  ou  jusqu'à **Localis. interne** puis sur appuyez sur  pour sélectionner.

- 4 Appuyez sur  ou  jusqu'à **Balises**, puis sur appuyez sur  pour sélectionner.

L'écran affiche les informations sur les balises.

Liste de notifications

Votre radio offre une liste de notification qui rassemble tous les événements « non lus » sur le canal, par exemple les messages texte, les messages de télémétrie, les appels manqués et les avertissements d'appel.

L'écran affiche l'icône **Notification** lorsque la liste de notification comprend au moins un événement.

La liste prend en charge au maximum quarante (40) événements non lus. Une fois la liste pleine, le prochain



événement remplace automatiquement l'événement le plus ancien. Une fois les événements lus, ils sont retirés de la liste de notifications.

Dans le cas de messages texte, d'appels manqués ou d'événements d'avertissement d'appel, le nombre maximum est de 30 messages texte et 10 appels manqués ou avertissements d'appel. Ce nombre maximum est fonction des capacités de liste de chaque fonction (tickets de tâche, message texte ou appels manqués et avertissements d'appel).

Accès à liste de notification

Suivez la procédure suivante pour accéder à la liste de notification sur votre radio.

- 1 Appuyez sur  pour accéder au menu.

- 2 Appuyez sur  ou  jusqu'à Notifications. Appuyez sur  pour effectuer la sélection.

- 3 Appuyez sur  ou  jusqu'à l'évènement voulu. Appuyez sur  pour effectuer la sélection.

Maintenez enfoncée la touche  pour revenir à l'écran d'accueil.

Système ARTS

Le système ARTS est une fonctionnalité analogique seulement conçue pour vous informer quand votre radio est en dehors de la zone de couverture des autres radios dotées du système ARTS.

Les radios dotées du système ARTS transmettent ou reçoivent périodiquement des signaux pour confirmer qu'elles se trouvent dans la zone de couverture l'une de l'autre.

Votre radio fournit des indications d'état comme suit :

Alerte initiale

Une tonalité se fait entendre.

L'écran affiche **A portée** après l'alias du canal.

Alerte ARTS dans la zone de couverture

Une tonalité se fait entendre, si programmée.

L'écran affiche **A** portée après l'alias du canal.

Alerte ARTS hors de la zone de couverture

Une tonalité se fait entendre. Le voyant DEL rouge clignote rapidement.

L'écran affiche **Hors de la zone de couverture** en alternance avec l'écran d'accueil.



AVIS:

Pour obtenir des renseignements supplémentaires, adressez-vous à votre détaillant ou à votre administrateur de système.

Programmation par onde radio

Votre détaillant peut mettre à jour à distance votre radio à partir de la programmation par radiocommunication (OTAP) sans connexion physique. De plus, certains paramètres peuvent être configurés à partir de la programmation par radiocommunication.

Lorsque votre radio est programmée par OTAP, le voyant DEL vert clignote.

Lorsque votre radio reçoit des données à volume élevé :

- L'écran affiche l'icône **Données à volume élevé**.
- Le canal devient occupé.

- Une tonalité d'échec se fait entendre si vous appuyez sur le bouton **PTT**.

Lorsque l'OTAP est terminée, selon la configuration :

- Une tonalité se fait entendre. L'écran affiche **Actualisation Redémarrage**. La radio redémarre en se mettant hors tension puis à nouveau sous tension.
- Vous pouvez sélectionner **Redémarrer maintenant** ou **Reporter**. Lorsque vous sélectionnez **Reporter**, votre radio revient à l'écran précédent. L'écran affiche l'icône **Retardateur OTAP** jusqu'à ce que le démarrage automatique se produise.

Lorsque votre radio se met sous tension après un redémarrage automatique :

- En cas de réussite, l'écran affiche **MàJ logiciel réussie**.
- En cas d'échec, l'écran affiche **Échec de la MàJ logiciel**.



Reportez-vous à [Vérification des informations de mise à jour du logiciel à la page 237](#) pour connaître la version logicielle mise à jour.



Sélection de modes de connexion de périphériques tiers



Suivez la procédure suivante pour sélectionner l'un des modes de connexion de périphériques tiers :



- Motorola Solutions
- PC et audio
- Accès aux données
- Télémétrie
- Générique

1 Appuyez sur  pour accéder au menu.

2 Appuyez sur  ou  jusqu'à Utilitaires.
Appuyez sur  pour effectuer la sélection.

3 Appuyez sur  ou  jusqu'au Paramètres de la radio. Appuyez sur  pour effectuer la sélection.

4 Appuyez sur  ou  jusqu'à Type câble.
Appuyez sur  pour effectuer la sélection.

5 Appuyez sur  ou  jusqu'au mode de connexion voulu. Appuyez sur  pour effectuer la sélection.

Cet écran montre le mode de connexion sélectionné. L'écran revient au menu précédent.

Indicateur d'intensité du signal reçu



Cette fonction vous permet de prendre connaissance des valeurs de l'indicateur d'intensité du signal reçu (RSSI).

L'écran affiche l'icône **RSSI** dans le coin supérieur droit. Consultez la section [Icônes d'affichage](#) pour des détails sur l'icône **RSSI**.

Affichage des valeurs RSSI (indicateur d'intensité de réception du signal)

Suivez la procédure suivant pour afficher les valeurs RSSI sur votre radio.

Lorsque vous êtes à l'écran d'accueil :

- 1 Appuyez trois fois sur la touche  et appuyez immédiatement trois fois sur la touche , le tout en 5 secondes.

L'écran affiche les valeurs RSSI courantes.

- 2 Maintenez enfoncée la touche  pour revenir à l'écran d'accueil.
-

Fonctions de verrouillage par mot de passe

Cette fonction vous permet de restreindre l'accès à la radio en demandant un mot de passe lorsqu'elle est allumée.

Vous pouvez utiliser un microphone à clavier ou les touches de **défilement vers le haut/bas** pour entrer le mot de passe.

Accès aux radios à l'aide des mots de passe



Suivez la procédure suivante pour accéder à votre radio en utilisant un mot de passe.

- 1 Entrez le mot de passe à quatre chiffres.



AVIS:

L'utilisation de l'interrupteur d'**urgence** au pied permet d'accéder à la radio sans devoir entrer un mot de passe.

- Utilisez le microphone à clavier.
 - Appuyez sur  ou  pour modifier la valeur numérique de chaque chiffre, puis appuyez sur  pour valider et passer au chiffre suivant.
-

- 2 Appuyez sur  pour saisir le mot de passe.

En cas de réussite, la radio est mise sous tension.

En cas d'échec :

- Après la première et seconde tentative, l'écran affiche Mot de passe erroné. Répétez l'étape [étape 1](#).
- Après une troisième tentative incorrecte, l'écran affiche Mot de passe erroné puis, Verrouillage radio. Une tonalité se fait entendre. Le voyant DEL jaune clignote en double. La radio se verrouille pendant 15 minutes.
- Si la radio est allumée, patientez 15 minutes et répétez les étapes de la section [Accès aux radios à l'aide des mots de passe à la page 201](#) pour accéder à la radio.
- Si la radio est éteinte, allumez-la. La radio redémarre la minuterie de verrouillage de 15 minutes. Une tonalité se fait entendre. Le voyant DEL jaune clignote en double. L'écran affiche Radio verrouillée.





**AVIS:**

En état de verrouillage, la radio réagit uniquement aux commandes du bouton **Marche/Arrêt/Volume** et de la touche programmée **Rétroéclairage**.

Patientez 15 minutes et répétez les étapes de la section [Accès aux radios à l'aide des mots de passe à la page 201](#) pour accéder à la radio.

Activation/désactivation du verrouillage par mot de passe



Suivez la procédure suivante pour activer ou désactiver le verrouillage par mot de passe de votre radio.

- 1 Appuyez sur  pour accéder au menu.
- 2 Appuyez sur  ou  jusqu'à Utilitaires. Appuyez sur  pour effectuer la sélection.

Déverrouillage de la radio



Lorsqu'elle est verrouillée, la radio ne peut recevoir aucun appel. Suivez la procédure suivante pour déverrouiller une radio verrouillée.

Faites un des suivants :

3 Appuyez sur  ou  jusqu'au Paramètres de la radio. Appuyez sur  pour effectuer la sélection.









4 Appuyez sur  ou  jusqu'à Mot de passe verr.. Appuyez sur  pour effectuer la sélection.

5 Entrez le mot de passe à quatre chiffres.

- Utilisez le microphone à clavier.
 - Appuyez sur  ou  pour modifier la valeur numérique de chaque chiffre, puis appuyez sur  pour valider et passer au chiffre suivant.
Vous entendrez une tonalité de réussite chaque fois que vous appuyez sur un chiffre.
-

6 Appuyez sur  pour saisir le mot de passe.
Si le mot de passe n'est pas valide, l'écran affiche Mot de passe erroné et revient automatiquement au menu précédent.



7 Faites un des suivants :



- Appuyez sur  ou  jusqu'à Activer.
Appuyez sur  pour effectuer la sélection.
L'écran affiche  à côté de Allumer.
 - Appuyez sur  ou  jusqu'à Eteindre.
Appuyez sur  pour effectuer la sélection.
L'écran affiche  à côté de Eteindre.
-



Changement de mot de passe

Suivez la procédure suivante pour modifier le mot de passe sur votre radio.

1 Appuyez sur  pour accéder au menu.



2 Appuyez sur  ou  jusqu'à Utilitaires.
Appuyez sur  pour effectuer la sélection.

3 Appuyez sur  ou  jusqu'au Paramètres de la radio. Appuyez sur  pour effectuer la sélection.

4 Appuyez sur  ou  jusqu'à Mot de passe verr.. Appuyez sur  pour effectuer la sélection.

5 Entrez le mot de passe actuel à quatre chiffres, puis appuyez sur  pour continuer.

Si le mot de passe n'est pas valide, l'écran affiche Mot de passe erroné et revient automatiquement au menu précédent.

6 Appuyez sur  ou  jusqu'à Changer le MdP. Appuyez sur  pour effectuer la sélection.

7 Entrez un nouveau mot de passe à quatre chiffres, puis appuyez sur  pour continuer.

8 Entrez de nouveau le mot de passe à quatre chiffres, puis appuyez sur  pour continuer.

En cas de réussite, l'écran affiche Mot de passe changé.

En cas d'échec, l'écran affiche Mots de passe incorrects.

L'écran revient automatiquement au menu précédent.







Configuration du panneau avant

Il est possible de personnaliser certains paramètres des fonctions de Configuration du panneau avant (FPC) afin d'améliorer l'utilisation de votre radio.

Entrée dans la Mode de configuration du panneau avant



Suivez la procédure suivante pour entrer en mode programmation à partir du panneau avant de votre radio.

Vous pouvez revenir à l'écran d'accueil à tout moment en maintenant la touche  enfoncée.

- 1 Appuyez sur  pour accéder au menu.
- 2 Appuyez sur  ou  jusqu'à Utilitaires.
Appuyez sur  pour effectuer la sélection.
- 3 Appuyez sur  ou  jusqu'à Programmer la radio. Appuyez sur  pour effectuer la sélection.

Modifier les paramètres de mode FPC

Utilisez les touches suivantes au besoin pendant la navigation dans les paramètres.

-  ,  – Pour parcourir les options, augmenter ou réduire les valeurs ou naviguer verticalement.
-  – Pour sélectionner l'option ou entrer dans un sous-menu.

-  – Appuyez brièvement pour revenir au menu précédent ou quitter l'écran de sélection. Maintenez cette touche enfoncée pour revenir à l'écran d'accueil.

Fonctionnement Wi-Fi

Cette fonction vous permet de configurer un réseau Wi-Fi et de vous connecter à ce réseau. Le Wi-Fi prend en charge les mises à jour de micrologiciel de la radio, de la codeplug, et des ressources telles que les modules de langues et les annonces vocales.



AVIS:

Cette fonction s'applique aux modèles XPR 5550e/XPR 5580e uniquement.

Wi-Fi® est une marque déposée de Wi-Fi Alliance®.

Votre radio prend en charge les réseaux Wi-Fi d'entreprise WEP/WPA/WPA2 personnels et WPA/WPA2 d'entreprise.

Réseau Wi-Fi WEP/WPA/WPA2 personnel

Utilise l'authentification basée sur clé prépartagée (mot de passe).

La clé prépartagée peut être saisie à partir du menu ou du CPS/RM.

Réseau Wi-Fi WPA/WPA2 d'entreprise

Utilise l'authentification basée sur certificat.

Votre radio doit être préconfigurée avec un certificat.



AVIS:

Vérifiez auprès de votre détaillant ou de votre administrateur de système la procédure de connexion à un réseau Wi-Fi WPA/WPA2 d'entreprise.

Activer ou désactiver la fonction Wi-Fi



La touche programmée **Wi-Fi Off** ou **On** est attribuée par défaut. Vérifiez auprès du détaillant ou de votre administrateur de système pour savoir de quelle façon votre radio a été programmée.



Les annonces vocales pour la touche programmée **Wi-Fi On** ou **Off** peut être personnalisé par le CPS selon les exigences des utilisateurs. Pour obtenir des renseignements supplémentaires, adressez-vous à votre détaillant ou à votre administrateur de système.



Vous pouvez activer ou désactiver le Wi-Fi en effectuant l'une des actions suivantes.



- Appuyez sur la touche programmée **Wi-Fi activé ou désactivé**. L'annonce vocale Activation du Wi-Fi ou Désactivation du Wi-Fi se fait entendre.
- Accédez à cette fonction à partir du menu.

a. Appuyez sur  pour accéder au menu.

b. Appuyez sur  ou  pour choisir le Wi-Fi, puis sur appuyez sur  pour sélectionner.

c. Appuyez sur  ou  pour choisir le Wi-Fi On, puis sur appuyez sur  pour sélectionner.

Appuyez sur  pour activer le Wi-Fi. L'écran affiche  à côté du message Activé.

Appuyez sur  pour désactiver le Wi-Fi. L'icône  ne s'affiche plus à côté du message Activé.

Connexion à un point d'accès réseau

Lorsque vous activez le Wi-Fi, la radio recherche un point d'accès réseau et s'y connecte.









AVIS:

Vous pouvez également vous connecter à un point d'accès réseau à partir du menu.

Les points d'accès réseau Wi-Fi WPA d'entreprise sont préconfigurés. Vérifiez auprès du détaillant ou de votre administrateur de système pour savoir de quelle façon votre radio a été programmée.

- 1 Appuyez sur  pour accéder au menu.

- 2 Appuyez sur  ou  pour choisir le Wi-Fi, puis sur appuyez sur  pour sélectionner.



- 3 Appuyez sur  ou  pour les Réseaux, puis sur appuyez sur  pour sélectionner.

- 4 Appuyez sur  ou  pour un point d'accès réseau, puis sur appuyez sur  pour sélectionner.



AVIS:

Pour un réseau Wi-Fi WPA d'entreprise, si un point d'accès réseau n'est pas préconfiguré, l'option *Connecter* n'est pas disponible.

- 5 Appuyez sur  ou  pour se Connecter, puis sur appuyez sur  pour sélectionner.

- 6 Pour un réseau Wi-Fi WPA personnel, entrez le mot de passe et appuyez sur  .

- 7 Pour un réseau Wi-Fi WPA d'entreprise, le mot de passe est configuré à partir de RM.
Si le mot de passe préconfiguré est correct, votre radio se connecte automatiquement au point d'accès réseau sélectionné.

Si le mot de passe préconfiguré n'est pas valide, l'écran affiche **Authenticat. - Échec** et revient automatiquement au menu précédent.

Lorsque la connexion est réussie, la radio affiche un avis et le point d'accès réseau est enregistré dans la liste des profils.

Si la connexion échoue, la radio affiche l'écran d'avis d'échec pendant un moment et revient automatiquement au menu précédent.

Vérification de l'état de la connexion Wi-Fi

Suivez la procédure suivante pour vérifier l'état de la connexion Wi-Fi.

Appuyez sur la touche programmée **Requête d'état Wi-Fi** pour connaître l'état de la connexion avec l'annonce vocale. L'annonce vocale indique Le Wi-Fi est désactivé, Le Wi-Fi est activé, mais il n'y a pas de connexion ou Le Wi-Fi est activé avec connexion.

- L'écran affiche **Wi-Fi désactivé** lorsque le Wi-Fi est désactivé.

- L'écran affiche **Wi-Fi activé, connecté** lorsque la radio est connectée à un réseau.
- L'écran affiche **Wi-Fi activé, déconnectée** lorsque le Wi-Fi est activé, mais que la radio n'est pas connectée à un réseau.

Les annonces vocales pour la touche programmée **Requête d'état Wi-Fi** peuvent être personnalisées par le CPS selon les exigences des utilisateurs. Pour obtenir des renseignements supplémentaires, adressez-vous à votre détaillant ou à votre administrateur de système.









AVIS:

La touche programmée **Requête d'état Wi-Fi** est affectée par défaut. Vérifiez auprès du détaillant ou de votre administrateur de système pour savoir de quelle façon votre radio a été programmée.

Actualisation de la liste de réseaux



Suivez la procédure pour actualiser la liste de réseaux.

- Effectuez les opérations suivantes pour actualiser la liste de réseaux à partir du menu.

- a. Appuyez sur  pour accéder au menu.
- b. Appuyez sur  ou  pour choisir le Wi-Fi, puis sur appuyez sur  pour sélectionner
- c. Appuyez sur  ou  pour les Réseaux, puis sur appuyez sur  pour sélectionner.

Quand vous entrez dans le menu Réseaux, la radio actualise automatiquement la liste des réseaux.

- Si vous êtes déjà dans le menu Réseaux, effectuez l'action suivante pour actualiser la liste de réseaux.

Appuyez sur  ou  pour Actualiser, puis sur appuyez sur  pour sélectionner.

La radio s'actualise et affiche la dernière liste de réseaux.

Ajout d'un réseau









AVIS:



Cette tâche n'est pas applicable aux réseaux Wi-Fi WPA d'entreprise.

Si un réseau préféré n'est pas dans la liste de réseaux disponibles, effectuez les opérations suivantes pour ajouter un réseau.



- 1 Appuyez sur  pour accéder au menu.

- 2 Appuyez sur  ou  pour choisir le Wi-Fi, puis sur appuyez sur  pour sélectionner.

- 3 Appuyez sur  ou  pour les Réseaux, puis sur appuyez sur  pour sélectionner.

- 4 Appuyez sur  ou  pour Ajouter un réseau, puis sur appuyez sur  pour sélectionner.

5 Entrez l'identifiant SSID (Service Set Identifier), puis appuyez sur  .



6 Appuyez sur  ou  pour l'Ouvrir, puis sur appuyez sur  pour sélectionner.



7 Entrez le mot de passe et appuyez sur  .
La radio affiche un mini-avis positif pour indiquer que le réseau est correctement enregistré.



Affichage des détails de points d'accès réseau

Vous pouvez afficher les détails des points d'accès réseau.

1 Appuyez sur  pour accéder au menu.

2 Appuyez sur  ou  pour choisir le Wi-Fi, puis sur appuyez sur  pour sélectionner.

3 Appuyez sur  ou  pour les Réseaux, puis sur appuyez sur  pour sélectionner.

4 Appuyez sur  ou  pour un point d'accès réseau, puis sur appuyez sur  pour sélectionner.

5 Appuyez sur  ou  pour afficher les détails, puis sur appuyez sur  pour sélectionner.



AVIS:

L'écran affiche des détails différents pour les points d'accès réseau Wi-Fi WPA personnel et Wi-Fi WPA d'entreprise.

Wi-Fi WPA personnel

Pour un point d'accès réseau connecté, votre radio affiche l'identifiant Service Set Identifier (SSID), le mode de sécurité, l'adresse Media Access Control (MAC) et l'adresse Internet Protocol (IP).

Pour un point d'accès réseau non connecté, votre radio affiche le SSID et le mode de sécurité.

Wi-Fi WPA d'entreprise

Pour un point d'accès réseau connecté, votre radio affiche le SSID, le mode de sécurité, l'identité, la méthode Extended Authentication Protocol (EAP), l'authentification de phase 2, le nom du certificat, l'adresse MAC, l'adresse IP, la passerelle, le DNS1 et le DNS2.

Pour un point d'accès réseau non connecté, votre radio affiche le SSID, le mode de sécurité, l'identité, la méthode EAP, l'authentification de phase 2 et le nom du certificat.

Retrait de points d'accès réseau









AVIS:



Cette tâche n'est pas applicable aux réseaux Wi-Fi d'entreprise.



Effectuez les opérations suivantes pour supprimer des points d'accès réseau dans la liste de profils.



- 1 Appuyez sur  pour accéder au menu.

- 2 Appuyez sur  ou  pour choisir le Wi-Fi, puis sur appuyez sur  pour sélectionner.

- 3 Appuyez sur  ou  pour les Réseaux, puis sur appuyez sur  pour sélectionner.

- 4 Appuyez sur  ou  pour sélectionner un point d'accès réseau, puis sur appuyez sur  pour sélectionner.

- 5 Appuyez sur  ou  pour le Supprimer, puis sur appuyez sur  pour sélectionner.

- 6 Appuyez sur  ou  pour choisir Oui, puis sur appuyez sur  pour sélectionner.

La radio affiche un mini-avis positif pour indiquer que le point d'accès réseau sélectionné est supprimé avec succès.

Utilitaires

Ce chapitre décrit le fonctionnement des fonctions utilitaires disponibles sur votre radio.

Niveau de silencieux

Vous pouvez régler le niveau du silencieux de la radio de manière à filtrer les appels indésirables à faible intensité de signal ou les canaux caractérisés par un bruit de fond anormalement élevé.

Normal

Il s'agit de la valeur par défaut.

Serré

Ce filtre élimine les appels indésirables ou le bruit de fond. Cependant, les appels provenant d'emplacements distants risquent alors d'être également éliminés.







AVIS:



Cette fonction n'est pas offerte dans les canaux de bandes citoyennes qui se trouvent dans la même fréquence.



Configuration du niveau du silencieux

Suivez la procédure suivante pour configurer le niveau du silencieux de recherche de votre radio.



- 1 Faites un des suivants :
 - Appuyez sur la touche programmée **Silencieux**. Ignorez les étapes suivantes.
 - Appuyez sur  pour accéder au menu.



- 2 Appuyez sur  ou  jusqu'à Utilitaires. Appuyez sur  pour effectuer la sélection.



- 3 Appuyez sur  ou  jusqu'au Paramètres de la radio. Appuyez sur  pour effectuer la sélection.



- 4 Appuyez sur  ou  jusqu'à Silencieux. Appuyez sur  pour effectuer la sélection.

5 Faites un des suivants :

- Appuyez sur  ou  jusqu'à Normal.

Appuyez sur  pour effectuer la sélection.
L'écran affiche  à côté de Normal.

- Appuyez sur  ou  jusqu'à Serré.

Appuyez sur  pour effectuer la sélection.
L'écran affiche  à côté de Serré.

L'écran revient automatiquement au menu précédent.

Niveaux de puissance

Vous pouvez personnaliser le niveau de puissance de votre radio en réglant celui-ci à Haut ou Bas pour chaque canal.

Haute

Ce réglage permet la communication avec des radios considérablement éloignées.

Faible

Ce réglage permet la communication avec des radios situées à proximité.



AVIS:

Cette fonction n'est pas offerte dans les canaux de bandes citoyennes qui se trouvent dans la même fréquence.

Configuration de la puissance



Suivez la procédure suivante pour configurer la puissance de votre radio.



1 Faites un des suivants :

- Appuyez sur la touche programmée **Niveau de puissance**. Passez les étapes ci-dessous.
- Appuyez sur  pour accéder au menu.

2 Appuyez sur  ou  jusqu'à



Utilitaires. Appuyez sur  pour effectuer la sélection.



3 Appuyez sur  ou  jusqu'au Paramètres de la radio. Appuyez sur  pour effectuer la sélection.



4 Appuyez sur  ou  jusqu'à Puissance.



Appuyez sur  pour effectuer la sélection.

5 Faites un des suivants :

- Appuyez sur  ou  jusqu'à Haut.

Appuyez sur  pour effectuer la sélection.
L'écran affiche  à côté de Haut.

- Appuyez sur  ou  jusqu'à Basse.

Appuyez sur  pour effectuer la sélection.
L'écran affiche  à côté de Basse.

6 Maintenez enfoncée la touche  pour revenir à l'écran d'accueil.

Activation ou désactivation des sonneries et alertes de la radio

Vous pouvez activer ou désactiver toutes les tonalités et alertes, si nécessaire, à l'exception de la tonalité d'alerte

entrante. Suivez la procédure suivante pour activer ou désactiver les sonneries et les alertes sur votre radio.



1 Faites un des suivants :



- Appuyez sur le bouton programmé **Sonneries/Alertes**. Ignorez les étapes suivantes.



- Appuyez sur  pour accéder au menu.

2 Appuyez sur  ou  jusqu'à

Utilitaires. Appuyez sur  pour effectuer la sélection.

3 Appuyez sur  ou  jusqu'au Paramètres de la radio. Appuyez sur  pour effectuer la sélection.

4 Appuyez sur  ou  jusqu'à Tonalités/Alertes. Appuyez sur  pour effectuer la sélection.

5 Appuyez sur  ou  jusqu'à Toutes Tnités. Appuyez sur  pour effectuer la sélection.



6 Appuyez sur  pour activer ou désactiver toutes les tonalités et tous les avertissements. L'écran affiche un des résultats suivants :



- Si la fonction est activée, ✓ apparaît à côté d'Activé.
 - Si cette option est désactivée, le ✓ ne s'affiche plus à côté de Activé.
-



Activer ou désactiver les tonalités du clavier



Suivez la procédure suivante pour activer ou désactiver les tonalités du clavier sur votre radio.

1 Appuyez sur  pour accéder au menu.

2 Appuyez sur  ou  jusqu'à Utilitaires. Appuyez sur  pour effectuer la sélection.

3 Appuyez sur  ou  jusqu'au Paramètres de la radio. Appuyez sur  pour effectuer la sélection.

4 Appuyez sur  ou  jusqu'à Tnités/ Avert.. Appuyez sur  pour effectuer la sélection.





5 Appuyez sur  ou  jusqu'à Tonalités du clavier numérique. Appuyez sur  pour effectuer la sélection.













6 Appuyez sur  pour activer ou désactiver les tonalités du clavier. L'écran affiche un des résultats suivants :

- Si la fonction est activée, ✓ apparaît à côté d'Activé.
- Si cette option est désactivée, le ✓ ne s'affiche plus à côté de Activé.

Configuration de la compensation de volume des sonneries et des alertes

Cette fonction permet de configurer le niveau sonore des sonneries et des alertes de manière à ce qu'il soit plus ou moins haut que celui de la voix. Suivez la procédure suivante pour configurer la compensation de volume des sonneries et des alertes de votre radio.

- 1 Appuyez sur  pour accéder au menu.
- 2 Appuyez sur  ou  jusqu'à Utilitaires. Appuyez sur  pour effectuer la sélection.



- 3 Appuyez sur  ou  jusqu'au Paramètres de la radio. Appuyez sur  pour effectuer la sélection.
- 4 Appuyez sur  ou  jusqu'à Sonneries et alertes. Appuyez sur  pour effectuer la sélection.
- 5 Appuyez sur  ou  jusqu'à Écart Vol. Appuyez sur  pour effectuer la sélection.
- 6 Appuyez sur  ou  jusqu'au niveau de compensation voulu. Une tonalité se fait entendre correspondant à chaque niveau de compensation de volume.
- 7 Faites un des suivants :
 - Appuyez sur  pour effectuer la sélection. Le niveau d'écart de volume est enregistré.



- Appuyez sur  pour quitter. Les changements sont supprimés.
-



Activation ou désactivation de la tonalité d'autorisation de parler



Suivez la procédure suivante pour activer ou désactiver la tonalité d'autorisation de parler sur votre radio.

- 1 Appuyez sur  pour accéder au menu.

 - 2 Appuyez sur  ou  jusqu'à Utilitaires.
Appuyez sur  pour effectuer la sélection.



 - 3 Appuyez sur  ou  jusqu'au Paramètres de la radio. Appuyez sur  pour effectuer la sélection.
-

- 4 Appuyez sur  ou  jusqu'à Trinités.
Avert... Appuyez sur  pour effectuer la sélection.
-

- 5 Appuyez sur  ou  jusqu'à Autorisation de parler. Appuyez sur  pour effectuer la sélection.
-

- 6 Appuyez sur  pour activer ou désactiver la tonalité d'autorisation de parler.



L'écran affiche un des résultats suivants :



- Si la fonction est activée,  apparaît à côté d'Activé.
 - Si cette option est désactivée, le  ne s'affiche plus à côté de Activé.
-



Activation et désactivation de la tonalité de mise sous tension



Suivez la procédure suivante pour activer ou désactiver la tonalité de mise sous tension de votre radio.

- 1 Appuyez sur  pour accéder au menu.

- 2 Appuyez sur  ou  jusqu'à Utilitaires.
Appuyez sur  pour effectuer la sélection.

- 3 Appuyez sur  ou  jusqu'au Paramètres de la radio. Appuyez sur  pour effectuer la sélection.

- 4 Appuyez sur  ou  jusqu'à Tonités/
Avert.. Appuyez sur  pour effectuer la sélection.



- 5 Appuyez sur  ou  jusqu'à Sous tension.
Appuyez sur  pour effectuer la sélection.

- 6 Appuyez sur  pour activer ou désactiver la tonalité de mise sous tension. L'écran affiche un des résultats suivants :
 - Si la fonction est activée, ✓ apparaît à côté d'Activé.
 - Si cette option est désactivée, le ✓ ne s'affiche plus à côté de Activé.



Configuration des sonneries d'avis de messages texte

Vous pouvez personnaliser la tonalité d'alerte de message texte sur Temporaire ou Répétitive pour chaque entrée dans la liste de contacts. Suivez la procédure suivante pour configurer les sonneries d'avis de messages de votre radio.



- 1 Appuyez sur  pour accéder au menu.

2 Appuyez sur  ou  jusqu'à **Contacts**.



Appuyez sur  pour effectuer la sélection.



3 Appuyez sur  ou  jusqu'à **l'alias** ou **l'ID**



voulu. Appuyez sur  pour effectuer la sélection.



4 Appuyez sur  ou  jusqu'à **Avis de message**. Appuyez sur  pour effectuer la sélection.

5 Faites un des suivants :

- Appuyez sur  ou  jusqu'à **Temporaire**.

Appuyez sur  pour effectuer la sélection.
L'écran affiche  à côté de **Temporaire**.

- Appuyez sur  ou  jusqu'à **Répétitive**.

Appuyez sur  pour effectuer la sélection.
L'écran affiche  à côté de **Répétitive**.

Changement des modes d'affichage

Vous pouvez changer le mode d'affichage de la radio entre le mode Jour ou mode Nuit au besoin. Ce réglage modifie la palette de couleurs de l'écran. Suivez la procédure suivante pour modifier le mode d'affichage de la radio.



1 Faites un des suivants :



- Appuyez sur la touche programmée **Mode d'affichage**. Ignorez les étapes suivantes.





- Appuyez sur  pour accéder au menu.

2 Appuyez sur  ou  jusqu'à **Utilitaires**.

Appuyez sur  pour effectuer la sélection.

3 Appuyez sur  ou  jusqu'au **Paramètres de la radio**. Appuyez sur  pour effectuer la sélection.



- 4 Appuyez sur  ou  jusqu'à Afficheur.
Appuyez sur  pour effectuer la sélection.
L'écran affiche Mode Jour et Mode Nuit.
-



- 5 Appuyez sur  ou  jusqu'au profil voulu.
Appuyez sur  pour effectuer la sélection.
L'écran affiche  à côté du profil sélectionné.
-



Configuration de la luminosité de l'affichage



Suivez la procédure de régler la luminosité de l'affichage sur votre radio. La luminosité de l'écran ne peut être ajustée lorsque la fonction « Luminosité auto » est activée.

- 1 Faites un des suivants :
- Appuyez sur la touche programmée **Luminosité**. Ignorez les étapes suivantes.
 - Appuyez sur  pour accéder au menu.
-

- 2 Appuyez sur  ou  jusqu'à Utilitaires.
Appuyez sur  pour effectuer la sélection.
-

- 3 Appuyez sur  ou  jusqu'au Paramètres de la radio. Appuyez sur  pour effectuer la sélection.
-

- 4 Appuyez sur  ou  jusqu'à Luminosité.
Appuyez sur  pour effectuer la sélection.
L'écran affiche une barre de progression.
-

- 5 Appuyez sur  ou  pour augmenter ou réduire la luminosité de l'affichage. Appuyez sur  pour effectuer la sélection.
La valeur du paramètre varie de 1 à 8.
-

Activation ou désactivation de l'avertisseur / des phares



Votre radio peut vous aviser d'un appel entrant en actionnant l'avertisseur et les phares. Lorsque cette fonction est activée, les appels entrants font s'activer l'avertisseur et les phares de votre véhicule. Cette fonction passe par le connecteur d'accessoire à l'arrière de votre radio et doit être installée par votre détaillant. Suivez la procédure suivante pour activer ou désactiver l'avertisseur et les phares de votre véhicule.



1 Faites un des suivants :

- Appuyez sur la touche programmée **Avert./ phares**. Passez les étapes ci-dessous.
- Appuyez sur  **OK** pour accéder au menu.



2 Appuyez sur  ou  jusqu'à

Utilitaires. Appuyez sur  **OK** pour effectuer la sélection.

3 Appuyez sur  ou  jusqu'au Paramètres de la radio. Appuyez sur  **OK** pour effectuer la sélection.

4 Appuyez sur  ou  jusqu'à Avert. / phares. Appuyez sur  **OK** pour effectuer la sélection.



5 Appuyez sur  **OK** pour activer ou désactiver l'avertisseur ou les phares. L'écran affiche un des résultats suivants :



- Si la fonction est activée,  apparaît à côté d'Activé.
- Si cette option est désactivée, le  ne s'affiche plus à côté de Activé.



Activation ou désactivation des voyants DEL



Suivez la procédure suivante pour activer ou désactiver les voyants DEL sur votre radio.

- 1 Appuyez sur  pour accéder au menu.

- 2 Appuyez sur  ou  jusqu'à Utilitaires.
Appuyez sur  pour effectuer la sélection.

- 3 Appuyez sur  ou  jusqu'au Paramètres de la radio. Appuyez sur  pour effectuer la sélection.



- 4 Appuyez sur  ou  jusqu'à Indicateur DEL. Appuyez sur  pour effectuer la sélection.



- 5 Appuyez sur  pour activer ou désactiver le voyant DEL.
L'écran affiche un des résultats suivants :
 - Si la fonction est activée,  apparaît à côté d'Activé.
 - Si cette option est désactivée, le  ne s'affiche plus à côté de Activé.



Activer et désactiver le système de diffusion publique

Suivez la procédure suivante pour activer ou désactiver la diffusion publique interne (PA) de votre radio.

- 1 Faites un des suivants :
 - Appuyez sur la touche programmée **Diffusion publique**. Ignorez les étapes suivantes.
 - Appuyez sur  pour accéder au menu.

- 2 Appuyez sur  ou  jusqu'à Utilitaires.
Appuyez sur  pour effectuer la sélection.

- 3 Appuyez sur  ou  jusqu'au Paramètres de la radio. Appuyez sur  pour effectuer la sélection.



- 4 Appuyez sur  ou  jusqu'à Diffusion publique. Appuyez sur  pour effectuer la sélection.



- 5 Appuyez sur  pour activer ou désactiver la diffusion publique.
- Si la fonction est activée, ✓ apparaît à côté d'Activé.
 - Si cette option est désactivée, le ✓ ne s'affiche plus à côté de Activé.
-



Activer et désactiver le système de diffusion publique externe

Suivez la procédure suivante pour activer ou désactiver la diffusion publique externe (PA) de votre radio.

- 1 Faites un des suivants :
- Appuyez sur la touche programmée **Diffusion publique ext.** Ignorez les étapes suivantes.
 - Appuyez sur  pour accéder au menu.
-

- 2 Appuyez sur  ou  jusqu'à Utilitaires.
Appuyez sur  pour effectuer la sélection.
-

- 3 Appuyez sur  ou  jusqu'au Paramètres de la radio. Appuyez sur  pour effectuer la sélection.
-



- 4 Appuyez sur  ou  jusqu'à Diffusion publique externe. Appuyez sur  pour effectuer la sélection.
-



- 5 Appuyez sur  pour activer ou désactiver la diffusion publique externe.
- Si la fonction est activée, ✓ apparaît à côté d'Activé.
 - Si cette option est désactivée, le ✓ ne s'affiche plus à côté de Activé.
-



Activer ou désactiver l'écran d'introduction



Vous pouvez activer ou désactiver l'écran d'introduction selon la procédure suivante.

- 1 Appuyez sur  pour accéder au menu.

- 2 Appuyez sur  ou  jusqu'à Utilitaires.
Appuyez sur  pour effectuer la sélection.

- 3 Appuyez sur  ou  jusqu'au Paramètres de la radio. Appuyez sur  pour effectuer la sélection.

- 4 Appuyez sur  ou  jusqu'à Afficheur.
Appuyez sur  pour effectuer la sélection.

- 5 Appuyez sur  ou  jusqu'à Écran intro.
Appuyez sur  pour effectuer la sélection.



- 6 Appuyez sur  pour activer ou désactiver l'écran d'introduction.
L'écran affiche un des résultats suivants :



- Si la fonction est activée, ✓ apparaît à côté d'Activé.
- Si cette option est désactivée, le ✓ ne s'affiche plus à côté de Activé.



Sélection de la langue





Suivez la procédure suivante pour choisir la langue de votre radio.



- 1 Appuyez sur  pour accéder au menu.



- 2 Appuyez sur  ou  jusqu'à Utilitaires.
Appuyez sur  pour effectuer la sélection.

- 3 Appuyez sur  ou  jusqu'au Paramètres de la radio. Appuyez sur  pour effectuer la sélection.

4 Appuyez sur  ou  jusqu'à Langues.
Appuyez sur  pour effectuer la sélection.

5 Appuyez sur  ou  jusqu'à la langue voulue. Appuyez sur  pour effectuer la sélection.
L'écran affiche  à côté de la langue sélectionnée.





3 Appuyez sur  ou  jusqu'au Paramètres de la radio. Appuyez sur  pour effectuer la sélection.

4 Appuyez sur  ou  jusqu'à Type câble.
Appuyez sur  pour effectuer la sélection.

5 Le type de câble actuel est indiqué par l'icône .

Déterminer le type de câble

Procédez comme suit pour sélectionner le type de câble utilisé par votre radio.

- 1 Appuyez sur  pour accéder au menu.
 - 2 Appuyez sur  ou  jusqu'à Utilitaires.
Appuyez sur  pour effectuer la sélection.
-

Transmission vocale

La transmission vocale (VOX) vous permet d'établir une communication vocale en mode mains libres sur un canal programmé. La radio transmet automatiquement, pendant une période programmée, dès que le microphone de l'accessoire VOX détecte une voix.



AVIS:

Cette fonction n'est pas offerte dans les canaux de bandes citoyennes qui se trouvent dans la même fréquence.

Vous pouvez activer ou désactiver la fonction VOX en procédant de l'une ou l'autre des manières suivantes :

- Éteignez la radio, puis rallumez-la pour activer la fonction VOX.
- Changez de canal à l'aide de la touche **Canal précédent/suivant** pour activer la fonction VOX.
- Changez de canal à l'aide du **bouton Volume/Canal** pour activer la fonction VOX.
- Activer ou désactiver la fonction VOX à l'aide de la touche programmée **VOX** ou du menu.
- Appuyez sur le bouton **PTT** pendant que la radio fonctionne pour désactiver la fonction VOX.



**AVIS:**



L'activation ou la désactivation de cette fonction est limitée aux radios sur lesquelles la fonction associée est activée. Pour obtenir des renseignements supplémentaires, adressez-vous à votre détaillant ou à votre administrateur de système.



Activation ou désactivation de l'émission commandée par la voix (VOX)

Suivez la procédure suivante pour activer ou désactiver le VOX sur votre radio.

- 1 Faites un des suivants :
 - Appuyez sur le bouton programmé **VOX**. Passez les étapes ci-dessous.
 - Appuyez sur  **OK** pour accéder au menu.

- 2 Appuyez sur  ou  jusqu'à Utilitaires. Appuyez sur  **OK** pour effectuer la sélection.

- 3 Appuyez sur  ou  jusqu'au Paramètres de la radio. Appuyez sur  **OK** pour effectuer la sélection.

- 4 Appuyez sur  ou jusqu'  à VOX. Appuyez sur  **OK** pour effectuer la sélection.

- 5 Appuyez sur  **OK** pour activer ou désactiver la fonction **VOX**.



AVIS:

Si la fonction de tonalité d'autorisation est activée, utilisez un mot déclencheur pour faire l'appel. Attendez la fin de la tonalité d'autorisation de parler, puis parlez clairement dans le microphone. Pour obtenir plus de renseignements à ce sujet, consultez la section [Activation ou désactivation de la tonalité d'autorisation de parler à la page 218](#).

Activation ou désactivation de l'assistance parlée

Cette fonction permet à la radio de confirmer vocalement le code ou le nom de la zone ou du canal que l'utilisateur vient d'entrer ou la touche programmable sur laquelle il vient d'appuyer.

Cette option est particulièrement utile lorsqu'il est difficile de lire le contenu affiché à l'écran.

L'assistance parlée peut être personnalisée en fonction des exigences du client. Suivez la procédure suivante pour activer ou désactiver l'assistance parlée de votre radio.

Activation ou désactivation de la carte d'option

Les capacités de carte d'option de chaque canal peuvent être attribuées aux touches programmables. Un canal peut prendre en charge jusqu'à six fonctions de carte d'option. Suivez la procédure suivante pour activer ou désactiver la carte d'option sur votre radio.

Appuyez sur la touche programmée **Carte d'option**.

Synthèse texte-parole

La fonction de synthèse vocale peut être activée uniquement par votre détaillant ou administrateur de système. Si la synthèse texte-parole est activée, l'annonce vocale est automatiquement désactivée. Si cette option est activée, la fonction de synthèse texte-parole est automatiquement désactivée.

Cette fonction permet à la radio de faire entendre les fonctionnalités suivantes :

- Canal actuel
- Zone actuelle



- Activation ou désactivation de la fonction de bouton programmé
- Contenu des messages texte reçus
- Contenu des fiches de travail reçues



L'indicateur audio peut être personnalisé en fonction des exigences du client. Cette fonction est particulièrement utile lorsqu'il est difficile de lire le contenu affiché à l'écran.



Réglage de la synthèse texte-parole



Suivez la procédure pour définir la fonction de synthèse vocale.

- 1 Appuyez sur  pour accéder au menu.

- 2 Appuyez sur  ou  jusqu'à Utilitaires.
Appuyez sur  pour effectuer la sélection.

- 3 Appuyez sur  ou  jusqu'au Paramètres de la radio. Appuyez sur  pour effectuer la sélection.

- 4 Appuyez sur  ou  jusqu'à Assistance parlée. Appuyez sur  pour effectuer la sélection.

- 5 Appuyez sur  ou  pour n'importe laquelle des fonctions suivantes. Appuyez sur  pour effectuer la sélection.



Voici les options disponibles :



- Tout
 - Messages
 - Tickets de tâche
 - Canal
 - Zone
 - Touche de programmation
 - ✓ L'icône s'affiche à côté du réglage sélectionné.
-



Activer ou désactiver le renvoi d'appel automatique

Vous pouvez configurer votre radio de manière à ce qu'elle transfère automatiquement les appels vocaux à une autre radio.





- 1 Appuyez sur  pour accéder au menu.

- 2 Appuyez sur  ou  jusqu'à Utilitaires.
Appuyez sur  pour effectuer la sélection.

- 3 Appuyez sur  ou  jusqu'au Paramètres de la radio. Appuyez sur  pour effectuer la sélection.

- 4 Appuyez sur  ou  jusqu'à Renvoi d'appel. Appuyez sur  pour effectuer la sélection.



- 5 Faites un des suivants :



- Appuyez sur  ou  pour activer le renvoi d'appel. Si la fonction est activée, ✓ apparaît à côté d'Activé.
- Appuyez sur  ou  pour désactiver le renvoi d'appel. Si cette option est désactivée, le ✓ ne s'affiche plus à côté de Activé.



Réglage du délai menu



Vous pouvez régler la durée pendant laquelle la radio affiche le menu avant de revenir automatiquement à l'écran d'accueil. Suivez la procédure suivante pour configurer le délai menu.



- 1 Appuyez sur  pour accéder au menu.

- 2 Appuyez sur  ou  jusqu'à Utilitaires.
Appuyez sur  pour effectuer la sélection.

3 Appuyez sur  ou  jusqu'au Paramètres de la radio. Appuyez sur  pour effectuer la sélection.

4 Appuyez sur  ou  jusqu'à Afficheur. Appuyez sur  pour effectuer la sélection.

5 Appuyez sur  ou  jusqu'à Délai Menu. Appuyez sur  pour effectuer la sélection.



6 Appuyez sur  ou  jusqu'au profil voulu. Appuyez sur  pour effectuer la sélection.



Activation ou désactivation du microphone analogique



Le contrôle de gain automatique du microphone analogique (CGA) permet de réguler automatiquement le gain du microphone de la radio durant la transmission sur un système analogique.

Cette fonction élimine l'audio fort ou augmente l'audio faible en fonction d'une valeur prédéterminée afin d'assurer un niveau audio uniforme. Suivez la procédure pour activer ou désactiver le CGA du microphone de votre radio.

1 Appuyez sur  pour accéder au menu.

2 Appuyez sur  ou  jusqu'à Utilitaires. Appuyez sur  pour effectuer la sélection.

3 Appuyez sur  ou  jusqu'au Paramètres de la radio. Appuyez sur  pour effectuer la sélection.

4 Appuyez sur  ou  jusqu'à Mic. CGA-A. Appuyez sur  pour effectuer la sélection.

5 Appuyez sur  pour activer la fonction CGA Mic. analogique.





L'écran affiche un des résultats suivants :



- Si la fonction est activée, ✓ apparaît à côté d'Activé.
- Si cette option est désactivée, le ✓ ne s'affiche plus à côté de Activé.



Activation ou désactivation du microphone numérique

Le contrôle de gain automatique du microphone numérique (CGA) permet de réguler automatiquement le gain du microphone de la radio durant la transmission sur un système numérique.

Cette fonction élimine l'audio fort ou augmente l'audio faible en fonction d'une valeur prédéterminée afin d'assurer un niveau audio uniforme. Suivez la procédure pour activer ou désactiver le CGA du microphone de votre radio.

- 1 Appuyez sur  pour accéder au menu.
- 2 Appuyez sur  ou  jusqu'à Utilitaires.
Appuyez sur  pour effectuer la sélection.

- 3 Appuyez sur  ou  jusqu'au Paramètres de la radio. Appuyez sur  pour effectuer la sélection.

- 4 Appuyez sur  ou  jusqu'à Mic. CGA-N.
Appuyez sur  pour effectuer la sélection.

- 5 Appuyez sur  pour activer la fonction CGA Mic. numérique.

L'écran affiche un des résultats suivants :

- Si la fonction est activée, ✓ apparaît à côté d'Activé.
- Si cette option est désactivée, le ✓ ne s'affiche plus à côté de Activé.

Activation ou désactivation de la fonction Audio intelligent

Votre radio règle automatiquement le volume audio pour compenser le bruit de fond actuel dans l'environnement, y

compris les sources de bruit mobiles et immobiles. Cette fonction est une fonction de réception uniquement et ne touche pas l'audio de transmission. Suivez la procédure suivante pour activer ou désactiver l'audio intelligent sur votre radio.









AVIS:



Cette fonction ne s'applique pas à la technologie Bluetooth.

1 Faites un des suivants :









- Appuyez sur la touche programmée **Audio intelligent**. Passez les étapes ci-dessous.
- Appuyez sur  pour accéder au menu.

2 Appuyez sur  ou  jusqu'à Utilitaires.
Appuyez sur  pour effectuer la sélection.

3 Appuyez sur  ou  jusqu'au Paramètres de la radio. Appuyez sur  pour effectuer la sélection.

4 Appuyez sur  ou  jusqu'à Audio intelligent. Appuyez sur  pour effectuer la sélection.



5 Faites un des suivants :



- Appuyez sur  ou  jusqu'à Activer.
Appuyez sur  pour effectuer la sélection.
L'écran affiche  à côté du message Activé.
- Appuyez sur  ou  jusqu'à Désactiver.
Appuyez sur  pour effectuer la sélection.
L'écran affiche  à côté du message Désactivé.



Activer ou désactiver la fonction de suppression des réactions acoustiques

Cette fonction vous permet de réduire la suppression de la réaction acoustique lors de la réception d'appels. Suivez la procédure suivante pour activer ou désactiver la suppression de la réaction acoustique sur votre radio.

- 1 Appuyez sur  pour accéder au menu.

- 2 Appuyez sur  ou  jusqu'à Utilitaires.
Appuyez sur  pour effectuer la sélection..

- 3 Appuyez sur  ou  jusqu'au Paramètres de la radio. Appuyez sur  pour effectuer la sélection.



- 4 Appuyez sur  ou  jusqu'à Réduction bruit. Appuyez sur  pour effectuer la sélection.



- 5 Faites un des suivants :
 - Appuyez sur pour activer la suppression de la réaction acoustique. Si la fonction est activée, ✓ apparaît à côté d'Activé.
 - Appuyez sur pour désactiver la suppression de la réaction acoustique. Si cette option est désactivée, le ✓ ne s'affiche plus à côté de Activé.



Activer ou désactiver l'amélioration de la vibration

Vous pouvez activer cette fonction lorsque vous parlez une langue qui contient beaucoup de consonnes vibrantes alvéolaires (« R » roulés). Suivez la procédure pour activer ou désactiver l'amélioration de la vibration sur votre radio.









- 1 Faites un des suivants :
 - Appuyez sur la touche programmée **Amélioration de la vibration**. Passez les étapes ci-dessous.
 - Appuyez sur  pour accéder au menu.

- 2 Appuyez sur  ou  jusqu'à Utilitaires.
Appuyez sur  pour effectuer la sélection.

- 3 Appuyez sur  ou  jusqu'au Paramètres de la radio. Appuyez sur  pour effectuer la sélection.

- 4 Appuyez sur  ou  jusqu'à Amélioration de la vibration. Appuyez sur  pour effectuer la sélection.
-

5 Faites un des suivants :

- Appuyez sur  ou  jusqu'à Activer.
Appuyez sur  pour effectuer la sélection.
L'écran affiche  à côté du message Activé.
 - Appuyez sur  ou  jusqu'à Désactiver.
Appuyez sur  pour effectuer la sélection.
L'écran affiche  à côté du message Désactivé.
-

Ambiance audio

Vous pouvez personnaliser l'ambiance audio de votre radio selon vos préférences.

Par défaut

Il s'agit de la valeur par défaut.

Fort

Cette configuration active la suppression du bruit et augmente le volume du haut-parleur pour une utilisation dans un environnement bruyant.



Groupe de travail



Cette configuration permet d'activer la réduction du bruit et de désactiver l'AGC pour utilisation lorsqu'un groupe de radios sont à proximité les unes des autres.

Configuration de l'ambiance audio



Suivez la procédure pour définir l'ambiance audio sur votre radio en fonction de votre environnement.

- 1 Appuyez sur  pour accéder au menu.

- 2 Appuyez sur  ou  jusqu'à Utilitaires.
Appuyez sur  pour effectuer la sélection.

- 3 Appuyez sur  ou  jusqu'au Paramètres de la radio. Appuyez sur  pour effectuer la sélection.

4 Appuyez sur  ou  jusqu'à **Ambiance audio**. Appuyez sur  pour effectuer la sélection.

5 Appuyez sur  ou  jusqu'au profil voulu. Appuyez sur  pour effectuer la sélection.

Les paramètres sont les suivants.

- Choisissez **Par défaut** pour activer les paramètres d'origine par défaut.
- Choisissez **Fort** pour augmenter le volume lorsque vous utilisez la radio dans un environnement bruyant.
- Choisissez **Groupe travail** afin de réduire la rétroaction acoustique lors de l'utilisation de la radio en combinaison avec un groupe de radios qui sont à proximité de l'autre.

L'écran affiche  à côté du profil sélectionné.

Profils audio

Vous pouvez personnaliser les profils audio de votre radio selon vos préférences.

Par défaut

Il s'agit de la valeur par défaut.

Niveau 1, niveau 2 et niveau 3

Ces paramètres sont des profils audio destinés à compenser la perte auditive causée par le bruit qui est typique chez les adultes dans la quarantaine, la cinquantaine, la soixantaine ou plus.



Amplification des fréquences aiguës, moyennes et basses



Ces paramètres sont prévus pour des sons plus ténus, ou nasillards, ou graves.



Configuration des profils audio



Suivez la procédure suivante pour configurer les profils audio par défaut de votre radio.

1 Appuyez sur  pour accéder au menu.

2 Appuyez sur  ou  jusqu'à **Utilitaires**. Appuyez sur  pour effectuer la sélection.

3 Appuyez sur  ou  jusqu'au Paramètres de la radio. Appuyez sur  pour effectuer la sélection.

4 Appuyez sur  ou  jusqu'à Profils audio. Appuyez sur  pour effectuer la sélection.

5 Appuyez sur  ou  jusqu'au profil voulu. Appuyez sur  pour effectuer la sélection. Les paramètres sont les suivants.

- Choisissez Par défaut pour désactiver le profil audio sélectionné précédemment et revenir aux paramètres par défaut.
- Choisissez Niveau 1, Niveau 2 ou Niveau 3 pour les profils audio destinés à compenser la perte auditive due au bruit qui est habituelle pour les adultes de plus de 40 ans.
- Choisissez Ampli. aigus, Ampli. médiums, ou Ampli. basses pour les profils audio qui

s'alignent avec votre préférence pour des sons plus métalliques, plus nasillards ou plus profonds.

L'écran affiche  à côté du profil sélectionné.

Activer et désactiver le système de système satellite de navigation mondial

Le système mondial de navigation par satellite (GNSS) est un système de navigation par satellite qui permet de déterminer l'emplacement précis de la radio. Le GNSS comprend le système de positionnement global (GPS), le système mondial de satellites de navigation (GLONASS) et le système de satellite de navigation BeiDou (BDS). Le









AVIS:



Certains modèles de radio peuvent offrir le GPS, le GLONASS et le BDS. La constellation GNSS est configurée dans le CPS. Vérifiez auprès du détaillant ou de votre administrateur de système pour savoir de quelle façon votre radio a été programmée.

- 1 Effectuez une des étapes suivantes pour activer ou désactiver le mode GNSS sur votre radio.

- Appuyez sur le bouton programmé **GNSS**.
- Appuyez sur  pour accéder au menu. Passez à l'étape suivante.

2 Appuyez sur  ou  jusqu'à Utilitaires. Appuyez sur  pour effectuer la sélection.

3 Appuyez sur  ou  jusqu'au Paramètres de la radio. Appuyez sur  pour effectuer la sélection.

4 Appuyez sur  ou  jusqu'à GNSS. Appuyez sur  pour effectuer la sélection.

5 Appuyez sur  pour activer ou désactiver le GNSS.

Si la fonction est activée, ✓ apparaît à côté d'Activé.

Si cette option est désactivée, le ✓ ne s'affiche plus à côté de Activé.

Liste de réception flexible

La Liste de réception flexible vous permet de créer et d'affecter des membres à la liste de groupe d'appels de réception. Votre radio peut prendre en charge un maximum de 16 membres dans la liste. Cette fonction est prise en charge en mode Capacity Plus.

Activer ou désactiver la liste de réception flexible



Suivez la procédure suivante pour activer ou désactiver la liste de réception flexible.

1 Faites un des suivants :

- Appuyez sur la touche programmée **Liste de réception flexible**. Ignorez les étapes suivantes.
- Appuyez sur  pour accéder au menu.



2 Appuyez sur  ou  jusqu'à Liste Rx flexible. Appuyez sur  pour effectuer la sélection.

3 Faites un des suivants :

- Appuyez sur  ou  jusqu'à Activer.

Appuyez sur  pour effectuer la sélection.
Une tonalité de réussite se fait entendre.

L'écran affiche un bref avis de réussite.

- Appuyez sur  ou  jusqu'à Eteindre.

Appuyez sur  pour effectuer la sélection.
Une tonalité d'échec se fait entendre.

L'écran affiche un bref avis d'échec.

Renseignements généraux sur la radio

Votre radio contient des renseignements sur différents paramètres.

Les informations générales de votre radio sont les suivantes :

- Alias et ID de la radio.
- Versions du micrologiciel et de la fiche de codes.

- Mise à jour du logiciel.
- Informations du système GNSS.
- Information sur le site.



AVIS:

Appuyez sur  pour revenir à l'écran précédent.

Maintenez enfoncée la touche  pour revenir à l'écran d'accueil. Lorsqu'il n'y a aucune activité pendant une durée prédéfinie, la radio quitte l'écran en cours.

Vérification de l'alias et l'ID de la radio



Suivez la procédure suivante pour vérifier l'alias et l'ID de la radio sur votre radio.

1 Faites un des suivants :



- Appuyez sur la touche programmée **Alias et ID de la radio**. Ignorez les étapes suivantes.
Une tonalité de réussite se fait entendre.



Appuyez sur la touche programmée **Alias et ID de la radio** pour revenir à l'écran précédent.

- Appuyez sur  pour accéder au menu.



2 Appuyez sur  ou  jusqu'à Utilitaires.
Appuyez sur  pour effectuer la sélection.

3 Appuyez sur  ou  jusqu'à Info de la radio. Appuyez sur  pour effectuer la sélection.

4 Appuyez sur  ou  jusqu'à Mon ID.
Appuyez sur  pour effectuer la sélection.
L'alias de la radio s'affiche sur la première ligne de l'écran. L'ID de la radio s'affiche sur la deuxième ligne de l'écran.

2 Appuyez sur  ou  jusqu'à Utilitaires.
Appuyez sur  pour effectuer la sélection.

3 Appuyez sur  ou  jusqu'à Info de la radio. Appuyez sur  pour effectuer la sélection.

4 Appuyez sur  ou  jusqu'à Version.
Appuyez sur  pour effectuer la sélection.
L'écran affiche la version actuelle du micrologiciel et celle de la fiche de code.

Vérification des versions du micrologiciel et de la codeplug



Suivez la procédure suivante pour vérifier les versions du micrologiciel et de la fiche de code sur votre radio.



1 Appuyez sur  pour accéder au menu.



Vérification des informations de mise à jour du logiciel

Affiche la date et l'heure de la dernière mise à jour logicielle effectuée par l'intermédiaire de la Programmation par radiocommunication (OTAP) ou Wi-Fi. Suivez la procédure suivante pour vérifier les informations de mise à jour du logiciel de votre radio.

- 1 Appuyez sur  pour accéder au menu.

- 2 Appuyez sur  ou  jusqu'à Utilitaires.
Appuyez sur  pour effectuer la sélection.

- 3 Appuyez sur  ou  jusqu'à Info de la radio. Appuyez sur  pour effectuer la sélection.

- 4 Appuyez sur  ou  jusqu'à M. à j. logicielle. Appuyez sur  pour effectuer la sélection.

L'écran affiche la date et l'heure de la dernière mise à jour logicielle.



Le menu de mise à jour logicielle est uniquement disponible après au moins une session OTAP ou Wi-Fi réussie. Pour obtenir plus de renseignements à ce sujet, consultez la section [Programmation par onde radio à la page 506](#).

Consulter les informations du GNSS



Affiche les informations GNSS sur votre radio, par exemple, les valeurs suivantes :



- Latitude
- Longitude
- Altitude
- Direction
- Vitesse
- Affaiblissement de la précision horizontale (Horizontal Dilution of Precision, ou HDOP)
- Satellites
- Version

- 1 Appuyez sur  pour accéder au menu.

- 2 Appuyez sur  ou  jusqu'à Utilitaires.
Appuyez sur  pour effectuer la sélection.

3 Appuyez sur  ou  jusqu'à Info de la radio. Appuyez sur  pour effectuer la sélection.



4 Appuyez sur  ou  jusqu'à Info GNSS. Appuyez sur  pour effectuer la sélection.

5 Appuyez sur  ou  jusqu'à l'élément voulu. Appuyez sur  pour effectuer la sélection. L'écran affiche les informations GNSS demandées.



Affichage de l'information sur le site

Suivez la procédure suivante pour afficher le nom du site sur lequel se trouve actuellement votre radio.

1 Appuyez sur  pour accéder au menu.

2 Appuyez sur  ou  jusqu'à Utilitaires. Appuyez sur  pour effectuer la sélection.

3 Appuyez sur  ou  jusqu'à Info de la radio. Appuyez sur  pour effectuer la sélection.



4 Appuyez sur  ou  jusqu'à Info site. Appuyez sur  pour effectuer la sélection.



L'écran affiche le nom du site actuel.

Affichage des détails du certificat Wi-Fi d'entreprise



Vous pouvez afficher les détails du certificat Wi-Fi d'entreprise sélectionné.

1 Appuyez sur  pour accéder au menu.

2 Appuyez sur  ou  jusqu'à Utilitaires. Appuyez sur  pour effectuer la sélection.

- 3 Appuyez sur  ou  pour Menu
Certificat. Appuyez sur  pour effectuer la
sélection.

✓ s'affiche vis-à-vis des certificats prêts.

- 4 Appuyez sur  ou  jusqu'au certificat voulu.
Appuyez sur  pour effectuer la sélection.
-

Votre radio affiche les détails complets du certificat.



AVIS:

Pour les certificats non prêts, l'écran affiche
uniquement l'état.

Liste des accessoires approuvés

Motorola Solutions fournit une liste d'accessoires pour améliorer la productivité de votre radio.

Antenne

- VHF, 136 à 144 MHz, 1/4 d'onde, montage par insertion, Mini-U (HAD4006_)
- VHF, 146 à 150,8 MHz, 1/4 d'onde, montage par insertion, Mini-U (HAD4007_)
- VHF, 150,8 à 162 MHz, 1/4 d'onde, montage par insertion, Mini-U (HAD4008_)
- VHF, 162 à 174 MHz, 1/4 d'onde, montage par insertion, Mini-U (HAD4009_)
- UHF, 403 à 430 MHz, 1/4 d'onde, montage par insertion, Mini-U (HAE4002_)
- UHF, 450 à 470 MHz, 1/4 d'onde, montage par insertion, Mini-U (HAE4003_)
- UHF, 470 à 527 MHz, 1/4 d'onde, montage par insertion, Mini-U (HAE4004_)
- UHF, 406 à 420 MHz, gain à 3,5 dB, montage par insertion, Mini-U (HAE4010_)
- UHF, 450 à 470 MHz, gain à 3,5 dB, montage par insertion, Mini-U (HAE4011_)
- UHF, 470 à 494 MHz, gain à 3,5 dB, montage par insertion, Mini-U (HAE4012_)
- UHF, 494 à 512 MHz, gain à 3,5 dB, montage par insertion, Mini-U (HAE4013_)
- GPS/UHF combinés, 403 à 527 MHz, gain à 2 dB, montage par insertion, Mini-U (HAE6019_)
- GPS/UHF combinés, 470 à 527 MHz, 1/4 d'onde, montage par insertion, Mini-U (HAE6020_)
- UHF, 403 à 527 MHz, gain à 2 dB, montage par insertion, Mini-U (HAE6022_)
- GPS/UHF combinés, 470 à 494 MHz, gain à 3 dB, montage par insertion, Mini-U (HAE6024_)
- GPS/UHF combinés, 494 à 512 MHz, gain à 3 dB, montage par insertion, Mini-U (HAE6026_)
- 800/900, 806 à 941 MHz, gain à 5 dB, montage par insertion, Mini-U (HAF4027_)
- GPS+RF combinés, 806 à 941 MHz, 1/4 d'onde, montage par insertion, Mini-U (HAF4029_)

- GPS+RF combinés, 806 à 941 MHz, gain à 3 dB, montage par insertion, Mini-U (HAF4030_) combinés
 - GPS+RF combinés, 806 à 941 MHz, gain à 5 dB, montage par insertion, Mini-U (HAF4032_) combinés
 - GPS+RF combinés, 806 à 941 MHz, gain à 5 dB, montage par insertion, Mini-U (HAF4033_) combinés
 - GPS/UHF combinés, 403 à 430 MHz, 1/4 d'onde, montage par insertion, Mini-U (PMAE4030_)
 - GPS/UHF combinés, 450 à 470 MHz, 1/4 d'onde, montage par insertion, Mini-U (PMAE4031_)
 - GPS/UHF combinés, 406 à 420 MHz, gain à 3,5 dB, montage par insertion, Mini-U (PMAE4032_)
 - GPS/UHF combinés, 450 – 470 MHz, gain à 3,5 dB, montage par insertion, Mini-U (PMAE4033_)
 - GPS/UHF combinés, 450 à 470 MHz, gain 5,0 dB, montage par insertion, Mini-U (PMAE4033_)
 - Antenne GPS active fixe (PMAN4000_)
 - Antenne GPS active montée sur fenêtre (PMAN4001_)
 - Antenne GPS active à fixation magnétique (PMAN4002_)
 - GPS+RF combinés, base uniquement, montage par insertion, Mini-U (PMAN4004_)
 - GPS/VHF combinés, 136 à 144 MHz, 1/4 d'onde, montage par insertion, Mini-U (RAD4214_)
 - GPS/VHF combinés, 146 à 150,8 MHz, 1/4 d'onde, montage par insertion, Mini-U (RAD4215_)
 - GPS/VHF combinés, 150,8 à 162 MHz, 1/4 d'onde, montage par insertion, Mini-U (RAD4216_)
 - GPS/VHF combinés, 162 à 174 MHz, 1/4 d'onde, montage par insertion, Mini-U (RAD4217_)
 - GPS/VHF combinés, 146 à 172 MHz, gain à 3 dB, montage par insertion, Mini-U (RAD4218_)
 - UHF, 445 à 470 MHz, gain à 5 dB, montage par insertion, Mini-U (avec base) (RAE4004_RB)
 - UHF, 445 à 470 MHz, gain à 5,0 dB, montage par insertion, Mini-U (sans base) (RAE4004_)
- Pour une utilisation avec base PMAN4004_ uniquement :**
- UHF, 494 à 512 MHz, gain 3 dB, montage par insertion (HAE6027_)
 - UHF, 470 à 494 MHz, gain à 3 dB, montage par insertion (HAE6028_)
 - UHF, 403 à 527 MHz, gain à 2 dB, montage par insertion (HAE6029_)

- UHF, 470 à 527 MHz, 1/4 d'onde, montage par insertion (HAE6030_)
- UHF, 403 à 430 MHz, 1/4 d'onde (PMAE4039_)
- UHF, 450 à 470 MHz, 1/4 d'onde (PMAE4041_)
- UHF, 406 à 420 MHz, gain à 3,5 dB (PMAE4040_)
- UHF, 450 à 470 MHz, gain à 3,5 dB (PMAE4042_)
- UHF, 450 à 470 MHz, gain à 5,0 dB (PMAE4043_)
- UHF, 162 à 174 MHz, 1/4 d'onde (RAD4223_)
- VHF, 150,8 à 162 MHz, 1/4 d'onde (RAD4224_)
- VHF, 146 à 150,8 MHz, 1/4 d'onde (RAD4225_)
- VHF, 136 à 144 MHz, 1/4 d'onde (RAD4226_)
- VHF, 146 à 172 MHz, gain à 3 dB (RAD4227_)
- Oreillette de l'appareil sans fil indispensable, câble de 24 cm (9,5 po) (NNTN8126_)
- Dispositif PTT de messagerie vocale instantanée sans fil indispensable (NNTN8127_)
- Casque sans fil non intrinsèque et dispositif PTT avec audio PTT, câble de 30,5 cm (12 pouces) (NNTN8189_)
- Ensemble d'accessoires Bluetooth, SP, câble de 24 cm (9,5 po) (NNTN8190_)
- Ensemble discret sans fil, comprend deux ensembles d'écouteurs à 2 fils (1 noir et 1 blanc), oreillette à 1 fil (noir), et un adaptateur de 3,5 mm pour brancher à n'importe quels écouteurs disponibles dans le commerce (NNTN8296_) ¹¹
- Adaptateur sans fil en Y et crochet de rétention pour écouteurs entièrement dissimulés (NNTN8385_) ¹³

Accessoires audio

- Casque Bluetooth HK200 (89409N)
- Combiné de style téléphone (HMN4098_)
- Oreillette de l'appareil sans fil indispensable, câble de 30,5 cm (12 po) (NNTN8125_)

- Oreillette pivotante à ajustement flexible avec microphone sur tige (PMLN7181_) ¹³
- Oreillette pivotante à ajustement flexible avec microphone sur tige, emballage multiple (PMLN7203_) ¹³

¹¹ Votre radio est compatible avec les accessoires indiqués ici. Pour en savoir davantage à ce sujet, communiquez avec le détaillant.

- Écouteurs entièrement dissimulés (RLN4922_) ¹³
- Casque robuste sans fil non sécurisé XBT à contour d'oreille (RLN6490_)
- Casque robuste sans fil non sécurisé XBT (RLN6491_)
- Kit d'accessoires Bluetooth MOTOTRBO avec bloc d'alimentation AN (RLN6500_)
- Oreillette pivotante avec microphone en ligne pour accessoire de bouton Bluetooth, paquet de 3 (RLN6550_) ¹³
- Microphone de bureau (RMN5050_)
- Microphone compact (RMN5052_)
- Microphone à clavier IMPRES pour navigation à quatre directions (RMN5127_)
- Microphone robuste avec audio avancé (RMN5053_)
- Microphone pour pare-soleil à fonction audio améliorée (RMN5054_)
- Câble d'alimentation vers la batterie, 3 m (10 pi), 15 ampères (1 – -25 watts) (HKN4137_)
- Câble d'alimentation vers la batterie, 3 m (10 pi), 20 ampères (1 – -45 watts) (HKN4191_)
- Câble d'alimentation vers la batterie, 6 m (20 pi), 20 ampères (1 – -45 watts) (HKN4192_)
- Avant mobile (MMP), câble de programmation (HKN6184_)
- Câble de programmation MAP (PMKN4010_)
- Câble de programmation et de test MAP (PMKN4016_)
- Câble universel de connecteur d'accessoire arrière pour dispositif sans fil et répéteur (PMKN4018_)
- Câble de rallonge pour microphone sans fil, 3 m (10 pi) (PMKN4033_)
- Câble de rallonge pour microphone sans fil, 6 m (20 pi) (PMKN4034_)
- Câble pour support distant, 3 m (PMKN4143_)
- Câble pour support distant, 5 m (PMKN4144_)
- Câble de détection d'allumage (RKN4136_)
- Câble de rechange pour microphone compact (3075336B07)
- Câble de rechange pour microphone à clavier ou microphone robuste (3075336B10)

Câbles

Accessoires de bureau

- Cordon d'alimentation É.-U. (3060665A04)
- Câble d'alimentation radio pour GPN6145 (GKN6266_)
- Plateau de bureau sans haut-parleur (GLN7318_)
- Bloc d'alimentation à découpage (modèles 1 à 25 watts) (marqués CE) (GPN6145_)
- Bloc d'alimentation et câble (HPN4007_)
- Trousse pour connecteur d'accessoire arrière (PMLN5072_)
- Plateau de bureau avec haut-parleur (RSN4005_)

Trousses de fixation

- Protecteur d'écran, clair (une unité par emballage) (AY000269A01_) ¹²
- Matériel de fixation pour tableau de bord (DIN) (RLN6465_)
- Matériel de fixation par tourillons à profil bas (RLN6466_)

- Matériel de fixation par tourillons à profil haut (RLN6467_)
- Matériel de fixation par tourillons à verrouillage (RLN6468_)
- Sac à tourillon bas profil (RLN6469_)
- Interface d'émetteur-récepteur montage à distance (PMLN6402_)
- Interface de tête de commande de montage à distance (PMLN6403_)

Accessoires divers

- Protection contre les surtensions, trousse de montage sur tour (DQT1)
- Protection contre les surtensions, cloison de protecteur coaxial (DSISB50LNC2MA)
- Adaptateur d'antenne PL259/Mini-U, câble de 2,4 m (8 pi) (HKN9557_)
- Pince de suspension pour microphone (tous les microphones) (HLN9073_)

¹² Votre radio est compatible avec les accessoires indiqués ici. Pour en savoir davantage à ce sujet, communiquez avec le détaillant.

- Pince de suspension universelle pour microphone (tous les microphones) (HLN9414_)
- Adaptateur mobile MMP IMPRES, sans PC (PMKN4072_)
- Adaptateur mobile MAP IMPRES, sans PC (PMKN4070_)
- Carte d'option générique (PMLN5718_S)
- Ensemble de surveillance sans fil à un fil pour opérations critiques avec tube translucide (PMLN7052_) ¹³
- Bouton PTT (RLN5926_)
- Interrupteur d'urgence au pied (RLN5929_)
-

Haut-parleurs

- Haut-parleur externe de 13 W (RSN4002_)
- Haut-parleur externe 7,5 W (RSN4003_)
- Haut-parleur externe de 5 W (RSN4004_)

¹³ Votre radio est compatible avec les accessoires indiqués ici. Pour en savoir davantage à ce sujet, communiquez avec le détaillant.

Utilisation de la radio maritime dans la gamme de fréquence VHF

Assignations des canaux spéciaux

Canal d'urgence

Si vous êtes exposé à un danger grave et imminent en mer et avez besoin d'une aide d'urgence, utilisez le canal VHF 16 pour lancer un appel de détresse aux navires qui se trouvent à proximité et à la Garde côtière. Transmettez les renseignements suivants dans cet ordre :

- 1 « MAYDAY, MAYDAY, MAYDAY. »
- 2 « ICI _____, INDICATIF D'APPEL _____ . » Dites le nom du navire en détresse trois fois, suivi de l'indicatif d'appel ou d'une autre identification du navire, en l'énonçant trois fois.
- 3 Répétez « MAYDAY » et le nom du navire.
- 4 « NOTRE POSITION EST _____ . » Indiquez la position du

navire en détresse à l'aide de renseignements qui pourraient aider les répondants à vous localiser, p. ex :

- la latitude et la longitude;
- le relèvement (dites si vous utilisez le nord géographique ou magnétique);
- votre distance d'un point de repère connu;
- la route, la vitesse ou la destination du navire.

- 5 Énoncez la nature de la situation de détresse.
- 6 Précisez l'aide dont vous avez besoin.
- 7 Indiquez le nombre de personnes à bord du navire et nécessitant une assistance médicale, le cas échéant.
- 8 Mentionnez toute autre information pouvant être utile aux répondants, comme le type de navire, sa longueur ou son tonnage, la couleur de la coque, etc.
- 9 « Terminé. »
- 10 Attendez une réponse.
- 11 Si vous ne recevez pas de réponse immédiate, restez près de la radio et répétez votre transmission à intervalles jusqu'à ce que l'on vous réponde. Soyez prêt à suivre les instructions qui vous seront données.

Canal d'appel non commercial

Pour transmettre des messages non commerciaux, comme des rapports de pêche, des arrangements de rendez-vous, des planifications de réparation ou des informations d'accostage, utilisez le **canal VHF 9**.

Exigences relatives à la fréquence de fonctionnement

Toute radio conçue pour la navigation doit être conforme à la section 80 des règlements de la Commission fédérale des communications (FCC), comme suit :

- sur les navires soumis à la section II du titre III de la Loi sur les communications (Communications Act) des États-Unis, la radio doit pouvoir fonctionner sur la fréquence 156,800 MHz;
- sur les navires soumis à la Convention de sécurité, la radio doit pouvoir fonctionner
 - en mode simplex sur le poste du navire qui transmet les fréquences précisées sur la bande de fréquences 156,025 – -157,425 MHz, et
 - en mode semi-duplex sur les deux canaux de fréquence précisés dans le tableau ci-dessous.



AVIS:

Les canaux simplex 3, 21, 23, 61, 64, 81, 82 et 83 ne peuvent être utilisés légalement par le grand public dans les eaux américaines.

Pour obtenir davantage de renseignements sur les exigences de fonctionnement des Services maritimes, consultez la version intégrale de la section 80 des règlements de la FCC ou communiquez avec la Garde côtière américaine.

Tableau 16: Liste des canaux de la bande maritime VHF

Numéro de canal	Fréquence (MHz)	
	Transmission	Réception
1	156,050	160,650
2	156,100	160,700
*	156,150	160,750
4	156,200	160,800
5	156,250	160,850
6	156,300	–
7	156,350	160,950
8	156,400	–

Français (Canada)

9	156,450	156,450
10	156,500	156,500
11	156,550	156,550
12	156,600	156,600
13**	156,650	156,650
14	156,700	156,700
15**	156,750	156,750
16	156,800	156,800
17**	156,850	156,850
18	156,900	161,500
19	156,950	161,550
20	157,000	161,600
*	157,050	161,650
22	157,100	161,700
*	157,150	161,750
24	157,200	161,800
25	157,250	161,850
26	157,300	161,900

27	157,350	161,950
28	157,400	162,000
60	156,025	160,625
*	156,075	160,675
62	156,125	160,725
63	156,175	160,775
*	156,225	160,825
65	156,275	160,875
66	156,325	160,925
67**	156,375	156,375
68	156,425	156,425
69	156,475	156,475
71	156,575	156,575
72	156,625	—
73	156,675	156,675
74	156,725	156,725
75	***	***
76	***	***

77**	156,875	–
78	156,925	161,525
79	156,975	161,575
80	157,025	161,625
*	157,075	161,675
*	157,125	161,725
*	157,175	161,775
84	157,225	161,825
85	157,275	161,875
86	157,325	161,925
87	157,375	161,975
88	157,425	162,025

**AVIS:**

Un – dans la colonne Réception indique qu'il s'agit d'un canal de transmission seulement.

Déclaration de conformité pour utilisation des fréquences de détresse et de sécurité

L'équipement radio n'utilise pas de modulation autre que la modulation adoptée à l'échelle internationale pour l'usage en mer sur les fréquences de détresse et de sécurité spécifiées dans le CNR-182 section 7.3.

Paramètres techniques d'interface avec des sources de données externes

	RS232	USB	SB9600
Tension d'entrée (tension)	18V	3,6V	5V

**AVIS:**

*Les canaux simplex 3, 21, 23, 61, 64, 81, 82, et 83 ne peuvent être **utilisés légalement** par le grand public dans les eaux américaines.

**Faible puissance (1 W) seulement.

***Bande de garde.

crête à crête)			
Débit binaire maximum	28 kbit/s	12 Mbit/s	9,6 kbit/s
Impédance	5000 ohms	90 ohms	120 ohms

Garantie limitée

PRODUITS DE COMMUNICATIONS MOTOROLA SOLUTIONS

I. PROTECTION ASSURÉE PAR LA PRÉSENTE GARANTIE ET DURÉE DE CELLE-CI :

Motorola Solutions Inc. (« Motorola Solutions ») garantit les produits de télécommunications identifiés ci-dessous (le « Produit ») fabriqués par Motorola Solutions contre tout défaut de matériel ou de fabrication dans des conditions normales d'utilisation et d'entretien, pour une période suivant la date d'achat, tel qu'il est stipulé ci-dessous :

Radios numériques mobiles	24 mois
Accessoires des produits	12 mois

À sa discrétion, Motorola Solutions réparera sans frais le produit (avec des pièces neuves ou remises à neuf), le

remplacera (par un produit neuf ou remis à neuf) ou remboursera le prix d'achat du produit durant la période de garantie, à condition que le produit soit retourné au lieu d'achat conformément aux modalités de la présente garantie. Les pièces et les cartes remplacées sont garanties pour le reste de la période de garantie d'origine. Toute pièce remplacée du produit devient la propriété de Motorola Solutions.

Cette garantie limitée expresse est accordée par Motorola Solutions à l'acheteur ou à l'utilisateur final d'origine seulement, et ne peut être ni transférée ni cédée à un tiers. La présente garantie constitue la garantie complète du produit fabriqué par Motorola Solutions. Motorola Solutions n'assume aucune obligation ni responsabilité pour quelconques ajout ou modification apportés à la présente garantie, à moins d'être en présence d'un document écrit signé par un cadre supérieur de Motorola Solutions.

Sauf dans le cadre d'une entente distincte conclue entre Motorola Solutions et l'acheteur ou l'utilisateur final d'origine, Motorola Solutions ne garantit pas l'installation, l'entretien, ni la réparation du produit.

Motorola Solutions se dégage de toute responsabilité à l'égard de tout équipement ou accessoire qui n'est pas fourni par Motorola Solutions et qui est branché sur le produit ou utilisé conjointement avec celui-ci, ainsi qu'à

l'égard du fonctionnement du produit utilisé conjointement avec tout équipement ou accessoire, et tous les équipements de cette nature sont expressément exclus de la présente garantie. Compte tenu du caractère unique de chaque système pouvant utiliser le produit, Motorola Solutions se dégage de toute responsabilité à l'égard de la portée, de la diffusion et du fonctionnement du système.

II. CONDITIONS GÉNÉRALES

La présente garantie précise l'entière responsabilité de Motorola Solutions à l'égard du produit. À la discrétion de Motorola Solutions, la réparation du produit, son remplacement ou le remboursement de son prix d'achat constituent le seul recours. CETTE GARANTIE REMPLACE TOUTE AUTRE GARANTIE EXPRESSE. TOUTES LES GARANTIES IMPLICITES, COMPRENANT, SANS LIMITATION, LES GARANTIES IMPLICITES DE QUALITÉ MARCHANDE ET D'ADAPTATION À UN USAGE PARTICULIER, SONT LIMITÉES À LA PÉRIODE DÉFINIE PAR CETTE GARANTIE LIMITÉE. DANS LA MESURE AUTORISÉE PAR LA LOI, MOTOROLA SOLUTIONS NE POURRA EN AUCUN CAS ÊTRE TENUE RESPONSABLE DE DOMMAGES DONT LA VALEUR DÉPASSE LE PRIX D'ACHAT DU PRODUIT, NI À L'ÉGARD DES PERTES DE JOUISSANCE, DES

PERTES DE TEMPS, DES DÉRANGEMENTS, DES PERTES COMMERCIALES, DES PERTES DE PROFIT OU D'ÉCONOMIES, NI RELATIVEMENT À TOUT AUTRE DOMMAGE ACCESSOIRE, SPÉCIAL OU INDIRECT RÉSULTANT DE L'UTILISATION OU DE L'INCAPACITÉ D'UTILISER CE PRODUIT.

III. DROITS PRÉVUS PAR LES LOIS PROVINCIALES :

CERTAINES PROVINCES NE PERMETTENT AUCUNE EXCLUSION NI LIMITATION QUANT AUX DOMMAGES CONSÉCUTIFS OU INDIRECTS, NI AUCUNE LIMITE SUR LA DURÉE D'UNE GARANTIE IMPLICITE, DE SORTE QUE LES LIMITES OU EXCLUSIONS MENTIONNÉES PLUS HAUT PEUVENT NE PAS S'APPLIQUER DANS VOTRE CAS.

La présente garantie confère des droits juridiques précis et il est possible que vous jouissiez d'autres droits, selon votre province de résidence.

IV. ENTRETIEN COUVERT PAR LA GARANTIE

Pour que la réparation soit couverte par la garantie, vous devez fournir une preuve d'achat (portant la date d'achat et le numéro de série du Produit). De plus, vous devez livrer ou expédier le Produit, en payant d'avance les frais de transport et d'assurance, à un centre de service homologué. Les réparations sous garantie seront effectuées par Motorola Solutions à l'un de ses centres de service autorisés. Dans certains cas, il est plus facile d'obtenir les réparations couvertes par la garantie en s'adressant d'abord à l'entreprise qui vous a vendu le produit (p. ex. le détaillant ou votre fournisseur de services de télécommunication). Vous pouvez également appeler Motorola Solutions au numéro 1 800 927-2744.

V. CE QUI N'EST PAS COUVERT PAR CETTE GARANTIE

- 1 Utilisation du produit autrement que dans des conditions normales et habituelles.
- 2 Mauvaise utilisation, accident, négligence ou exposition à des liquides.
- 3 Pannes ou dommages résultants de tests, modes opératoires, maintenance, installation, modifications ou réglages inadaptés.
- 4 Dommage ou bris des antennes, sauf si causé directement par un défaut de fabrication ou de main-d'œuvre.
- 5 Un Produit soumis à des modifications, des réparations ou un démontage non autorisés (y compris, sans s'y limiter, l'ajout au Produit d'un équipement quelconque non fourni par Motorola Solutions) et qui ont un effet négatif sur le rendement du Produit ou qui nuisent à l'inspection ou à l'essai normal sous garantie du Produit par Motorola Solutions en cas de réclamation.
- 6 Tout produit dont le numéro de série a été retiré ou rendu illisible.
- 7 Batteries rechargeables si :
 - les protections étanches du boîtier sont brisées ou présentent des signes d'altération;
 - le dommage ou défaut a été provoqué par le chargement ou l'utilisation de la batterie dans des conditions ou avec des équipements autres que celles/ceux destiné (e) s au produit.
- 8 Coûts du fret à l'atelier de réparation.

- 9 Tout produit qui, à cause de modifications illégales ou interdites apportées au logiciel ou au micrologiciel du Produit, ne fonctionne pas conformément aux spécifications énoncées par Motorola Solutions ou sur l'étiquette de conformité de la FCC en vigueur pour ce Produit lorsque le Produit a été initialement distribué par Motorola Solutions.
 - 10 Les égratignures et les autres dommages superficiels qui ne nuisent pas au fonctionnement du produit.
 - 11 L'usure et le vieillissement normaux et habituels.
- 2 Motorola Solutions maîtrisera entièrement la défense de l'action juridique et toutes les négociations d'accord ou de compromis;
 - 3 Si le produit ou les pièces doivent ou, de l'avis de Motorola Solutions, pourraient faire l'objet d'une poursuite pour contrefaçon d'un brevet américain ou canadien, l'acheteur accordera le droit à Motorola Solutions, à la discrétion et aux frais de cette dernière, soit de procurer à l'acheteur le droit de continuer d'utiliser le produit ou les pièces, soit de remplacer ou de modifier ces derniers de manière à ce qu'ils n'enfreignent plus le brevet, soit d'accorder à l'acheteur un crédit équivalent à la valeur dépréciée du produit ou des pièces et d'accepter de reprendre ceux-ci. La dépréciation représentera un montant égal pour chaque année de durée de vie utile du produit ou des pièces, tel que déterminé par Motorola Solutions.

VI. DISPOSITIONS RELATIVES AUX BREVETS ET AUX LOGICIELS

Motorola Solutions défendra à ses frais toute poursuite menée en justice contre l'acheteur dans la mesure où la poursuite revendique que le produit ou certaines de ses pièces enfreignent un brevet des États-Unis et Motorola Solutions paiera les frais et dommages finalement accordés au détriment de l'acheteur dans toute poursuite judiciaire attribuable à une quelconque revendication de cette nature, une telle défense et un tel paiement étant soumis aux conditions suivantes :

- 1 Motorola Solutions doit être rapidement notifiée, par écrit, d'une telle réclamation par l'acheteur;

Motorola Solutions se dégage de toute responsabilité à l'égard de toute poursuite pour contrefaçon de brevet fondée sur une adaptation du produit ou des pièces mentionnées dans la présente à un logiciel, un appareil ou un équipement non fourni par Motorola Solutions. Motorola Solutions se dégage également de toute responsabilité à l'égard de tout équipement ou logiciel qui n'est pas fourni par Motorola Solutions et qui est rattaché au produit ou utilisé conjointement avec ce dernier. Ce qui précède

énonce l'entière responsabilité de Motorola Solutions pour la contrefaçon de brevets relative au produit ou à toute pièce de ce dernier.

Les lois au Canada, aux États-Unis et dans d'autres pays protègent au nom de Motorola Solutions certains droits exclusifs visant les logiciels, comme ceux de reproduire des copies et de distribuer des copies desdits logiciels Motorola Solutions. Les logiciels Motorola Solutions ne peuvent être utilisés qu'avec les produits à l'intérieur desquels ils étaient installés à l'origine. Il est interdit de remplacer, de copier, de distribuer, de modifier d'aucune façon et d'utiliser le logiciel à l'intérieur du produit en vue de fabriquer un quelconque produit dérivé. Aucune autre utilisation, y compris, sans s'y limiter, l'altération, la modification, la reproduction, la distribution ou l'ingénierie à rebours, d'un quelconque logiciel Motorola Solutions n'est permise. Aucune licence n'est accordée pour inférence, estoppel ou autre en vertu des droits de brevets ou des droits d'auteur de Motorola Solutions ou de tiers.

VII. LOI APPLICABLE

Cette garantie est régie par les lois de l'état de l'Illinois, É.-U.

www.motorolasolutions.com/mototrbo

Motorola Solutions, Inc.
500 W Monroe Street
Chicago, IL 60661 U.S.A.

Printed in U.S.A.

MOTOROLA, MOTO, MOTOROLA SOLUTIONS and the Stylized M Logo are trademarks or registered trademarks of Motorola Trademark Holdings, LLC and are used under license. All other trademarks are the property of their respective owners. © 2018 Motorola Solutions, Inc. All rights reserved.

