



**MOTOROLA**

MOTOTRBO **XPR™ 7550 Ex**

Color Display Portable

User Guide



**68009585001-A**



# Declaration of Conformity

This declaration is applicable to your radio **only** if your radio is labeled with the FCC logo shown below.

**DECLARATION OF CONFORMITY**  
Per FCC CFR 47 Part 2 Section 2.1077(a)



Responsible Party  
Name: Motorola Solutions, Inc.  
Address: 1303 East Algonquin Road, Schaumburg, IL 60196-1078, U.S.A.  
Phone Number: 1-800-927-2744

Hereby declares that the product:  
Model Name: **XPR 7550 Ex**

conforms to the following regulations:  
FCC Part 15, subpart B, section 15.107(a), 15.107(d) and section 15.109(a)

**Class B Digital Device**

As a personal computer peripheral, this device complies with Part 15 of the FCC Rules. **This device complies with Industry Canada licence-exempt RSS standard(s).** Operation is subject to the following two conditions:

1. This device may not cause harmful interference, and
2. This device must accept any interference received, including interference that may cause undesired operation.

**Note:** This equipment has been tested and found to comply with the limits for a Class B digital device, pursuant to part 15 of the FCC Rules. These limits are designed to provide reasonable protection against harmful interference in a residential installation. This equipment generates, uses and can radiate radio frequency energy and, if not installed and used in accordance with the instructions, may cause harmful interference to radio communications. However, there is no guarantee that interference will not occur in a particular installation.

If this equipment does cause harmful interference to radio or television reception, which can be determined by turning the equipment off and on, the user is encouraged to try to correct the interference by one or more of the following measures:

- Reorient or relocate the receiving antenna.
- Increase the separation between the equipment and receiver.
- Connect the equipment into an outlet on a circuit different from that to which the receiver is connected.
- Consult the dealer or an experienced radio/TV technician for help.

## Contents

This User Guide contains all the information you need to use the MOTOTRBO XPR Series **Digital Portable Radios**.

<b>Important Safety Information</b> .....	<b>7</b>
Product Safety and RF Exposure Compliance ...	7
<b>Software Version</b> .....	<b>7</b>
<b>Computer Software Copyrights</b> .....	<b>8</b>
<b>Handling Precautions</b> .....	<b>9</b>
<b>Getting Started</b> .....	<b>1</b>
How to Use This Guide .....	1
What Your Dealer/System Administrator Can Tell You .....	1
<b>Preparing Your Radio for Use</b> .....	<b>2</b>
Charging the Battery .....	2
Attaching the Battery .....	3
Attaching the Antenna .....	3
Attaching the Belt Clip .....	4
Attaching the Universal Connector Cover (Dust Cover) 4 .....	4
Powering Up the Radio .....	5
Adjusting the Volume .....	5

<b>Identifying Radio Controls</b> .....	<b>6</b>
Radio Controls .....	6
Programmable Buttons .....	7
Assignable Radio Functions .....	7
Assignable Settings or Utility Functions .....	9
Using the 4-Way Navigation Button .....	9
Accessing the Programmed Functions .....	10
Using the Keypad .....	11
Push-To-Talk (PTT) Button .....	12
Switching Between Conventional Analog and Digital Mode .....	13
IP Site Connect .....	13
Capacity Plus .....	14
Linked Capacity Plus .....	14
<b>Identifying Status Indicators</b> .....	<b>15</b>
Display Icons .....	16
Call Icons .....	17
Advanced Menu Icons .....	17
Mini Notice Icons .....	18
Sent Item Icons .....	18
LED Indicator .....	19
Indicator Tones .....	20
Audio Tones .....	20
<b>Making and Receiving Calls</b> .....	<b>21</b>
Selecting a Zone .....	21

Selecting a Channel .....	22	Scan Lists .....	37
Receiving and Responding to a Radio Call .....	23	Viewing an Entry in the Scan List .....	37
Receiving and Responding to a Group Call .....	23	Viewing an Entry in the Scan List by Alias Search	37
Receiving and Responding to a Private Call .....	24	Editing the Scan List .....	38
Receiving an All Call .....	24	Adding a New Entry to the Scan List .....	38
Receiving and Responding to a Selective Call .....	25	Deleting an Entry from the Scan List .....	38
Making a Radio Call .....	26	Setting and Editing Priority for an Entry in the Scan	List
Making a Call with the Channel Selector Knob .....	26	.....	39
Making a Group Call .....	26	Scan .....	40
Making a Private Call .....	27	Starting and Stopping Scan .....	41
Making an All Call .....	28	Responding to a Transmission During a Scan .....	41
Making a Selective Call .....	28	Deleting a Nuisance Channel .....	42
Making a Group, Private or All Call with the		Restoring a Nuisance Channel .....	42
Programmable Number Key .....	29	Vote Scan .....	42
Stopping a Radio Call .....	30	Contacts Settings .....	43
Talkaround .....	31	Making a Group Call from Contacts .....	43
Monitoring Features .....	32	Making a Private Call from Contacts .....	44
Monitoring a Channel .....	32	Making a Call by Alias Search .....	45
Permanent Monitor .....	32	Assigning an Entry to a Programmable	Number Key
<b>Advanced Features .....</b>	<b>33</b>	.....	46
Radio Check .....	34	Removing the Association between Entry and	Programmable Number Key
Sending a Radio Check .....	34	.....	46
Remote Monitor .....	35	Setting Default Contact .....	47
Initiating Remote Monitor .....	35	Call Indicator Settings .....	47
Stopping Remote Monitor .....	36	Activating or Deactivating Call Ringers for Call Alert	47

Activating or Deactivating Call Ringers for Private Calls	48	57	
Activating or Deactivating Call Ringers for Selective Call	48	Reinitiating an Emergency Mode	58
Activating or Deactivating Call Ringers for Text Message	49	Exiting Emergency Mode	58
Activating or Deactivating Call Ringers for Telemetry Status with Text	49	Man Down	59
Assigning Ring Styles	50	Text Message Features	60
Escalating Alarm Tone Volume	50	Writing and Sending a Text Message	60
Call Log Features	51	Sending a Quick Text Message	61
Viewing Recent Calls	51	Sending a Quick Text Message with the One Touch Access Button	62
Storing an Alias or ID from a Call List	51	Accessing the Drafts Folder	62
Deleting a Call from a Call List	51	Viewing a Saved Text Message	62
Viewing Details from a Call List	52	Editing and Sending a Saved Text Message	62
Call Alert Operation	52	Deleting a Saved Text Message from Drafts	63
Receiving and Responding to a Call Alert	52	Managing Fail-to-Send Text Messages	63
Making a Call Alert from the Contacts List	53	Resending a Text Message	64
Making a Call Alert with the One Touch Access Button	53	Forwarding a Text Message	64
Emergency Operation	54	Editing a Text Message	64
Receiving an Emergency Alarm	54	Managing Sent Text Messages	65
Responding to an Emergency Alarm	55	Viewing a Sent Text Message	65
Sending an Emergency Alarm	55	Sending a Sent Text Message	65
Sending an Emergency Alarm with Call	56	Deleting All Sent Text Messages from Sent Items	67
Sending an Emergency Alarm with Voice to Follow		Receiving a Text Message	67
		Reading a Text Message	67
		Managing Received Text Messages	68
		Viewing a Text Message from the Inbox	68

Viewing a Telemetry Status Text Message from the Inbox . . . . .	68	Utilities . . . . .	82
Replying to a Text Message from the Inbox . . .	69	Turning the Radio Tones/Alerts On or Off . . . . .	82
Deleting a Text Message from the Inbox . . . . .	69	Turning Keypad Tones On or Off . . . . .	82
Deleting All Text Messages from the Inbox . . .	70	Setting the Tone Alert Volume Offset Level . . . . .	83
Analog Message Encode . . . . .	71	Turning the Talk Permit Tone On or Off . . . . .	83
Sending MDC Message Encode to Dispatcher . .	71	Changing the Display Mode . . . . .	84
Analog Status Update . . . . .	71	Adjusting the Display Brightness . . . . .	84
Sending Status Update to Predefined Contact . .	71	Controlling the Display Backlight . . . . .	84
Privacy . . . . .	72	Setting the Squelch Level . . . . .	85
Dual Tone Multi Frequency (DTMF) . . . . .	73	Turning the Introduction Screen On or Off . . . . .	85
Multi-Site Controls . . . . .	74	Locking and Unlocking the Keypad . . . . .	86
Starting an Automatic Site Search . . . . .	74	Language . . . . .	86
Stopping an Automatic Site Search . . . . .	74	Turning the LED Indicator On or Off . . . . .	87
Starting a Manual Site Search . . . . .	75	Turning the Voice Operating Transmission (VOX) Feature On or Off . . . . .	87
Security . . . . .	76	Turning the Option Board Feature(s) On or Off . .	88
Radio Disable . . . . .	76	Identifying Cable Type . . . . .	88
Radio Enable . . . . .	77	Voice Announcement . . . . .	88
Lone Worker . . . . .	78	Call Forwarding . . . . .	89
Password Lock Features . . . . .	78	Menu Timer . . . . .	89
Accessing the Radio from Password . . . . .	78	Analog Mic AGC . . . . .	89
Unlocking the Radio from Locked State . . . . .	79	Digital Mic AGC . . . . .	90
Turning the Password Lock On or Off . . . . .	79	Intelligent Audio . . . . .	90
Changing the Password . . . . .	80	GPS . . . . .	91
Notification List . . . . .	81	Accessing General Radio Information . . . . .	91
Accessing the Notification List . . . . .	81	Accessing the Battery Information . . . . .	92



Checking the Radio Alias and ID .....	92
Checking the Firmware Version and Codeplug Ver- sion .....	92
Checking the GPS Information .....	93
Front Panel Configuration (FPC) .....	93
Entering FPC Mode .....	93
Editing FPC Mode Parameters .....	93
<b>Accessories .....</b>	<b>94</b>
Antennas .....	94
Batteries .....	94
Carry Devices .....	95
Chargers .....	95
Headsets and Headset Accessories .....	95
Remote Speaker Microphones .....	95
Miscellaneous Accessories .....	95
<b>Batteries and Chargers Warranty .....</b>	<b>96</b>
<b>Limited Warranty .....</b>	<b>97</b>
<b>Notes .....</b>	<b>100</b>

## Important Safety Information

### Product Safety and RF Exposure Compliance



Caution

Before using this product, read the operating instructions for safe usage contained in the Product Safety and RF Exposure booklet enclosed with your radio.

### ATTENTION!

**This radio is restricted to occupational use only to satisfy FCC RF energy exposure requirements.**

Before using this product, read the RF energy awareness information and operating instructions in the **Regulatory Compliance and Product Safety section of your Quick Reference Guide** enclosed with your radio (Motorola Publication part number **68009584001**) to ensure compliance with RF energy exposure limits.

Keep the Quick Reference Guide available to all users of the radio.

For a list of Motorola-approved antennas, batteries, and other accessories, visit the following website:

<http://www.motorolasolutions.com>

*Any modification to this device, not expressly authorized by Motorola, may void the safety and regulatory compliance of the radio. The radio must only be repaired or serviced at authorized Motorola Service Centers. Contact your dealer or system administrator for details.*

## Software Version

All the features described in the following sections are supported by the radio's software version **R02.06.00**.

See **Checking the Firmware Version and Codeplug Version** on page 93 to determine your radio's software version.

Check with your dealer or system administrator for more details of all the features supported.

## Computer Software Copyrights

The Motorola products described in this manual may include copyrighted Motorola computer programs stored in semiconductor memories or other media. Laws in the United States and other countries preserve for Motorola certain exclusive rights for copyrighted computer programs including, but not limited to, the exclusive right to copy or reproduce in any form the copyrighted computer program. Accordingly, any copyrighted Motorola computer programs contained in the Motorola products described in this manual may not be copied, reproduced, modified, reverse-engineered, or distributed in any manner without the express written permission of Motorola. Furthermore, the purchase of Motorola products shall not be deemed to grant either directly or by implication, estoppel, or otherwise, any license under the copyrights, patents or patent applications of Motorola, except for the normal non-exclusive license to use that arises by operation of law in the sale of a product.

The AMBE+2™ voice coding Technology embodied in this product is protected by intellectual property rights including patent rights, copyrights and trade secrets of Digital Voice Systems, Inc.

This voice coding Technology is licensed solely for use within this Communications Equipment. The user of this Technology is explicitly prohibited from attempting to decompile, reverse engineer, or disassemble the Object Code, or in any other way convert the Object Code into a human-readable form.

U.S. Pat. Nos. #5,870,405, #5,826,222, #5,754,974, #5,701,390, #5,715,365, #5,649,050, #5,630,011, #5,581,656, #5,517,511, #5,491,772, #5,247,579, #5,226,084 and #5,195,166.

## Handling Precautions

The MOTOTRBO Series Digital Portable radio meets IP57 specifications, allowing the radio to withstand adverse field conditions such as being submersed in water.

- If the radio has been submersed in water, shake the radio well to remove any water that may be trapped inside the speaker grille and microphone port. Trapped water could cause decreased audio performance.
- If the radio's battery contact area has been exposed to water, clean and dry battery contacts on both the radio and the battery before attaching the battery to the radio. The residual water could short-circuit the radio.
- If the radio has been submersed in a corrosive substance (e.g. saltwater), rinse the radio and battery in fresh water then dry the radio and battery.
- To clean the exterior surfaces of the radio, use a diluted solution of mild dishwashing detergent and fresh water (i.e. one teaspoon of detergent to one gallon of water).

- Never poke the vent (hole) located on the radio chassis below the battery contact. This vent allows for pressure equalization in the radio. Doing so may create a leak path into the radio and the radio's submersibility may be lost.
- Never obstruct or cover the vent, even with a label.
- Ensure that no oily substances come in contact with the vent.
- The radio with antenna attached properly is designed to be submersible to a maximum depth of 1 meter (3.28 feet) and a maximum submersion time of 30 minutes. Exceeding either maximum limit or use without antenna may result in damage to the radio.
- When cleaning the radio, do not use a high pressure jet spray on the radio as this will exceed the 1 meter depth pressure and may cause water to leak into the radio.



**Caution**

Do not disassemble the radio. This could damage radio seals and result in leak paths into the radio. Radio maintenance should only be done in service depot that is equipped to test and replace the seal on the radio.

## Getting Started

Take a moment to review the following:

How to Use This Guide . . . . .	page 1
What Your Dealer/System Administrator Can Tell You. . . . .	page 1

### ■ How to Use This Guide

This User Guide covers the basic operation of the MOTOTRBO Portables.

However, your dealer or system administrator may have customized your radio for your specific needs. Check with your dealer or system administrator for more information.

Throughout this publication, the icons below are used to indicate features supported in either the conventional Analog mode or conventional Digital mode:



Indicates a conventional **Analog Mode-Only** feature.



Indicates a conventional **Digital Mode-Only** feature.

For features that are available in **both** conventional Analog and Digital modes, **no** icon is shown.

For features that are available in a conventional multi-site mode, see **IP Site Connect** on page 13 for more information.

Selected features are **also** available on the single-site trunking mode, Capacity Plus. See **Capacity Plus** on page 14 for more information.

Selected features are **also** available in the multi-site trunking mode, Linked Capacity Plus. See **Linked Capacity Plus** on page 14 for more information.

### ■ What Your Dealer/System Administrator Can Tell You

You can consult your dealer or system administrator about the following:

- Is your radio programmed with any preset conventional channels?
- Which buttons have been programmed to access other features?
- What optional accessories may suit your needs?
- What are the best radio usage practices for effective communication?
- What maintenance procedures will help promote longer radio life?

## Preparing Your Radio for Use

Assemble your radio by following these steps:

- Charging the Battery . . . . . page 2
- Attaching the Battery . . . . . page 3
- Attaching the Antenna . . . . . page 3
- Attaching the Belt Clip . . . . . page 4
- Attaching the Universal Connector  
Cover (Dust Cover) . . . . . page 4
- Powering Up the Radio . . . . . page 5
- Adjusting the Volume . . . . . page 5

## Charging the Battery



**Caution**

Charge your battery only in non-hazardous areas. After battery is charged, allow your radio to rest for at least 3 minutes. See **Batteries** on page 94 for available batteries.

For best performance, your radio is powered by a Motorola-approved Lithium-Ion (Li-Ion) battery. To avoid damage and comply with warranty terms, charge the battery using a Motorola charger *exactly* as described in the charger user guide.

If battery is attached to your radio, ensure that your radio remains powered off while charging.

Charge a new battery 14 to 16 hours before initial use for best performance.

**IMPORTANT:** **ALWAYS** charge your IMPRES battery with an IMPRES charger for optimized battery life and valuable battery data. IMPRES batteries charged exclusively with IMPRES chargers receive a 6-month capacity warranty extension over the standard Motorola Premium battery warranty duration.

## ■ Attaching the Battery



**Caution**

Do not replace battery in gas and dust environments. Replace battery only in non-hazardous areas. See **Batteries** on page 94 for available batteries.

Align the battery with the rails on the back of the radio. Press the battery firmly, and slide upward until the latch snaps into place. Slide battery latch into lock position.

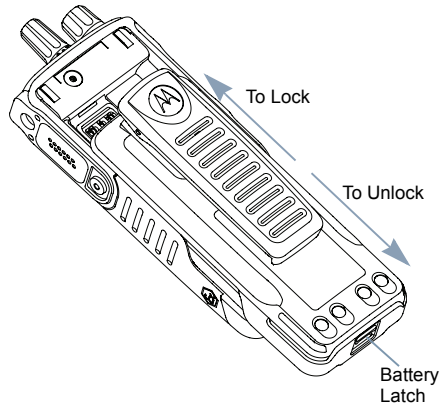

To remove the battery, turn the radio off. Move the battery latch into unlock position and hold, and slide the battery down and off the rails.

## ■ Attaching the Antenna

With the radio turned off, set the antenna in its receptacle and turn clockwise.

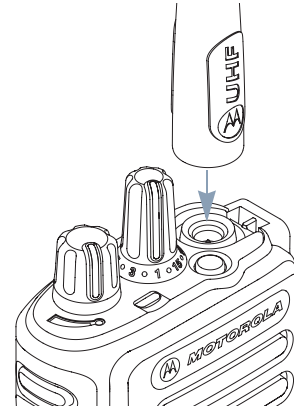

To remove the antenna, turn the antenna counterclockwise.



**Caution**

If antenna needs to be replaced, ensure that only MOTOTRBO antennas are used. Neglecting this will damage your radio. See **Antennas** on page 94 for a list of available antennas.

## ■ Attaching the Belt Clip

Align the grooves on the clip with those on the battery and press downward until you hear a click.

*To remove the clip, press the belt clip tab away from the battery. Using a key may be helpful. Then slide the clip upward and away from the radio.*

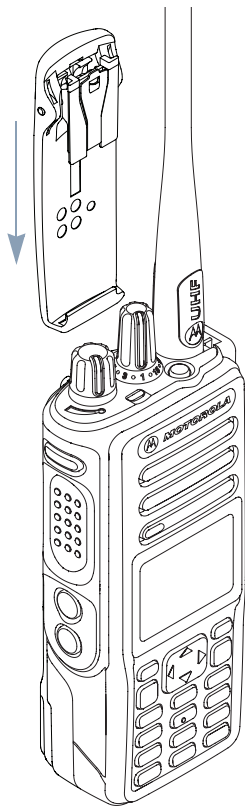

## ■ Attaching the Universal Connector Cover (Dust Cover)

The universal connector is located on the antenna side of the radio. It is used to connect MOTOTRBO accessories to the radio.



Insert the hooked end of the cover into the slots above the universal connector. Press downward on the cover to seat the lower tab properly into the RF connector.

Turn the thumbscrew clockwise to secure the connector cover to the radio.

*To remove the universal connector cover, press down on the cover and turn the thumbscrew counterclockwise.*

*Replace the dust cover when the universal connector is not in use.*



## ■ Powering Up the Radio

Rotate the **On/Off/Volume Control Knob** clockwise until you hear a click. You see **MOTOTRBO (TM)** on the radio's display momentarily, followed by a welcome message or welcome image.

The LED lights up solid green and the Home screen lights up if the backlight setting is set to turn on automatically.

**NOTE:** The Home screen does not light up during a power up if the LED indicator is disabled (see **Turning the LED Indicator On or Off** on page 88).

A brief tone sounds, indicating that the power up test is successful.

**NOTE:** There is no power up tone if the radio tones/alerts function is disabled (see **Turning the Radio Tones/Alerts On or Off** on page 83).

If your radio does not power up, check your battery. Make sure that it is charged and properly attached. If your radio still does not power up, contact your dealer.

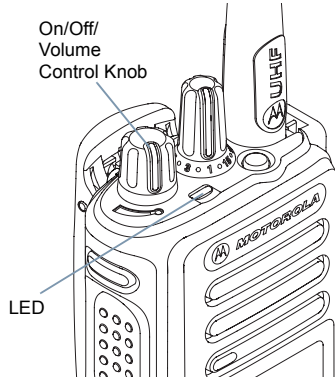

To turn off the radio, rotate this knob counterclockwise until you hear a click. You see a brief *Powering Down* on the radio's display.

## ■ Adjusting the Volume

To increase the volume, turn the **On/Off/Volume Control Knob** clockwise.

To decrease the volume, turn this knob counterclockwise.

**NOTE:** Your radio can be programmed to have a minimum volume offset where the volume level cannot be turned past the programmed minimum volume. Check with your dealer or system administrator for more information.

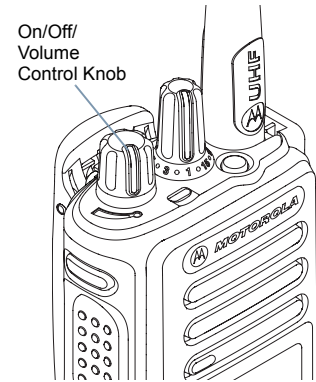

## Identifying Radio Controls

Take a moment to review the following:

Radio Controls . . . . .	page 6
Programmable Buttons . . . . .	page 7
Using the 4-Way Navigation Button . . . . .	page 9
Accessing the Programmed Functions . . . . .	page 10
Using the Keypad . . . . .	page 11
Push-To-Talk (PTT) Button . . . . .	page 12
Switching Between Conventional Analog and Digital Mode. . . . .	page 13
IP Site Connect . . . . .	page 13
Capacity Plus . . . . .	page 14
Linked Capacity Plus. . . . .	page 14

## Radio Controls

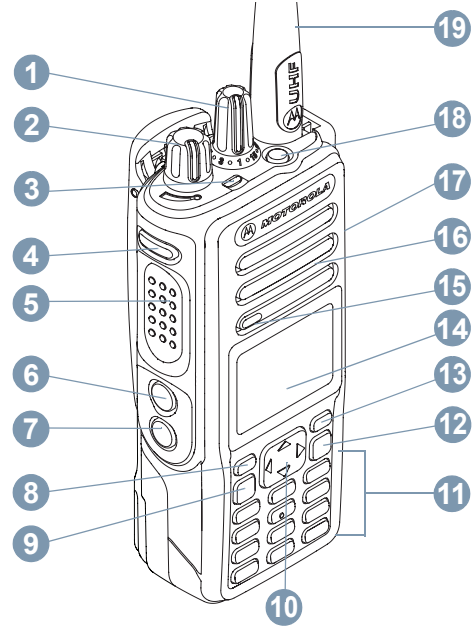

- 1 Channel Selector Knob\*
- 2 On/Off/Volume Control Knob
- 3 LED Indicator

- 4 Side Button 1\*\*
- 5 Push-to-Talk (PTT) Button
- 6 Side Button 2\*\*
- 7 Side Button 3\*\*
- 8 Front Button P1\*\*
- 9 Menu/OK Button
- 10 4-Way Navigation Button
- 11 Keypad
- 12 Back/Home Button
- 13 Front Button P2\*\*
- 14 Display
- 15 Microphone
- 16 Speaker
- 17 Universal Connector for Accessories
- 18 Emergency Button\*\*
- 19 Antenna

\* Display radios have a continuous-rotary Channel Selector Knob

\*\* These buttons are programmable.

## ■ Programmable Buttons

Your dealer can program the programmable buttons as shortcuts to **radio functions** or **preset channels/groups** depending on the duration of a button press:

- Short press – Pressing and releasing rapidly.
- Long press – Pressing and holding for the programmed duration.
- Hold down – Keeping the button pressed.

**NOTE:** The programmed duration of a button press is applicable for all assignable radio/utility functions or settings. See **Emergency Operation** on page 54 for more information on the programmed duration of the **Emergency** button.

### Assignable Radio Functions

**Contacts** – Provides direct access to the contacts list.

**Call Alert** – Provides direct access to the contacts list for you to select a contact to whom a Call Alert can be sent.

**Call Forwarding** – Toggles Call Forwarding on or off.

**Call Log** – Selects the call log list.

**Voice Announcement for Channel** – Plays zone and channel announcement voice messages for the current channel. This function is unavailable when Voice Announcement is disabled.

**Emergency** – Depending on the programming, initiates or cancels an emergency alarm or call.

**Intelligent Audio On/Off** – Toggles Intelligent Audio on or off.

**Manual Dial**  – Initiates a call by keying in any subscriber ID.

**Manual Site Roam\*‡**  – Starts the manual site search.

**Mic AGC On/Off** – Toggles the internal microphone automatic gain control (AGC) on or off.

**Monitor** – Monitors a selected channel for activity.

**Nuisance Channel Delete\*‡** – Temporarily removes an unwanted channel, except for the Selected Channel, from the scan list. The Selected Channel refers to the user's selected zone/channel combination from which scan is initiated.

**One Touch Access** – Directly initiates a predefined Private or Group Call, a Call Alert or a Quick Text message.

**Option Board Feature** – Toggles option board feature(s) on or off for option board-enabled channels.

**Permanent Monitor\*‡** – Monitors a selected channel for all radio traffic until function is disabled.

**Privacy**  – Toggles privacy on or off.

**Radio Alias and ID** – Provides radio alias and ID.

**Radio Check**  – Determines if a radio is active in a system.

**Radio Enable**  – Allows a target radio to be remotely enabled.

**Radio Disable**  – Allows a target radio to be remotely disabled.

**Remote Monitor**  – Turns on the microphone of a target radio without it giving any indicators.

**Repeater/Talkaround\*‡** – Toggles between using a repeater and communicating directly with another radio.

**Scan\*‡** – Toggles scan on or off.

**Site Lock On/Off\***  – Toggles the automatic site roam on or off.

**Status** – Selects the status list menu.

**Telemetry Control**  – Controls the Output Pin on a local or remote radio.

**Text Message** – Selects the text message menu.

**Transmit Interrupt Remote Dekey**  – Stops the transmission of a remote monitored radio without giving any indicators, or an ongoing interruptible call to free the channel.

**Voice Announcement On/Off** – Toggles Voice Announcement on or off.

\* Not applicable in Capacity Plus

‡ Not applicable in Linked Capacity Plus

**Voice Operating Transmission (VOX)** – Toggles VOX on or off.

**Zone** – Allows selection from a list of zones.

\* *Not applicable in Capacity Plus*  
 ‡ *Not applicable in Linked Capacity Plus*

### Assignable Settings or Utility Functions

**All Tones/Alerts** – Toggles all tones and alerts on or off.

**Backlight On/Off** – Toggles display backlight on or off.

**Backlight Brightness** – Adjusts the brightness level.

**Display Mode** – Toggles the day/night display mode on or off.

**Keypad Lock** – Toggles keypad between locked and unlocked.

**Squelch**  – Toggles squelch level between tight and normal.

## ■ Using the 4-Way Navigation Button

You can use the 4-way navigation button, , to scroll through options, increase/decrease values, and navigate vertically.

Category	▲ or ▼	◀ or ▶
Menu	Vertical Navigation	–
Lists	Vertical Navigation	–
View Details	Vertical Navigation	Previous/Next Item

You can use the 4-way navigation button, , as a number, alias, or free form text editor.

Editor Category	▲ or ▼	◀ or ▶
Number	–	Left: Delete last digit Right: –
Alias	–	Move cursor one character left/right
Free Form Text	Move cursor up/down	Move cursor one character left/right
Numeric Values	Increase/Decrease	–

## ■ Accessing the Programmed Functions





You can access various radio functions through one of the following ways:

- A short or long press of the relevant programmable buttons.

OR















- Use the 4-way navigation button as follows:

- 1 To access the menu, press the  button. Press the appropriate direction of the  to access the menu functions.
- 2 To select a function or enter a sub-menu, press the  button.
- 3 To go back one menu level, or to return to the previous screen, press the  button. Long press the  button to return to the Home screen.

**NOTE:** Your radio automatically exits the menu after a period of inactivity and returns to your Home screen.

## ■ Using the Keypad

You can use the 3 x 4 alphanumeric keypad to access your radio's features. You can use the keypad to enter subscriber aliases or IDs, and text messages. Many characters require that you press a key multiple times. The table below shows the number of times a key needs to be pressed to generate the required character.

Key	Number of Times Key is Pressed												
	1	2	3	4	5	6	7	8	9	10	11	12	13
	1	.	,	?	!	@	&	'	%	-	:	*	#
	A	B	C	2									
	D	E	F	3									
	G	H	I	4									
	J	K	L	5									
	M	N	O	6									
	P	Q	R	S	7								
	T	U	V	8									
	W	X	Y	Z	9								
	0	<b>NOTE:</b> Press to enter "0" and long press to activate the CAPS lock. Another long press to turn off the CAPS lock.											
	* or del	<b>NOTE:</b> Press during text entry to delete the character. Press during numeric entry to enter a "**".											
	# or space	<b>NOTE:</b> Press during text entry to insert a space. Press during numeric entry to enter a "##".											

## ■ Push-To-Talk (PTT) Button

The **PTT** button on the side of the radio serves two basic purposes:

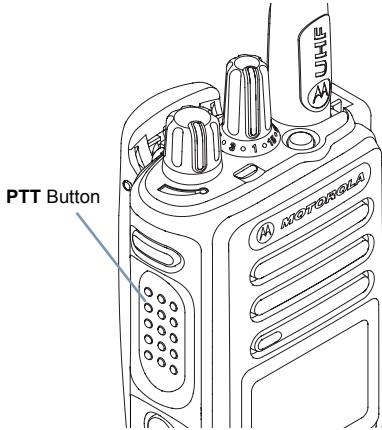



- While a call is in progress, the **PTT** button allows the radio to transmit to other radios in the call.

Press and hold down **PTT** button to talk. Release the **PTT** button to listen.

The microphone is activated when the **PTT** button is pressed.

- While a call is not in progress, the **PTT** button is used to make a new call (see **Making a Radio Call** on page 26).

If the Talk Permit Tone (see **Turning the Talk Permit Tone On or Off** on page 85) or the **PTT** Sidetone  is enabled, wait until the short alert tone ends before talking.

-  During a call, if the Channel Free Indication feature is enabled on your radio (programmed by your dealer), you hear a short alert tone the moment the target radio (the radio that is receiving your call) releases the **PTT** button, indicating the channel is free for you to respond.
-  You will also hear a continuous talk prohibit tone, if your call is interrupted, indicating that you should release the **PTT** button, for example when the radio receives an Emergency Call.



## ■ Switching Between Conventional Analog and Digital Mode

Each channel in your radio can be configured as a conventional analog or conventional digital channel. Use the Channel Selector Knob to switch between an analog or a digital channel.

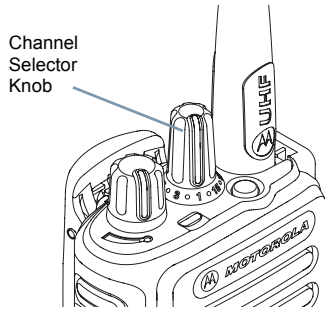

When switching from digital to analog mode, certain features are unavailable. Icons for the digital features (such as Messages) reflect this change by appearing 'grayed out'. Disabled features are hidden in the menu.

Your radio also has features available in both analog and digital mode. However, the minor differences in the way each feature works does **NOT** affect the performance of your radio.

**NOTE:** Your radio also switches between digital and analog modes during a dual mode scan (see **Scan** on page 40).

## ■ IP Site Connect

This feature allows your radio to extend conventional communication beyond the reach of a single site, by connecting to different available sites which are connected via an Internet Protocol (IP) network.

When the radio moves out of range from one site and into the range of another, it connects to the new site's repeater to send or receive calls/data transmissions. Depending on your settings, this is done automatically or manually.

If the radio is set to do this automatically, it scans through all available sites when the signal from the current site is weak or when the radio is unable to detect any signal from the current site. It then locks on to the repeater with the strongest Received Signal Strength Indicator (RSSI) value.

In a manual site search, the radio searches for the next site in the roam list that is currently in range (but which may not have the strongest signal) and locks on to it.

**NOTE:** Each channel can only have either Scan or Roam enabled, not both at the same time.

Channels with this feature enabled can be added to a particular roam list. The radio searches the channel(s) in the roam list during the automatic roam operation to locate the best site.

A roam list supports a maximum of 16 channels (including the Selected Channel).

**NOTE:** You cannot manually add or delete an entry to the roam list. Check with your dealer or system administrator for more information.

## ■ Capacity Plus

---

Capacity Plus is a single-site trunking configuration of the MOTOTRBO radio system, which uses a pool of channels to support hundreds of users and up to 254 Groups. This feature allows your radio to efficiently utilize the available number of programmed channels while in Repeater Mode.

Icons of features not applicable to Capacity Plus are not available in the menu. You hear a negative indicator tone if you try to access a feature not applicable to Capacity Plus via a programmable button press.

Your radio also has features that are available in conventional digital mode, IP Site Connect, Capacity Plus and Linked Capacity Plus. However, the minor differences in the way each feature works does **NOT** affect the performance of your radio.

Check with your dealer or system administrator for more information on this configuration.

## ■ Linked Capacity Plus

---

Linked Capacity Plus is a multi-site multi-channel trunking configuration of the MOTOTRBO radio system, combining the best of both Capacity Plus and IP Site Connect configurations.

Linked Capacity Plus allows your radio to extend trunking communication beyond the reach of a single site, by connecting to different available sites which are connected via an Internet Protocol (IP) network. It also provides an increase in capacity by efficiently utilizing the combined available number of programmed channels supported by each of the available sites.

When the radio moves out of range from one site and into the range of another, it connects to the new site's repeater to send or receive calls/data transmissions. Depending on your settings, this is done automatically or manually.

If the radio is set to do this automatically, it scans through all available sites when the signal from the current site is weak or when the radio is unable to detect any signal from the current site. It then locks on to the repeater with the strongest Received Signal Strength Indicator (RSSI) value.

In a manual site search, the radio searches for the next site in the roam list that is currently in range (but which may not have the strongest signal) and locks on to it.

Any channel with Linked Capacity Plus enabled can be added to a particular roam list. The radio searches these channels during the automatic roam operation to locate the best site.

**NOTE:** You cannot manually add or delete an entry to the roam list. Check with your dealer or system administrator for more information.

Similar to Capacity Plus, icons of features not applicable to Linked Capacity Plus are not available in the menu. You hear a negative indicator tone if you try to access a feature not applicable to Linked Capacity Plus via a programmable button press.

Check with your dealer or system administrator for more information on this configuration.

## Identifying Status Indicators

Your radio indicates its operational status through the following:

Display Icons . . . . .	page 16
Call Icons . . . . .	page 17
Advanced Menu Icons . . . . .	page 17
Mini Notice Icons . . . . .	page 18
Sent Item Icons . . . . .	page 18
LED Indicator . . . . .	page 19
Audio Tones . . . . .	page 20
Indicator Tones . . . . .	page 20

## ■ Display Icons

The 132 x 90 pixels, 256 colors, liquid crystal display (LCD) of your radio shows radio status, text entries, and menu entries.

The following are icons that appear on the status bar at the top of the radio's display. Icons are displayed on the status bar, arranged left-to-right, in order of appearance/usage and are channel specific.



### Received Signal Strength Indicator (RSSI)

The number of bars displayed represents the radio signal strength. Four bars indicate the strongest signal. This icon is only displayed while receiving.



### Battery

The number of bars (0 – 4) shown indicates the charge remaining in the battery. Blinks when the battery is low.



### Emergency

Radio is in Emergency mode.



### Notification

Notification List has one or more missed events.



### Scan<sup>‡</sup>

Scan feature is enabled.



### Scan – Priority 1<sup>‡</sup>

Radio detects activity on channel/group designated as Priority 1).



### Scan – Priority 2<sup>‡</sup>

Radio detects activity on channel/group designated as Priority 2.



### Vote Scan

Vote scan feature is enabled.



### Monitor

Selected channel is being monitored.



### Talkaround<sup>‡</sup>

In the absence of a repeater, radio is currently configured for direct radio to radio communication.



### Site Roaming<sup>\*</sup>

The site roaming feature is enabled.



### Secure

The Privacy feature is enabled.



### Unsecure

The Privacy feature is disabled.



### GPS Available

The GPS feature is enabled. The icon stays lit when a position fix is available.



### GPS Not Available/Out of Range

The GPS feature is enabled but is not receiving data from the satellite.



### Option Board

The Option Board is enabled.

<sup>\*</sup> Not applicable in Capacity Plus

<sup>‡</sup> Not applicable in Linked Capacity Plus

**Option Board Non-Function**

The Option Board is disabled.

**Tones Disable**

Tones are turned off.

\* *Not applicable in Capacity Plus*  
‡ *Not applicable in Linked Capacity Plus*

## ■ Call Icons

---

The following icons appear on the radio's display during a call. These icons also appear in the Contacts list to indicate ID type.

**Private Call**

Indicates a Private Call in progress.

In the Contacts list, it indicates a subscriber alias (name) or ID (number).

**Group Call/All Call**

Indicates a Group Call or All Call in progress.

In the Contacts list, it indicates a group alias (name) or ID (number).

## ■ Advanced Menu Icons

---

The following icons appear beside menu items that offer a choice between two options or as an indication that there is a sub-menu offering two options.

**Checkbox (Empty)**

Indicates the option is not selected.

**Checkbox (Checked)**

Indicates the option is selected.

**Solid Black Box**

Indicates the option selected for the menu item with a sub-menu.

## ■ Mini Notice Icons

The following icons appear momentarily on the radio's display after an action to perform task is taken.



### Successful Transmission (Positive)

Successful action taken.



### Failed Transmission (Negative)

Failed action taken.



### Transmission in Progress (Transitional)

Transmitting. This dynamic icon is seen before indication for Successful Transmission or Failed Transmission.

## ■ Sent Item Icons

The following icons appear in the Sent Items folder.



OR

### Sent Successfully

The text message is sent successfully.



OR

### Send Failed

The text message cannot be sent.



### In-Progress



OR

- The text message to a subscriber alias or ID is pending transmission, followed by waiting for acknowledgement.



- The text message to a group alias or ID is pending transmission.

## ■ LED Indicator

The LED indicator shows the operational status of your radio.

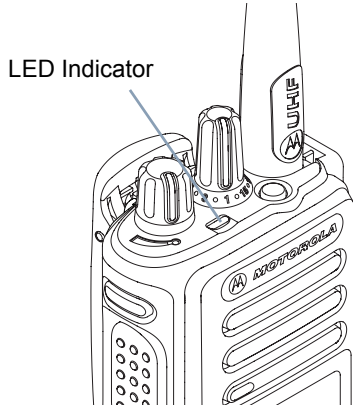

**Blinking red** – Radio is transmitting at low battery condition, receiving an emergency transmission, has failed the self-test upon powering up.

**Solid green** – Radio is powering up, or transmitting.

**Blinking green** – Radio is receiving a non-privacy-enabled call or data, detecting activity over the air.

**Double blinking green** – Radio is receiving a privacy-enabled call or data .

**Solid yellow** – Radio is monitoring a conventional channel.

**Blinking yellow** – Radio is scanning for activity or receiving a Call Alert, or all local Linked Capacity Plus channels are busy.

**Double blinking yellow** – Radio is no longer connected to the repeater while in Capacity Plus or Linked Capacity Plus, all Capacity Plus channels or Linked Capacity Plus channels are currently busy, Auto Roaming is enabled, radio is actively searching for a new site. Also indicates radio has yet to respond to a group call alert, or radio is locked.

**NOTE:** While in conventional mode, when the LED blinks green, it indicates the radio detects activity over the air. Due to the nature of the digital protocol, this activity may or may not affect the radio's programmed channel.

For Capacity Plus and Linked Capacity Plus, there is no LED indication when the radio is detecting activity over the air.

## ■ Indicator Tones

High pitched tone □

Low pitched tone ■



Positive Indicator Tone





Negative Indicator Tone

## ■ Audio Tones

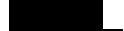
Alert tones provide you with audible indications of the radio's status or the radio's response to data received.

**Continuous Tone** A monotone sound. Sounds continuously until termination.  

**Periodic Tone** Sounds periodically depending on the duration set by the radio. Tone starts, stops, and repeats itself.  

**Repetitive Tone** A single tone that repeats itself until it is terminated by the user.  

**Momentary Tone** Sounds only once for a short period of time defined by the radio.  



## Making and Receiving Calls

Once you understand how your MOTOTRBO Portable is configured, you are ready to use your radio.

Use this navigation guide to familiarize yourself with the basic Call features:

Selecting a Zone . . . . .	page 21
Selecting a Radio Channel, Subscriber ID, or Group ID . . . . .	page 23
Receiving and Responding to a Radio Call . . . . .	page 23
Making a Radio Call . . . . .	page 26
Stopping a Radio Call . . . . .	page 30
Talkaround . . . . .	page 31
Monitoring Features . . . . .	page 32

## Selecting a Zone

A zone is a group of channels. Your radio supports up to 1000 channels and 250 zones, with a maximum of 160 channels per zone.

Use the following procedure to select a zone.

### Procedure:



Press the programmed Zone button and proceed to Step 3.

### OR

Follow the procedure below.

- 1  to access the menu.





---

  - 2  or  to Zone and press  to select.

---

  - 3 The current zone is displayed and indicated by a ✓.

---

  - 4  or  to the required zone and proceed to Step 7.
- OR**
- Key in the first character of the required zone.
- 
- 5 A blinking cursor appears.  
Use the keypad to type the required zone.  
Press  to move one space to the left.  
Press  to move one space to the right.  
Press  to delete any unwanted characters.

---

  - 6 The first line of the display shows the characters you keyed in. The next lines of the display show the shortlisted search

results.

The alias search is case-insensitive. If there are two or more zones with the same name, the radio displays the zone that is listed first in the zone list.

- 7 Press  to select.
- 8 The display shows <Zone> Selected momentarily and returns to the selected zone screen.

## ■ Selecting a Channel

Transmissions are sent and received on a channel. Depending on your radio's configuration, each channel may have been programmed differently to support different groups of users or supplied with different features. After selecting the required zone, select the channel you require to transmit or receive on.

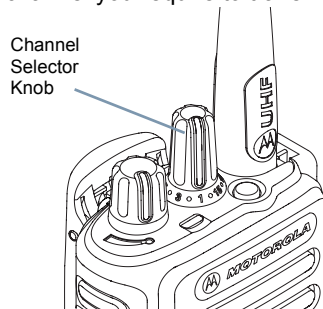

### Procedure:

Turn the Channel Selector Knob to select the channel with the active group alias or ID.

## ■ Receiving and Responding to a Radio Call

Once the channel, subscriber ID or group ID is displayed, you can proceed to receive and respond to calls.

*The LED lights up solid green while the radio is transmitting and blinks green when the radio is receiving.*

LED Indicator

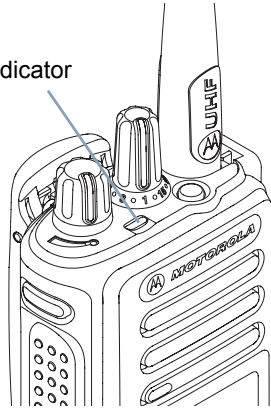

**NOTE:** The LED lights up solid green while the radio is transmitting and double blinks green when the radio is receiving a privacy-enabled call. To unscramble a privacy-enabled call, your radio must have the same Privacy Key, OR the same Key Value and Key ID (programmed by your dealer), as the transmitting radio (the radio you are receiving the call from).

See **Privacy** on page 73 for more information. 

## 📄 Receiving and Responding to a Group Call

To receive a call made to a group of users, your radio must be configured as part of that group.

### Procedure:

When you receive a Group Call (while on the Home screen):

- 1 The LED blinks green.



---

  - 2 The Group Call icon appears in the top right corner. The first text line shows the caller alias. The second text line displays the group call alias. Your radio unmutes and the incoming call sounds through the radio's speaker.

---

  - 3 To respond, hold the radio vertically 1 to 2 inches (2.5 to 5.0 cm) from your mouth.

---

  - 4  If the Channel Free Indication feature is enabled, you hear a short alert tone the moment the transmitting radio releases the **PTT** button, indicating the channel is free for you to respond. Press the **PTT** button to respond to the call.
- OR**
-  If the Voice Interrupt feature is enabled, press the **PTT** button to stop the current call from the transmitting radio and free the channel for you to talk/respond.

- 5 The LED lights up solid green.

---

- 6 Wait for the Talk Permit Tone to finish (if enabled) and speak clearly into the microphone.  
**OR**  
 Wait for the **PTT** Sidetone to finish (if enabled) and speak clearly into the microphone.

---

- 7 Release the **PTT** button to listen.

---

- 8 If there is no voice activity for a predetermined period of time, the call ends.

See **Making a Group Call** on page 26 for details on making a Group Call.

### **Receiving and Responding to a Private Call**

A Private Call is a call from an individual radio to another individual radio.

#### **Procedure:**

When you receive a Private Call:

- 1 The LED blinks green.

---

- 2 The Private Call icon appears in the top right corner. The first text line shows the caller alias. Your radio unmutes and the incoming call sounds through the radio's speaker.

---

- 3 To respond, hold the radio vertically 1 to 2 inches (2.5 to 5.0 cm) from your mouth.

- 4 If the Channel Free Indication feature is enabled, you hear a short alert tone the moment the transmitting radio releases the **PTT** button, indicating the channel is free for you to respond.  
Press the **PTT** button to respond to the call.  
**OR**  
If the Voice Interrupt feature is enabled, press the **PTT** button to stop the current call from the transmitting radio and free the channel for you to talk/respond.

---

- 5 The LED lights up solid green.

---

- 6 Wait for the Talk Permit Tone to finish (if enabled) and speak clearly into the microphone.

---

- 7 Release the **PTT** button to listen.

---

- 8 If there is no voice activity for a predetermined period of time, the call ends.

---

- 9 You hear a short tone. The display shows **Call Ended**.

See **Making a Private Call** on page 27 for details on making a Private Call.

### **Receiving an All Call**

An All Call is a call from an individual radio to every radio on the channel. It is used to make important announcements requiring the user's full attention.

**Procedure:**

When you receive an All Call:

- 1 A tone sounds and the LED blinks green.

---

- 2 The Group Call icon appears in the top right corner. The first text line shows the caller alias. The second text line displays All Call. Your radio unmutes and the incoming call sounds through the radio's speaker.

---

- 3 Once the All Call ends, the radio returns to the previous screen before receiving the call. An All Call does not wait for a predetermined period of time before ending.
  -  If the Channel Free Indication feature is enabled, you hear a short alert tone the moment the transmitting radio releases the **PTT** button, indicating the channel is now available for use.

*You cannot respond to an All Call.*

See **Making an All Call** on page 28 for details on making an All Call.

**NOTE:** The radio stops receiving the All Call if you switch to a different channel while receiving the call. During an All Call, you are **not** able to use any programmed button functions until the call ends.

### **Receiving and Responding to a Selective Call**

A Selective Call is a call from an individual radio to another individual radio. It is a Private Call on an analog system.

**Procedure:**

When you receive a Selective Call:

- 1 The LED blinks green.

---

- 2 The Private Call icon appears in the top right corner. The first text line shows the caller alias or Selective Call or Alert with Call. Your radio unmutes and the incoming call sounds through the radio's speaker.

---

- 3 To respond, hold the radio vertically 1 to 2 inches (2.5 to 5.0 cm) from your mouth.

---

- 4 If the Channel Free Indication feature is enabled, you hear a short alert tone the moment the transmitting radio releases the **PTT** button, indicating the channel is free for you to respond. Press the **PTT** button to respond to the call.

---

- 5 The LED lights up solid green.

---

- 6 Wait for the Talk Permit Tone to finish (if enabled) and speak clearly into the microphone.

---

- 7 Release the **PTT** button to listen.

---

- 8 If there is no voice activity for a predetermined period of time, the call ends.



---

- 9 You hear a short tone. The display shows Call Ended.

**NOTE:** See **Making a Selective Call** on page 28 for details on making a Private Call.

## ■ Making a Radio Call

After selecting your channel, you can select a subscriber alias or ID, or group alias or ID by using:

- The Channel Selector Knob
- A programmed **One Touch Access** button
- The programmed number keys – This method is for Group, Private and All Calls only and is used with the keypad (see **Making a Group, Private or All Call with the Programmable Number Key** on page 29). 
- The Contacts list (see **Contacts Settings** on page 43)
- Manual Dial (via Contacts) – This method is for Private Calls only and is dialed using the keypad (see **Making a Private Call from Contacts** on page 44). 

**NOTE:** Your radio must have the Privacy feature enabled on the channel to send a privacy-enabled transmission. Only target radios with the same Privacy Key OR the same Key Value and Key ID as your radio are able to unscramble the transmission.

See **Privacy** on page 73 for more information. 

The One Touch Access feature allows you to make a Group or Private Call to a predefined ID easily. This feature can be assigned to a short or long

programmable button press. You can **ONLY** have one ID assigned to a **One Touch Access** button. Your radio can have multiple **One Touch Access** buttons programmed.

### Making a Call with the Channel Selector Knob

### Making a Group Call

To make a call to a group of users, your radio must be configured as part of that group.

#### Procedure:

- 1 Select the channel with the active group alias or ID. See **Selecting a Channel** on page 22.

**OR**

Press the programmed **One Touch Access** button.

- 2 Hold the radio vertically 1 to 2 inches (2.5 to 5.0 cm) from your mouth.
- 3 Press the **PTT** button to make the call. The LED lights up solid green. The Group Call icon appears in the top right corner. The first text line shows the group call alias.
- 4 Wait for the Talk Permit Tone to finish (if enabled) and speak clearly into the microphone.

**OR**

 Wait for the **PTT** Sidetone to finish (if enabled) and speak clearly into the microphone.

- 5 Release the **PTT** button to listen. When the target radio responds, the LED blinks green. You see the Group Call icon, the group alias or ID, and transmitting radio alias or ID on your display.

---

- 6  If the Channel Free Indication feature is enabled, you hear a short alert tone the moment the target radio releases the **PTT** button, indicating the channel is free for you to respond. Press the **PTT** button to respond.  
**OR**  
If there is no voice activity for a predetermined period of time, the call ends.

---

- 7 Radio returns to the screen you were on prior to initiating the call.

---

You can also make a Group Call via Contacts (see **Making a Group Call from Contacts** on page 43).

### **Making a Private Call**

While you can receive and/or respond to a Private Call initiated by an authorized individual radio, your radio must be programmed for you to initiate a Private Call.

There are two types of Private Calls. The first type, where a radio presence check is performed prior to setting up the call, while the other sets up the call immediately.

Only **one** of these call types can be programmed to your radio by your dealer.

You hear a negative indicator tone, when you make a Private Call via the Contacts list, Call Log, **One Touch Access** button, the programmed number keys, or the Channel Selector Knob, if this feature is not enabled.

Use the Text Message or Call Alert features to contact an individual radio. See **Text Message Features** on page 60 or **Call Alert Operation** on page 52 for more information.

#### **Procedure:**

- 1 Select the channel with the active subscriber alias or ID. See **Selecting a Channel** on page 22.  
**OR**  
Press the programmed **One Touch Access** button.

---

- 2 Hold the radio vertically 1 to 2 inches (2.5 to 5.0 cm) from your mouth.

---

- 3 Press the **PTT** button to make the call. The LED lights up solid green. The Private Call icon appears in the top right corner. The first text line shows the subscriber alias. The second text line displays the call status.

---

- 4 Wait for the Talk Permit Tone to finish (if enabled) and speak clearly into the microphone.

---

- 5 Release the **PTT** button to listen. When the target radio responds, the LED blinks green.

---

- 6 If the Channel Free Indication feature is enabled, you hear a short alert tone the moment the target radio releases the **PTT** button, indicating the channel is free for you to respond.

Press the **PTT** button to respond.

**OR**

If there is no voice activity for a predetermined period of time, the call ends.

- 
- 7 You hear a short tone. The display shows **Call Ended**.
- 

You can also make a Private Call via Contacts (see **Making a Private Call from Contacts** on page 44) or perform a quick alphanumeric search for the required alias via a keypad entry (see **Making a Call by Alias Search** on page 45).

**NOTE:** If you release the **PTT** button while the radio is setting up the call, it exits without any indication and returns to the previous screen.

Your radio may be programmed to perform a radio presence check prior to setting up the Private Call. If the target radio is not available, you hear a short tone and see negative mini notice on the display.

The radio returns to the menu prior to initiating the radio presence check.

### **Making an All Call**

This feature allows you to transmit to all users on the channel. Your radio must be programmed to allow you to use this feature.

### **Procedure:**

- 1 Select the channel with the active All Call group alias or ID. See **Selecting a Channel** on page 22.

---

- 2 Hold the radio vertically 1 to 2 inches (2.5 to 5.0 cm) from your mouth.

---

- 3 Press the **PTT** button to make the call. The LED lights up solid green. The Group Call icon appears in the top right corner. The first text line shows **All Call**.

---

- 4 Wait for the Talk Permit Tone to finish (if enabled) and speak clearly into the microphone.

**OR**

-  Wait for the **PTT** Sidetone to finish (if enabled) and speak clearly into the microphone.
- 

*Users on the channel cannot respond to an All Call.*

### **Making a Selective Call**

Just like a Private Call, while you can receive and/or respond to a Selective Call initiated by an authorized individual radio, your radio must be programmed for you to initiate a Selective Call.

### **Procedure:**

- 1 Select the channel with the active subscriber alias or ID. See **Selecting a Channel** on page 22.

---



- 2 Hold the radio vertically 1 to 2 inches (2.5 to 5.0 cm) from your mouth.

---

- 3 Press the **PTT** button to make the call. The LED lights up solid green. The Private Call icon appears in the top right corner. The first text line shows the subscriber alias. The second text line displays the call status.

---

- 4 Wait for the Talk Permit Tone to finish (if enabled) and speak clearly into the microphone.  
**OR**  
Wait for the **PTT** Sidetone to finish (if enabled) and speak clearly into the microphone.

---

- 5 Release the **PTT** button to listen. When the target radio responds, the LED blinks green.

---

- 6 If the Channel Free Indication feature is enabled, you hear a short alert tone the moment the target radio releases the **PTT** button, indicating the channel is free for you to respond. Press the **PTT** button to respond.  
**OR**  
If there is no voice activity for a predetermined period of time, the call ends.

---

- 7 You hear a short tone. The display shows `Call Ended`.

---

## Making a Group, Private or All Call with the Programmable Number Key

The Programmable Number Key feature allows you to make a Group, Private or All Call to a predefined alias or ID easily. This feature can be assigned to all the available number keys on a keypad.

You can **ONLY** have one alias or ID assigned to a number key, but you can have more than one number key associated to an alias or ID.

### Procedure:

When you are on the Home screen:

- 1 Long press the programmed number key to make a Group, Private or All Call to the predefined alias or ID.  
If the number key is not associated to an entry, a negative indicator tone sounds.

---

- 2 Hold the radio vertically 1 to 2 inches (2.5 to 5.0 cm) from your mouth.

---

- 3 Press the **PTT** button to make the call. The LED lights up solid green. The Group/Private Call icon appears in the top right corner. The first text line shows the caller alias. The second text line displays either the call status for a Private Call or `All Call` for All Call.

---

- 4 Wait for the Talk Permit Tone to finish (if enabled) and speak clearly into the microphone.

**OR**

 **For Group Call only:** Wait for the **PTT** Sidetone to finish (if enabled) and speak clearly into the microphone.

- 5 Release the **PTT** button to listen. When the target radio responds, the LED blinks green.
- 6 If the Channel Free Indication feature is enabled, you hear a short alert tone the moment the target radio releases the **PTT** button, indicating the channel is free for you to respond. Press the **PTT** button to respond.

**OR**

If there is no voice activity for a predetermined period of time, the call ends.

- 7 Radio returns to the screen you were on prior to initiating the call.

*For a Private Call, you hear a short tone when the call ends.*

See **Assigning an Entry to a Programmable Number Key** on page 46 for details on assigning an entry to a number key on the keypad.

## ■ Stopping a Radio Call

This feature allows you to stop an ongoing Group or Private Call to free the channel for transmission. For example, when a radio experiences a “stuck microphone” condition where the **PTT** button is inadvertently pressed by the user.

Your radio must be programmed to allow you to use this feature.

### Procedure:

While on the required channel:

- 1 Press the programmed **Transmit Interrupt Remote Dekey** button.
- 2 The display shows `Remote Dekey`.
- 3 Wait for acknowledgment.
- 4 The radio sounds a positive indicator tone and the display shows `Remote Dekey Success`, indicating that the channel is now free.
 

**OR**

 The radio sounds a negative indicator tone and the display shows `Remote Dekey Failed`.

*On the interrupted radio, the display shows `Call Interrupted` and your radio sounds a negative indicator tone until you release the **PTT** button, if it is transmitting an interruptible call that is stopped via this feature.*

## ■ Talkaround

---

You can continue to communicate when your repeater is not operating, or when your radio is out of the repeater's range but within talking range of other radios.

This is called "talkaround".

**NOTE:** This feature is not applicable in Capacity Plus and Linked Capacity Plus.

### Procedure:



Press the programmed **Repeater/Talkaround** button to toggle between talkaround and repeater modes.

### OR



Follow the procedure below.

- 1  to access the menu.



---

- 2  or  to Utilities and press  to select.

---

- 3  or  to Radio Settings and press  to select.

---

- 4  or  to Talkaround.

---



- 5 Press  to enable Talkaround. The display shows ✓ beside Enabled.

### OR

Press  to disable Talkaround. The ✓ disappears from beside Enabled.

- 6 The screen automatically returns to the previous menu.

*The Talkaround setting is retained even after powering down.*

**NOTE:** At Step 4, you can also use  or  to change the selected option.

## ■ Monitoring Features

---

### Monitoring a Channel

Use the Monitor feature to make sure a channel is clear before transmitting.

**NOTE:** This feature is not applicable in Capacity Plus and Linked Capacity Plus.

#### **Procedure:**

- 1 Press and hold the programmed **Monitor** button and listen for activity.
- 2 The monitor icon appears on the status bar and the LED lights up solid yellow.
- 3 You hear radio activity or total silence, depending on how your radio is programmed.
- 4 When you hear “white noise” (that is, the channel is free), press the **PTT** button to talk and release it to listen.

### Permanent Monitor

Use the Permanent Monitor feature to continuously monitor a selected channel for activity.

**NOTE:** This feature is not applicable in Capacity Plus and Linked Capacity Plus.

#### **Procedure:**

- 1 Press the programmed **Permanent Monitor** button.
- 2 Radio sounds an alert tone, the LED lights up solid yellow, and the display shows `Permanent Monitor On`. The monitor icon appears on the status bar.
- 3 Press the programmed **Permanent Monitor** button to exit Permanent Monitor mode.
- 4 Radio sounds an alert tone, the LED turns off, and display shows `Permanent Monitor Off`.

## Advanced Features

Use this navigation guide to learn more about advanced features available with your radio:

- Radio Check . . . . . page 34
- Remote Monitor . . . . . page 35
- Scan Lists . . . . . page 37
- Scan . . . . . page 40
- Vote Scan . . . . . page 42
- Contacts Settings . . . . . page 43
- Call Indicator Settings . . . . . page 47
- Call Log Features . . . . . page 51
- Call Alert Operation . . . . . page 52
- Emergency Operation . . . . . page 54
- Text Message Features . . . . . page 60
- Analog Message Encode. . . . . page 71
- Analog Status Update . . . . . page 72
- Privacy. . . . . page 73
- Dual Tone Multi Frequency (DTMF) . . . . . page 75
- Multi-Site Controls . . . . . page 75
- Security . . . . . page 77
- Lone Worker . . . . . page 79
- Password Lock Features. . . . . page 80
- Notification List . . . . . page 82
- Utilities. . . . . page 83

## ■ Radio Check

If enabled, this feature allows you to determine if another radio is active in a system without disturbing the user of that radio. No audible or visual notification is shown on the target radio.

This feature is only applicable for subscriber aliases or IDs.

### Sending a Radio Check

#### Procedure:

Use the programmed **Radio Check** button.

- 1 Press the programmed **Radio Check** button.

---

- 2 ▲ or ▼ to the required subscriber alias or ID and press  to select.

---

- 3 The display shows transitional mini notice, indicating the request is in progress. The LED lights up solid green.

---

- 4 Wait for acknowledgement.

---

- 5 If successful, a positive indicator tone sounds and the display shows positive mini notice.

#### OR

If unsuccessful, a negative indicator tone sounds and the display shows negative mini notice.

- 6 Radio returns to the subscriber alias or ID screen.

---

#### OR

#### Procedure:







Use the menu.

- 1  to access the menu.

---

  - 2 ▲ or ▼ to **Contacts** and press  to select.

---

  - 3 ▲ or ▼ to the required subscriber alias or ID and press  to select.
- OR**
- ▲ or ▼ to **Manual Dial** and press  to select.
- If there was previously dialed ID, the ID appears along with a blinking cursor. Use the keypad to edit the ID. Press  to select.
- OR**
- ▲ or ▼ to **Manual Dial** and press  to select.
- Key in the subscriber alias or ID and press .
- 
- 4 ▲ or ▼ to **Radio Check** and press  to select.

---

- 5 The display shows transitional mini notice, indicating the request is in progress. The LED lights up solid green.
- 6 Wait for acknowledgement.
- 7 If successful, a positive indicator tone sounds and the display shows positive mini notice.  
**OR**  
If unsuccessful, a negative indicator tone sounds and the display shows negative mini notice.
- 8 Radio returns to the subscriber alias or ID screen.

If the  button is pressed when the radio is waiting for acknowledgement, a tone sounds, and the radio terminates all retries and exits Radio Check mode.

## ■ Remote Monitor



Use the Remote Monitor feature to turn on the microphone of a target radio (subscriber alias or IDs only). No audible or visual indication is given to the target radio. You can use this feature to monitor, remotely, any audible activity surrounding the target radio.

Your radio must be programmed to allow you to use this feature.

### Initiating Remote Monitor

#### **Procedure:**

Use the programmed **Remote Monitor** button.

- 1 Press the programmed **Remote Monitor** button.
- 2  or  to the required subscriber alias or ID and press  to select.
- 3 The display shows transitional mini notice, indicating the request is in progress. The LED lights up solid green.
- 4 Wait for acknowledgement.
- 5 If successful, a positive indicator tone sounds and the display shows positive mini notice. Your radio starts playing audio from the monitored radio for a programmed duration and display shows *Rem. Monitor*.  
Once the timer expires, the radio sounds an alert tone and the LED turns off.  
**OR**

If unsuccessful, a negative indicator tone sounds and the display shows negative mini notice.

---

**OR**

**Procedure:**

Use the menu.

1  to access the menu.

---

2 ▲ or ▼ to **Contacts** and press  to select.

---

3 ▲ or ▼ to the required subscriber alias or ID and press  to select.

**OR**

▲ or ▼ to **Manual Dial** and press  to select.

If there was previously dialed ID, the ID appears along with a blinking cursor. Use the keypad to edit the ID. Press  to select.

**OR**

▲ or ▼ to **Manual Dial** and press  to select.

Key in the subscriber alias or ID and press  to select.

---

4 ▲ or ▼ to **Remote Mon.** and press  to select.

---

5 The display shows transitional mini notice, indicating the request is in progress. The LED lights up solid green.

---

6 Wait for acknowledgment.

---

7 If successful, a positive indicator tone sounds and the display shows positive mini notice. Your radio starts playing audio from the monitored radio for a programmed duration and display shows **Rem. Monitor**.

Once the timer expires, the radio sounds an alert tone and the LED turns off.

**OR**

If unsuccessful, the radio sounds a negative indicator tone the display shows negative mini notice.

---

### **Stopping Remote Monitor**

Remote Monitor automatically stops after a programmed duration or when there is any user operation on the target radio.

**Procedure:**

1 Press the programmed **Transmit Interrupt Remote Dekey** button.

---

2 The display shows transitional mini notice, indicating the request is in progress. The LED lights up solid green.

---

3 Wait for acknowledgment.

---

4 If successful, a positive indicator tone sounds and the display shows positive mini notice.

**OR**

If unsuccessful, a negative indicator tone sounds and the display shows negative mini notice.

---



## ■ Scan Lists

Scan lists are created and assigned to individual channels/groups. Your radio scans for voice activity by cycling through the channel/group sequence specified in the scan list for the current channel/group.

Your radio can support up to 250 scan lists, with a maximum of 16 members in a list. Each scan list supports a mixture of both analog and digital entries.

You can add, delete, or prioritize channels by editing a scan list.

You can attach a new scan list to your radio via Front Panel Programming.

**NOTE:** This feature is not applicable in Capacity Plus and Linked Capacity Plus.

### Viewing an Entry in the Scan List

#### Procedure:

- 1  to access the menu.

---

- 2 ▲ or ▼ to Scan and press  to select.

---

- 3 ▲ or ▼ to Scan List and press  to select.

---

- 4 Use ▲ or ▼ to view each member on the list.

The priority icon appears left of the member's alias, if set, to indicate whether the member is on a Priority 1 or Priority 2 channel list. You **cannot** have multiple Priority 1 or Priority 2 channels in a scan list.

There is no priority icon if priority is set to **None**.

### Viewing an Entry in the Scan List by Alias Search

#### Procedure:

- 1  to access the menu.

---

- 2 ▲ or ▼ to Scan and press  to select.

---

- 3 ▲ or ▼ to Scan List and press  to select.

---

- 4 Key in the first character of the required alias.

---

- 5 A blinking cursor appears.  
Use the keypad to type the required alias.  
Press ◀ to move one space to the left.  
Press ▶ to move one space to the right.  
Press  to delete any unwanted characters.

---

- 6 The first line of the display shows the characters you keyed in. The next lines of the display show the shortlisted search results.

The alias search is case-insensitive. If there are two or more entries with the same name, the radio displays the entry that is listed first in the scan list.

## Editing the Scan List

### Adding a New Entry to the Scan List

#### Procedure:

- 1  to access the menu.

---

- 2 ▲ or ▼ to Scan and press  to select.

---

- 3 ▲ or ▼ to Scan List and press  to select.

---

- 4 ▲ or ▼ to Add Member and press  to select.

---

- 5 ▲ or ▼ to the required alias or ID and proceed to Step 8.  
**OR**  
Key in the first character of the required alias.

---

- 6 A blinking cursor appears.  
Use the keypad to type the required alias.  
Press ◀ to move one space to the left.  
Press ▶ to move one space to the right.  
Press  to delete any unwanted characters.

---

- 7 The first line of the display shows the characters you keyed in. The next lines of the display show the shortlisted search results.  
The alias search is case-insensitive. If there are two or more aliases with the same name, the radio displays the alias that is listed first in the list.

---

- 8 Press  to select.



---

- 9 ▲ or ▼ to the required priority level and press  to select.

---

- 10 The display shows positive mini notice, followed immediately by Add Another?.

---

- 11 ▲ or ▼ to Yes and press  to select, to add another entry, and repeat Steps 5 to 9.  
**OR**  
▲ or ▼ to No and press  to select to save the current list.

---

### Deleting an Entry from the Scan List

#### Procedure:

- 1  to access the menu.

---

- 2 ▲ or ▼ to Scan and press  to select.

---

- 3 ▲ or ▼ to Scan List and press  to select.

---

- 4 ▲ or ▼ to the required alias or ID and proceed to Step 7.  
**OR**  
Key in the first character of the required alias.

---

- 5 A blinking cursor appears.  
Use the keypad to type the required alias.  
Press ◀ to move one space to the left.

---

Press **▶** to move one space to the right.  
 Press **⌫** to delete any unwanted characters.



- 6 The first line of the display shows the characters you keyed in. The next lines of the display show the shortlisted search results.  
 The alias search is case-insensitive. If there are two or more entries with the same name, the radio displays the entry that is listed first in the scan list.
- 7 Press **OK** to select.
- 8 **▲** or **▼** to **Delete** and press **OK** to select.
- 9 At **Delete Entry?**, **▲** or **▼** to **Yes** and press **OK** to select, to delete the entry. The display shows positive mini notice.  
**OR**  
**▲** or **▼** to **No** and press **OK** to select to return to the previous screen.
- 10 Repeat Steps 4 to 9 to delete other entries.

*After deleting all required aliases or IDs, long press **Home** to return to the Home screen.*

## **Setting and Editing Priority for an Entry in the Scan List**

### **Procedure:**

- 1 Press **OK** to access the menu.
- 2 **▲** or **▼** to **Scan** and press **OK** to select.
- 3 **▲** or **▼** to **Scan List** and press **OK** to select.
- 4 **▲** or **▼** to the required alias or ID and proceed to Step 7.  
**OR**  
 Key in the first character of the required alias.
- 5 A blinking cursor appears.  
 Use the keypad to type the required alias.  
 Press **◀** to move one space to the left.  
 Press **▶** to move one space to the right.  
 Press **⌫** to delete any unwanted characters.
- 6 The first line of the display shows the characters you keyed in. The next lines of the display show the shortlisted search results.  
 The alias search is case-insensitive. If there are two or more entries with the same name, the radio displays the entry that is listed first in the scan list.
- 7 Press **OK** to select.

- 8 ▲ or ▼ to Edit Priority and press  to select.
- 9 ▲ or ▼ to the required priority level and press  to select.
- 10 The display shows positive mini notice before returning to the previous screen.
- 11 The priority icon appears left of the member's name.

*There is no priority icon if priority is set to **None**.*

## ■ Scan

When you start a scan, your radio cycles through the programmed scan list for the current channel looking for voice activity.

The LED blinks yellow and the scan icon appears on the status bar.

During a dual mode scan, if you are on a digital channel, and your radio locks onto an analog channel, it automatically switches from digital mode to analog mode for the duration of the call. This is also true for the reverse.

There are two ways of initiating scan:

- **Main Channel Scan (Manual):** Your radio scans all the channels/groups in your scan list. On entering scan, your radio may – depending on the settings – automatically start on the last scanned “active” channel/group or on the channel where scan was initiated.
- **Auto Scan (Automatic):** Your radio automatically starts scanning when you select a channel/group that has Auto Scan enabled.

**NOTE:** This feature is not applicable in Capacity Plus and Linked Capacity Plus.

## Starting and Stopping Scan

### Procedure:

Press the programmed **Scan** button to start or stop Scan.

### OR



Follow the procedure below.

- 1 Use the Channel Selector Knob to select a channel programmed with a scan list.



---

  - 2  to access the menu.



---

  - 3  or  to **Scan** and press  to select.

---

  - 4  or  to **Scan State** and press  to select.

---

  - 5  or  to required scan state and press  to select.

---

  - 6 The display shows **Scan On** when scan is enabled. The LED blinks yellow and the scan icon appears.
- OR**
- The display shows **Scan Off** if scan is disabled. The LED turns off and the scan icon disappears.

*While scanning, the radio can only accept data (e.g. text message, location, telemetry, or PC data) if received on its Selected Channel.*

## Responding to a Transmission During a Scan

During scanning, your radio stops on a channel/group where activity is detected. The radio stays on that channel for a programmed time period known as “hang time”.

### Procedure:

- 1 Hold the radio vertically 1 to 2 inches (2.5 to 5.0 cm) from your mouth.
    -  If the Channel Free Indication feature is enabled, you hear a short alert tone the moment the transmitting radio releases the **PTT** button, indicating the channel is free for you to respond.

---

  - 2 Press the **PTT** button during hang time. The LED lights up solid green.

---

  - 3 Wait for the Talk Permit Tone to finish (if enabled) and speak clearly into the microphone.
- OR**
-  Wait for the **PTT** Sidetone to finish (if enabled) and speak clearly into the microphone.

---

  - 4 Release the **PTT** button to listen.

---

  - 5 If you do not respond within the hang time, the radio returns to scanning other channels/groups.

## Deleting a Nuisance Channel

If a channel continually generates unwanted calls or noise (termed a “nuisance” channel), you can temporarily remove the unwanted channel from the scan list.

This capability does not apply to the channel designated as the Selected Channel.

### Procedure:

- 1 When your radio “locks on to” an unwanted or nuisance channel, press the programmed **Nuisance Channel Delete** button until you hear a tone.
- 2 Release the **Nuisance Channel Delete** button. The nuisance channel is deleted.

*Deleting a “nuisance” channel is **only** possible through the programmed **Nuisance Channel Delete** button. This feature is **not** accessible through the menu.*

## Restoring a Nuisance Channel

### Procedure:

To restore the deleted nuisance channel, do **one** of the following:

- Turn the radio off and then power it on again, **OR**
- Stop and restart a scan via the programmed **Scan** button or menu, **OR**
- Change the channel via the Channel Selector Knob.

## Vote Scan

Vote Scan provides you with wide area coverage in areas where there are multiple base stations transmitting identical information on different analog channels.

Your radio scans analog channels of multiple base stations and performs a voting process to select the strongest received signal. Once that is established, your radio unmutes to transmissions from that base station.

The LED blinks yellow and the vote scan icon appears on the status bar.

*To respond to a transmission during a Vote Scan, follow the same procedures as Responding to a Transmission During a Scan on page 41.*

## ■ Contacts Settings

Contacts provides “address-book” capabilities on your radio. Each entry corresponds to an alias or ID that you use to initiate a call.

Each entry, depending on context, associates with **one** of five types of calls: Group Call, Private Call, All Call, PC Call or Dispatch Call.

PC Call and Dispatch Call are data-related. They are only available with the applications. Refer to the data applications documentation for more information.

**NOTE:** If the Privacy feature is enabled on a channel, you can make privacy-enabled Group Call, Private Call, and All Call on that channel. Only target radios with the same Privacy Key OR the same Key Value and Key ID as your radio are able to unscramble the transmission.

See **Privacy** on page 73 for more information. 

Additionally, Contacts menu allows you to assign each entry to a programmable number key or more on a keypad. If an entry is assigned to a number key, your radio can perform a quick dial on the entry. 

Your radio supports two Contacts lists, one for Analog contacts and one for Digital contacts, with a maximum of 500 members for each Contacts list.

Each entry within Contacts displays the following information:







- Call Type
- Call Alias
- Call ID

**NOTE:** You can add, or edit subscriber IDs for the Digital Contacts list. Deleting subscriber IDs can only be performed by your dealer.

For the Analog Contacts list, you can only view the subscriber IDs, edit the subscriber IDs, and initiate a Call Alert. Adding and deleting capabilities can only be performed by your dealer.

### Making a Group Call from Contacts

#### Procedure:

- 1  to access the menu.
- 2  or  to **Contacts** and press  to select. The entries are alphabetically sorted.
- 3  or  to the required group alias or ID.
- 4 Hold the radio vertically 1 to 2 inches (2.5 to 5.0 cm) from your mouth.
- 5 Press the **PTT** button to make the call. The LED lights up solid green.
- 6 Wait for the Talk Permit Tone to finish (if enabled) and speak clearly into the microphone.

**OR**

 Wait for the **PTT** Sidetone to finish (if enabled) and speak clearly into the microphone.

---

7 Release the **PTT** button to listen. When any user in the group responds, the LED blinks green. You see the Group Call icon, the group ID, and that user's ID on your display.

---

8  If the Channel Free Indication feature is enabled, you hear a short alert tone the moment the target radio releases the **PTT** button, indicating the channel is free for you to respond. Press the **PTT** button to respond.

**OR**

If there is no voice activity for a programmed period of time, the call ends.



---

## Making a Private Call from Contacts

**Procedure:**

1  to access the menu.



---

2  or  to **Contacts** and press  to select. The entries are alphabetically sorted.

---

3  or  to the required subscriber alias or ID.

**OR**



 or  to **Manual Dial** and press  to select.

If there was previously dialed subscriber alias or ID, the alias or ID appears along with a blinking cursor.

Use the keypad to edit the ID.

---

**OR**

 or  to **Manual Dial** and press  to select.

Use the keypad to enter a new subscriber alias or ID.

---

4 Hold the radio vertically 1 to 2 inches (2.5 to 5.0 cm) from your mouth.

---

5 Press the **PTT** button to make the call. The LED lights up solid green. The display shows the destination alias.

---

6 Wait for the Talk Permit Tone to finish (if enabled) and speak clearly into the microphone.

---

7 Release the **PTT** button to listen. When the target radio responds, the LED blinks green and the display shows the transmitting user's ID.

---

8 If the Channel Free Indication feature is enabled, you hear a short alert tone the moment the target radio releases the **PTT** button, indicating the channel is free for you to respond. Press the **PTT** button to respond.

**OR**

If there is no voice activity for a programmed period of time, the call ends.

---

9 You hear a short tone. The display shows **Call Ended**.

---



## Making a Call by Alias Search



You can also use alias or alphanumeric search to retrieve the required subscriber alias.

This feature is only applicable while in Contacts.

### Procedure:

- 1  to access the menu.



---

- 2  or  to **Contacts** and press  to select. The entries are alphabetically sorted.

---

- 3 Key in the first character of the required alias.

---

- 4 A blinking cursor appears.  
Use the keypad to type the required alias.  
Press  to move one space to the left.  
Press  to move one space to the right.  
Press  to delete any unwanted characters.

---

- 5 The first line of the display shows the characters you keyed in. The next lines of the display show the shortlisted search results.  
The alias search is case-insensitive. If there are two or more aliases with the same name, the radio displays the alias that is listed first in the Contacts list.

---

- 6 Hold the radio vertically 1 to 2 inches (2.5 to 5.0 cm) from your mouth.

---

- 7 Press the **PTT** button to make the call. The LED lights up solid green. The display shows the destination alias.

---

- 8 Wait for the Talk Permit Tone to finish (if enabled) and speak clearly into the microphone.

---

- 9 Release the **PTT** button to listen. When the target radio responds, the LED blinks green.



---

- 10 If the Channel Free Indication feature is enabled, you hear a short alert tone the moment the target radio releases the **PTT** button, indicating the channel is free for you to respond. Press the **PTT** button to respond.  
**OR**  
If there is no voice activity for a programmed period of time, the call ends.

---

- 11 You hear a short tone. The display shows **Call Ended**.

---

**NOTE:** Press  button or  to exit alias search.

If you release the **PTT** button while the radio is setting up the call, it exits without any indication and returns to the previous screen.

Your radio may be programmed to perform a radio presence check prior to setting up the Private Call. If the target radio is not available, you hear a short tone and see negative mini notice on the display. The radio returns to the menu prior to initiating the radio presence check.

## Assigning an Entry to a Programmable Number Key

### Procedure:

- 1  to access the menu.

---

- 2 ▲ or ▼ to **Contacts** and press  to select. The entries are alphabetically sorted.

---

- 3 ▲ or ▼ to the required alias or ID and press  to select.

---

- 4 ▲ or ▼ to **Program Key** and press  to select.

---

- 5 ▲ or ▼ to the desired number key and press  to select.

### OR

If the number key is currently assigned to another entry, the display shows **The Key is Already Used** and then, the first line of the display shows **Overwrite?**.

▲ or ▼ to **Yes** and press  to select.

- 6 The radio sounds a positive indicator tone and the display shows positive mini notice.

---

- 7 The screen automatically returns to the previous menu.

**NOTE:** Each entry can be associated to different number keys. You see a checkmark before each number key that is assigned to an entry. If the checkmark is before **Empty**, you have not assign a number key to the entry. If a number key is assigned to an entry in a particular

mode, this feature is not supported when you long press the number key in another mode.

See **Making a Group, Private or All Call with the Programmable Number Key** on page 29 for details on making a *Group, Private or All Call with the programmed number key(s)*.

## Removing the Association between Entry and Programmable Number Key

### Procedure:

Long press the programmed number key to the required alias or ID, press  to select, and proceed to Step 4.

### OR

Follow the procedure below.

- 1  to access the menu.

---

- 2 ▲ or ▼ to **Contacts** and press  to select. The entries are alphabetically sorted.

---

- 3 ▲ or ▼ to the required alias or ID and press  to select.

---

- 4 ▲ or ▼ to **Program Key** and press  to select.

---

- 5 ▲ or ▼ to **Empty** and press  to select.

---

- 6 The first line of the display shows **Clear from all keys?**.





- 7 ▲ or ▼ to Yes and press  to select.
- 8 The radio sounds a positive indicator tone and the display shows positive mini notice.
- 9 The screen automatically returns to the previous menu.

**NOTE:** When an entry is deleted, the association between the entry and its programmed number key(s) is removed.

### **Setting Default Contact**

#### **Procedure:**

Follow the procedure below.







- 1  to access the menu.
- 2 ▲ or ▼ to Contacts and press  to select.
- 3 ▲ or ▼ to the required alias or ID and press  to select.
- 4 ▲ or ▼ to Set as Default and press  to select.
- 5 The radio sounds a positive indicator tone and the display shows positive mini notice.
- 6 A ✓ appears beside the selected default alias or ID.

## ■ **Call Indicator Settings**

### **Activating or Deactivating Call Ringers for Call Alert**

You can select, or turn on or off ringing tones for a received Call Alert.

#### **Procedure:**

- 1  to access the menu.
- 2 ▲ or ▼ to Utilities and press  to select.
- 3 ▲ or ▼ to Radio Settings and press  to select.
- 4 ▲ or ▼ to Tones/Alerts and press  to select.
- 5 ▲ or ▼ to Call Ringers and press  to select.
- 6 ▲ or ▼ to Call Alert and press  to select. The current tone is indicated by a ✓.
- 7 ▲ or ▼ to the required tone and press  to select. ✓ appears beside selected tone.

**NOTE:** At Step 6, you can also use ◀ or ▶ to change the selected option.



## Activating or Deactivating Call Ringers for Private Calls

You can turn on or off the ringing tones for a received Private Call.



### Procedure:

- 1  to access the menu.



---

- 2  or  to Utilities and press  to select.



---

- 3  or  to Radio Settings and press  to select.



---

- 4  or  to Tones/Alerts and press  to select.



---



- 5  or  to Call Ringers and press  to select.

---

- 6  or  to Private Call.

---

- 7 Press  to enable Private Call ringing tones. The display shows ✓ beside Enabled.  
**OR**  
 Press  to disable Private Call ringing tones. The ✓ disappears from beside Enabled.

**NOTE:** At Step 6, you can also use  or  to change the selected option.



## Activating or Deactivating Call Ringers for Selective Call

You can select, or turn on or off ringing tones for a received Selective Call.



### Procedure:

- 1  to access the menu.



---

- 2  or  to Utilities and press  to select.



---

- 3  or  to Radio Settings and press  to select.



---

- 4  or  to Tones/Alerts and press  to select.



---



- 5  or  to Call Ringers and press  to select.

---

- 6  or  to Selective Call and press  to select. The current tone is indicated by a ✓.

---

- 7  or  to the required tone and press  to select. ✓ appears beside selected tone.

**NOTE:** At Step 6, you can also use  or  to change the selected option.

## Activating or Deactivating Call Ringers for Text Message

You can select, or turn on or off the ringing tones for a received Text Message.

### Procedure:

- 1  to access the menu.

---

- 2 ▲ or ▼ to Utilities and press  to select.

---

- 3 ▲ or ▼ to Radio Settings and press  to select.

---

- 4 ▲ or ▼ to Tones/Alerts and press  to select.

---

- 5 ▲ or ▼ to Call Ringers and press  to select.

---

- 6 ▲ or ▼ to Messages and press  to select. The current tone is indicated by a ✓.

---

- 7 ▲ or ▼ to the required tone and press  to select. ✓ appears beside selected tone.

---

**NOTE:** At Step 6, you can also use ◀ or ▶ to change the selected option.

## Activating or Deactivating Call Ringers for Telemetry Status with Text

You can turn on or off the alert tones for a received Telemetry Status with Text.

### Procedure:

- 1  to access the menu.

---

- 2 ▲ or ▼ to Utilities and press  to select.

---

- 3 ▲ or ▼ to Radio Settings and press  to select.

---

- 4 ▲ or ▼ to Tones/Alerts and press  to select.

---

- 5 ▲ or ▼ to Call Ringers and press  to select.

---

- 6 ▲ or ▼ to Telemetry and press  to select. The current tone is indicated by a ✓.

---

- 7 ▲ or ▼ to the required tone and press  to select. ✓ appears beside selected tone.

---

**NOTE:** At Step 6, you can also use ◀ or ▶ to change the selected option.

## Assigning Ring Styles

You can program your radio to sound one of ten predefined ringing tones when receiving a Call Alert or a Text Message from a particular contact.

### Procedure:

- 1  to access the menu.

---

- 2 ▲ or ▼ to **Contacts** and press  to select. The entries are alphabetically sorted.

---

- 3 ▲ or ▼ to the required alias or ID and press  to select.

---

- 4 ▲ or ▼ to **Edit** and press  to select.

---

- 5 Press  until display shows **Edit Ringtone** menu.

---

- 6 A ✓ indicates the current selected tone.

---

- 7 ▲ or ▼ to the required tone and press  to select. ✓ appears beside selected tone.

---

- 8 The display shows a positive mini notice.

*The radio sounds out each ring style as you navigate through the list.*

## Escalating Alarm Tone Volume

You can program your radio to continually alert you when a radio call remains unanswered. This is done by automatically increasing the alarm tone volume over time. This feature is known as Escalert.

### Procedure:

- 1  to access the menu.

---

- 2 ▲ or ▼ to **Utilities** and press  to select.

---

- 3 ▲ or ▼ to **Radio Settings** and press  to select.



---

- 4 ▲ or ▼ to **Tones/Alerts** and press  to select.

---

- 5 ▲ or ▼ to **Escalert**.

---

- 6 Press  to enable Escalert. The display shows ✓ beside **Enabled**.  
**OR**  
Press  to disable Escalert. The ✓ disappears from beside **Enabled**.

**NOTE:** At Step 5, you can also use ◀ or ▶ to change the selected option.

## ■ Call Log Features

Your radio keeps track of all recent outgoing, answered, and missed Private Calls. Use the call log feature to view and manage recent calls.



You can perform the following tasks in each of your call lists:

- Store ID to Contacts
- Delete
- View Details

### Viewing Recent Calls

The lists are Missed, Answered, and Outgoing.







#### Procedure:

- 1  to access the menu.
- 2 ▲ or ▼ to Call Log and press  to select.
- 3 ▲ or ▼ to required list and press  to select.
- 4 The display shows the most recent entry at the top of the list.
- 5 ▲ or ▼ to view the list.

Press the **PTT** button to start a Private Call with the current selected alias or ID.

### Storing an Alias or ID from a Call List





#### Procedure:

- 1  to access the menu.
- 2 ▲ or ▼ to Call Log and press  to select.
- 3 ▲ or ▼ to the required list and press  to select.
- 4 ▲ or ▼ to the required alias or ID and press  to select.
- 5 ▲ or ▼ to Store and press  to select.
- 6 A blinking cursor appears. If needed, key in the alias for that ID and press .
- 7 The display shows positive mini notice.

You can also store an ID without an alias.

### Deleting a Call from a Call List

#### Procedure:

- 1  to access the menu.
- 2 ▲ or ▼ to Call Log and press  to select.
- 3 ▲ or ▼ to the required list and press  to select.
- 4 ▲ or ▼ to the required alias or ID and press  to select.

- 5 ▲ or ▼ to Delete and press  to select.

---

- 6 Press  to select Yes to delete the entry. The display shows positive mini notice.  
**OR**  
 ▲ or ▼ to No to return to the previous screen.

---

When you select a call list and it contains no entries, the display shows *List Empty*, and sounds a low tone if Keypad Tones are turned on (see **Turning Keypad Tones On or Off** on page 84).

### Viewing Details from a Call List

#### Procedure:

- 1  to access the menu.

---

- 2 ▲ or ▼ to Call Log and press  to select.

---

- 3 ▲ or ▼ to the required list and press  to select.

---

- 4 ▲ or ▼ to the required alias or ID and press  to select.

---

- 5 ▲ or ▼ to View Details and press  to select. Display shows details.

---

## ■ Call Alert Operation

---

Call Alert paging enables you to alert a specific radio user to call you back when they are able to do so.

This feature is applicable for subscriber aliases or IDs only and is accessible through the menu via Contacts or manual dial.

### Receiving and Responding to a Call Alert

When you receive a Call Alert page, you see the notification list listing a Call Alert with the alias or ID of the calling radio on the display.

#### Procedure:

- 1 You hear a repetitive tone. The LED blinks yellow.

---

- 2 Press the **PTT** button while the display still shows the Call Alert in the Notification List to respond with a Private Call.  
**OR**  
 Press  to exit the Notification List. The alert is moved to the Missed Call Log.

---

See **Notification List** on page 82 for details about the Notification List.

See **Call Log Features** on page 51 for details about the Missed Call List.





## ☞ Making a Call Alert from the Contacts List







### Procedure:

- 1  to access the menu.



---

- 2  or  to `Contacts` and press  to select.

---

- 3  or  to the required subscriber alias or ID and press  to select.  
**OR**  
 or  to `Manual Dial` and press  to select. A blinking cursor appears. Enter the subscriber ID you want to page and press .

---

- 4  or  to `Call Alert` and press  to select.

---

- 5 The display shows `Call Alert` and the subscriber alias or ID, indicating that the Call Alert has been sent.

---

- 6 The LED lights up solid green when your radio is sending the Call Alert.

---

- 7 If the Call Alert acknowledgement is received, the display shows positive mini notice.  
**OR**  
If the Call Alert acknowledgement is not received, the display shows negative mini notice.

---

## ☞ Making a Call Alert with the One Touch Access Button

### Procedure:

- 1 Press the programmed **One Touch Access** button to make a Call Alert to the predefined alias or ID.

---

- 2 The display shows `Call Alert` and the subscriber alias or ID, indicating that the Call Alert has been sent.

---

- 3 The LED lights up solid green when your radio is sending the Call Alert.

---

- 4 If the Call Alert acknowledgement is received, the display shows positive mini notice.  
**OR**  
If the Call Alert acknowledgement is not received, the display shows negative mini notice.

---

## ■ Emergency Operation

An Emergency Alarm is used to indicate a critical situation. You are able to initiate an Emergency at any time on any screen display even when there is activity on the current channel.

Your dealer can set the duration of a button press for the programmed **Emergency** button, except for long press, which is similar with all other buttons:

- Short press – Between 0.05 seconds and 0.75 seconds
- Long press – Between 1.00 second and 3.75 seconds

The **Emergency** button is assigned with the Emergency On/Off feature. Check with your dealer for the assigned operation of the **Emergency** button.

*If short press the **Emergency** button is assigned to turn on the Emergency mode, then long press the **Emergency** button is assigned to exit the Emergency mode.*

*If long press the **Emergency** button is assigned to turn on the Emergency mode, then short press the **Emergency** button is assigned to exit the Emergency mode.*

Your radio supports **three** Emergency Alarms:

- Emergency Alarm
- Emergency Alarm with Call
- Emergency Alarm with Voice to Follow 



In addition, each alarm has the following types:

- **Regular** – Radio transmits an alarm signal and shows audio and/or visual indicators.
- **Silent** – Radio transmits an alarm signal without any audio or visual indicators. Radio receives calls without any sound through the radio's speaker, until you press the **PTT** button to initiate the call.
- **Silent with Voice** – Radio transmits an alarm signal without any audio or visual indicators, but allow incoming calls to sound through the radio's speaker.



Only **ONE** of the Emergency Alarms above can be assigned to the programmed **Emergency** button.



### Receiving an Emergency Alarm

#### Procedure:

- 1 The emergency icon appears, a tone sounds, the LED blinks red, and the radio displays the Alarm List if there is more than one alarm listed. The emergency caller aliases are listed. ▲ or ▼ to the required alias and press  to view more details. Press  again to view your action options.

#### OR





The emergency icon appears, a tone sounds, the LED blinks red, and the radio displays the emergency caller alias. Press  to view more details. Press  again to view your action options.

- Press  and select **Yes** to exit the Alarm List.  
To revisit the Alarm List, press  to access the menu and select **Alarm List**.

## Responding to an Emergency Alarm

### Procedure:

When receiving an Emergency Alarm:

- In the Alarm List,  or  to the required alias.
- Hold the radio vertically 1 to 2 inches (2.5 to 5.0 cm) from your mouth.  
 If the Channel Free Indication feature is enabled, you hear a short alert tone the moment the transmitting radio releases the **PTT** button, indicating the channel is now available for use.
- Press **PTT** button to transmit non-emergency voice to the same group that the Emergency Alarm was targeted to. The LED lights up solid green. Your radio remains in the Emergency mode.
- Wait for the Talk Permit Tone to finish (if enabled) and speak clearly into the microphone.  
**OR**  
 Wait for the **PTT** Sidetone to finish (if enabled) and speak clearly into the microphone.

- Release the **PTT** button to listen. When the emergency initiating radio responds, the LED blinks green. You see the Group Call icon, the group ID, and transmitting radio ID on your display.
- Your radio displays the Alarm List.

*Emergency voice can only be transmitted by the emergency initiating radio. All other radios (including the emergency receiving radio) transmit non-emergency voice.*

## Sending an Emergency Alarm

This feature allows you to send an Emergency Alarm, a non-voice signal, which triggers an alert indication on a group of radios.

### Procedure:

- Press the programmed **Emergency On** button.
- The display shows **Tx Alarm** and the destination alias. The LED lights up solid green and the Emergency icon appears.  
**OR**  
 The display shows **Tx Telegram** and the destination alias. The LED lights up solid green and the Emergency icon appears.
- When an Emergency Alarm acknowledgment is received, the Emergency tone sounds and the LED blinks green. The display shows **Alarm Sent**.  
**OR**

If your radio does not receive an Emergency Alarm acknowledgement, and after all retries have been exhausted, a tone sounds and the display shows **Alarm Failed**.

- 4 Radio exits the Emergency Alarm mode and returns to the Home screen.



*If your radio is set to Silent, it does not display any audio or visual indicators during Emergency mode.*

### Sending an Emergency Alarm with Call

This feature allows you to send an Emergency Alarm to a group of radios. Upon acknowledgement by a radio within the group, the group of radios can communicate over a programmed Emergency channel.

#### Procedure:

- 1 Press the programmed **Emergency On** button.
- 2 The display shows **Tx Alarm** and the destination alias. The LED lights up solid green and the Emergency icon appears.  
**OR**  
 The display shows **Tx Telegram** and the destination alias. The LED lights up solid green and the Emergency icon appears.
- 3 When an Emergency Alarm acknowledgment is received, the Emergency tone sounds and the LED blinks green. The display shows **Alarm Sent**.

- 4 Your radio enters the emergency call mode when the display shows **Emergency** and the destination group alias.
- 5 Hold the radio vertically 1 to 2 inches (2.5 to 5.0 cm) from your mouth.
- 6 Press **PTT** button to make the call. The LED lights up solid green and the group icon appears on the display.
- 7 Wait for the Talk Permit Tone to finish (if enabled) and speak clearly into the microphone.  
**OR**  
 Wait for the **PTT** Sidetone to finish (if enabled) and speak clearly into the microphone.
- 8 Release the **PTT** button to listen.  
When you receive a group call, the display shows the caller alias and group alias.
- 9 When the channel is free for you to respond, a short alert tone sounds (  if the Channel Free Indication feature is enabled). Press the **PTT** button to respond.  
**OR**  
Once your call ends, press **Emergency Off** button to exit the Emergency mode.
- 10 The radio returns to the Home screen.

*If your radio is set to Silent, it does not display any audio or visual indicators during Emergency mode, or allow any received*

*calls to sound through the radio's speaker, until you press the **PTT** button to initiate the call.*

*If your radio is set to Silent with Voice, it does not display any audio or visual indicators during Emergency mode, but allow incoming calls to sound through the radio's speaker. The indicators only appear once you press the **PTT** button to initiate, or respond to, the call.*

## Sending an Emergency Alarm with Voice to Follow

This feature allows you to send an Emergency Alarm to a group of radios. Your radio's microphone is automatically activated, allowing you to communicate with the group of radios without pressing the **PTT** button.

This activated microphone state is also known as "hot mic".

If your radio has Emergency Cycle Mode enabled, repetitions of hot mic and receiving period are made for a programmed duration.

**NOTE:** During Emergency Cycle Mode, received calls sound through the radio's speaker.

If you press the **PTT** button during the programmed receiving period, you will hear a prohibit tone, indicating that you should release the **PTT** button. The radio ignores the **PTT** press and remains in Emergency mode.

**NOTE:** If you press the **PTT** button during hot mic, and continue to press it after the hot mic duration expires, the radio continues to transmit until you release the **PTT** button.

### Procedure:

- 1 Press the programmed **Emergency On** button.

---
- 2 The display shows Tx Alarm and the destination alias. The LED lights up solid green and the Emergency icon appears.  
**OR**  
 The display shows Tx Telegram and the destination alias. The LED lights up solid green and the Emergency icon appears.

---
- 3 Once the display shows Alarm Sent, speak clearly into the microphone. When hot mic has been enabled, the radio automatically transmits without a **PTT** press until the hot mic duration expires. While transmitting, the LED lights up solid green and the Emergency icon appears.

---
- 4 The radio automatically stops transmitting when: Once the cycling duration between hot mic and receiving calls expires, if Emergency Cycle Mode is enabled.  
**OR**  
Once the hot mic duration expires, if Emergency Cycle Mode is disabled.

---
- 5 To transmit again, press the **PTT** button.  
**OR**

Press the programmed **Emergency Off** button to exit the Emergency mode.

## 6 The radio returns to the Home screen.

*If your radio is set to Silent, it does not display any audio or visual indicators during Emergency mode, or allow any received calls to sound through the radio's speaker, until the programmed hot mic transmission period is over, and you press the **PTT** button.*

*If your radio is set to Silent with Voice, it does not display any audio or visual indicators during Emergency mode when you are making the call with hot mic, but allow sound through the radio's speaker when the target radio responds after the programmed hot mic transmission period is over. The indicators only appear when you press the **PTT** button.*

**NOTE:** If the Emergency Alarm request fails, the radio does not retry to send the request, and enters the hot mic state directly.

## Reinitiating an Emergency Mode

**NOTE:** This feature is only applicable to the radio sending the Emergency Alarm.

There are two instances where this can happen:

- You change the channel while the radio is in Emergency mode. This exits the Emergency mode. If Emergency Alarm is enabled on this new channel, the radio reinitiates Emergency.

- You press the programmed **Emergency On** button during an Emergency initiation/transmission state. This causes the radio to exit this state, and to reinitiate Emergency.

## Exiting Emergency Mode

**NOTE:** This feature is only applicable to the radio sending the Emergency Alarm.

Your radio exits Emergency mode when **one** of the following occurs:

- Emergency Alarm acknowledgement is received (for **Emergency Alarm** only), **OR**
-  An Emergency Exit Telegram is received, **OR**
- All retries to send the alarm have been exhausted, **OR**
- The **Emergency Off** button is pressed, **OR**

**NOTE:** If your radio is powered off, it exits the Emergency mode. The radio does not reinitiate the Emergency mode automatically when it is turned on again.

If you change channels when your radio is in Emergency mode to a channel that has no emergency system configured, No Emergency is shown on your display.

## Man Down

This feature prompts an emergency to be raised if there is a change in the radio's motions, such as the radio's tilt, motion and/or the lack of motion for a predefined time.

Following a change in the radio's motion for a programmed duration, the radio pre-warns the user via an audio indicator indicating that a change in motion is detected.

If there is still no acknowledgment by the user before the predefined reminder timer expires, the radio initiates an Emergency Alarm or an Emergency Call.

### Turning the Man Down Feature On or Off

#### Procedure:

Press the programmed **Man Down** button to toggle the feature on or off.

#### OR

Follow the procedure below.

- 1  to access the menu.

---

- 2  or  to Utilities and press  to select.

---

- 3  or  to Radio Settings and press  to select.

---

- 4  or  to Man Down and press  to select.

---

- 5 Press  to enable Man Down. The display shows ✓ beside Enabled.

#### OR

- Press  to disable Man Down. The ✓ disappears from beside Enabled.

**NOTE:** At Step 4, you can also use  or  to change the selected option.

If you disable the Man Down feature, the programmed alert tone sounds repeatedly until the Man Down feature is enabled.

A device failure tone sounds when the Man Down feature fails while powering up. The device failure tone will continue until the radio resumes normal operation.

## ■ Text Message Features

Your radio is able to receive data, for example a text message, from another radio or an e-mail application.

The **maximum** length of characters for sending a text message, including the subject line (seen when receiving message from an e-mail application), is **140**, whereas to receive would be a maximum of **280** characters.

The radio exits the current screen once the inactivity timer expires. Any text message in the writing/editing screen is automatically saved to the Drafts folder.

**NOTE:** Long press  at any time to return to the Home screen.

### Writing and Sending a Text Message



#### Procedure:



Press the programmed **Text Message** button and proceed to Step 3.

#### OR

Follow the procedure below.

1  to access the menu.



2  or  to **Messages** and press  to select.

3  or  to **Compose** and press  to select.

4 A blinking cursor appears.



Use the keypad to type your message.

Press  to move one space to the left.



Press  or  to move one space to the right.

Press  to delete any unwanted characters.

5 Press  once message is composed.

6  or  to the required alias or ID and press  to select.

#### OR

 or  to **Manual Dial** and press  to select.

Key in the subscriber ID and press .

#### OR

 to edit the message.

 again to discard the message or save it to the Drafts folder.

7 The display shows transitional mini notice, confirming your message is being sent.

8 If the message is sent, a tone sounds and the display shows positive mini notice.

#### OR

If the message is not sent, a low tone sounds and the display shows negative mini notice.



If the text message fails to send, the radio returns you to the *Resend* option screen (see **Managing Fail-to-Send Text Messages** on page 63).

### Sending a Quick Text Message

Your radio supports a maximum of 50 Quick Text messages as programmed by your dealer.

While Quick Text messages are predefined, you can edit each message before sending it.

#### Procedure:



Press the programmed **Text Message** button and proceed to Step 3.

#### OR



Follow the procedure below.

- 1  to access the menu.



---

- 2  or  to **Messages** and press  to select.





---

- 3  or  to **Quick Text** and press  to select.

---

- 4  or  to the required Quick Text and press  to select.

---

- 5 A blinking cursor appears.  
Use the keypad to edit the message, if required.  
Press  to move one space to the left.  
Press  or  to move one space to the right.  
Press  to delete any unwanted characters.



---

- 6 Press  once message is composed.

---

- 7  or  to the required alias or ID and press  to select.

#### OR

-  or  to **Manual Dial** and press  to select.

Key in the subscriber alias or ID and press .

#### OR

 to edit the message.

 again to discard the message or save it to the Drafts folder.

---

- 8 The display shows transitional mini notice, confirming your message is being sent.

---

- 9 If the message is sent, a tone sounds and the display shows positive mini notice.

#### OR

If the message is not sent, a low tone sounds and the display shows negative mini notice.

---

If the text message fails to send, the radio returns you to the *Resend* option screen (see **Managing Fail-to-Send Text Messages** on page 63).

## Sending a Quick Text Message with the One Touch Access Button

### Procedure:

- 1 Press the programmed **One Touch Access** button to send a predefined Quick Text message to a predefined alias or ID.

---

- 2 The display shows transitional mini notice, confirming your message is being sent.

---

- 3 If the message is sent, a tone sounds and the display shows positive mini notice.  
**OR**  
If the message is not sent, a low tone sounds and the display shows negative mini notice.

*If the text message fails to send, the radio returns you to the **Resend** option screen (see **Managing Fail-to-Send Text Messages** on page 63).*

## Accessing the Drafts Folder

You can save a text message to send it at a later time.

If a **PTT** button press or a mode change causes the radio to exit the text message writing/editing screen while you are in the process of writing or editing a text message, your current text message is automatically saved to the Drafts folder.

The most recent saved text message is always added to the top of the Drafts list.

The Drafts folder stores a maximum of ten (10) last saved messages. When the folder is full, the next saved text message automatically replaces the oldest text message in the folder.

**NOTE:** Long press  at any time to return to the Home screen.

## Viewing a Saved Text Message

### Procedure:



Press the programmed **Text Message** button and proceed to Step 3.

### OR



Follow the procedure below.

- 1  to access the menu.



---

- 2  or  to **Messages** and press  to select.

---

- 3  or  to **Drafts** and press  to select.

---



- 4  or  to the required message and press  to select.

## Editing and Sending a Saved Text Message

### Procedure:

- 1 Press  again while viewing the message.

---

- 2  or  to **Edit** and press  to select.  
A blinking cursor appears.

Use the keypad to edit your message.

Press to move one space to the left.

Press or to move one space to the right.

Press to delete any unwanted characters.

Press once message is composed.

- 3 or to the required alias or ID and press to select.

**OR**

or to Manual Dial and press to select.

Key in the subscriber alias or ID and press .

- 4 The display shows transitional mini notice, confirming your message is being sent.

- 5 If the message is sent, a tone sounds and the display shows positive mini notice.

**OR**

If the message is not sent, a low tone sounds and the display shows negative mini notice.

*If the text message fails to send, it is moved to the Sent Items folder and marked with a Send Failed icon.*

### **Deleting a Saved Text Message from Drafts**

**Procedure:**

Press the programmed **Text Message** button and proceed to Step 3.

**OR**

Follow the procedure below.

- 1 to access the menu.

---

- 2 or to Messages and press to select.

---

- 3 or to Drafts and press to select.

---

- 4 or to the required message and press to select.

---

- 5 Press again while viewing the message.

---

- 6 or to Delete and press to delete the text message.

---

### **Managing Fail-to-Send Text Messages**

You can select one of the following options while at the Resend option screen:

- Resend
- Forward
- Edit

**NOTE:** If the channel type (i.e. conventional digital or Capacity Plus or Linked Capacity Plus) is not a match, you can only edit and forward a Fail-to-Send message.

## Resending a Text Message











### Procedure:

- 1 Press  to resend the same message to the same subscriber/group alias or ID.
- 2 If the message is sent, a tone sounds and the display shows positive mini notice.  
**OR**  
If the message is not sent, a low tone sounds and the display shows negative mini notice.

## Forwarding a Text Message

Select **Forward** to send the message to another subscriber/group alias or ID.

### Procedure:

- 1  or  to **Forward** and press  to select.
- 2  or  to the required alias or ID and press  to select.  
**OR**  
 or  to **Manual Dial** and press  to select.  
Key in the subscriber ID and press .
- 3 The display shows transitional mini notice, confirming your message is being sent.
- 4 If the message is sent, a tone sounds and the display shows positive mini notice.

### OR















If the message is not sent, a low tone sounds and the display shows negative mini notice.

## Editing a Text Message

Select **Edit** to edit the message before sending it.

**NOTE:** If a subject line is present (for messages received from an e-mail application), you cannot edit it.

### Procedure:

- 1  or  to **Edit** and press  to select.
- 2 A blinking cursor appears.  
Use the keypad to edit your message.  
Press  to move one space to the left.  
Press  or  to move one space to the right.  
Press  to delete any unwanted characters.
- 3 Press  once message is composed.
- 4  or  to **Send** and press  to send the message.  
**OR**  
 or  to **Save** and press  to save the message to the Drafts folder.  
**OR**  
 to edit the message.

 again to delete the message or save it to the Drafts folder.

5 ▲ or ▼ to the required alias or ID and press  to select.

**OR**

▲ or ▼ to Manual Dial and press  to select.

Key in the subscriber ID and press .

6 The display shows transitional mini notice, confirming your message is being sent.

7 If the message is sent, a tone sounds and the display shows positive mini notice.

**OR**

If the message is not sent, a low tone sounds and the display shows negative mini notice.

## Managing Sent Text Messages

Once a message is sent to another radio, it is saved in Sent Items. The most recent sent text message is always added to the top of the Sent Items list.

The Sent Items folder is capable of storing a maximum of thirty (30) last sent messages. When the folder is full, the next sent text message automatically replaces the oldest text message in the folder.

**NOTE:** Long press  at any time to return to the Home screen.

## Viewing a Sent Text Message

**Procedure:**

Press the programmed **Text Message** button and proceed to Step 3.

**OR**

Follow the procedure below.

1  to access the menu.

2 ▲ or ▼ to Messages and press  to select.

3 ▲ or ▼ to Sent Items and press  to select.

4 ▲ or ▼ to the required message and press  to select.

A subject line may be shown if the message is from an e-mail application.

*The icon beside each message indicates the status of the message (see **Sent Item Icons** on page 18).*





## Sending a Sent Text Message

You can select one of the following options while viewing a sent text message:



- Resend
- Forward
- Edit
- Delete

**NOTE:** If the channel type (i.e. conventional digital or Capacity Plus or Linked Capacity Plus) is not a match, you can only edit, forward, or delete a Sent message.

**Procedure:**



- 1 Press  again while viewing the message.
- 2  or  to Resend and press  to select.
- 3 The display shows transitional mini notice, confirming that the same message is being sent to the same target radio.
- 4 If the message is sent, a tone sounds and the display shows positive mini notice.  
**OR**  
If the message is not sent, a low tone sounds and the display shows negative mini notice.

*If the message fails to send, the radio returns you to the Resend option screen. Press  to resend the message to the same subscriber/group alias or ID.*

**NOTE:** Changing the volume, and pressing any button, except for , , or , returns you to the message.

The radio exits the Resend option screen if you press the **PTT** button to initiate a Private or Group Call, or to respond to a Group Call. The radio also exits the screen when it receives a text or telemetry message, an emergency call or alarm, or a call alert.

The display returns to the Resend option screen if you press the **PTT** button to respond to a Private Call (except when the radio is displaying the Missed Call screen), and at the end of an All Call.

Press  or  to access the Forward, Edit, or Delete option screen:

- Select *Forward* to send the selected text message to another subscriber/group alias or ID (see **Forwarding a Text Message** on page 64).
- Select *Edit* to edit the selected text message before sending it (see **Editing a Text Message** on page 64).
- Select *Delete* to delete the text message.

**NOTE:** If you exit the message sending screen while the message is being sent, the radio updates the status of the message in the Sent Items folder without providing any indication in the display or via sound.

If the radio changes mode or powers down before the status of the message in Sent Items is updated, the radio cannot complete any In-Progress messages and automatically marks it with a Send Failed icon.

The radio supports a maximum of five (5) In-Progress messages at one time. During this period, the radio cannot send any new message and automatically marks it with a Send Failed icon.

## **Deleting All Sent Text Messages from Sent Items**

### **Procedure:**



Press the programmed **Text Message** button and proceed to Step 3.

### **OR**



Follow the procedure below.

- 1  to access the menu.



---

  - 2  or  to Messages and press  to select.







---

  - 3  or  to Sent Items and press  to select.

---

  - 4  or  to Delete All and press  to select.

---

  - 5  or  to Yes and press  to select. The display shows positive mini notice
- OR**
-  or  to No and press  to return to the previous screen.

*When you select Sent Items and it contains no text messages, the display shows *List Empty*, and sounds a low tone if Keypad Tones are turned on (see **Turning Keypad Tones On or Off** on page 84).*

## **Receiving a Text Message**

When your radio receives a message, the display shows the Notification List with the alias or ID of the sender and the message icon.



You can select one of the following options when receiving a text message:

- Read
- Read Later
- Delete

**NOTE:** The radio exits the Text Message alert screen and sets up a Private or Group Call to the sender of the message if the **PTT** button is pressed when the radio is displaying the alert screen.

## **Reading a Text Message**



### **Procedure:**

- 1  or  to Read? and press  to select.

---

  - 2 Selected message in the Inbox opens.  
A subject line may be shown if the message is from an e-mail application.

---

  - 3 Press  to return to the Inbox.
- OR**
- Press  to reply, forward, or delete the text message.

Press ▲ or ▼ to access the *Read Later* or *Delete* option screen:

- Select *Read Later* to return to the screen you were on prior to receiving the text message.
- Select *Delete* to delete the text message.

### Managing Received Text Messages

Use the Inbox to manage your text messages. The Inbox is capable of storing a maximum of 30 messages.

Your radio supports the following options for text messages:

- Reply
- Forward
- Delete
- Delete All

**NOTE:** If the channel type (i.e. conventional digital or Capacity Plus or Linked Capacity Plus) is not a match, you can only forward, delete, or delete all Received messages.

Text messages in the Inbox are sorted according to the most recently received.

**NOTE:** Long press  at any time to return to the Home screen.

### Viewing a Text Message from the Inbox

#### Procedure:

- 1  to access the menu.

---

- 2 ▲ or ▼ to Messages and press  to select.



---

- 3 ▲ or ▼ to Inbox and press  to select.

---

- 4 ▲ or ▼ to view the messages.  
A subject line may be shown if the message is from an e-mail application.

---

- 5 Press  to select the current message, and press  again to reply, forward, or delete that message.  
**OR**  
Long press  to return to the Home screen.

### Viewing a Telemetry Status Text Message from the Inbox

#### Procedure:

- 1  to access the menu.



---

- 2 ▲ or ▼ to Messages and press  to select.

---

- 3 ▲ or ▼ to Inbox and press  to select.



- 4 ▲ or ▼ to the required message and press  to select.
- 5 The display shows Telemetry: <Status Text Message>.
- 6 Long press  to return to the Home screen.

*You cannot reply to a Telemetry Status text message.*







### **Replying to a Text Message from the Inbox**

#### **Procedure:**

Press the programmed **Text Message** button and proceed to Step 3.

#### **OR**

Follow the procedure below.

- 1  to access the menu.
  - 2 ▲ or ▼ to Messages and press  to select.
  - 3 ▲ or ▼ to Inbox and press  to select.
  - 4 ▲ or ▼ to the required message and press  to select.  
A subject line may be shown if the message is from an e-mail application.
  - 5 Press  once more to access the sub-menu.
  - 6 ▲ or ▼ to Reply and press  to select.
- OR**
- ▲ or ▼ to Quick Reply and press  to select.

A blinking cursor appears. Use the keypad to edit your message, if required.

- 7 Press  once message is composed.
- 8 The display shows transitional mini notice, confirming your message is being sent.
- 9 If the message is sent, a tone sounds and the display shows positive mini notice.  
**OR**  
If the message is not sent, a low tone sounds and the display shows negative mini notice.

*If the message fails to send, the radio returns you to the Resend option screen (see **Managing Fail-to-Send Text Messages** on page 63).*



### **Deleting a Text Message from the Inbox**

#### **Procedure:**

Press the programmed **Text Message** button and proceed to Step 3.

#### **OR**

Follow the procedure below.

- 1  to access the menu.
- 2 ▲ or ▼ to Messages and press  to select.
- 3 ▲ or ▼ to Inbox and press  to select.

- 4 ▲ or ▼ to the required message and press  to select.  
A subject line may be shown if the message is from an e-mail application.

---

- 5 Press  once more to access the sub-menu.

---

- 6 ▲ or ▼ to Delete and press  to select.

---

- 7 ▲ or ▼ to Yes and press  to select.

---

- 8 The display shows positive mini notice.

---

- 9 The screen returns to the Inbox.

---

### **Deleting All Text Messages from the Inbox**

#### **Procedure:**

Press the programmed **Text Message** button and proceed to Step 3.

#### **OR**

Follow the procedure below.

- 1  to access the menu.

---

- 2 ▲ or ▼ to Messages and press  to select.

---

- 3 ▲ or ▼ to Inbox and press  to select.

---

- 4 ▲ or ▼ to Delete All and press  to select.

---

- 5 ▲ or ▼ to Yes and press  to select.

---

- 6 The display shows positive mini notice.

---



*When you select the Inbox and it contains no text messages, the display shows *List Empty*, and sounds a low tone if Keypad Tones are turned on (see **Turning Keypad Tones On or Off** on page 84).*

## ■ Analog Message Encode

Your radio is able to send preprogrammed messages from the Message list to a radio alias or to the dispatcher.

### Sending MDC Message Encode to Dispatcher

#### Procedure:

- 1 ▲ or ▼ to Message and press  to select.
- 2 ▲ or ▼ to Quick Text and press  to select.
- 3 ▲ or ▼ to the required message. Press  to send.
- 4 The display shows transitional mini notice, confirming your message is being sent.
- 5 If the message is sent, a tone sounds and the display shows positive mini notice.  
**OR**  
If the message is not sent, a low tone sounds and the display shows negative mini notice.



## ■ Analog Status Update

Your radio is able to send preprogrammed messages from the Status List indicating your current activity to the dispatcher.

The last acknowledged message is kept at the top of the Status List. The other messages are arranged in alphanumeric order.

### Sending Status Update to Predefined Contact

#### Procedure:

- 1 ▲ or ▼ to Status and press  to select.
- 2 ▲ or ▼ to the required status. Press  to select.
- 3 ▲ or ▼ to Set as Default. Press  to send the status update.
- 4 The display shows transitional mini notice, confirming your status update is being sent.
- 5 If the status update is acknowledged, a tone sounds and the display shows positive mini notice. A ✓ appears beside the acknowledged status.  
**OR**  
If the status update is not acknowledged, a low tone sounds and the display shows negative mini notice. A ✓ remains beside the previous status.

## ■ Privacy

If enabled, this feature helps to prevent eavesdropping by unauthorized users on a channel by the use of a software-based scrambling solution. The signaling and user identification portions of a transmission are not scrambled.

Your radio must have privacy enabled on the channel to send a privacy-enabled transmission, although this is not a necessary requirement for receiving a transmission. While on a privacy-enabled channel, the radio is still able to receive clear (unscrambled) transmissions.

Your radio supports **two types of privacy**:

- **Basic Privacy**
- **Enhanced Privacy.**

Only **ONE** of the privacy types above can be assigned to the radio.

To unscramble a privacy-enabled call or data transmission, your radio must be programmed to have **the same Privacy Key (for Basic Privacy), OR** the same Key Value and Key ID (for **Enhanced Privacy**) as the transmitting radio.

If your radio receives a scrambled call that is of **a different Privacy Key, OR** a different Key Value and Key ID, you will either hear **a garbled transmission (Basic Privacy)** or nothing at all (**Enhanced Privacy**).

The LED lights up solid green while the radio is transmitting and double blinks green when the radio is receiving an ongoing privacy-enabled transmission.

**NOTE:** Some radio models may not offer this Privacy feature. Check with your dealer or system administrator for more information.

### **Procedure:**



Press the programmed **Privacy** button to toggle privacy on or off.

### **OR**



Follow the procedure below.

- 1  to access the menu.



---

  - 2  or  to Utilities and press  to select.



---

  - 3  or  to Radio Settings and press  to select.

---

  - 4  or  to Privacy.

---

  - 5 Press  to enable Privacy. The display shows ✓ beside Enabled.
- OR**
- Press  to disable Privacy. The ✓ disappears from beside Enabled.

*If the radio has a privacy type assigned, the secure or unsecure icon appears on the status bar, except when the radio is sending or receiving an Emergency call or alarm.*

**NOTE:** At Step 4, you can also use ◀ or ▶ to change the selected option.

## ■ Dual Tone Multi Frequency (DTMF)

---

The Dual Tone Multi Frequency (DTMF) feature allows the radio to operate in a radio system with an interface to telephone systems.

### **Procedure:**

To initiate a DTMF call.

- 1 Press and hold the **PTT** button.
  - 2 Enter the desired number, \* or #.
- 

*You can turn off the DTMF tone by disabling all radio tones and alerts (see **Turning the Radio Tones/Alerts On or Off** on page 83).*

## ■ Multi-Site Controls

These features are applicable when your current radio channel is part of an IP Site Connect or Linked Capacity Plus configuration.

See **IP Site Connect** on page 13 and **Linked Capacity Plus** on page 14 for more details about these configurations.

### Starting an Automatic Site Search

**NOTE:** The radio **only** scans for a new site if the current signal is weak or when the radio is unable to detect any signal from the current site. If the RSSI value is strong, the radio remains on the current site.

#### **Procedure:**













Press the programmed **Site Lock On/Off** button.

- 1 A tone sounds and the display shows *Site Unlocked*.
- 2 The LED blinks yellow rapidly when the radio is actively searching for a new site, and turns off once the radio locks on to a site.
- 3 The display shows the channel alias and the site roaming icon appears.

**OR**

#### **Procedure:**

Use the menu.

- 1  to access the menu.
- 2  or  to *Utilities* and press  to select.
- 3  or  to *Radio Settings* and press  to select.
- 4  or  to *Site Roaming* and press  to select.
- 5  or  to *Unlock Site* and press  to select. A tone sounds and the display shows *Site Unlocked*.
- 6 The radio returns to the Home screen. The display shows the channel alias and the site roaming icon appears.
- 7 The LED blinks yellow rapidly when the radio is actively searching for a new site, and turns off once the radio locks on to a site.

*The radio also performs an automatic site search (site is unlocked) during a **PTT** button press or data transmission if the current channel, a multi-site channel with an attached roam list, is out of range.*

### Stopping an Automatic Site Search

When the radio is actively searching for a new site:







**Procedure:**

Press the programmed **Site Lock On/Off** button.

- 1 A tone sounds and the display shows `Site Locked`.
- 2 The LED turns off and the display shows the channel alias.

**OR****Procedure:**

Use the menu.

- 1  to access the menu.
- 2 ▲ or ▼ to `Utilities` and press  to select.
- 3 ▲ or ▼ to `Radio Settings` and press  to select.
- 4 ▲ or ▼ to `Site Roaming` and press  to select.
- 5 ▲ or ▼ to `Lock Site State`. 
- 6 Press  to lock site. The display shows ✓ beside `Enabled`.

**OR**

Press  to unlock site. The ✓ disappears from beside `Enabled`. The LED turns off and the radio returns to the Home screen. The display shows the channel alias.





**NOTE:** At Step 5, you can also use ◀ or ▶ to change the selected option.

 **Starting a Manual Site Search****Procedure:**

Press the programmed **Manual Site Roam** button and proceed to Step 6.

**OR**

Follow the procedure below.

- 1  to access the menu.
  - 2 ▲ or ▼ to `Utilities` and press  to select.
  - 3 ▲ or ▼ to `Radio Settings` and press  to select.
  - 4 ▲ or ▼ to `Site Roaming` and press  to select.
  - 5 ▲ or ▼ to `Active Search` and press  to select.
  - 6 A tone sounds and the display shows `Finding Site`. The LED blinks green.
  - 7 If a new site is found, a tone sounds and the LED turns off. The display shows `Site <Alias> Found`.
- OR**
- If there is no available site within range, a tone sounds and the LED turns off. The display shows `Out of Range`.
- OR**
- If a new site is within range, but the radio is unable to connect to it, a tone sounds and the LED turns off. The display shows `Channel Busy`.
- 8 The radio returns to the Home screen.

## ■ Security

You can enable or disable any radio in the system. For example, you might want to disable a stolen radio, to prevent the thief from using it, and enable that radio, when it is recovered.

**NOTE:** Performing Radio Disable and Enable is limited to radios with these functions enabled. Check with your dealer or system administrator for more information.

### Radio Disable

#### Procedure:

Use the programmed **Radio Disable** button.

- 1 Press the programmed **Radio Disable** button.

---

- 2 ▲ or ▼ to the required alias or ID and press  to select.

---

- 3 The display shows transitional mini notice, indicating the request is in progress. The LED blinks green.

---

- 4 Wait for acknowledgment.

---

- 5 If successful, a positive indicator tone sounds and the display shows positive mini notice.  
**OR**  
If unsuccessful, a negative indicator tone sounds and the display shows negative mini notice.

**OR**

#### Procedure:



Use the menu.

- 1  to access the menu.

---

- 2 ▲ or ▼ to **Contacts** and press  to select. The entries are alphabetically sorted.

---

- 3 ▲ or ▼ to the required alias or ID and press  to select.  
**OR**  
▲ or ▼ to **Manual Dial** and press  to select.  
Key in the subscriber alias or ID and press .

---

- 4 ▲ or ▼ to **Radio Disable** and press  to select.

---

- 5 The display shows transitional mini notice, indicating the request is in progress. The LED blinks green.

---

- 6 Wait for acknowledgment.

---

- 7 If successful, a positive indicator tone sounds and the display shows positive mini notice.  
**OR**  
If unsuccessful, a negative indicator tone sounds and the display shows negative mini notice.

*Do not press  during the Radio Disable operation as you will not get an acknowledgement message.*



## ☞ Radio Enable

### Procedure:

Use the programmed **Radio Enable** button.

- 1 Press the programmed **Radio Enable** button.

---

- 2 ▲ or ▼ to the required alias or ID and press  to select.

---

- 3 The display shows **Radio Enable** and the subscriber alias or ID. The LED lights up solid green.

---

- 4 Wait for acknowledgment.

---

- 5 If successful, the radio sounds a positive indicator tone and the display shows positive mini notice.  
**OR**  
If unsuccessful, the radio sounds a negative indicator tone and the display shows negative mini notice.

**OR**

### Procedure:

Use the menu.



- 1  to access the menu.

---

  - 2 ▲ or ▼ to **Contacts** and press  to select. The entries are alphabetically sorted.

---

  - 3 ▲ or ▼ to the required alias or ID and press  to select.
- OR**

▲ or ▼ to **Manual Dial** and press  to select.  
Key in the subscriber alias or ID and press .

- 4 ▲ or ▼ to **Radio Enable** and press  to select.

---

- 5 The display shows **Radio Enable** and the subscriber alias or ID. The LED lights up solid green.

---

- 6 Wait for acknowledgment.

---

- 7 If successful, the radio sounds a positive indicator tone and the display shows positive mini notice.  
**OR**  
If unsuccessful, the radio sounds a negative indicator tone and the display shows negative mini notice.

*Do not press  during the Radio Enable operation as you will not get an acknowledgement message.*

## ■ Lone Worker

This feature prompts an emergency to be raised if there is no user activity, such as any radio button press or activation of the channel selector, for a predefined time.

Following no user activity for a programmed duration, the radio pre-warns the user via an audio indicator once the inactivity timer expires.

If there is still no acknowledgment by the user before the predefined reminder timer expires, the radio initiates an Emergency Alarm.

Only **one** of the following Emergency Alarms is assigned to this feature:

- Emergency Alarm
- Emergency Alarm with Call
- Emergency Alarm with Voice to Follow 

The radio remains in the emergency state allowing voice messages to proceed until action is taken. See **Emergency Operation** on page 54 on ways to exit Emergency.

**NOTE:** This feature is limited to radios with this function enabled. Check with your dealer or system administrator for more information.

## ■ Password Lock Features

If enabled, this feature allows you to access your radio via password upon powering up.



### Accessing the Radio from Password

#### Procedure:

Power up the radio.

- 1 You hear a continuous tone.
- 2 Enter your current four-digit password with the radio's keypad. The display shows ●●●●. Press  to proceed.

#### OR

Enter your current four-digit password. Press ▲ or ▼ to edit each digit's numeric value. Press ▶ or  to move to the next digit. Each digit changes to ●. Press  to confirm your selection.

You hear a positive indicator tone for every digit pressed. Press ◀ to remove the each ● on the display. You hear a negative indicator tone, if you press ◀ when the line is empty, or if you press more than four digits.

- 3 If the password is correct:  
Your radio proceeds to power up. See **Powering Up the Radio** on page 5.

**OR**

If the password is incorrect:

The display shows *Wrong Password*. Repeat Steps 2.

**OR**

After the third incorrect password, the display shows *Wrong Password* and then, shows *Radio Locked*. A tone sounds and the LED double blinks yellow.

*Your radio enters into locked state for 15 minutes, and responds to inputs from **On/Off/Volume Control Knob** and programmed **Backlight Auto** button only.*

**NOTE:** The radio is unable to receive any call, including emergency calls, in locked state.

### **Unlocking the Radio from Locked State**

**Procedure:**

Wait for 15 minutes. Repeat Steps 1 to 3 in **Accessing the Radio from Password** on page 80.

**OR**













Power up the radio, if you have powered down the radio during locked state:

- 1 A tone sounds and the LED double blinks yellow. The display shows *Radio Locked*.
- 2 Wait for 15 minutes. Repeat **Accessing the Radio from Password** on page 80.

*Your radio restarts the 15 minutes timer for locked state when you power up.*

### **Turning the Password Lock On or Off**

**Procedure:**

- 1  to access the menu.
- 2  or  to *Utilities* and press  to select.
- 3  or  to *Radio Settings* and press  to select.
- 4  or  to *Passwd Lock* and press  to select.
- 5 Enter your current four-digit password.  
See Step 2 in **Accessing the Radio from Password** on page 80.
- 6 If the password is correct:
  - Press  to enable Password Lock. The display shows ✓ beside *Enabled*.
  - OR**
  - Press  to disable Password Lock. The ✓ disappears from beside *Enabled*.
  - OR**
  - If the password is incorrect:  
The display shows *Wrong Password* and automatically returns to the previous menu.

**NOTE:** At Step 6, you can also use ◀ or ▶ to change the selected option.

## Changing the Password

### Procedure:

- 1  to access the menu.

---
- 2 ▲ or ▼ to Utilities and press  to select.

---
- 3 ▲ or ▼ to Radio Settings and press  to select.

---
- 4 ▲ or ▼ to Passwd Lock and press  to select.

---
- 5 Enter your current four-digit password.  
See Step 2 in **Accessing the Radio from Password** on page 80.

---
- 6 If the password is correct:  
▲ or ▼ to Change Pwd and press  to select.  
**OR**  
If the password is incorrect:  
The display shows Wrong Password and automatically returns to the previous menu.

---
- 7 Enter a new four-digit password. See Step 2 in **Accessing the Radio from Password** on page 80.

---
- 8 Re-enter the new four-digit password. See Step 2 in **Accessing the Radio from Password** on page 80.

---

- 9 If both of the new password inputs match:  
The display shows Password Changed.  
**OR**  
If both of the new password inputs do not match:  
The display shows Passwords Do Not Match.

- 10 The screen automatically returns to the previous menu.

---

## ■ Notification List

---

Your radio has a Notification List that collects all your “unread” events on the channel, such as unread text messages, telegrams, telemetry messages, missed calls, and call alerts.

The Notification icon appears on the status bar when the Notification List has one or more events.







The list supports a maximum of forty (40) unread events. When it is full, the next event automatically replaces the oldest event.

After the events are read, they are removed from the Notification List.

**NOTE:** Your radio suspends Scan when the Notification List is displayed. Scanning resumes when your radio exits the Notification List. Press  to exit the Notification List or wait for the menu timer to expire.

### Accessing the Notification List

#### Procedure:

- 1  to access the menu.
- 2  or  to Notification and press  to select.
- 3  or  to the required event and press  to select.

Long press  to return to the Home screen.

## ■ Utilities

### ☰ Turning the Radio Tones/Alerts On or Off

You can enable and disable all radio tones and alerts (except for the incoming Emergency alert tone) if needed.

#### Procedure:

Press the programmed **All Tones/Alerts** button to toggle all tones on or off.

#### OR

Follow the procedure below.

- 1  to access the menu.

---

- 2 ▲ or ▼ to *Utilities* and press  to select.

---

- 3 ▲ or ▼ to *Radio Settings* and press  to select.

---

- 4 ▲ or ▼ to *Tones/Alerts* and press  to select.

---

- 5 ▲ or ▼ to *All Tones* and press  to select.

---

- 6 Press  to enable all tones. The display shows ✓ beside Enabled.

#### OR

Press  to disable all tones. The ✓ disappears from beside Enabled.

**NOTE:** At Step 5, you can also use ◀ or ▶ to change the selected option.

### ☰ Turning Keypad Tones On or Off

You can enable and disable keypad tones if needed.

#### Procedure:

- 1  to access the menu.

---

  - 2 ▲ or ▼ to *Utilities* and press  to select.

---

  - 3 ▲ or ▼ to *Radio Settings* and press  to select.



---

  - 4 ▲ or ▼ to *Tones/Alerts* and press  to select.

---

  - 5 ▲ or ▼ to *Keypad Tones* and press  to select.

---

  - 6 Press  to enable keypad tones. The display shows ✓ beside Enabled.
- OR**
- Press  to disable keypad tones. The ✓ disappears from beside Enabled.

**NOTE:** At Step 5, you can also use ◀ or ▶ to change the selected option.

## Setting the Tone Alert Volume Offset Level

You can adjust the Tone Alert Volume Offset level if needed. This feature adjusts the volume of the tones/alerts, allowing it to be higher or lower than the voice volume.

### Procedure:

- 1  to access the menu.

---

- 2 ▲ or ▼ to Utilities and press  to select.

---

- 3 ▲ or ▼ to Radio Settings and press  to select.

---

- 4 ▲ or ▼ to Tones/Alerts and press  to select.

---

- 5 ▲ or ▼ to Vol. Offset and press  to select.

---

- 6 ▲ or ▼ to the required volume value. The radio sounds a feedback tone with each corresponding volume value.

---

- 7 Press  to keep the required displayed volume value.

### OR

Repeat Step 6 to select another volume value.

### OR

 to exit without changing the current volume offset settings.

## Turning the Talk Permit Tone On or Off

You can enable and disable the Talk Permit Tone if needed.

### Procedure:

- 1  to access the menu.

---

- 2 ▲ or ▼ to Utilities and press  to select.

---

- 3 ▲ or ▼ to Radio Settings and press  to select.



---

- 4 ▲ or ▼ to Tones/Alerts and press  to select.

---

- 5 ▲ or ▼ to Talk Permit and press  to select.

---

- 6 Press  to enable Talk Permit Tone. The display shows ✓ beside Enabled.  
**OR**  
 Press  to disable Talk Permit Tone. The ✓ disappears from beside Enabled.

**NOTE:** At Step 5, you can also use ◀ or ▶ to change the selected option.

## Changing the Display Mode

You can change radio's display mode between Day or Night, as needed. This affects the color palette of the display.

### Procedure:

Press the programmed **Display Mode** button to toggle the display mode settings.

### OR

Follow the procedure below.

- 1  to access the menu.

---

- 2 ▲ or ▼ to Utilities and press  to select.

---

- 3 ▲ or ▼ to Radio Settings and press  to select.

---

- 4 ▲ or ▼ to Day/Night and press  to select.

---

- 5 The display shows Day Mode and Night Mode. ▲ or ▼ to the required setting and press  to enable. ✓ appears beside selected setting.

**NOTE:** At Step 4, you can also use ◀ or ▶ to change the selected option.

## Adjusting the Display Brightness

You can adjust radio's display brightness as needed.

### Procedure:

Press the programmed **Brightness** button and proceed to Step 5.

### OR

Follow the procedure below.

- 1  to access the menu.

---

- 2 ▲ or ▼ to Utilities and press  to select.

---

- 3 ▲ or ▼ to Radio Settings and press  to select.

---

- 4 ▲ or ▼ to Brightness and press  to select.

---

- 5 The display shows a progress bar. Decrease display brightness by pressing ◀ or increase the display brightness by pressing ▶. Press  to confirm your entry.

## Controlling the Display Backlight

You can enable or disable the radio's display backlight as needed. The setting also affects the Menu Navigation Buttons and keypad backlighting accordingly.

### Procedure:

Press the programmed **Backlight Auto** button to toggle the backlight settings.





**OR**



Follow the procedure below.

- 1  to access the menu.



---

  - 2  or  to Utilities and press  to select.



---

  - 3  or  to Radio Settings and press  to select.



---

  - 4  or  to Backlight Auto

---

  - 5 Press  to enable backlight. The display shows ✓ beside Enabled.
- OR**
- Press  to disable backlight. The ✓ disappears from beside Enabled.

*The display backlight and keypad backlighting are automatically turned off if the LED indicator is disabled (see **Turning the LED Indicator On or Off** on page 88).*

**NOTE:** At Step 4, you can also use  or  to change the selected option.

### **Setting the Squelch Level**

You can adjust your radio's squelch level to filter out unwanted calls with low signal strength or channels that have a higher than normal background noise.

**Settings:** Normal is the default. Tight filters out (unwanted) calls and/or background noise. However, calls from remote locations may also be filtered out.

**Procedure:**



Press the programmed **Squelch** button to toggle squelch level between normal and tight.

**OR**



Follow the procedure below.

- 1  to access the menu.



---

- 2  or  to Utilities and press  to select.



---

- 3  or  to Radio Settings and press  to select.

---



- 4  or  to Squelch and press  to select.

---

- 5 The display shows Tight and Normal.  or  to the required setting and press  to enable. ✓ appears besides selected setting.

---







- 6 Screen returns to the previous menu.

**NOTE:** At Step 4, you can also use  or  to change the selected option.

### **Turning the Introduction Screen On or Off**

You can enable and disable the Introduction Screen if needed.

### Procedure:



- 1  to access the menu.
- 2 ▲ or ▼ to Utilities and press  to select.
- 3 ▲ or ▼ to Radio Settings and press  to select.
- 4 ▲ or ▼ to Intro Screen and press  to select.
- 5 Press  to enable Introduction Screen. The display shows ✓ beside Enabled.  
**OR**  
Press  to disable Introduction Screen. The ✓ disappears from beside Enabled.



**NOTE:** At Step 4, you can also use ◀ or ▶ to change the selected option.

### Locking and Unlocking the Keypad

You can lock your radio's keypad to avoid inadvertent key entry.

### Procedure:

- 1  to access the menu.
- 2 ▲ or ▼ to Utilities and press  to select.
- 3 ▲ or ▼ to Radio Settings and press  to select.





- 4 ▲ or ▼ to Keypad Lock and press  to select.
- 5 The display shows Keypad Locked and returns to the Home screen.
- 6 To unlock the keypad, press  followed by .
- 7 The display shows Keypad Unlocked and returns to the Home screen.

**NOTE:** At Step 4, you can also use ◀ or ▶ to change the selected option.

### Language

You can set your radio display to be in your required language.

### Procedure:

- 1  to access the menu.
- 2 ▲ or ▼ to Utilities and press  to select.
- 3 ▲ or ▼ to Language and press  to select.
- 4 ▲ or ▼ to the required language and press  to enable.  
✓ appears beside selected language.

**NOTE:** At Step 4, you can also use ◀ or ▶ to change the selected option.



## Turning the LED Indicator On or Off

You can enable and disable the LED Indicator if needed.



### Procedure:

- 1  to access the menu.



---

- 2  or  to Utilities and press  to select.



---

- 3  or  to Radio Settings and press  to select.



---

- 4  or  to LED Indicator and press  to select.

---

- 5 Press  to enable LED indicator. The display shows ✓ beside Enabled.  
**OR**  
 Press  to disable LED indicator. The ✓ disappears from beside Enabled.

*The display backlight, buttons, and keypad backlighting are automatically turned off if the LED indicator is disabled (see **Controlling the Display Backlight** on page 86).*

**NOTE:** At Step 4, you can also use  or  to change the selected option.

## Turning the Voice Operating Transmission (VOX) Feature On or Off

This feature allows you to initiate a hands-free voice activated call on a programmed channel. The radio automatically

transmits, for a programmed period, whenever the microphone on the VOX-capable accessory detects voice.

Pressing the **PTT** button during radio operation disables VOX. To re-enable VOX, do **one** of the following:

- Turn the radio off and power it on again, **OR**
- Change the channel via the Channel Selector Knob, **OR**
- Follow the procedure below.

**NOTE:** Turning this feature on or off is limited to radios with this function enabled. Check with your dealer or system administrator for more information.

### Procedure:



Press the programmed **VOX** button to toggle the feature on or off.

### OR



Follow the procedure below.

- 1  to access the menu.



---

- 2  or  to Utilities and press  to select.

---

- 3  or  to Radio Settings and press  to select.

---

- 4  or  to VOX.

---

- 5 Press  to enable VOX. The display shows ✓ beside Enabled.  
**OR**

Press  to disable VOX. The ✓ disappears from beside Enabled.

---

If the Talk Permit Tone feature is enabled (see **Turning the Talk Permit Tone On or Off** on page 85), use a trigger word to initiate the call. Wait for the Talk Permit Tone to finish before speaking clearly into the microphone.

**NOTE:** At Step 4, you can also use ◀ or ▶ to change the selected option.

### **Turning the Option Board Feature(s) On or Off**

Option board capabilities within each channel and can be assigned to programmable buttons. Refer to your dealer or system administrator for more information.

#### **Procedure:**

Press the programmed **Option Board Feature** button to toggle the feature on or off.

### **Identifying Cable Type**

You can select the type of cable your radio uses.

#### **Procedure:**

1  to access the menu.

---

2 ▲ or ▼ to Utilities and press  to select.

---

3 ▲ or ▼ to Radio Settings and press  to select.

---

4 ▲ or ▼ to Cable Type and press  to select.

---

5 The current cable type is indicated by a ✓.

---

**NOTE:** At Step 4, you can also use ◀ or ▶ to change the selected option.

### **Voice Announcement**

This feature enables the radio to audibly indicate the current Zone or Channel the user has just assigned, or programmable button press. This audio indicator can be customized per customer requirements. This is typically useful when the user is in a difficult condition to read the content shown on the display.

Use the following features to toggle Voice Announcement on or off.

#### **Procedure:**

Press the programmed **Voice Announcement** button.

#### **OR**

Follow the procedure below.

1  to access the menu.

---

2 ▲ or ▼ to Utilities and press  to select.

---

3 ▲ or ▼ to Voice Announcement.

---

- 4 Press  to enable Voice Announcement. The display shows ✓ beside Enabled.

**OR**

Press  to disable Voice Announcement. The ✓ disappears from beside Enabled.

**NOTE:** At Step 3, you can also use ◀ or ▶ to change the selected option.

### Call Forwarding

You can enable your radio to automatically forward voice calls to another radio.

**Procedure:**

- 1  to access the menu.



---

  - 2 ▲ or ▼ to Utilities and press  to select.

---

  - 3 ▲ or ▼ to Call Forward.

---

  - 4 Press  to enable Call Forwarding. The display shows ✓ beside Enabled.
- OR**
- Press  to disable Call Forwarding. The ✓ disappears from beside Enabled.

**NOTE:** At Step 3, you can also use ◀ or ▶ to change the selected option.

### Menu Timer

Set the period of time your radio stays in the menu before it automatically switches to the Home screen.

**Procedure:**

- 1  to access the menu.

---

- 2 ▲ or ▼ to Utilities and press  to select.

---

- 3 ▲ or ▼ to Radio Settings and press  to select.

---

- 4 ▲ or ▼ to Menu Timer and press  to select.

---

- 5 ▲ or ▼ to the required setting and press  to enable.

### Analog Mic AGC

This feature controls the your radio's microphone gain automatically while transmitting on an analog system. It suppresses loud audio or boosts soft audio to a preset value in order to provide a consistent level of audio.

**Procedure:**

- 1  to access the menu.

---



- 2 ▲ or ▼ to Utilities and press  to select.

- 3 ▲ or ▼ to **Radio Settings** and press  to select.

---

- 4 ▲ or ▼ to **Analog Mic AGC**.

---

- 5 Press  to enable Analog Mic AGC. The display shows ✓ beside Enabled.  
**OR**  
Press  to disable Analog Mic AGC. The ✓ disappears from beside Enabled.

---

**NOTE:** At Step 3, you can also use ◀ or ▶ to change the selected option.

### **Digital Mic AGC**

This feature controls the your radio's microphone gain automatically while transmitting on an digital system. It suppresses loud audio or boosts soft audio to a preset value in order to provide a consistent level of audio.

#### **Procedure:**

- 1  to access the menu.

---

- 2 ▲ or ▼ to **Utilities** and press  to select.



---

- 3 ▲ or ▼ to **Radio Settings** and press  to select.

---

- 4 ▲ or ▼ to **Digital Mic AGC**.

---

- 5 Press  to enable Digital Mic AGC. The display shows ✓ beside Enabled.  
**OR**  
Press  to disable Digital Mic AGC. The ✓ disappears from beside Enabled.

---

**NOTE:** At Step 3, you can also use ◀ or ▶ to change the selected option.

### **Intelligent Audio**

Your radio automatically adjusts its audio volume to overcome current background noise in the environment, inclusive of both stationary and non-stationary noise sources. This feature is a Receive-only feature and does not affect Transmit audio.

Use the following features to toggle Intelligent Audio on or off.

#### **Procedure:**

Press the programmed **Intelligent Audio** button to toggle the feature on or off.

#### **OR**

Follow the procedure below.

- 1  to access the menu.

---

- 2 ▲ or ▼ to **Utilities** and press  to select.

---

- 3 ▲ or ▼ to **Radio Settings** and press  to select.

---

4 ▲ or ▼ to Intelligent Audio.

5 Press  to enable Intelligent Audio. The display shows ✓ beside Enabled.

**OR**

Press  to disable Intelligent Audio. The ✓ disappears from beside Enabled.

**NOTE:** At Step 3, you can also use ◀ or ▶ to change the selected option.

## GPS

Global Positioning System (GPS) is a satellite navigation system that determines the radio's precise location.

It is recommended you only disable GPS to save battery life when the GPS signal is unavailable.

### Procedure:

Press the programmed **GPS** button to toggle the feature on or off.

**OR**

1  to access the menu.

2 ▲ or ▼ to Utilities and press  to select.

3 ▲ or ▼ to Radio Settings and press  to select.

4 ▲ or ▼ to GPS.

5 Press  to enable GPS. The display shows ✓ beside Enabled.

**OR**

Press  to disable GPS. The ✓ disappears from beside Enabled.



See **Checking the GPS Information** on page 94 for details on retrieving GPS information.

**NOTE:** At Step 4, you can also use ◀ or ▶ to change the selected option.

## Accessing General Radio Information

Your radio contains information on the following:

- Battery
- Radio Alias and ID 
- Firmware and Codeplug Versions
- GPS Information

**NOTE:** Press  at any time to return to the previous screen or long press  to return to the Home screen. The radio exits the current screen once the inactivity timer expires.

## **Accessing the Battery Information**

Displays information on your radio battery.

### **Procedure:**

- 1  to access the menu.

---

- 2 ▲ or ▼ to Utilities and press  to select.

---

- 3 ▲ or ▼ to Radio Info and press  to select.

---

- 4 ▲ or ▼ to Battery Info and press  to select.

---

- 5 The display shows the battery information.  
**OR**  
 For **IMPRES** batteries **ONLY**: The display reads Recondition Battery if the battery requires reconditioning in an IMPRES charger. After the reconditioning process, the display then shows the battery information.

## **Checking the Radio Alias and ID**

Displays the ID of your radio.

### **Procedure:**

Press the programmed Radio Alias and ID button to check your radio alias and ID. You hear a positive indicator tone.

**OR**

Follow the procedure below.

- 1  to access the menu.

---

- 2 ▲ or ▼ to Utilities and press  to select.

---

- 3 ▲ or ▼ to Radio Info and press  to select.

---

- 4 ▲ or ▼ to My Number and press  to select.

---

- 5 The first line of the display shows the radio alias. The second line of the display shows the radio ID

*You can also press the programmed **Radio Alias and ID** button to return to the previous screen.*

## **Checking the Firmware Version and Codeplug Version**

Displays the firmware and codeplug versions on your radio.

### **Procedure:**

- 1  to access the menu.

---

- 2 ▲ or ▼ to Utilities and press  to select.

---

- 3 ▲ or ▼ to Radio Info and press  to select.

---

- 4 ▲ or ▼ to Versions and press  to select.

---

- 5 The display shows the current firmware and codeplug versions.



## ☞ **Checking the GPS Information**

Displays the GPS information on your radio, such as values of:

- Latitude
- Longitude
- Altitude
- Direction
- Velocity
- Horizontal Dilution of Precision (HDOP)
- Satellites
- Version

### **Procedure:**

- 1  to access the menu.

---

- 2 ▲ or ▼ to **Utilities** and press  to select.

---

- 3 ▲ or ▼ to **Radio Info** and press  to select.

---

- 4 ▲ or ▼ to **GPS Info** and press  to select.

---

- 5 ▲ or ▼ to the required item and press  to select.

---

- 6 The display shows the requested GPS information.

---

See **GPS** on page 92 for details on GPS.

## ■ **Front Panel Configuration (FPC)**

Your radio is able to customize certain feature parameters to enhance the use of your radio.

### ☞ **Entering FPC Mode**

#### **Procedure:**

- 1  to access the menu.

---

- 2 ▲ or ▼ to **Utilities** and press  to select.

---

- 3 ▲ or ▼ to **Program Radio** and press  to select.

---

**NOTE:** Long press  at any time to return to the Home screen.

### ☞ **Editing FPC Mode Parameters**

Use the following buttons as required while navigating through the feature parameters.

▲, ▼, ◀, ▶ – Scroll through options, increase/decrease values, or navigate vertically

 – Select the option or enter a sub-menu

 – Short-press to return to previous menu or to exit the selection screen. Long-press to return to Home screen.



## Accessories

Your radio is compatible with the accessories listed in this chapter. Contact your dealer for details.

Antennas . . . . .	page 94
Batteries . . . . .	page 94
Carry Devices . . . . .	page 95
Chargers . . . . .	page 95
Headsets and Headset Accessories . . . . .	page 96
Remote Speaker Microphones . . . . .	page 96
Miscellaneous Accessories . . . . .	page 96

## Antennas

- UHF, 403-470MHz, Whip Antenna EX (PMAE4085\_)
- UHF, 403-433MHz, GPS Folded Monopole Antenna EX (PMAE4081\_)
- UHF, 430-470MHz, GPS Folded Monopole Antenna EX (PMAE4082\_)
- UHF, 403-433MHz, GPS Stubby Antenna EX (PMAE4083\_)
- UHF, 430-470MHz, GPS Stubby Antenna EX (PMAE4084\_)
- VHF, 136-174MHz, Double Helical Antenna EX (PMAD4132\_)
- VHF, 136-147MHz, GPS Helical Antenna EX (PMAD4126)
- VHF, 147-160MHz, GPS Helical Antenna EX (PMAD4127\_)
- VHF, 160-174MHz, GPS Helical Antenna EX (PMAD4128\_)
- VHF, 136-147MHz, GPS Stubby Antenna EX (PMAD4129\_)
- VHF, 147-160MHz, GPS Stubby Antenna EX (PMAD4130\_)
- VHF, 160-174MHz, GPS Stubby Antenna EX (PMAD4131\_)

## Batteries

- MOTOTRBO CSA/IECEX/ATEX IMPRES Li-Ion, 2075mA (NNTN8359\_)

## ■ Carry Devices

---

- 2.5-Inch Replacement Swivel Belt Loop (PMLN5610\_)
- Hard Leather Carry Case with 2.5-Inch Swivel Belt Loop for Full-Keypad Radio (PMLN6097\_)
- Soft Leather Carry Case with 2.5-Inch Swivel Belt Loop for Full-Keypad Radio (PMLN6099\_)
- Belt Clip for 2.5-Inch Belt Width (PMLN6086\_)

## ■ Chargers

---

- IMPRES Single-Unit Charger (WPLN4226\_)
- IMPRES Single-Unit Charger with Switch Mode Power Supply EU Cord (WPLN4255\_)
- IMPRES Single-Unit Charger with Switch Mode Power Supply UK Cord (WPLN4254\_)
- IMPRES Single-Unit Charger with Switch Mode Power Supply PRC Cord (WPLN4245\_)
- IMPRES Single-Unit Charger with Switch Mode Power Supply KOR Cord (WPLN4249\_)
- IMPRES Single-Unit Charger with Switch Mode Power Supply AU Cord (WPLN4256\_)
- IMPRES Single-Unit Charger with Switch Mode Power Supply JP Cord (WPLN4247\_)
- IMPRES Single-Unit Charger with Switch Mode Power Supply US Cord (WPLN4253\_)
- IMPRES Multi-Unit Charger with Display (WPLN4218\_)
- IMPRES Multi-Unit Charger non Display - Euro Plug (WPLN4213\_)
- IMPRES Multi-Unit Charger with Display - Euro Plug (WPLN4220\_)
- IMPRES Multi-Unit Charger non Display - UK Plug (WPLN4214\_)
- IMPRES Multi-Unit Charger with Display - UK Plug (WPLN4221\_)
- IMPRES Multi-Unit Charger non Display - AU Plug (WPLN4215\_)
- IMPRES Multi-Unit Charger with Display - AU Plug (WPLN4222\_)
- IMPRES Multi-Unit Charger non Display - KOR Plug (WPLN4217\_)
- IMPRES Multi-Unit Charger with Display - KOR Plug (WPLN4224\_)
- IMPRES Multi-Unit Charger non Display - NAG (WPLN4212\_)
- IMPRES Multi-Unit Charger with Display - NAG (WPLN4219\_)

## ■ Headsets and Headset Accessories

---

- IS Approved Standard Headset with Head Band (PMLN6087\_)
- IS Approved Standard Headset with Helmet Attachment (PMLN6092\_)
- IS Approved Twin Cup Headset with Helmet Attachment (PMLN6333\_)
- IS Approved Level Dependent Headset with Head Band (PMLN6090\_)
- IS Approved Level Dependent Headset with Helmet Attachment (PMLN6089\_)
- IS Approved MOTOTRBO Adapter, 4-pole Nexus (PMLN6368\_)

## ■ Remote Speaker Microphones

---

- IMPRES ATEX CSA Remote Speaker Microphone (PMMN4067\_)

## ■ Miscellaneous Accessories

---

- Universal Connector Dust Cover for MOTOTRBO ATEX CSA (15012157001)
- ATEX Adapter with Molex Jack (PMLN6047\_)

## Batteries and Chargers Warranty

### The Workmanship Warranty

The workmanship warranty guarantees against defects in workmanship under normal use and service.

All MOTOTRBO Batteries	Two (2) Years
IMPRES Chargers (Single-Unit and Multi-Unit, Non-Display)	Two (2) Years
IMPRES Chargers (Multi-Unit with Display)	One (1) Year

### The Capacity Warranty

The capacity warranty guarantees 80% of the rated capacity for the warranty duration.

MOTOTRBO CSA/IECEEx/ATEX Lithium-Ion IMPRES Batteries	18 Months
IMPRES Batteries, When Used Exclusively with IMPRES Chargers	18 Months

# Limited Warranty

## MOTOROLA COMMUNICATION PRODUCTS

### I. WHAT THIS WARRANTY COVERS AND FOR HOW LONG:

MOTOROLA SOLUTIONS, INC. ("MOTOROLA") warrants the MOTOROLA manufactured Communication Products listed below ("Product") against defects in material and workmanship under normal use and service for a period of time from the date of purchase as scheduled below:

XPR Series Digital Portable Radios	Two (2) Years
Product Accessories (Excluding Batteries and Chargers)	One (1) Year

MOTOROLA, at its option, will at no charge either repair the Product (with new or reconditioned parts), replace it (with a new or reconditioned Product), or refund the purchase price of the Product during the warranty period provided it is returned in accordance with the terms of this warranty. Replaced parts or boards are warranted for the balance of the original applicable warranty period. All replaced parts of Product shall become the property of MOTOROLA.

This express limited warranty is extended by MOTOROLA to the original end user purchaser only and is not assignable or transferable to any other party. This is the complete warranty for the Product manufactured by MOTOROLA. MOTOROLA assumes no

obligations or liability for additions or modifications to this warranty unless made in writing and signed by an officer of MOTOROLA.

Unless made in a separate agreement between MOTOROLA and the original end user purchaser, MOTOROLA does not warrant the installation, maintenance or service of the Product.

MOTOROLA cannot be responsible in any way for any ancillary equipment not furnished by MOTOROLA which is attached to or used in connection with the Product, or for operation of the Product with any ancillary equipment, and all such equipment is expressly excluded from this warranty. Because each system which may use the Product is unique, MOTOROLA disclaims liability for range, coverage, or operation of the system as a whole under this warranty.

### II. GENERAL PROVISIONS:

This warranty sets forth the full extent of MOTOROLA'S responsibilities regarding the Product. Repair, replacement or refund of the purchase price, at MOTOROLA'S option, is the exclusive remedy. THIS WARRANTY IS GIVEN IN LIEU OF ALL OTHER EXPRESS WARRANTIES. IMPLIED WARRANTIES, INCLUDING WITHOUT LIMITATION, IMPLIED WARRANTIES OF MERCHANTABILITY AND FITNESS FOR A PARTICULAR PURPOSE, ARE LIMITED TO THE DURATION OF THIS LIMITED WARRANTY. IN NO EVENT SHALL MOTOROLA BE LIABLE FOR DAMAGES IN EXCESS OF THE PURCHASE PRICE OF THE PRODUCT, FOR ANY LOSS OF USE, LOSS OF TIME, INCONVENIENCE, COMMERCIAL LOSS, LOST PROFITS OR SAVINGS OR OTHER INCIDENTAL, SPECIAL OR CONSEQUENTIAL DAMAGES ARISING OUT OF THE USE OR

INABILITY TO USE SUCH PRODUCT, TO THE FULL EXTENT SUCH MAY BE DISCLAIMED BY LAW.

### III. STATE LAW RIGHTS:

SOME STATES DO NOT ALLOW THE EXCLUSION OR LIMITATION OF INCIDENTAL OR CONSEQUENTIAL DAMAGES OR LIMITATION ON HOW LONG AN IMPLIED WARRANTY LASTS, SO THE ABOVE LIMITATION OR EXCLUSIONS MAY NOT APPLY.

This warranty gives specific legal rights, and there may be other rights which may vary from state to state.

### IV. HOW TO GET WARRANTY SERVICE:

You must provide proof of purchase (bearing the date of purchase and Product item serial number) in order to receive warranty service and, also, deliver or send the Product item, transportation and insurance prepaid, to an authorized warranty service location. Warranty service will be provided by MOTOROLA through one of its authorized warranty service locations. If you first contact the company which sold you the Product (e.g., dealer or communication service provider), it can facilitate your obtaining warranty service. **You can also call MOTOROLA at 1-800-927-2744 US/Canada.**

### V. WHAT THIS WARRANTY DOES NOT COVER:

- A) Defects or damage resulting from use of the Product in other than its normal and customary manner.
- B) Defects or damage from misuse, accident, water, or neglect.

- C) Defects or damage from improper testing, operation, maintenance, installation, alteration, modification, or adjustment.
- D) Breakage or damage to antennas unless caused directly by defects in material workmanship.
- E) A Product subjected to unauthorized Product modifications, disassembles or repairs (including, without limitation, the addition to the Product of non-MOTOROLA supplied equipment) which adversely affect performance of the Product or interfere with MOTOROLA's normal warranty inspection and testing of the Product to verify any warranty claim.
- F) Product which has had the serial number removed or made illegible.
- G) Rechargeable batteries if:
  - (1) any of the seals on the battery enclosure of cells are broken or show evidence of tampering.
  - (2) the damage or defect is caused by charging or using the battery in equipment or service other than the Product for which it is specified.
- H) Freight costs to the repair depot.
- I) A Product which, due to illegal or unauthorized alteration of the software/firmware in the Product, does not function in accordance with MOTOROLA's published specifications or the FCC certification labeling in effect for the Product at the time the Product was initially distributed from MOTOROLA.
- J) Scratches or other cosmetic damage to Product surfaces that does not affect the operation of the Product.
- K) Normal and customary wear and tear.



## VI. PATENT AND SOFTWARE PROVISIONS:

MOTOROLA will defend, at its own expense, any suit brought against the end user purchaser to the extent that it is based on a claim that the Product or parts infringe a United States patent, and MOTOROLA will pay those costs and damages finally awarded against the end user purchaser in any such suit which are attributable to any such claim, but such defense and payments are conditioned on the following:

- A) that MOTOROLA will be notified promptly in writing by such purchaser of any notice of such claim;
- B) that MOTOROLA will have sole control of the defense of such suit and all negotiations for its settlement or compromise; and
- C) should the Product or parts become, or in MOTOROLA's opinion be likely to become, the subject of a claim of infringement of a United States patent, that such purchaser will permit MOTOROLA, at its option and expense, either to procure for such purchaser the right to continue using the Product or parts or to replace or modify the same so that it becomes non-infringing or to grant such purchaser a credit for the Product or parts as depreciated and accept its return. The depreciation will be an equal amount per year over the lifetime of the Product or parts as established by MOTOROLA.

MOTOROLA will have no liability with respect to any claim of patent infringement which is based upon the combination of the Product or parts furnished hereunder with software, apparatus or devices not furnished by MOTOROLA, nor will MOTOROLA have any liability for the use of ancillary equipment or software not furnished by MOTOROLA which is attached to or used in connection with the Product. The foregoing states the entire liability of MOTOROLA with

respect to infringement of patents by the Product or any parts thereof.

Laws in the United States and other countries preserve for MOTOROLA certain exclusive rights for copyrighted MOTOROLA software such as the exclusive rights to reproduce in copies and distribute copies of such MOTOROLA software. MOTOROLA software may be used in only the Product in which the software was originally embodied and such software in such Product may not be replaced, copied, distributed, modified in any way, or used to produce any derivative thereof. No other use including, without limitation, alteration, modification, reproduction, distribution, or reverse engineering of such MOTOROLA software or exercise of rights in such MOTOROLA software is permitted. No license is granted by implication, estoppel or otherwise under MOTOROLA patent rights or copyrights.

## VII. GOVERNING LAW:

This Warranty is governed by the laws of the State of Illinois, U.S.A.

---

## Notes