

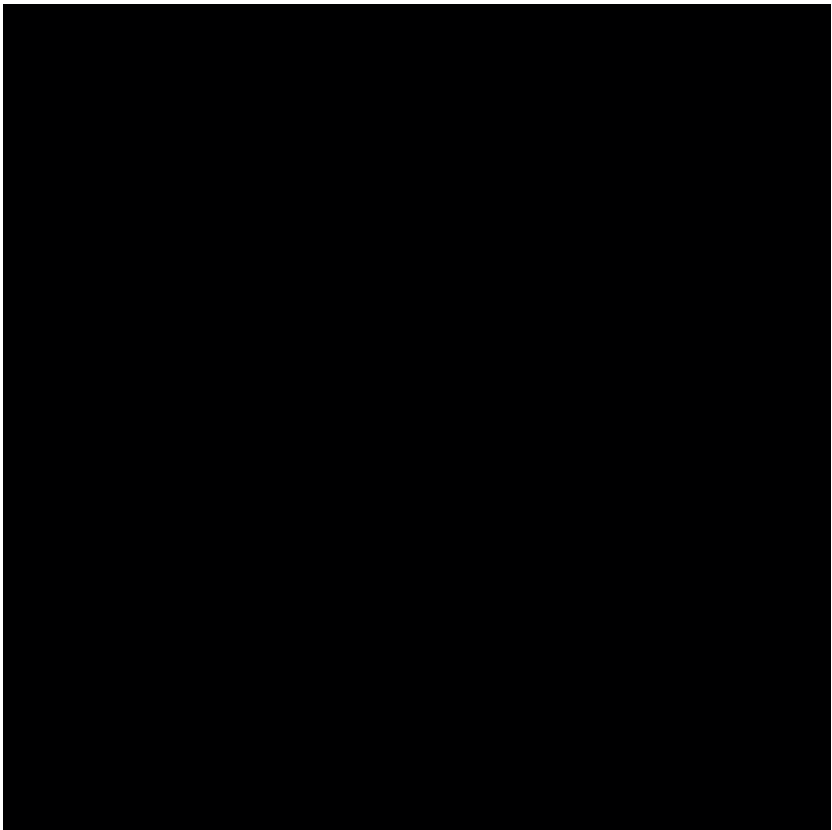

AURA

AURA™ R1 by Motorola
User's Guide





Introducing your new **AURA™** R1 by Motorola. Here's a quick anatomy lesson.

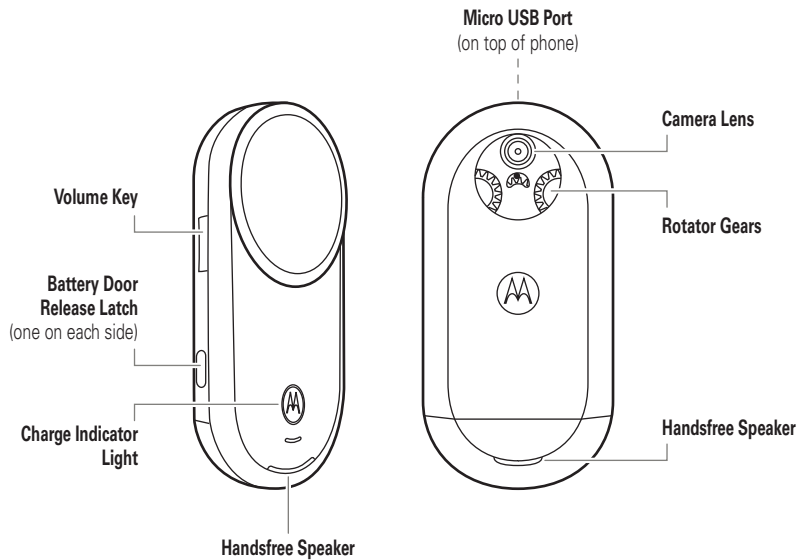

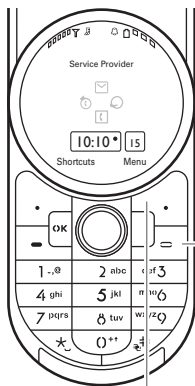

Home Screen



1 Press & hold  until the display lights up, to turn on your phone.

2 Press the **Menu** soft key to open the main menu.

Main Menu

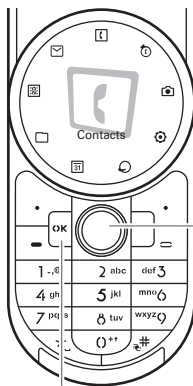

3 Press   left/right to scroll to a menu feature.

4 Press  to select it.

Note: This is the standard home screen and main menu layout. **Your phone's home screen and main menu may be different.** To change your home screen shortcuts and main menu appearance, see page 36.

CONTENTS

MENU MAP	7	VUFONE SERVICE	22
Cleaning	9	Register for vufone Service	22
Shock	10	Move Files from Your	
Temperature	10	Old Phone to Your AURA	22
Avoid Contact	10	Manage Your Phone Data	23
Use and Care	11	Back Up Your Phone	23
GET STARTED	12	Upload Media Files	23
About This Guide	12	vufone on the Web	24
Insert Your SIM Card	13	Service Eligibility	24
Battery	14	BASICS	25
Extend Battery Life	17	Display	25
Open & Close the Blade	18	Volume	27
Turn Phone On & Off	19	Voice Commands	27
Make a Call	19	Talking Phone	29
Answer a Call	19	Handsfree Speaker	29
End a Call	19	Codes & Passwords	30
Store a Phone Number	19	Lock & Unlock Phone	30
Call a Stored Number	19	Lock Your SIM Card or Applications ..	31
Your Phone Number	20		
Shortcuts	21		

PERSONALIZE	32	TEXT ENTRY	47
Alert Styles	32	Word Mode	48
Themes	33	ABC Mode	49
Time & Date	35	Numeric Mode	49
Clock Style	35	Symbol Mode	50
Wallpaper	35	MESSAGES	51
Screensaver	36	Voicemail	51
Home Screen Shortcuts	36	Text Messages	51
Display Appearance	37	More Messaging Features	53
More Personalizing Features	37	ENTERTAINMENT	55
CALLS	39	Camera	55
Turn Off a Call Alert	39	Videos	60
Recent Calls	39	Music	64
Redial	39	Browser	73
Return a Call	40	Fun & Games	75
Caller ID	40	TOOLS	76
Emergency Calls	40	Contacts	76
Handsfree	41	Personal Organizer	80
Answer Options	42		
Call Times & Costs	42		
More Calling Features	43		

CONNECTIONS	84
Bluetooth® Wireless	84
Cable Connections	88
Sync	90
File Manager	90
Phone Software Updates	91
SERVICE & REPAIRS	92
SAR Data	93
EU Conformance	95
OSS Information	96
INDEX	97

Main Menu



Contacts



Recent Calls



Camera



Settings

- (see next page)



Web Access

- Browser
- My Bookmarks
- My Web Pages
- History
- Go to URL
- Browser Setup



Calendar



Office Tools

- World Clock
- Help
- vufone
- Motorola SETUP
- Alarm Clock
- Calculator
- Sync
- Download Manager
- File Manager
 - Extended Memory
 - Music and Sounds
 - Pictures
 - Videos
 - Voice Notes
 - Application Downloads
 - Unrecognizable Files
 - My Documents
- Dialing Services
- Task List
- Notes



Multimedia

- Media Finder
- Games
- Camera
- Video Camera
- Voice Recorder
- Pictures
- Videos



Messages

- Create Message
- Inbox
- My Folders
- Templates
- Drafts
- Outbox
- Email
- Call Voicemail

This is the standard main menu layout. **Your phone's menu may be different.**

Tip: Press to back out of the current menu, or press to exit menus.

Settings Menu

- **Profiles**
- **Themes**
- **Home Screen**
 - NavKey Shortcuts
 - Change Wallpaper
 - External Clock Style
- **Connections**
 - Bluetooth®
 - USB Setting
 - Media Synchronization
 - Extended Memory
 - Modem
 - USB Printing
 - Voice Networks *
 - Data Connections
 - Add a Connection
 - Edit a Connection
 - Remove a Connection
- **Call Settings**
 - Speed Dial
 - Call Forward
 - In-Call Setup
 - Hearing Aid
 - In-Call Timer
 - Answer Options
 - In-Call Message Alert
 - Roam Alert
 - Call Waiting
 - Auto-Redial
 - Call Drop Tone
 - Dialing Setup
 - My Caller ID
 - DTMF
 - Dialing Prefix
 - Call Barring *
 - Fixed Dialing
 - My SIM Number
 - Active Line *
- **Phone Settings**
 - Display Settings
 - Display Timeout
 - Screensaver
 - Brightness
 - Airplane Mode
 - Battery Meter
 - Time & Date
 - Language
 - **(continued next column)**
- **Phone Settings (continued)**
 - Talking Phone
 - Text Entry
 - Reset
 - Reset All Settings
 - Delete All Data
 - Delete Memory Device
 - View Memory
 - Properties
 - Legal Notices
 - Java™ System
 - OTA Updates
 - Headset Settings
 - Auto-Answer
 - Voice Dial
 - TTY Settings *
- **Security**
 - Phone Lock
 - Application Lock
 - SIM Lock
 - Change Passwords
 - Certificates
- **Network**
 - Current Network
 - Scan Available Networks
 - Find New Network
 - My Network List
 - Search Setup
 - Service Tone

* optional features

Your **AURA** is a highly valuable mobile device with a superior design, and should be treated with care. This section provides some basic recommendations to protect it. Proper maintenance of your phone will ensure an extended life.

Cleaning

Use the provided soft micro-fiber cleaning cloth to clean your phone. Wrap the cloth around the device, and apply light pressure in a circular motion to clean the sapphire crystal lens, the main stainless steel housing and battery door, and the polished edges. This will remove dust, grease, oil, make-up, and any other residue that may have been deposited as a result of the normal use of your phone. Repeat as needed.

Use pressurized air or a soft toothbrush to gently clean the speaker and earpiece gaps. **AURA's** rotator mechanism is sealed and has been carefully designed. There is no need to clean the rotator mechanism. Do not attempt to open the device other than as instructed in this guide, as this could damage the phone's operation. Please contact an **AURA** service representative should you need further information or assistance.

Important Note: Never use liquid cleaners, as they can damage the phone's electronic circuits and protective coatings. **AURA** is not water resistant, and you should avoid contact with liquids.

Shock

We recommend you use the provided leather carrying case to protect your phone at all times. The sapphire crystal lens and stainless steel components are highly scratch resistant, but take care not to expose the phone to hard or abrasive materials and high impact activities or sports.

Temperature

Try to avoid exposing your **AURA** to severe temperatures for extended periods of time. Extreme heat tends to shorten the battery life, while extreme cold can cause the electronic circuits to stop working accurately.

Avoid Contact

Do not expose **AURA** to any liquids. Avoid contact with chemicals, solvents, or gases as these may cause discoloration, deterioration, or other forms of damage to your phone. **AURA** is not made to withstand extreme electric fields or static electricity. However, common household appliances do not pose a threat to your phone.

Remember that your **AURA** will last longer if you take proper care of it.

To care for your Motorola phone, please keep it away from:



liquids of any kind

Don't expose your phone to water, rain, extreme humidity, sweat, or other moisture. If it does get wet, don't try to accelerate drying with the use of an oven or dryer, as this may damage the phone.



dust and dirt

Don't expose your phone to dust, dirt, sand, food, or other inappropriate materials.



extreme heat or cold

Avoid temperatures below 0°C/32°F or above 45°C/113°F.



cleaning solutions

To clean your phone, use only a dry soft cloth. Don't use alcohol or other cleaning solutions.



microwaves

Don't try to dry your phone in a microwave oven.



the ground

Don't drop your phone.





CAUTION: Before using the phone for the first time, read the *Important Safety and Legal Information* guide included in the box.

About This Guide

This guide shows how to locate a menu feature as follows:

Find it: Menu >  Messages
> Create Message

This means that, from the home screen:

- 1 Press the **Menu** soft key to open the menu.
- 2 Press the *navigation key*  to scroll to  **Messages**, and press  to select it.
- 3 Press  to scroll to **Create Message**, and press  to select it.

This guide uses the following symbols:

symbols



This means a feature is network, SIM card, or subscription dependent and may not be available in all areas. Contact your service provider for more information.



This means a feature requires an optional accessory.

Insert Your SIM Card

Your *Subscriber Identity Module* (SIM) card stores your phone number and other information.

Caution: Don't bend or scratch your SIM card. Keep it away from static electricity, water, and dirt.

1

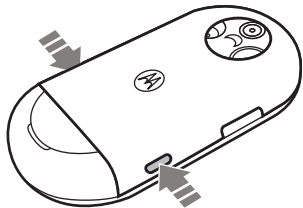

2

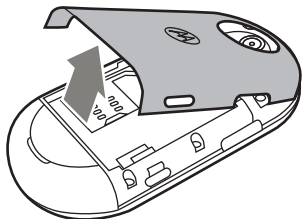

3

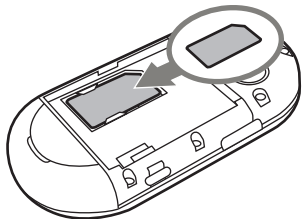

Battery

Battery Use & Safety

IMPORTANT: HANDLE AND STORE BATTERIES PROPERLY TO AVOID INJURY OR DAMAGE.

Most battery issues arise from improper handling of batteries, and particularly from the continued use of damaged batteries.

DON'Ts

- **Don't disassemble, crush, puncture, shred, or otherwise attempt to change the form of your battery.**
- **Don't let the phone or battery come in contact with water.** Water can get into the phone's circuits, leading to corrosion. If the phone and/or battery get wet, have them checked by your carrier or contact Motorola, even if they appear to be working properly.
- **Don't allow the battery to touch metal objects.** If metal objects, such as jewelry, stay in prolonged contact with the battery contact points, the battery could become very hot.
- **Don't place your battery near a heat source.** Excessive heat can damage the phone or the battery. High temperatures can cause the battery to swell, leak, or malfunction. Therefore:
 - Do **not** dry a wet or damp battery with an appliance or heat source, such as a hair dryer or microwave oven.
 - Avoid leaving your phone in your car in high temperatures.

DOs

- **Do avoid dropping the battery or phone.** Dropping these items, especially on a hard surface, can potentially cause damage.
- **Do contact your service provider or Motorola if your phone or battery has been damaged from dropping or high temperatures.**

IMPORTANT: USE MOTOROLA ORIGINAL PRODUCTS FOR QUALITY ASSURANCE AND SAFEGUARDS. To aid consumers in identifying authentic Motorola batteries from non-original or counterfeit batteries (that may not have adequate safety protection), Motorola provides holograms on its batteries. Consumers should confirm that any battery they purchase has a “Motorola Original” hologram.

Motorola recommends you always use Motorola-branded batteries and chargers.

Motorola mobile devices are designed to work with Motorola batteries. If you see a message on your display such as **Invalid Battery or Unable to Charge**, take the following steps:

- Remove the battery and inspect it to confirm that it has a “Motorola Original” hologram;
- If there is no hologram, the battery is not a Motorola battery;
- If there is a hologram, replace the battery and retry charging it;
- If the message remains, contact a Motorola Authorized Service Center.

Important: Motorola’s warranty does not cover damage to the phone caused by non-Motorola batteries and/or chargers.

Warning: Use of a non-Motorola battery or charger may present a risk of fire, explosion, leakage, or other hazard.

PROPER AND SAFE BATTERY DISPOSAL AND RECYCLING

Proper battery disposal is not only important for safety, it benefits the environment. Consumers may recycle their used batteries in many retail or service provider locations. Additional information on proper disposal and recycling may be found on the Web:

- www.motorola.com/recycling
- www.rbric.org/call2recycle/
(in English only)

Disposal: Promptly dispose of used batteries in accordance with local regulations. Contact your local recycling center or national recycling organizations for more information on how to dispose of batteries.



Warning: Never dispose of batteries in a fire because they may explode.

Insert the Battery

1

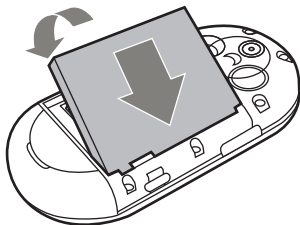

2

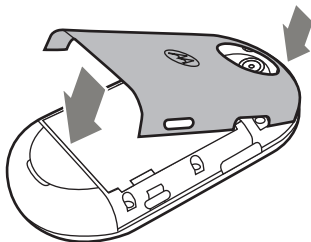

Charge the Battery

New batteries are not fully charged. Plug the battery charger into your phone and an electrical outlet. The battery charge indicator light on your phone shows when the battery is charging. The display shows **Charge Complete** when finished.

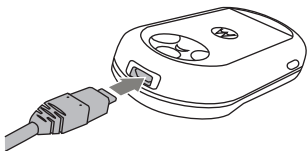

Notes for charging your phone's battery:

- When charging your battery, keep it near room temperature. Never expose batteries to temperatures below 0°C (32°F) or above 45°C (113°F) when charging.
- New batteries are not fully charged.

- New batteries or batteries stored for a long time may take more time to charge.
- Motorola batteries and charging systems have circuitry that protects the battery from damage from overcharging.

Note: You can charge your battery by connecting a cable from your phone's micro USB port to a USB port on a computer. Both your phone and the computer must be turned on, and your computer must have the correct software drivers installed. A Motorola Original USB cable and supporting software may be included with your phone. These tools are also sold separately.



Extend Battery Life

- Avoid excessive opening and closing of the blade, as each rotation activates the display.

- Turn off **Bluetooth®** power when you're not using it: Press **Menu** > **Settings** > **Connections** > **Bluetooth**, press **Options** > **Setup Bluetooth** > **Bluetooth Power** > **Off**.
- Set your **display** to turn off sooner: Press **Menu** > **Settings** > **Phone Settings** > **Display Settings** > **Display Timeout** > **5 Seconds**.
- Turn off your **screensaver**: Press **Menu** > **Settings** > **Phone Settings** > **Display Settings** > **Screensaver** > **Off**.
- Reduce the display **brightness**: Press **Menu** > **Settings** > **Phone Settings** > **Display Settings** > **Brightness**, and select a lower number setting.

Open & Close the Blade

Slide the blade left or right to open. Slide the blade in the opposite direction to close.

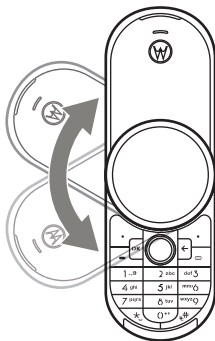

Close the blade on the same side you opened it. For example, if you slide the blade clockwise to open, slide it counter-clockwise to close.

Note: Repeatedly opening and closing the blade can inadvertently answer and end an incoming call, resulting in a missed call.

Turn Phone On & Off

Open the blade, then press and hold the *power/end key*  until the display turns on or off.

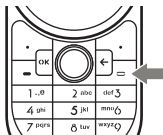

Make a Call

Open the blade, then enter a phone number and press the *send key* .

Tip: To **voice dial** a call, see page 28.

Answer a Call

When your phone rings and/or vibrates, open the blade or press  to answer.

End a Call

To hang up, close the blade or press .

Store a Phone Number

You can store a phone number in your **Contacts** list.

- 1 Enter a phone number in the home screen.
- 2 Press **Save**.
- 3 Enter a name for the phone number.
- 4 Press **Save** to store the contact.

To edit or store additional information about the contact, see page 78.

Call a Stored Number

To call a phone number stored in your **Contacts** list:

From the home screen, press keypad keys to enter the first letters of the contact name (one keypress per letter). The phone shows the contact name(s) that match your

keypresses. For example, if you press the letters d-a-n, your display might show:

Press the letters d-a-n
(keypad keys **3**-**2**-**6**).

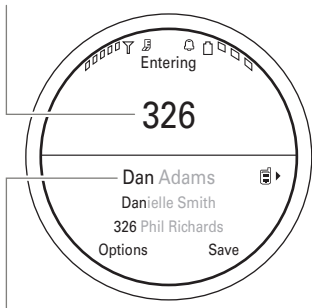

Press **↑** up/down to scroll to the contact you want. Press **☎** to call.

Note: If you've got contacts stored on your SIM card, but the contacts aren't visible when you open the contact list, you'll need to copy the contacts into phone memory.

Press **☎** > **☎** Contacts, press Options > Import Contacts > SIM Card, press Options > Select All, then press Import.

Your Phone Number

To see your phone number:

Find it: Menu > **⚙** Settings > Call Settings > My SIM Number

To see your phone number while you're on a call, press Options > My Telephone Number.

To store or edit your name and phone number on your SIM card, select the field you want to edit. If you don't know your phone number, contact your service provider.

Shortcuts

Your phone provides shortcuts to some frequently-used features. You can use the following shortcuts from the home screen.

To...	Do this...
view missed call and message notifications	Press Shortcuts > View Notifications.
take a picture	Press Shortcuts > Take Picture.
set an alarm	Press Shortcuts > Set Alarm.
change clock style (blade closed)	Press Shortcuts > Clock Style.
go to the dialed calls list	Press  .

Note: The **Shortcuts** list on your phone may include additional shortcuts or different shortcuts, depending on your service provider.

You can use the vufone service to easily transfer contacts from your previous phone to your new **AURA**, maintaining a safe copy of the information on a personal and protected Web portal.



Register for vufone Service

Find it: Menu >  Office Tools > vufone

vufone prompts you to accept the service terms and conditions. You'll need to accept the terms and conditions to register your phone. When you register, vufone sends you a text message with your service password.

To complete the registration process, use your computer browser to go to the vufone website at www.vufone.com. Your account **username** for logging on to the service is your international country code and phone number.

Move Files from Your Old Phone to Your AURA

Use vufone to move contacts, calendar, photos, videos, and music from your old phone to your new phone.

- 1 Insert your SIM card into your old phone.
- 2 On your computer, log onto the vufone Web site at www.vufone.com.
- 3 Select Download Mobile Application to send the vufone application to the old phone in a text message.
- 4 When you receive the text message on the old phone, select the link in the message to download, and install the vufone application on the phone.
- 5 Open the vufone application on the old phone, then press **Options > Settings** to select the types of content you want to back up.

- 6 Select **Backup** to upload the selected files to your vufone Web portal.
- 7 Remove the SIM card from the old phone and insert it in your new **AURA**.
- 8 Open the vufone application on your new phone, and select **Restore** to transfer the files to the new phone.

For a complete list of supported mobile devices, please see www.vufone.com.

Manage Your Phone Data

You can use your personal Web portal to manage the personal information on your phone. vufone lets you back up, edit, and restore your phone's contacts, calendar, pictures, videos, and music from the Web portal.

With vufone, you can upload and share your phone's photos and videos on the Web, listen to your music on the Web, download Web pictures and videos to your phone, and more.

Back Up Your Phone

To **back up** the contents of your phone to the Web portal:

Find it: Menu > Office Tools > vufone > Synchronize

To select the **types of content** you want to synchronize between your phone and Web portal, press **Options > Settings**.

Upload Media Files

To upload photos, videos, or music to your Web portal, you'll need to select these file types for synchronization.

Tip: You can also selectively choose files to upload.

Find it: Menu > Office Tools > vufone > Upload Files

- 1 Choose the categories of files you want to upload: **Images, Video, Music, and/or Docs**.

- 2 Press **Options > Upload** or **Upload & Delete** to copy or move your files to the vufone Web site.

vufone on the Web

Through the vufone Web site (www.vufone.com), you can:

- Manage, edit, and search your phone's contacts.
- Manage your mobile photos and videos, and send them to your contacts.
- Listen to your mobile music online over the Web.

The vufone service includes additional personalization options to let you express yourself and manage how others see you:

- Select the picture your contacts see when you call them.
- Upload your photos and videos to other Web sites.

- Synchronize your contacts and calendar with other Web sites.
- Post your mobile media files to the Web on a personalized myPage blog.

Service Eligibility

The vufone service's content backup and management features are provided free of charge. Some more advanced features are provided for a modest service subscription fee. Please see the vufone Web site at www.vufone.com for more details.

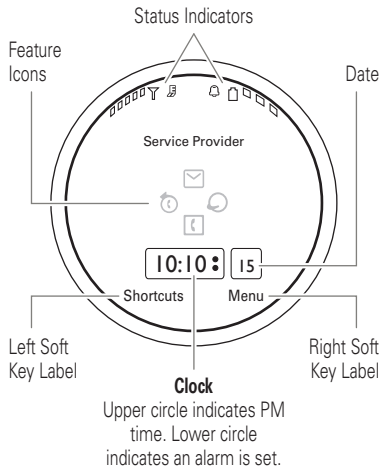

Display

The *home screen* appears when you turn on the phone.





Note: Your home screen may look different, depending on your service provider.

To dial a number from the home screen, press number keys and .

From the home screen, press the **Menu** soft key or  to open the main menu. When a menu is open, press  to go back one menu. Press  to exit all menus and return to the home screen.



Press **Shortcuts** to access some frequently-used phone features.

Press the *navigation key*  up, down, left, or right in the home screen to open basic features. To show, hide, or change feature icons in the home screen, see page 36.

Tip: Want some help? Press **Menu** >  **Office Tools** > **Help**. Select a **Help** topic to find information about phone features.

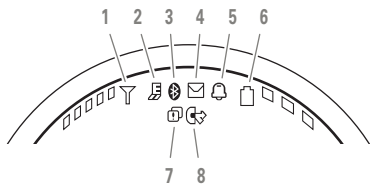
Status indicators appear at the top of the home screen:



- 1 Signal Strength Indicator** – Vertical bars (one to five) show the strength of the wireless network connection.
- 2 EDGE/GPRS Indicator** – Shows when your phone is using a high-speed *Enhanced Data for GSM Evolution* (EDGE) network connection , or *General Packet Radio Service* (GPRS) network connection .





- 3 Bluetooth® Indicator** – Shows Bluetooth status:





blue = power on
green = connected
flashing blue = discoverable

- 4 Message Indicator** – Shows when you receive a new text message. Other indicators can include:





 = voicemail message  = email message





- 5 Alert Style Indicator** – Shows the alert style setting:

 = ring only  = ring and vibrate
 = vibrate only  = vibrate then ring
 = silent

6 Battery Level Indicator – Vertical bars (one to three) show the battery charge level. Recharge the battery when your phone shows **Low Battery**.

7 Missed Event Indicator – Shows when you have missed calls or unread messages. 

8 Active Line Indicator – Shows  to indicate an active call, or  to indicate when call forwarding is on. Indicators for dual-line-enabled SIM cards can include:

 = line 1 active  = line 2 active
 = line 1 call forward on  = line 2 call forward on

When you set a phone alarm, the alarm indicator  appears in place of the active line indicator.

Volume

Press the *volume key* to:

- turn off an incoming call ringer
- change earpiece or speakerphone volume during a call
- change playback volume for a song or video
- set your phone's alert style to **Ring Only** or **Silent** in the blade-closed display

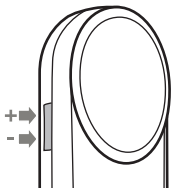

Voice Commands

You can use voice commands to tell your phone what to do.

Note: Not all languages support voice commands.

Voice Dial a Call

You can dial a contact list entry by speaking its name, or dial any phone number by speaking its digits.

- 1 Press and hold . The phone loads the voice recognition software, then prompts you to say a command or name.
- 2 Wait for the beep, then say the **full name** of the contact as it appears in your contact list. Your phone confirms the name and makes the call.

or

Say “Dial Number.” Your phone prompts you to speak the digits in the phone number. Speak the digits. Your phone confirms the number and makes the call.

Tips:

- You can say a contact’s name and number type together. For example, say “John Smith mobile” to call the mobile number stored for John Smith.
- For voice command help, press and hold , then press Help.

Voice Activate Phone Functions

You can use voice commands to open applications and perform many basic phone functions.

- 1 Press and hold . The phone prompts you to say a command.
- 2 Wait for the beep, then say a command from the list.

voice commands
<i>“contact name”</i>
“Dial Number”
“Send Message To <i>contact name</i>”

voice commands
“Check Calendar”
“Check New Message”
“Check New Email”
“Add New Contact”
“Talking Phone”
“Check Battery”
“Check Signal”
“Check Time”
“Check Date”
“Open Setup”
“Open Recent Calls”
“Open Theme”
“Open Camera”
“Open Web Access”
“Set Normal”
“Set Vibrate”
“Set Silent”
“Set Ring”
“Set Airplane”
“Set Airplane Off”

Tip: Press and hold  to see the list of voice commands.

Talking Phone

You can set your phone to recite caller ID information for incoming messages, read the names of menu features or contacts, read messages you receive (in English only), and provide audio feedback for phone functions.

Find it: Menu >  Settings
> Phone Settings > Talking Phone

Shortcut: Press and hold . When the phone prompts you to say a command, say “Talking Phone.”

Handsfree Speaker

During a call, press Options > Speaker On to turn the handsfree speaker on. Your display shows the speakerphone indicator until you turn it off (Options > Speaker Off) or end the call.

Note: The use of wireless phones while driving may cause distraction. Discontinue a call if you can't concentrate on driving. Additionally, the use of wireless devices and their accessories may be prohibited or restricted in certain areas. Always obey the laws and regulations on the use of these products.

Codes & Passwords

Your phone's four-digit **unlock code** is originally set to **1234**. The six-digit **security code** is originally set to **000000**. If your service provider didn't change these codes, you should change them:

Find it: Menu >  Settings > Security > Change Passwords

You can also change your **SIM PIN** codes or call barring password.

If you forget your unlock code: At the **Please verify the Unlock Code** prompt, try entering 1234 or the last four digits of your phone number. If that doesn't work, press  to enter your six-digit security code instead.

If you forget other codes: If you forget your security code, SIM PIN code, PIN2 code, or call barring password, contact your service provider.

Lock & Unlock Phone

You can lock your phone to keep others from using it. You'll need to enter the four-digit unlock code to lock or unlock your phone.

To **manually lock** your phone:

Find it: Menu >  Settings > Security > Phone Lock > Lock Now

To **automatically lock** your phone whenever you turn it off:

Find it: Menu >  Settings > Security > Phone Lock > Lock at Power On > On

Lock Your SIM Card or Applications

Note: You'll need to enter your SIM PIN code to lock or unlock the SIM card. If you forget your PIN code, contact your service provider.

Caution: If you enter an incorrect PIN code three times before the correct code, your SIM card is disabled, and your display shows SIM Blocked.

To **lock or unlock your SIM card:**

Find it: Menu >  Settings > Security > SIM Lock





To **lock an application** (such as Messages):

Find it: Menu >  Settings > Security > Application Lock

You'll need to enter the four-digit unlock code to see the applications list. Select an application and choose **Lock** to lock it.

Alert Styles

You can quickly change your phone's alert style or profile to match your activity or environment. Each alert style uses a different set of ringtones or vibrations to notify you of incoming calls and other events. The alert style indicator shows at the top of the home screen).

-  Ring Only
-  Ring and Vibrate
-  Vibrate Only
-  Vibrate then Ring
-  Silent

Change the Alert Style

With the blade open:

From the home screen, press the volume key up/down to scroll to an alert style, and press  to select it.

With the blade closed:

- 1 Press and hold the volume key to go to the alert style screen.
- 2 Press the volume key up to set the alert style to **Ring Only**.

or







Press the volume key down to set the alert style to **Silent**.

Edit Alert Style Settings

Choose the ringtones that an alert style uses to notify you of incoming calls and other events. You can also change the alert style's ring volume, keypad tone volume, media playback volume, and blade tone settings. For dual-line-enabled SIM cards, you can set different ringtones to identify incoming calls on line 1 or line 2.

Note: You can't set a ringtone for the **Silent** alert style, or change some settings for some alert styles.

Find it: Menu >  Settings > Profiles > Alert Style > *alert style*

- 1 Press  left/right to select the **alerts** tab , **volume** tab , **messages** tab , or **settings** tab .
- 2 Press  up/down to scroll to the alert or volume setting you want to change, then press .
- 3 Select the setting value you want.
- 4 Press **Back** to exit and save your changes.

To **reset** the standard settings for an alert style:

Find it: Menu >  Settings > Profiles > Alert Style > *alert style*, press **Options** > **Reset**

Themes

Use a phone *theme* to personalize the look and sound of your phone.



Standard themes include a **skin** that sets the overall look and feel of your phone display, **ringtones** to notify you of incoming calls and other events, a **wallpaper** image, and a **screensaver** image.

To **apply** a theme:

Find it: Menu >  Settings > Themes > *theme*



Note: When you apply a theme, you can choose to apply the theme's alert settings to the current profile. Selecting this option **changes** the current profile to use the theme alert settings.

To **download** a theme using your phone's browser, see page 73.

Preview Ringtones

To preview the ringtones on your phone, and choose the ringtone a theme uses to notify you of incoming calls:





Find it: Menu >  Settings > Themes, press Options > Edit > Ringtone > Ringtones > Sounds and Ringtones > Preloaded Ringtones

- 1 Press  up/down to scroll and listen to each ringtone in turn.
- 2 Press  to select the highlighted ringtone.
- 3 Press **Save** to save your selection.

Edit a Theme

Choose the ringtones and blade tone, wallpaper, screensaver, and skin that a theme applies to your phone.

Find it: Menu >  Settings > Themes, scroll to the theme, press Options > Edit

- 1 Press  left/right to select the **sounds** tab  or **images** tab .
- 2 Press  up/down to scroll to the setting you want to change, then press .
- 3 Scroll to the image or sound file you want, then select it.
- 4 Press **Save** to save your edits.

To **reset** the standard theme settings:

Find it: Menu >  Settings > Themes scroll to the theme, press Options > Manage > Reset

Restore Default Theme

To **restore** the default theme on your phone:

Find it: Menu >  Settings > Themes, press Options > Manage > Restore to Default

Time & Date

Your phone can automatically update the time and date. It uses the time and date for the **Calendar**.

To **synchronize** time and date with the network:



Find it: Menu > ⚙️ Settings
> Phone Settings > Time & Date
> Auto-Update Local Time > On

To **manually** set the time and date:

Find it: Menu > ⚙️ Settings
> Phone Settings > Time & Date
> Auto-Update Local Time > Off, then
> Time and Date

To adjust time and date, press ⌏ left/right to scroll to a setting, then press ⌏ up/down to change it. Press **Set** to save your settings.

To set your **time zone**:

Find it: Menu > ⚙️ Settings
> Phone Settings > Time & Date

> **Time Zone**, then select a city in your time zone

Shortcut: Press keypad keys to enter the first letters of the city you want.

Clock Style

Change the clock style that appears in the display when the blade is closed:

Find it: Menu > ⚙️ Settings
> Home Screen > External Clock Style
> *clock style*

Shortcut: From the home screen, press Shortcuts > Clock Style.

Wallpaper

Change the background *wallpaper* image that appears in the home screen when the blade is open:

Find it: Menu > ⚙️ Settings
> Home Screen > Change Wallpaper
> Wallpapers and Graphics

> Preloaded Wallpaper, scroll to an image, press **Select**

To apply a **photo** as a wallpaper image:

Find it: Menu >  Multimedia > Pictures > Captured Pictures, scroll to the photo, press Options > Apply to > Wallpaper

Screensaver

Change the screensaver image that appears in the display when the blade is open, after a period of inactivity:

Find it: Menu >  Office Tools > File Manager > Pictures > Wallpapers and Graphics > Preloaded Wallpaper, scroll to an image, press Options > Apply to > Screensaver

Tip: To extend battery life, turn off the screensaver.

Home Screen Shortcuts

From the home screen, you can press the *navigation key*  up, down, left, or right as shortcuts to your favorite features. You can change the shortcuts to suit your needs.





To **change** navigation key shortcut icons in the home screen:

Find it: Menu >  Settings > Home Screen > NaviKey Shortcuts > Left, Right, Up, or Down

Select a direction, then choose the feature you want to open when you press the navigation key in that direction.

To **show or hide** navigation key shortcut icons in the home screen:

Find it: Menu >  Settings > Home Screen > NaviKey Shortcuts > Icon Display > Show or Hide

Note: You can press  to select the features in the home screen even when the icons are hidden.

Display Appearance

To set the display **brightness**:

Find it: Menu >  Settings
> Phone Settings > Display Settings
> Brightness

To save battery life, the **display** can turn off when you're not using your phone. To set the display timeout delay interval:

Find it: Menu >  Settings
> Phone Settings > Display Settings
> Display Timeout

To turn the display **screensaver** on or off:

Find it: Menu >  Settings
> Phone Settings > Display Settings
> Screensaver > On or Off

Tip: To extend battery life, turn off the screensaver.

More Personalizing Features

features





language

Set menu language:

Menu >  Settings > Phone Settings
> Language

missed notifications

Set a reminder alert for missed notifications:

Menu >  Settings > Profiles, press 
left/right to select the **settings** tab ,
press  up/down to scroll to
Missed Notifications, press  to
select it

features

reset settings

Reset default settings for all options **except** the unlock code, security code, and lifetime timer:

Menu >  Settings > Phone Settings
> Reset > Reset All Settings

delete data

Caution: This option **erases all information you have entered** (including contacts and calendar entries) **and content you have downloaded** (including photos and sounds) stored in your phone's memory. After you erase the information, you can't recover it.

This option does **not** delete SIM card information:

Menu >  Settings > Phone Settings
> Reset > Delete All Data

features

delete SIM card information

Caution: This option **erases all information you have entered** (including contacts and calendar entries) **and content you have downloaded** (including photos and sounds) stored on your SIM card. After you erase the information, you can't recover it.

Menu >  Settings > Phone Settings
> Reset > Delete Memory Device

Turn Off a Call Alert



Press the volume key on the side of your phone, to turn off the ringer for an incoming call.



Recent Calls



Your phone keeps lists of incoming and outgoing calls, even for calls that didn't connect.

Find it: Menu >  Recent Calls



Shortcut: Press  in the home screen to go to the Dialed Calls list.

- 1 Press  left/right to select a call list: All Calls, Dialed Calls, Answered Calls, Missed Calls, or Frequent Calls.
- 2 Press  up/down to scroll to a phone number.

Icons indicate if the call was incoming  or outgoing . Icons with a check mark  indicate a connected call.

- To call the number, press .
- To check if your caller left a voicemail message, see page 51.
- To see call details (like time and date), press .
- Press **Options** to perform other operations on the number (send a message, save to contacts), or to set recent call options.

Redial



- 1 Press  from the home screen to see the **Dialed Calls** list.
- 2 Scroll to the number you want to call, then press .

If you hear a **busy signal** and see **Call Failed**, press  or **Retry** to redial the number. When the call goes through, your phone shows **Connected** and connects the call.



Return a Call

Your phone keeps a record of your unanswered calls.

When you see the **Missed Calls** message, press  to see the **Missed Calls** list. Scroll to the call you want to return, then press .

Caller ID

Calling line identification (caller ID) shows the phone number for an incoming call in your phone's display.



Your phone shows the caller's name and picture when they're stored in your contact list, or **Incoming Call** when caller ID information isn't available.

Note: Picture IDs aren't available for contacts stored on the SIM card.

Tip: Want to know who's calling without even looking at your phone? To give one of your contacts a special ringtone, see page 78.

To show or hide your phone number for the next outgoing call, enter the number you want to call, then press **Options** > **Show ID** or **Hide ID**.

To show or hide **your phone number** for all calls:

Find it: Menu >  Settings > Call Settings > Dialing Setup > My Caller ID > All Calls > Show ID or Hide ID

Emergency Calls

Your service provider programs one or more emergency phone numbers, such as 911 or 112, that you can call at any time, even when your phone is locked or the SIM card is not inserted.

Note: Check with your service provider, as emergency numbers vary by country. Your phone may not work in all locations, and sometimes an emergency call cannot be placed due to network, environmental, or interference issues. Do not solely rely on your wireless phone for essential

communications such as medical emergencies.

To make an emergency call: Turn your phone on, exit any open application such as games, dial the emergency number, then press  to call the emergency number.

Handsfree

Note: The use of wireless phones while driving may cause distraction. Discontinue a call if you can't concentrate on driving. Additionally, the use of wireless devices and their accessories may be prohibited or restricted in certain areas. Always obey the

laws and regulations on the use of these products.

features

auto answer (headset)

Automatically answer calls when connected to a car kit or headset:

Menu >  Settings > Phone Settings > Headset Settings > Auto-Answer

voice dial (headset)

Enable voice dial with headset send/end key:

Menu >  Settings > Phone Settings > Headset Settings > Voice Dial

Answer Options

You can use different ways to answer an incoming call:

Find it: Menu >  Settings > Call Settings > In-Call Setup > Answer Options





options	
Any Key Answer	Answer by pressing any key.
Open to Answer	Answer by opening the blade.

Note: You can always press  to answer a call.

Call Times & Costs

Network connection time is the elapsed time from the moment you connect to your service provider's network to the moment you end the call by pressing . This time includes busy signals and ringing.

The amount of network connection time you track on your resettable timer may not equal the amount of time for which you are billed by your service provider. For billing information, contact your service provider.

features
call times 
See call timers: Menu >  Recent Calls, press Options > Call Times
in-call timer 
Show call time information during a call: Menu >  Settings > Call Settings > In-Call Setup > In-Call Timer

features

call cost



See call cost trackers and credit information:

Menu >  Recent Calls, press Options > Call Costs

call cost setup



Set a credit limit:

Menu >  Recent Calls, press Options > Call Costs > Call Cost Setup

data times



See data call timers:

Menu >  Recent Calls, press Options > Data Times

data volumes



See data volume meters:

Menu >  Recent Calls, press Options > Data Volumes

More Calling Features

To use voice commands for calling, see page 27.

features

speed dial

Your phone can store nine phone numbers that you can call with a single keypress. To **store** a speed dial phone number:

Menu >  Contacts, press Options > Settings > Speed Dial List > *speed dial location*

To **call** a speed dial number, press and hold the single-digit speed dial number for one second.

features

international calls



If your phone service includes international dialing, press and hold  to insert your local international access code (indicated by +). Then, press number keys to dial the country code and phone number.

hold active call(s)

During a call, press **Options > Hold**

mute active call(s)

During a call, press **Options > Mute**

features

call waiting



When you're on a call, you'll hear an alert if you receive a second call. Press  to answer the new call.

- To switch between calls, press **Switch**.
- To connect the two calls, press **Link**.
- To end the call on hold, press **Options > End Call On Hold**.

To turn call waiting on or off:

Menu >  Settings > Call Settings > In-Call Setup > Call Waiting > On or Off

make another call during a call



During a call, press **Options > New Call**, press **Options > Browse Contacts**

features

conference call



During a call, dial next number, press , press **Options** > **Link Calls**

transfer a call



During a call, press **Options**
> **Transfer Call**, dial transfer number, press 

call forwarding



Set up or cancel call forwarding:

Menu >  **Settings** > **Call Settings**
> **Call Forward**

call barring



Restrict outgoing or incoming calls:

Menu >  **Settings** > **Call Settings**
> **Call Barring**

features

TTY calls



Set up your phone for use with an optional TTY device:

Menu >  **Settings** > **Phone Settings**
> **TTY Settings**

change phone line



If you have a dual-line-enabled SIM card, you can change your line to make and receive calls from your other phone number:

Menu >  **Settings** > **Call Settings**
> **In-Call Setup** > **Active Line**

The active line indicator shows the active phone line (see page 27).

network settings



See network information and adjust network settings:

Menu >  **Settings** > **Network**

features

fixed dial



When you turn on fixed dialing, you can call only numbers stored in the fixed dial list.

Turn fixed dialing on or off:

Menu >  Settings > Call Settings
> Fixed Dialing > On or Off

Note: You'll need to enter your SIM PIN2 code to turn fixed dialing on or off. If you forget your PIN2 code, contact your service provider.

Use the fixed dial list:

Menu >  Office Tools
> Dialing Services > Fixed Dial

service dial



Dial service phone numbers stored by your service provider:

Menu >  Office Tools
> Dialing Services > Service Dial

features

DTMF tones

Activate DTMF tones:

Menu >  Settings > Call Settings
> Dialing Setup > DTMF

To send DTMF tones during a call, just press the number keys.

Some features let you enter text.

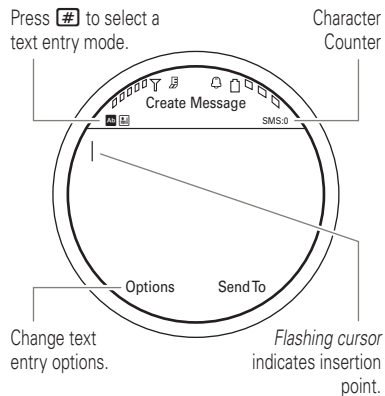

text entry modes

Ab	"word" mode (see page 48)
Ab	"abc" mode (see page 49)
123	numeric mode (see page 49)
☰	symbol mode (see page 50)

To **change** your global text entry settings or languages:

Find it: Menu > Settings
> Phone Settings > Text Entry



Change text case: In a text entry screen, press **0** to change text case to all capital letters (**! !**), next letter capitalized (**! !**), or next letter lowercase (no symbol).

Set word learning: Your phone can learn the words you enter, to improve text prediction and completion. In a text entry screen, press **Options** > **Text Entry** > **Set Text Prediction** > **Learn My Words**.



Your phone shows  when word learning is active.

Set text completion: Set your phone to complete words based on the characters you enter. In a text entry screen, press **Options > Text Entry > Set Text Prediction > Offer Completions**. Your phone shows  when text completion is active.





Enter punctuation: In a text entry screen, press  to enter punctuation or other characters.

Edit or delete text: In a text entry screen, press  to move the cursor to the right of text you want to edit. Press the *clear/back key*  to delete the character left of the cursor. Hold  to delete word by word.



Word Mode

To switch to “word” predictive text entry mode, press  in a text entry screen until you see  in the display.

Word mode lets you enter words using one keypress per letter. The phone predicts each word as you enter it.

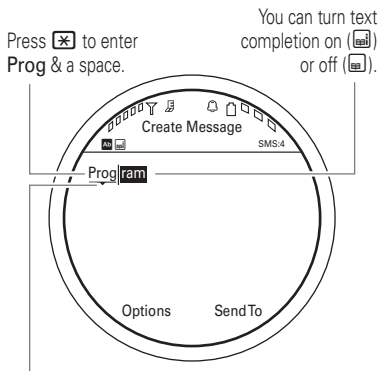
For example, if you press    , your display might show:



Press  up/down to see other words.
Press  to select a word.

Press  to delete character to left of cursor.

ABC Mode

To switch to “abc” text entry mode, press **#** in a text entry screen until you see **Ab** in the display.

To enter text, press a keypad key repeatedly to cycle through the letters and number on the key. Repeat this step to enter each letter.

For example, if you press **7** one time, your display might show:

Character displays at insertion point.

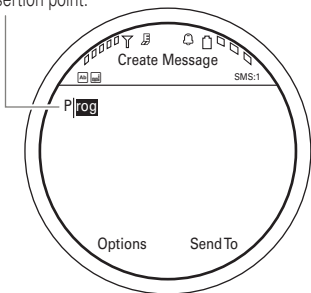

After two seconds, the character is accepted and the cursor moves to the next position.

When text completion is activated, your phone tries to guess the rest of the word:





- Press **OK** to select the suggested word.
- Press **⊙** right to enter the suggested word and a space.
- If you want a different word, press keypad keys to enter the remaining letters.

Numeric Mode

Press **#** in a text entry screen until you see **123**. Press the number keys to enter the numbers you want.

Tip: Just need one number? To enter a number quickly, press and hold a number key until the number appears.

Symbol Mode

Press  in a text entry screen until you see . The display shows the symbol associated with each keypad key. Press  up/down repeatedly to see different symbols. To insert a symbol, press its key, or scroll to it and press .

Voicemail

Your network stores the voicemail messages you receive.



When you **receive** a voicemail message, your phone shows **New Voicemail**, and the new message indicator  appears at the top of the home screen.

To **check** voicemail messages:

Find it: Menu >  Messages
> Call Voicemail

Shortcut: Your service provider may store your voicemail phone number in speed dial location 1. If so, you can press and hold  1 in the home screen to listen to your voicemail message(s).

Text Messages

Send a Message

A message can contain text and pictures, sounds, or other media objects. You can add multiple pages to a message and put text and media objects on each page. You can send a message to other compatible phones or to email addresses.





Find it: Menu >  Messages
> Create Message

- 1 Press keypad keys to enter text on the page (to enter text, see page 47).



To insert a **picture, video, or other media object** on the page, press **Options > Insert**. Select the file type and the file. (**Note:** File size restrictions may apply to pictures and videos sent in a message.)

To insert **another page**, press **Options** > **Insert** > **Page**. You can enter more text and objects on the new page.



- 2 When you finish the message, press **Options** > **Sending Options** to set message options (such as **Subject** and **Priority**).
- 3 When you finish setting message options, press **Done**.
- 4 Press **Send To** to select message recipients. You can:
 - Select one or more entries from your contact list (press  to scroll to an entry, and press  to select it).
 - Enter a new number or email address (press **Options** > **Enter Number** or **Enter Email**).

- 5 Press **Send** to send the message.

To save or cancel the message, press **Options** > **Save to Drafts** or **Cancel Message**.

Messages that you send are stored in the **Outbox**. Icons next to each message show if the message was **sent** , if the send attempt was **successful** , or if the send attempt **failed** . Press **Options** to perform various operations on a message.

Receive a Message

When you receive a message, your phone plays an alert and shows  **New Message**. The text message indicator  appears at the top of the home screen.



To **read** the message, press **View**. If the message contains media objects:











- Pictures and animations show as you read the message.

- Sound files play as you read the message. Press the volume key on the side of your phone to change the sound volume.
- Attached files are added to the end of the message. To open an attachment, select the file indicator or file name.

To **answer** the message, press Options > Reply.

More Messaging Features

features
<p>send a prewritten quick note </p> <p>Menu >  Messages > Templates > Text Templates > <i>quick note</i>, press Options > Send</p> <p>To create a new quick note:</p> <p>Menu >  Messages > Templates > Text Templates, press Options > Create Template</p>

<p>features</p>
<p>send email </p> <p>Menu >  Messages > Email</p>
<p>use a multimedia template </p> <p>Open a multimedia template with pre-installed media:</p> <p>Menu >  Messages > Templates > MMS Templates</p>
<p>read new message or email </p> <p>When your display shows New Message, press Read.</p>
<p>read old messages </p> <p>Menu >  Messages > Inbox</p> <p>Icons next to each message show if it is read , unread , urgent , or has an attachment . Press Options to perform various operations on a message.</p>

features

read old email



Menu >  Messages > Email

Press **Options** to perform various operations on a message.

store message objects



Go to a multimedia message page, then press **Options** > **Store**.

create folder



Create a personal folder to store your messages.

Menu >  Messages > My Folders, press **Options** > **Create Folder**

features

browser messages



Read messages received by your browser:

When your display shows **New Message**, press **View**.

To activate browser messages and adjust browser message settings:

Menu >  Messages, press **Options** > **Settings** > **Browser Messages**

info services



Read subscription-based information services messages:

When your display shows **New Message**, press **View**.

To activate information services and adjust info services settings:

Menu >  Messages, press **Options** > **Settings** > **Info Services**

Camera

Take a Photo

Find it: Menu >  Camera

Shortcut: From the home screen, press

Shortcuts > Take Picture.

The phone display acts as the camera viewfinder.

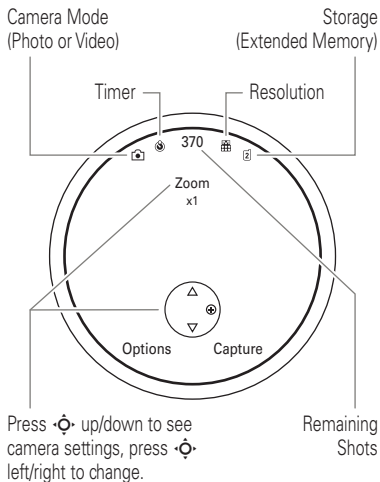

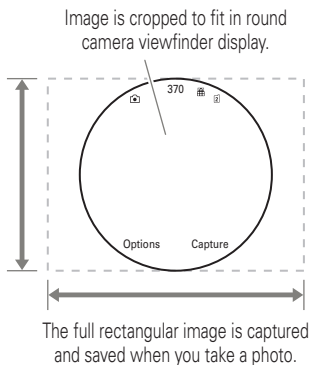

Note: Because of your phone's round display, the viewfinder doesn't show the edges of the rectangular image that is captured when you take a photo.



Use the viewfinder to compose your scene, then press **Capture** to take the photo.

- To store the photo, press **OK**.

- To send the photo in a message, press **Send** (see page 51). 
- To discard the photo, press .
- To select other photo options, press **Options**. You can choose to **Save Only**, **Discard**, **Send to** (message, email, or Bluetooth connection), **Apply to** (wallpaper, screensaver, new or existing contact), **Edit**, or **Print via** (Bluetooth connection or USB connection).

Note: If the auto-save feature is activated, your phone automatically saves the photos you take. In this case, you'll need to manually navigate to the stored photo to view, use, and/or delete it.

Apply Photo to a Contact

Assign a photo to a contact stored in your contact list. The photo appears as a background image for the contact, and shows in the display when you receive a call from the contact.

Find it: Menu >  Multimedia > Pictures > Captured Pictures, scroll to the photo, press Options > Apply to > Existing Contact > *contact*, press Save

Auto-Send

You can set up your phone to automatically send the photos you take to a list of contacts you specify.

To use auto-send, you first must activate the auto-save feature:

Find it: Menu >  Camera, press Options > Camera Settings > Auto-Save > Enable

Then set the storage location for auto-saved photos:

Find it: Menu >  Camera, press Options > Camera Settings > Storage Location > Phone or Extended Memory

Then activate auto-send:



Find it: Menu >  Camera, press Options > Camera Settings > Auto-Send > Enable



To specify message recipients for the photos you take:

Find it: Menu >  Camera, press Options > Camera Settings > Message Recipients

Tip: To send your photo in an MMS text message, set the picture resolution to **Thumbnail**, **Small**, or **Medium**. To set resolution, press Menu >  Camera, press Options > Camera Settings > Picture Settings > Resolution.

Camera Settings

When the camera viewfinder is active, you can use the navigation key  to adjust the following camera settings. Press  up or down to scroll to a setting, then press  left or right to change it:

settings	
Zoom	Press  right to zoom in, press left to zoom out.
Styles	Press  left/right to select Color, Black & White, Antique, Negative, Reddish, Greenish, or Bluish.
Scene	Press  left/right to select Automatic, Night, or Manual.
Tag	Select a predefined text tag to apply to the photo(s) you take. (To create a tag, press Options > Camera Settings > Tag > Create New Tag).

When the camera viewfinder is active, press **Options** to select these camera options:

options	
Capture	Take a photo.
Go To My Media	See, edit, and delete stored pictures and photos.
Video Mode	Switch to the video camera.
Auto-Timer	Set a timer for the camera to take a photo.
Multi-Shot	Set the camera to take multiple photos in sequence.



options

Camera Settings	Customize camera settings: <ul style="list-style-type: none">• Review Time• Tag• Default Name• Storage Location• Auto Save• Auto Send• Message Recipients• Picture Settings<ul style="list-style-type: none">• Resolution• Shutter Tone• Quality• Video Settings<ul style="list-style-type: none">• Resolution• Capture Tone• Quality• Video Length
-----------------	--

View & Use Photos

Find it: Menu >  Multimedia > Pictures > Captured Pictures > *photo*

Note: Because of your phone's round display, you won't see the edges of the rectangular photo when you view the photo in full screen mode.

To **rotate** the photo clockwise/counter-clockwise, press  up/down. To go to the **previous/next** photo, press  left/right. To toggle between **complete/cropped** (full screen) photo views, press  or Full Scrn.

Press **Options** to edit, print, send, apply, or delete the photo.

Videos

Record a Video



Find it: Menu >  Multimedia

> Video Camera

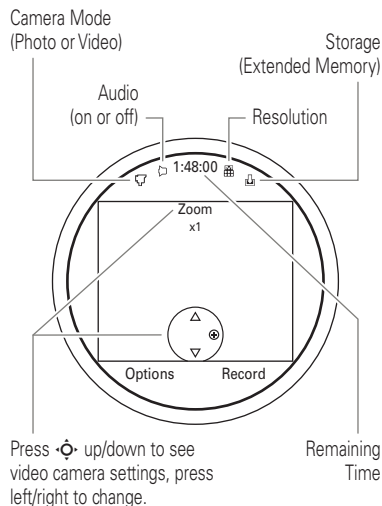
The phone display acts as the video camera *viewfinder*.



To start video recording, press **Record**. To stop video recording, press **Stop**.

- To store the video, press .
- To send the video in a message, press .
- To discard the video, press .
- To select other video options, press **Options**. You can choose to **Save Only**, **Discard**, **Send to** (message, email, or Bluetooth connection), or **Preview** the video.

Note: If the auto-save feature is activated, your phone automatically saves the videos you record. In this case, you'll need to manually navigate to the stored video to view, use, and/or delete it. To go to the video, press **Menu** >  **Multimedia** > **Videos** > **Captured Videos** > *video*.

Tip: To send your video in a message, the video length must be set to **MMS Short** or **MMS Long**. To set length, press **Menu** >  **Multimedia** > **Video Camera**, press **Options** > **Camera Settings** > **Video Settings** > **Video Length**.

When the video camera viewfinder is active, press **Options** to set video recording options:



options	
Record	Begin video recording.
Go To My Media	See, edit, and delete stored videos.
Picture Mode	Switch to the still camera to take a photo.
Audio On/Off	Turn audio recording on/off.
Camera Settings	Customize video camera settings (see page 59).

Upload Video to a Blog

Upload a recorded video to a video blog site.

Note: You'll need to have browser service activated on your phone to use this feature.

Find it: **Menu** >  **Web Access** > **Go to URL**

- 1 Enter the Web address for the video blogging service Web site, then press **Go**.
- 2 Log in to your account.
- 3 Scroll to **Upload Videos** and press .
- 4 Follow the browser prompts to scroll to the video you want to upload, then press .
- 5 Scroll to **Upload** and press .

Your phone uploads the video to the blog.

Play a Video

Find it: Menu >  Multimedia > Videos
> video

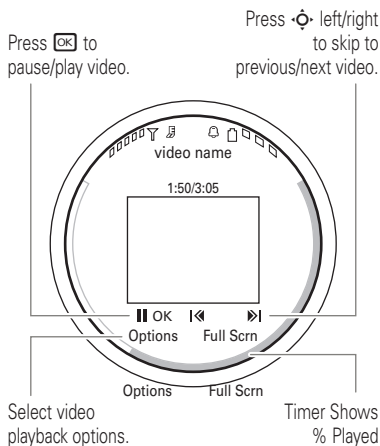

When a video is playing, press **Options** to select video playback options.

Note: Your phone's options may vary. Most options apply only to user-recorded videos, and are not available for pre-installed videos.

options	
Slideshow	View a slideshow of stored video clips.
Manage	Show video Properties , such as file name, type, and size.
Delete	Delete the video.
Zoom	Show the video at actual size, or scale the video to fit the viewing area.
Send To	Send the video in a message or email, or send it to another device over a Bluetooth® connection.

options	
Use Bluetooth/Handset	<p>To send the audio soundtrack to a Bluetooth® headset, turn on Bluetooth power, then select Use Bluetooth to connect to a recognized Bluetooth headset or search for a new headset.</p> <p>When a Bluetooth audio connection is active, select Use Handset to drop the Bluetooth connection and switch the audio back to the phone.</p> <p>Note: This option appears only when Bluetooth power is turned on.</p>
Setup	Adjust video settings.

supported video formats

Before you copy video files to your phone, make sure the files are in a format the phone recognizes: MPEG4 + AMR-NB, MPEG4 + AMR-WB, MPEG4 + AAC/AAC+/Enhanced AAC+, H.263 + AMR-NB, H.263 + AMR-WB, H.263 + AAC/AAC+/Enhanced AAC+, Real Audio + Video, H.264 + AMR-NB, H.264 + AMR-WB, H.264 + AAC/AAC+/Enhanced AAC+. WMV 9 + WMA v9 L2 (also WMA v3, v7, v8).

Music

Copying and syncing music between your phone and computer is easy, with Microsoft® Windows® Media Player 11.

Note: The unauthorized copying of copyrighted materials is contrary to the provisions of the Copyright Laws of the United States and other countries. This device is intended solely for copying non-copyrighted materials, materials in which you own the copyright, or materials which you are authorized or legally permitted to copy. If you are uncertain about your right to copy any material, please contact your legal advisor.

Set Up Music

To **load song files from a music CD** onto your computer:

- 1 Insert the music CD in your computer's CD drive.
- 2 Open Windows Media Player 11.

- 3 Copy the music CD to the media player library (also called *ripping* the CD).

If your computer is connected to the Internet, the media player may retrieve CD information, such as song titles, album name, artist name, and album artwork. This information will appear in your phone's music player.

Tip: You can also purchase Microsoft® Windows Media DRM-protected music files from supported on-line music stores (such as Urge, Yahoo!, and Napster).

Set Default Format & Bit Rate For Windows® Media Player 11

Windows Media Player 11 lets you adjust format and bit rate settings, to optimize sound quality, or to increase the number of song files you can store on your phone.

To set the default file format and bit rate:

- 1 Insert the music CD in your computer's CD drive.
- 2 Open Windows Media Player 11.

- 3 Select the Rip tab in Windows Media Player 11.
- 4 Click the Rip tab down arrow, then choose Format > Windows Media Audio, Windows Media Audio Pro, or mp3.
- 5 Click the Rip tab down arrow again, then choose Bit Rate > *bit rate*.

Tip: To maximize the number of songs you can store on your phone, set the bit rate to 128 Kbps or lower. Use the lowest bit rate that provides an acceptable sound quality.

Tip: To learn more about Windows Media Player 11 song file formats and bit rates, open Windows Media Player 11, click the Rip tab down arrow, then choose Help with Ripping.

Convert iTunes AAC Files To MP3 Files On Your Computer

You can use the iTunes desktop application to convert standard iTunes AAC files to MP3

files that are compatible with Windows Media Player 11. For more information, open the iTunes desktop application and choose Help > iTunes Help
> Saving a copy of a file in a new file format.

Get Music

Note: You'll need Windows Media Player 11 to synchronize music files as described in this section. Using previous versions of Windows Media Player may compromise your music experience. You can download Windows Media Player 11 at www.microsoft.com/windowsmedia.

Note: Windows Media Player 11 requires Windows XP™ or later to run. If you are using an earlier version of Windows OS on your computer, see the section “Manually Transfer Music” on page 70.

Note: You cannot use Windows Media Player 11 to copy pictures or videos to the phone.

On Your Phone

Press **Menu** >  **Settings** > **Connections**
> **USB Setting** > **Media Synchronization**

Attach a Motorola Original USB cable to the micro USB port on your phone and to an available USB port on your computer. A



Motorola Original USB cable and supporting software may be included with your phone. These tools are also sold separately.

Note: Some phone functions are temporarily unavailable when a USB connection is active.

On Your Computer

Open Windows Media Player 11. Your phone appears in the upper right corner of the Windows Media Player 11 screen. The phone's music files are listed on the left side of the screen.

1 Select the Sync tab in Windows Media Player 11.

- 2 Drag and drop songs or playlists onto the Sync List on the right side of the Windows Media Player 11 screen.
- 3 Click Start Sync to copy the songs onto the phone.
- 4 When you finish, disconnect your phone from the computer.

Play Music

Find it: Menu >  **Multimedia**
> **Media Finder** > **Music Library** > *category*
> *song name*

You can select a song or playlist from the following categories: **Recently Played**, **Shuffle Songs** (play all songs in random order), **All Songs**, **Playlists**, **Artists**, **Albums**, **Genres**, or **Composers**.

Tip: Use the phone's built-in speaker to play your music out loud. Use wireless stereo headphones or a wired headset to enjoy your music in private.

When a song or playlist starts to play, use the following keys to control song playback:

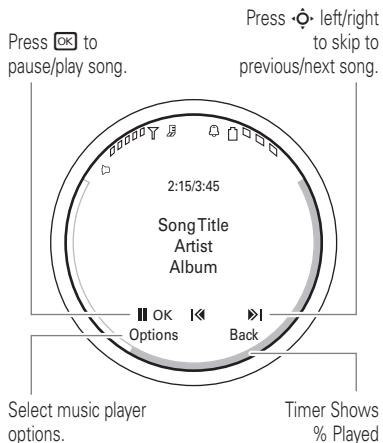

During a song, the music player shows the song title, artist, album, and artwork, if available.

If you receive a call during a song, the song pauses until the call is over.

When a song is playing, press **Options** to select music player options:

options	
Hide	Hide the music player while music plays. To see the music player again, go to the home screen, then press ◀ up.
Manage	Show song Properties , such as file name, type, and size.
Send to	Send the song in a message or email, or send it to another device over a Bluetooth® connection.
Apply to	Add the song to a playlist or make it a ringtone.

options	
Use Bluetooth/Use Handset	To send the audio to a Bluetooth® headset, turn on Bluetooth power, then select Use Bluetooth to connect to a recognized Bluetooth headset or search for a new headset.
	When a Bluetooth audio connection is active, select Use Handset to drop the Bluetooth connection and switch the audio back to the phone.
	Note: This option appears only when Bluetooth power is turned on.
Setup	Personalize settings.

Use Bluetooth® Stereo Headphones

Connect your phone with optional Bluetooth stereo headphones to listen to music stored on your phone.



To connect your phone to a set of Bluetooth stereo headphones for the first time, make sure the headphones are **on** and **ready** in *pairing* or *bonding* mode (to put the headphones in pairing/bonding mode, see the user's guide for the device).

Find it: Menu >  Settings > Connections > Bluetooth, press Options > Search For Devices

Your phone lists the Bluetooth devices it finds within range.

- 1 Scroll to the stereo headphones in the list.
- 2 Press  to connect with the stereo headphones.

Adjust Audio Settings

Optimize the sound quality when listening to music through the phone speaker, stereo headphones, or stereo headset.

To change **playback volume**, press the volume key on the side of your phone.

To change the **equalizer setting**, press **Options > Setup > Equalizer > equalizer effect**.



To set **stereo separation**, press **Options > Setup > Stereo Effects > Spatial Audio > separation level**.

To set **bass boost**, press **Options > Setup > Stereo Effects > Bass Boost > bass level**.

Note: The equalizer and stereo effect settings are best experienced using the stereo headset or stereo headphones. Your phone cannot produce stereo effects through the built-in monaural speaker.

Do Other Tasks While Playing Music

To take **pictures** or record **videos** while playing music:

- 1 From the music player screen, press **Hide** to hide the music player.
- 2 Press  until you return to the main menu.
- 3 From the main menu, select  **Camera** or  **Multimedia > Video Camera**.
- 4 Press **Capture** to take a photo, or **Record** to record a video.



Note: Music playback pauses while you record a video, and may pause momentarily when you take a picture.

To use the **browser** while playing music:

- 1 From the music player screen, press **Hide** to hide the music player.
- 2 Press  until you return to the main menu.

- 3 From the main menu, select  Web Access > Browser.

To return to the **music player** from another application:

- 1 Press  to exit the application and return to the home screen.
- 2 From the home screen, press  up to return to the music player screen.

Manually Transfer Music

Without using Windows Media Player 11, you can manually copy or sync music files from the computer to your phone.

Supported Audio Formats

Before you copy audio files to your phone, make sure the files are in a format the phone recognizes: AMR-NB, AMR-WB, AAC (MPEG4 AAC-LC), AAC+, Enhanced AAC+, MP3, 8-bit Linear PCM, 16-bit Linear PCM, 8-bit A-law PCM, 8-bit mu-law PCM, WMA v9 L2 (also WMA v3, v7, v8), Real Audio LBR (Cook), Real Audio Sipro (ACELP®.net), Real Audio 10.

On Your Phone

Press Menu >  Settings > Connections > USB Setting > Extended Memory

Attach a Motorola Original USB cable to the micro USB port on your phone and to an available USB port on your computer. A Motorola Original USB cable and supporting software may be included with your phone. These tools are also sold separately.



On Your Computer

When your phone is connected to the computer in extended memory mode, the phone's basic memory and extended memory appear as two separate removable disks on the computer.

- 1 Find where your phone's basic memory and extended memory appear as Removable Disk icons. On a Windows PC, this is the My Computer window. On a Macintosh® computer, it's on the desktop.

- 2 Double-click the Removable Disk icon for your phone's extended memory.
- 3 To copy the desired files onto the phone, drag and drop them onto the removable disk icon.
- 4 When you finish, remove the phone safely from your computer:
 - **If you are using a Windows PC,** click the Safely Remove Hardware icon in the system tray at the bottom of your computer screen, then select "Safely Remove USB Mass Storage Device."
 - **If you are using a Mac,** select and drag the Removable Disk icon to the Trash.

Create a Playlist

Create a Playlist on Your Computer



Use Windows Media Player 11 to create a playlist of music files stored on the computer.



On your phone, press **Menu** >  **Settings** > **Connections** > **USB Setting** > **Extended Memory**.

Connect your phone to the computer through a USB cable connection, then drag and drop the playlist onto the phone.

Create a Playlist on Your Phone

Find it: **Menu** >  **Multimedia** > **Media Finder** > **Music Library** > **Playlists**, press **Options** > **Create New Playlist**

- 1 Enter a name for the playlist, and press **Save**.
- 2 Scroll to the playlist you created, and press  to select it.
- 3 Scroll to **Add Songs**, and press  to select it.

- 4 Scroll to **All Songs, Artists, Albums, Genres, or Composers**, and press  to select it.
- 5 Scroll to the songs you want to add, and press  to select them.
- 6 Press **Add** to add the selected songs to the playlist.
- 7 Repeat the procedure to add more songs, or press **Back** to return to the **Playlists** menu.

Play a Playlist

Find it: Menu >  **Multimedia**
> **Media Finder** > **Music Library** > **Playlists**, scroll to the playlist, press **Options** > **Play**

Personalize Your Music Player

Find it: Menu >  **Multimedia**
> **Media Finder** > **Music Library**, press **Options** > **Setup**

You can select the following options:

options	
Shuffle	Play songs in a random order.
Equalizer	Optimize audio settings for the type of music you play.
Auto- Repeat	Replay the song or playlist when the last file finishes playing.
Spatial Audio	Set separation level for a stereo headset or headphones.
Bass Boost	Set the bass level.
Internet Connection	Set your Internet connection preferences. 

When you scroll to a song in a list and press **Options**, you may see additional options for

the song and list, such as **Delete**, **Send to**, and **Apply to**.

Close the Music Player



From the music player screen or home screen, press  to close the music player.

Browser

Use your phone's full HTML browser to surf to your favorite Web sites, upload videos to a video blog, and download files and applications to your phone. Log on to your Internet-based email account to check your email on the go.



Find it: Menu >  Web Access > Browser

Press  up/down/left/right to scroll through Web pages. Scroll to a link and press  to select it. Press **Back** at any time to return to the previous screen.

Some Web pages may contain a text entry window for exchanging information with a Web site. Scroll to the window, select it, and

enter text as usual (to enter text, see page 47).

To...	Do this...
go to a Web page	Press Options > Go to URL, enter the Web address, then press Go.
bookmark the current Web page	Press Options > Active Page > Add Bookmark.
go to a bookmarked Web page	Press Options > My Bookmarks > <i>bookmark</i> .
change the browser's home page	Go to the Web page you want to use, then press Options > Active Page > Use as Homepage.

To...	Do this...
download a media file, theme, game, or application	<p>Go to the Web page that links to the file, scroll to the link, and select it.</p> <p>Note: Java™ games and applications not designed specifically for AURA, may not display properly in your phone's round display.</p>
exit the browser	Press Options > Exit.





Perform a Google Search

Use your phone's browser to perform a Web search using the Google Web site.



Note: You'll need to have browser service activated on your phone to use this feature.

Find it: Menu >  Web Access
> My Bookmarks

- 1 Press  to scroll to the **Google** bookmark, and press  to select it.
- 2 Press  to select the Google text entry window.
- 3 Enter a search topic in the text entry window.
- 4 Press  down to scroll to the Google Search button, and press  to select it.

The browser shows the results of your search.

Check Your Email

Check your personal Web-based **email** account (such as Hotmail, Gmail, or Yahoo).



Note: You'll need to have browser service activated on your phone to use this feature.

Find it: Menu >  Web Access
> Go to URL

Enter the Web address for your Web-based email account, then press Go.

Manage Certificates

Certificates are used to verify the identity and security of Web sites when you download files or share information. To enable or disable Internet access certificates stored on your phone:



Find it: Menu >  Settings > Security > Certificates

Fun & Games

features

start a game or application



Start a Java™ game or application:

Menu >  Multimedia > Games
> *game* or *application*

features

airplane mode

Turn off your phone's Bluetooth wireless features and calling features in locations where wireless phone use is prohibited. This lets you use the camera, music player, and other non-network features while you are on an airplane, without interfering with airplane communications.

Menu >  Settings > Phone Settings > Airplane Mode > On

To reactivate your phone's calling features, turn off airplane mode.

Contacts

When you insert a new SIM card in your phone, or go to **Contacts** for the first time, the phone prompts you to set the default save location for new contacts.

The **Phone & SIM Card** option stores the contact in phone memory, and stores a copy of the name and phone number on the SIM card. Contacts in phone memory can contain multiple phone numbers, an email address, and personal information. The **SIM Card Only** option stores only the contact name and phone number on the SIM card.

Note: The default save location determines your contact list view. When save location is set to **Phone & SIM Card**, the contact list

shows only the contacts stored in phone memory.

features

call a contact

Menu >  **Contacts**, scroll to the contact, press  to call

Note: If a contact has multiple phone numbers or email addresses, press  left/right to select the number or email address you want.

set default contact save location







To set or change the default save location for new contacts:

Menu >  **Contacts**, press **Options**
 > **Settings** > **Default Save Location**
 > **Phone & SIM Card** or **SIM Card Only**

features

add new contact

Menu >  Contacts, press Options
> Create Contact

For a contact stored in phone memory, press  left/right to select the **details** tab , **address** tab , **ID** tab , or **notes** tab . Press  up/down to scroll to information you want to change, then press  to select it.

store new contact in phone memory only

Enter a phone number in the home screen, press **Save**, scroll to **Save to SIM Card** and make sure the option is de-selected, enter the contact name and other details as necessary.

features

copy SIM card contacts to phone memory

Press Menu >  Contacts, press Options > Settings
> Default Save Location
> Phone & SIM Card, press Back, press Options > Import Contacts > SIM Card, press Options > Select All, press Import.

copy phone memory contacts to SIM card

Press Menu >  Contacts, press Options > Settings
> Default Save Location
> SIM Card Only, press Back, press Options > Import Contacts
> Phone Contacts, press Options
> Select All, press Import.

send message to contact

Menu >  Contacts, scroll to the contact, press Options > Send Message

features

add another phone number or email address to contact

Menu > [f] Contacts, scroll to the contact, press Options > Edit, press ⬅️ left/right to select the **details** tab [d], press ⬆️ up/down to scroll to an empty **Number or Email** field, press [OK] to select it

set picture for contact

Assign a photo or picture (*picture ID*) to a contact. The picture appears as a background image for the contact, and shows in the display when you receive a call from the contact.

Menu > [f] Contacts, scroll to the contact, press Options > Edit, press ⬅️ left/right to select the **ID** tab [ID], press ⬆️ up/down to scroll to **Picture ID**, press [OK] to select it

features

set ringtone for contact

Assign a distinctive call alert (*ring ID*) for a contact:

Menu > [f] Contacts, scroll to the contact, press Options > Edit, press ⬅️ left/right to select the **ID** tab [ID], press ⬆️ up/down to scroll to **Ring ID**, press [OK] to select it

assign contact to category

Menu > [f] Contacts, scroll to the contact, press Options > Edit, press ⬅️ left/right to select the **details** tab [d], press ⬆️ up/down to scroll to **Category**, press [OK] to select it

features

set category view

Menu >  Contacts, press
Options > Filter By

You can show contacts in a predefined category (Email, Family, Friends, Work), or contacts in a category that you create (select **Create Category**).

create group mailing list

Assign contacts to a group message list or email list:

Menu >  Contacts, press Options
> Create List > Message or Email

set contact list sort order

Menu >  Contacts, press Options
> Settings > Default Sort Order
> First Name or Last Name

features

create and use private contacts

Identify one or more contacts as private contacts. You'll need to enter your six-digit security code to access the private contacts on your contact list.

Menu >  Contacts, press Options
> Settings > Private Contacts

manage SIM card contacts



Menu >  Contacts, press Options
> Settings > SIM Card Manager

You can delete contacts stored on your SIM card, or import contact to the SIM card from phone memory, or from another location.

features



send contact(s) to another device

Send one or more contacts to another phone, computer, or device:

Menu >  **Contacts**, scroll to the contact, press **Options** > **Share**, press  to select the current contact, press  up/down to scroll to **Bluetooth**, **Messaging**, or **Email** transfer method, press **Select** to select it

To send multiple contacts, press **Options** > **Share** > **Multiple Contacts** (instead of the current contact).

delete contact(s)

Menu >  **Contacts**, scroll to the contact, press **Options** > **Delete**, press  to select the current contact, press **Yes** to confirm deletion

To delete multiple contacts, press **Options** > **Delete** > **Multiple Contacts** (instead of the current contact).

features

set alarm

Menu >  **Office Tools** > **Alarm Clock**

Shortcut: From the home screen, press **Shortcuts** > **Set Alarm**.

tum off alarm

When the display shows an alarm:

To turn off the alarm, press **Dismiss** or .



To set an eight-minute delay, press **Snooze**.

set calendar default view

Menu >  **Calendar**, press **Options** > **Calendar Setup** > **Default View**

features

add new calendar event

Menu >  Calendar, scroll to the day and/or start time, press , enter event details

You can set a sound file, voice note, or video as a calendar event reminder. When creating a calendar event, select **Alarm Style** > *alarm type*, scroll to the file (or create a new file), press **Insert**.

see calendar event

Menu >  Calendar > *event*

To edit event details, press **Options** > **Edit**.

features

calendar event reminder

When the display shows and sounds an event reminder:

To see reminder details, select **Open Event**.

To close the reminder, press **Dismiss**.

send calendar event to another device

Send a calendar event to another phone, computer, or device:

Menu >  Calendar > *event*, press **Options** > **Share via** > **Bluetooth** or **Message**

manage downloaded files

Manage files and applications that you've downloaded onto your phone from the browser or over a Bluetooth® connection:

Menu >  **Office Tools**
> **Download Manager**

features

world clock

Show time and date information for multiple cities around the world:

Menu >  Office Tools > World Clock

task list

Create a checklist of tasks you need to perform, and set your phone to notify you when task deadlines arrive:

Menu >  Office Tools > Task List

notes

Write and store notes on your phone:

Menu >  Office Tools > Notes

features

record voice note

Menu >  Multimedia

> Voice Recorder, press **Record** to start recording, press **Stop** to stop recording

To save the voice note, press **Save**.

To perform various operations on the voice note, press **Options**.

Note: Recording of phone calls is subject to varying State and Federal laws regarding privacy and recording of phone conversations. Always obey the laws and regulations on the use of this feature.

play voice note

Menu >  Office Tools > File Manager
> Voice Notes > *voice note*

features

calculator

Menu >  Office Tools > Calculator

To use the calculator as a currency converter:

Menu >  Office Tools > Calculator, press **Options** > **Set Exchange Rate**, enter exchange rate, press **Set**, enter amount, press **Options** > **Convert Currency**

Bluetooth® Wireless

Your phone supports Bluetooth wireless connections with other Bluetooth devices.



For maximum Bluetooth security, you should always connect Bluetooth devices in a safe, private environment.

Turn Bluetooth Power On & Off

Your phone automatically turns Bluetooth power on when you use a Bluetooth feature.

To turn Bluetooth power on or off at any time:

Find it: Menu >  Settings > Connections > Bluetooth, press Options > Setup Bluetooth > Bluetooth Power > On or Off

Note: To extend battery life and maximize Bluetooth security, use this procedure to set Bluetooth power to **Off** when not in use.

Your phone will not connect to another device until you use a Bluetooth feature again, or set Bluetooth power back to **On**.

Use a Bluetooth Headset or Handsfree Car Kit

Before you try to connect your phone to a handsfree device for the first time, make sure the device is **on** and **ready** in *pairing* or *bonding* mode (to put the device in pairing/bonding mode, see the user's guide for the device). You can connect your phone with only one device at a time.

Find it: Menu >  Settings > Connections > Bluetooth, press Options > Search For Device > Headset

Your phone lists the Bluetooth audio devices it finds within range.

- 1 Scroll to a device in the list.
- 2 Press  to connect with the highlighted device.

Copy Files to Another Device

You can copy a media file, contact, calendar event, or bookmark to another phone or computer that supports Bluetooth connections.

Note: You can't copy some copyrighted objects.

Before you try to copy a file to another device, make sure the receiving device is **on** and **ready** in discoverable mode. Also, make sure the device is not busy with another Bluetooth connection.

- 1 On your phone, scroll to the object that you want to copy to the other device.
- 2 Press **Options**, then select:
 - **Send To > Bluetooth** for an image or sound file.
 - **Share > contact > Bluetooth** for a contact.
 - **Share Via > Bluetooth** for a calendar event or bookmark.

- 3 Select a recognized device name.

or

Select [**Search For Devices**] to search for new devices, then select the device where you want to copy the object.

- 4 Press **Options > Send**.
- 5 If necessary, enter a mutually agreed upon passkey (such as 0000) on your phone and the device, then press **OK** to connect to the device.

Your phone shows **Sending** while the file is transferred. When file transfer is complete, the phone shows **Send Successful**, and prompts you to press **OK** to continue.

Receive Files from Another Device

Before you try to receive a file from another device, make sure your phone's Bluetooth power is **on** (see page 84).

Place your phone within range (approximately 10 meters/30 feet) of the

other Bluetooth device, and send the file from the device.

If your phone and the sending device were not previously paired, place your phone in discoverable mode so the sending device can locate it. Press **Menu > Settings > Connections > Bluetooth**, press **Options > Discoverable: On for 3 Minutes**. The Bluetooth indicator  in the home screen flashes when your phone is in discoverable mode.

Your phone shows **Incoming Transfer** while the file is transferred. When file transfer is complete, the phone shows **Successful**, and tells you where the file was stored.

Send a Photo to a Printer

You can send a photo to a printer that supports Bluetooth connections.

Note: You can print A4, US Letter, and 4x6 size pages. To print another size, copy the image to a linked computer and print it from there.









- 1 On your phone, take a new photo or scroll to a stored image that you want to print, then press **Options > Print via > Bluetooth**.





Note: If you see **Service Not Supported** when you try to print, select **Send To > Bluetooth** instead. (The **Send To** option does not print the image name or date stamp.)

- 2 Select a recognized printer name, or press **Options > Search For Printers** to search for another printer where you want to send the image.
- 3 If available, modify print options.

More Bluetooth Features

Note: A device is *recognized* after you connect to it once (see page 84).

features
pair with recognized device  Press Menu >  Settings > Connections > Bluetooth, press  left to select the My Devices tab, press  up/down to scroll to the device name, press  to connect.
drop connection with device  Scroll to the connected device name and press  to disconnect.
remove device from device list  Scroll to the device name and press Options > Manage > Remove Device. Note: You can't remove a device from the list while your phone is connected to the device.

features
switch audio to Bluetooth headset or Bluetooth car kit during call  Press Options > Use Bluetooth. To switch audio back to the phone, press Options > Use Handset.
edit properties of recognized device  Scroll to the device name, press Options > Manage > Edit Device.
set Bluetooth options  Press Menu >  Settings > Connections > Bluetooth, press Options > Setup Bluetooth.

Cable Connections

To transfer data between your phone and a computer, insert the micro USB connector plug from a USB cable into your phone's micro USB port. Connect the other end of the cable to the computer.

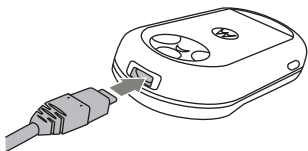



Note: A Motorola Original USB cable and supporting software may be included with your phone. These tools are also sold separately. Check your computer to determine the type of cable you need.

Note: Some phone functions are temporarily unavailable when a USB connection is active.



To use Windows Media Player 11 to **sync music files** from a computer to your phone: Press **Menu** >  **Settings** > **Connections** > **USB Setting** > **Media Synchronization**, then connect your phone to the computer. For more information, see page 65.

To manually **transfer pictures, videos, and music** between your computer and phone: Press **Menu** >  **Settings** > **Connections** > **USB Setting** > **Extended Memory**, then connect your phone to the computer. For more information about manually transferring music files, see page 70.

To use your phone as a **modem**: Press **Menu** >  **Setting** > **Connections** > **USB Settings** > **Modem**, then connect your phone to the computer.

To **transfer contact lists and calendar entries** between your computer and phone: Press **Menu** >  **Settings** > **Connections** > **USB Setting** > **Modem**, then connect your phone to the computer. Open the optional

Motorola Phone Tools accessory application on the computer. You can also use the Motorola Phone Tools application to transfer and sync music files from the computer to your phone. See the Motorola Phone Tools user's guide for more information.

To make **data calls** through a computer: Press Menu >  **Settings** > **Connections** > **USB Setting** > **Modem**, then connect your phone to the computer. Use the computer application to place or answer the call.

To **print** an image over a USB PictBridge connection: Press Menu >  **Settings** > **Connections** > **USB Setting** > **USB Printing**, then connect your phone to a PictBridge-compatible printer. Select the image(s) you want to print, then press **Options** > **Print via** > **USB**.

End a USB Connection

Caution: Do not disconnect your phone from the computer while files are being transferred.

On a PC running Windows XP™ or later:

When file transfer is complete, remove the USB cable from your phone and computer.

On a PC running an earlier version of

Windows OS: Click the Safely Remove Hardware icon in the system tray at the bottom of your computer screen, then select “Safely Remove USB Mass Storage Device.” Remove the USB cable from your phone and computer.

On a Macintosh™ computer: Select and drag the Removable Disk icon to the Trash. Remove the USB cable from your phone and computer.

Sync

You can use an over-the-air connection to synchronize your phone's contact list and calendar entries with a remote SyncML Internet server.



To **synchronize files** with a partner you set up:

Find it:  >  Office Tools > Sync > SyncML

If no SyncML profile is stored on your phone, the phone prompts you to create a profile. Contact your IT system administrator to obtain the information you need to set up a profile.

Note: If your phone can't connect to the server, verify that your phone's network service provider has data service activated on your phone (additional fees may apply for this service).

File Manager

Access and manage photos, videos, music, and other files stored on your phone.

Find it: Menu >  Office Tools > File Manager

Select a folder to see its contents.

To **play** a song file or voice note, or **view** a photo or video, just scroll to the file and select it.

To **edit** a file: Scroll to the file and press **Options** > **Manage** to copy, move, or rename it. Other options let you delete, send, or apply the file. You can't perform some operations on some copyrighted or pre-installed files.

To **copy files** between your phone and a computer, you can use a cable connection (see following section) or a Bluetooth® connection (see page 85).

Phone Software Updates

Sometimes, we think of ways to make your phone's software faster or more efficient after you've purchased your phone. You can find out if your phone can be updated at:

www.hellomoto.com/update

Your service provider can send updated phone software over-the-air to your phone.

When your phone receives a software update, you can install it immediately, or defer installation until later. To install a deferred software update:

Find it: Menu >  Settings

> Phone Settings > OTA Updates

> Update Software

If you have questions or need assistance, we're here to help.

Go to www.motorola.com/myAURA, where you can select from a number of customer care options. You can also contact the Motorola Customer Support Center at 1-800-331-6456 (United States), 1-888-390-6456 (TTY/TDD United States for hearing impaired), or 1-800-461-4575 (Canada).

Specific Absorption Rate Data

This model wireless phone meets the government's requirements for exposure to radio waves.

Your wireless phone is a radio transmitter and receiver. It is designed and manufactured not to exceed limits for exposure to radio frequency (RF) energy set by the Federal Communications Commission (FCC) of the U.S.

Government and by the Canadian regulatory authorities. These limits are part of comprehensive guidelines and establish permitted levels of RF energy for the general population. The guidelines are based on standards that were developed by independent scientific organizations through periodic and thorough evaluation of scientific studies. The standards include a substantial safety margin designed to assure the safety of all persons, regardless of age or health.

The exposure standard for wireless mobile phones employs a unit of measurement known as the Specific Absorption Rate, or SAR. The SAR limit set by the FCC and by the Canadian regulatory authorities is 1.6 W/kg.¹ Tests for SAR are conducted using standard operating positions accepted by the FCC and by Industry Canada with the phone transmitting at its highest certified power level in all tested frequency bands. Although the SAR is determined at the highest certified power level, the actual SAR level of the phone while operating can be well below the maximum value. This is because the phone is designed to operate at multiple power levels so as to use only the power required to reach the network. In general, the closer you are to a wireless base station, the lower the power output.

Before a phone model is available for sale to the public in the U.S. and Canada, it must be tested and certified to the FCC and Industry Canada that it does not exceed the limit established by each government for safe exposure. The tests are performed in positions and locations (e.g., at the ear and worn on the body) reported to the FCC and available for review by Industry Canada. The highest SAR value for this model phone when tested for use at the ear is 0.43 W/kg, and when worn on the body, as described in this user guide, is 0.76 W/kg. The SAR value for this product in its data transmission mode (body-worn use) is 0.76 W/kg. (Body-worn measurements differ among phone models, depending upon available accessories and regulatory requirements).²

While there may be differences between the SAR levels of various phones and at various positions, they all meet the governmental requirements for safe exposure. Please note that improvements to this product model could cause differences in the SAR value for later products; in all cases, products are designed to be within the guidelines.

Additional information on Specific Absorption Rates (SAR) can be found on the Cellular Telecommunications & Internet Association (CTIA) Web site:

<http://www.phonefacts.net>

or the Canadian Wireless Telecommunications Association (CWTA) Web site:

<http://www.cwta.ca>

1. In the United States and Canada, the SAR limit for mobile phones used by the public is 1.6 watts/kg (W/kg) averaged over one gram of tissue. The standard incorporates a substantial margin of safety to give additional protection for the public and to account for any variations in measurements.
2. The SAR information includes the Motorola testing protocol, assessment procedure, and measurement uncertainty range for this product.

European Union Directives Conformance Statement



Hereby, Motorola declares that this product is in compliance with:

- The essential requirements and other relevant provisions of Directive 1999/5/EC
- All other relevant EU Directives

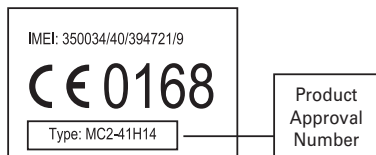

The above gives an example of a typical Product Approval Number.

You can view your product's Declaration of Conformity (DoC) to Directive 1999/5/EC (to R&TTE Directive) at www.motorola.com/rtte. To find your DoC, enter the Product Approval Number from your product's label in the "Search" bar on the Web site.

OPEN SOURCE SOFTWARE INFORMATION

For instructions on how to obtain a copy of any source code being made publicly available by Motorola related to software used in this Motorola mobile device you may send your request in writing to the address below. Please make sure that the request includes the model number and the software version number.

MOTOROLA, INC.
OSS Management
600 North US Hwy 45
Libertyville, IL 60048
USA

The Motorola website opensource.motorola.com also contains information regarding Motorola's use of open source.

Motorola has created the opensource.motorola.com to serve as a portal for interaction with the software community-at-large.

To view additional information regarding licenses, acknowledgments and required copyright notices for open source packages used in this Motorola mobile device, please select **Menu >  Settings > Phone Settings > Legal Notices**. In addition, this Motorola device may include self-contained applications that present supplemental notices for open source packages used in those applications.

A

- accessories 41, 68, 84
- active line indicator 27
- active line, change 45
- airplane mode 29, 75
- alarm clock 80
- alert
 - set 32, 33
 - turn off 27, 39
- alert style indicator 26
- answer a call 19, 42
- answer options, set 42
- audio file formats 70

B

- battery 17
- battery charge indicator
 - light 17
- battery door release latch 2
- battery indicator 26
- battery life, extend 14, 36, 37, 84

- blog 61
- Bluetooth indicator 26
- Bluetooth wireless 68, 84
- bonding, Bluetooth 84
- brightness 37
- browser 54, 73
- browser messages 54

C

- cables, using 88
- calculator 83
- calendar
 - add event 81
 - send event 81
- call
 - answer 19, 42
 - end 19
 - make 19
- call alert 78
- call barring 30, 45
- call forward indicator 27
- call forwarding 45
- call timers 42, 43
- call waiting 44
- caller ID 40, 78
- camera 2, 55, 60
- car kit 41
- certificates 75
- charge indicator light 2
- clean phone 9
- clear/back key 1, 48
- clock 35, 37
- codes 30
- conference call 44, 45

contact list
 add entry 19, 77
 categories 78
 contact list view 76
 copy contacts to phone
 or SIM 77
 default save location 76
 dial entry 19, 76
 filter 79
 picture ID 40
 search 19
 send contact 80
costs, track 43

D

data call 43
date 35, 37
delete data 38
delete text 48
dial a phone number 19, 46
dialed calls 39
display 3, 25, 37
download files 54, 74

download manager 81
drafts folder 52
DTMF tones 46

E

earpiece volume 27
EDGE indicator 26
email
 read 53, 54
 send 53
email address 19, 77
emergency number 40
end a call 19
end key 1, 19
Enter Unlock Code
 message 30

F

feature icons 36
file manager 90
filter contacts 79
fixed dial 46
forward calls 45

G

GPRS indicator 26
group mailing list 79

H

handsfree speaker 2, 29
headset 41
hold a call 44
home screen 3, 25, 36

I

in-call indicator 27
Incoming Call message 40
information services 54
international access code
 44

K

keypad volume, adjust 32

L

language 37
line 1 and line 2 27
linking, Bluetooth 84

lock

- applications 31
- phone 30
- SIM card 31

Low Battery message 26

M

make a call 19

media playback 32

media volume, adjust 32

menu 3, 25

menu icons 25

menu soft key 3, 12

message

- read 52, 53

- send 51

message indicator 26, 52

micro USB port 2, 17, 88

Missed Calls message 40

missed event indicator 27

missed notifications 37

multimedia message 51

multimedia template 53

music

- create playlist 71

- headphones 68

- load from CD 64

- options, set 67, 72

- play 66

- supported file formats

 - 70

- synchronize 65

music player 64

mute a call 44

N

navigation key 1, 12

network settings 45

notes 82

number entry 49

O

OK key 1, 12

open to answer 42

P

pairing. Bluetooth 84

passwords. See codes

phone number

- store 19, 77

- your number 20, 45

photo

- assign to contact 57, 78

- send in message 51, 57

- send to printer 86, 89

- take/store 55

picture ID 40, 78

PIN code 30, 31

PIN2 code 30, 46

power key 1, 19

predictive text entry 48

printing 86, 89

profiles 26

Q

quick note 53

R

- received calls 39
- recent calls 39
- redial 39
- reset settings 38
- resolution 59
- return a call 40
- ring ID 78
- ringer volume, adjust 32
- ringtone
 - assign to contact 78
 - preview 34
 - set 32, 33
 - use song as 67
- rotator 42

S

- screensaver 33, 36, 37
- security code 30
- send key 1, 19
- service dial 46
- shortcuts 21
- signal strength indicator 26

- silent alert style 32
- SIM Blocked message 31
- SIM card 13, 30, 31, 38, 46
- skin 33
- soft keys 1, 25
- software update 91
- speakerphone 41
- speed dial 43
- stereo headphones 68
- store phone numbers 19, 77
- store your phone number 20
- symbol entry 50
- synchronize 90

T

- talking phone 29
- task list 82
- text edit 48
- text entry 47
- text message 51
- text template 53

- theme 33
- time 35
- timers 42, 43
- transfer a call 45
- TTY device 45
- turn on/off 19

U

- unlock
 - applications 31
 - phone 30
 - SIM card 31
- unlock code 30
- USB cables 88

V

- vibrate alert style 32
- video
 - play 62
 - record/store 60
 - send in message 51, 60
 - supported file formats 63
 - upload to blog 61

- video blog 61
- voice command key 28
- voice commands 27
- voice dial 27, 41
- voice note 82
- voicemail 51
- voicemail message
 - indicator 51
- volume 27, 32
- volume key 1, 2, 27

W

- wallpaper 33, 35
- Web pages 73
- world clock 82

Y

- your phone number 20

U.S. patent Re. 34,976

Motorola, Inc.
Consumer Advocacy Office
1307 East Algonquin Road
Schaumburg, IL 60196
www.hellomoto.com

Note: Do not ship your phone to the above address. If you need to return your phone for repairs, replacement, or warranty service, please contact the Motorola Customer Support Center at:

1-800-331-6456 (United States)
1-888-390-6456 (TTY/TDD United States for hearing impaired)
1-800-461-4575 (Canada)

Certain mobile phone features are dependent on the capabilities and settings of your service provider's network. Additionally, certain features may not be activated by your service provider, and/or the provider's network settings may limit the feature's functionality. Always contact your service provider about feature availability and functionality. All features, functionality, and other product specifications, as well as the information contained in this user's guide are based upon the latest available information and are believed to be accurate at the time of printing. Motorola reserves the right to change or modify any information or specifications without notice or obligation.

MOTOROLA and the Stylized M Logo are registered in the US Patent & Trademark Office. The Bluetooth trademarks are owned by their proprietor and used by Motorola, Inc. under license. Java and all other Java-based marks are trademarks or registered trademarks of Sun Microsystems, Inc. in the U.S. and other countries. Microsoft and Windows are registered trademarks of Microsoft Corporation; and Windows XP and Windows

Media are trademarks of Microsoft Corporation. Macintosh is a registered trademark of Apple Computer, Inc. iTunes is a trademark of Apple Computer, Inc., registered in the U.S. and other countries. All rights reserved. All other product or service names are the property of their respective owners.

© 2008 Motorola, Inc. All rights reserved.

Caution: Changes or modifications made in the radio phone, not expressly approved by Motorola, will void the user's authority to operate the equipment.

Software Copyright Notice

The Motorola products described in this manual may include copyrighted Motorola and third-party software stored in semiconductor memories or other media. Laws in the United States and other countries preserve for Motorola and third-party software providers certain exclusive rights for copyrighted software, such as the exclusive rights to distribute or reproduce the copyrighted software. Accordingly, any copyrighted software contained in the Motorola products may not be modified, reverse-engineered, distributed, or reproduced in any manner to the extent allowed by law. Furthermore, the purchase of the Motorola products shall not be deemed to grant either directly or by implication, estoppel, or otherwise, any license under the copyrights, patents, or patent applications of Motorola or any third-party software provider, except for the normal, non-exclusive, royalty-free license to use that arises by operation of law in the sale of a product.

Manual Number: 68000201823-A

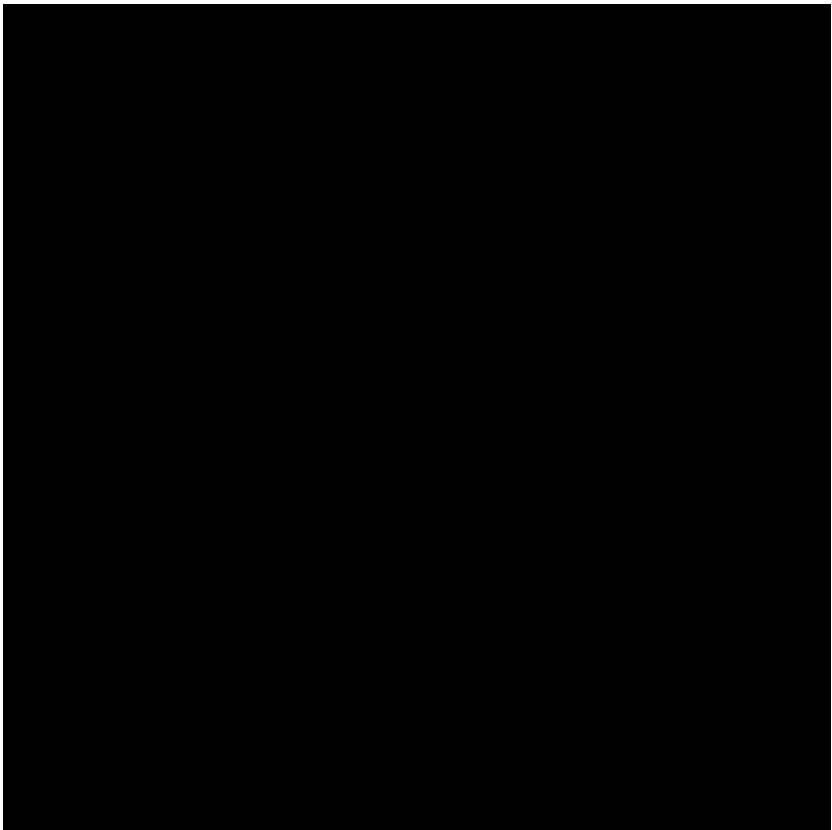

www.motorola.com

