



# DSR205

User Guide



This user guide is for use with DSR205 Digital Satellite Receivers

Publication #516581-001

Rev A

All Rights Reserved

General Instrument Corporation doing business as the  
Broadband Communications Sector of Motorola, Inc. (Motorola BCS)

6450 Sequence Dr.

San Diego, California 92121

Internet: <http://www.mot.com>

Copyright © 2004 Motorola, Inc.

All rights reserved. No part of this publication may be reproduced in any form or by any means or used to make any derivative work (such as translation, transformation or adaptation) without written permission from Motorola, Inc.

Motorola reserves the right to revise this publication and to make changes in content from time to time without obligation on the part of Motorola to provide notification of such revision or change. Motorola provides this guide without warranty of any kind, either implied or expressed, including but not limited to, the implied warranties of merchantability and fitness for a particular purpose. Motorola may make improvements or changes in the product(s) described in this manual at any time.

# IMPORTANT SAFETY INSTRUCTIONS

**WARNING: "DANGER OF EXPLOSION IF BATTERY IS INCORRECTLY REPLACED. REPLACE ONLY WITH THE SAME OR EQUIVALENT TYPE."** To reduce the risk of fire or electric shock, do not expose this unit to rain or moisture. Do not open the unit. Refer servicing to qualified personnel only.

**CAUTION: TO PREVENT ELECTRIC SHOCK, MATCH WIDE BLADE OF PLUG TO WIDE SLOT, FULLY INSERT.** To prevent electric shock, do not use this (polarized) plug with an extension cord receptacle or other outlet unless the blades can be fully inserted to prevent blade exposure.



**Lightning Flash Icon.** The lightning flash with arrowhead symbol within an equilateral triangle is intended to alert the user to the presence of un-insulated "dangerous voltage" within the product's housing that may be strong enough to constitute a risk of electric shock to persons.



**Exclamation Point Icon.** The exclamation point within an equilateral triangle is intended to alert the user to the presence of important operating and maintenance (servicing) instructions in the literature accompanying the appliance.

This digital apparatus does not exceed the Class A/Class B (whichever is applicable) limits for radio noise emissions from digital apparatus as set out in the Radio Interference Regulations of the Canadian Department of Communications.



**Read, Follow and Keep Instructions.** Before you operate the unit, read and follow all of the safety and operating instructions. Keep the safety and operating instructions for future reference.



**Heed Warning.** Pay attention to all warnings on the equipment and in the operating instructions.



**Cleaning.** Do not use liquid cleaners or aerosol cleaners. Use a damp cloth to clean the outside of the unit. Do not open the unit for cleaning or any other reason.



**Power Cord Protection.** Place power supply cords so that they are not walked on or pinched by items placed on or against them. Pay particular attention to the cords where they join the plug, near convenience receptacles, and where they exit from the equipment.



**Power Sources/Grounding.** Operate the equipment from the type of power source indicated on the marking label. This product has a polarized alternating-current line plug as a safety feature. This plug fits into the power outlet only one way. If the plug does not fit, contact your electrician to replace your obsolete outlet. Do not try to change the plug or defeat its safety purpose.



**Ventilation.** Do not block or cover the slots and openings of the unit. They provide ventilation and protect it from overheating. Never place the unit on carpeting, which it may block ventilation through the bottom slots. Never place the unit near a source of heat or in a built-in installation rack unless there is proper ventilation. Do not place near heat sources such as radiators, stoves, or other products (including amplifiers) that produce heat.



**Do Not Operate near Water.** Do not use this product near water, for example, near a bath tub, wash bowl, kitchen sink, swimming pool, laundry tub, in a wet basement, or in similar situations.



**Objects or Liquid in the Unit.** Never push any object into this unit through any of its openings because they may touch dangerous voltage points or short out the parts. This could cause a fire or any electrical shock. Do not spill liquid of any kind on the unit.



**Laser Light.** Use or controls or adjustments or performance of procedures other than those specified may result in hazardous radiation exposure. Avoid direct eye exposure. Keep out of reach of children. The laser light emitted from this device should not be directed towards people, under any circumstances.



**Overloading.** Do not overload power outlets or extension cords. This can result in a risk of fire or electrical shock.



**Damage Requiring Service.** Unplug this equipment from the power source, and contact a qualified service provider if any of the following situations occurs:

- If the power supply cord or plug is damaged.
- If liquid or objects have fallen into the unit.
- If the unit became wet from rain or water.
- If the unit was dropped or damaged.
- If the unit's performance changes.



**Service.** Do not try to service this product yourself. If you open or remove the cover, you may be exposed to dangerous voltage or other hazards and may void the unit's warranty. Contact a qualified service provider for all service.



**Mounting and Placement.** Do not place this product on an unstable surface such as a cart, stand, tripod, bracket, or table. It may fall, causing serious injury to a child, adult, or to the unit itself. To mount the unit, follow the manufacturer's instructions, and use a mounting accessory recommended by the manufacturer. Do not place this product directly on wood or simulated wood surfaces because these surfaces may be damaged.



**Power Lines.** Do not locate the satellite antenna system near overhead power lines, electrical light or power circuits, or where it can fall into power lines or circuits. When installing a satellite antenna system, avoid dangerous contact with power lines or circuits.



**Outdoor Antenna Grounding.** To provide some protection against voltage surges, lightning, and built-up static charges, make sure that the satellite antenna is properly grounded.



**Outdoor Cable Protection.** Protect all outdoor connections from moisture. During installation, treat all of the cable connectors on your LNB with coax seal, even if the connection is installed under a weatherproof cover. Internal heating can draw moisture or condensation into the covering of the unit and affect its operation. Do not use silicone seal because it has a tendency to form air pockets.



**Replacement Parts.** If your receiver requires repairs, contact your equipment provider, who will be able to assist you.



**Safety Check.** After the unit is serviced or repaired, ask the service technician to perform safety checks to find out if the unit is in proper operating condition.



**Lightning.** To protect the product from damage caused by lightning and power line surges, unplug it from the wall outlet and disconnect it from the antenna or cable system before a lightning storm or if the unit will be left unattended or unused for a long period of time. Once a storm passes, reconnect all antenna cables to the correct connectors. If you live in an area that has many lightning storms, buy polarized surge protectors and surge protectors for the power line, telephone line, and RF cable to protect your system from damage. Never attempt to connect or disconnect any wires during a thunderstorm or lightning storm.

## Note to the system installer:

The purpose of this reminder is to call your attention to Article 820-40 of the NEC that provides guidelines for proper grounding and, in particular, specifies that the cable ground shall be connected to the grounding system of the building, as close to the point of cable entry as practical. The illustration is an example of antenna grounding according to the National Electrical Code Section 810, "Radio and Television Equipment." Check your local building and electrical codes for other restrictions on antenna grounding.

1. For the ground wire, use No. 10 AWG (5.3mm<sup>2</sup>) copper, No. 8 AWG (8.4mm<sup>2</sup>) aluminum, No. 17 AWG (1.0mm<sup>2</sup>) copper-clad steel or bronze wire, or larger.
2. Secure the antenna lead-in wire and ground wires to the house with stand-off insulators spaced 4 ft. (1.22m) to 6 ft. (1.83m) apart.
3. Mount the antenna discharge unit as close as possible to the place where the lead-in enters the house.
4. Use a jumper wire that is no smaller than No. 6 AWG (13.3mm<sup>2</sup>) copper, or the equivalent, when using a separate antenna grounding electrode. See NEC Section 810-21(1).
5. In areas that are heavily prone to lightning storms install a lightning rod mounted to the top of the antenna on the back side. Install a ground strap (2 AWG, or larger, of copper wire) from the lightning rod to the rest of the antenna ground system.
6. Section 810 of the National Electrical Code, ANSI/NFPA No. 70-1984, provides information about the following items:
  - Proper grounding of the mast and supporting structure.
  - Grounding of the lead-in wire to the antenna discharge unit.
  - Size of grounding conductors.
  - Location of antenna-discharge unit.
  - Connection to grounding electrodes.
  - Requirement for the grounding electrode.

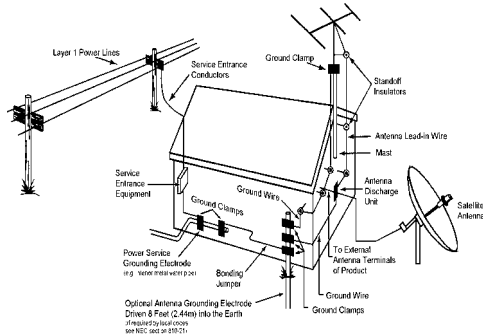

## **Programming Copyright Notice**

Use of this device may violate Section 605 of the Communications Act of 1934, as amended, if that use consists of the unauthorized interception and divulgence of radio communications for one's own benefit where there is no entitlement to its receipt.

Changes or modifications to this device not expressly approved by the party responsible for compliance with FCC regulations (the manufacturer) could void the user's authority to operate the equipment.

Resale of signals received from broadcast satellites is explicitly regulated. In any use or application involving resale or distribution, the user should verify compliance with current laws, regulations, and approved procedures for use. Where required, local and federal licensing or franchise authorization is the sole responsibility of the user.

Export of this device requires a valid export license issued by the U.S. Department of Commerce.

## **FCC Compliance**

This equipment has been tested and found to comply with the limits for a Class B digital device, pursuant to Part 15 of the FCC Rules. These limits are designed to provide reasonable protection against harmful interference in a residential installation. This equipment generates, uses, and can radiate radio frequency energy and, if not installed and used in accordance with the instructions, may cause harmful interference to radio communications. However, there is no guarantee that interference will not occur in a particular installation.

## **FCC Part 68**

This equipment complies with Part 68 of the FCC rules. Located on the equipment is a label that contains, among other information, the FCC registration number and Ringer Equivalence Number (REN). If requested, this information must be provided to the telephone company.

The REN is used to determine the quantity of devices which may be connected to the telephone line. Excessive REN's on the telephone line may result in the devices not ringing in response to an incoming call. In most, but not all areas, the sum of the REN's should not exceed five (5.0). To be certain of the number of devices that may be connected to the line, as determined by the total REN's contact the telephone company to determine the maximum REN for the calling area.

This equipment cannot be used on the telephone company-provided coin service. Connection to party line service is subject to state tariffs.

If this equipment causes harm to the telephone network, the telephone company will notify you in advance that temporary discontinuance of service may be required. If advance notice isn't practical, the telephone company will notify you as soon as possible. Also you will be advised of your right to file a complaint with the FCC if you believe it is necessary.

If trouble is experienced with this equipment, please contact:

Star Choice Communications, Inc.  
1-888-554-STAR

If the trouble is causing harm to the telephone network, the telephone company may request you to remove the equipment from the network until the problem is resolved.

This equipment uses the following USOC jacks: RJ11C

## IMPORTANT SAFETY INSTRUCTIONS

It is recommended that the customer install an AC surge arrester in the AC outlet to which this device is connected. This is to avoid damaging the equipment caused by local lightening strikes and other electrical surges.

This equipment is Hearing-Aid Compatible (HAC).

## User Instructions

If this equipment does cause interference to radio or television reception, which can be determined by turning the equipment off and then on, the user is encouraged to try to correct the interference by one or more of the following measures:

- Reorient or relocate the receiving antenna.
- Increase the distance between the equipment and receiver.
- Connect the equipment into a different outlet so that the equipment and receiver are on different branch circuits.
- Consult the dealer or an experienced radio/TV technician for help.

Changes or modifications not expressly approved by Motorola could void the user's right to operate the equipment and/or the equipment warranty.

Copyright © 2004 Motorola, Inc.

MOTOROLA, the Stylized M Logo, TVPass and DigiCipher are registered in the US Patent & Trademark Office. All other product or service names are the property of their respective owners. Certain third party trademarks are used throughout this manual for explanatory purposes only. The depiction of any third party trademark in typed form, or graphical form, in this manual should not be taken to imply any relationship, sponsorship, endorsement, license between Motorola, Inc. and the owner of such third party trademark, or any other affiliation. Such trademarks, and graphical representations thereto, include NBC, Bravo, History Channel, CBS, WGN, Lifetime, A&E, HGTV, ESPN, Fox, ESPN2, CNN, Discovery, PBS, CMT, Playboy, TMN, "National Geographic: On Assignment", "Blind Faith", "Art and Racing", "Defiance", "Doug", "Hey Arnold!", "Ace Ventura", "Fatal Affair", "Bravo!", "Authors", "The Avengers", "Interiors", "House", "Build", "ESPN Now", "Rodeo", "Automovilismo", "American Muscle", "CNN/Sports Illustrated Sports News", "The Sixth Sense", "Discovery Kids", "Discovery Science", "Discovery Health" and are the property of their respective owners. Further, any other third party trademarks not listed herein are the property of their respective owners. © Motorola, Inc. 2004

Covered under one or more U.S. patents: 4613901, 4634808, 4712238, 4792973, 4823399, 4864615, 4908859, 4933898, 4975951, 5068724, 5081680, 5083293, 5091782, 5093720, 5111504, 5446664, 5216295, 5216374, 5216503, 5345408, 5376968, 5398237, 5406228, 5485577, 5517250, 5530400, 5537420, 5565922, 5566089, 5580203, 5598415 and patents pending.

### ATTENTION

This consumer unit is intended for the decoding of DigiCipher® II television signals for consumer use. Possession of this device does not enable or entitle the possessor to receive DigiCipher II television signals. Contact program providers to obtain appropriate authorization.

### WARNING

The unauthorized modification of any decoder and the sale and use of any such decoder is prohibited by law. Any such modification or alteration of this product or any unauthorized reception of television programming could subject the user and/or seller and/or party modifying the decoder to fines, imprisonment and civil damages.



# Table of Contents

<b>IMPORTANT SAFETY INSTRUCTIONS</b> .....	<b>i</b>
Note to the system installer: .....	iii
User Instructions .....	v
Equipment Attachment Limitations .....	v
<b>Installation</b> .....	<b>1</b>
Connecting the Satellite Dish, Receiver, and TV .....	1
Front Panel Key Descriptions .....	2
Back Panel Connections .....	2
Using the Menus .....	3
Choosing the Menu Language .....	3
Acquiring a Signal .....	4
Authorizing Your Receiver .....	4
Completing the Receiver Connections to Your Entertainment System .....	5
Connections to Audio/Video Monitor .....	5
Connections to Audio/Video Monitor and VCR .....	5
Additional Features .....	6
Viewing and Language Settings .....	7
Audio Settings .....	7
Installation Settings .....	7
System Status .....	8
Authorization Screens .....	8
<b>Using Your Remote</b> .....	<b>9</b>
Key Functions .....	10
Programming the Remote Control .....	12
If Your Four-Digit Code is not in the Tables (Scanning) .....	13
Programming the Master Power Feature .....	13
Verifying Your TV, DVD, VCR and AUX Mode Codes .....	14
Volume Control Crossover .....	14
If You Have More Than One Satellite Receiver .....	14
Replacing the Remote Control Batteries .....	15
"Remote Energy Saver" .....	15
<b>Watching TV</b> .....	<b>23</b>
How to Select Menu Options .....	23
Banners .....	24
Interactive Program Guide (IPG) .....	25
How to Display the Guide .....	25

Interests and Favorites .....28

**Options .....31**

    How to Display and Use the Options Menu .....31

    Opening Your Mail .....32

    Setting Favorite Channels .....34

    Setting Parental Controls & Passwords .....35

    Setting Timers .....38

    List Purchases .....42

    Change System Settings .....43

    Installation Settings .....45

    System Status .....45

**Specifications .....47**

    Input .....47

    Video .....47

    Remodulator Output .....48

    Audio .....48

**Warranty & Service .....49**

# 1

## Installation

### Connecting the Satellite Dish, Receiver, and TV

Complete the following steps, and make sure that the satellite receiver is *not plugged into a power source* before you connect any cables to the receiver:

- Connect the cable from the satellite dish to the satellite terminal on the satellite receiver's back panel. Connect the supplied three-wire (red, yellow, and white) cable from the TV terminal on the satellite receiver's back panel to TV IN (or coaxial cable to VHF IN) terminal on your TV.
- On the back panel of the satellite receiver, set the CH3 CH4 switch which is located just above the TV terminal—to the same channel that you set on your TV for use with your VCR.
- Turn on the TV and tune it to channel 3 or 4 to match the position of the switch on the back panel of the satellite receiver.
- Plug the satellite receiver power cord into a standard power outlet. *Wait one minute*, and then press the POWER key on the left side of the satellite receiver's front panel.



## Front Panel Key Descriptions

- 1. POWER.** Press this key to turn the receiver power on/off and to watch programs in SAT mode.
- 2. REMOTE .** An indicator dot blinks each time you press a key on the remote control.
- 3. SIGNAL .** An indicator lights up when a satellite signal is present. Green indicates a good signal. Red indicates no signal.

## Back Panel Connections

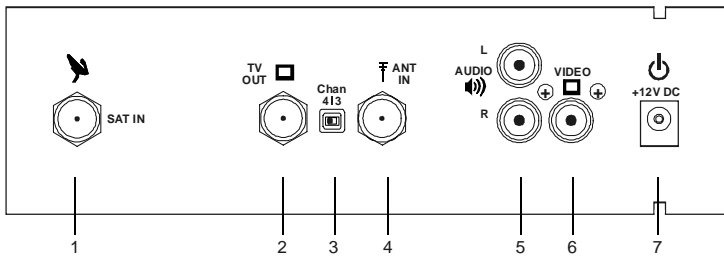

- 1. SATELLITE IN.** This terminal receives LNB input.
- 2. ANTENNA IN.** This is an off-air antenna terminal.
- 3. CH3 CH4.** This switch determines the channel (3 or 4) to which you set your TV to receive satellite broadcasts. The setting should be the same as the TV setting for use with your VCR (usually channel 3).
- 4. OUT TO TV.** This supplies the VHF signal to your TV.
- 5. AUDIO OUT (R L).** These are audio outputs, which may be used to connect to your TV or VCR. Volume levels are not adjustable.
- 6. TO VCR.** This video output jack may be connected to your VCR input connections for VCR taping.
- 7. POWER.** This is the power block input.

## Using the Menu

You will be making various adjustments to your receiver using the keys on the remote control. Press Options on the remote control. The Change System Settings option provides access to menus that allow you to adjust the operation of your system.

- Press the ◀ ▶ keys or the ▲ ▼ keys to highlight the option you wish to select. Then press the ENTER key to select it.
- If the options are numbered, simply press the number key for an option.



## Choosing the Menu Language

To make sure that the menus are displayed in the appropriate language for you, complete the following steps:

- While your receiver is turned on, aim the remote control at the receiver and press the OPTIONS key. The Options menu will appear.
- From the Options menu, select option 6 (Change System Settings), and the System Settings menu will appear.
- Select option 1 (Change Viewing and Language Settings), and the Viewing & Language Settings menu will appear.
- Option 3 shows you the language options available for the menus. Press the ▲ ▼ keys on the remote to select your language.
- Once you have chosen a language, press the GO BACK key until you return to the Options menu or press the EXIT key to exit and return to watching programs.



## Acquiring a Signal

Complete the following steps to help you acquire a signal:

- Using the number keys on the remote control, tune to the authorization channel (refer to the information supplied with your system). You should see a banner with the channel number at the top of the screen.
- Press the **OPTIONS** key on the remote control. The Options menu will appear.
- From the Options menu, select option 6 (Change System Settings), and the System Settings menu will appear.
- Select option 3 (Change Installation Settings), and on the Installation Settings menu select option 1 (Tune in Satellite Signal).
- Look at the value in the box labelled Signal. If it is less than 10, make sure that all connections between the satellite dish LNBF and the satellite receiver are correct. If the signal strength remains below 10, contact your service provider for assistance.
- Using the number keys on the remote control, enter the Provider ID supplied by your service provider (refer to the information supplied with your system). You can use the ◀ key on the remote control to back up and make corrections.
- If the satellite dish is pointed at the correct satellite, the large field in the center of the screen will turn green and display the message "Correct signal found". If you do not see this message within 5 to 10 minutes, the satellite dish may be pointed at the incorrect satellite. Contact your service provider for assistance.

## Authorizing Your Receiver

- Press the **EXIT** key on the remote control. Then press the number keys for the authorization channel.
- Press the **OPTIONS** key on the remote control. The Options menu will appear.
- From the Options menu, select option 6 (Change System Settings), and the System Settings menu will appear.



- Select option 4 (Check System Status), and the System Status menu will appear. Line A shows your Unit ID number.
- Telephone the company that provides your programming subscription, and ask to authorize your unit.
- When your receiver has received the authorization message the Trip Counter on the Installation Settings menu will advance.

## Completing the Receiver Connections to Your Entertainment System

You will need to make changes to connect your VCR.

- Connect the top/left TV terminal on the back panel of the receiver to the IN terminal on the VCR. If you had already connected this cable to your TV you must disconnect and connect it to your VCR.
- Connect the OUT terminal(s) on the VCR to the VHF IN terminal(s) on the TV.

## Connections to Audio/Video Monitor

Complete the following steps if you only plan to connect the satellite receiver to an audio/video monitor:

- Using standard RCA-type audio/video cables, connect the top/left TV (VIDEO output) terminal on the rear panel of the receiver to the video input terminal on the monitor (or TV using the baseband inputs).
- Using standard RCA-type audio/video cables, connect the two bottom/left speaker (R and L) terminals on the back panel of the receiver to the audio input terminals on the monitor (or TV using the baseband inputs).

## Connections to Audio/Video Monitor and VCR

Complete the following steps if you plan to connect the satellite receiver to an audio/video monitor and VCR:

- Using standard RCA-type audio/video cables, connect the top/right TV (VIDEO output) terminal on the rear panel of the receiver to the video input terminal on the VCR.
- Using standard RCA-type audio/video cables, connect the two bottom/right Speaker icon (R and L) terminals on the rear panel of the receiver to the audio input terminals on the VCR.
- Using standard RCA-type audio/video cables, connect the audio and video

inputs on the audio/video monitor (or TV using baseband audio/video inputs) to the outputs on the VCR.

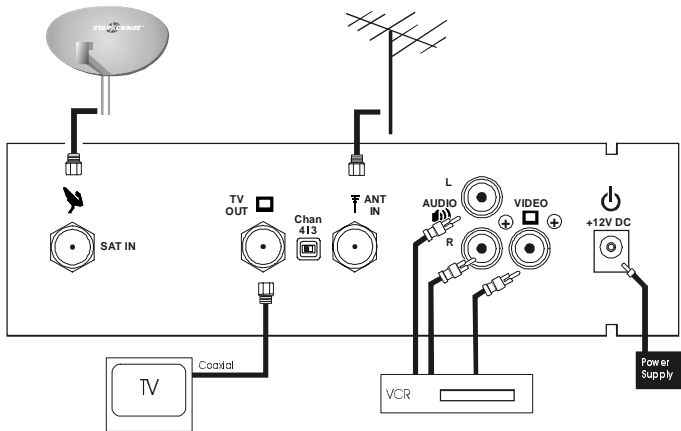

## Additional Features

After you complete the installation procedures, you may wish to use the on-screen menus to make additional adjustments to the satellite receiver's operation.

**Options.** The Options menu provides access to all of the on-screen menus. It appears when you press the **OPTIONS** key on the remote control.

**Change System Settings.** The Change System Settings menu provides access to menus that allow you to adjust the operation of your system.

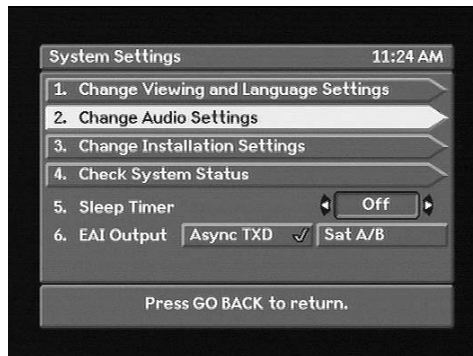



## Viewing and Language Settings

**Channel Information.** The Channel Information option allows you to turn the header (top of screen) and banner (bottom of screen) On or Off. The default setting is On.

**Subtitles.** The Subtitles option allows you to select the language for subtitles (if available for the particular program) or keep them turned off. The default setting is None.

**Language.** The Language option allows you to select the language of the on-screen menus and audio for your programs. The default setting is English.

**TV Viewing.** The TV Viewing option allows you to select the size of the viewing area. Select the Standard option if your TV screen is a typical screen with a 4:3 ratio of width to height. Select Wide if your TV screen is a wide screen with a 16:9 ratio (as in HDTV's or digital TV's). The default setting is Standard.

## Audio Settings

If you are in SAT mode (digital) broadcast, two options appear on the Audio Settings menu.

**Audio Connections.** Select option 1 (Audio Connections), and you will be able to select either TV or HiFi (the default is TV). Select TV if the receiver's AUDIO OUT port is connected to your TV. Select HiFi if it is connected to your stereo system.

**Satellite Audio.** Select option 2 and then select Mono, Stereo, or Surround.

## Installation Settings

**Tune in Satellite Signal.** This option allows you to see the strength of the signal your antenna is receiving.

**Set Remote Control Address.** This option allows you to control up to four receivers in a centralized area, with one or more remote controls. Each receiver requires a separate address. The default address is 0000.

On the front panel of your receiver press the Menu button to bring up the Menu screen.

- Choose Options.
- Choose option 6 (Change System Settings).
- Choose option 3 (Installation Settings).

- On the Installation Settings menu, choose option 2 (Set Remote Control Address). Now follow the instructions on the Remote Control Address screen.
- If you have four receivers, you will have to change the addresses on three of them: they will have address of 0000, 0001, 0002, and 0003.

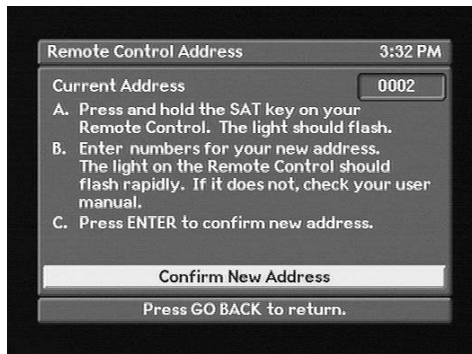

To program your remote control for each receiver, hold down the SAT key on the remote control until the light flashes. Once the light begins to flash enter the desired address.

## System Status

This is a view-only screen that displays information about the status of the receiver.

**Trip Counter.** Trip Counter displays the number of message updates from your service provider.



## Authorization Screens

Sometimes when you tune to a program, an Authorization screen will appear. It will fade to black after a short time, it will reappear when:

- The channel or program is locked out because of your parental control setting, which requires you to enter a password. (If you have not set a password, just press the ENTER key.)
- The receiver is not authorized.
- A subscription is required to receive the program.
- There is a program blackout in your area.
- There is a technical problem.

## Using Your Remote

All around the world, people just like you are enjoying entertaining, educational, and informational programming with a Motorola digital satellite receiver. In addition to offering outstanding picture and sound quality, your receiver comes with a remote control that can be programmed to operate your receiver, TV and auxiliary equipment.

**A Word About Modes.** To enable the remote control to operate your receiver, your TV, and your VCR, it may have as many as five main modes of operation: SAT mode, TV mode, DVD mode, VCR mode and AUX mode. This means that when you press the SAT, TV, DVD, VCR or AUX keys on the remote control, you enable it to control each of these devices, one at a time. Naturally, some of the remote control keys have more than one function, depending upon which mode you are using at the time. Keep this in mind as you read the descriptions for each remote control key. Also keep in mind that some SAT functions are available only within SAT mode. Among these special functions are access to the menus through the OPTIONS key, use of the Interactive Program Guide (IPG) through the GUIDE key, and the ability to select a satellite by using the SAT key.



## Key Functions

**Power.** To turn the component on or off.

**SAT(mode).** To change the remote to SAT mode so it can control the receiver for viewing satellite and cable TV signals as well as the OPTIONS menu.

**TV(mode).** To change the remote to TV mode so it can control the TV.

**VCR(mode).** To change the remote to VCR mode to control the VCR.

**DVD(mode).** To change the remote to DVD mode to control the DVD.

**AUX(mode).** To change the remote to AUX mode to control auxiliary components.

**Source.** To control the input source to your satellite receiver, your TV, your VCR or your auxiliary components.

- In SAT mode, it shifts between satellite or cable and antenna input.
- In TV mode, it shifts between auxiliary antenna and video sources.
- In VCR mode, it shifts between TV input and VCR input.
- In DVD mode, it shifts between TV input and DVD input.
- In AUX mode, it allows input from auxiliary components.

**PPV.** To display the current Pay-Per-View selections.

**Options.** To exit any menu and display the Options menu.

**Interests.** To exit any menu and display the Interests menu. Press it again to remove the Interests menu and return to watching a program.

**Browse.** To view program information for channels and times other than the current channel and time while continuing to view a program. Press GO BACK to return to watching a program. Press ENTER to go to the program located in the Browse banner.

**Future.** To display a program banner for what's on in the future while you are watching a program.

**Guide.** To display the Interactive Program Guide (IPG). Press it again to return to program viewing.

**Go Back.** To return to the previous menu.

**Enter.** For convenience, there are two ENTER keys. If you are using a menu, press ENTER to select a highlighted option. In SAT mode press ENTER to tune in the channel whose numbers you have already pressed.

**Arrow Keys.** To highlight selections from menu screens. Also used in the Browse banner to navigate between listings.

**Exit.** To exit any menu and watch a program or to display a program information if you are already watching a program.

**Last Ch.** To return to the last channel viewed.

**Info.** To display detailed information about the current program or a highlighted program in the Guide. Press it again to turn the information off.







**Vol.** To raise or lower the volume level.

**Mute.** To mute the TV sound.

**Chan.** If you are using a menu, press to change channels without removing the menu. If you are using the Guide, press to move one page up or down.

**Number Keys.** These keys operate in different ways, depending upon which mode you are in:

- While using the menus, press these keys to select a numbered option.
- If you are watching a program, press these keys and ENTER to change channels. If the channel has three numbers, it will tune in immediately after you enter the third number. Generally speaking, cable TV channels (analog) are numbered 1-99, and satellite TV channels are assigned numbers 100 and above.

**VCR Keys.** The remote control has separate keys that operate the VCR's play (  ), stop (  ), pause (  ), fast-forward (  ), rewind (  ), and record functions. Press and hold the record (  ) button then press play (  ) to perform the record function.

**Help.** To display the help screens. Press it again to turn off the help screens and return to watching a program. If you occasionally forget what an icon (symbol) means or how to use one of the satellite receiver features, just press the HELP key to display the Help messages. Press the ENTER key to display each successive Help screen.

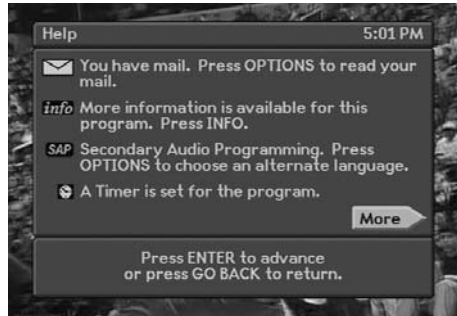

Some screens provide explanations that help you to use receiver features.

If you forget what certain keys or icons mean, just look them up by displaying this screen.

## Programming the Remote Control

The remote control is set at the factory to control all of the satellite receiver functions, but to use it to operate your TV, DVD, VCR and auxiliary components as well, you must "program" it for the brand you own. Follow these instructions to program the remote to control your TV, DVD, VCR and auxiliary (AUX) components.

Follow these instructions to program the remote to control your TV.

1. Turn on the desired component for programming.
2. Use the table that appears later in this section to find the manufacturer brand.
3. After the manufacturer's brand name is a four-digit code number (or several four-digit codes).
4. Press and hold the appropriate mode key on the remote control for at least three seconds—until the light on your remote flashes.
5. When the light flashes, key in the first of the four-digit codes (listed in the table) for your component using the number keys on the remote control. Make sure to do this accurately and without a long delay.
6. If the remote control "accepts" the code, you will see several rapid flashes of the light. If it does not flash, repeat steps 4, and 5. After the remote control accepts the code, press the POWER key on the remote control to make sure the remote control is able to turn your component off. This means it is functioning properly.
7. If your component does not respond to the remote control POWER key, even though it has "accepted" the manufacturer's code, repeat steps 4 and 5 using the second four-digit code from the table. If this does not work, try the third code, etc., until the remote control accepts the code and your component responds to the remote control POWER key.

**NOTE:** Some cable box brands are also programmable using these instructions. Check the table that appears later in this section for applicable cable box brands and codes. You will press the TV key to program your cable box. Your remote can only accept a TV or cable box code for this programming step.

## If Your Four-Digit Code is not in the Tables (Scanning)

If you try to program your remote control using the four-digit codes, and the remote control does not work correctly, you may be able to find a code that works by using the "scanning" process.

1. Turn on the TV.
2. Press the TV key for at least three seconds—until the LED blinks.
3. The following steps explain how to "scan" through the TV codes stored in your remote control using the  $\blacklozenge$  keys. (The LED will not be lit while the  $\blacklozenge$  keys are depressed.
  - While pointing the remote control at your TV, press the  $\blacktriangle$  key to scan upward to the next code. (Use the  $\blacktriangledown$  key to return to the previous code.)
  - If the transmitted code is the correct one, your TV will turn off, responding as if its POWER key were pressed.
  - If your TV does not respond, depress the  $\blacktriangle$  key to try the next code. When your TV turns on or off as a result of the transmitted code, you will know that you have found the correct code.
  - When you have found the correct code (power to your TV is toggled on or off), press the ENTER key. This will store the manufacturer's code. The LED will then flash rapidly several times and turn off.

NOTE: If your TV is not listed in the tables and/or the codes for your brand are not accepted by the remote, you will need to use the remote originally manufactured for your unit.

## Programming the Master Power Feature

If you wish to control the power on/off function of your receiver and TV with a single press of the POWER key on your remote control, you can enable the remote control's Master Power feature by following these steps:

- Press the SAT key on the remote control for at least three seconds—until the light on the key blinks.
- Press the POWER key on the remote. The light will remain on steady. Press the power key a second time, and the light on the remote will blink on and off briefly, which indicates that the remote has accepted the Master Power command.
- If you wish to cancel the Master Power feature, just repeat the steps outlined above.

## Verifying Your TV, DVD, VCR and AUX Mode Codes

You can verify the accepted programming codes for each mode by following these steps.

1. Press the TV key for at least three seconds—until the LED blinks.
2. Press the "INFO" key.
3. The LED will blink, indicating the code of your TV in the following sequence. For example, if your TV code is for a Tandy brand TV (code 1005) the blink pattern will be:
  - Pause>long blink "1;"
  - Pause>short blink "0;"
  - Pause>short blink "0;"
  - Pause>long blink, long blink, long blink, long blink, long blink "5."

A zero in the code will always be represented by a short blink.

## Volume Control Crossover

Your remote control unit is programmed from the factory to control the volume of your television set when you are using the remote control in the TV mode. The AUX mode can also be programmed to control the audio from the TV or Audio device. To program your remote control for this function:

- Enter the programming mode using the AUX mode key.
- While the AUX mode key is flashing, press and release the AUX mode or TV mode key (depending on which device you want remote volume and mute control).
- The AUX mode key will light as you press and release the programming mode key, flash three times rapidly and extinguish.
- The remote control will now control the volume of the SAT device when in the AUX mode.

## If You Have More Than One Satellite Receiver

If you have more than one receiver, you may want to prevent the remote controls from affecting the other receivers. To prevent this kind of interference, you must "pair" each remote control with one receiver. In order to do this, you will have to assign a new "address" to each pair of remote controls and receivers so that each pair functions independently of the others.



Using the remote control press the Menu button to bring up the Menu screen on the receiver monitor (TV).

- Choose Options, choose Change System Settings.
- Choose Installation Settings.
- On the Installation Settings menu, choose Set Remote Control Address. Now follow the instructions on the Remote Control Address screen.
- If you have multiple receivers, you will have to change the address on each of them. Choose from following addresses: 0000, 0001, 0002, or 0003.

To program your remote control for each receiver, hold down the SAT key on the remote control until the light flashes. Once the light begins to flash enter the desired address.

## Replacing the Remote Control Batteries

When the remote control batteries are worn out (discharged), the remote will stop working. Replace the batteries as soon as possible to retain your programmed codes. Once you remove the batteries from the compartment, you must replace them within two hours to retain your programmable features. The remote control for this unit may be powered by two AA batteries. Use only high quality, non-corrosive batteries designed for use in electronic equipment. Remember to replace both batteries at the same time. To replace the batteries:

- Remove the cover by pressing down the back panel indentation and removing the panel off the remote control.
- Position each battery in the battery compartment so that the flat base (-) is against the spring and so that the raised contact (+) is against the terminal. Make sure the batteries are securely seated. Replace the cover.

## "Remote Energy Saver"

If you misplace your remote (i.e., it is stuck in your couch), and a key is inadvertently pressed, the remote will automatically turn itself off after three minutes.

## TV Codes

ABI	1064	Emerson	1017,1023,1026,1028,1033
AOC	1005,1006,1019,1020,1023,1024		1034,1035,1037,1038,1039
	1120,1140,1163,1173		1041,1090,1122,1132,1141,1143
Accent	1065		1160,1163,1171,1172,1176,1181
Admiral	1003,1018,1034,1041		1203,1222,1224,1225,1227
	1069,1090,1125,1129,1176	Envision	1163
Adyson	1073	Fisher	1042,1090,1099
Aiko	1024	Fujitsu	1034
Aiwa	1090	Funai	1024,1034,1041,1132
Akai	1000,1032,1070,1074,1075,1077	Futuretech	1041
	1081,1083,1085,1094,1095,1097,1100	General Electric	1003,1008,1009,1023
	1101,1103,1105,1106,1107,1108,1111		1043,1044,1125,1130,1134,1143
	1115,1116,1124,1127,1128,1133,1135		1163,1165,1170,1172,1182,1207,1211
	1136,1137,1138,1139,1149,1163,1172	Goldstar	1005,1023,1026,1028,1045
Alaron	1034		1046,1088,1120,1146,1163,1168
Alba	1142		1172,1173,1194,1224,1225
Amark	1120,1224,1225	Gradiente	1060
Amstrad	1033,1132	Granada	1146
Anam	1005,1009,1021,1041,1120,1121	Grundig	1162
Anam National	1211	Hallmark	1023,1172
Apex	1159	Hinari	1034,1146
Archer	1120	Hitachi	1005,1018,1023,1024,1026
Audiovox	1024,1041,1120,1170		1044,1048,1049,1050,1051,1052
BPL	1144		1053,1054,1055,1126,1169,1172
Bang & Olufson	1154		1177,1183,1194,1210,1224,1225
Bell & Howell	1018,1034,1090,1129	Infinity	1010,1066,1151
Broksonic	1005,1010,1172,1173	JBL	1010,1066,1151
	1174,1176	JC Penney	1003,1005,1006,1014,1016
CXC	1041		1026,1043,1044,1096,1125,1131
Candle	1005,1006,1022,1023,1025,1163		1134,1149,1163,1165,1172,1194
Capehart	1019		1207,1224
Carver	1151	JVC	1057,1058,1059,1060,1061,1185
Centurion	1028,1192,1194	Jensen	1056
Citizen	1005,1006,1010,1016,1018,1022	KEC	1041
	1023,1024,1025,1026,1163,1172,1224	KMC	1224,1225
Concerto	1005,1010,1023	KTV	1026,1039,1041,1163,1172,1224,1225
Contec	1041,1054,1091,1181,1227	Kenwood	1006,1163
Corando	1224	Kloss	1022,1110,1175
Coronado	1225	LXI	1003,1010,1066,1090,1117,1125,1129
Craig	1021,1041,1203		1131,1132,1134,1151,1172,1173,1194
Crown	1026,1041	Lloytron	1224
Curtis Mathes	1006,1016,1018,1023,1026	Lodgenet	1018
	1041,1059,1090,1125,1131,1151	Loewe	1146,1186
	1163,1172,1192,1194,1224,	Logik	1018
Daewoo	1005,1023,1024,1026,1029,1030	Luxman	1023
	1032,1130,1146,1170,1171,1172,1224	MGA	1004,1005,1006,1023,1034,1071
Daytron	1024,1026,1192,1194,1224		1072,1149,1163,1172,1192,1194
Denon	1169	MTC	1005,1006,1010,1016,1023,1024,1163
Dimensia	1125	Magnasonic	1024,1034,1129,1131,1151
Dixi	1120,1146	Magnavox	1000,1006,1008,1010,1017,1020
Dumont	1001		1024,1025,1027,1028,1034,1066,1067,1068

**TV Codes (continued)**

Majestic	1018	Samsung	1005,1006,1016,1023,1026,1032
Marantz	1006,1010,1066,1068,1072	..	1088,1112,1146,1155,1157,1158,1163,1167
.....	1088,1146,1149,1151,1163,1172	.....	1172,1173,1192,1194,1205,1224,1225
Matsui	1032,1109,1146	Sansui	1176
Memorex	1018,1032,1034,1072	Sanyo	1041,1042,1089,1090,1091
.....	1090,1149,1172	.....	1092,1109,1184,1194
Midland	1001,1003,1165	Scott	1026,1034,1037,1041,1093
Mitsubishi	1004,1005,1023,1034,1070	.....	1172,1173,1192,1194,1224
.....	1071,1072,1122,1123,1129,1149	Sears	1003,1010,1016,1023,1034
.....	1172,1173,1188,1192,1194	.....	1042,1090,1096,1098,1099,1102,1104
Multitech	1041	.....	1117,1125,1131,1132,1134,1151,1172
NAD	1002,1117,1131,1166,1172	.....	1184,1194,1224,1225
NEC	1005,1006,1007,1009,1023	Sharp	1026,1091,1129,1141,1200,1224,1225
.....	1028,1036,1090,1141,1149,1163	Signature	1018,1129,1151
.....	1172,1173,1191,1192,1193,1194,1195	Sony	1000,1189
National	1008,1011,1145	Soundesign	1023,1025,1034,1041,1172
.....	1151,1190,1196,1211	Spectricon	1120
Nikkai	1113,1118,1146	Starlite	1041
Onwa	1041	Supra	1022,1023
Optimus	1012,1090,1166	Sylvania	1006,1010,1024,1025,1066,1068
Optonica	1129,1141	.....	1110,1112,1132,1151,1163,1172
Orion	1037,1146,1176,1212	.....	1173,1175,1192,1194
Osume	1091	Symphonic	1041,1132,1179
Panasonic	1008,1009,1010,1011,1012	TMK	1005,1023,1172
.....	1040,1066,1147,1151,1153,1165	TNCi	1015
.....	1196,1197,1198,1211	Tandy	1112,1113,1129
Philco	1005,1006,1009,1010,1024	Tatung	1009,1146,1211
.....	1025,1067,1068,1110,1149,1151,1163	Technics	1008,1012,1165
.....	1169,1172,1175,1176,1224,1225	Techwood	1023,1165
Pioneer	1002,1008,1031,1048,1051,1076	Teknika	1004,1005,1016,1018,1022,1023
.....	1131,1166,1199,1202,1204	.....	1024,1025,1026,1034,1041,1072,1114
Portland	1005,1024,1026,1172,1224,1225	.....	1149,1151,1224,1225
Proscan	1125,1152,1172	Telerent	1018,1224
Proton	1006,1013,1019,1023,1026	Teletech	1032
.....	1120,1172,1224	Thomson	1051
Pulsar	1001,1024	Toshiba	1016,1017,1090,1096,1117,1118
Quasar	1008,1009,1012,1165,1211	.....	1129,1131,1180,1201,1206
RCA	1003,1005,1008,1009,1014,1028	Totevision	1026,1224
.....	1047,1048,1063,1078,1079,1080	Universal	1043,1044,1207
.....	1082,1084,1086,1087,1125,1130	Vector Research	1006,1163
.....	1134,1149,1168,1172,1182,1210	Victor	1057,1060
Radio Shack	1003,1026,1041,1072,1090	Video Concepts	1070
.....	1112,1141,1172,1173,1194,1224	Vidtech	1005,1023,1169,1172,1173
Realistic	1035,1041,1090,1112,1141,1163	Viking	1022
.....	1172,1194,1222,1224	Wards	1005,1006,1008,1018,1023,1034,1043
Runco	1001,1163	.....	1044,1067,1068,1119,1125,1141,1151
SSS	1005,1041	..	1163,1172,1173,1182,1192,1194,1207,1224
Saba	1051	Westinghouse	1037,1041,1090,1130
Saisho	1032,1033,1109	.....	1170,1171,1190
Sampo	1006,1019,1156,1163,1192,1194	Yamaha	1005,1006,1163,1090,1192,1194
		Zenith	1001,1018,1024,1169,1178
		Zonda	1120

## DVD Players

Aiwa	3179
Akai	3163
Apex	3004
Apex Digital	3001
Cinevision	3223
Denon	3006,3222,3223,3224,3239,3241
Emerson	3002
Ferguson	3205
Fisher	3189,3236
Funai	3225
General Electric	3205
Goldstar	3221,3233,3247
Harman Kardon	3004,3005
Hitachi	3181,3226
JVC	3006,3117,3250
KLH	3187
Kenwood	3007,3227,3253
LG	3008
Magnavox	3002,3228,3229,3230,3231
Marantz	3009,3231
Memorex	3010
Mitsubishi	3228,3230,3232,3234
NAD	3005,3012,3228
Nakamichi	3013
Nordmende	3205

Onkyo	3003,3014,3230
Panasonic	3003,3015,3016,3188,3235
	3236,3239,3240,3241
Philips	3002,3009,3011,3017,3229,3230,3231
Pioneer	3018,3188,3228,3244
Proceed	3007
Proscan	3019,3205
Quasar	3236
RCA	3001,3205,3245
Radio Shack	3225
Runco	3207
Saba	3205
Samsung	3000,3020,3208,3209,3230
Sanyo	3189
Sharp	3021,3197,3253
Sherwood	3246
Sony	3000,3215,3216,3217,3220
Sylvania	3002
Technics	3235,3236,3240,3241
Theta Digital	3229
Thomson	3022,3201,3205
Toshiba	3023,3228,3230,3253
Yamaha	3024,3214,3239,3241,3254,3255
Zenith	3203,3221,3230,3233,3247

## VCR Recorders

ASA	2065,2134
Admiral	2085,2178
Aiwa	2056,2088,2202
Akai	2008,2013,2014,2015,2016,2018,2019
	2020,2068,2086
Alba	2046
American High	2054,2158
Amstrad	2088
Audio Dynamics	2013,2030,2046,2086
Audiovox	2056
Bell & Howell	2049,2175,2177
Broksonic	2005,2008,2059,2148
Bush	2089
CCE	2176
Candle	2042,2046,2056,2080,2092,2149
Canon	2042,2054,2154,2158
Capehart	2046
Carver	2065,2136
Cineral	2176
Citizen	2034,2046,2056,2091,2092
Craig	2044,2056,2082,2091
Curtis Mathes	2034,2051,2054,2088,2092,2105
	2114,2139,2149,2154,2158
DBX	2013,2030,2046,2086
Daewoo	2034,2046,2049,2150,2176
Daytron	2046
Denon	2173
Dimensia	2105
Dual	2086
Dumont	2049
Dynatech	2034,2088,2161
Electrohome	2056,2068

Emerson	2005,2006,2008,2009,2010,2011
	2012,2034,2056,2059,2068,2070,2088
	2090,2132,2148,2150,2169,2176,2190,2192
Finlandia	2049
Finlux	2049,2065,2088,2134
Fisher	2048,2049,2081,2082,2084,2175
Fuji	2054,2158
Funai	2088
General Electric	2025,2033,2050,2051,2052
	2054,2091,2105,2133,2139,2149,2154
	2158,2167,2174,2178,2194
Go Video	2057,2058,2091,2164,2165,2186
Goldstar	2030,2033,2056,2092,2102
Goodmans	2085,2089,2161
Gradiente	2061,2062,2088
Granada	2049,2081
Grundig	2065,2134
HQ	2034
Harman Kardon	2030,2065,2069,2136
Hinari	2089
Hitachi	2013,2037,2038,2040,2086,2088
	2094,2095,2139,2173
ITT	2018,2086
JC Penney	2030,2046,2050,2052,2054,2056
	2080,2081,2091,2092,2094,2114,2139,2149
	2154,2158,2173,2175
JVC	2030,2046,2061,2062,2063,2064,2081,
	2086,2092,2123,2158,2168
Jensen	2013,2086
Kenwood	2046,2062,2081,2086,2088,2092
Kodak	2056,2158
LXI	2034,2056,2088,2173,2175
Lloyd	2088

**VCR Recorders (continued)**

Logik	2089
Luxor	2018
MEI	2054,2158
MGA	2067,2068,2070,2169
MTC	2080,2088,2091
Magnavox	2027,2033,2034,2050,2054,2065 2076,2085,2088,2111,2130,2134,2136 2137,2138,2139,2158,2159
Magnin	2091
Marantz	2030,2046,2054,2065,2081,2085,2092 2102 2134,2136,2139,2158,2159,2161
Marta	2056
Matsui	2088
Matsushita	2054,2114,2137,2138,2139,2154,2158
Memorex	2033,2049,2054,2056,2066,2081,2082 2085,2088,2091,2114,2158,2161,2178
Minolta	2094,2173
Mitsubishi	2062,2067,2068,2069,2070,2071 2124,2125,2140,2169,2178
Motorola	2054,2158,2178
Multitech	2088,2089,2091,2154,2174
NAD	2073,2153
NEC	2013,2030,2031,2032,2046,2049 2062,2081,2086,2092,2102,2128,2158,2160
National	2054
Nokia	2176
Olympus	2054,2158
Optimus	2049,2056,2088,2091,2114,2154,2178
Optonica	2085,2130,2161
Orion	2005,2006,2021
Panasonic	2023,2034,2054,2078,2098,2114,2129 2137,2138,2139,2149,2154,2158,2170,2171
Pentax	2037,2092,2094,2173
Philco	2054,2076,2088,2111,2134,2137 2138,2139,2154,2158,2176
Philips	2034,2054,2065,2085,2088,2134,2136 2138,2139,2154,2155,2158,2161
Pioneer	2046,2062,2073,2074,2075,2076,2111
Portland	2046
Proscan	2034,2065,2105,2136,2138,2154,2173
Pulsar	2033,2088,2154
Quartz	2081
Quasar	2054,2078,2114,2129,2137,2139 2149,2158,2170
RCA	2003,2025,2027,2028,2034 2037,2051,2054,2065 2088 2091 2094,2105,2136,2138,2139,2147 2154 2158 2173,2178,2194
Radio Shack	2054,2056,2068,2081,2082 2084,2085 2088 2091,2114,2130 2154,2161,2172
Realistic	2049,2054,2056,2080,2081 2082,2084,2085 2088 2091,2130,2139,2149,2154,2158,2161,2175 2178
SBR	2065,2134,2155
STS	2173
Saisho	2006,2009
Salora	2067,2081
Samsung	2015,2034,2079,2080,2088 2091,2165,2174 2186
Sanky	2178
Sansui	2013,2032,2046,2062,2086 2088
Sanyo	2044,2048,2049,2081,2082 2083,2084,2175 2176 2177
Schneider	2089
Scott	2008,2009,2034,2059,2067 2070,2090,2169,2174
Sears	2034,2048,2049,2054,2056 2081,2082,2084 2088 2094,2158 2173,2175
Semp	2034,2080
Sentra	2046
Sharp	2068,2085,2130,2161,2178
Signature	2085,2088
Sony	2000,2001,2002,2054,2158
Soundesign	2088
Sylvania	2050,2054,2065,2067,2070 2076,2088,2111 2134 2136,2137 2139,2154,2158,2159,2169
Symphonic	2088
TMK	2006,2091,2190
Tandy	2049,2068,2081,2082,2084 2085,2088,2161
Tashiko	2088
Tatung	2013,2086
Teac	2013,2086,2088
Technics	2054,2114,2138,2154,2158
Teknika	2054,2056,2087,2088,2158
Toshiba	2034,2035,2067,2070,2084 2086,2090,2169
Totevision	2056,2080,2091
Unitech	2080,2091
Vector	2034
Vector Research	2030,2046,2067,2092
Victor	2062
Video Concepts	2030,2034,2046,2068,2088 2092
Videosonic	2091
Wards	2027,2033,2054,2065,2068 2080,2082,2085 2088 2089,2090,2091,2130,2136,2158,2161,2173 2178
XR-1000	2158
Yamaha	2013,2030,2046,2081,2086 2088,2092,2175
Zenith	2033,2062,2088

## Cable Boxes

AT&T	6238	Pulsar	6065
Americast	6128	Radio Shack	6023,6131
Cablevision	6103,6104	Regal	6089,6090
Eagle	6006	Regency	6007,6017
Eastern	6007,6015,6017	SL-Marx	6007
General Instrument	6055,6235,6236	Samsung	6006,665
	6238,6241,6242,6243	Scientific Atlanta	6066,6067,6069,6070,6239,6240
Hamlin	6088,6089,6090	Signal	6006
Hitachi	6053	Signature	6053
Hyundai	6127	SkyCable	6129
Jerrold	6050,6053,6055,6120,6163	Sprucer	6014,6249
	6190,6235,6236,6237,6238,6241,6242,6243	Starcom	6055,6235
Lodgenet	6200	Stargate	6007,6022,6065,6063
Macom	6044	Sylvania	6072
NSC	6020	Texscan	6072
Oak	6056,6057,6058,6059	Tocom	6241,6242,6243
Orion	6018	Videoway	6248
Panasonic	6014,6099,6249,6250	Viewstar	6020
Philips	6004	Visionetics	6106
Pioneer	6064,6108,6244,6245,6246	Zenith	6247,6248

## CD Players

ADC	3025	Nakamichi	3049
Aiwa	3026,3027	Nikko	3036,3050
Burmeister	3028	Onkyo	3051,3052
California Audio	3058	Optimus	3053
Carver	3029	Panasonic	3054,3055,3056
DKK	3033	Polk Audio	3057
Daewoo	3030,3031	QED	3047
Denon	3032	Quasar	3058
Fisher	3034	RCA	3059
Genexxa	3035,3036,3037	SAE	3047
Harmon	3038,3039,3040	Sansui	3060
JVC	3042,3043	Sears	3061
Jensen	3041	Sharp	3062
Kenwood	3044,3045,3046	Sony	3063
Linn	3047	Tascam	3028
MTC	3028	Teac	3064,3065
Magnavox	3048	Victor	3066
Mission	3047	Yamaha	3067,3068,3069
NSM	3047		

## Satellite Receivers

4DTV	0000
General Instrument	0000,0001,0002,0003 0004,0005,0006,0007
Motorola	0000,0001,0002,0003 0004,0005,0006,0007
Next Level	0000
Star Choice	0000

## Amplifiers

Adcom	4024,4032,4042	MCS	4021
Admiral	4101,4185	Memorex	4151
Aiwa	4020,4033,4102,4103,4104	Meridian	4025,4095
	4149,4150,4151,4152,4173	Mitsubishi	4045,4082
Akai	4075,4119,4153,4207	Modulaire	4170
AMC	4040,4208	Mondial	4029,4065,4144
Anam	4065	NAD	4099
Audio Alchemy	4154	Nakamichi	4074,4084,4157,4217
Audio Design	4054	NEC	4076
Audio Matrix	4209	Onkyo	4050,4061,4070,4071,4085
Audio Source	4155		4096,4124,4218,4219
B & K	4010	Optimus	4037,4059,4075,4175,4176
B&K	4026	Panasonic	4038,4080,4126,4177,4220
Bose	4020,4211	Parasound	4035,4178
Carver	4022,402,54083,4091,4093,4094,4147	Philco	4179
Casio	4021,4170	Philips	4015,4086,4093,4181
Cinema Sound	4036	Pioneer	4023,4062,4088,4187,4221
Citation	4052,4212	Proton	4182,4183
Clarion	4059	RCA	4053,4063,4089,4119,4129
Curtis Mathes	4021		4130,4131,4158,4184,4222
Daewoo	4105	Realistic	4018,4067,4072,4170,4185
Denon	3032	Rotel	4019,4233,4234
Denon	4036,4106,4107,4108,4109,4110	Samsung	4189
DKK	3033	Sansui	4015,4016,4063,4074,4133,4223,4224
Emerson	4163	Sanyo	4083,4147
Fisher	3034	Schneider	4134
Fisher	4083,4087,4147,4158	Scott	4031,4191,4192
Garrard	4075,4163	Sears	4021
General Electric	4067,4159	Sharp	4059,4106,4135,4239
Goldstar	4112	Sherwood	4051,4073,4136,4138
Harman Kardon	4039,4052,4113,4160,4212		4193,4194,4195,4196
Hitachi	4077,4110	Sontec	4197
Inkel	4193	Sony	4000,4001,4002
JBL	4078,4161		4003,4004,4005,4006,4007
JC Penney	4021,4148,4170	Sound Stream	4027,4030
Jensen	4114,4206	Soundesign	4049,4140
JVC	4034,4041,4043,4044,4079	SSI	4249
Kenwood	4058,4059,4083,4087,4135,4162,4214	Teac	4058,4074,4075,4090,4223,4225,4226
Koss	4148,4163,4164	Technics	4056,4057,4076,4080
Krell	4017		4126,4177,4199,4200
Lexicon	4165	Topline	4201
Linn	4008	Toshiba	4100
Lloyds	4170	Vector Research	4171,4202
Luxman	4069,4127,4166,4167,4168	Victor	3066
LXI	4021,4067,4169	Victor	4009
Magnavox	4028,4119,4170,4210	Wards	4083
Marantz	4015,4074,4081,4086,4091	Yamaha	4053,4059,4060,4145
	4093,4094,4099,4120,4171		4180,4203,4204,4227
McIntosh	41224172	Yorx	4170
MCS	4021	Zenith	4205,4206,4228

## Combination TV/VCRs, TV/DVD

Aiwa . . . . .	5251	Philips . . . . .	5223,5236,5237,5251
Apex . . . . .	5011	Pioneer . . . . .	5235
Audio Dynamics . . . . .	5234	Proscan . . . . .	5233
Broksonic . . . . .	5219	Pulsar . . . . .	5248
Curtis Mathes . . . . .	5231,5251	Quasar . . . . .	5231,5232
DBX . . . . .	5234	RCA . . . . .	5231,5233,5251
Daewoo . . . . .	5233,5250,5252	Radio Shack . . . . .	5230,5232,5251
Electrohome . . . . .	5240	Realistic . . . . .	5223,5251
Emerson . . . . .	5219,5223,5226,5251,5252,5253	Runco . . . . .	5243
Funai . . . . .	5251	Samsung . . . . .	5221,5229,5233,5244,5245,5246
General Electric . . . . .	5231,5233,5248	Sansui . . . . .	5219,5235,5251
Goldstar . . . . .	5223,5230,5234,5254	Sanyo . . . . .	5244,5245
Harman Kardon . . . . .	5234	Scott . . . . .	5233
Hitachi . . . . .	5231,5251	Sears . . . . .	5223,5251
Hughes . . . . .	5024	Signature . . . . .	5251
JC Penney . . . . .	5223,5231,5232,5234	Sony . . . . .	5232
JVC . . . . .	5234,5235	Soundesign . . . . .	5251
Kenwood . . . . .	5234,5251	Sylvania . . . . .	5050,5237,5240,5251
LXI . . . . .	5223,5251,5254	Symphonic . . . . .	5251
MGA . . . . .	5240	Tandy . . . . .	5251
MTC . . . . .	5251	Teac . . . . .	5251
Magnavox . . . . .	5012,5231,5236,5237,5251	Technics . . . . .	5232
Marantz . . . . .	5234,5237	Teknika . . . . .	5223,5251
Marta . . . . .	5223	Toshiba . . . . .	5013,5228,5233,5240
Memorex . . . . .	5223,5232,5244,5245,5248,5251	Totevision . . . . .	5223
Mitsubishi . . . . .	5239,5240	Vector Research . . . . .	5234
Multitech . . . . .	5251	Victor . . . . .	5235
NEC . . . . .	5234	Video Concepts . . . . .	5234,5251
Optimus . . . . .	5232	Wards . . . . .	5251
Orion . . . . .	5219,5226	Yamaha . . . . .	5234,5251
Panasonic . . . . .	5010,5231,5232,5255	Zenith . . . . .	5219,5223,5235,5248,5249,5251
Philco . . . . .	5236,5237,5251		

## Home Theater

Fujitsu . . . . .	4066
JVC . . . . .	4068
Pioneer . . . . .	4048
Venturer . . . . .	4190



## Watching TV

Once you become accustomed to the various controls and features, you will spend most of your television viewing time enjoying the programs made available through the satellite receiver. *The features described in this section will be available to you when the remote control is set to SAT mode—in other words, when you have pressed the SAT key and are viewing various programs.*

### How to Select Menu Options

As you use the many menus, you will be asked to select various options. When you see the word *select*, it is important that when you use the remote control, there are two ways to select a menu option:

1. Press the ◀ ▶ keys or the ⬄ keys to highlight an option. Then press the ENTER key to select it.
2. If the options are numbered, simply press the number key for an option. You do not have to press the ENTER key.

### Headers

Your viewing screen displays a variety of information about the programs you are viewing or plan to view. When you tune in a channel, a header appears at the top of the screen. It displays the following information from left to right:

- Interests—Until you identify your viewing interests nothing appears on the left side of the header. After you select an interest such as Pay Per View, the name of the interest you selected will appear on the left side of the header.
- Channel name—NBC-W, BRAVO, HISTORY, etc.
- Channel number—A number from 1 to 999.
- Message—An envelope icon appears if a message is waiting for you.
- Time—The current time automatically appears on the right side of the header.

## Banners

Program banners appear at the bottom of the screen:

**On Now banner**—When you tune in a channel, this banner displays the current program title, start and end times, and rating icon. Press EXIT to remove the banner.

While you are viewing a channel, if you press the FUTURE key, the Browse Banner displays the next program's title, start and end times, and ratings icon. Press EXIT to remove the banner.



### Info Banner

To obtain detailed information about the current program, press the INFO key.

To obtain detailed program information about the next program on a selected channel, press the INFO key and then press the FUTURE key or the ► key. If the On Next Banner is already displayed at the bottom of your screen, just press the INFO key to display more detailed information about the next program. Press the ◀ key to return to the information display for the current program.

### Browse Banner



Browse is used to view current program information while viewing a program. Browse is also used to view information for channels and times other than the current channel and time. Press GO BACK to return to watching a program. Press ENTER to change channels to the program located in the Browse banner or set timers for future programs.

- Press GO BACK to return to watching a program.
- Press FUTURE to go to a different day and/or time.

- Press the **◆** keys to scroll through the channels.
- Press the **◀ ▶** keys to scroll through the next or previous program.
- Press ENTER to change channels to the program located in the Browse banner.
- While in Browse, to obtain more detailed information about the program displayed, press the INFO key.

## Interactive Program Guide (IPG)

The Interactive Program Guide (IPG) provides access to current and future program information while you watch TV. It displays a 90-minute block of scheduled programs, and can be used as a starting point for purchasing IPPV programs and settings timers.

### How to Display the Guide

- Press the GUIDE key once. (displays 6 channels at once).
- Press the GUIDE key a second time or press the EXIT key to return to watching TV programs.
- Press the GO BACK key to return to the menu last viewed (or return to watching TV).



### How to Use the Guide

- Press the **◆** keys to display different channels.
- Press the **◀ ▶** keys to scroll backward and forward by half-hour increments.
- Enter a particular channel number to display that channel at the top of the screen.
- Press the ENTER key to tune to a current program that is highlighted. If you press the ENTER key on a future program, a detailed program information banner appears (discussed later in this section).
- Press the INFO key to display more detailed information.
- Press the CHANNEL + and – keys to page up and down through the Guide.

## Guide Screen

The header (top of screen) displays the current Interests menu setting (sports, movies, etc.) on the left side and the time on the right. The line below the header displays the day of the program information being viewed. The rest of the screen displays the channel names and numbers on the left and the program names on the right. The Guide screen displays 6 programs at a time.

### How to Display a Future Day and Time on the Guide

You can always scroll ahead with the Guide, but if you want to immediately look at program offerings for another day or a specific time, you can jump ahead without scrolling. To jump to a specific date and time:

- Display the Options menu (press the OPTIONS key on the remote control).
- Select option 2 (Guide & Favorites). The Guide & Favorites menu appears.
- Select option 1 (Set a Future Day & Time for the Guide). A Choose Day menu appears.
- Select which day of the Guide you would like to display. A Choose Time menu will appear.
- Select the time of day for the Guide programming you would like to view.  
Short Cut: Press the FUTURE key after pressing GUIDE. You can go directly to the Choose Day menu.

Press the GUIDE key. The Guide will return to displaying the current day and time. If you press the GO BACK key, you will return to the previous screen or the program you were watching.

### How to View the Guide by Interests

You can also focus the Guide display to a list of your favorite channels or to special programming interests (such as sports or movies). To select an interest:

- Press the INTERESTS key. The Interests menu will appear.
- Highlight one of the listed choices and press the ENTER key.
- The Guide will appear and display only programs that pertain to the interest (such as sports) that you have selected. For example, if you have selected a list of favorite channels (Favorites A, B, C or D), the Guide will display only the list of favorite channels you have selected. (Refer to the section entitled "Setting Favorite Channels" to select the channels you want to include in your Favorites list.)
- Future interest programming by day and time can be viewed by pressing the FUTURE key on the remote while in GUIDE.



### Detailed Program Information

Press the INFO key to display a program information banner that has a detailed description of the program, ratings, purchasing information, and information icons.

### Setting a Timer for a Future Program

Using the Guide, you can set a timer to automatically display a program at a future time and date. If you are viewing a programming list for a future date or time on the Guide, press the ENTER key or the INFO key while a program is highlighted to display the detailed program information banner. This banner includes a Timer button. Select the Timer button by pressing the ENTER key to display a Confirm Timer screen. Confirm the Timer by pressing the ENTER key again. You will return to the Guide and a Timer icon will appear in the lower right corner of the program cell. Press INFO again or press the GO BACK key to turn off the detailed information and return to the Guide. More information on timers is in the section entitled, "Options: Setting Timers."

## Interests and Favorites

You have the choice to scan every channel when you "channel surf." But to help you locate channels and shows of specific interest to you, the receiver has an Interests menu that helps you to focus your channel surfing.

- By using the Interests menu, you can quickly locate programs according to a particular theme or surf through four lists of favorite channels.

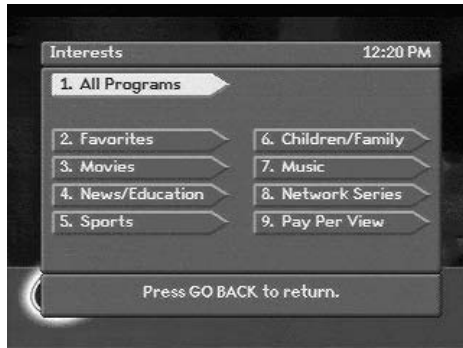

### How to Display and Use the Interests Menu

- Press the INTERESTS key on the remote control. The Interests menu appears.
- To select an interest (for example, All Programs, Favorites A, B, C, D or Network Series, News/Education, Movies, Sports, Pay Per View, or Music/Radio), highlight one of these options and press the ENTER key. The Guide will appear and display channels or programs that pertain to the interest you selected. Remember that once you have selected one of the options (or interests) from the Interests menu:

A. The information you see in the Guide will be limited to programming that matches the interest you selected. If there is no programming that matches the interest, a message will appear notifying you of this.

B. You will notice that while you are watching a program or channel, the left side of the header will display the interest you selected. If there is no programming matching the selected interest, a message will appear notifying you of this.

- Press the INTERESTS key again to display the Interests menu and change your selection.

**1 All Programs.** Each time you turn on the receiver, it automatically returns to the All Programs setting. When this option is selected, you will be able to scan for all programs while channel surfing or when you are using the Guide.

**2 Favorites A, B, C, D.** If you select Favorites A, B, C or D, you will be able to limit your channel surfing and the Guide information listings to channels that are listed in the Favorites A, B, C or D lists. If you have not yet made a list of favorite channels, a message will instruct you to do so.

**3 Movies.** If you select this interest, you will be able to channel surf exclusively for movies.

**4 News/Education.** If you select this interest, you will be able to channel surf exclusively for news/education programs.

**5 Sports.** If you select this interest, you will be able to channel surf exclusively for sports programs.

**6 Children/Family.** If you select this interest, you will be able to channel surf exclusively for children/family programs.

**7 Music.** If you select this interest, you will be able to channel surf exclusively for music programming.

**8 Network Series.** If you select this interest, you will be able to channel surf exclusively for network series programs.

**9 Pay-Per-View.** If you select this interest, you will be able to channel surf exclusively for Pay-Per-View (PPV) programs.





## Options

### How to Display and Use the Options Menu

The Options menu is your doorway to a series of menu screens that allow you to set up various features for program viewing. There is one procedure for displaying the Options menu if you are using the remote control, and there is another if you are using the keys on the Front Panel of the receiver.



If you are using the remote control, press the **OPTIONS** key. The Options menu will appear.

If you are using the front panel of the receiver, press the **MENU** key. When the Menu screen appears, press the **◆** keys to highlight **Options**, and then press the **ENTER** key. The Options menu will appear.

The following list will give you a broad overview of the menu options and the features they control.

- 1. Open Your Mail.** This option lets you read personal, programming, or promotional messages. Look for the envelope icon on your viewing screen.
- 2. Set Guide & Favorites.** This option allows you to select a future day and time for viewing IPG listings. It also allows you to create a list of favorite channels that can be used for selective channel surfing and to limit the programs displayed on the IPG to a particular group.

**3. Set Parental Control (and Passwords).** Parental Control features and passwords allow you to control the programs, channels, and subject matter that can be viewed with your receiver.

**4. Set Timers.** This option allows you to set a timer to view (or record) a program at a future time and day up to one year in advance.

**5. List Purchases.** This list shows the date, time, cost, and name of each purchased program.

**6. Change System Settings.** There are a variety of topics available through this menu option including language, audio, installation and system status settings. The Sleep Timer is also located under this option.

## Opening Your Mail

Your receiver is able to display a variety of messages that are sent to it. Some messages will be displayed on your screen as soon as they arrive, but others are stored in your mailbox for you to retrieve. If a message is waiting in your mailbox, the envelope icon will appear on your screen header while you are watching a program. This feature applies to viewing in SAT mode only.

### How to Display the Mailbox Menu

- Press the OPTIONS key to display the Options Menu.
- Select option 1 (Open Your Mail). The Mailbox menu appears.

### Mailbox Menu

The Mailbox menu displays a list of numbered message titles, each with a date. If you wish to read the entire contents of a message, select the message (while the message is highlighted, press the ENTER key), and a message screen will appear within the Mailbox menu.

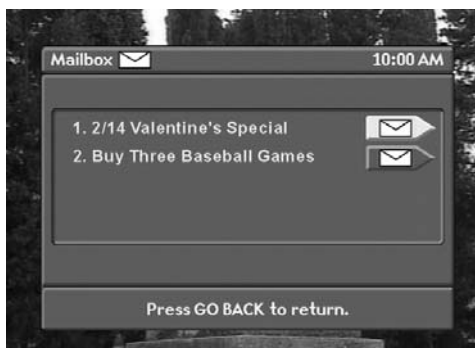

## Mailbox Message Screen

The Message screen contains the complete message. Once you read the message and wish to erase it, press either the ENTER key or the GO BACK key. An Erase Message prompt screen will appear. Some messages will be automatically erased after you read them. Such messages will have the following statement in the instructions at the bottom of the screen: "This message will erase after being read."



## Erase or Keep Message Screen

When the Erase Message prompt screen appears within the Mailbox menu, it allows you to select from two options.

- Select Erase Message to erase the message and return to the Message List menu.
- Select Keep Message to save the message and return to the Message List menu.

## Setting a Future Day and Time for the Guide

If you want to immediately look at program offerings in the IPG for another day or a specific time:

- Display the Options menu (press the OPTIONS key on the remote control).
- Select option 2 (Guide & Favorites). The Guide & Favorites menu appears.
- Select option 1 (Set a Future Day & Time for the Guide). A Choose Day menu appears.
- Select which day of the Guide you would like to display. A Choose Time menu will appear.
- Select the time of day for the Guide programming you would like to view.

Refer to the section entitled "Guide (IPG)" for more information.

## Setting Favorite Channels

With this option, you can create a list of favorite channels using the Favorite Channels menu. Once you create this list you will be able to focus your channel surfing and find programs more quickly.

### How to Display the Favorite Channels Menu

- Display the Options menu.
- Select Option 2 (Set Guide & Favorites). The Guide and Favorites menu appears.
- Select Option 2 (Set Favorite Channels). The Favorite Channels menu appears.



### Favorite Channels Menu

The Favorite Channels menu allows you to assign channels to each of four lists (refer to the section entitled, "Viewing Interests and Favorites"). The Favorite Channels menu displays options to set Favorite Channels A, B, C, or D. Press the **◆** keys and press ENTER or use the number keys to select which Favorite Channels list you would like

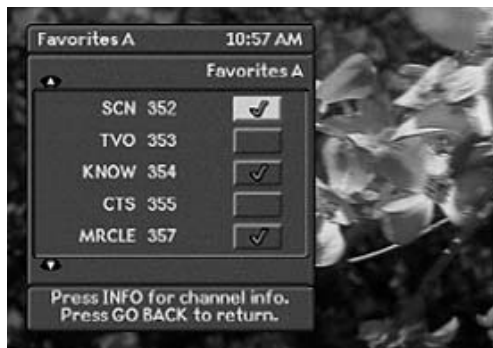

to modify. When you select one of these options the corresponding Favorites screen will appear, i.e. Favorites A. Each of the Favorites menus displays a list showing the name of the channel and the channel number with corresponding buttons running down the right side of the screen.

### To assign a channel to the Favorites A, B, C or D list:

- Press the **◀ ▶** keys to scroll through the list of channels.
- Press the **◀ ▶** keys to highlight the box to which you will assign the channel.
- Press the ENTER key. A check mark will appear in the box you select. Press the ENTER key again if you wish to remove the check mark.
- Press GO BACK to return to the Favorite Channels menu.
- Repeat this process to create each Favorites list.
- Press EXIT to view programming.

## Setting Parental Controls & Passwords

The Parental Control menu enables you to set passwords, lock out certain channels, and lock out certain programs based on their rating or specific content. This applies to programs which have a U.S. content rating.



### How to Display the Parental Control Menu

- Display the Options menu.
- Select Option 3 (Set Parental Control). If a password has already been programmed, you will be asked to enter your password before you can have access to the Parental Control menu.

### Parental Control Menu Options

**1. Set Password.** The Set Password option allows you to set a parental control password that prevents others from viewing certain channels and programs.

- From the Parental Control menu, select option 1 (Set Password). The New Password screen appears.
- Use the number keys to enter a password of up to 8 numbers. An asterisk (\*) will appear each time you add a number. Press the **◀** key to move to the left and change a number. When you are finished, press the ENTER key. The Confirm Password screen appears.
- Re-enter your password numbers and press the ENTER key. The Password

Changed screen appears, letting you know that your password is now effective. Press the GO BACK key to return to the Parental Control menu.

**To Set a New Password.** If you wish to change your password in the future, you must first enter your current password to gain access to the Parental Control menu. From the Parental Control menu, select option 1 (Set Password). The New Password screen appears. Key in a new password, and press the ENTER key. When the Confirm Password screen appears, re-enter the new password. A Password Changed screen will confirm that your password has been changed.



**To Clear Your Password.** If you wish to clear your password so that no passwords are required to purchase Pay Per View programs or view locked-out channels or programs, you must first enter your current password to gain access to the Parental Control menu. From the Parental Control menu, select option 1 (Set Password). The New Password screen appears. Press the ENTER key without keying in any numbers. When the Confirm Password screen appears, press the ENTER key again without keying in any numbers. A Password Changed screen will confirm that your password has been cleared.

**2. Set Channel Locks.** The Set Channel Locks option allows you to lock out specific channels from viewing. Once a channel is locked out, you must use the parental control password to view programs on the locked out channel.

- Select option 2 (Set Channel Locks). The Channel Locks menu appears. The Channel Locks menu displays a list of channel names, numbers, and buttons. Press the  $\blacklozenge$  keys to scroll up and down the list of names. Select a highlighted channel (press the ENTER key) to lock it out. A lock appears on the button. To remove a lock, select a channel that is already locked (press the ENTER key when it is highlighted).
- Press the GO BACK key to exit this menu. Changes are saved automatically



each time you set a lock.

- When you are channel surfing, the receiver will skip locked out channels. If you try to directly enter the channel number of the locked-out channel while channel surfing, the following message will appear: "This channel has been locked".

**3. Set General Rating Locks.** The Set General Rating Locks option allows you to lock out programs based on their general rating —PG, R, NC-17, X, etc. Once you set a general rating limit, you must use the parental control password to view programs with that rating or a higher rating.

- Select option 3 (Set General Rating Locks). The General Rating Locks menu appears.
- If you highlight one of the rating boxes on the left side of the menu, a description of that rating will appear.
- Select a rating to lock out programs matching that rating. All higher ratings will also be automatically locked out. A closed lock symbol will appear. If you select a locked rating, it will be unlocked.
- You may also select No Locks to permit access.

**4. Set Content Rating Locks.** The Set Content Rating Locks option allows you to lock out digital programs based on their specific content—violence, sexual material, or offensive language—regardless of their general rating. Once you set a content rating lock, you must use the parental control password to view programs that possess the locked-out content. This applies to programs which have a content rating.

- Select option 4 (Set Content Rating Locks). The Content Rating Locks menu appears.
- Listed under each category (Violence, Sexual Material, or Language) are four boxes. For example, under the Violence category are: No Locks, GV (graphic violence), V (violence), and (MV) mild violence. If you highlight one of the boxes, a full description of the category will appear.
- Select a rating to lock out programs with that rating. All higher ratings will be automatically locked out, and a closed lock icon will appear. If you select a locked rating, it will be unlocked.
- You may also select No Locks for each category.

**5. Locks.** The Locks option allows you to turn off all of the channel and program locks so that you can view all of the locked out channels and programs. If you set any new locks after Locks is set to Off, the Locks option automatically re-sets itself to On. Each time you press the POWER key to turn on the receiver, the Locks Option resets itself to On.

**6. Lock Channel on "No Info" in Guide.** This option will allow you to lock any programming that is listed as "No Info" in the Guide.

## Setting Timers

With timers, you can schedule your viewing up to one year in advance—whether you want to schedule one-time-only events or daily programs. Once you have set the timer, the receiver will automatically tune to the channel when the program begins. You can change, erase, and review the timers whenever you wish. Make sure to set your VCR if you wish to make a tape since the receiver will not automatically program your VCR to tape an event.

**Sleep Timer.** Sometimes when you are watching a program in SAT mode, you will want to automatically turn off the picture and sound because you plan to fall asleep after a certain amount of time.

To set the sleep timer:

- Display the Options menu (press the OPTIONS key on the remote control).
- Select option 6 (Change System Settings), and the System Settings menu appears.
- Select option 5 (Sleep Timer) to highlight it.
- Press the ◀ ▶ keys to set the amount of time you wish to watch and hear a program until the sleep timer shuts off the picture and sound (shown in hours and minutes). The maximum time limit is 3 hours.

NOTE: Any time that a sleep timer is set, the LOCKS option re-sets itself to On. See "Setting Parental Controls & Passwords."



### How to Display the Timers Menu

- Display the Options menu.
- Select Option 4 (Set Timers). the Timers menu appears.



## How to Use the Timers Menu

The Timers menu has up to 25 timer listings. Each listing that has already been set includes the program name, the day and time it begins, and icons for parental controls and IPPV programs.

- Press the  $\blacktriangle$  keys to scroll up and down the listings.
- If you select a Not Used listing, a Set Timer menu will appear.
- If you select a listing that has already been set, the Change Timer/Erase Timers prompt screen will appear.

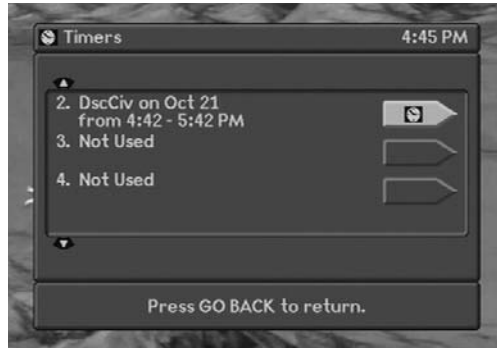

## Change Timer/Erase Timer Prompt Screen

The Change Timer/Erase Timer prompt screen has two options:

- If you select the Change Timer option, the Set timer menu will appear so that you can change the timer settings.
- If you select Erase Timer, The Timers menu will reappear, and the listing will be changed to Not Used.

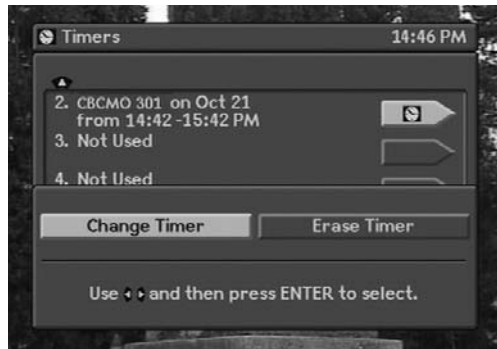

A clock icon appears on the right side of the arrow-shaped box if the timer is set but the program has not yet begun.

## Maximum Number of Timers

The maximum number of timers is twenty-five (25). If all of the timers have been used you will have to erase an existing timer before a new timer can be set.

## Before a Timer Executes

Two minutes before a timer executes, the front panel Timer light will blink, and a countdown screen will appear. You may either: (1) press the GO BACK key to remove the countdown screen, (2) press the ENTER key to return to the Timers menu so that you can erase the timer, or (3) wait until the timer executes.

## How to Use the Set Timer Menu

If you selected a Not Used listing in the Timers menu, the Set Timer menu appears. The Set Timer menu allows you to select the frequency for the timer, the date, the beginning and ending times for the program, and the channel.

Press the ◀ ⬆ ▶ keys to highlight the various options.

To set each option, press either the ◀ ▶ keys or the number keys as indicated.

When you are finished setting all of the timer options, select the Confirm Timer arrow to display the Confirm Timer menu.

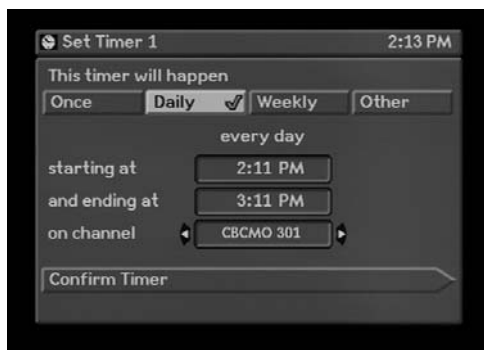

## How to Set Each Timer Option

- Press the ◀ ⬆ ▶ keys and ENTER to display the day of the the program's frequency (for example, a weekly or daily program).
- If Daily, Weekly or Other is selected, different screens will appear.
- Press the ◀ ▶ keys to display the date.
- Press the number keys to set the time. A timer must be at least 5 minutes long to activate.
- Press the ◀ ▶ keys, or the number keys to indicate the channel number.

## Setting a Timer for Next Year

If you set the timer for a month and day that have already passed in the current year, the receiver will consider the setting to be for the next year on that date. For example, if it is December and you set a timer for February, your timer will execute in February of the coming new year.

## If You Press the GO BACK Key

If you press the Go BACK key from the Set Timer menu, a message screen will appear. It will instruct you to do either one of the following:

- Cancel your changes by pressing the ENTER key.
- Press the GO BACK key again to return to the Set Timer menu.

## How to Use the Confirm Timer Menu

The top portion of the Confirm Timer menu displays timer information followed by up to four options (the IPPV option does not appear if the program is not a subscription program). Some programs may be scheduled too far in advance to immediately determine this information.

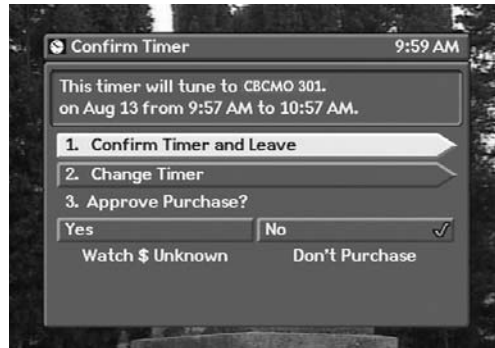

1. Select option 1 (Confirm Timer and Leave) to complete your settings from the Set Timer menu and to return to the Timers menu to complete additional settings. Select this option only after you make sure the other options on this screen are correct.
2. Select option 2 (Change Timer) to return to the Set Timer menu and change the Timer option settings.
3. Option 3 (Approve Purchase) allows you to pre-purchase a program before viewing time. This option only appears if your receiver is IPPV enabled. The program's price is not always displayed.
  - Select the Yes option to pre-purchase the program.
  - If you select the No option, the program will not be pre-purchased. The timer will be set for the program, but you will have to purchase the program at viewing time.
  - If the program cannot be taped, a no tape icon will appear.

*If you have purchased a program or have used parental control features to lock out channels, satellites, or program content, a Password screen will appear. You will have to enter your password to finish setting the timer. Refer to the section entitled "Setting Parental Controls and Passwords".*

## Setting a Timer Using the Guide

To set a timer while you are using the Guide:

- Highlight a future program.
- Press the INFO key or the ENTER key.
- The Confirm Timer menu will appear (follow the instructions for the Confirm Timer menu).

## How to Cancel a Timer

To cancel a timer while it is executing:

- Press the POWER key.  
For repeating timers (such as those used for daily or weekly programs), pressing the POWER key only cancels the currently executing event. The timer for the next repeating event (the timer for the next day or week) will be re-enabled at the start of the next day.
- Erase the timer on the Timers menu. This will cancel single-event and repeating event timers. Refer to the section entitled "Change Timer/Erase Timer Menu".

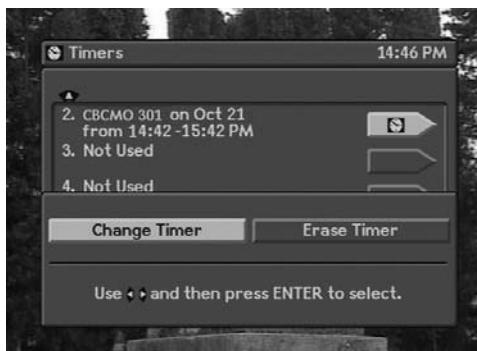

## If New Settings Conflict with Previous Settings

If your new timer settings conflict with a previously set timer (for example, if both are set for the same time), a message screen will appear. It will describe the conflict and ask you to do either one of the following:

- Press ENTER to replace the conflicting (previously set) timer with the new one.
- Press GO BACK so that you can retain the previously set timer and change the settings of the current timer so that they no longer are in conflict.

## List Purchases

This is a view only screen that allows you to review a list of previously purchased IPPV programs and to verify your account status. Refer to the section entitled "Pay-Per-View Events" for more information regarding this option.

## Change System Settings

The System Settings menu provides access to menus that allow you to adjust the operation of your system.

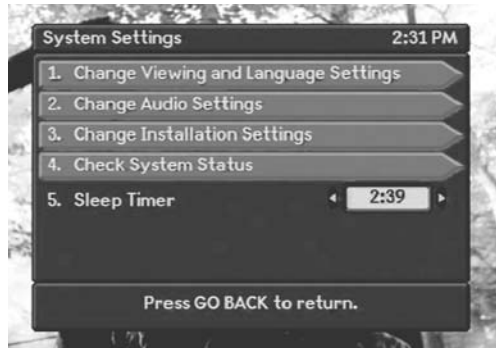

### Viewing and Language Settings

The Change Viewing and Language Settings option allows you to turn off the headers and banners, choose the language for subtitles and audio, and choose the size of the viewing area. Typically, these settings are selected at the time of initial installation by your installer.

- Press the **OPTIONS** key on the remote. The Options menu appears.
- Select option 6 (Change System Settings), and the System Settings menu appears.
- Select Option 1 (Change Viewing and Language Settings). The Viewing and Language Settings menu will be displayed.



**Channel Information.** The Channel Information option allows you to turn the header (top of screen) and banner (bottom of screen) on or off. Select the option of your choice, On or Off. The default setting is On.

**Subtitles.** The Subtitles option allows you to select the language for subtitles (if available for the particular program) or keep them turned off. Select the option of your choice—None, English, Spanish, or French. The default setting is None.

**Language.** the Language option allows you to select the language of the audio for your programs. Select the option of your choice—English, Spanish, or French. The default setting is English.

**TV Viewing.** The TV Viewing option allows you to select the size of the viewing area. Select the Normal option if your TV screen is typical screen with 4:3 ratio of width to height. Select Wide if your TV screen is a wide screen with a 16:9 ratio. The default setting is Normal.

## Audio Settings

To adjust the audio settings so that they are correct for the type of equipment connected to your receiver, you will be using the onscreen menus. Typically, these settings are selected at the time of initial installation by your installer.

- Press the OPTIONS key on the remote. The Options menu appears.
- From the Options menu, select option 6 (Change Systems Settings), and the System Settings menu appears.
- From the System Settings menu, select option 2 (Change Audio Settings), and an Audio Settings menu will appear.



**Audio Settings Menu for Satellite Broadcasts.** On the Audio Settings menu two options appear:

- Select option 1 (Audio Connections), and you will be able to select either TV or Hi Fi (the default is TV), Select TV if the receiver's AUDIO OUT port is connected to your TV. Select Hi Fi if it is connected to your stereo system.
- Select option 2 and then select Mono, Stereo, or Surround.

## Installation Settings

### Tune in Satellite Signal.

This option allows you to see the strength of the signal your antenna is receiving.

### Set Remote Control

**Address.** This option allows you to control up to four receivers in a centralized area with one or more remote controls. Each receiver requires a separate address. The default address is 0000.



On the front panel of your receiver press the Menu button to bring up the Menu screen.

- Choose Options.
- Choose option 6 (Change System Settings).
- Choose option 3 (Installation Settings).
- On the Installation Settings menu, choose option 2 (Set Remote Control Address). Now follow the instructions on the Remote Control Address screen.
- If you have four receivers, you will have to change the addresses on three of them: they will have address of 0000, 0001, 0002, and 0003.

*To program your remote control for each receiver, hold down the SAT key on the remote control until the light flashes. Once the light begins to flash enter the desired address (0000, 0001, 0002, or 0003).*

## System Status

This is a view-only screen that displays information about the status of the receiver.

**Trip Counter.** Trip Counter displays the number of message updates from your service provider.

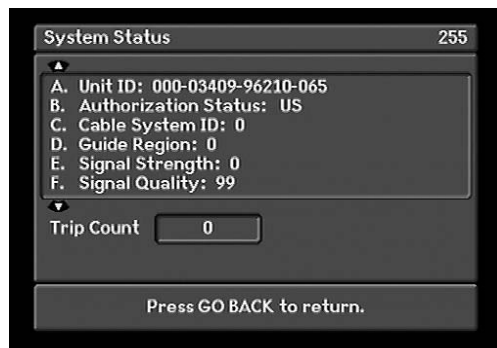







# Specifications

## Input

### L-Band Input

Input frequency	950 to 1550 MHz or 950 to 2150 MHz
Input impedance	75 ohm
Input level	-65 dBm to -25 dBm
Return loss	8 dB minimum
Demodulator	QPSK demodulator

### Antenna Input

Connector	"F" type, receptacle
Input Impedance	75 ohm

## Video

### Composite Video

Output level	1.0 Vp-p $\pm$ 10% into 75 ohm
Connector	Yellow phono, marked Video out
De-emphasis	525 line CCIR Rec. 405-1

### DigiCipher II (Digital) System

Frequency response	$\pm$ 1.0 dB, 1kHz to 4.2 MHz
Differential gain	5.0% p-p maximum
Differential phase	5.0 deg. p-p maximum
S/N	57 dB minimum (unified weighting 100 kHz HPF, 5MHz LPF)

## Remodulator Output

Connector	"F" type receptacle, "Out to TV" NTSC & IEC
Impedance	75 ohm
Channel	Ch. 3 or 4 (NTSC, North America)
Audio	Mono

## Audio

Modes	Digital stereo Fixed volume output, volume control is from TV only
-------	---

## DigiCipher II (Digital) System

Frequency response	$\pm 1.0$ dB, maximum 20 Hz to 20 kHz
--------------------	--

## Remote Control

Transmitter	Infrared (IR)
Batteries	2 x AA type
Range	Up to a maximum of 35 ft. (IR)
Angle	$\pm 22$ deg. (IR)

## Physical/Environmental

Temperature	0 deg. to 40 deg. C ambient
Humidity	95% relative
Dimensions	6.9" W x 2.25" H x 8" D
Weight	1.3 lbs
Power input	12V DC; 15W maximum
UL	Listed
CSA	Certified



## Warranty & Service

### RECEIVER WARRANTY COVERAGE

**Within 1-365 days from date of purchase.**

- Call the Star Choice Customer Care Centre (1 888 554-STAR) to see if we can help you troubleshoot the problem on the spot.
- If it can't be fixed over the phone, you'll be given a **Return Tracking Code # (RTC)** needed to return the receiver for warranty coverage.
- We'll have a replacement delivered to you.
- Your new receiver package will include a prepaid mailing label and instructions for returning the defective receiver. When doing so, you must **enclose a proof of purchase** (i.e. sales receipt) and your **RTC #**.
- We must get your defective receiver within 30 days of you getting the replacement. Otherwise, a charge for the receiver will be applied to your account.

**366 days or more – not covered under warranty. Contact Star Choice for details.**

### REMOTE CONTROL WARRANTY COVERAGE

**Within 1-365 Days from the date of purchase.**

- Call the Star Choice Customer Care Centre (1 888 554-STAR) to see if we can help you troubleshoot the problem on the spot.
- If it can't be fixed over the phone, you'll be given a **Return Tracking Code # (RTC)** needed to return the remote for warranty coverage.
- We'll have a replacement delivered to you.

**366 days or more – not covered under warranty. Contact Star Choice for details.**

## **RECEIVER/REMOTE CONTROL WARRANTY ENTITLEMENT WILL NOT APPLY IN THE FOLLOWING CASES**

**Improper Handling** – if the unit appears to have been dropped or otherwise damaged as a result of accident or neglect

**Opened Case** – if the receiver cover has been opened, tampered with or altered in any way

**Liquid Spills** – includes any foreign matter found in receiver (e.g., soft drinks, coffee, animal hair, etc.)

**Lightning/Power Surge** – if equipment is separately connected to a proper surge protector, refer to the warranty detail provided by the manufacturer of the surge protector. Star Choice is not responsible for covering 3<sup>rd</sup> party extended warranties.

**Unit Resold** – if a unit has been resold from its original owner to another consumer