

MVME187
RISC Single Board Computer
Installation Guide

MVME187IG/D4

Notice

While reasonable efforts have been made to assure the accuracy of this document, Motorola, Inc. assumes no liability resulting from any omissions in this document, or from the use of the information obtained therein. Motorola reserves the right to revise this document and to make changes from time to time in the content hereof without obligation of Motorola to notify any person of such revision or changes.

No part of this material may be reproduced or copied in any tangible medium, or stored in a retrieval system, or transmitted in any form, or by any means, radio, electronic, mechanical, photocopying, recording or facsimile, or otherwise, without the prior written permission of Motorola, Inc.

It is possible that this publication may contain reference to, or information about Motorola products (machines and programs), programming, or services that are not announced in your country. Such references or information must not be construed to mean that Motorola intends to announce such Motorola products, programming, or services in your country.

Restricted Rights Legend

If the documentation contained herein is supplied, directly or indirectly, to the U.S. Government, the following notice shall apply unless otherwise agreed to in writing by Motorola, Inc.

Use, duplication, or disclosure by the Government is subject to restrictions as set forth in subparagraph (c)(1)(ii) of the Rights in Technical Data and Computer Software clause at DFARS 252.227-7013.

Motorola, Inc.
Computer Group
2900 South Diablo Way
Tempe, Arizona 85282-9602

Preface

This manual provides a general board level hardware description, hardware preparation and installation instructions, debugger general information, and information about using the debugger.

This manual applies to the following MVME187 RISC Single Board Computers:

Assembly Item	Board Description
MVME187-001B	25MHZ, 4MB Parity
MVME187-002B	25MHZ, 8MB Parity
MVME187-003B	25MHZ, 16MB Parity
MVME187-004B	25MHZ, 32MB Parity
MVME187-023B	33MHZ, 16MB ECC, 128
MVME187-024B	33MHZ, 32MB ECC, 128C
MVME187-031B	33MHZ, 4MB ECC
MVME187-032B	33MHZ, 8MB ECC
MVME187-033B	33MHZ, 16MB ECC
MVME187-034B	33MHZ, 32MB ECC
MVME187-035B	33MHZ, 64MB ECC
MVME187-036B	33MHZ, 128MB ECC

This manual is intended for anyone who wants to provide OEM systems, supply additional capability to an existing compatible system, or work in a lab environment for experimental purposes.

Anyone using this manual should have a basic knowledge of computers and digital logic.

Safety Summary

Safety Depends On You

The following general safety precautions must be observed during all phases of operation, service, and repair of this equipment. Failure to comply with these precautions or with specific warnings elsewhere in this manual violates safety standards of design, manufacture, and intended use of the equipment. Motorola, Inc. assumes no liability for the customer's failure to comply with these requirements.

The safety precautions listed below represent warnings of certain dangers of which Motorola is aware. You, as the user of the product, should follow these warnings and all other safety precautions necessary for the safe operation of the equipment in your operating environment.

Ground the Instrument.

To minimize shock hazard, the equipment chassis and enclosure must be connected to an electrical ground. The equipment is supplied with a three-conductor ac power cable. The power cable must be plugged into an approved three-contact electrical outlet. The power jack and mating plug of the power cable meet International Electrotechnical Commission (IEC) safety standards.

Do Not Operate in an Explosive Atmosphere.

Do not operate the equipment in the presence of flammable gases or fumes. Operation of any electrical equipment in such an environment constitutes a definite safety hazard.

Keep Away From Live Circuits.

Operating personnel must not remove equipment covers. Only Factory Authorized Service Personnel or other qualified maintenance personnel may remove equipment covers for internal subassembly or component replacement or any internal adjustment. Do not replace components with power cable connected. Under certain conditions, dangerous voltages may exist even with the power cable removed. To avoid injuries, always disconnect power and discharge circuits before touching them.

Do Not Service or Adjust Alone.

Do not attempt internal service or adjustment unless another person capable of rendering first aid and resuscitation is present.

Use Caution When Exposing or Handling the CRT.

Breakage of the Cathode-Ray Tube (CRT) causes a high-velocity scattering of glass fragments (implosion). To prevent CRT implosion, avoid rough handling or jarring of the equipment. Handling of the CRT should be done only by qualified maintenance personnel using approved safety mask and gloves.

Do Not Substitute Parts or Modify Equipment.

Because of the danger of introducing additional hazards, do not install substitute parts or perform any unauthorized modification of the equipment. Contact your local Motorola representative for service and repair to ensure that safety features are maintained.

Dangerous Procedure Warnings.

Warnings, such as the example below, precede potentially dangerous procedures throughout this manual. Instructions contained in the warnings must be followed. You should also employ all other safety precautions which you deem necessary for the operation of the equipment in your operating environment.



Dangerous voltages, capable of causing death, are present in this equipment. Use extreme caution when handling, testing, and adjusting.

All Motorola PWBs (printed wiring boards) are manufactured by UL-recognized manufacturers, with a flammability rating of 94V-0.



This equipment generates, uses, and can radiate electro-magnetic energy. It may cause or be susceptible to electro-magnetic interference (EMI) if not installed and used in a cabinet with adequate EMI protection.



European Notice: Board products with the CE marking comply with the EMC Directive (89/336/EEC). Compliance with this directive implies conformity to the following European Norms:

EN55022 (CISPR 22) Radio Frequency Interference

EN50082-1 (IEC801-2, IEC801-3, IEEC801-4) Electromagnetic Immunity

The product also fulfills EN60950 (product safety) which is essentially the requirement for the Low Voltage Directive (73/23/EEC).

This board product was tested in a representative system to show compliance with the above mentioned requirements. A proper installation in a CE-marked system will maintain the required EMC/safety performance.

The computer programs stored in the Read Only Memory of this device contain material copyrighted by Motorola Inc., 1995, and may be used only under a license such as those contained in Motorola's software licenses.

Motorola® and the Motorola symbol are registered trademarks of Motorola, Inc.

All other products mentioned in this document are trademarks or registered trademarks of their respective holders.

©Copyright Motorola 1997
All Rights Reserved

Printed in the United States of America
March 1997

Contents

This Chapter Covers	1-1
About this Manual	1-1
Terminology, Conventions, and Definitions Used in this Manual	1-2
Data and Address Parameter Numeric Formats	1-2
Signal Name Conventions	1-2
Assertion and Negation Conventions	1-3
Data and Address Size Definitions	1-3
Big-Endian Byte Ordering	1-3
Control and Status Bit Definitions	1-4
True/False Bit State Definitions	1-4
Bit Value Descriptions	1-4
Related Documentation	1-5
Document Set for MVME187-0xx Board	1-5
Additional Manuals for this Board	1-6
Other Applicable Motorola Publications	1-6
Non-Motorola Peripheral Controllers Publications Bundle	1-7
Applicable Non-Motorola Publications	1-9
This Chapter Covers	2-1
General Description	2-1
Onboard Memory Mezzanine Module	2-2
SCSI Mass Storage Interface	2-2
Serial Ports	2-3
Parallel (Printer) Port	2-3
Ethernet Transceiver Interface	2-3
187Bug Firmware	2-4
Features	2-4
Specifications	2-6
Conformance to Requirements	2-6
Board Level Overview	2-7
Connectors	2-7
Adapters	2-7
Transition Modules	2-8
ASICs	2-8
VMEchip2 ASIC	2-9
PCCchip2 ASIC	2-9
MEMC040 Memory Controller ASIC	2-10

MCECC Memory Controller ASIC	2-10
Functional Description	2-10
Front Panel Switches and LEDs	2-11
Data Bus Structure	2-12
Local Bus Arbitration	2-12
M88000 MPU	2-12
EPROM	2-13
Programmable EPROM Features	2-13
Static RAM	2-13
Optional SRAM Battery Backup	2-14
Onboard DRAM	2-15
Stacking Mezzanines	2-16
DRAM Programming Considerations	2-16
Battery Backed Up RAM and Clock	2-17
VMEbus Interface	2-18
I/O Interfaces	2-18
Serial Port Interface	2-18
Parallel Port Interface	2-20
Ethernet Interface	2-21
SCSI Interface	2-22
Local Resources	2-23
Programmable Tick Timers	2-23
Watchdog Timer	2-23
Software-Programmable Hardware Interrupts	2-23
Local Bus Timeout	2-23
Memory Maps	2-24
Local Bus Memory Map	2-24
Normal Address Range Devices	2-24
VMEbus Memory Map	2-28
VMEbus Accesses to the Local Bus	2-28
VMEbus Short I/O Memory Map	2-28
This Chapter Covers	3-1
Unpacking the Equipment	3-1
Overview of Startup Procedure	3-2
Preparing the Hardware	3-5
Modifying Configuration before Installation	3-5
Option Modification	3-5
Checking the 187Bug EPROMs	3-7
EPROM Location	3-7
EPROM Orientation	3-7
User-programmed EPROMs	3-7

Jumper Settings	3-7
Optional Jumper Settings	3-8
General Purpose Software Readable Header J1	3-8
System Controller Header J2	3-10
Optional SRAM Backup Power Source Select Header J6	3-11
Serial Port 4 Clock Configuration Select Headers J7 and J8	3-11
Preparing the MVME187 for Installation	3-14
Preparing the System Chassis	3-15
Installing the Hardware	3-16
Installing the MVME187 in the Chassis	3-16
Transition Modules and Adapter Boards Overview	3-17
Equipment Connections	3-19
Installing Transition Modules and Adapter Boards	3-20
Connecting Peripherals	3-20
Completing the Installation	3-24
Starting the System	3-24
Powering Up the System	3-25
Initializing the Real-Time Clock	3-25
Examining and/or Changing Environmental Parameters	3-25
Programming the PCCchip2 and VMEchip2	3-26
System Considerations	3-27
Backplane Power Connections	3-27
Memory Address Ranges	3-27
DRAM Addressing	3-27
Global Bus Timeout	3-27
Multiple Module Cage Configuration	3-28
GCSR Location Monitor Register	3-28
Ethernet LAN (+12 Vdc) Fuse	3-28
SCSI Bus Termination	3-29
Storage and the Real-Time Clock	3-29
This Chapter Covers	4-1
Introduction to MVME187Bug	4-1
Overview of M88000 Firmware	4-1
Description of 187Bug	4-2
Command Facilities	4-2
Trap #496 Routines	4-2
Debugger or Diagnostic Directories	4-3
Keyboard Control	4-3
Comparison with M68000-Based Firmware	4-4
187Bug Implementation	4-4
Memory Requirements	4-5

- Booting and Restarting 187Bug 4-5
 - Starting Up 187Bug 4-6
 - Autoboot 4-6
 - Autoboot Sequence 4-6
 - ROMboot 4-7
 - ROMboot Sequence 4-7
 - Network Boot 4-8
 - Network Boot Sequence 4-8
 - Restarting the System 4-9
 - Reset 4-10
 - Abort 4-10
 - Break 4-11
 - SYSFAIL* Assertion/Negation 4-12
 - MPU Clock Speed Calculation 4-12
- Disk I/O Support 4-13
 - Disk Support Facilities 4-13
 - Parameter Tables 4-13
 - Supported Controllers 4-13
 - Blocks Versus Sectors 4-14
 - Device Probe Function 4-14
 - Disk I/O via 187Bug Commands 4-15
 - IOI (Input/Output Inquiry) 4-15
 - IOP (Physical I/O to Disk) 4-15
 - IOT (I/O Teach) 4-15
 - IOC (I/O Control) 4-15
 - BO (Bootstrap Operating System) 4-15
 - BH (Bootstrap and Halt) 4-16
 - Disk I/O via 187Bug System Calls 4-16
 - Controller Command Packets 4-16
 - Default 187Bug Controller and Device Parameters 4-17
 - Disk I/O Error Codes 4-18
- Network I/O Support 4-19
 - Intel 82596 LAN Coprocessor Ethernet Driver 4-19
 - UDP/IP Protocol Modules 4-19
 - RARP/ARP Protocol Modules 4-20
 - BOOTP Protocol Module 4-20
 - TFTP Protocol Module 4-20
 - Network Boot Control Module 4-20
 - Network I/O Error Codes 4-21
- Multiprocessor Support 4-21
 - Multiprocessor Control Register (MPCR) Method 4-21

- MPCR Status Codes 4-22
- Multiprocessor Address Register (MPAR) 4-22
- MPCR Powerup Sequence 4-22
- Global Control and Status Register (GCSR) Method 4-24
- Diagnostic Facilities 4-25
 - 187Bug Diagnostic Test Groups 4-27
- This Chapter Covers 5-1
- Entering Debugger Command Lines 5-1
 - Terminal Input/Output Control 5-1
 - Debugger Command Syntax 5-3
 - Syntactic Variables 5-4
 - Expression as a Parameter 5-4
 - Address as a Parameter 5-5
 - Address Formats 5-6
 - Offset Registers 5-7
 - Port Numbers 5-7
- Entering and Debugging Programs 5-8
 - Creating a Program with the Assembler/Disassembler 5-8
 - Downloading an S-Record Object File 5-8
 - Read the Program from Disk 5-9
- Calling System Utilities from User Programs 5-9
- Preserving the Debugger Operating Environment 5-10
 - 187Bug Vector Table and Workspace 5-10
 - Hardware Functions 5-11
 - Exception Vectors Used by 187Bug 5-11
 - CPU/MPU Registers 5-11
- Floating Point Support 5-11
 - Single Precision Real 5-13
 - Double Precision Real 5-13
 - Scientific Notation 5-14
- The 187Bug Debugger Command Set 5-15
- This Appendix Covers A-1
- Configuring the Board Information Block A-1
- Setting Environment to Bug/Operating System A-3
- Disk/Tape Controller Modules Supported B-1
- Disk/Tape Controller Default Configurations B-2
- IOT Command Parameters for Supported Floppy Types B-4
- Network Controller Modules Supported C-1
- Introduction E-1
- Levels of Implementation E-3

Signal Adaptations E-4
Sample Configurations E-4
Proper Grounding E-7

List of Figures

- MVME187 General Block Diagram 2-7
 - MVME187 Switches, Headers, Connectors, Fuses, and LEDs 3-6
 - Typical Internal SCSI and Serial Port Connections 3-18
 - Using MVME712A / AM and MVME712B 3-22
 - Typical Transition Module Peripheral Port Connectors 3-23
-

List of Tables

MVME187 General Specifications	2-6
Bus Transfers	2-9
Front Panel Switches	2-11
Front Panel LEDs	2-11
Local Bus Memory Map	2-25
Local I/O Devices Memory Map	2-26
Startup Overview	3-2
J1 Bit Descriptions	3-9
Factory Settings for J1 General Purpose Readable Jumpers	3-9
Settings for J2 System Controller Header	3-10
Settings for Optional J6 SRAM Backup Power Source Select Header	3-12
Settings for J7 and J8 Serial Port 4 Clock Configuration Select Headers	3-13
MVME187 Preparation Procedure	3-14
Chassis Preparation/Slot Selection Procedure	3-15
MVME187 Installation Procedure	3-16
Peripheral Connections	3-19
Transition Module and Adapter Board Installation Overview	3-20
Peripheral Connection Procedures	3-21
Installation Completion Procedure	3-24
System Startup Overview	3-24
RTC Initialization Procedure	3-26
Diagnostic Monitor Commands/Prefixes	4-25
Diagnostic Utilities	4-26
Diagnostic Test Groups	4-27
Debugger Commands	5-15

Introduction to the MVME187 Installation Guide

1

This Chapter Covers

- ❑ Details about this manual
- ❑ Terminology, conventions, and definitions used
- ❑ Other publications relevant to the MVME187

About this Manual

This manual supports the setup, installation, and debugging of the RISC-based MVME187 Single Board Computer; a high-performance engine for VMEbus-based low- and mid-range OEM and integrated systems, embedded controllers, and other single-board computer applications.

This manual provides:

- ❑ A general *Board Level Hardware Description* in Chapter 2
- ❑ *Hardware Preparation and Installation* instructions in Chapter 3
- ❑ *Debugger General Information* in Chapter 4
- ❑ Debugger/monitor commands, and other information about *Using the 187Bug Debugger* in Chapter 5
- ❑ Other information needed for start-up and troubleshooting of the MVME187 RISC Single Board Computer, including
 - *Configure and Environment Commands* in Appendix A
 - *Disk/Tape Controller Data* in Appendix B for controller modules supported by 187Bug
 - *Network Controller Data* in Appendix C
 - *Procedures for Troubleshooting CPU Boards* in Appendix D
 - *EIA-232-D Interconnections* in Appendix E

Terminology, Conventions, and Definitions Used in this Manual

Data and Address Parameter Numeric Formats

Throughout this manual, a character identifying the numeric format precedes data and address parameters as follows:

\$	dollar	specifies a hexadecimal character
%	percent	specifies a binary number
&	ampersand	specifies a decimal number

For example, “12” is the decimal number twelve, and “\$12” is the decimal number eighteen.

Unless otherwise specified, all address references are in hexadecimal.

Signal Name Conventions

An asterisk (*) follows signal names for signals which are level or edge significant:

Term	* Indicates
level significant	The signal is true or valid when the signal is low.
edge significant	The actions initiated by that signal occur on high to low transition.

Assertion and Negation Conventions

Assertion and negation are used to specify forcing a signal to a particular state. These terms are used independently of the voltage level (high or low) that they represent.

Term	Indicates
Assertion and assert	The signal is active or true.
Negation and negate	The signal is inactive or false.

Data and Address Size Definitions

Data and address sizes are defined as follows:

Name	Size	Numbered	Significance	Called
Byte	8 bits	0 through 7	bit 0 is the least significant	
Two-byte	16 bits	0 through 15	bit 0 is the least significant	half-word
Four-byte	32 bits	0 through 31	bit 0 is the least significant	word

Big-Endian Byte Ordering

This manual assumes that the MPU on the MVME187 always programs the CMMUs with big-endian byte ordering, as shown below. Any attempt to use little-endian byte ordering will immediately render the MVME187Bug debugger unusable.

BIT							BIT
31	24	23	16	15	08	07	00
ADR0	ADR1		ADR2		ADR3		

Control and Status Bit Definitions

The terms control bit and status bit are used extensively in this document to describe certain bits in registers.

Term	Describes
Control bit	The bit can be set and cleared under software control.
Status bit	The bit reflects a specific condition.

- The status bit can be read by software to determine operational or exception conditions.

True/False Bit State Definitions

True and False indicate whether a bit enables or disables the function it controls:

Term	Indicates
True	Enables the function it controls.
False	Disables the function it controls.

Bit Value Descriptions

In all tables, the terms 0 and 1 are used to describe the actual value that should be written to the bit, or the value that it yields when read.

Related Documentation

The MVME187 ships with a start-up installation guide (MVME187IG/D, the document you are presently reading) which includes installation instructions, jumper configuration information, memory maps, debugger/monitor commands, and any other information needed for start-up of the board.

If you wish to develop your own applications or need more detailed information about your MVME187 Single Board Computer, you may purchase the additional documentation (listed on the following pages) through your local Motorola sales office.

If any supplements have been issued for a manual or guide, they will be furnished along with the particular document. Each Motorola Computer Group manual publication number is suffixed with characters which represent the revision level of the document, such as "/D2" (the second revision of a manual); a supplement bears the same number as a manual but has a suffix such as "/D2A1" (the first supplement to the second edition of the manual).

Document Set for MVME187-0xx Board

You may order the manuals in this list individually or as a set. The manual set *68-M187SET* includes:

Motorola Publication Number	Description
MVME187/D	MVME187 RISC Single Board Computer User's Manual
88KBUG1/D 88KBUG2/D	Debugging Package for Motorola 88K RISC CPUs User's Manual (Parts 1 and 2)
MVME187BUG	MVME187Bug Debugging Package User's Manual
VMESBCA1/PG VMESBCA2/PG	Single Board Computer Programmer's Reference Guide (Parts 1 and 2)

Motorola Publication Number	Description
SBCSCSI/D	Single Board Computers SCSI Software User's Manual

Additional Manuals for this Board

Also available but **not** included in the set:

Motorola Publication Number	Description
MVME187IG/D	MVME187 RISC Single Board Computer Installation Guide (this manual)
SIMVME187/D	MVME187 RISC Single Board Computer Support Information The SIMVME187 manual contains the connector interconnect signal information, parts lists, and the schematics for the MVME187.

Other Applicable Motorola Publications

The following publications are applicable to the MVME187 and may provide additional helpful information. They may be purchased through your local Motorola sales office.

Motorola Publication Number	Description
MVME712M	MVME712M Transition Module and P2 Adapter Board User's Manual
MVME712A	MVME712-12, MVME712-13, MVME712A, MVME712AM, and MVME712B Transition Modules and LCP2 Adapter Board User's Manual

Motorola Publication Number	Description
MC88100UM	MC88100 RISC Microprocessor User's Manual
MC88200UM	MC88200 Cache/Memory Management Unit (CMMU) User's Manual
MC88204	MC88204 64K-Byte Cache/Memory Management Unit (CMMU) data sheet A

Non-Motorola Peripheral Controllers Publications Bundle

For your convenience, we have collected user's manuals for each of the peripheral controllers used on the MVME187 from the suppliers. This bundle, which can be ordered as part number **68-1X7DS**, includes the following manuals:

Part Number	Description
NCR53C710DM	NCR 53C710 SCSI I/O Processor Data Manual
NCR53C710PG	NCR 53C710 SCSI I/O Processor Programmer's Guide
CL-CD2400/2401	Cirrus Logic CD2401 Serial Controller User's Manual
UM95SCC0100	Zilog Z85230 Serial Communications Controller User's Manual
290218	Intel Networking Components Data Manual
290435	Intel i28F008 Flash Memory Data Sheet
290245	Intel i28F020 Flash Memory Data Sheet
292095	Intel i28F008SA Software Drivers Application Note
292099	Intel i28F008SA Automation and Algorithms Application Note

Part Number	Description
MK48T08/18B	SGS-THOMSON MK48T08 Time Clock/NVRAM Data Sheet
MC68230/D	MC68230 Parallel Interface Timer (PI/T) Data Sheet
SBCCOMPS/L	Customer Letter for Component Alternatives

Applicable Non-Motorola Publications

The following non-Motorola publications are also available from the sources indicated.

Document Title	Source
Versatile Backplane Bus: VMEbus, ANSI/IEEE Std 1014-1987 (VMEbus Specification) (This is also <i>Microprocessor System Bus for 1 to 4 Byte Data</i> , IEC 821 BUS)	The Institute of Electrical and Electronics Engineers, Inc. 345 East 47th St. New York, NY 10017
	Bureau Central de la Commission Electrotechnique Internationale 3, rue de Varembe Geneva, Switzerland
ANSI Small Computer System Interface-2 (SCSI-2), Draft Document X3.131-198X, Revision 10c	Global Engineering Documents 15 Inverness Way East Englewood, CO 80112-5704
CL-CD2400/2401 Four-Channel Multi-Protocol Communications Controller Data Sheet, order number 542400-003	Cirrus Logic, Inc. 3100 West Warren Ave. Fremont, CA 94538
82596CA Local Area Network Coprocessor Data Sheet, order number 290218; and 82596 User's Manual, order number 296853	Intel Corporation, Literature Sales P.O. Box 58130 Santa Clara, CA 95052-8130
NCR 53C710 SCSI I/O Processor Data Manual, order number NCR53C710DM	NCR Corporation Microelectronics Products Division 1635 Aeroplaza Dr. Colorado Springs, CO 80916
NCR 53C710 SCSI I/O Processor Programmer's Guide, order number NCR53C710PG	
MK48T08(B) Timekeeper™ and 8Kx8 Zeropower™ RAM data sheet in Static RAMs Databook, order number DBSRAM71	SGS-THOMSON Microelectronics Group Marketing Headquarters 1000 East Bell Rd. Phoenix, AZ 85022-2699

This Chapter Covers

- ❑ A general description of the MVME187 RISC Single Board Computer
- ❑ Features and specifications
- ❑ A board-level hardware overview
- ❑ A detailed hardware functional description, including front panel switches and indicators
- ❑ Memory maps

General Description

The MVME187 is a high functionality VMEbus RISC single board computer designed around the M88000 chip set. It features:

- ❑ Onboard memory expansion mezzanine module with 4, 8, 16, 32, 64 or 128MB of onboard DRAM
- ❑ SCSI bus interface with DMA
- ❑ Four serial ports with EIA-232-D interface
- ❑ Centronics (parallel) printer port
- ❑ Ethernet transceiver interface with DMA
- ❑ 187Bug debug monitor firmware

Onboard Memory Mezzanine Module

The MVME187 onboard DRAM mezzanine boards are available in different sizes and with programmable parity protection or Error Checking and Correction (ECC) protection.

- ❑ The main board and a single mezzanine board together take one slot.
- ❑ Motorola software supports mixed parity and ECC memory boards on the same main board.
- ❑ Mezzanine board sizes are 4, 8, 16, or 32 MB (parity), or 4, 8, 16, 32, 64, or 128 MB (ECC);
 - Two mezzanine boards may be stacked to provide 256MB of onboard RAM (ECC) or 64 MB (parity). The stacked configuration requires two VMEbus slots.
- ❑ The DRAM is four-way interleaved to efficiently support cache burst cycles.
- ❑ The parity mezzanines are only supported on 25 MHz main boards.

A functional description of the Onboard DRAM starts on page [2-15](#).

SCSI Mass Storage Interface

The MVME187 provides for mass storage subsystems through the industry-standard SCSI bus. These subsystems may include

- ❑ Hard and floppy disk drives
- ❑ Streaming tape drives
- ❑ Other mass storage devices.

A functional description of the SCSI Interface starts on page [2-22](#).

Serial Ports

The serial ports support standard baud rates of 110 to 38.4K baud.

Serial Port	Function	Synchronous/ Asynchronous	Signals	Bit Rates
1	Minimum	Asynchronous	RXD, CTS, TXD, and RTS	
2 and 3	Full	Asynchronous	RXD, CTS, DCD, TXD, RTS, and DTR	
4	Full	Both	RXD, CTS, DCD, TXD, RTS, and DTR	Synchronous up to 64 k bits per second

All four serial ports use EIA-232-D drivers and receivers located on the main board, and all the signal lines are routed to the I/O connector.

A functional description of the Serial Port Interface starts on page [2-18](#).

Parallel (Printer) Port

The 8-bit bidirectional parallel port may be used as a Centronics-compatible parallel printer port or as a general parallel I/O port.

A functional description of the Parallel Port Interface starts on page [2-20](#).

Ethernet Transceiver Interface

The Ethernet transceiver interface is located on the MVME187, and the industry standard connector is located on the MVME712X transition module.

A functional description of the Ethernet Interface starts on page [2-21](#).

187Bug Firmware

The MVME187Bug debug monitor firmware (187Bug) is provided in two of the four EPROM sockets on the MVME187.

It provides:

- ❑ Over 50 debug commands
- ❑ Up/down load commands
- ❑ Disk bootstrap load commands
- ❑ A full set of onboard diagnostics
- ❑ A one-line assembler/disassembler

The 187Bug user interface accepts commands from the system console terminal.

187Bug can also operate in a System Mode, which includes choices from a service menu.

Features

- ❑ M88000 Microprocessor (one MC88100 MPU and two MC88200 or MC88204 CMMUs)
- ❑ 4/8/16/32/64MB of 32-bit DRAM with parity or 4/8/16/32/64/128/256MB of 32-bit DRAM with ECC protection
- ❑ Four 44-pin PLCC ROM sockets (organized as two banks of 32 bits)
- ❑ 128KB Static RAM (with optional battery backup as a factory build special request)
- ❑ Status LEDs for FAIL, STAT, RUN, SCON, LAN, +12V (LAN power), SCSI, and VME.
- ❑ 8K by 8 static RAM and time of day clock with battery backup

- ❑ RESET and ABORT switches
- ❑ Four 32-bit tick timers for periodic interrupts
- ❑ Watchdog timer
- ❑ Eight software interrupts
- ❑ I/O
 - SCSI Bus interface with DMA
 - Four serial ports with EIA-232-D buffers with DMA
 - Centronics printer port
 - Ethernet transceiver interface with DMA
- ❑ VMEbus interface
 - VMEbus system controller functions
 - VMEbus interface to local bus (A24/A32, D8/D16/D32 and D8/D16/D32/D64BLT) (BLT = Block Transfer)
 - Local bus to VMEbus interface (A16/A24/A32, D8/D16/D32)
 - VMEbus interrupter
 - VMEbus interrupt handler
 - Global CSR for interprocessor communications
 - DMA for fast local memory - VMEbus transfers (A16/A24/A32, D16/D32 and D16/D32/D64BLT)

Specifications

Table 2-1. MVME187 General Specifications

Characteristics		Specifications	
Power requirements (with all four EPROM sockets populated and excluding external LAN transceiver)		+5 Vdc (+/-5%)	3.5 A (typical), 4.5 A (maximum) (at 25 MHz, with 32MB parity DRAM)
			5.0 A (typical), 6.5 A (maximum) (at 33 MHz, with 128MB ECC DRAM)
		+12 Vdc (+/-5%)	100 mA (maximum) (1.0 A (maximum) with offboard LAN transceiver)
		-12 Vdc (+/- 5%)	100 mA (maximum)
Operating temperature		0° to 55° C at point of entry of forced air (approximately 490 LFM)	
Storage temperature		-40° to +85° C	
Relative humidity		5% to 90% (non-condensing)	
Physical dimensions Double-high VMEboard	PC board with mezzanine module only	Height	9.187 inches (233.35 mm)
		Depth	6.299 inches (160.00 mm)
		Thickness	0.662 inches (16.77 mm)
	PC board with connectors and front panel	Height	10.309 inches (261.85 mm)
		Depth	7.4 inches (188 mm)
		Thickness	0.80 inches (20.32 mm)

Conformance to Requirements

These boards are designed to conform to the requirements of the following specifications:

- ❑ VMEbus Specification (IEEE 1014-87)
- ❑ EIA-232-D Serial Interface Specification, EIA
- ❑ SCSI Specification

Board Level Overview

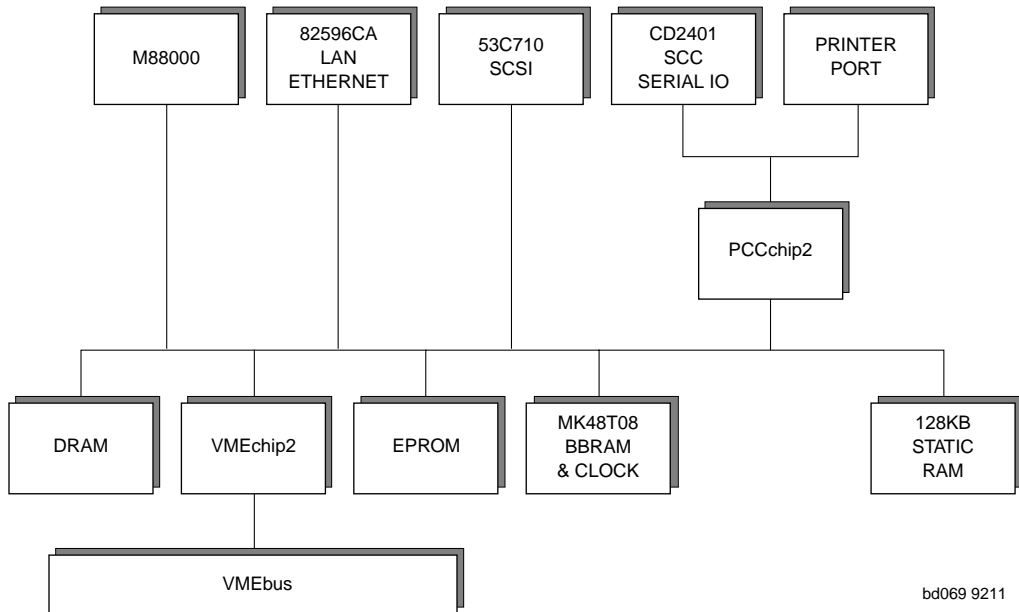

Figure 2-1. MVME187 General Block Diagram

Connectors

The MVME187 has two 96-position DIN connectors: P1 and P2.

- ❑ P1 rows A, B, C, and P2 row B provide the VMEbus interconnection.
- ❑ P2 rows A and C provide the connection to the SCSI bus, serial ports, Ethernet, and printer.

Adapters

I/O on the MVME187 is connected to the VMEbus P2 connector.

The main board is connected to the transition modules through a P2 adapter board and cables.

Transition Modules

MVME712X transition modules provide configuration headers and provide industry standard connectors for the I/O devices. Refer to [Figure 3-3 on page 3-22](#).

- ❑ The MVME187 supports the transition modules MVME712-12, MVME712-13, MVME712M, MVME712A, MVME712AM, and MVME712B (referred to in this manual as MVME712X, unless separately specified).

Transition modules and adapter boards are covered in MVME712M, *Transition Module and P2 Adapter Board User's Manual*, and MVME712A, MVME712-12, MVME712-13, MVME712A, MVME712AM, and MVME712B *Transition Modules and LCP2 Adapter Board User's Manual*.

ASICs

The MVME187 board features several Application Specific Integrated Circuits (ASICs) including:

- ❑ VMEchip2
- ❑ PCCchip2
- ❑ MEMC040
- ❑ MCECC

All programmable registers in the MVME187 that reside in ASICs are covered in the *Single Board Computers Programmer's Reference Guide*.

VMEchip2 ASIC

Provides the VMEbus interface. The VMEchip2 includes:

- ❑ Two tick timers
- ❑ Watchdog timer
- ❑ Programmable map decoders for the master and slave interfaces, and a VMEbus to/from local bus DMA controller
- ❑ VMEbus to/from local bus non-DMA programmed access interface
- ❑ VMEbus interrupter
- ❑ VMEbus system controller
- ❑ VMEbus interrupt handler
- ❑ VMEbus requester

Table 2-2. Bus Transfers

Transfer type	Can be...
Processor-to-VMEbus	D8, D16, or D32
VMEchip2 DMA to the VMEbus	D16, D32, D16/BLT, D32/BLT, or D64/MBLT

PCCchip2 ASIC

The PCCchip2 ASIC provides two tick timers and the interface to the:

- ❑ LAN chip
- ❑ SCSI chip
- ❑ Serial port chip
- ❑ Printer port
- ❑ BBRAM

MEMC040 Memory Controller ASIC

The MEMC040 memory controller ASIC provides the programmable interface for the parity-protected DRAM mezzanine board.

MCECC Memory Controller ASIC

The MCECC memory controller ASIC provides the programmable interface for the ECC-protected DRAM mezzanine board.

Functional Description

The major functional blocks of the MVME187 covered in this section are:

- ❑ Front panel switches and LED indicators
- ❑ Data bus structure
- ❑ M88000 MPU
- ❑ EPROM
- ❑ SRAM
- ❑ Onboard DRAM
- ❑ Battery backed up RAM and clock
- ❑ VMEbus interface
- ❑ I/O interfaces
- ❑ Local resources

Front Panel Switches and LEDs

There are two switches and eight LEDs on the board's front panel (refer to [Table 2-3](#), [Table 2-4](#), and [Figure 3-1 on page 3-6](#)).

Table 2-3. Front Panel Switches

Switch Name	Description
RESET	The RESET switch resets all onboard devices and drives SYSRESET* if the board is system controller. The RESET switch may be disabled by software.
ABORT	When enabled by software, the ABORT switch generates an interrupt at a user-programmable level. It is normally used to abort program execution and return to the debugger.

Table 2-4. Front Panel LEDs

LED Name	Color	Description
FAIL	Red	The FAIL LED lights when the BRDFAIL signal line is active.
STAT	Yellow	The STAT LED is controlled by software on the MVME187.
RUN	Green	The RUN LED lights when the local bus TIP* signal line is low. This indicates one of the local bus masters is executing a local bus cycle.
SCON	Green	The SCON LED lights when the MVME187 is the VMEbus system controller.
LAN	Green	The LAN LED lights when the LAN chip is local bus master.
+12V	Green	The +12V LED lights when +12V power is available to the Ethernet transceiver interface.
SCSI	Green	The SCSI LED lights when the SCSI chip is local bus master.
VME	Green	The VME LED lights when the board is using the VMEbus (VMEbus AS* is asserted by the VMEchip2) or when the board is accessed by the VMEbus (VMEchip2 is the local bus master).

Data Bus Structure

The local data bus on the MVME187 is a 32-bit synchronous bus based on the MC68040 bus, and supports burst transfers and snooping.

Local Bus Arbitration

The various local bus master and slave devices use the local bus to communicate.

The local bus is arbitrated by priority type arbiter and the priority of the local bus masters from highest to lowest is:

1. 82596CA LAN (highest)
2. CD2401 serial (through the PCCchip2)
3. 53C710 SCSI
4. VMEbus
5. MPU (lowest)

In general, any master can access any slave; however, not all combinations pass the “common sense test.” Refer to the *Single Board Computers Programmer’s Reference Guide* and to the user’s guide for each device to determine its port size, data bus connection, and any restrictions that apply when accessing the device.

M88000 MPU

The MVME187 is based on the M88000 family and uses one MC88100 MPU and two MC88200 or MC88204 CMMUs.

One CMMU is used for the data cache and one is used for the instruction cache.

More information is available in the MC88100 and MC88200 user’s manuals and the MC88204 data sheet.

EPROM

Four 44-pin PLCC/CLCC EPROM sockets for 27C102JK or 27C202JK type EPROMs. They are:

- ❑ Organized in two 32-bit wide banks supporting 8-, 16-, and 32-bit read accesses
- ❑ Controlled by the VMEchip2
- ❑ Mapped to local bus address 0 following a local bus reset
 - This allows the MC88100 to start executing code at address 0 following a reset.

Programmable EPROM Features

- ❑ Map decoder
- ❑ Access time
- ❑ When accessible at address 0

Static RAM

The MVME187 includes 128KB of 32-bit wide 100 ns static RAM (SRAM), which:

- ❑ Supports 8-, 16-, and 32-bit wide accesses.
- ❑ Allows debugger operation and execution of limited diagnostics without the DRAM mezzanine.
- ❑ Is controlled by the VMEchip2; the access time is programmable.

Optional SRAM Battery Backup

SRAM battery backup is optionally available on the MVME187, *but only as a factory build and only by special request*. (Contact your local Motorola sales office for details). The battery backup function, provided by a Dallas DS1210S nonvolatile controller chip and a RAYOVAC FB1225 battery, supports primary and secondary power sources.

The onboard power source is a RAYOVAC FB1225 battery which has two BR1225-type lithium cells and is socketed for easy removal and replacement. A small capacitor is provided to allow the battery to be quickly replaced without data loss (i.e., the battery must be replaced within 30 seconds).

If your MVME187 is equipped with SRAM battery backup, when the main board power fails, the DS1210S selects the source with the highest voltage.

If one source should fail, the DS1210S switches to the redundant source.

Each time the board is powered, the DS1210S checks power sources, allowing software to provide an early warning to avoid data loss:

- ❑ If the voltage of the backup sources is less than two volts, the second memory access cycle is blocked.
- ❑ Because the DS1210S may block the second access, the software should do at least two accesses before relying on the data.

With the optional battery backup, the MVME187 provides jumpers (see *Optional SRAM Backup Power Source Select Header J6* on page 3-11) that allow either power source of the DS1210S to be connected to the VMEbus +5 V STDBY pin or to one cell of the onboard battery.

The power leads from the battery are exposed on the solder side of the board, therefore the board should not be placed on a conductive surface or stored in a conductive bag unless the battery is removed.



Lithium batteries incorporate inflammable materials such as lithium and organic solvents. If lithium batteries are mistreated or handled incorrectly, they may burst open and ignite, possibly resulting in injury and /or fire.

When dealing with lithium batteries, carefully follow the precautions listed below in order to prevent accidents.

- ❑ Do not short circuit.
- ❑ Do not disassemble, deform, or apply excessive pressure.
- ❑ Do not heat or incinerate.
- ❑ Do not apply solder directly.
- ❑ Do not use different models.
- ❑ Do not charge.
- ❑ Always check proper polarity.

To remove the battery from the module, carefully pull the battery from the socket. (Data will be lost if a new battery is not installed within 30 seconds.)

Before installing a new battery, ensure that the battery pins are clean. Note the battery polarity and press the battery into the socket.

Onboard DRAM

The MVME187 onboard DRAM is located on a mezzanine board. The mezzanine boards are available in different sizes and with parity protection or ECC protection.

Note Parity mezzanines are only supported on 25 MHz main boards.

Motorola software *does* support mixed parity and ECC memory boards on the same main board.

The DRAM is four-way interleaved to efficiently support cache burst cycles.

Onboard DRAM mezzanines are available in these configurations:

- ❑ 4, 8, 16, or 32MB with parity protection
- ❑ 4, 8, 16, 32, 64, or 128 MB with ECC protection

Stacking Mezzanines

Two mezzanine boards may be stacked to provide up to 256MB of onboard RAM (ECC).

- ❑ The MVME187 board and a single mezzanine board together take one slot.
- ❑ The stacked configuration requires two VMEboard slots.

DRAM Programming Considerations

- ❑ The DRAM map decoder can be programmed to accommodate different base address(es) and sizes of mezzanine boards.
- ❑ Onboard DRAM is disabled by a local bus reset and must be programmed before the DRAM can be accessed.
- ❑ Most DRAM devices require some number of access cycles before the DRAMs are fully operational.
 - Normally this requirement is met by the onboard refresh circuitry and normal DRAM installation. However, software should insure a minimum of 10 initialization cycles are performed to each bank of RAM.

Refer to the MEMC040 or the MCECC in the *Single Board Computers Programmer's Reference Guide* for detailed programming information.

Battery Backed Up RAM and Clock

The MK48T08 RAM and clock chip is a 28-pin package that provides

- ❑ A time-of-day clock
- ❑ An oscillator
- ❑ A crystal
- ❑ Power fail detection
- ❑ Memory write protection
- ❑ 8KB of RAM
- ❑ A battery

The clock provides

- ❑ Seconds, minutes, hours, day, date, month, and year in BCD 24-hour format
- ❑ Automatic corrections for 28-, 29- (leap year), and 30-day months

No interrupts are generated by the clock.

The MK48T08 is an 8 bit device; however, the interface provided by the PCCchip2 supports 8-, 16-, and 32-bit accesses to the MK48T08.

Refer to the MK48T08 data sheet for detailed programming information.

VMEbus Interface

The VMEchip2 provides:

- ❑ Local bus to VMEbus interface
- ❑ VMEbus to local bus interface
- ❑ Local-VMEbus DMA controller functions
- ❑ VMEbus system controller functions

I/O Interfaces

The MVME187 provides onboard I/O for many system applications.

- ❑ The I/O functions include:
 - Serial ports
 - Printer port
 - Ethernet transceiver interface
 - SCSI mass storage interface
- ❑ An external I/O transition board such as the MVME712X should be used to convert the I/O connector pinout to industry-standard connectors.
- ❑ The configuration headers are located on the MVME187 and the MVME712X transition board.

The I/O on the MVME187 is connected to the VMEbus P2 connector. The MVME712X transition module is connected to the MVME187 through cables and a P2 adapter board.

Serial Port Interface

The CD2401 serial controller chip (SCC) implements the four serial ports. The serial ports support the standard baud rates (110 to 38.4K baud). The four serial ports are different functionally because of the limited number of pins on the P2 I/O connector.

All four serial ports use EIA-232-D drivers and receivers located on the MVME187, and all the signal lines are routed to the I/O connector.

- ❑ Serial port 1 is a minimum function asynchronous port. It uses RXD, CTS, TXD, and RTS.
- ❑ Serial ports 2 and 3 are full function asynchronous ports. They use RXD, CTS, DCD, TXD, RTS, and DTR.
- ❑ Serial port 4 is a full function asynchronous or synchronous port. It can operate at synchronous bit rates up to 64 k bits per second. It uses RXD, CTS, DCD, TXD, RTS, and DTR. It also interfaces to the synchronous clock signal lines.

Serial Interface Programming Considerations

- ❑ The MVME187 board hardware ties the DTR signal from the CD2401 to the pin labeled RTS at connector P2. Likewise, RTS from the CD2401 is tied to DTR on P2. Therefore, when programming the CD2401, assert DTR when you want RTS, and RTS when you want DTR.
- ❑ The interface provided by the PCCchip2 allows the 16-bit CD2401 to appear at contiguous addresses.
- ❑ Accesses to the CD2401 must be 8 or 16 bits: 32-bit accesses are not permitted.
- ❑ The CD2401 supports DMA operations to local memory.
- ❑ Because the CD2401 does not support a retry operation necessary to break VMEbus lockup conditions, the CD2401 DMA controllers should not be programmed to access the VMEbus.
- ❑ The hardware does not restrict the CD2401 to onboard DRAM.

Refer to the CD2401 data sheet for detailed programming information.

Parallel Port Interface

The PCCchip2 provides an 8-bit bidirectional parallel port. This port may be used as a Centronics-compatible parallel printer port or as a general parallel I/O port.

All eight bits of the port must be either inputs or outputs (no individual bit selection).

In addition to the 8 bits of data, there are two control pins and five status pins.

When used as a parallel printer port, these pins function as follows:

Status Pins	Printer Acknowledge (ACK*)
	Printer Fault (FAULT*)
	Printer Busy (BSY)
	Printer Select (SELECT)
	Printer Paper Error (PE)
Control Pins	Printer Strobe (STROBE*)
	Input Prime (INP*)

Each of the status pins can generate an interrupt to the MPU in any of the following programmable conditions:

- High level
- Low level
- High-to-low transition
- Low-to-high transition

The PCCchip2 provides an auto-strobe feature similar to that of the MVME147 PCC.

- ❑ In auto-strobe mode, after a write to the Printer Data Register, the PCCchip2 automatically asserts the STROBE* pin for a selected time specified by the Printer Fast Strobe control bit.
- ❑ In manual mode, the Printer Strobe control bit directly controls the state of the STROBE* pin.

Ethernet Interface

The 82596CA implements the Ethernet transceiver interface. The 82596CA accesses local RAM using DMA operations to perform its normal functions.

The Ethernet transceiver interface is located on the MVME187, and the industry standard connector is located on the MVME712X transition module.

Every MVME187 is assigned an Ethernet Station Address. The address is \$08003E2xxxxx where xxxxx is the unique 5-nibble number assigned to the board (i.e., every MVME187 has a different value for xxxxx).

Each module has the Ethernet Station Address displayed on a label attached to the VMEbus P2 connector. In addition, the six bytes including the Ethernet address are stored in the configuration area of the BBRAM. That is, 08003E2xxxxx is stored in the BBRAM.

- ❑ At an address of \$FFFC1F2C, the upper four bytes (08003E2x) can be read.
- ❑ At an address of \$FFFC1F30, the lower two bytes (xxxx) can be read.

The MVME187 debugger has the capability to retrieve or set the Ethernet address.

If the data in the BBRAM is lost, the user should use the number on the VMEbus P2 connector label to restore it.

Buffer Overruns

Because the 82596CA has small internal buffers and the VMEbus has an undefined latency period, buffer overrun may occur if the DMA is programmed to access the VMEbus. Therefore, the 82596CA should not be programmed to access the VMEbus. Support functions for the 82596CA are provided by the PCCchip2.

Refer to the 82596CA user's guide for detailed programming information.

SCSI Interface

The MVME187 provides for mass storage subsystems through the industry-standard SCSI bus. These subsystems may include hard and floppy disk drives, streaming tape drives, and other mass storage devices.

The SCSI interface is implemented using the NCR 53C710 SCSI I/O controller.

Support functions for the 53C710 are provided by the PCCchip2. Refer to the 53C710 user's guide for detailed programming information.

SCSI Termination

Because this board has no provision for SCSI termination, you must ensure that the SCSI bus is terminated properly.

- ❑ If the SCSI bus ends at the P2 Adapter, termination resistors must be installed on the R1, R2, and R3 sockets using three 8-pin SIP resistors. Note: +5V power to the SCSI bus TERM power line and termination resistors is provided through a fuse located on the P2 transition board.
- ❑ If there are additional SCSI mass storage devices in your system, make sure that terminators are installed on the last device in the SCSI chain.

Local Resources

The MVME187 includes many resources for the local processor. These include tick timers, software programmable hardware interrupts, watchdog timer, and local bus timeout.

Programmable Tick Timers

Four 32-bit programmable tick timers with 1 μ s resolution are provided, two in the VMEchip2 and two in the PCCchip2. The tick timers can be programmed to generate periodic interrupts to the processor.

Watchdog Timer

A watchdog timer function is provided in the VMEchip2. When the watchdog timer is enabled, it must be reset by software within the programmed time or it times out. The watchdog timer can be programmed to generate a SYSRESET signal, local reset signal, or board fail signal if it times out.

Software-Programmable Hardware Interrupts

Eight software-programmable hardware interrupts are provided by the VMEchip2. These interrupts allow software to create a hardware interrupt.

Local Bus Timeout

The MVME187 provides a timeout function for the local bus. When the timer is enabled and a local bus access times out, a Transfer Error Acknowledge (TEA) signal is sent to the local bus master. The timeout value is selectable by software for 8 μ sec, 64 μ sec, 256 μ sec, or infinite. The local bus timer does not operate during VMEbus bound cycles. VMEbus bound cycles are timed by the VMEbus access timer and the VMEbus global timer.

Memory Maps

There are two points of view for memory maps:

1. Local bus memory map
 - the mapping of all resources as viewed by local bus masters
2. VMEbus memory map
 - the mapping of onboard resources as viewed by VMEbus Masters

Local Bus Memory Map

The local bus memory map is split into different address spaces by the transfer type (TT) signals. The local resources respond to the normal access and interrupt acknowledge codes.

Normal Address Range Devices

The memory map of devices that respond to the normal address range is shown in the following tables. The normal address range is defined by the Transfer Type (TT) signals on the local bus.

- ❑ On the MVME187, Transfer Types 0 and 1 define the normal address range.

[Table 2-5 on page 2-25](#) is the entire map from \$00000000 to \$FFFFFFFF. Many areas of the map are user-programmable, and suggested uses are shown in the table.

- ❑ The cache inhibit function is programmable in the MMUs.
- ❑ The onboard I/O space must be marked cache inhibit and serialized in its page table.

[Table 2-6 on page 2-26](#) further defines the map for the local I/O devices.

Table 2-5. Local Bus Memory Map

Address Range	Devices Accessed	Port Size	Size	Software Cache Inhibit	Notes
\$00000000 - DRAMSIZE	User programmable (onboard DRAM)	D32	DRAMSIZE	N	1, 2
DRAMSIZE - \$FF7FFFFF	User programmable (VMEbus)	D32/D16	3GB	?	3, 4
\$\$FF800000 - \$\$FFBFFFFFFF	ROM	D32	4MB	N	1
\$\$FFC00000 - \$\$FFDFFFFFFF	Reserved	--	2MB	--	5
\$\$FFE00000 - \$\$FFE1FFFF	SRAM	D32	128KB	N	--
\$\$FFE20000 - \$\$FFEFFFFFFF	SRAM (repeated)	D32	896KB	N	--
\$\$\$\$F00000 - \$\$\$\$\$FFFFFFF	Local I/O devices (refer to next table)	D32-D8	1MB	Y	3
\$\$\$\$F0000 - \$\$\$\$\$FFFFF	User programmable (VMEbus A16)	D32/D16	64KB	?	2, 4

Notes

1. Onboard EPROM appears at \$00000000 - \$003FFFFFFF following a local bus reset. The EPROM appears at 0 until the ROM0 bit is cleared in the VMEchip2. The ROM0 bit is located at address \$FFF40030 bit 20. The EPROM must be disabled at 0 before the DRAM is enabled. The VMEchip2 and DRAM map decoders are disabled by a local bus reset.
2. This area is user-programmable. The suggested use is shown in the table. The DRAM decoder is programmed in the MEMC040 or MCECC chip, and the local-to-VMEbus decoders are programmed in the VMEchip2.
3. Size is approximate.
4. Cache inhibit depends on devices in area mapped.
5. This area is not decoded. If these locations are accessed and the local bus timer is enabled, the cycle times out and is terminated by a TEA signal.

The following table focuses on the Local I/O Devices portion of the local bus Main Memory Map.

Table 2-6. Local I/O Devices Memory Map

Address Range	Devices Accessed	Port Size	Size	Notes
\$FFF00000 - \$FFF3FFFF	Reserved	--	256KB	4
\$FFF40000 - \$FFF400FF	VMEchip2 (LCSR)	D32	256B	1,3
\$FFF40100 - \$FFF401FF	VMEchip2 (GCSR)	D32-D8	256B	1,3
\$FFF40200 - \$FFF40FFF	Reserved	--	3.5KB	4,6
\$FFF41000 - \$FFF41FFF	Reserved	--	4KB	4
\$FFF42000 - \$FFF42FFF	PCCchip2	D32-D8	4KB	1
\$FFF43000 - \$FFF430FF	MEMC040/MCECC #1	D8	256B	1
\$FFF43100 - \$FFF431FF	MEMC040/MCECC #2	D8	256B	1
\$FFF43200 - \$FFF43FFF	MEMC040s/MCECCs (repeated)	--	3.5KB	1,6
\$FFF44000 - \$FFF44FFF	reserved	--	4KB	4
\$FFF45000 - \$FFF451FF	CD2401 (Serial Comm. Cont.)	D16-D8	512B	1
\$FFF45200 - \$FFF45DFF	Reserved	--	3KB	6,8
\$FFF45E00 - \$FFF45FFF	Reserved	--	512B	8
\$FFF46000 - \$FFF46FFF	82596CA (LAN)	D32	4KB	1,7
\$FFF47000 - \$FFF47FFF	53C710 (SCSI)	D32/D8	4KB	1
\$FFF48000 - \$FFF4FFFF	Reserved	--	32KB	4
\$FFF50000 - \$FFF6FFFF	Reserved	--	128KB	4
\$FFF70000 - \$FFF76FFF	Reserved	--	28KB	5
\$FFF77000 - \$FFF77FFF	CODE CMMU	D32	4KB	1
\$FFF78000 - \$FFF7EFFF	Reserved	--	28KB	5
\$FFF7F000 - \$FFF7FFFF	DATA CMMU	D32	4KB	1
\$FFF80000 - \$FFF9FFFF	Reserved	--	128KB	5
\$FFFA0000 - \$FFFBFFFF	Reserved	--	128KB	4
\$FFFC0000 - \$FFFCFFFF	MK48T08 (BBRAM, TOD Clock)	D32-D8	64KB	1
\$FFFD0000 - \$FFFDFFFF	Reserved	--	64KB	4
\$FFFE0007	IACK LEVEL 1	D8	1 byte	2

Table 2-6. Local I/O Devices Memory Map (Continued)

Address Range	Devices Accessed	Port Size	Size	Notes
\$FFFE000B	IACK LEVEL 2	D8	1 byte	2
\$FFFE000F	IACK LEVEL 3	D8	1 byte	2
\$FFFE0013	IACK LEVEL 4	D8	1 byte	2
\$FFFE0017	IACK LEVEL 5	D8	1 byte	2
\$FFFE001B	IACK LEVEL 6	D8	1 byte	2
\$FFFE001F	IACK LEVEL 7	D8	1 byte	2
\$FFFE0020 - \$FFFEFFFF	IACK LEVELS (repeated)	--	64KB	2,6

Notes

1. For a complete description of the register bits, refer to the *Single Board Computers Programmer's Reference Guide* or to the data sheet for the specific chip.
2. Byte reads should be used to read the interrupt vector. These locations do not respond when an interrupt is not pending. If the local bus timer is enabled, the access times out and is terminated by a TEA signal.
3. Writes to the LCSR in the VMEchip2 must be 32 bits. LCSR writes of 8 or 16 bits terminate with a TEA signal. Writes to the GCSR may be 8, 16 or 32 bits. Reads to the LCSR and GCSR may be 8, 16 or 32 bits.
4. This area does not return an acknowledge signal. If the local bus timer is enabled, the access times out and is terminated by a TEA signal.
5. This area does return an acknowledge signal.
6. Size is approximate.
7. Port commands to the 82596CA must be written as two 16-bit writes: upper word first and lower word second.
8. The CD2401 appears repeatedly from \$FFF45200 to \$FFF45FFF. If the local bus timer is enabled, the access times out and is terminated by a TEA signal.

VMEbus Memory Map

This section describes the mapping of local resources as viewed by VMEbus masters. Default addresses for the slave, master, and GCSR address decoders are provided by the **ENV** command. Refer to Appendix A.

VMEbus Accesses to the Local Bus

The VMEchip2 includes a user-programmable map decoder for the VMEbus to local bus interface. The map decoder allows you to program the starting and ending address and the modifiers the MVME187 responds to.

VMEbus Short I/O Memory Map

The VMEchip2 includes a user-programmable map decoder for the GCSR. The GCSR map decoder allows you to program the starting address of the GCSR in the VMEbus short I/O space.

This Chapter Covers

This chapter provides instructions on:

- ❑ Unpacking the equipment
- ❑ Preparing the hardware
- ❑ Installing the MVME187 RISC Single Board Computer

Note that hardware preparation instructions for the MVME712X transition module are provided in separate user's manuals for each model. Refer to the user's manual you received with your MVME712X.

Unpacking the Equipment

Note If the shipping carton is damaged upon receipt, request that the carrier's agent be present during unpacking and inspection of the equipment.

Unpack the equipment from the shipping carton. Refer to the packing list and verify that all items are present. Save the packing material for storing and reshipping of the equipment.



Caution

Avoid touching areas of integrated circuitry; static discharge can damage circuits.

Overview of Startup Procedure

The following list identifies the things you will need to do before you can use this board, and where to find the information you need to perform each step. Be sure to read this chapter and all Caution notes, and have the related documentation with you before you begin.

Table 3-1. Startup Overview

Stage	What you will need to do...	Refer to...	On page...
1	Prepare the MVME187.	<i>Preparing the Hardware</i>	3-5
	Ensure that EPROM devices are properly installed in their sockets.	<i>Checking the 187Bug EPROMs</i>	3-7
	Configure adapters and MVME712X transition modules.	The user's manual you received with your MVME712X module	
	Install/remove jumpers on headers.	<i>Jumper Settings</i>	3-7
2	Prepare the chassis.	<i>Preparing the MVME187 for Installation</i>	3-14
	Turn power off to chassis and peripherals.	The user's manual you received with your chassis	3-15
	Disconnect AC power cable.		
	Remove chassis cover.		
	Remove filler panels from card slots.		
3	Install your MVME187 in the chassis.	<i>Installing the Hardware</i>	3-16
	Remove IACK and BG jumpers from backplane.		
	Slide the module into the chassis and fasten it securely.		

Table 3-1. Startup Overview (Continued)

Stage	What you will need to do...		Refer to...	On page...
4	Install adapter boards and transition modules.		<i>Transition Modules and Adapter Boards Overview</i>	3-17
			<i>Installing Transition Modules and Adapter Boards</i>	3-20
		Set jumpers on the transition module(s).	The user's manual you received with your MVME712X	
		Connect and install the MVME712X transition module.		
	Connect and install the P2 adapter board.			
5	Connect peripherals.		<i>Connecting Peripherals</i>	3-20
		Connect and install any optional SCSI device cables.	You may also wish to obtain the <i>Single Board Computer SCSI Software User's Manual</i>	
		Connect a console terminal to the MVME712X.		
		Connect any other optional devices or equipment you will be using, such as serial or parallel printers, host computers, etc.	<i>EIA-232-D Interconnections</i>	E-1
	<i>Port Numbers</i>		5-7	
	<i>Disk/Tape Controller Data</i>		B-1	
6	Complete the installation.		The user's manual you received with your chassis	
		Reassemble chassis.		
		Reconnect AC power.		

Table 3-1. Startup Overview (Continued)

Stage	What you will need to do...	Refer to...	On page...	
7	Start up the system.	<i>Starting the System</i>	3-24	
		Power up the system.	<i>Front Panel Switches and LEDs</i>	2-11
		Initialize the real-time clock.	<i>Initializing the Real-Time Clock</i>	3-25
		Note that the debugger prompt appears.	<i>Powering Up the System</i>	3-25
			<i>Starting Up 187Bug</i>	4-6
			You may also wish to obtain the <i>Debugging Package for Motorola 88K RISC CPUs User's Manual</i> and the <i>187Bug Diagnostics User's Manual</i>	
		Examine and/or change environmental parameters.	<i>Examining and/or Changing Environmental Parameters</i>	3-25
			<i>Setting Environment to Bug/Operating System</i>	A-3
		Program the PCCchip2 and VMEchip2.	<i>Memory Maps</i>	2-24
		Troubleshoot the system.	<i>Troubleshooting the MVME187: Solving Startup Problems</i>	D-1
	Solve any startup problems			

Preparing the Hardware

This section covers:

- ❑ Modifying hardware configurations before installation
- ❑ Checking the 187Bug EPROMs
- ❑ Factory jumper settings
- ❑ Preparing your MVME187
- ❑ Preparing the system chassis

Modifying Configuration before Installation

To select the desired configuration and ensure proper operation of the MVME187, certain option modifications may be necessary before installation.

The location of the switches, jumper headers, connectors, and LED indicators on the MVME187 is illustrated in Figure 3-1.

Option Modification

The MVME187 has provisions for option modification via:

- ❑ Software control for most options
- ❑ Jumper settings on headers for some options
- ❑ Bit settings in control registers after installation for most other options
 - Control registers are described in the *Single Board Computer Programmer's Reference Guide* as listed in *Related Documentation* in Chapter 1 of this manual.

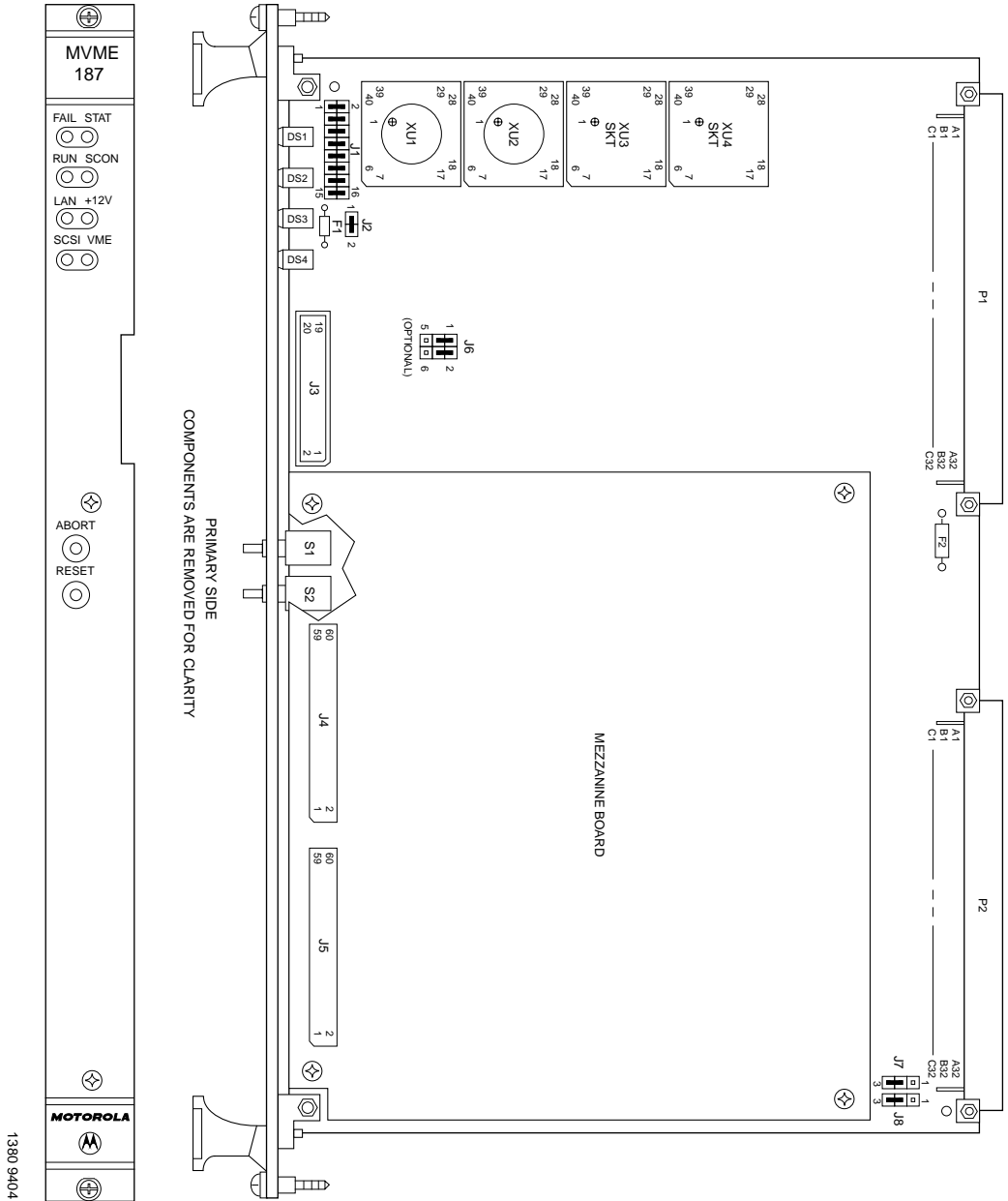

Checking the 187Bug EPROMs

Be sure that the two factory installed 128K x 16 187Bug EPROMs are in the proper sockets.

EPROM Location

- ❑ Odd-numbered label (such as B01): EPROM in socket XU1 (for Least Significant Half-Words)
- ❑ Even-numbered label (such as B02): EPROM in XU2 (for Most Significant Half-Words)

EPROM Orientation

Be sure that physical chip orientation is correct:

- ❑ The flatted corner of each EPROM aligns with the corresponding portion of the EPROM socket on the MVME187.

User-programmed EPROMs

There are two spare EPROM sockets, XU3 and XU4, available to carry user-programmed EPROMs.

Jumper Settings

The MVME187 has been factory tested and is shipped with the factory jumper settings described on the following pages. The MVME187 operates with its required and factory-installed Debug Monitor, 187Bug, with these factory jumper settings.

Optional Jumper Settings

Most of the optional functions on your board can be changed through software control or bit settings in control registers. If your installation requires it, however, you may change jumper settings on the following headers:

- ❑ Jumper pins 9 through 16 on header **J1** are general purpose software readable jumpers open to your application.
- ❑ Header **J2** enables/disables the MVME187 as system controller.
- ❑ Optional header **J6** selects the SRAM backup power source (this is only available as an optional factory build special request).
- ❑ Headers **J7** and **J8** select serial port 4 to drive or receive TRXC4 and RTXC4 clock signals.

General Purpose Software Readable Header J1

Each MVME187 may be configured with readable jumpers. They can be read as a register (at \$FFF40088) in the VMEchip2 LCSR. The bit values are read as a one when the jumper is off, and as a zero when the jumper is on

Reserved/Defined Bits

Jumpers on header J1 affect 187Bug operation as listed in [Table 3-2](#). The factory (default) configuration is with all eight jumpers installed (see [Table 3-3](#)).

The MVME187BUG reserves/defines the four lower order bits (GPI3 to GPI0). [Table 3-2](#) describes the bits reserved/defined by the debugger:

Table 3-2. J1 Bit Descriptions

Bit	J1 Pins	Description
Bit #0 (GPI0)	1-2	When this bit is a one (high), it instructs the debugger to use local Static RAM for its work page (i.e., variables, stack, vector tables, etc.). This bit will be high when jumper is removed.
Bit #1 (GPI1)	3-4	When this bit is a one (high), it instructs the debugger to use the default setup/operation parameters in ROM versus the user setup/operation parameters in NVRAM. This is the same as depressing the RESET and ABORT switches at the same time. This feature can be used in the event the user setup is corrupted or does not meet a sanity check. Refer to the ENV command (Appendix A) for the ROM defaults. This bit will be high when jumper is removed.
Bit #2 (GPI2)	5-6	Reserved for future use.
Bit #3 (GPI3)	7-8	Reserved for future use.
Bit #4 (GPI4)	9-10	Open to your application.
Bit #5 (GPI5)	11-12	Open to your application.
Bit #6 (GPI6)	13-14	Open to your application.
Bit #7 (GPI7)	15-16	Open to your application.

Table 3-3. Factory Settings for J1 General Purpose Readable Jumpers

Header Number	Header Description	Configuration	Jumpers
J1	General purpose software readable jumpers	GPI0 - GPI3: Reserved GPI4 - GPI7: User-definable (Factory configuration)	<p>The diagram shows a header with 16 pins. Pins 1-3 are labeled GPI0, GPI1, and GPI2. Pins 4-6 are labeled GPI3, GPI4, and GPI5. Pins 7-9 are labeled GPI6, GPI7, and GPI8. Pins 10-12 are labeled GPI9, GPI10, and GPI11. Pins 13-15 are labeled GPI12, GPI13, and GPI14. Pin 16 is labeled GPI15. The jumpers are shown as vertical bars between the pins. Pins 1, 4, 7, 10, 13, and 16 have jumpers installed, while pins 2, 3, 5, 6, 8, 9, 11, 12, 14, and 15 do not.</p>

System Controller Header J2

The MVME187 can be VMEbus system controller. The system controller function is enabled by installing a jumper on header J2 (see [Table 3-4](#)). When the MVME187 is system controller, the SCON LED is turned on.

Table 3-4. Settings for J2 System Controller Header

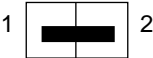
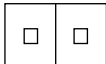
Header Number	Header Description	Configuration	Jumpers
J2	System controller header	System controller (Factory configuration)	<p style="text-align: center;">J2</p>  <p>The diagram shows a two-pin header labeled J2. Pin 1 is on the left and pin 2 is on the right. A solid black horizontal bar is positioned between the two pins, representing a jumper.</p>
		Not system controller	<p style="text-align: center;">J2</p>  <p>The diagram shows a two-pin header labeled J2. Pin 1 is on the left and pin 2 is on the right. There are two small squares, one under each pin, representing the contact points. No jumper is present.</p>

Optional SRAM Backup Power Source Select Header J6

Header J6 is an optional header used to select the SRAM backup power source on the MVME187, if the optional battery is present. (The battery backup for SRAM is optionally available, *but only as a factory build and only by special request.*)



If your system is equipped with the optional battery backup, do not remove the jumpers from J6. This will disable the SRAM. If your board contains optional header J6, but the optional battery is removed, jumpers must be installed between pins 1 and 3 and pins 2 and 4 for the factory configuration as shown in [Table 3-5](#).

Serial Port 4 Clock Configuration Select Headers J7 and J8

Serial port 4 can be configured to use clock signals provided by the TRXC4 and RTXC4 signal lines.

Headers J7 and J8 on the MVME187 configure serial port 4 to drive or receive TRXC4 and RTXC4, respectively (see [Table 3-6](#)).

- ❑ Factory configuration sets port 4 to receive both signals.
- ❑ The alternative configuration sets port 4 to drive both signals

The remaining configuration of the clock lines is accomplished using the Serial Port 4 Clock Configuration Select header on the MVME712M transition module. Refer to the *MVME712M Transition Module and P2 Adapter Board User's Manual* for configuration of that header.

Table 3-5. Settings for Optional J6 SRAM Backup Power Source Select Header

3





Header Number	Header Description	Configuration	Jumpers
J6	SRAM backup power source select header	Primary source VMEbus +5V STBY Secondary source VMEbus +5V STBY (Factory configuration)	J6 
		Primary source optional battery Secondary source optional battery	J6 
		Primary source VMEbus +5V STBY Secondary source optional battery	J6 
		Primary source optional battery Secondary source VMEbus +5V STBY	J6 

Table 3-6. Settings for J7 and J8 Serial Port 4 Clock Configuration Select Headers

Header Number	Header Description	Configuration	Jumpers
J7	Serial Port 4 clock configuration select headers	Receive TRXC4 (Factory configuration)	<p>J7</p> 
		Drive TRXC4	<p>J7</p> 
J8		Receive RTXC4 (Factory configuration)	<p>J8</p> 
		Drive RTXC4	<p>J8</p> 

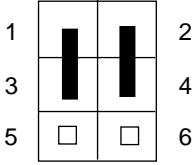
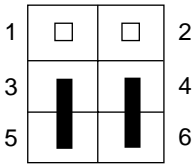
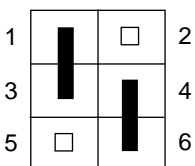
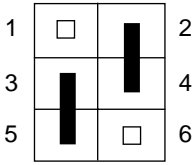
Preparing the MVME187 for Installation

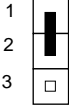
Refer to the setup procedures in the manuals for your particular chassis or system for additional details concerning the installation of the MVME187 into a VME chassis.

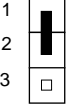
Table 3-7. MVME187 Preparation Procedure

Step	Action
1	<p>Install/remove jumpers on headers according to the <i>Jumper Settings</i> in this chapter and as required for your particular application.</p> <ul style="list-style-type: none"><li data-bbox="316 626 1218 696">❑ Jumpers on header J1 affect 187Bug operation as listed in <i>Jumper Settings</i>. The default condition is with all eight jumpers installed<li data-bbox="316 704 1218 774">❑ A jumper installed/ removed on header J2 enables/ disables the system controller function of the MVME187.<li data-bbox="316 782 1218 852">❑ Install jumpers on headers J7 and J8 to configure serial port 4 to use clock signals provided by the TRXC4 and RTXC4 signal lines.
2	Configure adapters and transition modules according to the <i>MVME712X transition module</i> user's manuals.
3	<p>Ensure that EPROM devices are properly installed in their sockets.</p> <ul style="list-style-type: none"><li data-bbox="316 982 1144 1052">❑ Factory configuration is with two EPROMs installed for the MVME187Bug debug monitor, in sockets XU1 and XU2.

Preparing the System Chassis

Now that the MVME187 module is ready for installation, prepare the system chassis and determine slot assignments (for peripherals, transition modules, etc.) as follows:



Inserting or removing modules while power is applied could result in damage to module components.



Dangerous voltages, capable of causing death, are present in this equipment. Use extreme caution when handling, testing, and adjusting.

Table 3-8. Chassis Preparation/Slot Selection Procedure

Step	Action	
1	Turn all power OFF to chassis and peripherals.	
2	Disconnect AC power cable from source.	
3	Remove chassis cover as shown in the user's manual for your particular chassis or system.	
4	<p>If the MVME187 is configured as system controller:</p> <p>It must be installed in the left-most card slot (slot 1) to correctly initiate the bus-grant daisy-chain and to have proper operation of the IACK-daisy-chain driver.</p>	<p>If it is not configured as system controller:</p> <p>It may be installed in any double-height unused card slot.</p>

Installing the Hardware

This section covers

- ❑ Installation of the MVME187 into a VME chassis
- ❑ Overview and installation of transition modules and adapter boards
- ❑ Connection of peripheral equipment such as console terminals, optional SCSI drives, and serial or parallel printers

Installing the MVME187 in the Chassis

Note that if the MVME187 is to be used as system controller, it must be installed in the left-most card slot (slot 1), otherwise it may be installed in any unused double-height card slot.

Table 3-9. MVME187 Installation Procedure

Step	Action
1	Remove IACK and BG jumpers from backplane for the card slot that the MVME187 is to be installed in.
2	Carefully slide the MVME187 into the card slot in the front of the chassis. <ul style="list-style-type: none">❑ The MVME187 requires power from both P1 and P2. Be sure the module is seated properly into the P1 and P2 connectors on the backplane.❑ Do not damage or bend connector pins.❑ Fasten the MVME187 in the chassis with screws provided, making good contact with the transverse mounting rails to minimize RFI emissions.

Transition Modules and Adapter Boards Overview

The MVME187 supports the MVME712-12, MVME712-13, MVME712M, MVME712A, MVME712AM, and MVME712B transition modules (referred to in this manual as MVME712X, unless separately specified).

Note Other modules in the system may have to be moved to allow space for the MVME712M which has a double-wide front panel.

MVME712X transition modules provide configuration headers and industry-standard connectors for internal and external I/O devices. The I/O on the MVME187 is connected to the VMEbus P2 connector.

- The MVME712X transition module is connected to the MVME187 through cables and a P2 adapter board as shown in [Figure 3-2 on page 3-18](#).

Note Some cable(s) are not provided with the MVME712X module(s), and therefore must be made or provided by the user. (Motorola recommends using shielded cables for all connections to peripherals to minimize radiation.)

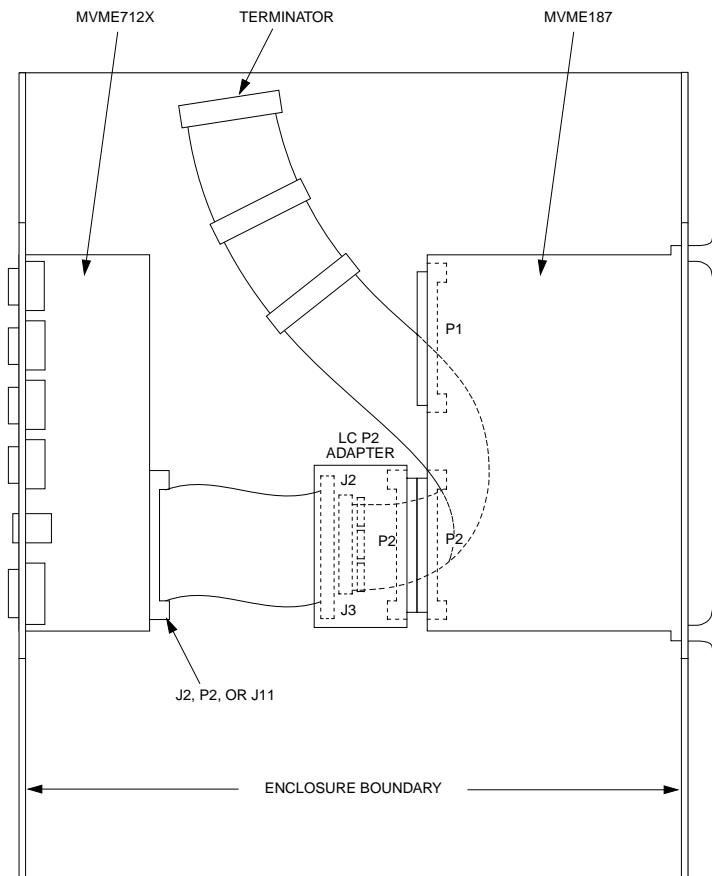

1859 9609

Figure 3-2. Typical Internal SCSI and Serial Port Connections

Equipment Connections

Some connection diagrams are in the *Single Board Computer Programmer's Reference Guide*.

The MVME712X transition modules and P2 adapter boards connect peripheral equipment to the MVME187 as shown in [Table 3-10](#).

Table 3-10. Peripheral Connections

Equipment Type	Connect Through...
Console terminals, host computer systems, modems, or serial printers	EIA-232-D serial ports on the transition module
Parallel printers	Centronics printer port on the transition module
Optional internal modems (see the user's manual for your transition module for details)	Optional modem port, replacing serial port 2 on the transition module
Internal SCSI drives	Adapter board and transition module
External SCSI drives	SCSI interface connector on the transition module
Ethernet connections	Ethernet port on the transition module

Installing Transition Modules and Adapter Boards

Table 3-11. Transition Module and Adapter Board Installation Overview

Stage	What you will need to do...	Refer to...
1	Set jumpers on the transition module(s) and install SCSI terminators (if needed) on the P2 adapter board.	<i>Module Preparation</i> in the user's manual for your transition module and adapter board, and <i>SCSI Bus Termination</i> on page 3-29
2	Connect and install the MVME712X transition module in the front or the rear of the chassis.	<i>Installation Instructions</i> in the user's manual for your transition module and adapter board
3	Connect and install	
	<ul style="list-style-type: none"> ❑ The P2 adapter board at the P2 connector on the backplane at the MVME187 slot. 	<i>Installation Instructions</i> in the user's manual for your transition module and adapter board
	<ul style="list-style-type: none"> ❑ SCSI cable(s) from the P2 adapter board to the MVME712X transition module and internal SCSI devices. 	<i>Module Preparation</i> in the user's manual for your transition module and adapter board, and <i>SCSI Bus Termination</i> on page 3-29

Connecting Peripherals

The MVME187 mates with (optional) terminals or other peripherals at the EIA-232-D serial ports (marked SERIAL PORTS 1, 2, 3, and 4 on the MVME712X transition module), parallel port, SCSI ports, and LAN Ethernet port, as shown in [Figure 3-3 on page 3-22](#).

Note Some cable(s) are not provided with the MVME712X module(s), and therefore are made or provided by the user. (Motorola recommends using shielded cables for all connections to peripherals to minimize radiation.)

Table 3-12. Peripheral Connection Procedures

Step	Action...	Refer to...
1	Connect and install any optional SCSI device cables from J3 on the P2 Adapter to internal devices and/or the MVME712B or MVME712M to external SCSI devices (typical configurations shown in Figure 3-2 on page 3-18 and Figure 3-3 on page 3-22).	The <i>Single Board Computer Programmer's Reference Guide</i> for some possible connection diagrams
2	Connect the terminal to be used as the 187Bug system console to the default debug EIA-232-D port at serial port 1 on the MVME712X transition module.	
3	<p>Set up the terminal as follows:</p> <ul style="list-style-type: none"> ❑ eight bits per character ❑ one stop bit per character ❑ parity disabled (no parity) ❑ baud rate 9600 baud (default baud rate of MVME187 ports at powerup) <p>After power-up, the baud rate of the debug port can be reconfigured by using the Port Format (PF) command of the 187Bug debugger.</p>	
4	Connect devices such as a host computer system and/or a serial printer to the other EIA-232-D port connectors with the appropriate cables and configuration. After power-up, these ports can be reconfigured by programming the MVME187 CD2401 Serial Controller Chip (SCC), or by using the 187Bug PF command.	
	Set up the device serial ports as described in Step 3. After powerup, the baud rate of the port can be reconfigured by using the Port Format (PF) command of the 187Bug debugger.	<i>Configuring a Port</i> under the PF (Port Format) command in the <i>Debugging Package for 88K RISC CPUs User's Manual</i>
5	Connect a parallel device, such as a printer, to the printer port on the MVME712X transition module. (You may also use a module such as the MVME335 for a parallel port connection.)	The <i>Single Board Computer Programmer's Reference Guide</i> for some possible connection diagrams

Note In order for high-baud rate serial communication between 187Bug and the terminal to work, the terminal must do some form of handshaking. If the terminal being used does not do hardware handshaking via the CTS line, then it must do XON/XOFF handshaking. If you get garbled messages and missing characters, you should check the terminal to make sure XON/XOFF handshaking is enabled. Refer to *Configuring a Port* under the **PF** (Port Format) command in the *Debugging Package for 88K RISC CPUs User's Manual*.

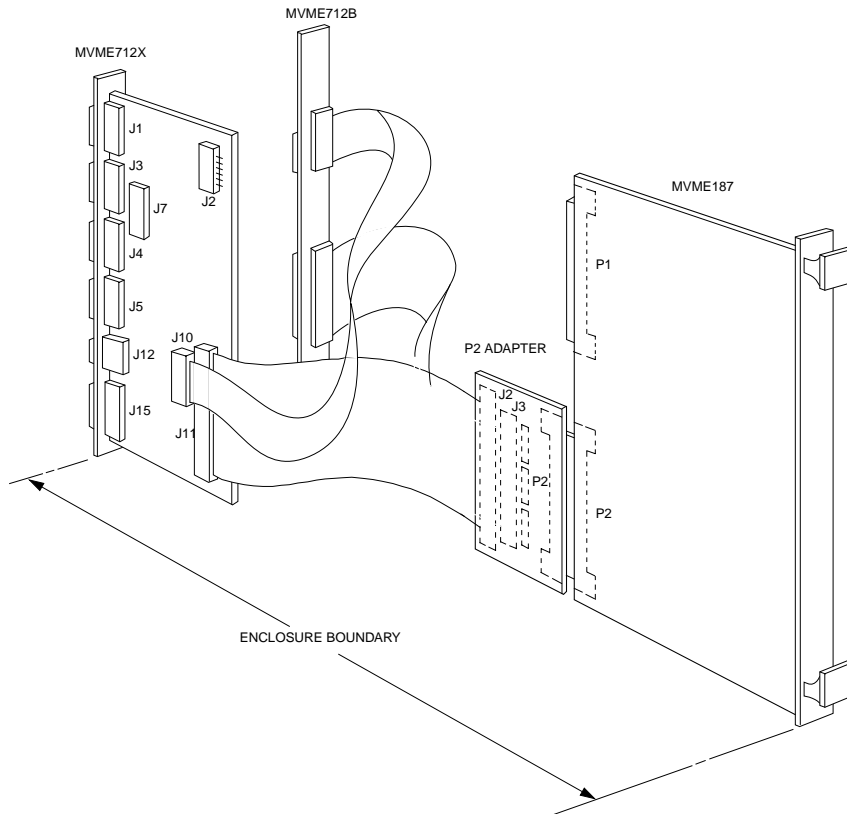

Figure 3-3. Using MVME712A/AM and MVME712B

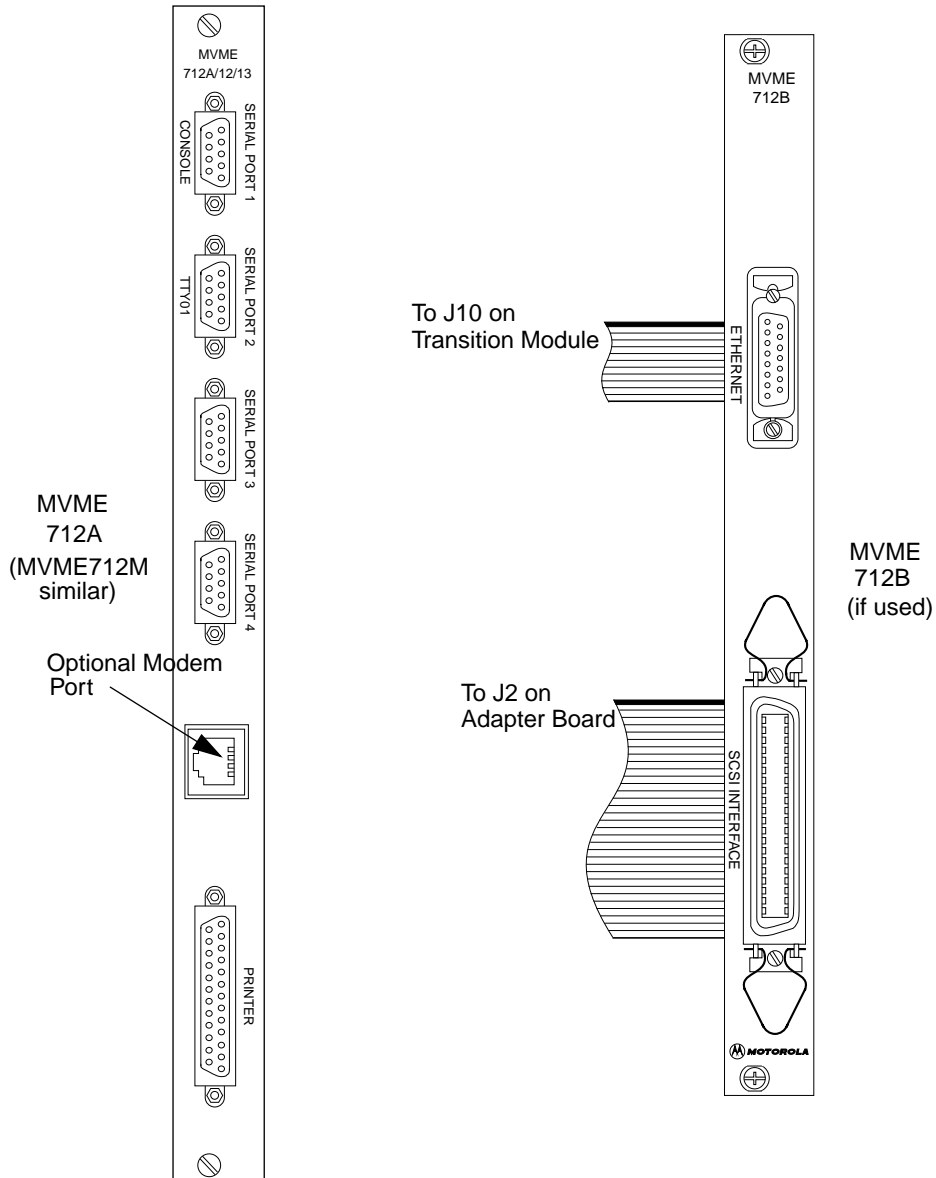

Figure 3-4. Typical Transition Module Peripheral Port Connectors

Completing the Installation

Table 3-13. Installation Completion Procedure

Step	Action...
1	Reassemble the chassis.
2	Reconnect the AC power.

Starting the System

After completing the preparation and installation procedures, you are ready to start up your system.

Table 3-14. System Startup Overview

Stage	What you will need to do...	Refer to...
1	Power up the system and note that the debugger prompt appears.	Page 3-25; <i>Starting Up 187Bug</i> on page 4-6; and the <i>MVME187Bug Debugging Package User's Manual</i> .
2	Initialize the real-time clock.	Page 3-25.
3	Examine and/or change environmental parameters.	Page 3-25 and <i>Configure and Environment Commands</i> on page A-1.
4	Program the PCCchip2 and VMEchip2.	<i>System Considerations</i> on page 3-27, <i>Memory Maps</i> on page 2-24, <i>ASICs</i> on page 2-8, and the <i>Single Board Computer Programmer's Reference Guide</i> .

Powering Up the System

The following table shows what takes place when you turn equipment power ON (depending on whether 187Bug is in Board Mode or in System Mode):

If 187Bug is in...		
Board Mode	187Bug executes some self-checks and displays the debugger prompt 187-Bug>	
System Mode	The system performs a selftest and tries to autoboot.	If the confidence test fails, the test aborts when the first fault occurs. If possible, an appropriate message is displayed, and control then returns to the menu (refer to Chapter 4, <i>Debugger General Information</i> , and Chapter 5, <i>Using the 187Bug Debugger</i> for ENV and MENU commands).

Initializing the Real-Time Clock

The onboard real-time clock (RTC) is backed up with a self-contained battery. Before shipment of this board, the clock of the RTC device was stopped to preserve battery life.

The board's "Selftests" (ST) and operating systems require the clock of the RTC to be operating. Table 3-15 shows the steps required to initialize the RTC, depending on the mode.

Examining and/or Changing Environmental Parameters

Use the 187Bug's ENV command to verify the NVRAM (BDRAM) parameters, and optionally use ENV to make changes to the Environmental parameters. Refer to Appendix A for the Environment parameters.

Table 3-15. RTC Initialization Procedure

Step	Action	
	Board Mode	System Mode
1	Allow 187Bug to boot up normally.	Stop the auto-boot sequence by pressing the <BREAK> key. (If the system has already started and failed a confidence test in system mode, you should be in the debugger menu).
2	At the 187-Bug> prompt, enter TIME to display the current date and time of day.	Select (3) from the debugger menu to get the debugger prompt.
3	At the 187-Bug> prompt, use the SET command to initialize the RTC and to set the time and date. Use the following command line structure: SET [<MMddyyhhmm>] [<+/-CAL>;C] For example: 187-Bug>SET 0522961037 <Return> WED May 22 10:37:00.00 1996 187-Bug> Where the arguments are: MM=month, dd=day of the month, yy=year, hh=hour in "military" (24 hour) time, and mm=minutes.	

Programming the PCCchip2 and VMEchip2

See *System Considerations* below, and refer to *Memory Maps* on page 2-24, and the *Single Board Computer Programmer's Reference Guide* for details of your particular system environment.

System Considerations

Backplane Power Connections

The MVME187 needs to draw power from both P1 and P2 of the VMEbus backplane. P2 is also used for the upper 16 bits of data for 32-bit transfers, and for the upper 8 address lines for extended addressing mode. The MVME187 may not operate properly without its main board connected to P1 and P2 of the VMEbus backplane.

Memory Address Ranges

Whether the MVME187 operates as a VMEbus master or as a VMEbus slave, it is configured for 32 bits of address and for 32 bits of data (A32/D32). However, it handles A16 or A24 devices in certain address ranges. D8 and/or D16 devices in the system must be handled by the MC88100 software. Refer to the memory maps in the *Single Board Computer Programmer's Reference Guide* as listed in *Related Documentation* in Chapter 1.

DRAM Addressing

The MVME187 contains shared onboard DRAM whose base address is software-selectable. Both the onboard processor and offboard VMEbus devices see this local DRAM at base physical address \$00000000, as programmed by the MVME187Bug firmware. This may be changed, by software, to any other base address. Refer to the *Single Board Computer Programmer's Reference Guide* for details.

Global Bus Timeout

If the MVME187 tries to access offboard resources in a non-existent location, and is not system controller, and if the system does not have a global bus timeout, the MVME187 waits forever for the VMEbus cycle to complete. This would cause the system to hang up.

Multiple Module Cage Configuration

Multiple MVME187s may be configured into a single VME card cage. In general, hardware multiprocessor features are supported.

GCSR Location Monitor Register

Other MPUs on the VMEbus can interrupt, disable, communicate with and determine the operational status of the RISC processor(s). One register of the GCSR set includes four bits which function as location monitors to allow one MVME187 processor to broadcast a signal to other MVME187 processors, if any. All eight GCSR registers are accessible from any local processor as well as from the VMEbus.

Ethernet LAN (+12 Vdc) Fuse

The MVME187 provides +12 Vdc power to the Ethernet LAN transceiver interface through a 1-amp fuse (F2) located on the MVME187. The +12V LED lights when +12 Vdc is available. The fuse is socketed and is located adjacent to diode CR1 near connector P1. If the Ethernet transceiver fails to operate, check the fuse. When using the MVME712M transition module, the yellow LED (DS1) on the MVME712M front panel lights when LAN power is available, indicating that the fuse is good.

SCSI Bus Termination

- ❑ The MVME187 provides SCSI terminator power through a 1-amp fuse (F1) located on the P2 adapter board. The fuse is socketed. If the fuse is blown, the SCSI devices may not operate or may function erratically.
- ❑ When the P2 adapter board is used with an MVME712M and the SCSI bus is connected to the MVME712M, the green LED (DS2) on the MVME712M front panel lights when there is SCSI terminator power. If the LED flickers during SCSI bus operation, the fuse should be checked.
- ❑ Because this board has no provision for SCSI termination, you must ensure that the SCSI bus is terminated properly. If you use a P2 Adapter, the adapter has sockets (R1, R2, R3) for terminating the SCSI lines using three 8-pin SIP resistor networks.

Storage and the Real-Time Clock

For storage of this product, be sure the RTC is put into the power save mode. This will extend the life of the battery contained in this part. To put the part into the power save mode, use the **PS** command of the debugger. For example:

```
187-Bug>ps <Return>  
(Clock is in Battery Save mode)  
187-Bug>
```

This Chapter Covers

- ❑ An introduction to the MVME187Bug firmware package
- ❑ Booting and restarting 187Bug
- ❑ Disk input/output support capabilities
- ❑ Network support capabilities

Introduction to MVME187Bug

This section covers:

- ❑ Overview of M88000 firmware
- ❑ Description of 187Bug
- ❑ Comparison with M68000-based firmware
- ❑ 187Bug implementation
- ❑ Memory requirements

Overview of M88000 Firmware

The firmware for the M88000-based (88K) series of board and system level products has a common genealogy, deriving from the BUG firmware currently used on all Motorola M68000-based CPU modules. The M88000 firmware family provides a high degree of functionality and user friendliness, and yet stresses portability and ease of maintenance. This member of the M88000 firmware family is implemented on the MVME187 RISC Single Board Computer, and is known as the MVME187Bug, or just 187Bug.

Description of 187Bug

The 187Bug package is a powerful evaluation and debugging tool for systems built around the MVME187 RISC-based microcomputers.

187Bug consists of three parts:

- ❑ The “debugger” or “187Bug”; a command-driven user-interactive software debugger, described in Chapter 5
- ❑ A command-driven diagnostic package for the MVME187 hardware
- ❑ A user interface which accepts commands from the system console terminal

Command Facilities

Facilities are available for loading and executing user programs under complete operator control for system evaluation.

187Bug includes commands for these tasks:

- ❑ Display and modification of memory
- ❑ Breakpoint and tracing capabilities
- ❑ A powerful assembler/ disassembler useful for patching programs
- ❑ A self-test at powerup feature which verifies the integrity of the system

Trap #496 Routines

Various 187Bug routines that handle I/O, data conversion, and string functions are available to user programs through the TRAP #496 handler. The TRAP #496 handler is accessible through any of the trap exception commands TB0, TB1, TBND, and TCND, with trap vector #496.

Debugger or Diagnostic Directories

When using 187Bug, you operate out of either the debugger directory or the diagnostic directory.

If you are in...	With the prompt...	You have available...
The debugger directory	187-Bug>	All of the debugger commands
The diagnostic directory	187-Diag>	All of the diagnostic commands as well as all of the debugger commands

You may switch between directories by using the Switch Directories (**SD**) command.

You may examine the commands in the current directory by using the Help (**HE**) command.

Keyboard Control

Because 187Bug is command-driven, it performs its various operations in response to user commands entered at the keyboard. When you enter a command, 187Bug executes the command and the prompt reappears. However, if you enter a command that causes execution of user target code (e.g., "**GO**"), then control may or may not return to 187Bug, depending on the outcome of the user program.

Comparison with M68000-Based Firmware

If you have used one or more of Motorola's other debugging packages, you will find the RISC 187Bug very similar, after making due allowances for the architectural differences between the M68000 and M88000 CPU architectures. These differences are primarily reflected as follows:

- ❑ Instruction mnemonics and addressing modes of the assembler/disassembler differ somewhat in 187Bug.
- ❑ 187Bug uses registers instead of the stack for the passing of arguments to or from the TRAP #496 handler.
- ❑ The interactive commands in 187Bug are more consistent. For example, delimiters between commands and arguments may now be commas or spaces interchangeably.

187Bug Implementation

MVME187Bug is written largely in the "C" programming language, providing benefits of portability and maintainability. Where necessary, assembler has been used in the form of separately compiled modules containing only assembler code; no mixed language modules are used.

Physically, 187Bug is contained in two of the four 44-pin PLCC/CLCC EPROMs, providing 512KB (128K words) of storage. Both EPROMs are necessary regardless of how much space is actually occupied by the firmware, because of the 32-bit word-oriented M88000 memory bus architecture.

The executable code is checksummed at every power-on or reset firmware entry, and the result (which includes a pre-calculated checksum contained in the EPROMs), is tested for an expected zero. Thus, users are cautioned against modification of the EPROMs unless re-checksum precautions are taken.

Memory Requirements

The program portion of 187Bug is approximately 512KB of code, consisting of download, debugger, and diagnostic packages and contained entirely in EPROM. The EPROM sockets on the MVME187 are mapped starting at location \$FF800000.

187Bug requires a minimum of 64KB of contiguous read/write memory to operate.

The **ENV** command controls where this block of memory is located. Regardless of where the onboard RAM is located, the first 64KB is used for 187Bug stack and static variable space and the rest is reserved as user space.

Whenever the MVME187 is reset, the target IP is initialized to the address corresponding to the beginning of the user space, and the target stack pointers are initialized to addresses within the user space, with the target Pseudo Stack Pointer (R31) set to the top of the user space.

At power up or reset, all 8KB of memory at addresses \$FFE0C000 through \$FFE0DFFF is completely changed by the 187Bug initial stack.

Booting and Restarting 187Bug

This section covers the following tasks:

- ❑ Starting up 187Bug
- ❑ Autoboot
- ❑ ROMboot
- ❑ Network boot
- ❑ Restarting the system

Starting Up 187Bug

1. Verify that the MVME187 is properly installed and operating as described in [Table 3-1 on page 3-2](#).
2. Power up the system. 187Bug executes some self-checks and displays the debugger prompt `187-Bug>` (if 187Bug is in Board Mode). However, if the **ENV** command (Appendix A) has put 187Bug in System Mode, the system performs a selftest and tries to autoboot. Refer to the **ENV** and **MENU** commands listed in [Table 5-1](#).

If the confidence test fails, the test is aborted when the first fault is encountered. If possible, an appropriate message is displayed, and control then returns to the menu.

Autoboot

Autoboot is a software routine that is contained in the 187Bug EPROMs to provide an independent mechanism for booting an operating system.

Autoboot Sequence

1. The autoboot routine automatically scans for controllers and devices in a specified sequence until a valid bootable device containing a boot media is found or the list is exhausted.
2. If a valid bootable device is found, a boot from that device is started.

The controller scanning sequence goes from the lowest controller Logical Unit Number (LUN) detected to the highest LUN detected. (Controllers, devices, and their LUNs are listed in Appendix B).

3. At powerup, Autoboot is enabled, and if the drive and controller numbers encountered are valid, the system console displays the following message:

```
"Autoboot in progress... To abort hit <BREAK>"
```

4. Following this message there is a delay to allow you an opportunity to abort the Autoboot process if you wish. To gain control without Autoboot, you can press the **BREAK** key or the software **ABORT** or **RESET** switches.
5. Then the actual I/O begins: the program pointed to within the volume ID of the media specified is loaded into RAM and control passed to it.

Autoboot is controlled by parameters contained in the **ENV** command. These parameters allow the selection of specific boot devices and files, and allow programming of the Boot delay. Refer to the **ENV** command in Appendix A for more details.

ROMboot

There are two spare EPROM sockets, XU3 and XU4, available to carry user-programmed EPROMs. Therefore, you do not have to reprogram the 187Bug EPROMs in order to implement the ROMboot feature.

One use of ROMboot might be resetting **SYSFAIL*** on an unintelligent controller module. The **NORB** command disables the function.

ROMboot Sequence

1. ROMboot is configured/enabled and executed at powerup (optionally also at reset) in one of two ways:
 - a. By the Environment (**ENV**) command (refer to Appendix A)
 - b. By the **RB** command assuming there is valid code in the EPROMs (or optionally elsewhere on the module or VMEbus) to support it.
2. If ROMboot code is installed, a user-written routine is given control (if the routine meets the format requirements).

For a user's ROMboot module to gain control through the ROMboot linkage, four requirements must be met:

Requirement...	Optionally, with the ENV command...
Power must have just been applied.	Change this to respond to any reset.
Your routine must be located within the MVME187 ROM memory map.	Change this to any other portion of the onboard memory, or even offboard VMEbus memory.
The ASCII string "BOOT" must be located within the specified memory range.	
Your routine must pass a checksum test, which ensures that this routine was really intended to receive control at powerup.	

For complete details on how to use ROMboot, refer to the *Debugging Package for Motorola 88K RISC CPUs User's Manual*.

Network Boot

Network Auto Boot is a software routine contained in the 187Bug EPROMs that provides a mechanism for booting an operating system using a network (local Ethernet interface) as the boot device.

Network Boot Sequence

1. The Network Auto Boot routine automatically scans for controllers and devices in a specified sequence until a valid bootable device containing a boot media is found or the list is exhausted.
2. If a valid bootable device is found, a boot from that device is started.

The controller scanning sequence goes from the lowest controller Logical Unit Number (LUN) detected to the highest LUN detected. (Refer to Appendix C for default LUNs.)

3. At powerup, Network Boot is enabled, and providing the drive and controller numbers encountered are valid, the following message is displayed on the system console:

```
"Network Boot in progress... To abort hit <BREAK>"
```

Following this message there is a delay to allow you to abort the Network Boot process if you wish. To gain control without Network Boot, you can press the BREAK key or the software ABORT or RESET switches.
4. Then the actual I/O begins: the program pointed to within the volume ID of the media specified is loaded into RAM and control passed to it.

Network Auto Boot is controlled by parameters contained in the **NIOT** and **ENV** commands. These parameters allow the selection of specific boot devices, systems, and files, and allow programming of the Boot delay. Refer to the **ENV** command in Appendix A.

Restarting the System

You can initialize the system to a known state in three different ways: reset, abort, and break. Each has characteristics which make it more appropriate than the others in certain situations.

The debugger has a special feature which can be used in the event your setup/operation parameters are corrupted or do not meet a sanity check. This feature:

- ❑ Is activated by pressing the RESET and ABORT switches at the same time, and releasing the RESET switch before the ABORT switch.
- ❑ Instructs 187Bug to use the default setup/operation parameters in ROM instead of your setup/operation parameters in NVRAM.

Refer to the **ENV** command (Appendix A) for the ROM defaults.

Reset

Pressing and releasing the MVME187 front panel RESET switch initiates a system reset.

Reset must be used if the processor ever halts, or if the 187Bug environment is ever lost (vector table is destroyed, stack corrupted, etc.).

- ❑ COLD and WARM reset modes are available.
- ❑ By default, 187Bug is in COLD mode.

During COLD reset:

1. A total system initialization takes place, as if the MVME187 had just been powered up.
2. All static variables (including disk device and controller parameters) are restored to their default states.
3. The breakpoint table and offset registers are cleared.
4. The target registers are invalidated.
5. Input and output character queues are cleared.
6. Onboard devices (timer, serial ports, etc.) are reset, and
7. The *first* two serial ports are reconfigured to their default state.

During WARM reset:

1. The 187Bug variables and tables are preserved, as well as the target state registers and breakpoints.

Abort

Abort is invoked by pressing and releasing the ABORT switch on the MVME187 front panel.

Abort should be used to regain control if the program gets caught in a loop, etc.

Whenever abort is invoked while running target code (a user program), a “snapshot” of the processor state is captured and stored in the target registers. For this reason, abort is most appropriate when terminating a user program that is being debugged. The target IP, register contents, etc., help to pinpoint the malfunction.

Abort Sequence

Pressing and releasing the ABORT switch does the following:

1. Generates a local board condition which may interrupt the processor if enabled.
2. Displays the target registers on the screen, reflecting the machine state at the time the ABORT switch was pressed.
3. Removes any breakpoints installed in the user code and keeps the breakpoint table intact.
4. Returns control to the debugger.

Break

A “Break” is generated by pressing and releasing the BREAK key on the console terminal keyboard.

- ❑ Break does not generate an interrupt.
- ❑ The only time break is recognized is when characters are sent or received by the console port.

Many times it may be desirable to terminate a debugger command prior to its completion; for example, during the display of a large block of memory. Break allows you to terminate the command.

Break Sequence

1. Removes any breakpoints in your code and keeps the breakpoint table intact.
2. Takes a snapshot of the machine state if the function was entered using SYSCALL. This machine state is then accessible to you for diagnostic purposes.

SYSFAIL* Assertion/Negation

Upon a reset/powerup condition the debugger asserts the VMEbus SYSFAIL* line (refer to the VMEbus specification). SYSFAIL* stays asserted if any of the following has occurred:

- ❑ Confidence test failure
- ❑ NVRAM checksum error
- ❑ NVRAM low battery condition
- ❑ Local memory configuration status
- ❑ Self test (if System Mode) has completed with error
- ❑ MPU clock speed calculation failure

After debugger initialization is done and none of the above situations have occurred, the SYSFAIL* line is negated. This indicates to the user or VMEbus masters the state of the debugger. In a multi-computer configuration, other VMEbus masters could view the pertinent control and status registers to determine which CPU is asserting SYSFAIL*. SYSFAIL* assertion/negation is also affected by the ENV command. Refer to Appendix A.

MPU Clock Speed Calculation

The clock speed of the microprocessor is calculated and checked against a user definable parameter contained in NVRAM (refer to the CNFG command in Appendix A). If the check fails, a warning message is displayed.

Disk I/O Support

187Bug can initiate disk input/output by communicating with intelligent disk controller modules over the VMEbus.

This section covers:

- ❑ Blocks Versus Sectors
- ❑ Device Probe Function
- ❑ Disk I/O via 187Bug Commands
- ❑ Disk I/O via 187Bug System Calls
- ❑ Default 187Bug Controller and Device Parameters
- ❑ Disk I/O Error Codes

Disk Support Facilities

Disk support facilities built into 187Bug consist of the following:

- ❑ Command-level disk operations
- ❑ Disk I/O system calls (only via one of the TRAP #496 instructions) for use by user programs
- ❑ Defined data structures for disk parameters

Parameter Tables

Parameters such as the address where the module is mapped and the type and number of devices attached to the controller module are kept in tables by 187Bug. Default values for these parameters are assigned at powerup and cold-start reset, but may be altered as described in the section on default parameters, later in this chapter.

Supported Controllers

Appendix B contains a list of the controllers presently supported, as well as a list of the default configurations for each controller.

Blocks Versus Sectors

The logical block defines the unit of information for disk devices. A disk is viewed by 187Bug as a storage area divided into logical blocks. By default, the logical block size is set to 256 bytes for every block device in the system. The block size can be changed on a per device basis with the **IOT** command.

The sector defines the unit of information for the media itself, as viewed by the controller. The sector size varies for different controllers, and the value for a specific device can be displayed and changed with the **IOT** command.

When a disk transfer is requested, the start and size of the transfer is specified in blocks. 187Bug translates this into an equivalent sector specification, which is then passed on to the controller to initiate the transfer. If the conversion from blocks to sectors yields a fractional sector count, an error is returned and no data is transferred.

Device Probe Function

A device probe with entry into the device descriptor table is done whenever a specified device is accessed; i.e., when system calls **.DSKRD**, **.DSKWR**, **.DSKCFIG**, **.DSKFMT**, and **.DSKCTRL**, and debugger commands **BH**, **BO**, **IOC**, **IOP**, **IOT**, **MAR**, and **MAW** are used.

The device probe mechanism utilizes the SCSI commands "Inquiry" and "Mode Sense". If the specified controller is non-SCSI, the probe simply returns a status of "device present and unknown". The device probe makes an entry into the device descriptor table with the pertinent data. After an entry has been made, the next time a probe is done it simply returns with "device present" status (pointer to the device descriptor).

Disk I/O via 187Bug Commands

These following 187Bug commands are provided for disk I/O. Detailed instructions for their use are found in the *Debugging Package for Motorola 88K RISC CPUs User's Manual*. When a command is issued to a particular controller LUN and device LUN, these LUNs are remembered by 187Bug so that the next disk command defaults to use the same controller and device.

IOI (Input/Output Inquiry)

This command is used to probe the system for all possible CLUN/DLUN combinations and display inquiry data for devices which support it. The device descriptor table only has space for 16 device descriptors; with the **IOI** command, you can view the table and clear it if necessary.

IOP (Physical I/O to Disk)

IOP allows you to read or write blocks of data, or to format the specified device in a certain way. **IOP** creates a command packet from the arguments you have specified, and then invokes the proper system call function to carry out the operation.

IOT (I/O Teach)

IOT allows you to change any configurable parameters and attributes of the device. In addition, it allows you to see the controllers available in the system.

IOC (I/O Control)

IOC allows you to send command packets as defined by the particular controller directly. **IOC** can also be used to look at the resultant device packet after using the **IOP** command.

BO (Bootstrap Operating System)

BO reads an operating system or control program from the specified device into memory, and then transfers control to it.

BH (Bootstrap and Halt)

BH reads an operating system or control program from a specified device into memory, and then returns control to 187Bug. It is used as a debugging tool.

4

Disk I/O via 187Bug System Calls

All operations that actually access the disk are done directly or indirectly by 187Bug TRAP #496 system calls. (The command-level disk operations provide a convenient way of using these system calls without writing and executing a program.)

The following system calls are provided to allow user programs to do disk I/O:

.DSKRD	Disk read. System call to read blocks from a disk into memory.
.DSKWR	Disk write. System call to write blocks from memory onto a disk.
.DSKCFG	Disk configure. This function allows you to change the configuration of the specified device.
.DSKFMT	Disk format. This function allows you to send a format command to the specified device.
.DSKCTRL	Disk control. This function is used to implement any special device control functions that cannot be accommodated easily with any of the other disk functions.

Refer to the *Debugging Package for Motorola 88K RISC CPUs User's Manual* for information on using these and other system calls.

Controller Command Packets

To perform a disk operation, 187Bug must eventually present a particular disk controller module with a controller command packet which has been especially prepared for that type of controller module. (This is accomplished in the respective controller driver module.)

A command packet for one type of controller module usually does not have the same format as a command packet for a different type of module. The system call facilities which do disk I/O accept a generalized (controller-independent) packet format as an argument, and translate it into a controller-specific packet, which is then sent to the specified device.

Refer to the system call descriptions in the *Debugging Package for Motorola 88K RISC CPUs User's Manual* for details on the format and construction of these standardized "user" packets.

The packets which a controller module expects to be given vary from controller to controller. The disk driver module for the particular hardware module (board) must take the standardized packet given to a trap function and create a new packet which is specifically tailored for the disk drive controller it is sent to. Refer to documentation on the particular controller module for the format of its packets, and for using the **IOC** command.

Default 187Bug Controller and Device Parameters

187Bug initializes the parameter tables for a default configuration of controllers and devices (refer to Appendix B). If the system needs to be configured differently than this default configuration (for example, to use a 70MB Winchester drive where the default is a 40MB Winchester drive), then these tables must be changed.

There are three ways to change the parameter tables:

Using...	When you invoke one of these commands...	Change status is...	If a cold-start reset occurs...
Command BO or BH	The configuration area of the disk is read and the parameters corresponding to that device are rewritten according to the parameter information contained in the configuration area.	Temporary	The default parameter information is written back into the tables.
Command IOT	You can use this command to reconfigure the parameter table manually for any controller and/or device that is different from the default.	Temporary	The default parameter information is written back into the tables.
The source code	In the source code, you may change the permanent configuration files and rebuild 187Bug so that it has different defaults.	Permanent until changed again.	

Disk I/O Error Codes

187Bug returns an error code if an attempted disk operation is unsuccessful.

Network I/O Support

The Network Boot Firmware provides the capability to boot the CPU through the ROM debugger using a network (local Ethernet interface) as the boot device.

The booting process is executed in two distinct phases.

- ❑ The first phase allows the diskless remote node to discover its network identify and the name of the file to be booted.
- ❑ The second phase has the diskless remote node reading the boot file across the network into its memory.

The various modules and the dependencies of these modules that support the overall network boot function are described in the following paragraphs.

Intel 82596 LAN Coprocessor Ethernet Driver

This driver manages/surrounds the Intel 82596 LAN Coprocessor. Management is in the scope of the reception of packets, the transmission of packets, receive buffer flushing, and interface initialization.

This module ensures that the packaging and unpackaging of Ethernet packets is done correctly in the Boot PROM.

UDP/IP Protocol Modules

The Internet Protocol (IP) is designed for use in interconnected systems of packet-switched computer communication networks. The Internet Protocol provides for transmitting of blocks of data called datagrams (hence User Datagram Protocol, or UDP) from sources to destinations, where sources and destinations are hosts identified by fixed length addresses.

The UDP/IP protocols are necessary for the TFTP and BOOTP protocols; TFTP and BOOTP require a UDP/IP connection.

RARP/ARP Protocol Modules

The Reverse Address Resolution Protocol (RARP) basically consists of an identity-less node broadcasting a "whoami" packet onto the Ethernet, and waiting for an answer. The RARP server fills an Ethernet reply packet up with the target's Internet Address and sends it.

The Address Resolution Protocol (ARP) basically provides a method of converting protocol addresses (e.g., IP addresses) to local area network addresses (e.g., Ethernet addresses). The RARP protocol module supports systems which do not support the BOOTP protocol.

BOOTP Protocol Module

The Bootstrap Protocol (BOOTP) basically allows a diskless client machine to discover its own IP address, the address of a server host, and the name of a file to be loaded into memory and executed.

TFTP Protocol Module

The Trivial File Transfer Protocol (TFTP) is a simple protocol to transfer files. It is implemented on top of the Internet User Datagram Protocol (UDP or Datagram) so it may be used to move files between machines on different networks implementing UDP. The only thing it can do is read and write files from/to a remote server.

Network Boot Control Module

The "control" capability of the Network Boot Control Module is needed to tie together all the necessary modules and to sequence the booting process. The booting sequence consists of two phases: the first phase is labeled "address determination and bootfile selection" and the second phase is labeled "file transfer". The first phase will utilize the RARP/BOOTP capability and the second phase will utilize the TFTP capability.

Network I/O Error Codes

187Bug returns an error code if an attempted network operation is unsuccessful.

Multiprocessor Support

The MVME187 dual-port RAM feature makes the shared RAM available to remote processors as well as to the local processor. This can be done by either of the following two methods:

- ❑ The Multiprocessor Control Register (MPCR) Method
- ❑ The Global Control and Status Register (GCSR) Method

Either method can be enabled/disabled by the **ENV** command as its Remote Start Switch Method (refer to Appendix A).

Multiprocessor Control Register (MPCR) Method

A remote processor can initiate program execution in the local MVME187 dual-port RAM by issuing a remote **GO** command using the Multiprocessor Control Register (MPCR).

The MPCR, located at shared RAM location of \$3000 offset from the base address the debugger loads it at, contains one of two words used to control communication between processors. The MPCR contents are organized as follows:

Base Address + \$3000

*	N/A	N/A	N/A
---	-----	-----	-----

 (MPCR)

MPCR Status Codes

The status codes stored in the MPCR are of two types:

- ❑ Status returned (from 187Bug)
- ❑ Command set by the bus master (job requested by some processor)

The status codes that may be returned from 187Bug are:

HEX	0	(HEX 00)	--	Wait. Initialization not yet complete.
ASCII	R	(HEX 52)	--	Ready. The firmware monitor is watching for a change.
ASCII	E	(HEX 45)	--	Code pointed to by the MPAR is executing.

The command code that may be **set** by the bus master is:

ASCII	G	(HEX 47)	--	Use Go Direct (GD) logic specifying the MPAR address.
ASCII	B	(HEX 42)	--	Recognize breakpoints using the Go (G) logic.

Multiprocessor Address Register (MPAR)

The Multiprocessor Address Register (MPAR), located in shared RAM location of \$3004 offset from the base address the debugger loads it at, contains the second of two words used to control communication between processors. The MPAR contents specify the physical address (as viewed from the local processor) at which execution for this processor is to begin if the MPCR contains a G or B. The MPAR is organized as follows:

Base Address + \$3004

*	*	*	*
---	---	---	---

 (MPAR)

MPCR Powerup Sequence

1. At powerup, the debug monitor self-test routines initialize RAM, including the memory locations used for multi-processor support (\$3000 through \$3007).
2. The MPCR contains \$00 at powerup, indicating that initialization is not yet complete.

3. As the initialization proceeds, the execution path comes to the "prompt" routine.

Before sending the prompt, this routine places an R in the MPCR to indicate that initialization is complete. Then the prompt is sent.

- If no terminal is connected to the port, the MPCR is still polled to see whether an external processor requires control to be passed to the dual-port RAM.
- If a terminal does respond, the MPCR is polled for the same purpose while the serial port is being polled for user input.
- An **ASCII G** placed in the MPCR by a remote processor indicates that the Go Direct type of transfer is requested.
- An **ASCII B** in the MPCR indicates that breakpoints are to be armed before control is transferred (as with the **GO** command).

In either sequence, an E is placed in the MPCR to indicate that execution is underway just before control is passed to RAM. (Any remote processor could examine the MPCR contents.)

4. If the code being executed in dual-port RAM is to reenter the debug monitor, a TRAP #496 call using function \$0063 (SYSCALL .RETURN) returns control to the monitor with a new display prompt.

Note that every time the debug monitor returns to the prompt, an R is moved into the MPCR to indicate that control can be transferred once again to a specified RAM location.

Global Control and Status Register (GCSR) Method

A remote processor can initiate program execution in the local MVME187 dual-port RAM by issuing a remote **GO** command using the VMEchip2 Global Control and Status Registers (GCSR).

1. The remote processor places the MVME187 execution address in general purpose registers 0 and 1 (GPCSR0 and GPCSR1).
2. The remote processor then sets bit 8 (SIG0) of the VMEchip2 LM/SIG register.
3. This causes the MVME187 to install breakpoints and begin execution. The result is identical to the MPCR method (with status code B) described in the previous section.

The GCSR registers are accessed in the VMEbus short I/O space. Each general purpose register is two bytes wide, occurring at an even address.

The general purpose register number 0 is at an offset of \$8 (local bus) or \$4 (VMEbus) from the start of the GCSR registers. The local bus base address for the GCSR is \$FFF40100. The VMEbus base address for the GCSR depends on the group select value and the board select value programmed in the Local Control and Status Registers (LCSR) of the MVME187. The execution address is formed by reading the GCSR general purpose registers in the following manner:

GPCSR0 used as the upper 16 bits of the address
 GPCSR1 used as the lower 16 bits of the address

The address appears as:

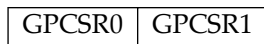

Diagnostic Facilities

Included in the 187Bug package is a complete set of hardware diagnostics intended for testing and troubleshooting of the MVME187. These diagnostics are completely described in the *MVME187Bug Debugging Package User's Manual*.

- ❑ In order to use the diagnostics, you must switch directories to the diagnostic directory.
- ❑ If you are in the debugger directory, you can switch to the diagnostic directory by entering the debugger command Switch Directories (**SD**). The diagnostic prompt

```
187-Diag>
```

should appear.

Table 4-1. Diagnostic Monitor Commands/Prefixes

Command/ Prefix	Description
AEM	Append Error Messages Mode
CEM	Clear Error Messages
CF	Test Group Configuration Parameters Editor
DE	Display Errors
DEM	Display Error Messages
DP	Display Pass Count
HE	Help
HEX	Help Extended
LA	Loop Always Mode
LC	Loop Continuous Mode
LE	Loop on Error Mode
LF	Line Feed Suppression Mode
LN	Loop Non-Verbose Mode
MASK	Display / Revise Self Test Mask

Table 4-1. Diagnostic Monitor Commands/Prefixes

Command/ Prefix	Description
NV	Non-Verbose Mode
SD	Switch Directories
SE	Stop on Error Mode
ST	Selftest
ZE	Clear (Zero) Error Counters
ZP	Zero Pass Count

Table 4-2. Diagnostic Utilities

Command	Description
WL	Write loop enable
RL	Read loop enable

187Bug Diagnostic Test Groups

Refer to the *MVME187Bug Debugging Package User's Manual* for complete descriptions of the diagnostic routines available and instructions on how to invoke them. Note that some diagnostics depend on restart defaults that are set up only in a particular restart mode. Refer to the documentation on a particular diagnostic for the correct mode.

Table 4-3. Diagnostic Test Groups

Test Set	Description
RAM	Local RAM Tests
SRAM	Static RAM Tests
RTC	MK48T0x Real-Time Clock Tests
PCC2	Peripheral Channel Controller Tests
MCECC	Memory Board Tests
MEMC1	MC040 Memory Controller 1 ASIC Tests
MEMC2	MC040 Memory Controller 2 ASIC Tests
ST2401	CD2401 Serial Port Tests
CMMU	Memory Management Unit Tests
VME2	VME Interface ASIC VMEchip2 Tests
LAN	LAN Coprocessor (Intel 82596) Tests
NCR	NCR 53C710 SCSI I/O Processor Tests

This Chapter Covers

- ❑ Entering debugger command lines
- ❑ Entering and debugging programs
- ❑ Calling system utilities from user programs
- ❑ Preserving the debugger operating environment
- ❑ Floating point support
- ❑ The 187Bug debugger command set

Entering Debugger Command Lines

187Bug is command-driven and performs its various operations in response to user commands entered at the keyboard. When the debugger prompt

```
187-Bug>
```

appears on the terminal screen, then the debugger is ready to accept commands.

Terminal Input/Output Control

As the command line is entered, it is stored in an internal buffer. Execution begins only after the carriage return is entered, so that you can correct entry errors, if necessary, using the control characters described below.

Note The presence of the upward caret (^) before a character indicates that the Control (CTRL) key must be held down while striking the character key.

^X	(cancel line)	The cursor is backspaced to the beginning of the line.
^H	(backspace)	The cursor is moved back one position.
Delete key	(delete)	Performs the same function as ^H.
^D	(redisplay)	The entire command line as entered so far is redisplayed on the following line.
^A	(repeat)	Repeats the previous line. This happens only at the command line. The last line entered is redisplayed but not executed. The cursor is positioned at the end of the line. You may enter the line as is or you can add more characters to it. You can edit the line by backspacing and typing over old characters.

When observing output from any 167Bug command, the XON and XOFF characters which are in effect for the terminal port may be entered to control the output, if the XON/XOFF protocol is enabled (default). These characters are initialized to ^S and ^Q respectively by 167Bug, but you may change them with the PF command. In the initialized (default) mode, operation is as follows:

^S	(wait)	Console output is halted.
^Q	(resume)	Console output is resumed.

When a command is entered, the debugger executes the command and the prompt reappears. However, if the command entered causes execution of user target code, for example **GO**, then control may or may not return to the debugger, depending on what the user program does.

For example, if a breakpoint has been specified, then control returns to the debugger when the breakpoint is encountered during execution of the user program. Alternately, the user program could return to the debugger by means of the TRAP #496 function

“.RETURN”.

Debugger Command Syntax

In general, a debugger command is made up of the following parts:

- ❑ The command identifier (i.e., **MD** or **md** for the Memory Display command). Note that either upper- or lowercase is allowed.
- ❑ A port number if the command is set up to work with more than one port.
- ❑ At least one intervening space before the first argument.
- ❑ Any required arguments, as specified by the command.
- ❑ An option field, set off by a semicolon (;) to specify conditions other than the default conditions of the command.

The commands are shown using a modified Backus-Naur form syntax. The metasymbols used are:

boldface strings	A boldface string is a literal such as a command or a program name, and is to be typed just as it appears.
<i>italic strings</i>	An italic string is a “syntactic variable” and is to be replaced by one of a class of items it represents.
	A vertical bar separating two or more items indicates that a choice is to be made; only one of the items separated by this symbol should be selected.
[]	Square brackets enclose an item that is optional. The item may appear zero or one time.
{ }	Braces enclose an optional symbol that may occur zero or more times.

Syntactic Variables

The syntactic variables shown below are encountered in the command descriptions on the following pages. In addition, other syntactic variables may be used and are defined in the particular command description in which they occur.

<i>del</i>	Delimiter; either a comma or a space.
<i>exp</i>	Expression (described in detail in a following section).
<i>addr</i>	Address (described in detail in a following section).
<i>count</i>	Count; the syntax is the same as for <i>exp</i> .
<i>range</i>	A range of memory addresses which may be specified either by <i>addr del addr</i> or by <i>addr: count</i> .
<i>text</i>	An ASCII string of up to 255 characters, delimited at each end by the single quote mark (').

5

Expression as a Parameter

An expression can be one or more numeric values separated by the arithmetic operators: plus (+), minus (-), multiplied by (*), divided by (/), logical AND (&), shift left (<<), or shift right (>>).

Numeric values may be expressed in either hexadecimal, decimal, octal, or binary by immediately preceding them with the proper base identifier.

Base	Identifier	Examples
Hexadecimal	\$	\$FFFFFFFF
Decimal	&	&1974, &10-&4
Octal	@	@456
Binary	%	%1000110

If no base identifier is specified, then the numeric value is assumed to be hexadecimal.

A numeric value may also be expressed as a string literal of up to four characters. The string literal must begin and end with the single quote mark ('). The numeric value is interpreted as the concatenation of the ASCII values of the characters. This value is right-justified, as any other numeric value would be.

String Literal	Numeric Value (In Hexadecimal)
'A'	41
'ABC'	414243
'TEST'	54455354

Evaluation of an expression is always from left to right unless parentheses are used to group part of the expression. There is no operator precedence. Subexpressions within parentheses are evaluated first. Nested parenthetical subexpressions are evaluated from the inside out.

Valid expression examples:

Expression	Result (In Hex)	Notes
FF0011	FF0011	
45+99	DE	
&45+&99	90	
@35+@67+@10	5C	
%10011110+%1001	A7	
88<<4	880	shift left
AA&F0	A0	logical AND

The total value of the expression must be between 0 and \$FFFFFFFF.

Address as a Parameter

Many commands use *addr* as a parameter. The syntax accepted by 187Bug is similar to the one accepted by the M88000 one-line assembler. All control addressing modes are allowed. An “address + offset register” mode is also provided.

Address Formats

Addresses are entered as a hexadecimal number, e.g., 20000 would correspond to address \$00020000. The address, or starting address of a range, can be qualified by a suffix of the form **^S**, **^s**, **^U**, or **^u** where **S** or **s** defines Supervisor address space, and **U** or **u** defines user address space. The default, when the qualifier is not specified, is Supervisor.

5

Once a qualifier has been entered, it remains valid for all addresses entered for that command sequence, until the 187Bug is reentered or another qualifier is provided.

An alternate form of Address is **Rnn**, which tells the bug to use the address contained in CPU Register *Rnn*, where *nn*=00 thru 31 (i.e., 00, 01,..., or 31).

Hence *addr:= Hex Number*{**[^S]** | **[^s]** | **[^U]** | **[^u]**} | **Rnn**

Note In commands with *range* specified as *addr del addr*, and with size option H or W chosen, data at the second (ending) address is acted on only if the second address is a proper boundary for a half-word or word, respectively. Otherwise, the range is truncated so that the last byte acted upon is at an address that is a proper boundary.

Offset Registers

Eight pseudo-registers (Z0 through Z7) called offset registers are used to simplify the debugging of relocatable and position-independent modules. The listing files in these types of programs usually start at an address (normally 0) that is not the one at which they are loaded, so it is harder to correlate addresses in the listing with addresses in the loaded program. The offset registers solve this problem by taking into account this difference and forcing the display of addresses in a relative address+offset format. Offset registers have adjustable ranges and may even have overlapping ranges. The range for each offset register is set by two addresses: base and top. Specifying the base and top addresses for an offset register sets its range. In the event that an address falls in two or more offset registers' ranges, the one that yields the least offset is chosen.

Note Relative addresses are limited to 1MB (5 digits), regardless of the range of the closest offset register.

Port Numbers

Some 187Bug commands give the user the option to choose the port to be used to input or output. Valid port numbers which may be used for these commands are:

1. MVME187 EIA-232-D Debug (Terminal Port 0 or 00) (PORT 1 on the MVME187 P2 connector). Sometimes known as the "console port", it is used for interactive user input/output by default.
2. MVME187 EIA-232-D (Terminal Port 1 or 01) (PORT 2 on the MVME187 P2 connector). Sometimes known as the "host port", this is the default for downloading, uploading, concurrent mode, and transparent modes.

Note These logical port numbers (0 and 1) are shown in the pinouts of the MVME187 as "SERIAL PORT 1" and "SERIAL PORT 2", respectively. Physically, they are all part of connector P2.

Entering and Debugging Programs

5

There are various ways to enter a user program into system memory for execution:

- ❑ Create the program with the assembler/disassembler
- ❑ Download an S-record object file
- ❑ Read the program from disk

Creating a Program with the Assembler/Disassembler

You can create a program using the Memory Modify (MM) command with the assembler/disassembler option.

1. Enter the program one source line at a time.
2. After each source line is entered, it is assembled and the object code is loaded to memory.

Refer to the *Debugging Package for Motorola 88K RISC CPUs User's Manual* for complete details of the 187Bug Assembler/Disassembler.

Downloading an S-Record Object File

Another way to enter a program is to download an object file from a host system.

The program must be in S-record format (described in the *Debugging Package for Motorola 88K RISC CPUs User's Manual*) and may have been assembled or compiled on the host system.

Alternately, the program may have been previously created using the 187Bug **MM** command as outlined above and stored to the host using the Dump (**DU**) command.

A communication link must exist between the host system and the MVME187 port 1. (Hardware configuration details are provided in *Connecting Peripherals* on page 3-20.) The file is downloaded from the host to MVME187 memory by the Load (**LO**) command.

Read the Program from Disk

5

Another way to enter a program is by reading the program from disk, using one of the disk commands (**BO**, **BH**, **IOP**). Once the object code has been loaded into memory, you can set breakpoints if desired and run the code or trace through it.

Calling System Utilities from User Programs

A convenient way of doing character input/output and many other useful operations has been provided so that you do not have to write these routines into the target code. You can access various 187Bug routines via one of the MC88100 TRAP instructions, using vector #496. Refer to the *Debugging Package for Motorola 88K RISC CPUs User's Manual* for details on the various TRAP #496 utilities available and how to invoke them from within a user program.

Preserving the Debugger Operating Environment

This section explains how to avoid contaminating the operating environment of the debugger. Topics covered include:

- ❑ 187Bug Vector Table and workspace
- ❑ Hardware functions
- ❑ Exception vectors used by 187Bug
- ❑ CPU/MPU registers

187Bug uses certain of the MVME187 onboard resources and may also use offboard system memory to contain temporary variables, exception vectors, etc. If you disturb resources upon which 187Bug depends, then the debugger may function unreliably or not at all.

If your application enables translation through the Memory Management Units (MMUs), and utilizes resources of the debugger (e.g., system calls), your application must create the necessary translation tables for the debugger to have access to its various resources. The debugger honors the enabling of the MMUs; it does not disable translation.

187Bug Vector Table and Workspace

The debugger and diagnostic firmware resides in the EPROMs. The first 64KB of RAM are also used by the debugger for storage of the Vector Table, executable code, variables, and stack.

Hardware Functions

The only hardware resources used by the debugger are the EIA-232-D ports, which are initialized to interface to the debug terminal and a host. If these ports are reprogrammed, the terminal characteristics must be modified to suit, or the ports should be restored to the debugger-set characteristics prior to reinvoking the debugger.

Note Although the 187Bug does not explicitly manage the MC88200 or MC88204 CMMUs, hardware prevents caching of I/O space on the MVME187, i.e., \$FFFXXXX. Furthermore, the code cache must not be operative for code pages which are being traced or breakpointed.

Exception Vectors Used by 187Bug

The top 16 MC88100 exception vectors (i.e., #496 to 511 inclusive) are reserved for use by the debugger.

CPU/MPU Registers

MPU register CR20 is reserved for usage by the debugger. If CR20 is to be used by the user program, it must be restored prior to utilizing debugger resources (system calls).

Floating Point Support

The floating point Special Function Unit (SFU) of the MC88100 microprocessor chip is supported in 187Bug. For MVME187BUG, the commands **MD**, **MM**, **RM**, and **RS** have been extended to allow display and modification of floating point data in registers and in memory. Floating point instructions can be assembled and disassembled with the **DI** option of the **MD** and **MM** commands.

Valid data types that can be used when modifying a floating point data register or a floating point memory location:

Integer Data Types

12	Byte
1234	Half-Word
12345678	Word

Floating Point Data Types

1_FF_7FFFFFFF	Single Precision Real Format
1_7FF_FFFFFFFFFFFFFF	Double Precision Real Format
-3.12345678901234501_E+123	Scientific Notation Format (decimal)

When entering data in single or double precision format, the following rules must be observed:

1. The sign field is the first field and is a binary field.
2. The exponent field is the second field and is a hexadecimal field.
3. The mantissa field is the last field and is a hexadecimal field.
4. The sign field, the exponent field, and at least the first digit of the mantissa field must be present (any unspecified digits in the mantissa field are set to zero).
5. Each field must be separated from adjacent fields by an underscore.
6. All the digit positions in the sign and exponent fields must be present.

Single Precision Real

This format would appear in memory as:

1-bit sign field	(1 binary digit)
8-bit biased exponent field	(2 hex digits. Bias = \$7F)
23-bit fraction field	(6 hex digits)

A single precision number takes 4 bytes in memory.

5

Double Precision Real

This format would appear in memory as:

1-bit sign field	(1 binary digit)
11-bit biased exponent field	(3 hex digits. Bias = \$3FF)
52-bit fraction field	(13 hex digits)

A double precision number takes 8 bytes in memory.

Note The single and double precision formats have an implied integer bit (always 1).

Scientific Notation

This format provides a convenient way to enter and display a floating point decimal number. Internally, the number is assembled into a packed decimal number and then converted into a number of the specified data type.

Entering data in this format requires the following fields:

5

An optional sign bit (+ or -).

One decimal digit followed by a decimal point.

Up to 17 decimal digits (at least one must be entered).

An optional Exponent field that consists of:

An optional underscore.

The Exponent field identifier, letter "E".

An optional Exponent sign (+, -).

From 1 to 3 decimal digits.

For more information about the floating point SFU, refer to the *MC88100 RISC Microprocessor User's Manual*.

The 187Bug Debugger Command Set

The 187Bug debugger commands are summarized in Table 5-1. The command syntax is shown using the symbols explained earlier in this chapter. The **CNFG** and **ENV** commands are explained in Appendix A. Controllers, devices, and their LUNs are listed in Appendix B or Appendix C. All other command details are explained in the *MVME187Bug Debugging Package User's Manual*.

Table 5-1. Debugger Commands

Command Mnemonic	Title	Command Line Syntax
AB	Automatic Bootstrap Operating System	AB [<i>V</i>]
NOAB	No Auto Boot	NOAB
AS	One Line Assembler	AS <i>addr</i>
BC	Block of Memory Compare	BC <i>range del addr</i> [<i>; B H W</i>]
BF	Block of Memory Fill	BF <i>range del data</i> [<i>del increment</i>] [<i>; B H W</i>]
BH	Bootstrap Operating System and Halt	BH [<i>del controller LUN</i>] [<i>del device LUN</i>] [<i>del string</i>]
BI	Block of Memory Initialize	BI <i>range</i> [<i>; B H W</i>]
BM	Block of Memory Move	BM <i>range del addr</i> [<i>; B H W</i>]
BO	Bootstrap Operating System	BO [<i>del controller LUN</i>] [<i>del device LUN</i>] [<i>del string</i>]
BR	Breakpoint Insert	BR [<i>addr</i> [<i>: count</i>]]
NOBR	Breakpoint Delete	NOBR [<i>addr</i>]
BS	Block of Memory Search	BS <i>range del text</i> [<i>; B H W</i>] or BS <i>range del data</i> [<i>del mask</i>] [<i>; B H W</i> [<i>,N</i>],[<i>,V</i>]]
BV	Block of Memory Verify	BV <i>range del data</i> [<i>del increment</i>] [<i>; B H W</i>]
CB	Cache Bit Test	CB { <i>CMMU-ID</i> }
CD	Cache Display	CD <i>CMMU-ID</i> [<i>del set-start</i> [<i>: count</i> <i>del set-end</i>]]
CM	Concurrent Mode	CM [[<i>port</i>] [<i>del ID-string</i>] [<i>del baud</i>] [<i>del phone-number</i>]] [<i>;[A H]</i>]
NOCM	No Concurrent Mode	NOCM

Table 5-1. Debugger Commands (Continued)

Command Mnemonic	Title	Command Line Syntax
CNFG	Configure Board Information Block	CNFG [<i>;</i> [I] [M]]
CS	Checksum	CS <i>range</i> [<i>;</i> B H W]
DC	Data Conversion	DC <i>exp</i> <i>addr</i> [<i>;</i> [B] [O] [A]]
DMA	DMA Block of Memory Move	DMA <i>range del addr del vdir del am del blk</i> [<i>;</i> B H W]
DS	One Line Disassembler	DS <i>addr</i> [<i>:</i> <i>count</i> <i>del addr</i>]
DU	Dump S-records	DU [<i>port</i>] <i>del range</i> [<i>del text</i>] [<i>del addr</i>] [<i>del offset</i>] [<i>;</i> B H W]
ECHO	Echo String	ECHO [<i>port</i>] <i>del</i> { <i>hexadecimal number</i> } {' <i>string</i> '}
ENV	Set Environment to Bug/Operating System	ENV [<i>;</i> [D]]
GD	Go Direct (Ignore Breakpoints)	GD [<i>addr</i>]
GN	Go to Next Instruction	GN
GO	Go Execute User Program	GO [<i>addr</i>]
GT	Go to Temporary Breakpoint	GT <i>addr</i>
HE	Help	HE [<i>command</i>]
IOC	I/O Control for Disk	IOC
IOI	I/O Inquiry	IOI [<i>;</i> [C] [L]]
IOP	I/O Physical (Direct Disk Access)	IOP
IOT	I/O "TEACH" for Configuring Disk Controller	IOT [<i>;</i> [A] [F] [H] [T]]
IRQM	Interrupt Request Mask	IRQM [<i>mask</i>]
LO	Load S-records from Host	LO [<i>port</i>] [<i>addr</i>] [<i>;</i> [X][C][T]] [= <i>text</i>]
MA	Macro Define/Display	MA [<i>name</i> <i>;</i> L]
NOMA	Macro Delete	NOMA [<i>name</i>]
MAE	Macro Edit	MAE <i>name del line#</i> [<i>del string</i>]
MAL	Enable Macro Expansion Listing	MAL

Table 5-1. Debugger Commands (Continued)

Command Mnemonic	Title	Command Line Syntax
NOMAL	Disable Macro Expansion Listing	NOMAL
MAW	Save Macros	MAW [<i>controller LUN</i>] [<i>del</i> [<i>device LUN</i>] [<i>del block #</i>]]
MAR	Load Macros	MAR [<i>controller LUN</i>] [<i>del</i> [<i>device LUN</i>] [<i>del block #</i>]]
MD	Memory Display	MD [<i>S</i>] <i>addr</i> [: <i>count</i> <i>del addr</i>] [: [B H W S D DI]]
MENU	Menu	MENU
MM	Memory Modify	MM <i>addr</i> [: [[B H W S D][A][N]] [DI]]
MMD	Memory Map Diagnostic	MMD <i>range del increment</i> [: B H W]
MS	Memory Set	MS <i>addr</i> { <i>Hexadecimal number</i> } {' <i>string</i> '}
MW	Memory Write	MW <i>addr data</i> [: B H W]
NAB	Automatic Network Boot Operating System	NAB
NBH	Network Boot Operating System and Halt	NBH [<i>controller LUN</i>] [<i>device LUN</i>] [<i>client IP Address</i>] [<i>server IP Address</i>] [<i>string</i>]
NBO	Network Boot Operating System	NBO [<i>controller LUN</i>] [<i>device LUN</i>] [<i>client IP Address</i>] [<i>server IP Address</i>][<i>string</i>]
NIOC	Network I/O Control	NIOC
NIOP	Network I/O Physical	NIOP
NIOT	Network I/O Teach	NIOT [: [H] [A]]
NPING	Network Ping	NPING <i>controller-LUN del device-LUN del source-IP del destination-IP</i> [<i>del n-packets</i>]
OF	Offset Registers Display / Modify	OF [Zn [: A]]
PA	Printer Attach	PA [<i>port</i>]
NOPA	Printer Detach	NOPA [<i>port</i>]
PF	Port Format	PF [<i>port</i>]
NOPF	Port Detach	NOPF [<i>port</i>]
PS	Put RTC Into Power Save Mode for Storage	PS
RB	ROMboot Enable	RB [: V]
NORB	ROMboot Disable	NORB

Table 5-1. Debugger Commands (Continued)

Command Mnemonic	Title	Command Line Syntax
RD	Register Display	RD {[+ - =] [<i>dname</i>] [/]} {[+ - =] [<i>reg1</i> [- <i>reg2</i>]] [/]} [; E]
REMOTE	Connect the Remote Modem to CSO	REMOTE
RESET	Cold/Warm Reset	RESET
RL	Read Loop	RL <i>addr</i> [; [B H W]]
RM	Register Modify	RM [<i>reg</i>] [; [S D]]
RS	Register Set	RS <i>reg</i> [<i>del exp</i> <i>del addr</i>] [; [S D]]
SD	Switch Directories	SD
SET	Set Time and Date	SET <i>mmddyyhhmm</i> <i>n</i> ; C
SYM	Symbol Table Attach	SYM [<i>addr</i>]
NOSYM	Symbol Table Detach	NOSYM
SYMS	Symbol Table Display/Search	SYMS [<i>symbol-name</i>] [; S]
T	Trace	T [<i>count</i>]
TA	Terminal Attach	TA [<i>port</i>]
TC	Trace on Change of Control Flow	TC [<i>count</i>]
TIME	Display Time and Date	TIME [; [C L O]]
TM	Transparent Mode	TM [<i>port</i>] [<i>del ESCAPE</i>]
TT	Trace to Temporary Breakpoint	TT <i>addr</i>
VE	Verify S-Records Against Memory	VE [<i>port</i>] [<i>del addr</i>] [; [X] [C]] [= <i>text</i>]
VER	Revision/Version Display	VER [; E]
WL	Write Loop	WL <i>addr del data</i> [; [B H W]]

This Appendix Covers

- ❑ Configuring the board information block
- ❑ Setting the environment to Bug/Operating System
- ❑ Environment command parameters

Configuring the Board Information Block

`CNFG [;[I][M]]`

This command is used to display and configure the board information block. This block is resident within the Non-Volatile RAM (NVRAM). Refer to the *MVME187 RISC Single Board Computer User's Manual* for the actual location.

The information block contains various elements detailing specific operation parameters of the hardware. The *MVME187 RISC Single Board Computer User's Manual* describes the elements within the board information block, and lists the size and logical offset of each element. The `CNFG` command does *not* describe the elements and their use. The board information block contents are checksummed for validation purposes. This checksum is the last element of the block.

Example: Display the current contents of the board information block.

```
187-Bug>cnfg
Board (PWA) Serial Number = "000000061050"
Board Identifier           = "MVME187-03      "
Artwork (PWA) Identifier  = "01-W3827B03A   "
MPU Clock Speed           = "2500"
Ethernet Address          = 08003E20A867
Local SCSI Identifier     = "07"
Optional Board 1 Artwork (PWA) Identifier = "      "
Optional Board 1 (PWA) Serial Number      = "      "
Optional Board 2 Artwork (PWA) Identifier = "      "
Optional Board 2 (PWA) Serial Number      = "      "
187-Bug>
```

Note that the parameters that are quoted are left-justified character (ASCII) strings padded with space characters, and the quotes (") are displayed to indicate the size of the string. Parameters that are not quoted are considered data strings, and data strings are right-justified. The data strings are padded with zeroes if the length is not met.

In the event of corruption of the board information block, the command displays a question mark "?" for nondisplayable characters. A warning message (`WARNING: Board Information Block Checksum Error`) is also displayed in the event of a checksum failure.

Using the **I** option initializes the unused area of the board information block to zero.

Modification is permitted by using the **M** option of the command. At the end of the modification session, you are prompted for the update to Non-Volatile RAM (NVRAM). A **Y** response must be made for the update to occur; any other response terminates the update (disregards all changes). The update also recalculates the checksum.

Be cautious when modifying parameters. These parameters are initialized by the factory, and correct board operation relies upon these parameters.

Once modification and update are complete, you can now display the current contents as described earlier.

Setting Environment to Bug/Operating System

`ENV [;[D]]`

The `ENV` command allows you to interactively view and configure all Bug operational parameters that are kept in Battery Backed Up RAM (BBRAM), also known as Non-Volatile RAM (NVRAM). The operational parameters are saved in NVRAM and used whenever power is lost.

Any time the Bug uses a parameter from NVRAM, the NVRAM contents are first tested by checksum to insure the integrity of the NVRAM contents. In the instance of BBRAM checksum failure, certain default values are assumed as stated below.

The bug operational parameters (which are kept in NVRAM) are not initialized automatically on power-up/warm reset. It is up to the Bug user to invoke the `ENV` command. Once the `ENV` command is invoked and executed without error, Bug default and/or user modified parameters are loaded into NVRAM along with checksum data. The operational parameters that have been modified will not be in effect until a reset/power-up condition.

If the `ENV` command is invoked with no options on the command line, you are prompted to configure all operational parameters. If the `ENV` command is invoked with the option `D`, ROM defaults will be loaded into NVRAM.

The parameters to be configured are listed in the following table:

Table A-1. ENV Command Parameters

ENV Parameter and Options	Default	Meaning of Default
Bug or System environment [B/S]	S	System Mode
Field Service Menu Enable [Y/N]	Y	Display field service menu.
Remote Start Method Switch [G/M/B/N]	B	Use both the Global Control and Status Register (GCSR) in the VMEchip2, and the Multiprocessor Control Register (MPCR) in shared RAM, methods to pass and start execution of cross-loaded program.
Probe System for Supported I/O Controllers [Y/N]	Y	Accesses will be made to VMEbus to determine presence of supported controllers.
Negate VMEbus SYSFAIL* Always [Y/N]	N	Negate VMEbus SYSFAIL after successful completion or entrance into the bug command monitor.
Local SCSI Bus Reset on Debugger Startup [Y/N]	N	Local SCSI bus is not reset on debugger startup.
Local SCSI Bus Negotiations Type [A/S/N]	A	Asynchronous.
Ignore CFGA Block on a Hard Disk Boot [Y/N]	Y	Enable the ignorance of the Configuration Area (CFGA) Block on a hard disk.
Auto Boot Enable [Y/N]	N	Auto Boot function is disabled.
Auto Boot at power-up only [Y/N]	Y	Auto Boot is attempted at power-up reset only.
Auto Boot Controller LUN	00	LUN of a disk/tape controller module currently supported by the Bug. Default is 00.
Auto Boot Device LUN	00	LUN of a disk/tape device currently supported by the Bug. Default is 00.

Table A-1. ENV Command Parameters (Continued)

ENV Parameter and Options	Default	Meaning of Default
Auto Boot Abort Delay	15	This is the time in seconds that the Auto Boot sequence will delay before starting the boot. The purpose for the delay is to allow you the option of stopping the boot by use of the Break key. The time value is from 0 through 255 seconds.
Auto Boot Default String [NULL for an empty string]	Null	You may specify a string (filename) which is passed on to the code being booted. Maximum length is 16 characters. Default is the null string.
ROM Boot Enable [Y/N]	N	ROMboot function is disabled.
ROM Boot at power-up only [Y/N]	Y	ROMboot is attempted at powerup only.
ROM Boot Enable search of VMEbus [Y/N]	N	VMEbus address space will not be accessed by ROMboot.
ROM Boot Abort Delay	0	This is the time in seconds that the ROMboot sequence will delay before starting the boot. The purpose for the delay is to allow you the option of stopping the boot by use of the Break key. The time value is from 0 through 255 seconds.
ROM Boot Direct Starting Address	FF800000	First location tested when the Bug searches for a ROMboot Module.
ROM Boot Direct Ending Address	FFBFFFFC	Last location tested when the Bug searches for a ROMboot Module.
Network Auto Boot Enable [Y/N]	N	Network Auto Boot function is disabled.
Network Auto Boot at power-up only [Y/N]	Y	Network Auto Boot is attempted at power-up reset only.

Table A-1. ENV Command Parameters (Continued)

ENV Parameter and Options	Default	Meaning of Default
Network Auto Boot Controller LUN	00	LUN of a network controller module currently supported by the Bug. Default is 00.
Network Auto Boot Device LUN	00	LUN of a network device currently supported by the Bug. Default is 00.
Network Auto Boot Abort Delay	5	This is the time in seconds that the Network Boot sequence will delay before starting the boot. The purpose for the delay is to allow you the option of stopping the boot by use of the Break key. The time value is from 0 through 255 seconds.

Table A-1. ENV Command Parameters (Continued)

ENV Parameter and Options	Default	Meaning of Default
Network Auto Boot Configuration Parameters Pointer (NVRAM)	00000000	<p>This is the address where the network interface configuration parameters are to be saved in NVRAM; these parameters are the necessary parameters to perform an unattended network boot.</p> <p> Caution</p> <p>If you use the NIOT debugger command, these parameters need to be saved in the NVRAM, somewhere in the address range \$FFFC0000 through \$FFFC0FFF. The NIOT parameters do not exceed 128 bytes in size. The location for these parameters is determined by setting this ENV pointer. If you have used the exact same space for your own program information or commands, they will be overwritten and lost.</p>
Memory Search Starting Address	00000000	<p>Where the Bug begins to search for a work page (a 64KB block of memory) to use for vector table, stack, and variables. This must be a multiple of the debugger work page, modulo \$10000 (64KB). In a multi-187 environment, each MVME187 board could be set to start its work page at a unique address to allow multiple debuggers to operate simultaneously from the same memory.</p>

Table A-1. ENV Command Parameters (Continued)

ENV Parameter and Options	Default	Meaning of Default
Memory Search Ending Address	02000000	Top limit of the Bug's search for a work page. If a contiguous block of memory, 64KB in size, is not found in the range specified by Memory Search Starting Address and Memory Search Ending Address parameters, then the bug will place its work page in the onboard static RAM on the MVME187. Default Memory Search Ending Address is the calculated size of local memory.
Memory Search Increment Size	00010000	This multi-CPU feature is used to offset the location of the Bug work page. This must be a multiple of the debugger work page, modulo \$10000 (64KB). Typically, Memory Search Increment Size is the product of CPU number and size of the Bug work page. Example: first CPU \$0 (0 x \$10000), second CPU \$10000 (1 x \$10000), etc.
Memory Search Delay Enable [Y/N]	N	There will be no delay before the Bug begins its search for a work page.
Memory Search Delay Address	FFFFCE0F	The process of using the Memory Search Delay Address was implemented on the MVME188. It has not been used on the MVME187.
Memory Size Enable [Y/N]	Y	Memory will be sized for Self Test diagnostics.
Memory Size Starting Address	00000000	Default Starting Address is \$0.
Memory Size Ending Address	02000000	Default Ending Address is the calculated size of local memory.

Table A-1. ENV Command Parameters (Continued)

ENV Parameter and Options	Default	Meaning of Default
Base Address of Local Memory	00000000	Beginning address of Local Memory. It must be a multiple of the Local Memory board size, starting with 0. The Bug will set up hardware address decoders so that Local Memory resides as one contiguous block at this address. Default is \$0.
Size of Local Memory Board #0 Size of Local Memory Board #1	02000000 00000000	You are prompted twice, once for each possible MVME187 memory mezzanine board. Default is the calculated size of the memory board.
Slave address decoders setup. The slave address decoders are used to allow another VMEbus master to access a local resource of the MVME187. There are two slave address decoders. They are set up as follows.		
Slave Enable #1 [Y/N]	Y	Yes, Setup and enable the Slave Address Decoder #1.
Slave Starting Address #1	00000000	Base address of the local resource that is accessible by the VMEbus, as viewed by the VMEbus. Default is the base of local memory, \$0.
Slave Ending Address #1	01FFFFFF	Ending address of the local resource that is accessible by the VMEbus, as viewed by the VMEbus. Default is the end of calculated memory.
Slave Address Translation Address #1	00000000	This register will allow the VMEbus address and the local address to be different. The value in this register is the base address of the local resource that is associated with the starting and ending address selection from the previous questions. Default is \$0.

Table A-1. ENV Command Parameters (Continued)

ENV Parameter and Options	Default	Meaning of Default
Slave Address Translation Select #1	00000000	This register defines which bits of the Translation Address are significant. A logical one "1" indicates significant address bits, logical zero "0" is non-significant. The non-significant bits will come from the VMEbus address that accesses the local resource. Normally, MS bits will be set, down to the size of memory to be accessed. Default is \$0.
Slave Control #1	01FF	Defines the access restriction for the address space defined with this slave address decoder. Default is \$01FF. See description of VMEchip2 bits in <i>Single Board Computer Programmer's Reference Guide</i> .
Slave Enable #2 [Y/N]	Y	Yes, Setup and enable the Slave Address Decoder #2.
Slave Starting Address #2	FFE00000	Base address of the local resource that is accessible by the VMEbus, as viewed by the VMEbus. Default is the base address of static RAM, \$FFE00000.
Slave Ending Address #2	FFE1FFFF	Ending address of the local resource that is accessible by the VMEbus, as viewed by the VMEbus. Default is the end of static RAM, \$FFE1FFFF.
Slave Address Translation Address #2	00000000	Works the same as Slave Address Translation Address #1. Default is \$0.
Slave Address Translation Select #2	00000000	Works the same as Slave Address Translation Select #1. Default is \$0.
Slave Control #2	01EF	Works the same as Slave Control #1. Default is \$01EF.

Table A-1. ENV Command Parameters (Continued)

ENV Parameter and Options	Default	Meaning of Default
Master Enable #1 [Y/N]	Y	Yes, Setup and enable the Master Address Decoder #1.
Master Starting Address #1	02000000	Base address of the VMEbus resource that is accessible from the local bus. Default is the end of calculated local memory.
Master Ending Address #1	FFFFFFF	Ending address of the VMEbus resource that is accessible from the local bus. Default is the end of calculated memory.
Master Control #1	0D	Works the same as Slave Control #1. Default is \$0D.
Master Enable #2 [Y/N]	N	Do not set up and enable the Master Address Decoder #2.
Master Starting Address #2	00000000	Base address of the VMEbus resource that is accessible from the local bus. Default is \$0.
Master Ending Address #2	00000000	Ending address of the VMEbus resource that is accessible from the local bus. Default is \$0.
Master Control #2	00	Works the same as Slave Control #1. Default is \$00.
Master Enable #3 [Y/N]	N	Do not set up and enable the Master Address Decoder #3.
Master Starting Address #3	00000000	Base address of the VMEbus resource that is accessible from the local bus. Default is \$0.
Master Ending Address #3	00000000	Ending address of the VMEbus resource that is accessible from the local bus. Default is \$0.
Master Control #3	00	Works the same as Slave Control #1. Default is \$00.

Table A-1. ENV Command Parameters (Continued)

ENV Parameter and Options	Default	Meaning of Default
Master Enable #4 [Y/N]	N	Do not set up and enable the Master Address Decoder #4.
Master Starting Address #4	00000000	Base address of the VMEbus resource that is accessible from the local bus. This will be the local bus address. Default is \$0.
Master Ending Address #4	00000000	Ending address of the VMEbus resource that is accessible from the local bus. This will be the local bus address. Default is \$0.
Master Address Translation Address #4	00000000	This register will allow the VMEbus address and the local address to be different. The value in this register is the base address of the VMEbus resource that is associated with the starting and ending address selection from the previous questions. Default is \$0.
Master Address Translation Select #4	00000000	This register defines which bits of the Translation Address are significant. A logical one "1" indicates significant address bits, logical zero "0" is non-significant. The non-significant bits will come from the local bus address that accesses the VMEbus. Normally MS bits will be set, down to the size of memory to be accessed. Default is \$0.
Master Control #4	00	Works the same as Slave Control #1. Default is \$00.
Short I/O (VMEbus A16) Enable [Y/N]	Y	Yes, Enable the Short I/O Address Decoder.
Short I/O (VMEbus A16) Control	01	Works the same as Slave Control #1. Default is \$01.

Table A-1. ENV Command Parameters (Continued)

ENV Parameter and Options	Default	Meaning of Default
F-Page (VMEbus A24) Enable [Y/N]	Y	Yes, Enable the F-Page Address Decoder.
F-Page (VMEbus A24) Control	02	Works the same as Slave Control #1. Default is \$02.
ROM Speed Bank A Code ROM Speed Bank B Code	05 05	Used to set up the ROM speed. Default is \$05 = 165 ns (25 MHz MVME187) or \$04=145 ns (33 MHz MVME187).
Static RAM Speed Code	01	Used to set up the SRAM speed. Default is \$01 = 125 ns (25 MHz MVME187) or \$00=115 ns (33 MHz MVME187).
PCC2 Vector Base VMEC2 Vector Base #1 VMEC2 Vector Base #2	05 06 07	Base interrupt vector for the component specified. Default: PCCchip2 = \$05, VMEchip2 Vector 1 = \$06, VMEchip2 Vector 2 = \$07.
VMEC2 GCSR Group Base Address	CE	Specifies the group address (\$FFFFXX00) in Short I/O for this board. Default = \$CE.
VMEC2 GCSR Board Base Address	00	Specifies the base address (\$FFFFCEx0) in Short I/O for this board. Default = \$00.
VMEbus Global Time Out Code	01	This controls the VMEbus timeout when this MVME187 is the system controller. Default \$01 = 64 μ s.
Local Bus Time Out Code	00	This controls the local bus timeout. Default \$00 = 8 μ s.
VMEbus Access Time Out Code	02	This controls the local bus to VMEbus access timeout. Default \$02 = 32 ms.

Disk/Tape Controller Data

B

Disk/Tape Controller Modules Supported

The following VMEbus disk/tape controller modules are supported by the 187Bug. The default address for each controller type is First Address and the controller can be addressed by First CLUN during commands **BH**, **BO**, or **IOP**, or during TRAP #496 calls **.DSKRD** or **.DSKWR**.

Note that if another controller of the same type is used, the second one must have its address changed by its onboard jumpers and/or switches, so that it matches Second Address and can be called up by Second CLUN.

Controller Type	First CLUN	First Address	Second CLUN	Second Address
RISC Single Board Computer (MVME187)	\$00	--	--	--
MVME320 - Winchester/Floppy Controller	\$11	\$FFFFB000	\$12	\$FFFFAC00
MVME323 - ESDI Winchester Controller	\$08	\$FFFA000	\$09	\$FFFA200
MVME327A - SCSI Controller	\$02	\$FFFA600	\$03	\$FFFA700
MVME328 - SCSI Controller	\$06	\$FFF9000	\$07	\$FFF9800
MVME328 - SCSI Controller	\$16	\$FFF4800	\$17	\$FFF5800
MVME328 - SCSI Controller	\$18	\$FFF7000	\$19	\$FFF7800
MVME350 - Streaming Tape Controller	\$04	\$FFF5000	\$05	\$FFF5100

Disk/Tape Controller Default Configurations

Note SCSI Common Command Set (CCS) devices are only the ones tested by Motorola Computer Group.

RISC Single Board Computers -- 7 Devices

Controller LUN	Address	Device LUN	Device Type
0	\$XXXXXXXX	00	SCSI Common Command Set
		10	(CCS), which may be any of these:
		20	- Fixed direct access
		30	- Removable flexible direct access
		40	(TEAC style)
		50	- CD-ROM
		60	- Sequential access

MVME320 -- 4 Devices

Controller LUN	Address	Device LUN	Device Type
11	\$FFFFB000	0	Winchester hard drive
		1	Winchester hard drive
12	\$FFFFAC00	2	5-1/4" DS/DD 96 TPI floppy drive
		3	5-1/4" DS/DD 96 TPI floppy drive

MVME323 -- 4 Devices

Controller LUN	Address	Device LUN	Device Type
8	\$FFFFA000	0	ESDI Winchester hard drive
		1	ESDI Winchester hard drive
9	\$FFFFA200	2	ESDI Winchester hard drive
		3	ESDI Winchester hard drive

MVME327A -- 9 Devices

Controller LUN	Address	Device LUN	Device Type
2	\$FFFA600	00	SCSI Common Command Set (CCS), which may be any of these:
		10	
3	\$FFFA700	20	- Fixed direct access
		30	- Removable flexible direct access (TEAC style)
		40	- CD-ROM
		50	- Sequential access
		60	
		80	Local floppy drive
		81	Local floppy drive

MVME328 -- 14 Devices

Controller LUN	Address	Device LUN	Device Type
6	\$FFF9000	00	SCSI Common Command Set (CCS), which may be any of these:
		08	
		10	
7	\$FFF9800	18	- Removable flexible direct access (TEAC style)
		20	- CD-ROM
		28	- Sequential access
16	\$FFF4800	30	Same as above, but these will only be available if the daughter card for the second SCSI channel is present.
17	\$FFF5800	40	
		48	
		50	
18	\$FFF7000	58	
		60	
19	\$FFF7800	68	
		70	

MVME350 -- 1 Device

Controller LUN	Address	Device LUN	Device Type
4	\$FFFF5000	0	QIC-02 streaming tape drive
5	\$FFFF5100		

IOT Command Parameters for Supported Floppy Types

The following table lists the proper IOT command parameters for floppies used with boards such as the MVME328, MVME167, and MVME187.

IOT Parameter	Floppy Types and Formats						
	DSD5	PCXT8	PCXT9	PCXT9_3	PCAT	PS2	SHD
Sector Size: 0-128 1-256 2-512 3-1024 4-2048 5-4096	1	2	2	2	2	2	2
Block Size: 0-128 1-256 2-512 3-1024 4-2048 5-4096	1	1	1	1	1	1	1
Sectors/Track	10	8	9	9	F	12	24
Number of Heads	2	2	2	2	2	2	2
Number of Cylinders	50	28	28	50	50	50	50
Precomp. Cylinder	50	28	28	50	50	50	50
Reduced Write Current Cylinder	50	28	28	50	50	50	50
Step Rate Code	0	0	0	0	0	0	0
Single/Double DATA Density	D	D	D	D	D	D	D
Single/Double TRACK Density	D	D	D	D	D	D	D

IOT Parameter	Floppy Types and Formats						
	DSDD5	PCXT8	PCXT9	PCXT9_3	PCAT	PS2	SHD
Single/Equal_in_all Track Zero Density	S	E	E	E	E	E	E
Slow/Fast Data Rate	S	S	S	S	F	F	F
Other Characteristics							
Number of Physical Sectors	0A00	0280	02D0	05A0	0960	0B40	1680
Number of Logical Blocks (100 in size)	09F8	0500	05A0	0B40	12C0	1680	2D00
Number of Bytes in Decimal	653312	327680	368460	737280	1228800	1474560	2949120
Media Size/Density	5.25/DD	5.25/DD	5.25/DD	3.5/DD	5.25/HD	3.5/HD	3.5/ED

Notes

1. All numerical parameters are in hexadecimal unless otherwise noted.
2. The DSDD5-type floppy is the default setting for the debugger.

B

Network Controller Modules Supported

The VMEbus network controller modules supported by MVME187Bug are shown in Table C-1. The default address for each type and position is shown to indicate where the controller must reside to be supported by MVME187Bug.

The CLUNs and DLUNs are used in conjunction with the following debugger commands and debugger system calls:

Debugger Commands	Debugger System Calls
NBH	.NETRD
NBO	.NETWR
NIOC	.NETFOPN
NIOP	.NETFRD
NIOT	.NETCFIG
NPING	.NETCTRL
NAB	

The controllers are accessed via the CLUNs and DLUNs specified in the following table.

Table C-1. Network Controller Access Data

Controller Type	CLUN	DLUN	Address	Interface Type
MVME187	\$00	\$00	\$FFF46000	Ethernet
MVME376	\$02	\$00	\$FFFF1200	Ethernet
MVME376	\$03	\$00	\$FFFF1400	Ethernet
MVME376	\$04	\$00	\$FFFF1600	Ethernet
MVME376	\$05	\$00	\$FFFF5400	Ethernet
MVME376	\$06	\$00	\$FFFF5600	Ethernet

Table C-1. Network Controller Access Data (Continued)

Controller Type	CLUN	DLUN	Address	Interface Type
MVME376	\$07	\$00	\$FFFA400	Ethernet
MVME374	\$10	\$00	\$FF00000	Ethernet
MVME374	\$11	\$00	\$FF10000	Ethernet
MVME374	\$12	\$00	\$FF20000	Ethernet
MVME374	\$13	\$00	\$FF30000	Ethernet
MVME374	\$14	\$00	\$FF40000	Ethernet
MVME374	\$15	\$00	\$FF50000	Ethernet

C

Troubleshooting the MVME187: Solving Startup Problems

D

- ❑ Try these simple troubleshooting steps before calling for help or sending your CPU board back for repair.
- ❑ Some of the procedures will return the board to the factory debugger environment. (The board was tested under these conditions before it left the factory.)
- ❑ Selftest may not run in all user-customized environments.

Table D-1. Troubleshooting Steps

Condition	Possible Problem	Try This:
I. Nothing works, no display on the terminal.	A. If the RUN or +12V LED is not lit, the board may not be getting correct power.	<ol style="list-style-type: none">1. Make sure the system is plugged in.2. Check that the board is securely installed in its backplane or chassis.3. Check that all necessary cables are connected to the board, per this manual.4. Check for compliance with System Considerations, in Chapter 3.5. Review the Installation and Startup procedures, in Chapter 3. The step-by-step powerup routine for your board is on page 3-17. Try it.
	B. If the LEDs are lit, the board may be in the wrong slot.	<ol style="list-style-type: none">1. The CPU board should be in the first (leftmost) slot if it is to be the system controller.2. The “system controller” function requires that header J2 be set properly. See Chapter 3.
	C. The system console terminal may be configured wrong.	Configure the system console terminal according to the instructions in Chapter 3.

Table D-1. Troubleshooting Steps (Continued)

Condition	Possible Problem	Try This:
II. There is a display on the terminal, but input from the keyboard has no effect.	A. The keyboard may be connected incorrectly.	Recheck the keyboard connections and power.
	B. Board jumpers may be configured incorrectly.	Check the board jumpers per this manual.
	C. You may have invoked flow control by pressing a HOLD or PAUSE key, or by typing ^S Also, a HOLD LED may be lit on the keyboard.	Press the HOLD or PAUSE key again. If this does not free up the keyboard, type in ^Q (Hold down the CONTROL key and type a "Q")

D

Table D-1. Troubleshooting Steps (Continued)



Condition	Possible Problem	Try This:
III. Debug prompt 187-Bug> does not appear at powerup, and the board does not auto boot.	A. Debugger EPROM may be missing.	1. Disconnect <i>all</i> power from your system. 2. Check that the proper debugger EPROM is installed per this manual.
	B. The board may need to be reset.	3. Reconnect power. <div style="display: flex; align-items: center; justify-content: center;">  <div style="margin-left: 10px;"> <p>Caution</p> <p>Performing the next step will change some parameters that may affect your system operation.</p> </div> </div> 4. Restart the system by “double-button reset”: press the RESET and ABORT switches at the same time; release RESET first, wait five seconds, then release ABORT. 5. If the debug prompt appears, go to step IV or step V, as indicated. If the debug prompt does not appear, go to step VI.

Table D-1. Troubleshooting Steps (Continued)

Condition	Possible Problem	Try This:
<p>IV. Debug prompt 187-Bug> appears at powerup, but the board does not auto boot.</p>	<p>A. The initial debugger environment parameters may be set wrong.</p> <hr/> <p>B. There may be some fault in the board hardware.</p>	<p>1. Start the onboard calendar clock and timer. Type in set mmddyymm <Return> where the characters indicate the month, day, year, hour, and minute. The date and time will be displayed.</p> <div style="display: flex; align-items: center; margin: 10px 0;">  <p>Caution Performing the next step will change some parameters that may affect your system operation.</p> </div> <p>2. Type in env;d <Return> This sets up the default parameters for the debugger environment.</p> <p>3. When prompted to Update Non-Volatile RAM, type in y <Return></p> <p>4. When prompted to Reset Local System, type in y <Return></p> <p>5. After clock speed is displayed, immediately (within five seconds) press the RETURN key <Return> or BREAK to exit to System Menu. Then enter a 3 "Go to System Debugger" and press the RETURN key 3 <Return> Now the prompt should be 187-Diag></p>

D

Table D-1. Troubleshooting Steps (Continued)

Condition	Possible Problem	Try This:
		<p>6. You may need to use the cnfg command (see Appendix A) to change clock speed and/or Ethernet Address, and then later return to env <Return> and step 3.</p> <p>7. Run selftest by typing in st <Return> The tests take as much as 10 minutes, depending on RAM size. They are complete when the prompt returns. (The onboard selftest is a valuable tool in isolating defects.)</p> <p>8. The system may indicate that it has passed all the selftests. Or, it may indicate a test that failed. If neither happens, enter de <Return> Any errors should now be displayed. If there are any errors, go to step VI. If there are no errors, go to step V.</p>
<p>V. The debugger is in system mode and the board auto boots, or the board has passed selftests.</p>	<p>A. No problems. Troubleshooting is done.</p>	<p>No further troubleshooting steps are required.</p> <p>Note Even if the board passes all tests, it may still be bad. Selftest does not try out all functions in the board (for example, SCSI, or VMEbus tests).</p>
<p>VI. The board has failed one or more of the tests listed above, and can not be corrected using the steps given.</p>	<p>A. There may be some fault in the board hardware or the on-board debugging and diagnostic firmware.</p>	<p>1. Document the problem and return the board for service. 2. Phone 1-800-222-5640.</p>
<p>YOU ARE FINISHED (DONE) WITH THIS TROUBLESHOOTING PROCEDURE.</p>		

D

EIA-232-D Interconnections

E

Introduction

The EIA-232-D standard is the most common terminal/ computer and terminal/ modem interface, and yet it is not fully understood. This may be because not all the lines are clearly defined, and many users do not see the need to follow the standard in their applications. Often designers think only of their own equipment, but the state of the art is computer-to-computer or computer-to-modem operation. A system should easily connect to any other system.

The EIA-232-D standard was originally developed by the Bell System to connect terminals via modems. Several handshaking lines were included for that purpose. Although handshaking is unnecessary in many applications, the lines themselves remain part of many designs because they facilitate troubleshooting.

[Table E-1](#) lists the standard EIA-232-D interconnections. To interpret this information correctly, remember that EIA-232-D was intended to connect a terminal to a modem. When computers are connected to each other without modems, one of them must be configured as a terminal (data terminal equipment: DTE) and the other as a modem (data circuit-terminating equipment: DCE). Since computers are normally configured to work with terminals, they are said to be configured as a modem in most cases.

Signal levels must lie between +3 and +15 volts for a high level, and between -3 and -15 volts for a low level. Connecting units in parallel may produce out-of-range voltages and is contrary to EIA-232-D specifications.

Table E-1. EIA-232-D Interconnections

Pin Number	Signal Mnemonic	Signal Name and Description
1		CHASSIS GROUND. Not always used. See section <i>Proper Grounding</i> .
2	TxD	TRANSMIT DATA. Data to be transmitted; input to the modem from the terminal.
3	RxD	RECEIVE DATA. Data which is demodulated from the receive line; output from the modem to the terminal.
4	RTS	REQUEST TO SEND. Input to the modem from the terminal when required to transmit a message. With RTS off, the modem carrier remains off. When RTS is turned on, the modem immediately turns on the carrier.
5	CTS	CLEAR TO SEND. Output from the modem to the terminal to indicate that message transmission can begin. When a modem is used, CTS follows the off-to-on transition of RTS after a time delay.
6	DSR	DATA SET READY. Output from the modem to the terminal to indicate that the modem is ready to transmit data.
7	SIG-GND	SIGNAL GROUND. Common return line for all signals at the modem interface.
8	DCD	DATA CARRIER DETECT. Output from the modem to the terminal to indicate that a valid carrier is being received.
9-14		Not used.
15	TxC	TRANSMIT CLOCK (DCE). Output from the modem to the terminal; clocks data from the terminal to the modem.
16		Not used.
17	RxC	RECEIVE CLOCK. Output from the modem to the terminal; clocks data from the modem to the terminal.
18, 19		Not used.
20	DTR	DATA TERMINAL READY. Input to the modem from the terminal; indicates that the terminal is ready to send or receive data.
21		Not used.

Table E-1. EIA-232-D Interconnections (Continued)

Pin Number	Signal Mnemonic	Signal Name and Description
22	RI	RING INDICATOR. Output from the modem to the terminal; indicates to the terminal that an incoming call is present. The terminal causes the modem to answer the phone by carrying DTR true while RI is active.
23		Not used.
24	TxC	TRANSMIT CLOCK (DTE). Input to modem from terminal; same function as TxC on pin 15.
25	BSY	BUSY. Input to modem from terminal. A positive EIA signal applied to this pin causes the modem to go off-hook and make the associated phone busy.

E

Levels of Implementation

There are several levels of conformance that may be appropriate for typical EIA-232-D interconnections. The bare minimum requirement is the two data lines and a ground. The full implementation of EIA-232-D requires 12 lines; it accommodates:

- ❑ Automatic dialing
- ❑ Automatic answering
- ❑ Synchronous transmission

A middle-of-the-road approach is illustrated in [Figure E-1](#).

Signal Adaptations

E

One set of handshaking signals frequently implemented are RTS and CTS. CTS is used in many systems to inhibit transmission until the signal is high. In the modem application, RTS is turned around and returned as CTS after 150 microseconds. RTS is programmable in some systems to work with the older type 202 modem (half duplex). CTS is used in some systems to provide flow control to avoid buffer overflow. This is not possible if modems are used. It is usually necessary to make CTS high by connecting it to RTS or to some source of +12 volts such as the resistors shown in [Figure E-1](#). CTS is also frequently jumpered to an MC1488 gate which has its inputs grounded (the gate is provided for this purpose).

Another signal used in many systems is DCD. The original purpose of this signal was to inform the system that the carrier tone from the distant modem was being received. This signal is frequently used by the software to display a message such as `CARRIER NOT PRESENT` to help the user diagnose failure to communicate. Obviously, if the system is designed properly to use this signal and is not connected to a modem, the signal must be provided by a pullup resistor or gate as described above (see [Figure E-1](#)).

Many modems expect a DTR high signal and issue a DSR response. These signals are used by software to help prompt the operator about possible causes of trouble. The DTR signal is sometimes used to disconnect the phone circuit in preparation for another automatic call. These signals are necessary in order to communicate with all possible modems (see [Figure E-1](#)).

Sample Configurations

[Figure E-1](#) is a good middle-of-the-road configuration that almost always works. If the CTS and DCD signals are not received from the modem, the jumpers can be moved to artificially provide the needed signal.

E

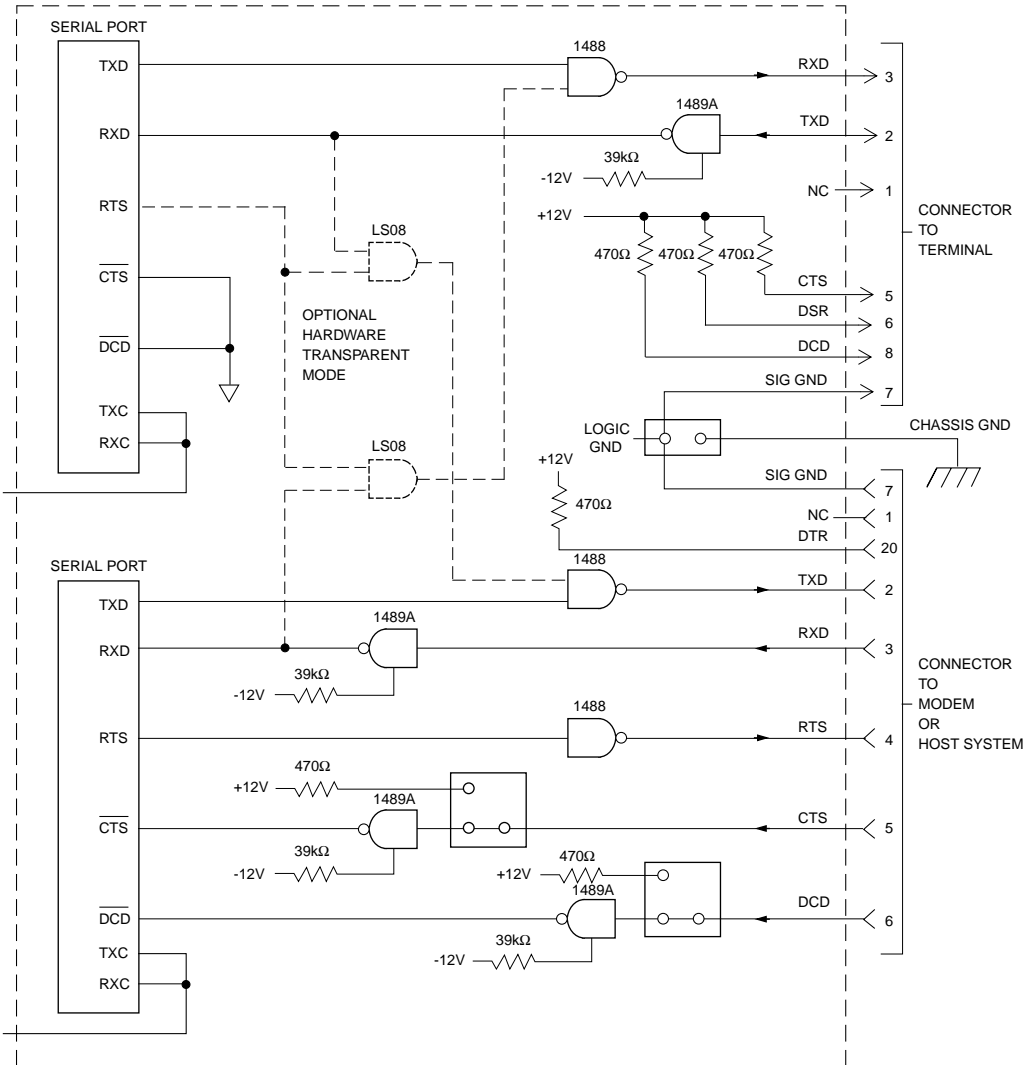

cb181 9210

Figure E-1. Middle-of-the-Road EIA-232-D Configuration

Figure E-2 shows a way of wiring an EIA-232-D connector to enable a computer to connect to a basic terminal with only three lines. This is feasible because most terminals have DTR and RTS signals that are ON, and which can be used to pull up the CTS, DCD, and DSR signals.

Two of these connectors wired back-to-back can be used. In this implementation, however, diagnostic messages that might otherwise be generated do not occur because all the handshaking is bypassed. In addition, the TX and RX lines may have to be crossed since TX from a terminal is outgoing but the TX line on a modem is an incoming signal.

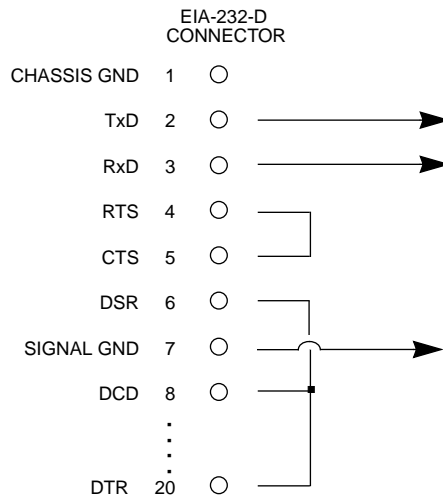

Figure E-2. Minimum EIA-232-D Connection

Proper Grounding

Another subject to consider is the use of ground pins. There are two pins labeled GND. Pin 7 is the SIGNAL GROUND and must be connected to the distant device to complete the circuit. Pin 1 is the CHASSIS GROUND, but it must be used with care. The chassis is connected to the power ground through the green wire in the power cord and must be connected to the chassis to be in compliance with the electrical code.

The problem is that when units are connected to different electrical outlets, there may be several volts of difference in ground potential. If pin 1 of each device is interconnected with the others via cable, several amperes of current could result. This condition may not only be dangerous for the small wires in a typical cable, but may also produce electrical noise that causes errors in data transmission. That is why [Figure E-1](#) shows no connection for pin 1.

Normally, pin 7 should only be connected to the CHASSIS GROUND at one point; if several terminals are used with one computer, the logical place for that point is at the computer. The terminals should not have a connection between the logic ground return and the chassis.

E

Symbols

#496 system calls 4-16

+12V LED 2-11

Numerics

100 ns SRAMs 2-13

187Bug

debugger command set 5-15

firmware in EPROMs 2-4

implementation 4-4

see also debug monitor and
MVME187Bug

stack 4-5

vector table and workspace 5-10

27C102JK type EPROM 2-13

44-pin PLCC/CLCC EPROM 2-13

5-1/4 DS/DD 96 TPI floppy drive B-2

53C710 (SCSI Controller) 2-22

82596CA 2-12, 2-21

see also Ethernet and LAN

96-position DIN connectors 2-7

A

abort 4-10

ABORT switch 2-11

adapter board and transition module installation 3-20

adapters 2-7

additional manuals for the MVME187 board 1-6

address 5-4

as a parameter 5-5

formats 5-6

address resolution protocol (ARP) 4-20

applicable Non-Motorola Publications 1-9

arguments 5-3

arithmetic operators 5-4

ASCII string 5-4

assembler/disassembler 4-2, 5-8

assertion and negation conventions 1-3

autoboot 4-6

B

backplane power connections 3-27

Backus-Naur 5-3

base and top addresses 5-7

base identifier 5-4

Battery Backed Up RAM (BBRAM) and clock 2-17

see also MK48T08 and NVRAM

BH (Bootstrap and Halt) 4-16

big-endian byte ordering 1-3

binary number 1-2

bit value descriptions 1-4

block diagram 2-7

blocks versus sectors 4-14

BO (Bootstrap Operating System) 4-15

board

information block A-1

level hardware description 2-1

level overview 2-7

select value 4-24

boldface string 5-3

Boot PROM 4-19

booting 187Bug 4-5

- BOOTP
 - address determination and bootfile selection 4-20
 - protocol module 4-20
- Bootstrap
 - and Halt (BH) 4-16
 - Operating System (BO) 4-15
 - Protocol (BOOTP) 4-20
- braces 5-3
- break 4-11
- BREAK key 4-11
- breakpoint and tracing capabilities 4-2
- breakpoint during execution of the user program 5-2
- bug operational parameters A-3
- byte
 - definition 1-3
 - ordering 1-3
- C**
- C programming language 4-4
- cable(s) 3-20
- calling system utilities from user programs 5-9
- card slot selection 3-15
- CCS
 - (SCSI Common Command Set) B-2
- CD2401 Serial Controller Chip (SCC) 2-18, 3-21
- change clock speed D-5
- changing parameter table 4-18
- character input/output 5-9
- chassis ground E-7
- chassis preparation 3-15
- checksum A-2
 - precautions 4-4
- CLCC (EPROM) 2-13
- Clear To Send (CTS) 3-22
- clock speed calculation failure 4-12
- CLUN (controller LUN) B-2, C-1
- CLUN/DLUN combinations 4-15
- command
 - descriptions 5-4
 - facilities 4-2
 - identifier 5-3
 - line 5-1
 - command parameters IOT B-4
 - commands
 - diagnostic utilities 4-26
 - commands/prefixes, diagnostic monitor 4-25
 - comparison with M68000-based firmware 4-4
 - confidence test failure 4-12
 - configuration, default disk/tape controller B-2
 - configuration, hardware 3-8
 - Configure (CNFG) and Environment (ENV) commands A-1
 - Configure Board Information Block (CNFG) A-1
 - connector P2 5-8
 - connectors 2-7
 - console port 5-7
 - console terminal D-1
 - control
 - addressing modes 5-5
 - and status bit definitions 1-4
 - bit 1-4
 - controller B-1
 - command packets 4-16
 - LUN (CLUN) B-2, C-1
 - converting protocol addresses to local area network addresses 4-20
 - count 5-4
 - CPU Register *Rnn* 5-6
 - CPU/MPU registers 5-11
 - CR20 5-11
 - creating a program with the assembler/disassembler 5-8
 - CTS (Clear To Send) 3-22
 - CTS/RTS E-4

D

- Dallas DS1210S 2-14
- data and address
 - parameter numeric format 1-2
 - size definitions 1-3
- data bus structure 2-12
- data circuit-terminating equipment (DCE) E-1
- data terminal equipment (DTE) E-1
- DCE (data circuit-terminating equipment) E-1
- debug monitor 3-14
 - see also* 187Bug and MVME187Bug
- debug port 5-7
- debugger 3-9
 - commands 5-15
 - directories 4-3
 - general information 4-1
 - prompt 5-1
 - setup/operation parameters stored in ROM 3-9
- decimal number 1-2
- default
 - 187Bug controller and device parameters 4-17
 - baud rate 3-21
- delimiter 5-4
- description of 187Bug 4-2
- device
 - descriptor table 4-15
 - LUN (DLUN) B-2, C-1
 - probe function 4-14
- diagnostic directories 4-3
- diagnostic facilities 4-25
- diagnostics
 - monitor commands/prefixes 4-25
 - utilities 4-26
- direct access device B-2, B-3
- disk
 - I/O
 - error codes 4-18

- support 4-13
 - via 187Bug commands 4-15
 - via 187Bug system calls 4-16
 - support facilities 4-13
- disk/tape
 - controller
 - default configurations B-2
 - controller modules B-1
 - diskless client 4-20
 - diskless remote node 4-19
 - display of memory 4-2
 - DLUN (device LUN) B-2, C-1
 - document set for MVME187-0xx board 1-5
- documentation
 - available non-Motorola publications
 - bundle 1-7
- double precision real 5-13
- downloading an S-record object file 5-8
- DRAM (dynamic RAM) 2-15
 - addressing 3-27
 - base address 3-27
 - mezzanine boards 2-2
 - mixed parity 2-16
 - programming considerations 2-16
- DTE (data terminal equipment) E-1
- dynamic RAM (DRAM) 2-15

E

- EIA-232-D 2-3, 2-19
 - interconnections E-1, E-2
 - middle-of-the-road configuration E-5
 - minimum connection E-6
 - port(s) 3-21, 5-11
 - standard E-1
- entering and debugging programs 5-8
- entering debugger command lines 5-1
- ENV command parameters A-4
- Environment (ENV) and Configure (CNFG) commands A-1

environmental parameters 3-25
 EPROM(s) 2-13, 2-25, 3-7, 3-14, 4-4, 5-10
 socket installation 3-7
 socket orientation 3-7
 user-programmed 3-7
 ESDI Winchester hard drive B-2
 Ethernet C-1
 address, when to change D-5
 interface 2-21
 LAN (+12vdc) fuse 3-28
 see also 82596CA and LAN
 station address 2-21
 transceiver interface 2-3
 evaluation of an expression 5-5
 Examine and/or change environmental parameters 3-25
 exception vectors used by 187Bug 5-11
 exponent field 5-12
 expression 5-4
 expression as a parameter 5-4
 extended addressing 3-27
 external connections 3-22

F

factory debugger environment D-1
 FAIL LED 2-11
 features of the MVME187 RISC Single Board Computer 2-4
 flexible diskette B-2
 floating point
 data types 5-12
 decimal number 5-14
 instructions 5-11
 SFU (special function unit) 5-14
 support 5-11
 floppy disk B-3
 command parameters B-4
 floppy drive B-2, B-3
 flow control D-2
 four-byte 1-3
 front panel
 LEDs 2-11

 switches 2-11
 functional description 2-10
 fuse F1 3-29
 fuse F2 3-28

G

GCSR (Global Control and Status Registers) 3-28, 4-24
 location monitor register 3-28
 method 4-24
 general purpose readable jumpers on header J1 3-8
 global bus timeout 3-27
 Global Control and Status Registers (GCSR) 3-28, 4-21, 4-24
 grounding E-7
 group select value 4-24

H

half duplex E-4
 handshaking 3-22, E-1, E-4
 hard disk drive B-2
 hardware
 diagnostics 4-25
 functions 5-11
 interrupts 2-23
 preparation 3-5
 preparation and installation 3-1
 headers 3-8
 hexadecimal character 1-2
 host port 5-7
 host system 5-8

I

I/O interfaces 2-18
 installation and startup 4-6
 Integer Data Types 5-12
 Intel 82596 LAN Coprocessor Ethernet driver 4-19
 interconnections
 EIA-232-D E-1
 implementation E-3

- sample configurations E-4
- internal
 - SCSI connections 3-18
 - serial port connections 3-18
- Internet Protocol (IP) 4-19
- Internet User Datagram Protocol (UDP) 4-20
- interrupt(s) 2-23
- IOC (I/O Control) 4-15
- IOI (Input/Output Inquiry) 4-15
- IOP (Physical I/O to Disk) 4-15
- IOT
 - command parameters B-4
 - command parameters for supported floppy types B-4
- IOT (I/O teach)
- isolating defects D-5
- italic strings 5-3

J

- J1 3-8, 3-9
- J2 3-8, 3-10
- J6 3-11, 3-12
- J7 3-11, 3-13
- J8 3-11, 3-13
- jumpers 3-8

K

- keyboard control 4-3

L

- LAN (local area network) 2-21
 - LED 2-11
 - see also* 82596CA and Ethernet transceiver 3-28
- LCSR (Local Control and Status Registers) 3-8
- LEDs 2-11
- loading and executing user programs 4-2
- local
 - bus arbitration 2-12
 - floppy drive B-3

- I/O devices memory map 2-26
- memory configuration status 4-12
- resources 2-23
- local bus 2-23
 - arbitration 2-12
 - memory map 2-24, 2-25
 - timeout 2-23
 - to VMEbus interface 2-18
- Local Control and Status Registers (LCSR) 4-24
- location monitors 3-28
- logical block 4-14

M

- M88000 firmware 4-1
- M88000 MPU 2-12
- mantissa field 5-12
- manual terminology 1-2
- MC88100 exception vectors 5-11
- MC88100 TRAP instructions 5-9
- MC88200 or MC88204 CMMUs 5-11
- MCECC memory controller ASIC 2-10
- MEMC040 memory controller ASIC 2-10
- memory
 - address ranges 3-27
 - maps 2-24
 - local bus 2-24
 - local I/O devices 2-26
 - VMEbus 2-28
 - VMEbus short I/O 2-28
 - requirements 4-5
- Memory Modify (MM) 5-8
- metasymbols 5-3
- mezzanine module 2-2
 - on 25 MHz main boards 2-2
- mezzanines, stacking 2-16
- mixed parity 2-16
- modem(s) E-1
- modifying memory 4-2
- Motorola-style byte ordering 1-3

- move files between machines on different networks 4-20
 - MPAR (Multiprocessor Access Register) 4-22
 - MPCR (Multiprocessor Control Register)
 - method 4-21
 - status codes 4-22
 - MPU clock speed calculation 4-12
 - MPU register CR20 5-11
 - multiple module cage configuration 3-28
 - Multiprocessor Address Register (MPAR) 4-22
 - Multiprocessor Control Register (MPCR) 4-21
 - method 4-21
 - multiprocessor support 4-21
 - MVME187 2-1, C-1
 - block diagram 2-7
 - specifications 2-6
 - MVME187Bug debugging package
 - see also* 187Bug and debug monitor 1-3, 3-14
 - MVME320 - Winchester/Floppy Controller B-1
 - MVME323 - ESDI Winchester Controller B-1, B-2
 - MVME327A - SCSI Controller B-1, B-3
 - MVME328 - SCSI Controller B-1, B-3
 - MVME350 - Streaming Tape Controller B-1, B-4
 - MVME374 C-2
 - MVME376 C-1
 - MVME712-12 2-8, 3-17
 - MVME712-13 2-8, 3-17
 - MVME712A 2-8, 3-17
 - MVME712AM 2-8, 3-17
 - MVME712B 2-8, 3-17
 - MVME712M 2-8, 3-11, 3-17
 - MVME712X 2-8, 3-17
- N**
- negation 1-3
- network**
- controller data C-1
 - controller modules supported C-1
 - I/O error codes 4-21
 - I/O support 4-19
 - identify 4-19
 - network (local Ethernet interface) as a boot device 4-19
 - network boot 4-8
 - control module 4-20
 - firmware 4-19
 - no display D-1
 - normal address range 2-24
 - numeric value 5-4
 - NVRAM (Non-Volatile RAM)
 - checksum error 4-12
 - low battery condition 4-12
- O**
- object code 5-8
 - offset registers 5-7
 - onboard
 - DRAM 2-15
 - memory 2-2
 - selftest D-5
 - operating environment 5-10
 - operation parameters of the hardware A-1
 - operational parameters A-3
 - operator precedence 5-5
 - option field 5-3
 - option modification 3-5
 - optional SRAM battery backup 2-14
 - overview of M88000 firmware 4-1
 - overview of startup procedure 3-2
- P**
- P1 2-7
 - P2 2-7
 - P2 adapter board 2-7, 3-20, 3-29
 - packed decimal number 5-14
 - parallel (printer) port 2-3

parallel port interface 2-20
parameter tables 4-13, 4-18
parity mezzanines 2-2
parity modules 2-2
patching programs 4-2
PCCchip2 ASIC 2-9
peripheral
 connection procedures 3-21
PLCC (EPROM) 2-13
port 0 or 00 5-7
port 1 or 01 5-7
port number(s) 5-3, 5-7
power sources 2-14
preserving the debugger operating environment 5-10
primary and secondary power source support 2-14
priority
 82596CA LAN (highest) 2-12
 of local bus masters 2-12
 type arbiter 2-12
programmable EPROM features 2-13
programmable tick timers 2-23
programming the PPCchip2 and VMEchip2 3-26
proper grounding E-7
Pseudo Stack Pointer (R31) 4-5
pseudo-registers 5-7
publications
 applicable Motorola 1-6
 Non-Motorola 1-9
 not included in the set 1-6

Q

QIC-02 streaming tape drive B-4
qualifier 5-6

R

RAM 5-10
range 5-4
RARP 4-20
RARP/ARP protocol modules 4-20

read files from/to a remote server 4-20
reading a program from disk 5-9
related documentation 1-5
relative address+offset 5-7
Remote Start Switch Method 4-21
rendering the debugger unusable 1-3
reset 4-10
RESET switch 2-11
restarting 187Bug 4-5
restarting the system 4-9
Reverse Address Resolution Protocol (RARP) 4-20
RFI 3-16
RISC Single Board Computer (SBC) B-1
ROMboot 4-7
RTC (real-time clock) 3-25
 initialization 3-25
 power save mode 3-29
RTS/CTS E-4
RTXC4 (Receive Transmit Clock 4) 3-11, 3-14
RUN LED 2-11

S

SBC B-1
 see also RISC Single Board Computer
SCC (Serial Controller Chip) 2-18
 see also CD2401
scientific notation 5-14
SCON LED 2-11
SCSI
 bus termination 3-29
 Common Command Set (CCS) B-2, B-3
 controller (53C710) 2-22
 interface 2-22
 internal connections 3-18
 LED 2-11
 mass storage interface 2-2
 specification 1-9
 termination 2-22
 terminator power 3-29

- SCSI commands
 - Inquiry 4-14
 - Mode Sense 4-14
- sector size 4-14
- selftest error 4-12
- sequential access device B-2, B-3
- Serial Controller Chip (SCC)
 - see also* CD2401
- serial port 1 5-8
- serial port 2 5-8
- serial port 4 clock configuration select headers J7 and J8 3-11
- serial port interface 2-18
- serial ports 2-3
- Set Environment to Bug/Operating System (ENV) A-3
- settings for
 - J1 general purpose readable jumpers 3-9
 - J2 system controller header 3-10
 - J6 SRAM optional backup power select header 3-12
 - J7 and J8 serial port 4 clock configuration select headers 3-13
- setup/operation parameters
 - default
 - in NVRAM 3-9
- SFU (special function unit) 5-11, 5-14
- shared RAM 4-21
- shielded cables 3-17
- sign field 5-12
- signal
 - adaptations E-4
 - ground E-7
 - levels E-1
 - name conventions 1-2
 - edge significant 1-2
 - level significant 1-2
- Single Board Computer (SBC)
 - see also* RISC Single Board Computer
- single precision real 5-13
- small-endian byte ordering 1-3
- software-programmable hardware interrupts 2-23
- source line 5-8
- special function unit (SFU) 5-11
- specifications 2-6
- square brackets 5-3
- SRAM (static RAM) 2-13
- SRAM backup power source select header J6 3-11, 3-12
- S-record format 5-8
- stacking mezzanines 2-16
- standards requirements 2-6
- startup procedure overview 3-2
- static RAM (SRAM) 2-13
- static variable space 4-5
- status bit 1-4
- status codes (MPCR) 4-22
- storage and the real-time clock 3-29
- streaming tape drive B-4
 - see also* QIC-2 streaming tape drive
- string literal 5-5
- supervisor address space 5-6
- supported controllers 4-13
- switches 2-11
- syntactic variables 5-4
- SYSFAIL* assertion/negation 4-12
- system
 - considerations 3-27
 - console 3-21, D-1
 - controller 3-10
 - controller function 3-14
 - controller header 3-10
 - controller header J2 3-8
 - fail (SYSFAIL*) 4-7
 - reset 4-10
 - startup overview 3-24
- system calls
 - see also* disk I/O via 187Bug system calls
- system calls <singlepage> 4-16

T

- terminal input/output control 4-13, 5-1
- terminal(s) E-1
- TFTP protocol module 4-20
- tick timers 2-23
- timeout 2-23
- tracing capabilities 4-2
- transfer type (TT) 2-24
- transition boards supported by MVME187 2-8
- transition module installation 3-20
- translation table 5-10
- translation through the Memory Management Units (MMUs) 5-10
- TRAP #496 4-16, 5-9
 - calls, and default controller addresses B-1
 - function ".RETURN" 5-2
- trap exception commands 4-2
- Trivial File Transfer Protocol (TFTP) 4-20
- troubleshooting steps D-1
- true/false bit state definitions 1-4
- TRXC4 (Transmit Receive Clock 4) 3-11, 3-14
- TT (transfer type) 2-24
- two-byte 1-3

U

- UDP/IP protocol modules 4-19
- unpacking instructions 3-1
- unusable debugger and small-endian byte ordering 1-3
- user address space 5-6
- User Datagram Protocol 4-19
- user-customized environments D-1
- using local SRAM for work space J6 3-9
- using the 187Bug debugger 5-1

V

- vector table 5-10
- verify the NVRAM (BDRAM) parameters 3-25

- vertical bar 5-3
- VME LED 2-11
- VMEbus
 - accesses to the local bus 2-28
 - interface 2-18
 - memory map 2-28
 - short I/O memory map 2-28
 - short I/O space 4-24
 - specification 1-9
- VMEchip2
 - ASIC 2-9
 - LCSR (Local Control and Status Registers) 3-8
 - LM/SIG register 4-24

W

- watchdog timer 2-23
- whoami packet 4-20
- Winchester hard drive B-2
- work page 3-9
- write files from/to a remote server 4-20

X

- XON/XOFF 3-22