



PROFESSIONAL DIGITAL TWO-WAY RADIO

MOTOTRBO™ SL7550 PORTABLE USER GUIDE

Declaration of Conformity

This declaration is applicable to your radio **only** if your radio is labeled with the FCC logo shown below.

DECLARATION OF CONFORMITY

Per FCC CFR 47 Part 2 Section 2.1077(a)



Responsible Party

Name: Motorola Solutions, Inc.

Address: 1303 East Algonquin Road, Schaumburg, IL 60196, U.S.A.

Phone Number: 1-800-927-2744

Hereby declares that the product:

Model Name: **SL 7550**

conforms to the following regulations:

FCC Part 15, subpart B, section 15.107(a), 15.107(d) and section 15.109(a)

Class B Digital Device

As a personal computer peripheral, this device complies with Part 15 of the FCC Rules. Operation is subject to the following two conditions:

1. This device may not cause harmful interference, and
2. This device must accept any interference received, including interference that may cause undesired operation.

Note: This equipment has been tested and found to comply with the limits for a Class B digital device, pursuant to part 15 of the FCC Rules. These limits are designed to provide reasonable protection against harmful interference in a residential installation. This equipment generates, uses and can radiate radio frequency energy and, if not installed and used in accordance with the instructions, may cause harmful interference to radio communications. However, there is no guarantee that interference will not occur in a particular installation.

If this equipment does cause harmful interference to radio or television reception, which can be determined by turning the equipment off and on, the user is encouraged to try to correct the interference by one or more of the following measures:

- Reorient or relocate the receiving antenna.
- Increase the separation between the equipment and receiver.
- Connect the equipment into an outlet on a circuit different from that to which the receiver is connected.
- Consult the dealer or an experienced radio/TV technician for help.

Contents

This User Guide contains all the information you need to use the MOTOTRBO SL7550 Portable Radios.

| | |
|--------------------------------------------------------------------------------|-------------|
| Important Safety Information | vi |
| Product Safety and RF Exposure Compliance | vi |
| Firmware Version | vi |
| Computer Software Copyrights | vii |
| Open Source Software Legal Notices | vii |
| Handling Precautions | viii |
| RF Energy Exposure and Product Safety Guidelines and Instructions | viii |
| Operating Precautions | ix |
| Getting Started | 1 |
| How to Use This Guide | 1 |
| What Your Dealer/System Administrator Can Tell You | 1 |
| Preparing Your Radio for Use | 2 |
| Attaching the Battery | 2 |
| Charging the Battery | 3 |
| Attaching the Earpiece/Audio Accessory | 4 |
| Powering Up the Radio | 4 |

| | |
|------------------------------------------------|-----------|
| Adjusting the Volume | 5 |
| Identifying Radio Controls | 6 |
| Radio Controls | 6 |
| Programmable Buttons | 7 |
| Assignable Radio Functions | 8 |
| Assignable Settings or Utility Functions | 9 |
| Using the 4-Way Navigation Disc | 9 |
| Accessing the Programmed Functions | 10 |
| Using the Keypad | 11 |
| Push-To-Talk (PTT) Button | 12 |
| Capacity Plus | 13 |
| Identifying Status Indicators | 14 |
| Display Icons | 14 |
| Call Icons | 16 |
| Utilities Icons | 16 |
| Mini Notice Icons | 17 |
| Sent Item Icons | 17 |
| Job Tickets Icons | 18 |
| LED Indicator | 18 |
| Audio Tones | 19 |
| Indicator Tones | 20 |
| Making and Receiving Calls | 21 |
| Selecting a Zone | 21 |
| Selecting a Channel | 22 |

| | | | |
|-----------------------------------------------------------------------------------|-----------|---------------------------------------------------------------------------------|----|
| Receiving and Responding to a Radio Call | 23 | Editing the Scan List | 37 |
| Receiving and Responding to a Group Call | 23 | Adding a New Entry to the Scan List | 37 |
| Receiving and Responding to a Private Call | 24 | Deleting an Entry from the Scan List | 37 |
| Receiving an All Call | 24 | Setting and Editing Priority for an Entry in the Scan List | 38 |
| Making a Radio Call | 25 | Scan | 39 |
| Making a Group Call with the PTT Button | 26 | Setting an Active Scan List | 39 |
| Making a Private Call with the PTT Button | 26 | Starting and Stopping Scan | 40 |
| Making an All Call | 27 | Responding to a Transmission During a Scan | 40 |
| Making a Group or Private Call with the One Touch Access Button | 28 | Deleting a Nuisance Channel | 40 |
| Making a Group, Private or All Call with the Programmable Number Key | 28 | Restoring a Nuisance Channel | 41 |
| Stopping a Radio Call | 30 | Contacts Settings | 41 |
| Talkaround | 30 | Making a Group Call from Contacts | 42 |
| Monitoring Features | 31 | Making a Private Call from Contacts | 42 |
| Monitoring a Channel | 31 | Making a Call by Alias Search | 43 |
| Sticky Monitor | 32 | Assigning an Entry to a Programmable Number Key | 44 |
| Advanced Features | 33 | Removing the Association between Entry and Programmable Number Key | 45 |
| Radio Check | 33 | Adding a New Contact | 45 |
| Sending a Radio Check | 33 | Sending a Message to a Contact | 46 |
| Remote Monitor | 35 | Call Indicator Settings | 46 |
| Initiating Remote Monitor | 35 | Activating and Deactivating Call Ringers for Call Alert | 46 |
| Scan Lists | 36 | Activating and Deactivating Call Ringers for | |
| Viewing an Entry in the Scan List | 36 | | |
| Viewing an Entry in the Scan List by Alias Search | 36 | | |

| | | | |
|--------------------------------------------------------------------|----|------------------------------------------------------------------------|----|
| Private Calls | 47 | Exiting Emergency Mode | 57 |
| Activating and Deactivating Call Ringers for Text Message | 47 | Text Message Features | 58 |
| Assigning Ring Styles | 48 | Writing and Sending a Text Message | 58 |
| Ring Alert Type Selection | 48 | Sending a Quick Text Message | 59 |
| Escalating Alarm Tone Volume | 49 | Sending a Quick Text Message with the One Touch Access Button | 59 |
| Call Log Features | 49 | Accessing the Drafts Folder | 60 |
| Viewing Recent Calls | 49 | Viewing a Saved Text Message | 60 |
| Missed Calls | 50 | Editing and Sending a Saved Text Message .. | 60 |
| Storing an Alias or ID from a Call List | 50 | Deleting a Saved Text Message from Drafts .. | 61 |
| Deleting a Call from a Call List | 50 | Managing Fail-to-Send Text Messages | 61 |
| Viewing Details from a Call List | 51 | Resending a Text Message | 62 |
| Call Alert Operation | 51 | Forwarding a Text Message | 62 |
| Receiving and Responding to a Call Alert | 51 | Editing a Text Message | 62 |
| Making a Call Alert from the Contacts List | 52 | Managing Sent Text Messages | 63 |
| Making a Call Alert with the One Touch Access Button | 52 | Viewing a Sent Text Message | 63 |
| Emergency Operation | 53 | Sending a Sent Text Message | 63 |
| Receiving an Emergency Alarm | 53 | Deleting All Sent Text Messages from Sent Items | 65 |
| Responding to an Emergency Alarm | 54 | Receiving a Text Message | 65 |
| Sending an Emergency Alarm | 54 | Reading a Text Message | 65 |
| Sending an Emergency Alarm with Call | 55 | Managing Received Text Messages | 65 |
| Sending an Emergency Alarm with Voice to Follow | 56 | Viewing a Text Message from the Inbox | 66 |
| Reinitiating an Emergency Mode | 57 | Replying to a Text Message from the Inbox .. | 66 |
| | | Deleting a Text Message from the Inbox | 67 |
| | | Deleting All Text Messages from the Inbox .. | 67 |

| | | | |
|--------------------------------------------------------|----|-------------------------------------------------------------------------------|----|
| Job Tickets | 68 | Disconnecting from a Bluetooth Device | 81 |
| Accessing the Job Ticket Folder | 68 | Switching Audio Route | 81 |
| Responding to the Job Ticket | 68 | Viewing Device Details | 81 |
| Deleting a Job Ticket | 69 | Editing Device Name | 82 |
| Privacy | 70 | Notification List | 82 |
| Covert Mode | 71 | Accessing the Notification List | 82 |
| Entering Covert Mode | 71 | Utilities | 83 |
| Exiting Covert Mode | 71 | Turning the Radio Tones/Alerts On or Off | 83 |
| Dual Tone Multi Frequency (DTMF) | 71 | Turning Keypad Tones On or Off | 83 |
| IP Site Connect | 72 | Setting the Tone Alert Volume Offset Level | 84 |
| Locking Automatic Site Search | 72 | Turning the Talk Permit Tone On or Off | 84 |
| Unlocking Automatic Site Search | 73 | Changing the Display Mode | 85 |
| Starting a Manual Site Search | 73 | Adjusting the Display Brightness | 85 |
| Security | 74 | Controlling the Display Backlight | 86 |
| Radio Disable | 74 | Wallpaper Mode | 86 |
| Radio Enable | 75 | Screen Saver Mode | 86 |
| Lone Worker | 76 | Audio Accessory | 87 |
| Password Lock Features | 77 | Locking and Unlocking the Keypad | 87 |
| Accessing the Radio from Password | 77 | Auto Keypad Lock | 88 |
| Unlocking the Radio from Locked State | 77 | Language | 88 |
| Turning the Password Lock On or Off | 78 | Turning the LED Indicator On or Off | 88 |
| Changing the Password | 78 | Turning the Voice Operating Transmission (VOX) Feature On or Off | 89 |
| Bluetooth Operation | 79 | Turning the Option Board Feature(s) On or Off | 90 |
| Turning Bluetooth On and Off | 80 | Identifying Cable Type | 90 |
| Finding and Connecting to a Bluetooth Device | 80 | | |

| | |
|-------------------------------------------------------------|-----------|
| Voice Announcement | 90 |
| Menu Timer | 91 |
| Digital Mic AGC | 91 |
| Intelligent Audio | 91 |
| Accessing General Radio Information | 92 |
| Accessing the Battery Information | 92 |
| Checking the Radio Alias and ID | 93 |
| Checking the Firmware Version and Codeplug Version | 93 |
| Checking the Open-Source Software Information | 93 |
| Batteries and Chargers Warranty | 95 |
| Limited Warranty | 96 |

Important Safety Information

Product Safety and RF Exposure Compliance



Caution

Before using this product, read the operating instructions for safe usage contained in the Product Safety and RF Exposure booklet enclosed with your radio.

ATTENTION!

This radio is restricted to occupational use only to satisfy FCC/ICNIRP RF energy exposure requirements. Before using this product, read the RF energy awareness information and operating instructions in the Product Safety and RF Exposure booklet enclosed with your radio (Motorola Publication part number 6881095C98) to ensure compliance with RF energy exposure limits.

For a list of Motorola-approved antennas, batteries, and other accessories, visit the following website:

<http://www.motorolasolutions.com/governmentandenterprise>

Any modification to this device, not expressly authorized by Motorola, may void the user's authority to operate this device.

Under Industry Canada regulations, this radio transmitter may only operate using an antenna of a type and maximum (or lesser) gain approved for the transmitter by Industry Canada. To reduce potential radio interference to other users, the antenna type and its gain should be so chosen that the equivalent isotropically radiated power (e.i.r.p.) is not more than that necessary for successful communication

Firmware Version

All the features described in the following sections are supported by the radio's firmware version **R02.02.00** or later.

See ***Checking the Firmware Version and Codeplug Version*** on page 93 to determine your radio's firmware version.

Check with your dealer or system administrator for more details of all the features supported.

Computer Software Copyrights

The Motorola products described in this manual may include copyrighted Motorola computer programs stored in semiconductor memories or other media. Laws in the United States and other countries preserve for Motorola certain exclusive rights for copyrighted computer programs including, but not limited to, the exclusive right to copy or reproduce in any form the copyrighted computer program. Accordingly, any copyrighted Motorola computer programs contained in the Motorola products described in this manual may not be copied, reproduced, modified, reverse-engineered, or distributed in any manner without the express written permission of Motorola. Furthermore, the purchase of Motorola products shall not be deemed to grant either directly or by implication, estoppel, or otherwise, any license under the copyrights, patents or patent applications of Motorola, except for the normal non-exclusive license to use that arises by operation of law in the sale of a product.

The AMBE+2™ voice coding Technology embodied in this product is protected by intellectual property rights including patent rights, copyrights and trade secrets of Digital Voice Systems, Inc.

This voice coding Technology is licensed solely for use within this Communications Equipment. The user of this Technology is explicitly prohibited from attempting to decompile, reverse engineer, or disassemble the Object Code, or in any other way convert the Object Code into a human-readable form.

U.S. Pat. Nos. #5,870,405, #5,826,222, #5,754,974, #5,701,390, #5,715,365, #5,649,050, #5,630,011, #5,581,656, #5,517,511, #5,491,772, #5,247,579, #5,226,084 and #5,195,166.

Open Source Software Legal Notices

This Motorola Product contains Open Source Software. For information regarding licenses, acknowledgements, required copyright notices, and other usage terms, refer to the Documentation for this Motorola Product at:

<http://www.motorola.com/businessonline>

Handling Precautions

The MOTOTRBO Series Digital Portable radio meets IP54 specifications. Your radio limits protection against dust and water exposure.

- Keep your radio clean and exposure to water should be avoided to help ensure proper functionality and performance.
- To clean the exterior surfaces of the radio, use a diluted solution of mild dishwashing detergent and fresh water (i.e. one teaspoon of detergent to one gallon of water).
- These surfaces should be cleaned whenever a periodic visual inspection reveals the presence of smudges, grease, and/or grime.



Caution

The effects on certain chemicals and their vapors can have harmful results on certain plastics. Avoid using aerosol sprays, tuner cleaners and other chemicals.

RF Energy Exposure and Product Safety Guidelines and Instructions

See more detailed proper usage instructions, warnings and cautions in the Regulatory Compliance and Product Safety Guide.



1To ensure a comfortable audio level and compliance with RF energy exposure limits, do not hold against the ear or alongside the head.



2Use only in front of the face or with Motorola Solutions approved audio accessories and carry cases to ensure compliance with RF energy exposure limits.

Operating Precautions

- Transmit no more than the rated duty factor of 50% of the time. To transmit (talk), push the Push-To-Talk (PTT) button. To receive calls, release the PTT button. Transmitting 50% of the time, or less, is important because this radio generates measurable RF energy exposure only when transmitting (in terms of measuring for standards compliance).
- To protect your hearing, use the lowest volume necessary to do your job, turn down the volume before adding a headset or earpiece, and limit the amount of time you use headsets or earpieces at high volume.
- User awareness instructions should accompany device when transferred to other users.

NOTE: For more details please read the information about RF Energy Exposure Awareness and Control Information and Operational Instructions for Occupational Use in the Quick Reference Guide/Safety Booklet (Motorola Publications number 68009553001) provided with your radio.

Notes

Notes

X

English

Getting Started

Take a moment to review the following:

| | |
|-----------------------------------------------------------------|--------|
| How to Use This Guide | page 1 |
| What Your Dealer/System Administrator Can Tell You | page 1 |

■ How to Use This Guide

This User Guide covers the basic operation of the MOTOTRBO SL7550 Digital Portable Radios.

However, your dealer or system administrator may have customized your radio for your specific needs. Check with your dealer or system administrator for more information.

Selected features are also available on this single-site trunking mode, Capacity Plus. See **Capacity Plus** on **page 13**.

■ What Your Dealer/System Administrator Can Tell You

You can consult your dealer or system administrator about the following:

- Is your radio programmed with any preset conventional channels?
- Which buttons have been programmed to access other features?
- What optional accessories may suit your needs?
- What are the best radio usage practices for effective communication?
- What maintenance procedures will help promote longer radio life?

Preparing Your Radio for Use

Assemble your radio by following these steps:

- Attaching the Battery page 2
- Charging the Battery page 3
- Attaching the Earpiece/Audio Accessory page 4
- Powering Up the Radio page 4
- Adjusting the Volume page 5

■ Attaching the Battery

Align the battery contacts with the contacts inside the battery compartment. Insert the contact side of the battery first. Gently push the battery into place.

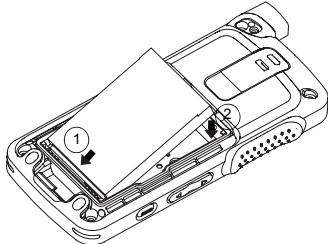

To attach battery cover, align it in place and slide the battery latch until it snaps into place. Slide battery latch into lock position.

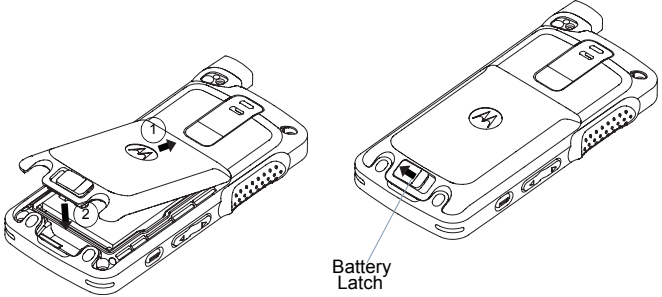

■ Charging the Battery

Your radio is powered by a Lithium-Ion (Li-Ion) battery. To avoid damage and comply with warranty terms, charge the battery using a Motorola charger *exactly* as described in the charger user guide. All chargers can charge only the Motorola authorized batteries. Other batteries may not charge.

Charge a new battery 14 to 16 hours before initial use for best performance. Prior to charging a battery with the radio, it is recommended to turn the radio off. Batteries charge best at room temperature.

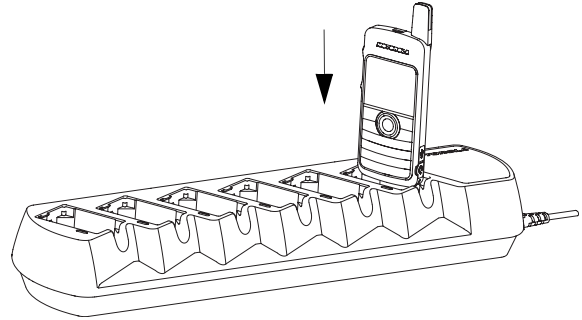
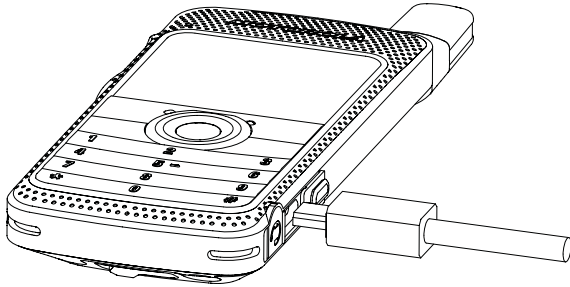

NOTE: The battery charging icon will be displayed until the user unplugs the USB cable or takes the radio out of the charger.

■ Attaching the Earpiece/Audio Accessory

The audio jack is located on the antenna side of the radio. It is used to connect MOTOTRBO SL7550 accessories to the radio.

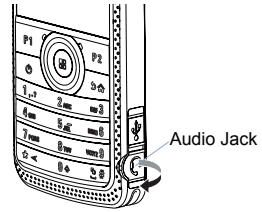

Lift up the flap of the Audio Jack cover. Align the indicators on both the connector and housing, then push until it fits in properly.

Rotate connector clockwise or counterclockwise to lock.

To unlock, rotate until the indicators on both the connector and housing are aligned. Pull out the connector gently to disconnect from radio.

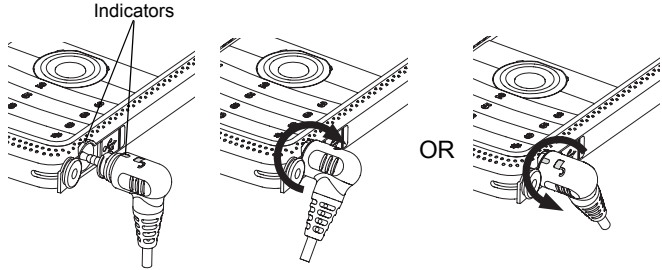

■ Powering Up the Radio

Press the **On/Off** button on the front keypad. You see MOTOTRBO (TM) on the radio's display momentarily, followed by a welcome message or welcome image.

The LED lights up solid green and the Home screen lights up. The backlight depends on the last brightness setting.

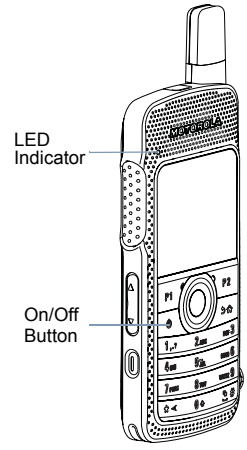

NOTE: Brightness is set via the manual brightness mode or auto brightness is controlled by the radio's photo sensor. The Home screen does not light up during a power up if the LED indicator is disabled (see **Turning the LED Indicator On or Off** on page 88).

A brief tone sounds, indicating that the power up test is successful.

NOTE: There is no power up tone if the radio tones/alerts function is disabled (see **Turning the Radio Tones/ Alerts On or Off** on page 83).

If your radio does not power up, check your battery. Make sure that it is charged and properly attached. If your radio still does not power up, contact your dealer.

*To turn off the radio, press the **On/Off** button again and hold for 2 seconds. You see a brief Powering Down on the radio's display.*

■ Adjusting the Volume

To increase the volume, push the **Volume Button** up.

To decrease the volume, push the Volume Button down.

NOTE: Your radio can be programmed to have a minimum volume offset where the volume level cannot be lowered past the programmed minimum volume. Check with your dealer or system administrator for more information.

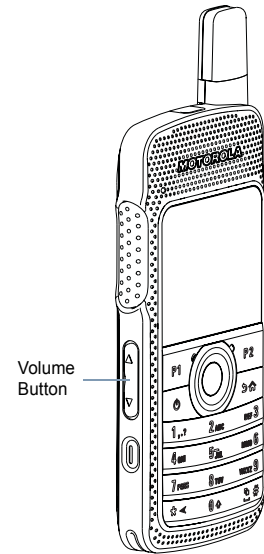

Identifying Radio Controls

Take a moment to review the following:

| | |
|----------------------------------------------|---------|
| Radio Controls | page 6 |
| Programmable Buttons | page 7 |
| Using the 4-Way Navigation Disc | page 9 |
| Accessing the Programmed Functions | page 10 |
| Using the Keypad | page 11 |
| Push-To-Talk (PTT) Button | page 12 |
| Capacity Plus | page 13 |

Radio Controls

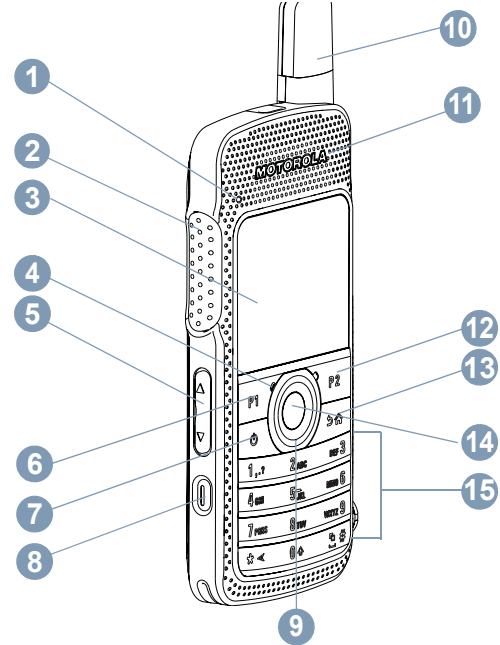

- 1 LED Indicator
- 2 Push-to-Talk (PTT) Button
- 3 Display

- 4 Microphone
- 5 Volume Button
- 6 Front Button P1*
SP: _____ LP: _____
- 7 On/Off Button
- 8 Emergency Button*
- 9 4-way Navigation Disc
- 10 Antenna
- 11 Speaker
- 12 Front Button P2 *
SP: _____ LP: _____
- 13 Back/Home Button
- 14 Menu/OK Button
- 15 Keypad

* These buttons are programmable.

■ Programmable Buttons

Your dealer can program the programmable buttons as shortcuts to **radio functions** or **preset channels/groups** depending on the duration of a button press:

- Short press – Pressing and releasing rapidly (0.05 seconds).
- Long press – Pressing and holding for the programmed duration (between 1.00 second and 3.75 seconds).
- Hold down – Keeping the button pressed.

NOTE: The programmed duration of a button press is applicable for all assignable radio/utility functions or settings. See **Emergency Operation** on page 53 for more information on the programmed duration of the **Emergency** button.

For your convenience, a programmable button can also be customized to support up to 9 of your favorite features. Please consult your dealer for programming options.

Assignable Radio Functions

Actions – A programmable button to access a CPS programmable action list.

Audio Routing – Toggles audio routing between internal radio speaker and external accessory speakers.

Power Battery Indicator – Displays the current status of the battery level.

Bluetooth® Audio Switch – Toggles audio routing between internal radio speaker and external Bluetooth-enabled accessory.

Contacts – Provides direct access to the contacts list.

Call Alert – Direct access to the radio contacts list to select a radio contact to send a call alert to.

Call Log – Selects the call log list.

Channel Announcement – Plays zone and channel announcement voice messages for the current channel.

Display Radio Alias - Shows radio display name.

Emergency – Depending on the programming, initiates or cancels an emergency alarm or call.

Intelligent Audio On/Off – Toggles intelligent audio on or off.

Job Tickets – Allows the user to view and act upon job tickets.

Manual Dial for Private Call – Allows the user to dial a private call manually.

Manual Site Roam* – Starts the manual site search.

Mic AGC On/Off – Toggles the internal microphone automatic gain control (AGC) on or off.

Monitor – Monitors a selected channel for activity.

Notifications – Provides direct access to the Notifications list.

Nuisance Channel Delete* – Temporarily removes an unwanted channel, except for the Selected Channel, from the scan list. The Selected Channel refers to the user's selected zone/channel combination from which scan is initiated.

One Touch Access – Directly initiates a predefined Private or Group Call, a Call Alert or a Quick Text message.

Option Board Feature – Toggles option board feature(s) on or off for option board-enabled channels.

Permanent Monitor* – Monitors a selected channel for all radio traffic until function is disabled.

Privacy – Toggles privacy on or off.

Radio Alias and ID – Provides radio alias and ID.

Radio Check – Determines if a radio is active in a system.

Radio Enable – Allows a target radio to be remotely enabled.

Radio Disable – Allows a target radio to be remotely disabled.

Remote Monitor – Turns on the microphone of a target radio without it giving any indicators.

Repeater/Talkaround* – Toggles between using a repeater and communicating directly with another radio.

** Not applicable in Capacity Plus*

Ring Alert Type – Provides direct access to the Ring Alert Type Setting.

Scan – Toggles scan on or off.

Site Lock On/Off* – Toggles the automatic site roam on or off.

Text Message – Selects the text message menu.

Transmit Interrupt Remote Dekey – Stops the transmission of a remote monitored radio without giving any indicators, or an ongoing interruptible call to free the channel.

Unassigned – Unassigned programmable button.

Voice Announcement On/Off – Toggles voice announcement on or off.

Voice Operating Transmission (VOX) – Toggles VOX on or off.

Zone – Allows selection from a list of zones.

Assignable Settings or Utility Functions

All Tones/Alerts – Toggles all tones and alerts on or off.

Brightness – Allows brightness to be set via the manual brightness mode or auto brightness control via the radio's photo sensor.

Display Mode – Toggles the day/night display mode on or off.

Keypad Lock – Toggles keypad between locked and unlocked.

Wallpaper – Displayed on home screen.

* Not applicable in Capacity Plus

■ Using the 4-Way Navigation Disc

You can use the 4-way navigation disc, , to scroll through options, increase/decrease values, and navigate vertically.

| Category | Direction | |
|----------------|---------------------|--------------------|
| | ▲ or ▼ | ◀ or ▶ |
| Menu | Vertical Navigation | – |
| Lists | Vertical Navigation | – |
| View Details | Vertical Navigation | Previous/Next Item |
| Numeric Values | Increase/Decrease | – |

You can use the 4-way navigation disc, , as a number, alias, or free form text editor.

The  button can be used to change the channels in the home screen.

Press the Menu/OK button to select your desired channel.

| Editor Category | Direction | |
|-----------------|----------------------|---------------------------------------|
| | ▲ or ▼ | ◀ or ▶ |
| Number | – | Left: Delete last digit Right: – |
| Alias | – | Move cursor one character left/right. |
| Free Form Text | Move cursor up/down. | Move cursor one character left/right. |



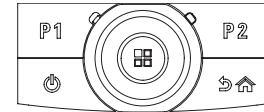

■ Accessing the Programmed Functions

You can access various radio functions through one of the following ways:

- A short or long press of the relevant programmable buttons.















OR

- Use the 4-way navigation disc as follows:
 - 1 To access the menu, press the  button. Press ▲ or ▼ to access the required menu function.
 - 2 Press  to select a function or enter a sub-menu.
 - 3 To go back one menu level, or to return to the previous screen, press the  button. Long press the  button to return to the Home screen.

NOTE: Your radio automatically exits the menu after a period of inactivity and returns to your Home screen.

■ Using the Keypad

You can use the alphanumeric keypad to access your radio's features. You can use the keypad to enter subscriber aliases or IDs, and text messages. Many characters require that you press a key multiple times. The table below shows the number of times a key needs to be pressed to generate the required character.

| Key | Number of Times Key is Pressed | | | | | | | | | | | | |
|-----------------------------------------------------------------------------------|--------------------------------|-------------------------------------------------------------------------------------------------------------------------|---|---|---|---|---|---|---|----|----|----|----|
| | 1 | 2 | 3 | 4 | 5 | 6 | 7 | 8 | 9 | 10 | 11 | 12 | 13 |
|  | 1 | . | , | ? | ! | @ | & | ' | % | - | : | * | # |
|  | A | B | C | 2 | | | | | | | | | |
|  | D | E | F | 3 | | | | | | | | | |
|  | G | H | I | 4 | | | | | | | | | |
|  | J | K | L | 5 | | | | | | | | | |
|  | M | N | O | 6 | | | | | | | | | |
|  | P | Q | R | S | 7 | | | | | | | | |
|  | T | U | V | 8 | | | | | | | | | |
|  | W | X | Y | Z | 9 | | | | | | | | |
|  | 0 | NOTE: Press to enter "0" and long press to activate the CAPS lock. Another long press to turn off the CAPS lock. | | | | | | | | | | | |
|  | * or del | NOTE: Press during text entry to delete the character. Press during numeric entry to enter a "***". | | | | | | | | | | | |
|  | # or space | NOTE: Press during text entry to insert a space. Press during numeric entry to enter a "#". | | | | | | | | | | | |

■ Push-To-Talk (PTT) Button

The **PTT** button on the side of the radio serves two basic purposes:

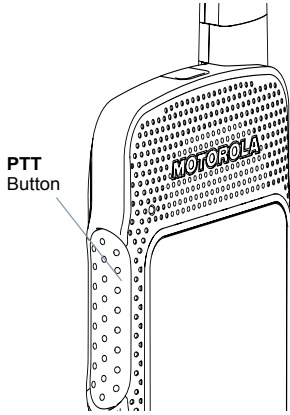

- While a call is in progress, the **PTT** button allows the radio to transmit to other radios in the call.

Press and hold down **PTT** button to talk. Release the **PTT** button to listen.

The microphone is activated when the **PTT** button is pressed.

- While a call is not in progress, the **PTT** button is used to make a new call (see **Making a Radio Call** on page 25).

If the Talk Permit Tone (see **Turning the Talk Permit Tone On or Off** on page 84) is enabled, wait until the short alert tone ends before talking .

*During a call, if the Channel Free Indication feature is enabled on your radio (programmed by your dealer), you will hear a short alert tone the moment the target radio (the radio that is receiving your call) releases the **PTT** button, indicating the channel is free for you to respond.*

*You will also hear a continuous talk prohibit tone, if your call is interrupted, indicating that you should release the **PTT** button, for example when the radio receives an Emergency Call.*

■ Capacity Plus

Capacity Plus is a single-site trunking configuration of the MOTOTRBO radio system, which uses a pool of channels to support hundreds of users and up to 254 Groups. This feature allows your radio to efficiently utilize the available number of programmed channels while in Repeater Mode.

When Capacity Plus is enabled, features not applicable to Capacity Plus are not available in the menu. Also, you hear a negative indicator tone if you try to access a feature not applicable to Capacity Plus via a programmable button press.

Your radio also has features that are available in both conventional digital mode and Capacity Plus. However, the minor differences in the way each feature works does NOT affect the performance of your radio.

Check with your dealer or system administrator for more information on this system configuration.

Identifying Status Indicators

Your radio indicates its operational status through the following:

| | |
|-----------------------------|---------|
| Display Icons | page 14 |
| Call Icons | page 16 |
| Utilities Icons | page 16 |
| Mini Notice Icons | page 17 |
| Sent Item Icons | page 17 |
| Job Tickets Icons | page 18 |
| LED Indicator | page 18 |
| Audio Tones | page 19 |
| Indicator Tones | page 20 |

Display Icons

Your radio has a 2 inch landscape display with QVGA (Quarter Video Graphics Array) 16-bit color resolution.

The following are icons that appear on the radio's display. Icons are displayed arranged left-most in order of appearance/usage.



Received Signal Strength Indicator (RSSI)

The number of bars displayed represents the radio signal strength. Four bars indicate the strongest signal. This icon is only displayed while receiving.



Battery

The number of bars shown indicates the charge remaining in the battery. Blinks when the battery is low.



Battery Discharging Status

Shows battery discharging status.



Bluetooth Not Connected

The Bluetooth feature is enabled but there is no remote Bluetooth device connected.



Bluetooth Connected

The Bluetooth feature is enabled. The icon stays lit when a remote Bluetooth device is connected.



Emergency

Radio is in Emergency mode.



Job Ticket Notification

Notification List has items to review.



Scan*

Scan feature is enabled.



Scan – Priority 1*

Radio detects activity on channel/group designated as Priority 1.



Scan – Priority 2*

Radio detects activity on channel/group designated as Priority 2.



Monitor

Selected channel is being monitored.



Talkaround*

In the absence of a repeater, radio is currently configured for direct radio to radio communication.



Site Roaming*

The site roaming feature is enabled.



Secure

The Privacy feature is enabled.



Unsecure

The Privacy feature is disabled.



Option Board

The Option Board is enabled. (Option board enabled models only).



Option Board Non-Function

The Option Board is disabled.



All Tones Disabled

No ring tones available.



Call Log

Radio call log.



Contact

Radio contact is available



Message

Incoming message.



Silent Ring

Silent ring mode is enabled.



Ring only

Ringing mode is enabled.



Vibrate

Vibrate mode is enabled.



Vibrate and Ring

Vibrate and ring modes are enabled.



Keypad

Keypad locked.

* Not applicable in Capacity Plus

■ Call Icons

The following icons appear on the radio's display during a call. These icons also appear in the Contacts list to indicate ID type.



Private Call

Indicates a Private Call in progress.



Group Call/All Call

Indicates a Group Call or All Call in progress.



Private Call Alert Icon

In the Contacts list, it indicates a subscriber alias (name) or ID (number).

■ Utilities Icons

The following icons appear beside menu items on the radio's display that offer the following options.



Checkbox (Empty)

Indicates the option is not selected.



Checkbox (Checked)

Indicates the option is selected.

Brightness



Indicates the brightness level.

Brightness Highlighted



Highlights the brightness level.

■ Mini Notice Icons

The following icons appear momentarily on the radio's display after an action to perform task is taken.



Successful Transmission (Positive)

Successful action taken.



Failed Transmission (Negative)

Failed action taken.



Transmission in Progress (Transitional)

Transmitting. This is seen before indication for Successful Transmission or Failed Transmission.

■ Sent Item Icons

The following icons appear in the Sent Items folder.



OR

Sent Successfully

The text message is sent successfully.



OR

Individual or Group Message Read.

The text message has been read.



OR

Individual or Group Message Unread.

The text message has been unread.



OR

Send Failed

The text message cannot be sent.





In-Progress

OR



- The text message to a group alias or ID is pending transmission.
- The text message to a subscriber alias or ID is pending transmission, followed by waiting for acknowledgement.

Job Tickets Icons



All Jobs

Indicates all jobs listed.



New Jobs

Indicates new jobs.

LED Indicator

The LED indicator shows the operational status of your radio.

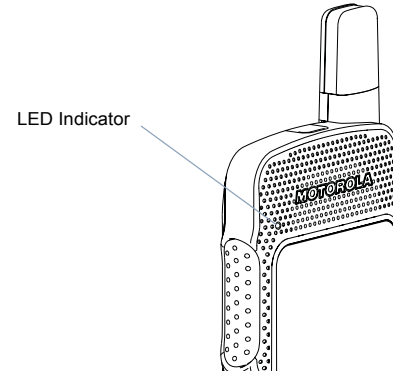

Blinking red – Radio is transmitting at low battery condition, receiving an emergency transmission or has failed the self-test upon powering up.

Solid yellow – Radio is monitoring a digital conventional channel. Also indicates fair battery charge when programmable button is pressed.

Blinking yellow – Radio is scanning for activity or receiving a Call Alert.

Double blinking yellow – Radio is no longer connected to the repeater while in Capacity Plus, all Capacity Plus channels are currently busy, Auto Roaming is enabled, radio is actively searching for a new site, or radio has yet to respond to a group

call alert. Also indicates that radio has yet to respond to a group call alert, or radio is locked.

Solid green – Radio is powering up or transmitting. Also indicates full charge of the battery when programmable button is pressed.

Blinking green – Radio is powering up, receiving a non-privacy-enabled call or data, or detecting activity over the air.

Double blinking green – Radio is receiving a privacy-enabled call or data.

NOTE: While in conventional mode, when the LED blinks green, it indicates the radio detects activity over the air. Due to the nature of the digital protocol, this activity may or may not affect the radio's programmed channel.

For Capacity Plus, there is no LED indication when the radio is detecting activity over the air.

■ Audio Tones

Alert tones provide you with audible indications of the radio's status or the radio's response to data received.

Continuous Tone  A monotone sound. Sounds continuously until termination.

Periodic Tone  Sounds periodically depending on the duration set by the radio. Tone starts, stops, and repeats itself.

Repetitive Tone  A single tone that repeats itself until it is terminated by the user.

Momentary Tone  Sounds only once for a short period of time defined by the radio.

■ Indicator Tones

High pitched tone

Low pitched tone



Positive Indicator Tone



Negative Indicator Tone

Making and Receiving Calls

Once you understand how your MOTOTRBO SL7550 is configured, you are ready to use your radio.

Use this navigation guide to familiarize yourself with the basic Call features:

| | |
|----------------------------------------------------|---------|
| Selecting a Zone | page 21 |
| Selecting a Channel | page 23 |
| Receiving and Responding to a Radio Call | page 23 |
| Making a Radio Call | page 25 |
| Stopping a Radio Call | page 30 |
| Talkaround | page 30 |
| Monitoring Features | page 31 |

Selecting a Zone

A zone is a group of channels. Your radio supports up to 250 zones, with a maximum of 160 channels per zone.

Use the following procedure to select a zone.



Procedure:

Press the programmed Zone button and proceed to Step 3.





OR

Follow the procedure below.

- 1  to access the menu.

 - 2  or  to Zone and press  to select.

 - 3 The current zone is displayed and indicated by a .

 - 4  or  to the required zone and proceed to Step 7.
- OR**
- Key in the first character of the required zone.
-
- 5 A blinking cursor appears.
Use the keypad to type the required zone.
Press  to move one space to the left.
Press  to move one space to the right.
Press the *DEL key to delete any unwanted characters.

 - 6 The first line of the display shows the characters you keyed in. The next lines of the display show the shortlisted zones. The alias search is case-insensitive. If there are two or more

zones with the same name, the radio displays the zone that is listed first in the zone list.

- 7 Press  to select.
- 8 The display shows <Zone> Selected momentarily and returns to the selected zone screen.

■ Selecting a Channel

Transmissions are sent and received on a channel. Depending on your radio's configuration, each channel may have been programmed differently to support different groups of users or supplied with different features. After selecting the relevant Zone, select the relevant channel you require to transmit or receive on.

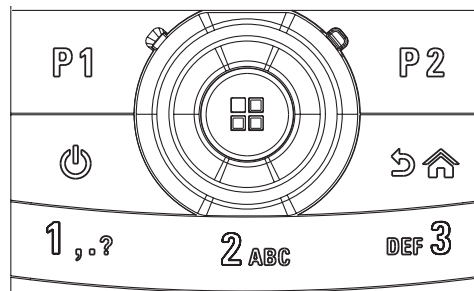

Procedure:

- 1 On the navigation disc, press  to access the Channel List (while on the Home Screen). The active channel is displayed and indicated by a ✓.

■ Receiving and Responding to a Radio Call

Once the channel or group alias ID is displayed, you can proceed to receive and respond to calls.

The LED lights up solid green while the radio is transmitting and blinks green when the radio is receiving.

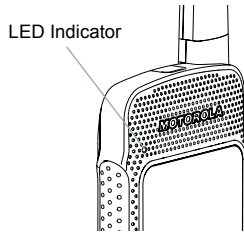

NOTE: The LED lights up solid green while the radio is transmitting and double blinks green when the radio is receiving a privacy-enabled call.

To unscramble a privacy-enabled call, your radio must have the same Privacy Key, OR the same Key Value and Key ID (programmed by your dealer), as the transmitting radio (the radio you are receiving the call from).

See **Privacy** on page 70 for more information.

📄 Receiving and Responding to a Group Call

To receive a call made to a group of users, your radio must be configured as part of that group.

Procedure:

When you receive a Group Call (while on the Home screen):

- 1 The LED blinks green.

- 2 The Group Call icon appears in the top right corner. The first text line shows the caller alias. The second text line displays the group call alias. Your radio unmutes and the incoming call sounds through the radio's speaker.

- 3 To respond, hold the radio vertically 1 to 2 inches (2.5 to 5.0 cm) from your mouth.

- 4 If the Channel Free Indication feature is enabled, you will hear a short alert tone the moment the transmitting radio releases the **PTT** button, indicating the channel is free for you to respond. Press the **PTT** button to respond to the call.

OR

If the Voice Interrupt feature is enabled, press the **PTT** button to stop the current call from the transmitting radio and free the channel for you to talk/respond.

- 5 The LED lights up solid green.
- 6 Wait for the Talk Permit Tone to finish (if enabled) and speak clearly into the microphone.
- 7 Release the **PTT** button to listen.
- 8 If there is no voice activity for a predetermined period of time, the call ends.

See **Making a Group Call with the PTT Button** on page 26 for details on making a Group Call.

NOTE: If the radio receives a Group Call while not on the Home screen, it remains on its current screen prior to answering the call.

Long press the  button to go to the Home screen to view the caller alias before replying.

Receiving and Responding to a Private Call

A Private Call is a call from an individual radio to another individual radio.

Procedure:

When you receive a Private Call:

- 1 The LED blinks green.
- 2 The status line shows the Private Call icon. The first text line shows the caller alias. The second text line displays the call status. Your radio unmutes and the incoming call sounds through the radio's speaker.

- 3 To respond, hold the radio vertically 1 to 2 inches (2.5 to 5.0 cm) from your mouth.
- 4 If the Channel Free Indication feature is enabled, you will hear a short alert tone the moment the transmitting radio releases the **PTT** button, indicating the channel is free for you to respond.
Press the **PTT** button to respond to the call.

OR

If the Voice Interrupt feature is enabled, press the **PTT** button to stop the current call from the transmitting radio and free the channel for you to talk/respond.

- 5 The LED lights up solid green.
- 6 Wait for the Talk Permit Tone to finish (if enabled) and speak clearly into the microphone.
- 7 Release the **PTT** button to listen.
- 8 If there is no voice activity for a predetermined period of time, the call ends.
- 9 You hear a short tone. The display shows `Call Ended`.

See **Making a Private Call with the PTT Button** on page 26 for details on making a Private Call.

Receiving an All Call

An All Call is a call from an individual radio to every radio on the channel. It is used to make important announcements requiring the user's full attention.

Procedure:

When you receive an All Call:

- 1 A tone sounds and the LED blinks green.
- 2 The Group Call icon appears in the top right corner. The first text line shows the caller alias. The second text line displays All Call. Your radio unmutes and the incoming call sounds through the radio's speaker.
- 3 Once the All Call ends, the radio returns to the previous screen it was on before receiving the call. An All Call does not wait for a predetermined period of time before ending. If the Channel Free Indication feature is enabled, you will hear a short alert tone the moment the transmitting radio releases the **PTT** button, indicating the channel is now available for use.

You cannot respond to an All Call.

See **Making an All Call** on page 27 for details on making an All Call.

NOTE: The radio stops receiving the All Call if you switch to a different channel while receiving the call. During an All Call, you will **not** be able to use any programmed button functions until the call ends.

■ Making a Radio Call

After selecting your channel, you can select a subscriber ID, or group by using:

- The **PTT** Button
- A programmed **One Touch Access** button (see **Making a Group or Private Call with the One Touch Access Button** on page 28)
- The programmed number keys (see **Making a Group, Private or All Call with the Programmable Number Key** on page 28).
- The Contacts list (see **Contacts Settings** on page 41)
- Manual Dial (via Contacts) – This method is for Private Calls only and is dialed using the keypad (see **Making a Private Call from Contacts** on page 42).

NOTE: Your radio must have the Privacy feature enabled on the channel to send a privacy-enabled transmission. Only target radios with the same Privacy Key OR the same Key Value and Key ID as your radio will be able to unscramble the transmission.

See **Privacy** on page 70 for more information.

Making a Group Call with the PTT Button

To make a call to a group of users, your radio must be configured as part of that group.

Procedure:

- 1 Select the channel with the active group alias or ID. See **Selecting a Channel** on page **page 22**.
- 2 Hold the radio vertically 1 to 2 inches (2.5 to 5.0 cm) from your mouth.
- 3 Press the **PTT** button to make the call. The LED lights up solid green. The Group Call icon appears in the top right corner. The first text line shows the group call alias.
- 4 Wait for the Talk Permit Tone to finish (if enabled) and speak clearly into the microphone.
- 5 Release the **PTT** button to listen. When the target radio responds, the LED blinks green, the radio unmutes and the response sounds through the radio's speaker. You see the Group Call icon, the group alias or ID, and transmitting radio alias or ID on your display.
- 6 If the Channel Free Indication feature is enabled, you will hear a short alert tone the moment the target radio releases the **PTT** button, indicating the channel is free for you to respond. Press the **PTT** button to respond.
OR
If there is no voice activity for a predetermined period of time, the call ends.

- 7 Radio returns to the screen you were on prior to initiating the call.

Making a Private Call with the PTT Button

While you can receive and/or respond to a Private Call initiated by an authorized individual radio, your radio must be programmed for you to initiate a Private Call.

You will hear a negative indicator tone, when you make a Private Call via the Contacts list, Call Log, **One Touch Access** button, the programmed number keys, if this feature is not enabled.

Use the Text Message or Call Alert features to contact an individual radio. See **Text Message Features** on page 58 or **Call Alert Operation** on page 51 for more information.

Procedure:

- 1 Select the channel with the active individual alias or ID. See **Selecting a Channel** on **page 22**.
- 2 Hold the radio vertically 1 to 2 inches (2.5 to 5.0 cm) from your mouth.
- 3 Press the **PTT** button to make the call. The LED lights up solid green, the radio unmutes and the response sounds through the radio's speaker. The Private Call icon appears on the top right corner. The first text line shows the

subscriber alias. The second text line displays the call status.

- 4 Wait for the Talk Permit Tone to finish (if enabled) and speak clearly into the microphone.
- 5 Release the **PTT** button to listen. When the target radio responds, the LED blinks green, the radio unmutes and the response sounds through the radio's speaker.
- 6 If the Channel Free Indication feature is enabled, you will hear a short alert tone the moment the target radio releases the **PTT** button, indicating the channel is free for you to respond. Press the **PTT** button to respond.
OR
If there is no voice activity for a predetermined period of time, the call ends.
- 7 You hear a short tone. The display shows `Call Ended`.

NOTE: If you release the PTT button while the radio is setting up the call, it exits without any indication and returns to the previous screen.
Your radio may be programmed to perform a radio presence check prior to setting up the Private Call. If the target radio is not available, you hear a short tone and see negative mini notice on the display.

Making an All Call

This feature allows you to transmit to all users on the channel. Your radio must be programmed to allow you to use this feature.

Procedure:

- 1 Select the channel with the active group alias or ID. See **Selecting a Channel** on page **page 22**.
- 2 Hold the radio vertically 1 to 2 inches (2.5 to 5.0 cm) from your mouth.
- 3 Press the **PTT** button to make the call. The LED lights up solid green. The Group Call icon appears in the top right corner. The first text line shows `All Call`.
- 4 Wait for the Talk Permit Tone to finish (if enabled) and speak clearly into the microphone.

Users on the channel cannot respond to an All Call.

Making a Group or Private Call with the One Touch Access Button

The One Touch Access feature allows you to make a Group or Private Call to a predefined alias or ID easily. This feature can be assigned to a short or long programmable button press.

You can **ONLY** have one channel independent alias or ID assigned to a **One Touch Access** button, however you can have multiple **One Touch Access** buttons programmed.

Procedure:

- 1 Press the programmed **One Touch Access** button to make a Group or Private Call to the predefined alias or ID.
- 2 Hold the radio vertically 1 to 2 inches (2.5 to 5.0 cm) from your mouth.
- 3 Press the **PTT** button to make the call. The LED lights up solid green, the radio unmutes and the response sounds through the radio's speaker. The Group/Private Call icon appears in the top right corner. The first text line shows the caller alias. The second text line displays the call status for a Private Call.
- 4 Wait for the Talk Permit Tone to finish (if enabled) and speak clearly into the microphone.
- 5 Release the **PTT** button to listen. When the target radio responds, the LED blinks green, the radio unmutes and the response sounds through the radio's speaker.

- 6 If the Channel Free Indication feature is enabled, you will hear a short alert tone the moment the target radio releases the **PTT** button, indicating the channel is free for you to respond. Press the **PTT** button to respond.

OR

If there is no voice activity for a predetermined period of time, the call ends.

- 7 Radio returns to the screen you were on prior to initiating the call.

For a Private Call, you hear a short tone when the call ends.

Making a Group, Private or All Call with the Programmable Number Key

The Programmable Number Key feature allows you to make a Group, Private or All Call to a predefined alias or ID easily. This feature can be assigned to all the available number keys on a keypad.

You can **ONLY** have one channel independent alias or ID assigned to a number key, however you can have more than one number key associated to an alias or ID.

Procedure:

When you are on the Home screen:

- 1 Long press the programmed number key to make a Group, Private or All Call to the predefined alias or ID. If the number key is not associated to an entry, a negative indicator tone sounds.

- 2 Hold the radio vertically 1 to 2 inches (2.5 to 5.0 cm) from your mouth.

- 3 Press the **PTT** button to make the call. The LED lights up solid green, the radio unmutes and the response sounds through the radio's speaker. The Group/Private Call icon appears in the top right corner. The first text line shows the caller alias. The second text line displays either the call status for a Private Call or **All Call** for All Call.

- 4 Wait for the Talk Permit Tone to finish (if enabled) and speak clearly into the microphone.

- 5 Release the **PTT** button to listen. When the target radio responds, the LED blinks green, the radio unmutes and the response sounds through the radio's speaker.

- 6 If the Channel Free Indication feature is enabled, you will hear a short alert tone the moment the target radio releases the **PTT** button, indicating the channel is free for you to respond. Press the **PTT** button to respond.
OR
If there is no voice activity for a predetermined period of time, the call ends.

- 7 Radio returns to the screen you were on prior to initiating the call.

For a Private Call, you hear a short tone when the call ends.

See **Assigning an Entry to a Programmable Number Key** on page 44 for details on assigning an entry to a number key on the keypad.

■ Stopping a Radio Call

This feature allows you to stop an ongoing Group or Private Call to free the channel for transmission. For example, when a radio experiences a "stuck microphone" condition where the **PTT** button is inadvertently pressed by the user.

Your radio must be programmed to allow you to use this feature.

Procedure:

While on the required channel:

- 1 Press the programmed **Transmit Interrupt Remote Dekey** button.
 - 2 The display shows *Remote Dekey*.
 - 3 Wait for acknowledgment.
 - 4 The radio sounds a positive indicator tone and the display shows *Remote Dekey Success*, indicating that the channel is now free.
- OR**
- The radio sounds a negative indicator tone and the display shows *Remote Dekey Failed*.

*The display shows **Call Interrupted**, and the radio sounds a negative indicator tone until you release the **PTT** button, if it is transmitting an interruptible call that is stopped via this feature.*

■ Talkaround

You can continue to communicate when your repeater is not operating, or when your radio is out of the repeater's range but within talking range of other radios.

This is called "talkaround".

NOTE: This feature is not applicable in Capacity Plus

Procedure:

Press the programmed **Repeater/Talkaround** button to toggle between talkaround and repeater modes.

OR

Follow the procedure below.

- 1 Ⓜ to access the menu.
 - 2 \blacktriangle or \blacktriangledown to *Utilities* and press Ⓜ to select.
 - 3 \blacktriangle or \blacktriangledown to *Radio Settings* and press Ⓜ to select.
 - 4 \blacktriangle or \blacktriangledown stop *Talkaround*.
 - 5 Press Ⓜ to enable Talkaround. The display shows \checkmark beside *Enabled*.
- OR**
- Press Ⓜ to disable Talkaround. The \checkmark disappears from beside *Enabled*.
- 6 The screen automatically returns to the previous menu.

The Talkaround setting is retained even after powering down.

NOTE: At Step 4, you can also use ◀ or ▶ to change the selected option.

■ Monitoring Features

Monitoring a Channel

Use the Monitor feature to make sure a channel is clear before transmitting.

NOTE: This feature is not applicable in Capacity Plus

Procedure:

- 1 Press and hold the programmed **Monitor** button and listen for activity.
- 2 The monitor icon appears on the status bar and the LED lights up solid yellow.
- 3 You hear radio activity or total silence, depending on how your radio is programmed.
- 4 When you hear "talk permit tone" (that is, the channel is free), press the **PTT** button to talk and release it to listen.

 **Sticky Monitor**

Use the Permanent Monitor feature to continuously monitor a selected channel for activity.

NOTE: This feature is not applicable in Capacity Plus

Procedure:

- 1 Press the programmed **Sticky Monitor** button.

- 2 Radio sounds an alert tone, the LED lights up solid yellow, and the display shows Permanent Monitor On. The monitor icon appears on the status bar.

- 3 Press the programmed **Permanent Monitor** button to exit Permanent Monitor mode.

- 4 Radio sounds an alert tone, the LED turns off, and display shows Permanent Monitor Off.

Advanced Features

Use this navigation guide to learn more about advanced features available with your radio:

| | |
|--------------------------------------------|---------|
| Radio Check | page 33 |
| Remote Monitor | page 35 |
| Scan Lists | page 36 |
| Scan | page 39 |
| Contacts Settings | page 41 |
| Call Indicator Settings | page 46 |
| Call Log Features | page 49 |
| Call Alert Operation | page 51 |
| Emergency Operation | page 53 |
| Text Message Features | page 58 |
| Job Tickets | page 68 |
| Privacy | page 70 |
| Covert Mode | page 71 |
| Dual Tone Multi Frequency (DTMF) | page 71 |
| IP Site Connect | page 72 |
| Security | page 74 |
| Lone Worker | page 76 |
| Password Lock Features | page 77 |
| Bluetooth Operation | page 79 |
| Notification List | page 82 |
| Utilities | page 83 |

Radio Check

If enabled, this feature allows you to determine if another radio is active in a system without disturbing the user of that radio. No audible or visual notification is shown on the target radio.

Sending a Radio Check

Procedure:







Use the programmed **Radio Check** button.

- 1 Press the programmed **Radio Check** button.
- 2 ▲ or ▼ to the required subscriber alias or ID and press  to select.
- 3 The display shows transitional mini notice, indicating the request is in progress. The LED lights up solid green.
- 4 Wait for acknowledgement.
- 5 If successful, a positive indicator tone sounds and the display shows positive mini notice.
OR
If unsuccessful, a negative indicator tone sounds and the display shows negative mini notice.
- 6 Radio returns to the subscriber alias or ID screen.



OR

Procedure:

Use the menu.





- 1  to access the menu.
- 2  or  to **Contacts** and press  to select.
- 3  or  to the required subscriber alias or ID and press  to select.



OR

 or  to **Manual Dial** and press  to select.

If there was previously dialed ID, the ID appears along with a blinking cursor. Use the keypad to edit the ID. Press  to select.

OR

 or  to **Manual Dial** and press  to select. Key in the subscriber alias or ID and press .

- 4  or  to **Radio Check** and press  to select.
 - 5 The display shows transitional mini notice, indicating the request is in progress. The LED lights up solid green.
 - 6 Wait for acknowledgement.
 - 7 If successful, a positive indicator tone sounds and the display shows positive mini notice.
- OR**
- If unsuccessful, a negative indicator tone sounds and the display shows negative mini notice.

- 8 Radio returns to the subscriber alias or ID screen.

If the  button is pressed when the radio is waiting for acknowledgement, a tone sounds, and the radio terminates all retries and exits Radio Check mode.

■ Remote Monitor

Use the Remote Monitor feature to turn on the microphone of a target radio (subscriber alias or IDs only). No audible or visual indication is given to the target radio. You can use this feature to monitor, remotely, any audible activity surrounding the target radio.

Your radio must be programmed to allow you to use this feature.

Initiating Remote Monitor

Procedure:

Use the programmed **Remote Monitor** button.

- 1 Press the programmed **Remote Monitor** button.

- 2 ▲ or ▼ to the required subscriber alias or ID and press  to select.

- 3 The display shows transitional mini notice, indicating the request is in progress. The LED lights up solid green.

- 4 Wait for acknowledgment.

- 5 If successful, a positive indicator tone sounds and the display shows mini notice. Your radio starts playing audio from the monitored radio for a programmed duration and display shows **Rem. Monitor**. Once the timer expires, the radio sounds an alert tone and the LED turns off.

OR

If unsuccessful, a negative indicator tone sounds and the display shows mini notice.

OR

Procedure:

Use the menu.

- 1  to access the menu.

- 2 ▲ or ▼ to **Contacts** and press  to select.



- 3 ▲ or ▼ to the required subscriber alias or ID and press  to select.

OR

▲ or ▼ to **Manual Dial** and press  to select.

If there was previously dialed ID, the ID appears along with a blinking cursor. Use the keypad to edit the ID. Press  to select.

OR

▲ or ▼ to **Manual Dial** and press  to select. Key in the subscriber alias or ID and press  to select.

- 4 ▲ or ▼ to **Remote Mon.** and press  to select.

- 5 The display shows transitional mini notice, indicating the request is in progress. The LED lights up solid green.

- 6 Wait for acknowledgment.

- 7 If successful, a positive indicator tone sounds and the display shows mini notice. Your radio starts playing audio from the monitored radio for a programmed duration and display shows *Rem. Monitor*.
Once the timer expires, the radio sounds an alert tone and the LED turns off.
OR
If unsuccessful, the radio sounds a negative indicator tone the display shows mini notice.

■ Scan Lists

Scan lists are created and assigned to individual channels. Your radio cycles through the programmed scan list for the current channel looking for voice activity. At each channel in the cycle the radio also cycles through the group list for that channel.

Your radio can support up to 250 scan lists, with a maximum of 16 members in a list.

You can add, delete, or prioritize channels by editing a scan list.



You can attach a new scan list to your radio via Front Panel Programming.



NOTE: This feature is not applicable in Capacity Plus



Viewing an Entry in the Scan List

Procedure:

- 1  to access the menu.

- 2  or  to *Scan* and press  to select.

- 3  or  to *View/Edit List* and press  to select.

- 4 Use  or  to view each member on the list.



*The priority icon appears left of the member's alias, if set, to indicate whether the member is on a Priority 1 or Priority 2 channel list. You **cannot** have multiple Priority 1 or Priority 2 channels in a scan list.*



*There is no priority icon if priority is set to **None**.*

Viewing an Entry in the Scan List by Alias Search

Procedure:

- 1  to access the menu.

- 2  or  to *Scan* and press  to select.

- 3  or  to *View/Edit List* and press  to select.

- 4 Key in the first character of the required alias.

- 5 A blinking cursor appears.
Use the keypad to type the required alias.

Press ◀ to move one space to the left.
 Press ▶ to move one space to the right.
 Press the *DEL key to delete any unwanted characters.





- 6 The first line of the display shows the characters you keyed in. The next lines of the display shows the short listed search results.

The alias search is case-insensitive. If there are two or more entries with the same name, the radio displays the entry that is listed first in the scan list.

Editing the Scan List

Adding a New Entry to the Scan List

Procedure:

- 1  to access the menu.
- 2 ▲ or ▼ to Scan and press  to select.
- 3 ▲ or ▼ to View/Edit List and press  to select.
- 4 ▲ or ▼ to Add Member and press  to select.
- 5 ▲ or ▼ to the required alias or ID and proceed to Step 8.
OR
 Key in the first character of the required alias.



- 6 A blinking cursor appears.
 Use the keypad to type the required alias.
 Press ◀ to move one space to the left.
 Press ▶ to move one space to the right.
 Press the *DEL key to delete any unwanted characters.

- 7 The first line of the display shows the characters you keyed in. The next lines of the display shows the short listed search results.
 The alias search is case-insensitive. If there are two or more aliases with the same name, the radio displays the alias that is listed first in the list.

- 8 Press  to select.

- 9 ▲ or ▼ to the required priority level and press  to select.

- 10 The display shows mini notice, followed immediately by Add Another?.

- 11 ▲ or ▼ to Yes and press  to select, to add another entry, and repeat Steps 5 to 9.
OR
 ▲ or ▼ to No and press  to select to save the current list.

Deleting an Entry from the Scan List

Procedure:

- 1  to access the menu.

- 2 ▲ or ▼ to Scan and press **Ⓜ** to select.

- 3 ▲ or ▼ to View/Edit List and press **Ⓜ** to select.

- 4 ▲ or ▼ to the required alias or ID and proceed to Step 7.
OR
Key in the first character of the required alias.

- 5 A blinking cursor appears.
Use the keypad to type the required alias.
Press ◀ to move one space to the left.
Press ▶ to move one space to the right.
Press the *DEL key to delete any unwanted characters.

- 6 The first line of the display shows the characters you keyed in. The next lines of the display show the short listed search results.
The alias search is case-insensitive. If there are two or more entries with the same name, the radio displays the entry that is listed first in the scan list.

- 7 Press **Ⓜ** to select.

- 8 ▲ or ▼ to Delete and press **Ⓜ** to select.

- 9 At Delete Entry?, ▲ or ▼ to Yes and press **Ⓜ** to select, to delete the entry. The display shows mini notice.
OR
▲ or ▼ to No and press **Ⓜ** to select to return to the previous screen.

- 10 Repeat Steps 4 to 9 to delete other entries.
-

After deleting all required aliases or IDs, long press **↵** to return to the Home screen.

Setting and Editing Priority for an Entry in the Scan List

Procedure:

- 1 **Ⓜ** to access the menu.

- 2 ▲ or ▼ to Scan and press **Ⓜ** to select.

- 3 ▲ or ▼ to View/Edit List and press **Ⓜ** to select.

- 4 ▲ or ▼ to the required alias or ID and proceed to Step 7.
OR
Key in the first character of the required alias.

- 5 A blinking cursor appears.
Use the keypad to type the required alias.
Press ◀ to move one space to the left.
Press ▶ to move one space to the right.
Press the *DEL key to delete any unwanted characters.

- 6 The first line of the display shows the characters you keyed in. The next lines of the display show the short listed search results.
The alias search is case-insensitive. If there are two or more entries with the same name, the radio displays the entry that is listed first in the scan list.

- 7 Press **Ⓜ** to select.

- 8 **▲** or **▼** to Edit Priority and press **Ⓜ** to select.

- 9 **▲** or **▼** to the required priority level and press **Ⓜ** to select.

- 10 The display shows mini notice before returning to the previous screen.

- 11 The priority icon appears left of the member's name.

*There is no priority icon if priority is set to **None**.*

■ Scan

When you start a scan, your radio cycles through the programmed scan list for the current channel looking for voice activity.

The LED blinks yellow and the scan icon appears on the bar.

There are two ways of initiating scan:

- **Scan Button (Manual):** For channels that have Auto Scan disabled, scan can be turned on and off using programmed Scan button.
- **Auto Scan (Automatic):** Your radio automatically starts scanning when you select a channel that has Auto Scan enabled.

NOTE: This feature is not applicable in Capacity Plus

Setting an Active Scan List

Procedure:

- 1 **Ⓜ** to access the menu.

- 2 **▲** or **▼** to select Scan and press **Ⓜ** to select.

- 3 **▲** or **▼** to select Set Active List and press **Ⓜ** to select.

- 4 **▲** or **▼** to required list and press **Ⓜ** to select.

NOTE: The list selected will be your active scan list.











Starting and Stopping Scan

Procedure:

Press the programmed **Scan** button to start or stop Scan.

OR

Follow the procedure below.

- 1  to access the menu.
- 2  or  to **Scan** and press  to select.
- 3  or  to **Scan State** and press  to select.
- 4  or  to required scan state and press  to select.
- 5 The display shows **Scan On** when scan is enabled. The LED blinks yellow and the scan icon appears.

OR

The display shows **Scan Off** when scan is disabled. The LED turns off and the scan icon disappears.

While scanning, the radio will only accept data (e.g. text message, location, or PC data) if received on its Selected Channel.

Responding to a Transmission During a Scan

During scanning, your radio stops on a channel where activity (e.g. a group call) targeted for the radio is detected. Your radio unmutes and the incoming call sounds through the radio's speaker.

The radio remains on that channel while the activity is present and for a programmed time period (known as "hang time") after the activity ceases.

Procedure:

- 1 Hold the radio vertically 1 to 2 inches (2.5 to 5.0 cm) from your mouth.
If the Channel Free Indication feature is enabled, you will hear a short alert tone the moment the transmitting radio releases the **PTT** button, indicating the channel is free for you to respond.
- 2 Press the **PTT** button during hang time. The LED lights up solid green.
- 3 Wait for the Talk Permit Tone to finish (if enabled) and speak clearly into the microphone.
- 4 Release the **PTT** button to listen.
- 5 If you do not respond within the hang time, the radio returns to scanning other channels/groups.

Deleting a Nuisance Channel

If a particular channel continually generates unwanted calls or noise (termed a "nuisance" channel), you can temporarily remove the unwanted channel from the scan list.

This capability does not apply to the channel designated as the Selected Channel.

Procedure:

- 1 When your radio "locks on to" an unwanted or nuisance channel, press the programmed **Nuisance Channel Delete** button until you hear a tone.
- 2 Release the **Nuisance Channel Delete** button. The nuisance channel is deleted.

*Deleting a "nuisance" channel is **only** possible through the programmed **Nuisance Channel Delete** button. This feature is **not** accessible through the menu.*

Restoring a Nuisance Channel

Procedure:

To restore the deleted nuisance channel, do **one** of the following:

- Turn the radio off and then power it on again,
- Stop and restart a scan via the programmed **Scan** button or menu, **OR**
- Change channel or zone.

■ Contacts Settings

Contacts provides "address-book" capabilities on your radio. Each entry corresponds to an alias or ID that you use to initiate a call.

Each entry, depending on context, associates with **one** of five types of calls: Group Call, Private Call, All Call, PC Call or Dispatch Call.

PC Call and Dispatch Call are data-related. They are only available with the applications. Refer to the data applications documentation for more information.

NOTE: If the Privacy feature is enabled on a channel, you can make privacy-enabled Group Call, Private Call, and All Call on that channel. Only target radios with the same Privacy Key OR the same Key Value and Key ID as your radio will be able to unscramble the transmission.

See **Privacy** on page 70 for more information.

Additionally, the Contacts menu allows you to assign each entry to one or more programmable number keys on the keypad. If an entry is assigned to a number key, your radio can perform a quick dial on the entry.

Your radio supports maximum of 1000 Contact list entries.

Each entry within Contacts displays the following information:







- Call Type

- Call Alias
- Call ID

NOTE: You can add or edit subscriber IDs for the Digital Contacts list.

Making a Group Call from Contacts

Procedure:

- 1  to access the menu.
- 2  or  to **Contacts** and press  to select. The entries are alphabetically sorted.
- 3  or  to the required group alias or ID.
- 4 Hold the radio vertically 1 to 2 inches (2.5 to 5.0 cm) from your mouth.
- 5 Press the **PTT** button to make the call. The LED lights up solid green, the radio unmutes and the response sounds through the radio's speaker.
- 6 Wait for the Talk Permit Tone to finish (if enabled) and speak clearly into the microphone.
- 7 Release the **PTT** button to listen. When any user in the group responds, the LED blinks green, the radio unmutes and the response sounds through the radio's speaker. You

see the Group Call icon, the group ID, and that user's ID on your display.













- 8 If the Channel Free Indication feature is enabled, you will hear a short alert tone the moment the target radio releases the **PTT** button, indicating the channel is free for you to respond. Press the **PTT** button to respond.

OR

If there is no voice activity for a programmed period of time, the call ends.

Making a Private Call from Contacts

Procedure:

- 1  to access the menu.
 - 2  or  to **Contacts** and press  to select. The entries are alphabetically sorted.
 - 3  or  to the required subscriber alias or ID.
- OR**
-  or  to **Manual Dial** and press  to select. If there was previously dialed subscriber alias or ID, the alias or ID appears along with a blinking cursor. Use the keypad to edit the ID.
- OR**
-  or  to **Manual Dial** and press  to select. Use the keypad to enter a new subscriber alias or ID.







- 4 Hold the radio vertically 1 to 2 inches (2.5 to 5.0 cm) from your mouth.
- 5 Press the **PTT** button to make the call. The LED lights up solid green. The first line displays the subscriber alias or ID. The second line displays `Private Call` and the Private Call icon.
- 6 Wait for the Talk Permit Tone to finish (if enabled) and speak clearly into the microphone.
- 7 Release the **PTT** button to listen. When the target radio responds, the LED blinks green, the display shows the transmitting user's ID, the radio unmutes and the response sounds through the radio's speaker.
- 8 If the Channel Free Indication feature is enabled, you will hear a short alert tone the moment the target radio releases the **PTT** button, indicating the channel is free for you to respond. Press the **PTT** button to respond.
OR
If there is no voice activity for a programmed period of time, the call ends.
- 9 You hear a short tone. The display shows `Call Ended`.

Making a Call by Alias Search

You can also use alias or alphanumeric search to retrieve the required subscriber alias.

This feature is only applicable while in Contacts.

Procedure:

- 1  to access the menu.
- 2  or  to `Contacts` and press  to select. The entries are alphabetically sorted.
- 3 Key in the first character of the required alias.
- 4 A blinking cursor appears.
Use the keypad to type the required alias.
Press  to move one space to the left.
Press  to move one space to the right.
Press the *DEL key to delete any unwanted characters.
- 5 The first line of the display shows the characters you keyed in. The next lines of the display show the short listed search results.
The alias search is case-insensitive. If there are two or more entries with the same name, the radio displays the entry that is listed first in the Contacts list.
- 6 Hold the radio vertically 1 to 2 inches (2.5 to 5.0 cm) from your mouth.

- 7 Press the **PTT** button to make the call. The LED lights up solid green. The display shows the destination alias.
- 8 Wait for the Talk Permit Tone to finish (if enabled) and speak clearly into the microphone.
- 9 Release the **PTT** button to listen. When the target radio responds, the LED blinks green, the radio unmutes and the response sounds through the radio's speaker.
- 10 If the Channel Free Indication feature is enabled, you will hear a short alert tone the moment the target radio releases the **PTT** button, indicating the channel is free for you to respond. Press the **PTT** button to respond.
OR
If there is no voice activity for a programmed period of time, the call ends.
- 11 You hear a short tone. The display shows `Call Ended`.

NOTE: Press  button or Ⓜ to exit alias search.

If you release the **PTT** button while the radio is setting up the call, it exits without any indication and returns to the previous screen.

Your radio may be programmed to perform a radio presence check prior to setting up the Private Call. If the target radio is not available, you hear a short tone and see negative mini notice on the display.

Assigning an Entry to a Programmable Number Key

Procedure:

- 1 Ⓜ to access the menu.
- 2 \blacktriangle or \blacktriangledown to `Contacts` and press Ⓜ to select radio name/alias. The entries are alphabetically sorted.
- 3 \blacktriangle or \blacktriangledown to the required alias or ID and press Ⓜ to select.
- 4 \blacktriangle or \blacktriangledown to `Program Key` and press Ⓜ to select.
- 5 \blacktriangle or \blacktriangledown to the desired number key and press Ⓜ to select.
OR
If the number key is currently assigned to another entry, the display shows `The Key is Already Assigned Used` and then, the first line of the display shows `Overwrite?`.
 \blacktriangle or \blacktriangledown to `Yes` and press Ⓜ to select.
- 6 The radio sounds a positive indicator tone and the display shows mini notice.
- 7 The screen automatically returns to the previous menu.

NOTE: Each entry can be associated to different number keys. You see a checkmark before each number key that is assigned to an entry. If the checkmark is before `Empty`, you have not assign a number key to the entry. If a number key is assigned to an entry in `Capacity`

Plus, this feature is not supported when you long press the number key in Conventional mode (and vice versa).

See **Making a Group, Private or All Call with the Programmable Number Key** on page 28 for details on making a Group, Private or All Call with the programmed number key(s).

Removing the Association between Entry and Programmable Number Key



Procedure:



Long press the programmed number key to the required alias or ID, press  to select, and proceed to Step 4.



OR



Follow the procedure below.

- 1  to access the menu.



- 2  or  to `Contacts` and press  to select. The entries are alphabetically sorted.

- 3  or  to the required alias or ID and press  to select.

- 4  or  to `Program Key` and press  to select.

- 5  or  to `Empty` and press  to select.

- 6 The first line of the display shows `Clear from all keys?`.

- 7  or  to `Yes` and press  to select.

- 8 The radio sounds a positive indicator tone and the display shows mini notice.



- 9 The screen automatically returns to the previous menu.



NOTE: When an entry is deleted, the association between the entry and its programmed number key(s) is removed.

Adding a New Contact



Procedure:



- 1  to access the menu.

- 2  or  to `Contacts` and press  to select.

- 3  or  to access `New Contact`. Add /Edit the name field provided.











- 4 Press  to access radio number field. Add/Edit the radio number field provided.

- 5 Select from the list of ring tones. Press  or  to select from `Tone List`.

- 6  to select `Save Contact` and press  to save.

Sending a Message to a Contact

Procedure:



















- 1  to access the menu.
- 2  or  to `Contacts` and press  to select radio name/alias. The entries are alphabetically sorted.
- 3  or  to the required alias or ID and press  to select.
- 4  or  to `Send Message` and press  to compose.
- 5 Press  to send the message.



Call Indicator Settings

Activating and Deactivating Call Ringers for Call Alert

You can select, or turn on or off ringing tones for a received Call Alert.

Procedure:

- 1  to access the menu.
- 2  or  to `Utilities` and press  to select.
- 3  or  to `Radio Settings` and press  to select.
- 4  or  to `Tones/Alerts` and press  to select.
- 5  or  to `Call Ringers` and press  to select.
- 6  or  to `Call Alert` and press  to select. The current tone is indicated by a ✓.
- 7  or  to the required tone and press  to select. ✓ appears beside selected tone.



NOTE: At Step 6, you can also use  or  to change the selected option.



📄 Activating and Deactivating Call Ringers for Private Calls



You can turn on or off the ringing tones for a received Private Call.



Procedure:



- 1  to access the menu.

- 2  or  to Utilities and press  to select.

- 3  or  to Radio Settings and press  to select.

- 4  or  to Tones/Alerts and press  to select.



- 5  or  to Call Ringers and press  to select.

- 6  or  to Private Call.

- 7 Press  to enable Private Call ringing tones. The display shows ✓ beside Enabled.

OR

Press  to disable Private Call ringing tones. The ✓ disappears from beside Enabled.



NOTE: At Step 6, you can also use  or  to change the selected option.



📄 Activating and Deactivating Call Ringers for Text Message



You can select, or turn on or off the ringing tones for a received Text Message.



Procedure:



- 1  to access the menu.



- 2  or  to Utilities and press  to select.

- 3  or  to Radio Settings and press  to select.

- 4  or  to Tones/Alerts and press  to select.

- 5  or  to Call Ringers and press  to select.

- 6  or  to and press  to select. The current tone is indicated by a ✓

- 7  or  to the required tone and press  to select. ✓ appears beside selected tone.

Assigning Ring Styles

You can program your radio to sound one of ten predefined ringing tones when receiving a Call Alert or a Text Message from a particular contact.

Procedure:

- 1 **[M]** to access the menu.

- 2 **▲** or **▼** to **Contacts** and press **[M]** to select. The entries are alphabetically sorted.

- 3 **▲** or **▼** to the required alias or ID and press **[M]** to select.

- 4 **▲** or **▼** to **View/Edit** select and press **[M]**.

- 5 **▲** or **▼** to **Ringer** and press **[M]**.

- 6 **▲** or **▼** to required ring style and press **[M]**.

- 7 A **✓** indicates the current selected tone.

- 8 **▲** or **▼** to the required tone and press **[M]** to select. **✓** appears beside selected tone.

- 9 The display shows **Contact Saved**.

The radio sounds out each ring style as you navigate through the list.

All Tones

- 1 **[M]** to access the menu.

- 2 **▲** or **▼** to **Utilities** and press **[M]** to select.

- 3 Go to **Radio Settings**. Select **Tones/Alerts**. Select **All Tones**. Toggle **All Tones** to be enabled or disabled.

Ring Alert Type Selection

You can program your the radio calls to one predetermined vibrate call.

If All Tones status is disabled, the radio displays the All Tone Mute icon. If All Tones status is enabled, the related ring alert type is displayed.

Follow the procedure below.

- 1 **[M]** to access the menu.

- 2 **▲** or **▼** to **Utilities** and press **[M]** to select.

- 3 Go to **Radio Settings**. Select **Tones/Alerts**. Select **Ring Alert Type**. Select from 4 settings, **Ring**, **Vibrate**, **Ring & Vibrate** or **Silent**.

The radio sounds one vibration if it is a momentary ring style. The radio will vibrate repetitively if it is a repetitive ring style. When set to Ring & Vibrate, the radio sounds a specific ring tone if there is any incoming radio transaction (i.e. Call Alert,



Message or Job Ticket). It sounds like a good key tone or missed call. If the notification list is not empty, the radio repeats a vibration every 5 minutes.



Escalating Alarm Tone Volume



You can program your radio to continually alert you when a radio call remains unanswered. This is done by automatically increasing the alarm tone volume over time. This feature is known as Escalert.



Procedure:



- 1  to access the menu.



- 2  or  to Utilities and press  to select.

- 3  or  to Radio Settings and press  to select.

- 4  or  to Tones/Alerts and press  to select.

- 5  or  to Escalert.

- 6 Press  to enable Escalert. The display shows ✓ beside Enabled.
OR
 Press  to disable Escalert. The ✓ disappears from beside Enabled.

NOTE: At Step 5, you can also use  or  to change the selected option

■ Call Log Features

Your radio keeps track of all recent outgoing, answered, and missed Private Calls. Use the call log feature to view and manage recent calls.

You can perform the following tasks in each of your call lists:



- Store ID to Contacts
- Delete
- View Details



Viewing Recent Calls

The lists are Missed, Answered, and Outgoing.



Procedure:

- 1  to access the menu.

- 2  or  to Call Log and press  to select.

- 3  or  to preferred list and press  to select.

- 4 The display shows the most recent entry at the top of the list.

- 5  or  to view the list.

Press the **PTT** button to start a Private Call with the current selected alias or ID.

Missed Calls

Whenever a call is missed, your radio displays a missed call message in notification list.

NOTE: The radio sets up a Private Call if you press the **PTT** button while viewing a missed call number.

Procedure:

- 1 The display shows `Missed Calls`.

- 2 Press Ⓜ to view the missed call ID. The missed call log list appears on display.
Press Ⓜ to store or delete the entry.

Storing an Alias or ID from a Call List

Procedure:

- 1 Ⓜ to access the menu.

- 2 \blacktriangle or \blacktriangledown to `Call Log` and press Ⓜ to select.

- 3 \blacktriangle or \blacktriangledown to required list and press Ⓜ to select.

- 4 \blacktriangle or \blacktriangledown to the required alias or ID and press Ⓜ to select.

- 5 \blacktriangle or \blacktriangledown to `Store` and press Ⓜ to select.

- 6 A blinking cursor appears. If needed, key in the alias for that ID and press Ⓜ .

- 7 The display shows positive mini notice.

You can also store an ID without an alias.

Deleting a Call from a Call List

Procedure:

- 1 Ⓜ to access the menu.

- 2 \blacktriangle or \blacktriangledown to `Call Log` and press Ⓜ to select.

- 3 \blacktriangle or \blacktriangledown to the required list and press Ⓜ to select.

- 4 \blacktriangle or \blacktriangledown to the required alias or ID and press Ⓜ to select.

- 5 \blacktriangle or \blacktriangledown to `Delete Entry?` and press Ⓜ to select.



- 6 Press Ⓜ to select `Yes` to delete the entry. The display shows positive mini notice.
OR
 \blacktriangle or \blacktriangledown to `No` to return to the previous screen



*When you select a call list and it contains no entries, the display shows `List Empty`, and sounds a low tone if Keypad Tones are turned on (see **Turning Keypad Tones On or Off** on page 83).*



Viewing Details from a Call List



Procedure:

- 1  to access the menu.

- 2  or  to Call Log and press  to select.

- 3  or  to the required list and press  to select.

- 4  or  to the required alias or ID and press  to select.

- 5  or  to View Details and press  to select. Display shows details.

■ Call Alert Operation

Call Alert paging enables you to alert a specific radio user to call you back when they are able to do so.

This feature is applicable for subscriber aliases or IDs only and is accessible through the menu via Contacts or manual dial.

Receiving and Responding to a Call Alert

When you receive a Call Alert page, you see the notification list listing a Call Alert with the alias or ID of the calling radio on the display.

Procedure:

- 1 You hear a repetitive tone. The LED blinks yellow.

- 2 Press the **PTT** button while the display still shows the Call Alert in the Notification List to respond with a Private Call.
OR
Press  to exit the Notification List. The alert is moved to the Missed Call Log.



See **Notification List** on **page 82** for details about the Notification List.











See **Call Log Features** on **page 49** for details about the Missed Call List.

Making a Call Alert from the Contacts List

Procedure:

- 1  to access the menu.

- 2  or  to `Contacts` and press  to select.

- 3  or  to the required subscriber alias or ID and press  to select.
OR
 or  to `Manual Dial` and press  to select.
A blinking cursor appears. Enter the subscriber ID you want to page and press .
- 4  or  to `Call Alert` and press .
- 5 The display shows `Call Alert` and the subscriber alias or ID, indicating that the Call Alert has been sent.

- 6 The LED lights up solid green when your radio is sending the Call Alert.

- 7 If the Call Alert acknowledgement is received, the display shows positive mini notice.
OR
If the Call Alert acknowledgement is not received, the display shows negative mini notice.

Making a Call Alert with the One Touch Access Button

Procedure:

- 1 Press the programmed **One Touch Access** button to make a Call Alert to the predefined alias or ID.

- 2 The display shows `Call Alert` and the subscriber alias or ID, indicating that the Call Alert has been sent.

- 3 The LED lights up solid green when your radio is sending the Call Alert.

- 4 If the Call Alert acknowledgement is received, the display shows positive mini notice.
OR
If the Call Alert acknowledgement is not received, the display shows negative mini notice.

■ Emergency Operation

An Emergency Alarm is used to indicate a critical situation. You are able to initiate an Emergency at any time on any screen display even when there is activity on the current channel.

Your dealer can set the duration of a button press for the programmed **Emergency** button, except for long press, which is similar with all other buttons.

The **Emergency** button is assigned with the Emergency On/Off feature. Check with your dealer for the assigned operation of the **Emergency** button.

*If short press the **Emergency** button is assigned to turn on the Emergency mode, then long press the **Emergency** button is assigned to exit the Emergency mode.*

*If long press the **Emergency** button is assigned to turn on the Emergency mode, then short press the **Emergency** button is assigned to exit the Emergency mode.*

Your radio supports **three** Emergency Alarms:

- Emergency Alarm
- Emergency Alarm with Call
- Emergency Alarm with Voice to Follow

In addition, each alarm has the following types:

- **Regular** – Radio transmits an alarm signal and shows audio and/or visual indicators.









- **Silent** – Radio transmits an alarm signal without any audio or visual indicators. Radio receives calls without any sound through the radio's speaker, until you press the **PTT** button to initiate the call.
- **Silent with Voice** – Radio transmits an alarm signal without any audio or visual indicators, but allow incoming calls to sound through the radio's speaker.

Only **ONE** of the Emergency Alarms above can be assigned to the programmed **Emergency** button.

Receiving an Emergency Alarm

On receiving an emergency alarm the emergency icon appears, a tone sounds, the LED blinks red and the radio displays the emergency caller alias. If more than one alarm has occurred all emergency caller aliases are displayed in an Alarm List.

Procedure:

- 1 If a single emergency call alias is displayed, press  to view more details. press  again to view you action details.
OR
If the multiple emergency caller aliases are displayed in the Alarm List,  or  to the required alias and press  to view more details. Press  again to view your action items.
- 2 Press  and select Yes to exit the Alarm List.
To revisit the Alarm List, press  to access the menu and select Alarm List.

When your radio receives an Emergency Alarm, it displays the Emergency Alarm received indications until acknowledgement is sent (if enabled) and you exit the Emergency mode, by long pressing the emergency button.

You will not be able to receive any other indications or displays for any other calls until you exit the Alarm List.

When your radio receives an Emergency Alarm, and you change the radio channel, the radio automatically exits the Alarm list. However, the radio remains in Emergency mode so the new channel displays the Emergency icon and the LED blinks red. When you change the radio channel back to the previous channel, radio continues to display the Emergency icon and the LED continues blinking red.

Responding to an Emergency Alarm

Procedure:

When receiving an Emergency Alarm:

- 1 In the Alarm List, ▲ or ▼ to the required alias.
- 2 Hold the radio vertically 1 to 2 inches (2.5 to 5.0 cm) from your mouth.
If the Channel Free Indication feature is enabled, you will hear a short alert tone the moment the transmitting radio releases the **PTT** button, indicating the channel is now available for use.

- 3 Press **PTT** button to transmit non-emergency voice to the same group that the Emergency Alarm was targeted to. The LED lights up solid green. Your radio remains in the Emergency mode.
- 4 Wait for the Talk Permit Tone to finish (if enabled) and speak clearly into the microphone.
- 5 Release the **PTT** button to listen. When the emergency initiating radio responds, the LED blinks green, the radio unmutes and the response sounds through the radio's speaker. You see the Group Call icon, the group ID, and transmitting radio ID on your display.
- 6 Your radio displays the Alarm List.

Emergency voice can only be transmitted by the emergency initiating radio. All other radios (including the emergency receiving radio) transmit non-emergency voice.

Sending an Emergency Alarm

This feature allows you to send an Emergency Alarm (i.e. a non-voice signal) which triggers an alert indication on a group of radios.

Procedure:

- 1 Press the programmed **Emergency On** button.
- 2 The display shows Tx Alarm and the destination alias. The LED lights up solid green and the Emergency icon appears.

- 3 When an Emergency Alarm acknowledgment is received, the Emergency tone sounds and the LED blinks green. The display shows `Alarm Sent`.

OR

If your radio does not receive an Emergency Alarm acknowledgement, and after all retries have been exhausted, a tone sounds and the display shows `Alarm Failed`.

- 4 Radio exits the Emergency Alarm mode and returns to the Home screen.

If your radio is set to Silent, it will not display any audio or visual indicators during Emergency mode.

Sending an Emergency Alarm with Call

This feature allows you to send an Emergency Alarm to a group of radios. Upon acknowledgement by a radio within the group, the group of radios can communicate over a programmed Emergency channel.

Procedure:

- 1 Press the programmed **Emergency On** button.
- 2 The display shows `Tx Alarm` and the destination alias. The LED lights up solid green and the Emergency icon appears.
- 3 When an Emergency Alarm acknowledgment is received, the Emergency tone sounds and the LED blinks green. The display shows `Alarm Sent`.

- 4 Your radio enters the emergency call mode when the display shows `Emergency` and the destination group alias.

- 5 Hold the radio vertically 1 to 2 inches (2.5 to 5.0 cm) from your mouth.

- 6 Press **PTT** button to make the call. The LED lights up solid green and the group icon appears on the display.

- 7 Wait for the Talk Permit Tone to finish (if enabled) and speak clearly into the microphone.

- 8 Release the **PTT** button to listen.

When you receive a group call, the display shows the caller alias and group alias, the radio unmutes and the group call sounds through the radio's speaker.

- 9 When the channel is free for you to respond, a short alert tone sounds (if the Channel Free Indication feature is enabled). Press the **PTT** button to respond.

OR

Once your call ends, press **Emergency Off** button to exit the Emergency mode.

- 10 The radio returns to the Home screen.

*If your radio is set to Silent, it will not display any audio or visual indicators during Emergency mode, or allow any received calls to sound through the radio's speaker, until you press the **PTT** button to initiate the call.*

If your radio is set to Silent with Voice, it will not display any audio or visual indicators during Emergency mode, but allow incoming calls to sound through the radio's speaker. The indicators will only appear once you press the **PTT** button to initiate, or respond to, the call.

Sending an Emergency Alarm with Voice to Follow

This feature allows you to send an Emergency Alarm to a group of radios. Your radio's microphone is automatically activated, allowing you to communicate with the group of radios without pressing the **PTT** button.

This activated microphone state is also known as "hot mic".

If you press the **PTT** button during the programmed hot mic transmission period, the radio ignores the **PTT** press and remains in Emergency mode.

NOTE: If you press the **PTT** button during hot mic, and continue to press it after the hot mic duration expires, the radio continues to transmit until you release the **PTT** button.

Procedure:

- 1 Press the programmed **Emergency On** button.
- 2 The display shows Tx Alarm and the destination alias. The LED lights up solid green and the Emergency icon appears.
- 3 Once the display shows Alarm Sent, speak clearly into the microphone. When hot mic has been enabled, the radio

automatically transmits without a **PTT** press until the hot mic duration expires.

- 4 While transmitting, the LED lights up solid green and the Emergency icon appears.
- 5 Once the hot mic duration expires, the radio automatically stops transmitting. To transmit again, press the **PTT** button.
- 6 Press **Emergency Off** button to exit the Emergency mode.
- 7 The radio returns to the Home screen.

*If your radio is set to Silent, it will not display any audio or visual indicators during Emergency mode, or allow any received calls to sound through the radio's speaker, until the programmed hot mic transmission period is over, and you press the **PTT** button.*

*If your radio is set to Silent with Voice, it will not display any audio or visual indicators during Emergency mode when you are making the call with hot mic, but allow sound through the radio's speaker when the target radio responds after the programmed hot mic transmission period is over. The indicators will only appear when you press the **PTT** button.*

NOTE: If the Emergency Alarm request fails, the radio does not retry to send the request, and enters the hot mic state directly.

Reinitiating an Emergency Mode

NOTE: This feature is only applicable to the radio sending the Emergency Alarm.

There are two instances where this can happen:

- You change the channel while the radio is in Emergency mode. This exits the Emergency mode. If Emergency Alarm is enabled on this new channel, the radio reinitiates Emergency.
- You press the programmed **Emergency On** button during an Emergency initiation/transmission state. This causes the radio to exit this state, and to reinitiate Emergency.

Exiting Emergency Mode

NOTE: This feature is only applicable to the radio sending the Emergency Alarm.

Your radio exits Emergency mode when **one** of the following occurs:

- Emergency Alarm acknowledgement is received (for **Emergency Alarm** only), **OR**
- All retries to send the alarm have been exhausted, **OR**
- The **Emergency Off** button is pressed.

NOTE: If your radio is powered off, it exits the Emergency mode. The radio will not reinitiate the Emergency mode automatically when it is turned on again.

If you change channels when your radio is in Emergency mode to a channel that has no emergency

system configured, No Emergency is shown on your display.

■ Text Message Features

Your radio is able to receive data, for example a text message, from another radio or an e-mail application.

The **maximum** length of characters for sending a text message, including the subject line (seen when receiving message from an e-mail application), is **140**, whereas for receiving this is 280 characters.

NOTE: Long press  at any time to return to the Home screen.

Writing and Sending a Text Message



Procedure:



Press the programmed **Text Message** button and proceed to Step 3.



OR

Follow the procedure below.









- 1  to access the menu.

- 2  or  to **Messages** and press  to select.

- 3  or  to **Compose** and press  to select.

- 4 A blinking cursor appears.
Use the keypad to type your message.
Press  to move one space to the left.
Press  or the # key to move one space to the right.
Press the *DEL key to delete any unwanted characters.

- 5 Press  once message is composed.

- 6  or  to the required alias or ID and press  to select.
OR
 or  to **Manual Dial** and press  to select.
Key in the subscriber ID and press .
OR
 to edit the message.
 again to discard the message or save it to the Drafts folder.

- 7 The display shows transitional mini notice, confirming your message is being sent.

- 8 If the message is sent, a tone sounds and the display shows positive mini notice.
OR
If the message is not sent, a low tone sounds and the display shows negative mini notice.

*If the text message fails to send, the radio returns you to the Resend option screen (see **Managing Fail-to-Send Text Messages** on page 61).*

Sending a Quick Text Message

Your radio supports a maximum of 50 Quick Text messages as programmed by your dealer.

While Quick Text messages are predefined, you can edit each message before sending it.



Procedure:



Press the programmed **Text Message** button and proceed to Step 3.



OR



Follow the procedure below.

- 1  to access the menu.



 - 2  or  to **Messages** and press  to select.



 - 3  or  to **Quick Text** and press  to select.

 - 4  or  to the required Quick Text and press  to select.

 - 5 A blinking cursor appears.
Use the keypad to edit the message, if required.
Press  to move one space to the left.
Press  or the # key to move one space to the right.
Press the *DEL key to delete any unwanted characters.

 - 6 Press  once message is composed.

 - 7  or  to the required alias or ID and press  to select.
- OR**

 or  to **Manual Dial** and press  to select.

Key in the subscriber alias or ID and press .

OR

 to edit the message.

 again to discard the message or save it to the Drafts folder.

- 8 The display shows transitional mini notice, confirming your message is being sent.

- 9 If the message is sent, a tone sounds and the display shows positive mini notice.
OR
If the message is not sent, a low tone sounds and the display shows negative mini notice.

*If the text message fails to send, the radio returns you to the Resend option screen (see **Managing Fail-to-Send Text Messages** on page 61).*

Sending a Quick Text Message with the One Touch Access Button

Procedure:

- 1 Press the programmed **One Touch Access** button to send a predefined Quick Text message to a predefined alias or ID.

- 2 The display shows transitional mini notice, confirming your message is being sent.
-
- 3 If the message is sent, a tone sounds and the display shows positive mini notice.
OR
If the message is not sent, a low tone sounds and the display shows negative mini notice.
-

*If the text message fails to send, the radio returns you to the Resend option screen (see **Managing Fail-to-Send Text Messages** on page 61).*

Accessing the Drafts Folder

You can save a text message to send it at a later time.

If a **PTT** button press or a mode change causes the radio to exit the text message writing/editing screen while you are in the process of writing or editing a text message, your current text message is automatically saved to the Drafts folder.

The most recent saved text message is always added to the top of the Drafts list.

The Drafts folder stores a maximum of ten (10) last saved messages. When the folder is full, the next saved text message automatically replaces the oldest text message in the folder.

NOTE: Long press  at any time to return to the Home screen.











Viewing a Saved Text Message

Procedure:

Press the programmed **Text Message** button and proceed to Step 3.







OR

Follow the procedure below.

- 1  to access the menu.
-
- 2  or  to **Messages** and press  to select.
-
- 3  or  to **Drafts** and press  to select.
-
- 4  or  to the required message and press  to select.
-

Editing and Sending a Saved Text Message

Procedure:

- 1 Press  again while viewing the message.
-
- 2  or  to **Edit** and press  to select.
A blinking cursor appears.
Use the keypad to edit your message.
Press  to move one space to the left.
Press  or the **#** key to move one space to the right.
Press the ***DEL** key to delete any unwanted characters.
Press  once message is composed.
-

3 ▲ or ▼ to the required alias or ID and press  to select.

OR

▲ or ▼ to **Manual Dial** and press  to select.

Key in the subscriber alias or ID and press .

4 The display shows transitional mini notice, confirming your message is being sent.

5 If the message is sent, a tone sounds and the display shows positive mini notice.

OR

If the message is not sent, a low tone sounds and the display shows negative mini notice.

If the text message fails to send, it is moved to the Sent Items folder and marked with a Send Failed icon.

Deleting a Saved Text Message from Drafts

Procedure:

Press the programmed **Text Message** button and proceed to Step 3.

OR

Follow the procedure below.

1  to access the menu.

2 ▲ or ▼ to **Messages** and press  to select.

3 ▲ or ▼ to **Drafts** and press  to select.

4 ▲ or ▼ to the required message and press  to select.

5 Press  again while viewing the message.

6 ▲ or ▼ to **Delete** and press  to delete the text message.

Managing Fail-to-Send Text Messages

You can select one of the following options while at the **Resend** option screen:

- Resend
- Forward
- Edit

NOTE: The Resend option will not be available if the current channel type (i.e. Conventional or Capacity Plus) does not match the channel type on which the message originally failed to send.

Resending a Text Message

Procedure:

- 1 Press **Ⓜ** to resend the same message to the same subscriber/group alias or ID.

- 2 If the message is sent, a tone sounds and the display shows positive mini notice.
OR
If the message is not sent, a low tone sounds and the display shows negative mini notice.

Forwarding a Text Message

Select **Forward** to send the message to another subscriber/group alias or ID.

Procedure:

- 1 **▲** or **▼** to **Forward** and press **Ⓜ** to select.

- 2 **▲** or **▼** to the required alias or ID and press **Ⓜ** to select.
OR
▲ or **▼** to **Manual Dial** and press **Ⓜ** to select.
Key in the subscriber ID and press **Ⓜ**.

- 3 The display shows transitional mini notice, confirming your message is being sent.

- 4 If the message is sent, a tone sounds and the display shows positive mini notice.

OR

If the message is not sent, a low tone sounds and the display shows negative mini notice.

Editing a Text Message

Select **Edit** to edit the message before sending it.

NOTE: If a subject line is present (for messages received from an e-mail application), you cannot edit it.

Procedure:

- 1 **▲** or **▼** to **Edit** and press **Ⓜ** to select.

- 2 A blinking cursor appears.
Use the keypad to edit your message.
Press **◀** to move one space to the left.
Press **▶** or the **#** key to move one space to the right.
Press the ***DEL** key to delete any unwanted characters.

- 3 Press **Ⓜ** once message is composed.

- 4 **▲** or **▼** to **Send** and press **Ⓜ** to send the message.
OR
▲ or **▼** to **Save** and press **Ⓜ** to save the message to the Drafts folder.
OR
↵ to edit the message.

 again to delete the message or save it to the Drafts folder.

- 5 ▲ or ▼ to the required alias or ID and press  to select.

OR

▲ or ▼ to Manual Dial and press  to select.

Key in the subscriber ID and press .

- 6 The display shows transitional mini notice, confirming your message is being sent.

- 7 If the message is sent, a tone sounds and the display shows positive mini notice.

OR

If the message is not sent, a low tone sounds and the display shows negative mini notice.

Managing Sent Text Messages

Once a message is sent to another radio, it is saved in Sent Items. The most recent sent text message is always added to the top of the Sent Items list.

The Sent Items folder is capable of storing a maximum of thirty (30) last sent messages. When the folder is full, the next sent text message automatically replaces the oldest text message in the folder.

NOTE: Long press  at any time to return to the Home screen.





Viewing a Sent Text Message

Procedure:

Press the programmed **Text Message** button and proceed to Step 3.

OR

Follow the procedure below.

- 1  to access the menu.
- 2 ▲ or ▼ to Messages and press  to select.
- 3 ▲ or ▼ to Sent Items and press  to select.
- 4 ▲ or ▼ to the required message and press  to select.
A subject line may be shown if the message is from an e-mail application.

*The icon at the top right corner of the screen indicates the status of the message (see **Sent Item Icons** on page 17).*

Sending a Sent Text Message

You can select one of the following options while viewing a sent text message:

- Resend
- Forward
- Edit
- Delete

NOTE: The Resend option will not be available if the current channel type (i.e. Conventional or Capacity Plus) does not match the channel type on which the message was originally sent.

Procedure:

- 1 Press **Ⓜ** again while viewing the message.
- 2 **▲** or **▼** to Resend and press **Ⓜ** to select.
- 3 The display shows transitional mini notice, confirming that the same message is being sent to the same target radio.
- 4 If the message is sent, a tone sounds and the display shows positive mini notice.

OR

If the message is not sent, a low tone sounds and the display shows negative mini notice.

*If the message fails to send, the radio returns you to the Resend option screen. Press **Ⓜ** to resend the message to the same subscriber/group alias or ID.*

NOTE: Changing the volume, and pressing any button, except for **Ⓜ**, **◀**, or **▶**, returns you to the message.

The radio exits the Resend option screen if you press the **PTT** button to initiate a Private or Group Call, or to respond to a Group Call. The radio also exits the screen when it receives a text message, an emergency call or alarm, or a call alert.

The display returns to the Resend option screen if you press the **PTT** button to respond to a Private Call (except when the radio is displaying the Missed Call screen), and at the end of an All Call.

Press **▲** or **▼** to access the Forward, Edit, or Delete option screen:

- Select **Forward** to send the selected text message to another subscriber/group alias or ID (see **Forwarding a Text Message** on page 62).
- Select **Edit** to edit the selected text message before sending it (see **Editing a Text Message** on page 62).
- Select **Delete** to delete the text message.

NOTE: If you exit the message sending screen while the message is being sent, the radio updates the status of the message in the Sent Items folder without providing any indication in the display or via sound.

If the radio changes mode or powers down before the status of the message in Sent Items is updated, the radio cannot complete any In-Progress messages and automatically marks it with a Send Failed icon.

The radio supports a maximum of five (5) In-Progress messages at one time. During this period, the radio cannot send any new message and automatically marks it with a Send Failed icon.

Deleting All Sent Text Messages from Sent Items



Procedure:



Press the programmed **Text Message** button and proceed to Step 3.



OR







Follow the procedure below.

- 1  to access the menu.

 - 2  or  to **Messages** and press  to select.

 - 3  or  to **Sent Items** and press  to select.

 - 4  or  to **Delete All** and press  to select.

 - 5  or  to **Yes** and press  to select. The display shows positive mini notice
- OR**
-  or  to **No** and press  to return to the previous screen.

*When you select **Sent Items** and it contains no text messages, the display shows **List Empty**, and sounds a low tone if **Keypad Tones** are turned on (see **Turning Keypad Tones On or Off** on page 83).*

Receiving a Text Message



When your radio receives a message, the display shows the Notification List with the alias or ID of the sender and the message icon.

You can select **Read** when receiving a text message:



NOTE: The radio exits the Text Message alert screen and sets up a Private or Group Call to the sender of the message if the **PTT** button is pressed when the radio is displaying the alert screen.

Reading a Text Message

Procedure:

- 1  or  to **Read?** and press  to select.

 - 2 Selected message in the **Inbox** opens.
A subject line may be shown if the message is from an e-mail application.

 - 3 Press  to return to the **Inbox**.
- OR**
- Press  to reply, quick reply forward, or delete the text message.

Managing Received Text Messages

Use the **Inbox** to manage your text messages. The **Inbox** is capable of storing a maximum of 30 messages.

Your radio supports the following options for text messages:

- Reply
- Quick Reply
- Forward

- Delete

NOTE: The Reply option will not be available if the current channel type (i.e. Conventional or Capacity Plus) does not match the channel type on which the message was received.



Text messages in the Inbox are sorted according to the most recently received.



NOTE: Long press  at any time to return to the Home screen.



Viewing a Text Message from the Inbox



Procedure:

- 1  to access the menu.

- 2  or  to **Messages** and press  to select.

- 3  or  to **Inbox** and press  to select.

- 4  or  and press  to view the messages.
A subject line may be shown if the message is from an e-mail application.

- 5 Press  to select the current message, and press  again to reply, quick reply, forward, or delete that message.
OR
Long press  to return to the Home screen.

Replying to a Text Message from the Inbox



Procedure:

Press the programmed **Text Message** button and proceed to Step 3.

OR

Follow the procedure below.

- 1  to access the menu.

- 2  or  to **Messages** and press  to select.

- 3 ▲ or ▼ to **Inbox** and press **Ⓜ** to select.

- 4 ▲ or ▼ to the required message and press **Ⓜ** to select.
A subject line may be shown if the message is from an e-mail application.

- 5 Press **Ⓜ** once more to access the sub-menu.

- 6 ▲ or ▼ to **Reply** and press **Ⓜ** to select.
OR
▲ or ▼ to **Quick Reply** and press **Ⓜ** to select.
A blinking cursor appears. Use the keypad to edit your message, if required.

- 7 Press **Ⓜ** once message is composed.

- 8 The display shows transitional mini notice, confirming your message is being sent.

- 9 If the message is sent, a tone sounds and the display shows positive mini notice.
OR
If the message is not sent, a low tone sounds and the display shows negative mini notice. *If the message fails to send, the radio returns you to the **Resend** option screen (see **Managing Fail-to-Send Text Messages** on page 61).*

Deleting a Text Message from the Inbox

Procedure:

Press the programmed **Text Message** button and proceed to

Step 3.

OR

Follow the procedure below.

- 1 **Ⓜ** to access the menu.

- 2 ▲ or ▼ to **Messages** and press **Ⓜ** to select.

- 3 ▲ or ▼ to **Inbox** and press **Ⓜ** to select.

- 4 ▲ or ▼ to the required message and press **Ⓜ** to select.
A subject line may be shown if the message is from an e-mail application.

- 5 Press **Ⓜ** once more to access the sub-menu.

- 6 ▲ or ▼ to **Delete** and press **Ⓜ** to select.

- 7 ▲ or ▼ to **Yes** and press **Ⓜ** to select.

- 8 The display shows positive mini notice.

- 9 The screen returns to the **Inbox**.

Deleting All Text Messages from the Inbox

Procedure:

Press the programmed **Text Message** button and proceed to Step 3.

OR

Follow the procedure below.

- 1 **Ⓜ** to access the menu.

2 ▲ or ▼ to Messages and press **Ⓜ** to select.

3 ▲ or ▼ to Inbox and press **Ⓜ** to select.

4 ▲ or ▼ to Delete All and press **Ⓜ** to select.

5 ▲ or ▼ to Yes and press **Ⓜ** to select.

6 The display shows positive mini notice.

*When you select the Inbox and it contains no text messages, the display shows List Empty, and sounds a low tone if Keypad Tones are turned on (see **Turning Keypad Tones On or Off** on page 83).*

■ Job Tickets

Your radio is able to receive Job Tickets, which are messages from the dispatcher listing out tasks that need to be performed.

You can respond to Job Tickets in order to sort them into Job Ticket Folders. By default, the folders are "All", "New", "Started", and "Completed". Check with your dealer or system administrator for an additional 10 folders.

Your radio supports a **maximum** of 100 Job Tickets, all of which can be seen in the "All" folder. New Job Tickets and Job Tickets with recent change in state are listed first. Upon reaching the maximum number of Job Tickets, the next Job Ticket automatically replaces the last Job Ticket in your radio.

NOTE: Job Tickets are retained even after radio is powered down and powered up again.

Accessing the Job Ticket Folder

Procedure:

Press the programmed **Job Ticket** button and proceed to Step 3.

1 **Ⓜ** button to access the main menu.

2 ▲ or ▼ to Job Tickets and press **Ⓜ** to select.

3 ▲ or ▼ to the required folder and press **Ⓜ** to select.

4 ▲ or ▼ to the required Job Ticket and press **Ⓜ** to select.

NOTE: At Step 3, you can also press **5#** and the corresponding number key (1–9) to access the required folder.

Responding to the Job Ticket

Procedure:

Press the programmed **Job Ticket** button and proceed to Step 3.

1 **Ⓜ** button to access the main menu.

2 ▲ or ▼ to Job Tickets and press **Ⓜ** to select.

3 ▲ or ▼ to the required folder and press **Ⓜ** to select.

- 4 ▲ or ▼ to the required Job Ticket and press **Ⓜ** to select.
- 5 Press **Ⓜ** once more to access the sub-menu.
- 6 ▲ or ▼ to the required action and press **Ⓜ** to select.
- 7 The display shows transitional mini notice, confirming your message is being sent.
- 8 If the message is sent, a tone sounds and the display shows positive mini notice.
OR
If the message is not sent, a low tone sounds and the display shows negative mini notice.

NOTE: At Steps 3 and 6, you can also press **LS#** and the corresponding number key (1–9) to access the required folder or action.

Deleting a Job Ticket

Procedure:

Press the programmed **Job Tickets** button and proceed to Step 3.

OR

Follow the procedure below.

- 1 **Ⓜ** to access the menu.
- 2 ▲ or ▼ to **Job Tickets** and press **Ⓜ** to select.
- 3 ▲ or ▼ to **All** and press **Ⓜ** to select.
- 4 ▲ or ▼ to the required Job Ticket and press **Ⓜ** to select.
- 5 Press **Ⓜ** again while viewing the Job Ticket.
- 6 ▲ or ▼ to **Delete** and press **Ⓜ** to select.

NOTE: At Step 4, while viewing the Job Ticket, press ***←** to delete.

■ Privacy

If enabled, this feature helps to prevent eavesdropping by unauthorized users on a channel by the use of a software-based scrambling solution. The signaling and user identification portions of a transmission are not scrambled.

Your radio must have privacy enabled on the channel to send a privacy-enabled transmission. While on a privacy-enabled channel, the radio is still able to receive clear (unscrambled) transmissions.

Your radio supports two types of privacy:

- Basic Privacy
- Enhanced Privacy

Only **ONE** of the privacy types above can be assigned to the radio.

To unscramble a privacy-enabled call or data transmission, your radio must be programmed to have the same Privacy Key (for Basic Privacy), OR the same Key Value and Key ID (for Enhanced Privacy) as the transmitting radio.

If your radio receives a scrambled call that is of a different Privacy Key, OR a different Key Value and Key ID, you will either hear a garbled transmission (Basic Privacy) or nothing at all (Enhanced Privacy).

The LED lights up solid green while the radio is transmitting and double blinks green when the radio is receiving an ongoing privacy-enabled transmission.

NOTE: Some radio models/locations may not offer this Privacy feature. Check with your dealer or system administrator for more information.



Procedure:



Press the programmed **Privacy** button to toggle privacy on or off.



OR



Follow the procedure below.

- 1  to access the menu.

 - 2  or  to Utilities and press  to select.

 - 3  or  to Radio Settings and press  to select.

 - 4  or  to Privacy and press  to select.

 - 5 Press  to enable Privacy. The display shows ✓ beside Enabled.
- OR**
- Press  to disable Privacy. The ✓ disappears from beside Enabled.

If the radio has a privacy type assigned, the secure or unsecure icon appears on the status bar, except when the radio is sending or receiving an Emergency call or alarm.

NOTE: At Step 4, you can also use ◀ or ▶ to change the selected option.

■ Covert Mode

Your radio is capable of Covert Mode. During covert mode, all keypad and programmed button access are blocked. When enabled, all visual indications (display, LED's and backlight) are disabled.

This feature allows audio or tone only via a wired accessory or a Bluetooth accessory.

Entering Covert Mode

Procedure:

Press the  button and the 2, 5 and 8 numeric keys in tandem in home screen.

Exiting Covert Mode

Procedure:

1 Press the  button and the 2, 5 and 8 numeric keys in tandem. Radio will go back to normal mode.

OR

Power cycle the radio via the On/Off button to exit Covert Mode.

■ Dual Tone Multi Frequency (DTMF)

The Dual Tone Multi Frequency (DTMF) feature allows the radio to operate in a radio system with an interface to telephone systems.

Procedure:

To initiate a DTMF call.

- 1 Press and hold the **PTT** button.
 - 2 Enter the desired number, * or #.
-

*You can turn off the DTMF tone by disabling all radio tones and alerts (see **Turning the Radio Tones/Alerts On or Off** on page 83).*

■ IP Site Connect

This feature allows your radio to extend communication beyond the reach of a single repeater site by operating on multiple repeater sites connected together via an Internet Protocol (IP) network.

NOTE: This feature is not applicable in Capacity Plus

When the radio moves out of range from one site and into the range of another, it connects to the new site's base station to send or receive calls/data transmissions. Depending on your settings, this is done automatically or manually.

If the radio is set to do this automatically, it scans through all available sites when the signal from the current site is weak or when the radio is unable to detect any signal from the current site. It then locks on to the base station with the strongest Received Signal Strength Indicator (RSSI) value.

In a manual site search, the radio searches for the next site in the roam list that is currently in range (but which may not have the strongest signal) and locks on to it.

NOTE: Each channel can only have either Scan or Roam enabled, not both at the same time.

Channels with this feature enabled can be added to a particular roam list. The radio searches the channel(s) in the Members list during the automatic roam operation to locate the best site.

A Members list supports a maximum of 16 channels (including the Selected Channel).

NOTE: You cannot manually add or delete an entry to the Members list. Check with your dealer or system administrator for more information.

Locking Automatic Site Search

When the radio is actively searching for a new site:

Procedure:









Press the programmed **Site Lock On/Off** button.

- 1 A tone sounds and the display shows `Site Locked`.
- 2 The LED turns off and the display shows the channel alias.

OR

Procedure:

Use the menu.

- 1  to access the menu.
- 2  or  to `Utilities` and press  to select.
- 3  or  to `Radio Settings` and press  to select.
- 4  or  to `Site Roaming` and press  to select.
- 5  or  to `Lock Site State`.

- 6 Press **[M]** to lock site. The display shows ✓ beside Enabled.
OR
 Press **[M]** to unlock site. The ✓ disappears from beside Enabled. The LED turns off and the radio returns to the Home screen. The display shows the channel alias.

NOTE: At Step 5, you can also use **[Left]** or **[Right]** to change the selected option.

Unlocking Automatic Site Search

Procedure:

Press the programmed **Site Lock On/Off** button.

- 1 A tone sounds and the display shows `Site Unlocked`.
- 2 The LED blinks yellow rapidly when the radio is actively searching for a new site, and turns off once the radio locks on to a site.
- 3 The display shows the channel alias and the site roaming icon appears.

OR

Procedure:

Use the menu.

- 1 **[M]** to access the menu.
- 2 **[Up]** or **[Down]** to `Utilities` and press **[M]** to select.

- 3 **[Up]** or **[Down]** to `Radio Settings` and press **[M]** to select.
- 4 **[Up]** or **[Down]** to `Site Roaming` and press **[M]** to select.
- 5 **[Up]** or **[Down]** to `Unlock Site` and press **[M]** to select. A tone sounds and the display shows `Site Unlocked`.
- 6 The radio returns to the Home screen. The display shows the channel alias and the site roaming icon appears.
- 7 The LED blinks yellow rapidly when the radio is actively searching for a new site, and turns off once the radio locks on to a site.

Starting a Manual Site Search

Procedure:

Press the programmed **Manual Site Roam** button and proceed to Step 6.

OR

Follow the procedure below.

- 1 **[M]** to access the menu.
- 2 **[Up]** or **[Down]** to `Utilities` and press **[M]** to select.
- 3 **[Up]** or **[Down]** to `Radio Settings` and press **[M]** to select.
- 4 **[Up]** or **[Down]** to `Site Roaming` and press **[M]** to select.
- 5 **[Up]** or **[Down]** to `Active Search` and press **[M]** to select.

- 6 A tone sounds and the display shows `Finding Site`.
The LED blinks green.
-
- 7 If a new site is found, a tone sounds and the LED turns off.
The display shows `Site <Alias> Found`.
OR
If there is no available site within range, a tone sounds and the LED turns off. The display shows `Out of Range`.
OR
If a new site is within range, but the radio is unable to connect to it, a tone sounds and the LED turns off. The display shows `Channel Busy`.
-
- 8 The radio returns to the Home screen.
-

■ Security

You can enable or disable any radio in the system. For example, you might want to disable a stolen radio, to prevent the thief from using it, and enable that radio, when it is recovered.

NOTE: Performing Radio Disable and Enable is limited to radios with these functions enabled. Check with your dealer or system administrator for more information.

Radio Disable

Procedure:

Use the programmed **Radio Disable** button.

- 1 Press the programmed **Radio Disable** button.

- 2 ▲ or ▼ to the required alias or ID and press  to select.

- 3 The display shows transitional mini notice, indicating the request is in progress. The LED blinks green.

- 4 Wait for acknowledgment.



- 5 If successful, a positive indicator tone sounds and the display shows positive mini notice.
OR
If unsuccessful, a negative indicator tone sounds and the display shows negative mini notice.







OR



Procedure:

Use the menu.

- 1  to access the menu.

- 2  or  to **Contacts** and press  to select. The entries are alphabetically sorted.

- 3  or  to the required alias or ID and press  to select.
OR
 or  to **Manual Dial** and press  to select.
Key in the subscriber alias or ID and press .

- 4  or  to **Radio Disable** and press  to select. The LED blinks green.

- 5 The display shows transitional mini notice, indicating the request is in progress. The LED blinks green.

- 6 Wait for acknowledgment.



- 7 If successful, a positive indicator tone sounds and the display shows positive mini notice.
OR
If unsuccessful, a negative indicator tone sounds and the display shows negative mini notice.

Do not press  during the Radio Disable operation as you will not get an acknowledgement message.

 **Radio Enable****Procedure:**

Use the programmed **Radio Enable** button.

- 1 Press the programmed **Radio Enable** button.

- 2  or  to the required alias or ID and press  to select.

- 3 The display shows **Radio Enable** and the subscriber alias or ID. The LED lights up solid green.



- 4 Wait for acknowledgment.



- 5 If successful, the radio sounds a positive indicator tone and the display shows positive mini notice.
OR
If unsuccessful, the radio sounds a negative indicator tone and the display shows negative mini notice.

OR**Procedure:**

Use the menu.

- 1  to access the menu.

- 2  or  to **Contacts** and press  to select. The entries are alphabetically sorted.

- 3  or  to the required alias or ID and press  to select.
OR

▲ or ▼ to Manual Dial and press  to select.

Key in the subscriber alias or ID and press .

4 ▲ or ▼ to Radio Enable and press  to select. The LED blinks green.

5 The display shows Radio Enable and the subscriber alias or ID. The LED lights up solid green.

6 Wait for acknowledgment.

7 If successful, the radio sounds a positive indicator tone and the display shows positive mini notice.

OR

If unsuccessful, the radio sounds a negative indicator tone and the display shows negative mini notice.

Do not press  during the Radio Enable operation as you will not get an acknowledgement message.

Lone Worker

This feature prompts an emergency to be raised if there is no user activity, such as any radio button press or activation of the channel selector, for a predefined time.

Following no user activity for a programmed duration, the radio pre-warns the user via an audio indicator once the inactivity timer expires.

If there is still no acknowledgment by the user before the predefined reminder timer expires, the radio initiates an Emergency Alarm.

Only **one** of the following Emergency Alarms is assigned to this feature:

- Emergency Alarm
- Emergency Alarm with Call
- Emergency Alarm with Voice to Follow

The radio remains in the emergency state allowing voice messages to proceed until action is taken. See **Emergency Operation** on page 53 on ways to exit Emergency.

NOTE: This feature is limited to radios with this function enabled. Check with your dealer or system administrator for more information.

■ Password Lock Features

If enabled, this feature allows you to access your radio via password upon powering up.





📄 Accessing the Radio from Password



Procedure:

Power up the radio.

- 1 You hear a continuous tone.
- 2 Enter your current four-digit password with the radio's keypad. The second line of the display shows ●●●●. Press  to proceed.

OR

Enter your current four-digit password. Press  or  to edit each digit's numeric value. Each digit changes to ●. Press  to move to next digit. Press  to confirm your selection.

You hear a positive indicator tone for every digit pressed. Press  to remove the last ● on the display. You hear a negative indicator tone, if you press  when the second line of the display is empty, or if you press more than four digits.

- 3 If the password is correct:
Your radio proceeds to power up. See **Powering Up the Radio** on page 4.
- OR

If the password is incorrect:

The display shows `Wrong Password`. Repeat Step 2. Password less than four digits is incorrect.

OR

After the third incorrect password, the display shows `Wrong Password` and then, shows `Radio Locked`. A tone sounds and the LED double blinks yellow.

*Your radio enters into locked state for 15 minutes, and responds to inputs from **On/Off Button** and programmed **Backlight button** only.*

NOTE: The radio is unable to receive any call, including emergency calls, in locked state.

📄 Unlocking the Radio from Locked State

Procedure:

Wait for 15 minutes. Repeat Steps 1 to 3 in **Accessing the Radio from Password** on page 77.

OR

Power up the radio, if you have powered down the radio during locked state:



- 1 A tone sounds and the LED double blinks yellow. The display shows `Radio Locked`.
 - 2 Wait for 15 minutes. Repeat **Accessing the Radio from Password** on page 77.
-



Your radio restarts the 15 minutes timer for locked state when you power up.



Turning the Password Lock On or Off

Procedure:



- 1  to access the menu.



- 2  or  to Utilities and press  to select.

- 3  or  to Radio Settings and press  to select.

- 4  or  to Passwd Lock and press  to select.

- 5 Enter your current four-digit password.
See Step 2 in **Accessing the Radio from Password on page 77**



- 6 If the password is correct:
Press  to enable Password Lock. The display shows ✓ beside Enabled.
OR
Press  to disable Password Lock. The display shows ✓ beside Enabled.
OR
If the password is incorrect:
The display shows Wrong Password and automatically returns to the previous menu.



NOTE: At Step 6, you can also use  or  to change the selected option.



Changing the Password

Procedure:



- 1  to access the menu.

- 2  or  to Utilities and press  to select.

- 3  or  to Radio Settings and press  to select.

- 4  or  to Passwd Lock and press  to select.

- 5 Enter a four-digit password.
See Step 2 in **Accessing the Radio from Password on page 77**

- 6 If the password is correct:
 or  to Change Pwd and press  to select.
OR
If the password is incorrect:
The display shows Wrong Password and automatically returns to the previous menu.

- 7 Enter a new four-digit password. See Step 2 in **Accessing the Radio from Password on page 77**

- 8 Re-enter the new four-digit password. See Step 2 in **Accessing the Radio from Password on page 77**

- 9 If both of the new password inputs match:
The display shows Password Changed.
OR
If both of the new password inputs do not match:
The display shows Passwords Do Not Match.
-
- 10 The screen automatically returns to the previous menu.
-

■ Bluetooth Operation

This feature allows you to use your radio with a Bluetooth enabled device (accessory) via a wireless Bluetooth connection. Your radio supports both Motorola and COTS (Commercially available Off-The-Shelf) Bluetooth-enabled devices.

Bluetooth operates within a range of 10 meters (32 feet) line of sight. This is an unobstructed path between your radio and your Bluetooth-enabled device.

It is not recommended that you leave your radio behind and expect your Bluetooth-enabled device to work with a high degree of reliability when they are separated.

At the fringe areas of reception, both voice and tone quality will start to sound “garbled” or “broken”. To correct this problem, simply position your radio and Bluetooth-enabled device closer to each other (within the 10-meter/32 feet defined range) to re-establish clear audio reception. Your radio’s Bluetooth function has a maximum power of 2.5 mW (4 dBm) at the 10-meter/32 feet range.



Your radio can support up to 3 simultaneous Bluetooth connections with Bluetooth-enabled devices of unique types. For example, a headset, a scanner, and a PTT-Only Device (POD). Multiple connections with Bluetooth-enabled devices of the same type are not supported.



Refer to your respective Bluetooth-enabled device’s user manual for more details on your Bluetooth-enabled device’s full capabilities.









Turning Bluetooth On and Off

Procedure:

- 1  to access the menu.

- 2  or  to Bluetooth and press  to select.

- 3  or  to My Status and press  to select.



- 4 The display shows On and Off.  or  to On and press  to enable Bluetooth.  appears beside On. The Bluetooth icon appears on the status bar.
OR
 The display shows On and Off.  or  to Off and press  to disable Bluetooth.  appears beside Off.



Finding and Connecting to a Bluetooth Device



Procedure:





- 1 Turn on your Bluetooth-enabled device and place it in pairing mode. Refer to respective Bluetooth-enabled device's user manual.



- 2 On your radio, press  to access the menu.

- 3  or  to Bluetooth and press  to select.

- 4  or  to Devices and press  to select.

- 5  or  to the required device and press  to select.
OR

 or  to Find Devices to locate available devices.
 or  to the required device and press  to select.

- 6  or  to Connect and press  to select. Display shows Connecting to <device>. Your Bluetooth-enabled device may require additional steps to complete the pairing. Refer to respective Bluetooth-enabled device's user manual.

- 7 If successful, the radio display shows <Device> Connected. A tone sounds and  appears beside the connected device. The Bluetooth Connected icon appears on the status bar.
OR
 If unsuccessful, the radio display shows Connecting Failed.

Do not turn off your Bluetooth-enabled device or press  during the finding and connecting operation as this cancels the operation.

NOTE: If pin code is required, use the same entry method as Step 2 in **Accessing the Radio from Password** on **page 77**.

📄 Disconnecting from a Bluetooth Device

Procedure:

- 1 On your radio, press **Ⓜ** to access the menu.

- 2 **▲** or **▼** to `Bluetooth` and press **Ⓜ** to select.

- 3 **▲** or **▼** to `Devices` and press **Ⓜ** to select.

- 4 **▲** or **▼** to the required device and press **Ⓜ** to select.

- 5 **▲** or **▼** to `Disconnect` and press **Ⓜ** to select. Display shows `Disconnecting from <device>`.
Your Bluetooth-enabled device may require additional steps to disconnect. Refer to respective Bluetooth-enabled device's user manual.

- 6 The radio display shows `<Device> Disconnected`. A positive indicator tone sounds and **✓** disappears beside the connected device. The Bluetooth Connected icon disappears on the status bar.

📄 Switching Audio Route

You can toggle audio routing between internal radio speaker and external Bluetooth-enabled accessory.

Procedure:

- 1 Press the programmed **Bluetooth Audio Switch** button.

- 2 A tone sounds and display shows `Route Audio to Radio`.
OR
A tone sounds and display shows `Route Audio to Bluetooth`.

📄 Viewing Device Details

Procedure:

- 1 **Ⓜ** to access the menu.

- 2 **▲** or **▼** to `Bluetooth` and press **Ⓜ** to select.

- 3 **▲** or **▼** to `Devices` and press **Ⓜ** to select.















- 4 **▲** or **▼** to the required device and press **Ⓜ** to select.

- 5 **▲** or **▼** to `View Details` and press **Ⓜ** to select.

Editing Device Name

You can edit the name of available Bluetooth-enabled devices.

Procedure:

- 1  to access the menu.
- 2  or  to Bluetooth and press  to select.
- 3  or  to Devices and press  to select.
- 4  or  to the required device and press  to select.
- 5  or  to Edit Name and press  to select.
- 6 A blinking cursor appears.
Use the keypad to type the required zone.
Press  to move one space to the left.
Press  to move one space to the right.
Press the *DEL key to delete any unwanted characters.
- 7 The display shows Device Name Saved.

■ Notification List

Your radio has a Notification List that collects all your “unread” events on the channel, such as unread text messages and missed ring alert calls. Unread Job Tickets are also stored in the notification list.







The Notification icon appears on the status bar when the Notification List has one or more events.

For TMS and missed call/call alert notification events, the maximum number are 30 TMS and 10 missed calls/call alerts. This maximum number depends on individual feature (job tickets or TMS or missed calls/call alerts) list capability.

After the events are read, they are removed from the Notification List.

Accessing the Notification List

Procedure:

- 1  to access the menu.
- 2  or  to Notification and press  to select.
- 3  or  to the required event and press  to select.

Long press  to return to the Home screen.

Utilities

Turning the Radio Tones/Alerts On or Off

You can enable and disable all radio tones and alerts (except for the incoming Emergency alert tone) if needed. The current settings for alert tones are *ring*, *vibrate*, *ring & vibrate* and *silent* mode.



Procedure:



Press the programmed **All Tones/Alert** button to toggle all tones on or off.



OR



Follow the procedure below.

- 1  to access the menu.

- 2  or  to **Utilities** and press  to select.

- 3  or  to **Radio Settings** and press  to select.



- 4  or  to **Tones/Alerts** and press  to select.

- 5  or  to **All Tones** and press  to select.

- 6 Press  to enable all tones. The display shows ✓ beside Enabled.

OR

Press  to disable all tones. The ✓ disappears from beside Enabled.



NOTE: At Step 5, you can also use  or  to change the selected option.



Turning Keypad Tones On or Off



You can enable and disable keypad tones if needed.



Procedure:

- 1  to access the menu.

- 2  or  to **Utilities** and press  to select.

- 3  or  to **Radio Settings** and press  to select.



- 4  or  to **Tones/Alerts** and press  to select.

- 5  or  to **Keypad Tones** and press  to select.

- 6 Press  to enable keypad tones. The display shows ✓ beside Enabled.

OR















Press  to disable keypad tones. The ✓ disappears from beside Enabled.

NOTE: At Step 5, you can also use  or  to change the selected option.

Setting the Tone Alert Volume Offset Level

You can adjust the Tone Alert Volume Offset level if needed. This feature adjusts the volume of the tones/alerts, allowing it to be higher or lower than the voice volume.

Procedure:

- 1  to access the menu.
- 2  or  to Utilities and press  to select.
- 3  or  to Radio Settings and press  to select.
- 4  or  to Tones/Alerts and press  to select.
- 5  or  to Vol. Offset and press  to select.
- 6  or  to the required volume value. The radio sounds a feedback tone with each corresponding volume value.

NOTE: Press  to keep the required displayed volume value.

OR

Repeat Step 6 to select another volume value.















OR



 to exit without changing the current volume offset settings.

Turning the Talk Permit Tone On or Off

You can enable and disable the Talk Permit Tone if needed.

Procedure:

- 1  to access the menu.
- 2  or  to Utilities and press  to select.
- 3  or  to Radio Settings and press  to select.
- 4  or  to Tones/Alerts and press  to select.
- 5  or  to Talk Permit and press  to select.
- 6 Press  to enable Talk Permit Tone. The display shows ✓ beside Enabled.
OR
Press  to disable Talk Permit Tone. The ✓ disappears from beside Enabled.

NOTE: At Step 5, you can also use  or  to change the selected option.

📄 Changing the Display Mode

You can change radio's display mode between Day or Night, as needed. This affects the color palette of the display.



Procedure:



Press the programmed **Display Mode** button to toggle the display mode settings.



OR



Follow the procedure below.



- 1  to access the menu.

- 2  or  to **Utilities** and press  to select.

- 3  or  to **Radio Settings** and press  to select.

- 4  or  to **Display** and press  to select.

- 5 The display shows **Day Mode** and **Night Mode**.  or  to the required setting and press  to enable. ✓ appears beside selected setting.

NOTE: At Step 4, you can also use  or  to change the selected option.

📄 Adjusting the Display Brightness

You can adjust radio's display brightness as needed.

NOTE: Display brightness cannot be adjusted when “Auto Brightness” is enabled.



Procedure:



Press the programmed **Brightness** button and proceed to Step 5.



OR



Follow the procedure below.

- 1  to access the menu.

- 2  or  to **Utilities** and press  to select.

- 3  or  to **Radio Settings** and press  to select.

- 4  or  to **Brightness** and press  to select.

- 5 The display shows a progress bar. Decrease display brightness by pressing  or increase the display brightness by pressing . Select from setting of 1 to 8. Press  to confirm your entry.

Controlling the Display Backlight



You can enable or disable the radio's display backlight as needed. The setting also affects the Menu Navigation Buttons and keypad backlighting accordingly.



Press the programmed Backlight Auto button to toggle the backlight settings.



OR



Follow the procedure below.

- 1  to access the menu.



- 2  or  to Utilities and press  to select.

- 3  or  to Radio Settings and press  to select.

- 4  or  to Backlight Auto.

- 5 Press  to enable backlight. The display shows ✓ beside Enabled.
OR
Press  to disable backlight. The ✓ disappears from beside Enabled.

*The display backlight and keypad backlighting are automatically turned off if the LED Indicator is disabled (see **Turning the LED Indicator On or Off on page 88**).*



NOTE: At Step 4, you can also use  or  to change the selected option.



Wallpaper Mode



Your radio displays the Wallpaper background on home screen. The user can select from 5 default wallpapers.



Procedure:



- 1  to access the menu.

- 2  or  to Utilities and press  to select.

- 3  or  to Radio Settings and press  to select.

- 4  or  to select Display.

- 5  or  to Wallpaper and press  to select.

NOTE: At Step 5, you can also use  or  to change the selected option.

Screen Saver Mode

The screen saver feature allows the radio to save radio battery time. A Screen Saver Pre Duration is used to track the radio activities before entering screen saver mode.

Radio starts Screen Saver Pre Duration upon power up. Radio enters into screen saver mode when Screen Saver Pre Duration timer expires, the radio exits screen saver mode and responds to related transaction normally upon any user input and over the air transaction.

Radio restarts *Screen Saver Pre Duration* upon any user input and over the air transaction. After being in Screen Saver mode for 5 seconds, radio enters keypad lock state automatically. When any audio or Bluetooth accessory is connected, battery saver mode is enabled, radio enters screen saver mode.

If there is any user input or over the air transaction, the radio exits screen saver mode and responds to user interaction. The *Screen Saver Pre Duration* is restarted and the radio goes back to screen saver mode when it expires.

NOTE: The screen saver mode is to help improve battery life.

Audio Accessory

The audio accessory has two modes: Normal and Battery Saver mode. When audio accessory is plugged in and the setting is in Battery Saver Mode, the radio restarts the timer and goes into screen saver mode. In this scenario, when there is any user input (including user input on radio and accessory attachment/detachment) or when receiving emergency alarm/call, the radio exits screen saver mode and responds to user event as normal. The Screen Saver timer restarts and the radio goes back to screen saver mode when the time allocated expires.



Note: This battery saver mode is to improve battery life. See Screen Saver box SRS for more details in this mode.



Locking and Unlocking the Keypad



You can lock your radio's keypad to avoid inadvertent key entry.

Procedure:



- 1  to access the menu.

- 2  or  to *Utilities* and press  to select.



- 3  or  to *Radio Settings* and press  to select.

- 4  or  to *Keypad Lock* and press  to select.

- 5 The display shows *Keypad Lock* and returns to the Home Screen.

- 6 To unlock the keypad, press  followed by  .

- 7 The display shows *Keypad Unlocked* and returns to the Home Screen.



NOTE: At Step 4, you can also use  or  to change the selected option.



📄 Auto Keypad Lock



You can enable/disable your radio's auto keypad lock to avoid inadvertent key entry.



Procedure:

- 1  to access the menu.

 - 2  or  to Utilities and press  to select.

 - 3  or  to Radio Settings and press  to select.

 - 4  or  to Auto Keypad Lock and press  to select.



 - 5 Press  to enable Auto Keypad Lock. The display shows ✓ beside Enabled.
- OR**
- Press  to disable Auto Keypad Lock. The ✓ disappears from beside Enabled.



📄 Language

You can set your radio display to be in your required language.



Procedure:

- 1  to access the menu.

- 2  or  to Utilities and press  to select.

- 3  or  to Radio Settings and press  to select.

- 4  or  to Languages and press  to select.



- 5 Press  or  to the required language and press  to enable. ✓ appears beside selected language.



📄 Turning the LED Indicator On or Off



You can enable and disable the LED Indicator if needed.



Procedure:

- 1  to access the menu.



 - 2  or  to Utilities and press  to select.

 - 3  or  to Radio Settings and press  to select.

 - 4  or  to LED Indicator and press  to select.

 - 5 Press  to enable LED indicator. The display shows ✓ beside Enabled.
- OR**
- Press  to disable LED indicator. The ✓ disappears from beside Enabled.

*The display backlight, buttons, and keypad backlighting are automatically turned off if the LED indicator is disabled (see **Controlling the Display Backlight** on page 86).*

NOTE: At Step 4, you can also use  or  to change the selected option.

Turning the Voice Operating Transmission (VOX) Feature On or Off

This feature allows you to initiate a hands-free voice activated call on a programmed channel. The radio automatically transmits, for a programmed period, whenever the microphone on the VOX-capable accessory detects voice.

Pressing the **PTT** button during radio operation will disable VOX. To re-enable VOX, do **one** of the following:

- Turn the radio off and power it on again, **OR**
- Follow the procedure below.

NOTE: Turning this feature on or off is limited to radios with this function enabled. Check with your dealer or system administrator for more information.



Procedure:



Press the programmed **VOX** button to toggle the feature on or off.



OR

Follow the procedure below.

- 1  to access the menu.

- 2  or  to Utilities and press  to select.

- 3  or  to Radio Settings and press  to select.



- 4  or  to VOX.

- 5 Press  to enable VOX. The display shows ✓ beside Enabled.

OR

- Press  to disable VOX. The ✓ disappears from beside Enabled.

*If the Talk Permit Tone feature is enabled (see **Turning the Talk Permit Tone On or Off** on page 84), use a trigger word to initiate the call. Wait for the Talk Permit Tone to finish before speaking clearly into the microphone.*

NOTE: At Step 4, you can also use  or  to change the selected option.

Turning the Option Board Feature(s) On or Off

A channel can support up to 6 option board features. Refer to your dealer or system administrator for more information.

Procedure:



Press the programmed **Option Board Feature** button to toggle the feature on or off.



Identifying Cable Type



You can select the type of cable your radio uses.

Procedure:



- 1  to access the menu.

- 2  or  to Utilities and press  to select.

- 3  or  to Radio Settings and press  to select.

- 4  or  to Cable Type and press  to select.

- 5 The current cable type is indicated by a ✓.

NOTE: At Step 4, you can also use  or  to change the selected option.

Voice Announcement

This feature enables the radio to audibly indicate the current Zone or Channel the user has just assigned, or programmable button press. This audio indicator can be customized per customer requirements. This is typically useful when the user is in a difficult condition to read the content shown on the display.

Use the following features to toggle Voice Announcement on or off.



Procedure:



Press the programmed **Voice Announcement** button.



OR



Follow the procedure below.

- 1  to access the menu.

- 2  or  to Utilities and press  to select.

- 3  or  to Radio Settings and press  to select.

- 4  or  to Voice Announcement.

- 5 Press  to enable Voice Announcement. The display shows ✓ beside Enabled.
OR
Press  to disable Voice Announcement. The ✓ disappears from beside Disabled.

NOTE: At Step 3, you can also use ◀ or ▶ to change the selected option

Menu Timer

Set the period of time your radio stays in the menu before it automatically switches to the Home screen.

Procedure:

- 1  to access the menu.

- 2 ▲ or ▼ to Utilities and press  to select.

- 3 ▲ or ▼ to Radio Settings and press  to select.

- 4 ▲ or ▼ to Menu Timer and press  to select.

- 5 ▲ or ▼ to the required setting and press  to select.

Digital Mic AGC

This feature controls the your radio's microphone gain automatically while transmitting on an digital system. It suppresses loud audio or boosts soft audio to a preset value in order to provide a consistent level of audio.

Procedure:

- 1  to access the menu.

- 2 ▲ or ▼ to Utilities and press  to select.

- 3 ▲ or ▼ to Radio Settings and press  to select.

- 4 ▲ or ▼ to Digital Mic AGC.

- 5 Press  to enable Digital Mic AGC. The display shows ✓ beside Enabled.

OR

- Press  to disable Digital Mic AGC. The ✓ disappears from beside Enabled.
-

NOTE: At Step 3, you can also use ◀ or ▶ to change the selected option.

Intelligent Audio

Your radio can automatically adjust its audio volume to overcome background noise in the environment, inclusive of all stationary and non-stationary noise sources. This feature is a Receive-only feature and does not affect Transmit audio.

NOTE: This feature is not applicable during a bluetooth session.

Use the following features to toggle Intelligent Audio on or off.

Procedure:

Press the programmed **Intelligent Audio** button.

OR

Follow the procedure below.

- 1  to access the menu.

- 2 ▲ or ▼ to Utilities and press  to select.

- 3 ▲ or ▼ to Radio Settings and press  to select.

- 4 ▲ or ▼ to Intelligent Audio.

- 5 Press  to enable Intelligent Audio. The display shows ✓ beside Enabled.

OR



Press  to disable Intelligent Audio. The ✓ disappears from beside Enabled.

NOTE: At Step 3, you can also use ◀ or ▶ to change the selected option. See **Accessories on page 89** for recommended Bluetooth-enabled audio accessories with in-built Automatic Volume Control for similar performance.

Accessing General Radio Information

Your radio contains information on the following:

- Battery
- Radio Alias and ID
- Firmware and Codeplug Versions
- Open-Source Software Information

NOTE: Press  at any time to return to the previous screen or long press  to return to the Home screen. The

radio exits the current screen once the inactivity timer expires.

Accessing the Battery Information

Displays information on your radio battery.

Procedure:

- 1  to access the menu.

 - 2 ▲ or ▼ to Utilities and press  to select.

 - 3 ▲ or ▼ to Radio Info and press  to select.

 - 4 ▲ or ▼ to Battery Info and press  to select.

 - 5 The display shows the battery information.
- OR**
- For **IMPRES** batteries **ONLY**. The display reads Recondition Battery if the battery requires reconditioning in an IMPRES charger. After the reconditioning process, the display then shows the battery information.

Checking the Radio Alias and ID

Displays the ID of your radio.



Procedure:



Press the programmed Radio Alias and ID button to check your radio alias and ID. You hear a positive indicator tone.



OR

Follow the procedure below.

- 1  to access the menu.

- 2  or  to Utilities and press  to select.

- 3  or  to Radio Info and press  to select.

- 4  or  to My Number and press  to select.

- 5 The first line of the display shows the radio alias. The second line of the display shows the radio ID



*You can also press the programmed **Radio Alias and ID** button to return to the previous screen.*



Checking the Firmware Version and Codeplug Version



Displays the firmware version on your radio.

Procedure:

- 1  to access the menu.

- 2  or  to Utilities and press  to select.

- 3  or  to Radio Info and press  to select.

- 4  or  to Versions and press  to select.



- 5 The display shows the current firmware and codeplug versions.



Checking the Open-Source Software Information



Displays the open-source software (OSS) information on your radio.

Procedure:

- 1  to access the menu.

- 2  or  to Utilities and press  to select.

- 3  or  to Radio Info and press  to select.

- 4  or  to Versions and press  to select.

- 5 The display shows the Firmware Version information.

Accessories

Your radio is compatible with the accessories listed in this chapter. Contact your dealer for details.

| | |
|-------------------------------------|---------|
| Antennas | page 89 |
| Audio Accessories | page 89 |
| Batteries | page 89 |
| Bluetooth | page 89 |
| Cable | page 90 |
| Carry Devices | page 90 |
| Chargers | page 90 |
| Miscellaneous Accessories | page 91 |

■ Antennas

- 420 – 445 MHz Stubby Antenna, (PMAE4076_)
- 438 – 470 MHz Stubby Antenna, (PMAE4077_)
- 403 – 425 MHz Stubby Antenna, (PMAE4078_)

■ Audio Accessories

- Surveillance Earpiece with in-line microphone and PTT (PMLN5957_)
- Swivel Earpiece with in-line microphone and PTT (PMLN5958_)

■ Batteries

- Lithium-Ion 1800 mAH Battery Pack (HKNN4013_)
- Lithium-Ion 1370 mAH Battery Pack (PMNN4425_)

■ Bluetooth

- HK200 Bluetooth Headset (US) (89409_)
- Operations Critical Wireless Earpiece with 12 inch cable (US) (NNTN8125_)
- Operations Critical Wireless Earpiece with 9.5 inch cable (US) (NNTN8126_)
- Operations Critical Wireless Push-To-Talk POD (US) (NNTN8127_)

■ Cable

- Micro USB Programming Cable (25-124330-01R)

■ Carry Devices

- Carry Holder (PMLN5956_)
- Wrist Strap (PMLN6074_)

■ Chargers

- Multi-Unit Charger, US Plug (PMLN5916_)
- Micro USB Charger, US Plug (PMPN4009_)

■ Miscellaneous Accessories

- 1370 mAH Battery Cover (PMLN6000_)
- 1800 mAH Battery Cover (PMLN6001_)

Batteries and Chargers Warranty

The Workmanship Warranty

The workmanship warranty guarantees against defects in workmanship under normal use and service.

| | |
|--------------------------------|---------------|
| Lithium-Ion (Li-Ion) Batteries | One (1) Year |
| Chargers | Two (2) Years |

The Capacity Warranty

The capacity warranty guarantees 80% of the rated capacity for the warranty duration.

| | |
|------------------------------------------------|-----------|
| Lithium-Ion (Li-Ion) Batteries | 12 Months |
| Batteries, When Used Exclusively with Chargers | 18 Months |

Limited Warranty

MOTOROLA COMMUNICATION PRODUCTS

I. WHAT THIS WARRANTY COVERS AND FOR HOW LONG:

MOTOROLA SOLUTIONS, INC. ("MOTOROLA") warrants the MOTOROLA manufactured Communication Products listed below ("Product") against defects in material and workmanship under normal use and service for a period of time from the date of purchase as scheduled below:

| | |
|--------------------------------------------------------|---------------|
| SL 7550 Digital Portable Radios | Two (2) Years |
| Product Accessories (Excluding Batteries and Chargers) | One (1) Year |

MOTOROLA, at its option, will at no charge either repair the Product (with new or reconditioned parts), replace it (with a new or reconditioned Product), or refund the purchase price of the Product during the warranty period provided it is returned in accordance with the terms of this warranty. Replaced parts or boards are warranted for the balance of the original applicable warranty period. All replaced parts of Product shall become the property of MOTOROLA.

This express limited warranty is extended by MOTOROLA to the original end user purchaser only and is not assignable or transferable to any other party. This is the complete warranty for the Product manufactured by MOTOROLA. MOTOROLA assumes no

obligations or liability for additions or modifications to this warranty unless made in writing and signed by an officer of MOTOROLA.

Unless made in a separate agreement between MOTOROLA and the original end user purchaser, MOTOROLA does not warrant the installation, maintenance or service of the Product.

MOTOROLA cannot be responsible in any way for any ancillary equipment not furnished by MOTOROLA which is attached to or used in connection with the Product, or for operation of the Product with any ancillary equipment, and all such equipment is expressly excluded from this warranty. Because each system which may use the Product is unique, MOTOROLA disclaims liability for range, coverage, or operation of the system as a whole under this warranty.

II. GENERAL PROVISIONS:

This warranty sets forth the full extent of MOTOROLA'S responsibilities regarding the Product. Repair, replacement or refund of the purchase price, at MOTOROLA'S option, is the exclusive remedy. THIS WARRANTY IS GIVEN IN LIEU OF ALL OTHER EXPRESS WARRANTIES. IMPLIED WARRANTIES, INCLUDING WITHOUT LIMITATION, IMPLIED WARRANTIES OF MERCHANTABILITY AND FITNESS FOR A PARTICULAR PURPOSE, ARE LIMITED TO THE DURATION OF THIS LIMITED WARRANTY. IN NO EVENT SHALL MOTOROLA BE LIABLE FOR DAMAGES IN EXCESS OF THE PURCHASE PRICE OF THE PRODUCT, FOR ANY LOSS OF USE, LOSS OF TIME, INCONVENIENCE, COMMERCIAL LOSS, LOST PROFITS OR SAVINGS OR OTHER INCIDENTAL, SPECIAL OR CONSEQUENTIAL DAMAGES ARISING OUT OF THE USE OR

INABILITY TO USE SUCH PRODUCT, TO THE FULL EXTENT SUCH MAY BE DISCLAIMED BY LAW.

III. STATE LAW RIGHTS:

SOME STATES DO NOT ALLOW THE EXCLUSION OR LIMITATION OF INCIDENTAL OR CONSEQUENTIAL DAMAGES OR LIMITATION ON HOW LONG AN IMPLIED WARRANTY LASTS, SO THE ABOVE LIMITATION OR EXCLUSIONS MAY NOT APPLY.

This warranty gives specific legal rights, and there may be other rights which may vary from state to state.

IV. HOW TO GET WARRANTY SERVICE:

You must provide proof of purchase (bearing the date of purchase and Product item serial number) in order to receive warranty service and, also, deliver or send the Product item, transportation and insurance prepaid, to an authorized warranty service location. Warranty service will be provided by MOTOROLA through one of its authorized warranty service locations. If you first contact the company which sold you the Product (e.g., dealer or communication service provider), it can facilitate your obtaining warranty service. You can also call MOTOROLA at 1-800-927-2744 US/Canada.

V. WHAT THIS WARRANTY DOES NOT COVER:

- A) Defects or damage resulting from use of the Product in other than its normal and customary manner.
- B) Defects or damage from misuse, accident, water, or neglect.

- C) Defects or damage from improper testing, operation, maintenance, installation, alteration, modification, or adjustment.
- D) Breakage or damage to antennas unless caused directly by defects in material workmanship.
- E) A Product subjected to unauthorized Product modifications, disassembles or repairs (including, without limitation, the addition to the Product of non-MOTOROLA supplied equipment) which adversely affect performance of the Product or interfere with MOTOROLA's normal warranty inspection and testing of the Product to verify any warranty claim.
- F) Product which has had the serial number removed or made illegible.
- G) Rechargeable batteries if:
 - (1) any of the seals on the battery enclosure of cells are broken or show evidence of tampering.
 - (2) the damage or defect is caused by charging or using the battery in equipment or service other than the Product for which it is specified.
- H) Freight costs to the repair depot.
- I) A Product which, due to illegal or unauthorized alteration of the software/firmware in the Product, does not function in accordance with MOTOROLA's published specifications or the FCC certification labeling in effect for the Product at the time the Product was initially distributed from MOTOROLA.
- J) Scratches or other cosmetic damage to Product surfaces that does not affect the operation of the Product.
- K) Normal and customary wear and tear.

VI. PATENT AND SOFTWARE PROVISIONS:

MOTOROLA will defend, at its own expense, any suit brought against the end user purchaser to the extent that it is based on a claim that the Product or parts infringe a United States patent, and MOTOROLA will pay those costs and damages finally awarded against the end user purchaser in any such suit which are attributable to any such claim, but such defense and payments are conditioned on the following:

- A) that MOTOROLA will be notified promptly in writing by such purchaser of any notice of such claim;
- B) that MOTOROLA will have sole control of the defense of such suit and all negotiations for its settlement or compromise; and
- C) should the Product or parts become, or in MOTOROLA's opinion be likely to become, the subject of a claim of infringement of a United States patent, that such purchaser will permit MOTOROLA, at its option and expense, either to procure for such purchaser the right to continue using the Product or parts or to replace or modify the same so that it becomes non-infringing or to grant such purchaser a credit for the Product or parts as depreciated and accept its return. The depreciation will be an equal amount per year over the lifetime of the Product or parts as established by MOTOROLA.

MOTOROLA will have no liability with respect to any claim of patent infringement which is based upon the combination of the Product or parts furnished hereunder with software, apparatus or devices not furnished by MOTOROLA, nor will MOTOROLA have any liability for the use of ancillary equipment or software not furnished by MOTOROLA which is attached to or used in connection with the Product. The foregoing states the entire liability of MOTOROLA with respect to infringement of patents by the Product or any parts thereof.

Laws in the United States and other countries preserve for MOTOROLA certain exclusive rights for copyrighted MOTOROLA software such as the exclusive rights to reproduce in copies and distribute copies of such MOTOROLA software. MOTOROLA software may be used in only the Product in which the software was originally embodied and such software in such Product may not be replaced, copied, distributed, modified in any way, or used to produce any derivative thereof. No other use including, without limitation, alteration, modification, reproduction, distribution, or reverse engineering of such MOTOROLA software or exercise of rights in such MOTOROLA software is permitted. No license is granted by implication, estoppel or otherwise under MOTOROLA patent rights or copyrights.

VII. GOVERNING LAW:

This Warranty is governed by the laws of the State of Illinois, U.S.A.



Motorola Solutions, Inc.
1303 East Algonquin Road
Schaumburg, Illinois 60196 U.S.A.

MOTOROLA, MOTO, MOTOROLA SOLUTIONS and the Stylized M logo are trademarks or registered trademarks of Motorola Trademark Holdings, LLC and are used under license. All other trademarks are the property of their respective owners.
© 2011 Motorola Solutions, Inc. All rights reserved.
November 2011.

www.motorolasolutions.com/slseries



68009554001-A

