

Professional Digital Two-Way Radio System

MOTOTRBO™ XPR™ 4300 / XPR™ 4350

Numeric Display Mobile

User Guide



Declaration of Conformity

This declaration is applicable to your radio **only** if your radio is labeled with the FCC logo shown below.

DECLARATION OF CONFORMITY

Per FCC CFR 47 Part 2 Section 2.1077(a)



Responsible Party
Name: Motorola, Inc.

Address: 1301 East Algonquin Road, Schaumburg, IL 60196-1078, U.S.A.
Phone Number: 1-888-567-7347

Hereby declares that the product:

Model Name: **XPR 4300/XPR 4350**

conforms to the following regulations:

FCC Part 15, subpart B, section 15.107(a), 15.107(d) and section 15.109(a)

Class B Digital Device

As a personal computer peripheral, this device complies with Part 15 of the FCC Rules. Operation is subject to the following two conditions:

1. This device may not cause harmful interference, and
2. This device must accept any interference received, including interference that may cause undesired operation.

Note: This equipment has been tested and found to comply with the limits for a Class B digital device, pursuant to part 15 of the FCC Rules. These limits are designed to provide reasonable protection against harmful interference in a residential installation. This equipment generates, uses and can radiate radio frequency energy and, if not installed and used in accordance with the instructions, may cause harmful interference to radio communications. However, there is no guarantee that interference will not occur in a particular installation.

If this equipment does cause harmful interference to radio or television reception, which can be determined by turning the equipment off and on, the user is encouraged to try to correct the interference by one or more of the following measures:

- Reorient or relocate the receiving antenna.
- Increase the separation between the equipment and receiver.
- Connect the equipment into an outlet on a circuit different from that to which the receiver is connected.
- Consult the dealer or an experienced radio/TV technician for help.

Contents

This User Guide contains all the information you need to use the MOTOTRBO XPR Series Digital Mobile Radios.

Declaration of Conformity	i
Important Safety Information	v
Product Safety and RF Exposure Compliance	v
Software Version	v
Computer Software Copyrights	vi
Getting Started	1
How to Use This Guide	1
What Your Dealer/System Administrator Can Tell You	1
Powering Up the Radio	2
Adjusting the Volume	2
Identifying Radio Controls	3
Radio Controls You Will Be Using	3
Programmable Buttons	4
Assignable Radio Functions	4
Assignable Settings/Utility Functions	4

Push-To-Talk (PTT) Button	5
Switching Between Analog and Digital Mode	5
Identifying Status Indicators	6
Display Icons	6
LED Indicators	6
Audio Tones	7
Indicator Tones	7
Receiving and Making Calls	8
Selecting a Zone	8
Selecting a Radio Channel, Subscriber ID, or Group ID	8
Receiving and Responding to a Radio Call	9
Receiving and Responding to a Group Call	9
Receiving and Responding to a Private Call	10
Receiving an All Call	10
Making a Radio Call	11
Making a Call with the Channel Rocker	11
Making a Group Call	11
Making a Private Call	11
Making an All Call	12
Making a Group or Private Call with the One Touch Call Button	12
Talkaround	13

Permanent Monitor	13	Sending a Quick Text Message	20
Advanced Features	14	Privacy	20
Scan Lists	14	Utilities	21
Scan	14	Setting the Squelch Level	21
Starting and Stopping Scan	14	Setting the Power Level	21
Responding to a Transmission During a Scan	15	Turning the Option Board Feature(s) On or Off	21
Deleting a Nuisance Channel	15	Turning the Public Address System On or Off	21
Restoring a Nuisance Channel	15	Turning the External Public Address System On or Off	22
Call Indicator Settings	16	Turning Horns/Lights On or Off	22
Escalating Alarm Tone Volume	16	Turning Radio Tones/Alerts On or Off	22
Call Alert Operation	16	Accessories	23
Receiving and Acknowledging a Call Alert	16	Antennas	23
Making a Call Alert with the One Touch Call Button	16	Audio	24
Emergency Operation	17	Cables	24
Sending an Emergency Alarm	17	Desktop Accessories	25
Sending an Emergency Alarm with Call	18	Mounting Kits	25
Sending an Emergency Alarm with Voice to Follow	18	Speakers	25
Reinitiating an Emergency Mode	19	Miscellaneous Accessories	25
Exiting an Emergency Mode	19	Limited Warranty	26
Text Messaging Features	20		

Important Safety Information

Product Safety and RF Exposure Compliance



Caution

Before using this product, read the operating instructions for safe usage contained in the Product Safety and RF Exposure booklet enclosed with your radio.

ATTENTION!

This radio is restricted to occupational use only to satisfy FCC RF energy exposure requirements.

Before using this product, read the RF energy awareness information and operating instructions in the Product Safety and RF Exposure booklet enclosed with your radio (Motorola Publication part number 6881095C99) to ensure compliance with RF energy exposure limits.

For a list of Motorola-approved antennas and other accessories, visit the following website:

<http://www.motorola.com/governmentandenterprise>

Software Version

All the features described in the following sections are supported by the radio's software version **R01.02.01**.

Please check with your dealer or system administrator for more details of all the features supported.

Computer Software Copyrights

The Motorola products described in this manual may include copyrighted Motorola computer programs stored in semiconductor memories or other media. Laws in the United States and other countries preserve for Motorola certain exclusive rights for copyrighted computer programs including, but not limited to, the exclusive right to copy or reproduce in any form the copyrighted computer program. Accordingly, any copyrighted Motorola computer programs contained in the Motorola products described in this manual may not be copied, reproduced, modified, reverse-engineered, or distributed in any manner without the express written permission of Motorola. Furthermore, the purchase of Motorola products shall not be deemed to grant either directly or by implication, estoppel, or otherwise, any license under the copyrights, patents or patent applications of Motorola, except for the normal non-exclusive license to use that arises by operation of law in the sale of a product.

The AMBE+2™ voice coding Technology embodied in this product is protected by intellectual property rights including patent rights, copyrights and trade secrets of Digital Voice Systems, Inc.

This voice coding Technology is licensed solely for use within this Communications Equipment. The user of this Technology is explicitly prohibited from attempting to decompile, reverse engineer, or disassemble the Object Code, or in any other way convert the Object Code into a human-readable form.

U.S. Pat. Nos. #5,870,405, #5,826,222, #5,754,974, #5,701,390, #5,715,365, #5,649,050, #5,630,011, #5,581,656, #5,517,511, #5,491,772, #5,247,579, #5,226,084 and #5,195,166.

Getting Started

Take a moment to review the following:

How to Use This Guide	page 1
What Your Dealer/System Administrator Can Tell You	page 1
Powering Up the Radio	page 2
Adjusting the Volume	page 2

■ How to Use This Guide

This User Guide covers the basic operation of the MOTOTRBO Mobiles with Numeric Display.

However, your dealer or system administrator may have customized your radio for your specific needs. Check with your dealer or system administrator for more information.

Throughout this publication, two icons are used to differentiate Analog mode and Digital mode only features:



Indicates an Analog mode only feature.



Indicates a Digital mode only feature.

For features that are available in both Analog and Digital modes, no icon is shown.

■ What Your Dealer/System Administrator Can Tell You

You can consult your dealer or system administrator about the following:

- Is your radio programmed with any preset conventional channels?
- Which buttons have been programmed to access other features?
- What optional accessories may suit your needs?

■ Powering Up the Radio

Press the **On/Off Button** briefly.

The green LED blinks and the numeric display screen lights up.

A brief tone sounds, indicating that the power up test is successful.

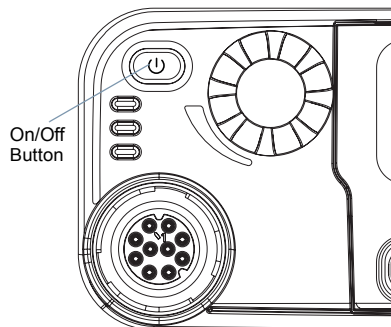

NOTE: There is no power up tone if the radio tones/alerts function is disabled (see **Turning Radio Tones/Alerts On or Off** on page 22).

If your radio does not power up, contact your dealer.

To turn off the radio, press and hold the On/Off Button.

■ Adjusting the Volume

To increase the volume, turn the **Volume Knob** clockwise.

To decrease the volume, turn this knob counterclockwise.

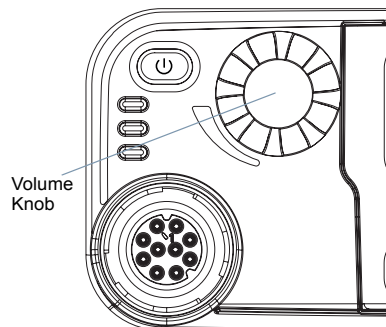

Identifying Radio Controls

Take a moment to review the following:

Radio Controls You Will Be Using page 3
 Programmable Buttons page 4
 Push-To-Talk (PTT) Button page 5
 Switching Between Analog and Digital Mode page 5

■ Radio Controls You Will Be Using

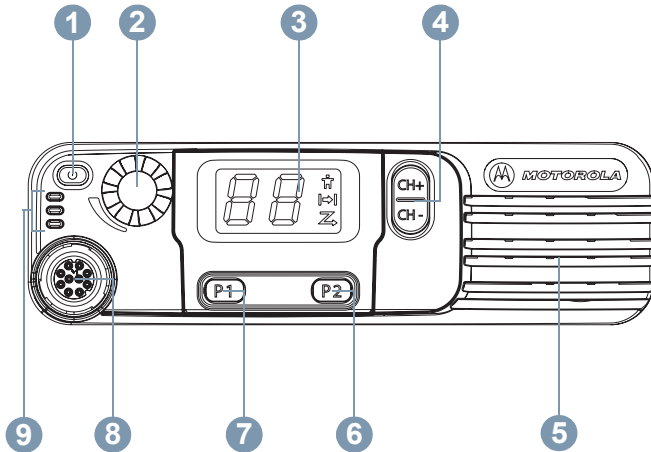

- 1 On/Off Button
- 2 Volume Knob
- 3 Display
- 4 Channel Rocker
- 5 Speaker
- 6 Front Button P2*
- 7 Front Button P1*
- 8 Accessory Connector
- 9 LED Indicators

** These buttons are programmable.*

■ Programmable Buttons

Your dealer can program the programmable buttons as shortcuts to radio functions or preset channels/groups depending on the duration of a button press:

- Press – Pressing and releasing rapidly.
- Long press – Pressing and holding for the preprogrammed duration (between 0.25 seconds and 3.75 seconds).
- Hold down – Keeping the button pressed.

📄 Assignable Radio Functions

Emergency – Depending on the programming, initiates or cancels an Emergency Alarm or Call.

Ext PA On/Off – Toggles the audio routing between the connected public address (PA) loudspeaker amplifier and the radio's internal public address (PA) system.

Nuisance Channel Delete – Temporarily removes an unwanted channel, except for the Selected Channel, from the scan list. The Selected Channel refers to the user's selected zone/channel combination from which scan is initiated.

One Touch Call  – Directly initiates a predefined Group or Private Call, a Call Alert or a Quick Text message.

Option Board Feature – Toggles option board feature(s) on or off for option board-enabled channels.

PA On/Off – Toggles the radio's internal public address (PA) system on or off.

Permanent Monitor – Monitors a selected channel for all radio traffic until function is disabled.

Privacy  – Toggles privacy on or off.

Repeater/Talkaround – Toggles between using a repeater and communicating directly with another radio.

Scan – Toggles scan on or off.

Telemetry Control  – Controls the Output Pin on a local or remote radio.

Zone – Allows selection from a list of zones.

📄 Assignable Settings/Utility Functions

All Tones/Alerts – Toggles all tones on or off.

Power Level – Toggles transmit power level between high and low.

Squelch  – Toggles squelch level between normal and tight.

■ Push-To-Talk (PTT) Button

The **PTT** button on the side of the microphone serves two basic purposes:

- While a call is in progress, the **PTT** button allows the radio to transmit to other radios in the call.

Press and hold down **PTT** button to talk. Release the **PTT** button to listen.

The microphone is activated when the **PTT** button is pressed.

- While a call is not in progress, the **PTT** button is used to make a new call (see **Making a Radio Call** on page 11).

Depending on programming, if the Talk Permit Tone is enabled, wait until the short alert tone ends before talking.

-  *During a call, if the Channel Free Indication feature is enabled on your radio (programmed by your dealer), you will hear a short alert tone the moment the target radio (the radio that is receiving your call) releases the **PTT** button, indicating the channel is free for you to respond.*

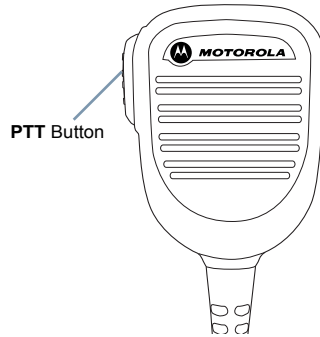

You will also hear the Channel Free Indication tone if your call is interrupted, for example when the radio receives an Emergency Call.

*You can turn off the Channel Free Indication tone by disabling all radio tones and alerts (see **Turning Radio Tones/Alerts On or Off** on page 22).*

■ Switching Between Analog and Digital Mode

Each channel in your radio can be configured as an analog channel or a digital channel. Use the Channel Rocker to switch between an analog or a digital channel.

When switching from digital to analog mode, certain features are unavailable.

Your radio also has features available in both analog and digital mode. However, the minor differences in the way each feature works does **NOT** affect the performance of your radio.

NOTE: Your radio also switches between digital and analog modes during a dual mode scan (see **Scan** on page 14).

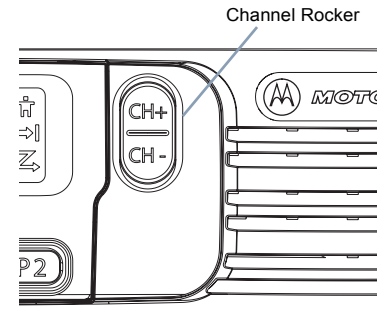

Identifying Status Indicators

Your radio indicates its operational status through the following:

LED Indicators	page 6
Audio Tones	page 7
Indicator Tones	page 7

■ Display Icons

The seven-segment display shows radio channel and status. The following are the icons that appear on the radio's display.



Private Call

Indicates a Private Call in progress.



Talkaround

In the absence of a repeater, radio is currently configured for direct radio to radio communication.



Scan

Scan feature is activated.

■ LED Indicators

LED indicators show the operational status of your radio.

Blinking red – Radio is receiving an emergency transmission or has failed the self-test upon powering up.

Solid yellow – Radio is monitoring a channel.

Blinking yellow – Radio is scanning for activity or receiving a Call Alert.

Solid green – Radio is transmitting.

Blinking green – Radio is powering up, receiving a non-privacy-enabled call or data, or detecting activity over the air.

Rapidly blinking green – Radio is receiving a privacy-enabled call or data. 

NOTE: When the green LED blinks, it indicates the radio detects activity over the air. Due to the nature of the digital protocol, this activity may or may not affect the radio's programmed channel.

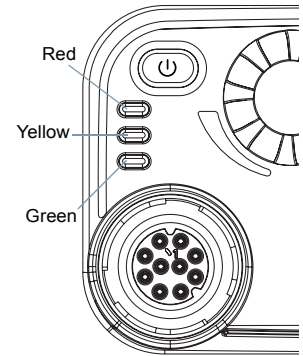

Upon a **PTT** button press, if the radio is programmed for polite operation, the radio automatically determines whether a transmission is permitted via a Talk Permit or a Talk Denial tone.

■ Audio Tones

Alert tones provide you with audible indications of the radio's status or the radio's response to data received.

Continuous Tone A monotone sound. Sounds continuously until termination.



Periodic Tone Sounds periodically depending on the duration set by the radio. Tone starts, stops and repeats itself.



Repetitive Tone A single tone that repeats itself until it is terminated by the user.



Momentary Tone Sounds only once for a short period of time defined by the radio.



■ Indicator Tones

High pitched tone 

Low pitched tone 



Positive Indicator Tone



Negative Indicator Tone

Receiving and Making Calls

Once you understand how your MOTOTRBO Mobile is configured, you are ready to use your radio.

Use this navigation guide to familiarize yourself with the basic Call features:

Selecting a Zone	page 8
Selecting a Radio Channel, Subscriber ID, or Group ID	page 8
Receiving and Responding to a Radio Call.	page 9
Making a Radio Call	page 11
Talkaround	page 13
Permanent Monitor	page 13

Selecting a Zone

A zone is a group of channels. Your radio supports up to a maximum of 2 zones.

Procedure:

- 1 Press the preprogrammed **Zone** button.
- 2 You hear a positive indicator tone, indicating the radio has switched from Zone 1 to Zone 2.
OR
You hear a negative indicator tone, indicating the radio has switched from Zone 2 to Zone 1.

Selecting a Radio Channel, Subscriber ID, or Group ID

Procedure:

Once the required zone is set (if you have multiple zones in your radio), press the Channel Rocker to select the number that represents the channel, subscriber ID, or group ID.

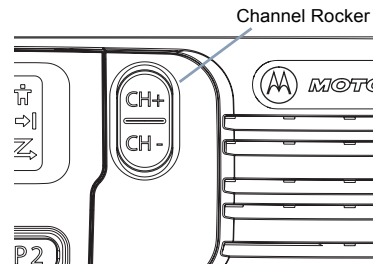

■ Receiving and Responding to a Radio Call

Once the channel, subscriber ID, or group ID is set, you can proceed to receive and respond to calls.

The green LED lights up while the radio is transmitting and blinks when the radio is receiving.

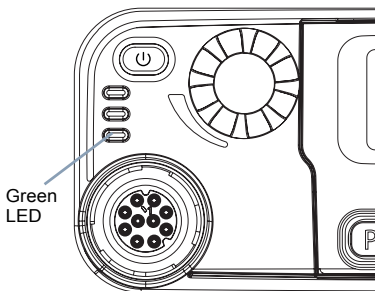

NOTE: The green LED lights up while the radio is transmitting and blinks rapidly when the radio is receiving a privacy-enabled call.

To unscramble a privacy-enabled call, your radio must have the same Privacy Key (programmed by your dealer) as the transmitting radio (the radio you are receiving the call from). See **Privacy** on page 20 for

more information. 

📄 Receiving and Responding to a Group Call

To receive a call from a group of users, your radio must be configured as part of that group.

Procedure:

When you receive a Group Call:

- 1 The green LED blinks.
 -  If the Channel Free Indication feature is enabled, you will hear a short alert tone the moment the transmitting radio releases the **PTT** button, indicating the channel is free for you to respond.
- 2 Press the **PTT** button to respond to the call. The green LED lights up.
- 3 Wait for the Talk Permit Tone to finish (if enabled) and speak clearly into the microphone.
- 4 Release the **PTT** button to listen.
- 5 If there is no voice activity for a predetermined period of time, the call ends.

See **Making a Group Call** on page 11 for details on making a Group Call.

Receiving and Responding to a Private Call

A Private Call is a call from an individual radio to another individual radio.

There are two types of Private Calls. The first type, where a radio presence check is performed prior to setting up the call, while the other sets up the call immediately.

When your radio is checked, the green LED blinks.

Only one of these call types can be programmed to your radio by your dealer.

Procedure:

When you receive a private call:

- 1 The green LED blinks.
If the Channel Free Indication feature is enabled, you will hear a short alert tone the moment the transmitting radio releases the **PTT** button, indicating the channel is free for you to respond.

- 2 Press the **PTT** button to respond to the call. The green LED lights up.

- 3 Wait for the Talk Permit Tone to finish (if enabled) and speak clearly into the microphone.

- 4 Release the **PTT** button to listen.

- 5 If there is no voice activity for a predetermined period of time, the call ends.

- 6 You hear a short tone.

See **Making a Private Call** on page 11 for more details on making a private call.

Receiving an All Call

An All Call is a call from an individual radio to every radio on the channel. It is used to make important announcements requiring the user's full attention.

Procedure:

When you receive an All Call:

- 1 A tone sounds and the green LED blinks.

- 2 If there is no voice activity for a predetermined period of time, the All Call ends.
 If the Channel Free Indication feature is enabled, you will hear a short alert tone the moment the transmitting radio releases the **PTT** button, indicating the channel is now available for use.

You cannot respond to an All Call.

NOTE: The radio stops receiving the All Call if you switch to a different channel while receiving the call. During an All Call, you will **not** be able to use any preprogrammed button functions until the call ends.

■ Making a Radio Call

You can select a channel, subscriber ID or group by using:

- Channel Rocker
- A preprogrammed **One Touch Call** button 

NOTE: Your radio must have the Privacy feature enabled on the channel to send a privacy-enabled transmission. Only target radios with the same Privacy Key as your radio will be able to unscramble the transmission.

See **Privacy** on page 20 for more information. 

Making a Call with the Channel Rocker

Making a Group Call

To make a call to a group of users, your radio must be configured as part of that group.

Procedure:

- 1 Press the Channel Rocker to select the channel with the active group ID.
- 2 Press the **PTT** button to make the call. The green LED lights up.
- 3 Wait for the Talk Permit Tone to finish (if enabled) and speak clearly into the microphone.

- 4 Release the **PTT** button to listen. When the target radio responds, the green LED blinks.
- 5 If the Channel Free Indication feature is enabled, you will hear a short alert tone the moment the target radio releases the **PTT** button, indicating the channel is free for you to respond. Press the **PTT** button to respond. 

OR

If there is no voice activity for a predetermined period of time, the call ends.

Making a Private Call

Procedure:

- 1 Press the Channel Rocker to select the channel with the active subscriber ID.
 - 2 Press the **PTT** button to make the call. The green LED lights up.
 - 3 Wait for the Talk Permit Tone to finish (if enabled) and speak clearly into the microphone.
 - 4 Release the **PTT** button to listen. When the target radio responds, the green LED blinks.
 - 5 If the Channel Free Indication feature is enabled, you will hear a short alert tone the moment the target radio releases the **PTT** button, indicating the channel is free for you to respond. Press the **PTT** button to respond.
- OR**

If there is no voice activity for a predetermined period of time, the call ends.

- 6 You hear a short tone.
-

Making an All Call

This feature allows you to transmit to all users on the channel. Your radio must be programmed to allow you to use this feature.

Procedure:

- 1 Press the Channel Rocker to select the channel with the active All Call group ID.
 - 2 Press the **PTT** button to make the call. The green LED lights up.
 - 3 Wait for the Talk Permit Tone to finish (if enabled) and speak clearly into the microphone.
-

Users on the channel cannot respond to an All Call.

Making a Group or Private Call with the One Touch Call Button

The One Touch Call feature allows you to make a Group or Private Call to a predefined ID easily. This feature can be assigned to a short or long programmable button press.

You can **ONLY** have one ID assigned to a **One Touch Call** button. Your radio can have multiple **One Touch Call** buttons programmed.

Procedure:

- 1 Press the preprogrammed **One Touch Call** button to make a Group or Private Call to the predefined ID.
 - 2 Press the **PTT** button to make the call. The green LED lights up.
 - 3 Wait for the Talk Permit Tone to finish (if enabled) and speak clearly into the microphone.
 - 4 Release the **PTT** button to listen. When the target radio responds, the green LED blinks.
 - 5 If the Channel Free Indication feature is enabled, you will hear a short alert tone the moment the target radio releases the **PTT** button, indicating the channel is free for you to respond. Press the **PTT** button to respond.
-

OR

If there is no voice activity for a predetermined period of time, the call ends.

For a Private Call, you hear a short tone when the call ends.

■ Talkaround

You can continue to communicate when your repeater is not operating, or when your radio is out of the repeater's range but within talking range of other radios. This is called "talkaround".

Procedure:

- 1 Press the preprogrammed **Repeater/Talkaround** button.
- 2 You hear a positive indicator tone, indicating the radio is in Talkaround mode. The Talkaround icon is displayed.

OR

You hear a negative indicator tone, indicating the radio is in Repeater mode. The Talkaround icon is turned off.

The Talkaround setting is retained even after powering down.

■ Permanent Monitor

Use the Permanent Monitor feature to continuously monitor a selected channel for activity.

Procedure:

- 1 Press the preprogrammed **Permanent Monitor** button.
 - 2 Radio sounds alert tone, and the yellow LED lights up.
 - 3 Press the preprogrammed **Permanent Monitor** button to remove the radio from permanent monitor mode.
 - 4 Radio sounds an alert tone and the LED turns off.
-

Advanced Features

Use this navigation guide to learn more about advanced features available with your radio:

Scan Lists	page 14
Scan	page 14
Call Indicator Settings	page 16
Call Alert Operation	page 16
Emergency Operation	page 17
Text Messaging Features	page 20
Privacy	page 20
Utilities	page 21

■ Scan Lists

Scan lists are created and assigned to individual channels/groups. Your radio scans for voice activity by cycling through the channel/group sequence specified in the scan list for the current channel.

Your radio supports up to 32 scan lists, with a maximum of 16 members in a list. Each scan list shall support a mixture of both analog and digital entries.

■ Scan

When you start a scan, your radio cycles through the preprogrammed scan list for the current channel looking for voice activity.

The yellow LED blinks and you see the scan icon on the display.

During a dual mode scan, if you are on a digital channel, and your radio locks onto an analog channel, it automatically switches from digital mode to analog mode for the duration of the call. This is also true for the reverse.

There are two types of scans:

- **Main Channel Scan (Manual):** Your radio scans all the channels/groups in your scan list. On entering scan, your radio may – depending on the settings – automatically start on the last scanned “active” channel/group or on the channel where scan was initiated.
- **Auto Scan (Automatic):** Your radio automatically starts scanning when you select a channel/group that has Auto Scan enabled.

Starting and Stopping Scan

Procedure:

- 1 Press the preprogrammed **Scan** button.

OR

Use the Channel Rocker to select a channel with Auto Scan enabled.

- 2 When Scan is enabled, the yellow LED blinks and you hear a positive indicator tone. The scan icon is displayed.

OR

When Scan is disabled, the LED turns off and you hear a negative indicator tone. The scan icon turns off.

Responding to a Transmission During a Scan

During scanning, your radio stops on a channel/group where activity is detected. The radio stays on that channel for a preprogrammed time period known as “hang time”.

Procedure:

- 1 If the Channel Free Indication feature is enabled, you will hear a short alert tone the moment the transmitting radio releases the **PTT** button, indicating the channel is free for

you to respond. 

Press the **PTT** button during hang time. The green LED lights up.

- 2 Wait for the Talk Permit Tone to finish (if enabled) and speak clearly into the microphone.
-
- 3 Release the **PTT** button to listen.
-
- 4 If you do not respond within the hang time, the radio returns to scanning other channels/groups.
-

Deleting a Nuisance Channel

If a channel continually generates unwanted calls or noise (termed a “nuisance” channel), you can temporarily remove the unwanted channel from the scan list.

This capability does not apply to the channel designated as the Selected Channel.

Procedure:

- 1 When your radio “locks on to” an unwanted or nuisance channel, press the preprogrammed **Nuisance Channel Delete** button until you hear a tone.
-
- 2 Release the **Nuisance Channel Delete** button. The nuisance channel is deleted.
-

Restoring a Nuisance Channel

Procedure:

To restore the deleted nuisance channel, do **one** of the following:

- Power the radio off and powering it on again, **OR**
- Stop and restart a scan via the preprogrammed **Scan** button, **OR**
- Change the channel via the Channel Rocker.

■ Call Indicator Settings

You can turn on or off the ringing tones for a received Private Call (see *Turning Radio Tones/Alerts On or Off* on page 22).

Escalating Alarm Tone Volume

Your radio can be preprogrammed by your dealer to continually alert you when a radio call remains unanswered. This is done by automatically increasing the alarm tone volume over time.

This feature is known as Escalert.

■ Call Alert Operation

Call Alert paging enables you to alert a specific radio user to call you back when they are able to do so.

This feature is accessible via a preprogrammed **One Touch Call** button.

Receiving and Acknowledging a Call Alert

Procedure:

When you receive a Call Alert page:

- 1 You hear a repetitive tone. The yellow LED blinks.
- 2 Press and release the **PTT** button to acknowledge the alert.

Making a Call Alert with the One Touch Call Button

Procedure:

- 1 Press the preprogrammed **One Touch Call** button to make a Call Alert to the predefined ID.
- 2 The green LED lights up when your radio is sending the Call Alert.
- 3 If the Call Alert acknowledgement is received, two chirps sounds.
OR
If the Call Alert acknowledgement is not received, a low-pitch tone sounds.

■ Emergency Operation

An Emergency Alarm is used to indicate a critical situation. You are able to initiate an Emergency at any time, in any state, even when there is activity on the current channel.

Your radio supports 3 Emergency Alarms:

- Emergency Alarm
- Emergency Alarm with Call
- Emergency Alarm with Voice to Follow 

In addition, each alarm has the following types:

- Regular – Radio transmits an alarm signal and shows audio and/or visual indicators.
- Silent – Radio transmits an alarm signal without any audio or visual indicators. There will be no response (call) from the target radio until you press the **PTT** button to initiate the call.
- Silent with Voice – Radio transmits an alarm signal and is able to receive an incoming call, without any audio or visual indicators, until you press the **PTT** button to initiate, or respond to, the call.

Only **one** of the Emergency Alarms above can be assigned to the preprogrammed **Emergency** button or the **Emergency** footswitch.

Sending an Emergency Alarm

This feature allows you to send an Emergency Alarm, a non-voice signal, which triggers an alert indication on another radio.

Procedure:

- 1 Press the preprogrammed **Emergency** button or the **Emergency** footswitch.
- 2 The green LED lights up.
- 3 When an Emergency Alarm acknowledgment is received, the Emergency tone sounds. The green LED blinks.
OR
If your radio does not receive an Emergency Alarm acknowledgement, and after all retries have been exhausted, a low-pitch tone sounds.
- 4 Radio exits the Emergency Alarm mode.

If your radio is set to Silent, it will not display any audio or visual indicators during Emergency mode.

Sending an Emergency Alarm with Call

This feature allows you send an Emergency Alarm to another radio. Upon acknowledgement, both radios can communicate over a preprogrammed Emergency channel.

Procedure:

- 1 Press the preprogrammed **Emergency** button or press the **Emergency** footswitch.
- 2 The green LED lights up.
- 3 When an Emergency Alarm acknowledgment is received, the Emergency tone sounds. The green LED blinks.
- 4 Press the **PTT** button to make the call. The green LED lights up.
- 5 Wait for the Talk Permit Tone to finish (if enabled) and speak clearly into the microphone.
- 6 Release the **PTT** button to listen.
- 7 If the Channel Free Indication feature is enabled, you will hear a short alert tone the moment the target radio releases the **PTT** button, indicating the channel is free for you to

respond. 

OR

Long press the preprogrammed **Emergency** button to exit the Emergency mode.

*If your radio is set to Silent, it will not display any audio or visual indicators during Emergency mode, or receive any response (call) from the target radio, until you press the **PTT** button to initiate the call.*

*If your radio is set to Silent with Voice, it will not display any audio or visual indicators during Emergency mode, or when you are receiving a call from the target radio. The indicators will only appear once you press the **PTT** button to initiate, or respond to, the call.*

Sending an Emergency Alarm with Voice to Follow

This feature allows you to send an Emergency Alarm to another radio. Upon acknowledgement, your radio's microphone is automatically activated, allowing you to communicate with the other radio without pressing the **PTT**.

This activated microphone state is also known as "hot mic".

If you press the **PTT** button during the preprogrammed hot mic transmission period, the radio ignores the **PTT** press and remains in Emergency mode.

NOTE: If you press the **PTT** button during hot mic, and continue to press it after the hot mic duration expires, the radio continues to transmit until you release the **PTT** button.

Procedure:

- 1 Press the preprogrammed **Emergency** button or the **Emergency** footswitch.
- 2 The green LED lights up.
- 3 Once a tone sounds, speak clearly into the microphone. When hot mic has been enabled, the radio automatically transmits without a **PTT** press until the hot mic duration expires.
- 4 While transmitting, the green LED lights up.
- 5 Once the hot mic duration expires, the radio automatically stops transmitting. To transmit again, press the **PTT** button.

*If your radio is set to Silent, it will not display any audio or visual indicators during Emergency mode, or receive any response from the target radio, until the programmed hot mic transmission period is over, and you press the **PTT** button.*

*If your radio is set to Silent with Voice, it will not display any audio or visual indicators during Emergency mode when you are making the call with hot mic, or when the target radio responds after the programmed hot mic transmission period is over. The indicators will only appear when you press the **PTT** button.*

 **Reinitiating an Emergency Mode**

There are two instances where this can happen:

- You change the channel while the radio is in Emergency mode. This exits the Emergency mode. If Emergency Alarm is enabled on this new channel, the radio reinitiates Emergency.
- You press the preprogrammed **Emergency** button during an Emergency initiation/transmission state. This causes the radio to exit this state, and to reinitiate Emergency.

 **Exiting an Emergency Mode**

Your radio exits Emergency mode when **one** of the following occurs:

- Emergency Alarm acknowledgement is received (for **Emergency Alarm** only), **OR**
- All retries to send the alarm have been exhausted, **OR**
- The preprogrammed **Emergency** button is long pressed.

NOTE: If your radio is powered off, it exits the Emergency mode. The radio will not reinitiate the Emergency mode automatically when it is turned on again.

■ Text Messaging Features

Sending a Quick Text Message

You can send Quick Text messages, preprogrammed by your dealer, via the programmable button.

Procedure:

- 1 Press the preprogrammed **One Touch Call** button to send a predefined Quick Text message to a predefined ID.
 - 2 The green LED lights up.
 - 3 Two chirps indicate that the message is sent successfully.
OR
A low-pitch tone indicates that the message cannot be sent.
-

■ Privacy

If enabled, this feature helps to prevent eavesdropping by unauthorized users on a channel by the use of a software-based scrambling solution. The signaling and user identification portions of a transmission are not scrambled.

Your radio must have privacy enabled on the channel to send a privacy-enabled transmission, although this is not a necessary requirement for receiving a transmission. While on a privacy-enabled channel, the radio is still able to receive clear (unscrambled) transmissions.

To unscramble a privacy-enabled call or data transmission, your radio must have the same Privacy Key (programmed by your dealer) as the transmitting radio. If your radio receives a scrambled call that is of a different Privacy Key, you will hear a garbled transmission.

The green LED lights up while the radio is transmitting and blinks rapidly when the radio is receiving an ongoing privacy-enabled transmission.

NOTE: Some radio models may not offer this Privacy feature. Check with your dealer or system administrator for more information.

Procedure:

Press the programmed **Privacy** button to toggle privacy on or off.

■ Utilities

Setting the Squelch Level

You can adjust your radio's squelch level to filter out unwanted calls with low signal strength or channels that have a higher than normal background noise.

Settings: **Normal** is the default. **Tight** filters out (unwanted) calls and/or background noise. However, calls from remote locations may also be filtered out.

Procedure:

- 1 Press the preprogrammed **Squelch** button.
 - 2 You hear a positive indicator tone, indicating the radio is operating in tight squelch.
OR
You hear a negative indicator tone, indicating the radio is operating in normal squelch.
-

Setting the Power Level

You can customize your radio's power setting to high or low for each channel.

Settings: **High** enables communication with radios located at a considerable distance from you. **Low** enables communication with radios in closer proximity.

Procedure:

- 1 Press the preprogrammed **Power Level** button.
 - 2 You hear a positive indicator tone, indicating the radio is transmitting at low power.
OR
You hear a negative indicator tone, indicating the radio is transmitting at high power.
-

Turning the Option Board Feature(s) On or Off

A channel can support up to 6 option board features. Refer to your dealer or system administrator for more information.

Procedure:

Press the programmed **Option Board Feature** button to toggle the feature on or off.

Turning the Public Address System On or Off

You can enable and disable the radio's internal public address (PA) system.

Procedure:

Press the programmed **PA On/Off** button to toggle the feature on or off.

Turning the External Public Address System On or Off

You can enable or disable the audio routing between the connected public address (PA) loudspeaker amplifier and the radio's internal public address (PA) system.

Procedure:

Press the programmed **Ext PA On/Off** button to toggle the feature on or off.

Turning Horns/Lights On or Off

Your radio is able to notify you of an incoming call via the horns and lights feature. When activated, an incoming call sounds your vehicle's horn and turns on its lights.

This feature needs to be installed through your radio's rear accessory connector by your dealer.

Procedure:

- 1 Press the preprogrammed **Horns/Lights** button.
- 2 You hear a positive indicator tone, indicating the horns and lights feature is on.
OR
You hear a negative indicator tone, indicating the horns and lights feature is off.

Turning Radio Tones/Alerts On or Off

You can enable and disable all radio tones and alerts (except for the incoming Emergency alert tone) if needed.

Procedure:

- 1 Press the preprogrammed **All Tones/Alerts** button.
- 2 You hear a positive indicator tone, indicating all tones and alerts are on.
OR
You hear a negative indicator tone, indicating all tones and alerts are off.

Accessories

Your radio is compatible with the accessories listed in this chapter. Contact your dealer for details.

Antennas	page 23
Audio	page 24
Cables	page 24
Desktop Accessories	page 25
Mounting Kits	page 25
Speakers	page 25
Miscellaneous Accessories	page 25

■ Antennas

- VHF, 136 – 144 MHz, 1/4 Wave, Through-Hole Mount, Mini-U (HAD4006_)
- VHF, 146 – 150.8 MHz, 1/4 Wave, Through-Hole Mount, Mini-U (HAD4007_)
- VHF, 150.8 – 162 MHz, 1/4 Wave, Through-Hole Mount, Mini-U (HAD4008_)
- VHF, 162 – 174 MHz, 1/4 Wave, Through-Hole Mount, Mini-U (HAD4009_)
- VHF, 146 – 172 MHz, 3.0 dB Gain, Through-Hole Mount, Mini-U (HAD4014_)

- UHF, 403 – 430 MHz, 1/4 Wave, Through-Hole Mount, Mini-U (HAE4002_)
- UHF, 450 – 470 MHz, 1/4 Wave, Through-Hole Mount, Mini-U (HAE4003_)
- UHF, 470 – 527 MHz, 1/4 Wave, Through-Hole Mount, Mini-U (HAE4004_)
- UHF, 406 – 420 MHz, 3.5 dB Gain, Through-Hole Mount, Mini-U (HAE4010_)
- UHF, 450 – 470 MHz, 3.5 dB Gain, Through-Hole Mount, Mini-U (HAE4011_)
- UHF, 470 – 494 MHz, 3.5 dB Gain, Through-Hole Mount, Mini-U (HAE4012_)
- UHF, 494 – 512 MHz, 3.5 dB Gain, Through-Hole Mount, Mini-U (HAE4013_)
- UHF, 403 – 527 MHz, 2.0 dB Gain, Through-Hole Mount, Mini-U (HAE6022_)
- UHF, 450 – 470 MHz, 5.0 dB Gain, Through-Hole Mount, Mini-U (RAE4004_)

For XPR 4350 GPS Models Only

- Combination GPS/VHF, 136 – 144 MHz, 1/4 Wave, Through-Hole Mount, Mini-U (RAD4214_)
- Combination GPS/VHF, 146 – 150.8 MHz, 1/4 Wave, Through-Hole Mount, Mini-U (RAD4215_)

- Combination GPS/VHF, 150.8 – 162 MHz, 1/4 Wave, Through-Hole Mount, Mini-U (RAD4216_)
- Combination GPS/VHF, 162 – 174 MHz, 1/4 Wave, Through-Hole Mount, Mini-U (RAD4217_)
- Combination GPS/VHF, 146 – 172 MHz, 3.0 dB Gain, Through-Hole Mount, Mini-U (RAD4218_)
- Combination GPS/UHF, 403 – 527 MHz, 2.0 dB Gain, Through-Hole Mount, Mini-U (HAE6019_)
- Combination GPS/UHF, 470 – 527 MHz, 1/4 Wave, Through-Hole Mount, Mini-U (HAE6020_)
- Combination GPS/UHF, 470 – 494 MHz, 3.0 dB Gain, Through-Hole Mount, Mini-U (HAE6024_)
- Combination GPS/UHF, 494 – 512 MHz, 3.0 dB Gain, Through-Hole Mount, Mini-U (HAE6026_)
- Combination GPS/UHF, 403 – 430 MHz, 1/4 Wave, Through-Hole Mount, Mini-U (PMAE4030_)
- Combination GPS/UHF, 450 – 470 MHz, 1/4 Wave, Through-Hole Mount, Mini-U (PMAE4031_)
- Combination GPS/UHF, 406 – 420 MHz, 3.5 dB Gain, Through-Hole Mount, Mini-U (PMAE4032_)
- Combination GPS/UHF, 450 – 470 MHz, 3.5 dB Gain, Through-Hole Mount, Mini-U (PMAE4033_)
- Combination GPS/UHF, 450 – 470 MHz, 5.0 dB Gain, Through-Hole Mount, Mini-U (PMAE4034_)

- Fixed Mount GPS Active Antenna (PMAN4000_)
- Window Mount GPS Active Antenna (PMAN4001_)
- Magnetic Mount GPS Active Antenna (PMAN4002_)

■ Audio

- Telephone Style Handset (HMN4098_)
- Desktop Microphone (RMN5050_)
- Compact Microphone (RMN5052_)
- Heavy Duty Microphone with Enhanced Audio (RMN5053_)
- Visor Microphone with Enhanced Audio (RMN5054_)

■ Cables

- Power Cable to Battery, 10-foot (3-metre) Cable, 15 amp (1 – 25 Watt) (HKN4137_)
- Power Cable to Battery, 10-foot (3-metre) Cable, 20 amp (1 – 45 Watt) (HKN4191_)
- Power Cable to Battery, 20-foot (6-metre) Cable, 20 amp (1 – 45 Watt) (HKN4192_)
- Mobile and Repeater Rear Accessory Connector Universal Cable (PMKN4018_)
- Ignition Sense Cable (RKN4136_)

■ Desktop Accessories

- Radio Power Cable for GPN6145 (GKN6266_)
- Desktop Tray without Speaker (GLN7318_)
- Desktop Tray with Speaker (RSN4005_)
- Switchmode Power Supply (1 – 25 Watt Models) (CE marked) (GPN6145_)
- Mobile Mini-U Antenna Adapter, 8-foot (2.4-metre) Cable (HKN9088_)
- Power Supply and Cable (25 – 60 Watt Models) (HPN4007_)
- Power Supply and Cable (1 – 25 Watt Models) (HPN4008_)
- Hardware Kit for Rear Accessory Connector (PMLN5072_)

■ Mounting Kits

- In Dash (DIN) Mounting Kit (RLN5933_)
- Low Profile Trunnion Kit (RLN6077_)
- High Profile Trunnion Kit (RLN6078_)
- Key Lock Trunnion Kit (RLN6079_)

■ Speakers

- 13-Watt External Speaker (RSN4002_)
- 7.5-Watt External Speaker (RSN4003_)
- 5-Watt External Speaker (RSN4004_)

■ Miscellaneous Accessories

- Mobile Button Kit (Includes Buttons for Remote Monitor, Radio Check, Radio Disable, and VOX) (HKLN4292_)
- Numeric Display Mobile Button Kit (Includes Buttons for Monitor and Scan) (HKLN4293_)
- PL259/Mini-U Antenna Adapter, 8-foot (2.4-metre) Cable (HKN9557_)
- Microphone Hang Up Clip (All Microphones) (HLN9073_)
- Universal Microphone Hang Up Clip (All Microphones) (HLN9414_)
- Push Button PTT (RLN5926_)
- Emergency Footswitch (RLN5929_)

Limited Warranty

MOTOROLA COMMUNICATION PRODUCTS

I. WHAT THIS WARRANTY COVERS AND FOR HOW LONG:

MOTOROLA INC. ("MOTOROLA") warrants the MOTOROLA manufactured Communication Products listed below ("Product") against defects in material and workmanship under normal use and service for a period of time from the date of purchase as scheduled below:

XPR Series Digital Mobile Radios	Two (2) Years
Product Accessories	One (1) Year

MOTOROLA, at its option, will at no charge either repair the Product (with new or reconditioned parts), replace it (with a new or reconditioned Product), or refund the purchase price of the Product during the warranty period provided it is returned in accordance with the terms of this warranty. Replaced parts or boards are warranted for the balance of the original applicable warranty period. All replaced parts of Product shall become the property of MOTOROLA.

This express limited warranty is extended by MOTOROLA to the original end user purchaser only and is not assignable or transferable to any other party. This is the complete warranty for the Product manufactured by MOTOROLA. MOTOROLA assumes no

obligations or liability for additions or modifications to this warranty unless made in writing and signed by an officer of MOTOROLA.

Unless made in a separate agreement between MOTOROLA and the original end user purchaser, MOTOROLA does not warrant the installation, maintenance or service of the Product.

MOTOROLA cannot be responsible in any way for any ancillary equipment not furnished by MOTOROLA which is attached to or used in connection with the Product, or for operation of the Product with any ancillary equipment, and all such equipment is expressly excluded from this warranty. Because each system which may use the Product is unique, MOTOROLA disclaims liability for range, coverage, or operation of the system as a whole under this warranty.

II. GENERAL PROVISIONS:

This warranty sets forth the full extent of MOTOROLA'S responsibilities regarding the Product. Repair, replacement or refund of the purchase price, at MOTOROLA'S option, is the exclusive remedy. THIS WARRANTY IS GIVEN IN LIEU OF ALL OTHER EXPRESS WARRANTIES. IMPLIED WARRANTIES, INCLUDING WITHOUT LIMITATION, IMPLIED WARRANTIES OF MERCHANTABILITY AND FITNESS FOR A PARTICULAR PURPOSE, ARE LIMITED TO THE DURATION OF THIS LIMITED WARRANTY. IN NO EVENT SHALL MOTOROLA BE LIABLE FOR DAMAGES IN EXCESS OF THE PURCHASE PRICE OF THE PRODUCT, FOR ANY LOSS OF USE, LOSS OF TIME, INCONVENIENCE, COMMERCIAL LOSS, LOST PROFITS OR SAVINGS OR OTHER INCIDENTAL, SPECIAL OR CONSEQUENTIAL DAMAGES ARISING OUT OF THE USE OR

INABILITY TO USE SUCH PRODUCT, TO THE FULL EXTENT SUCH MAY BE DISCLAIMED BY LAW.

III. STATE LAW RIGHTS:

SOME STATES DO NOT ALLOW THE EXCLUSION OR LIMITATION OF INCIDENTAL OR CONSEQUENTIAL DAMAGES OR LIMITATION ON HOW LONG AN IMPLIED WARRANTY LASTS, SO THE ABOVE LIMITATION OR EXCLUSIONS MAY NOT APPLY.

This warranty gives specific legal rights, and there may be other rights which may vary from state to state.

IV. HOW TO GET WARRANTY SERVICE:

You must provide proof of purchase (bearing the date of purchase and Product item serial number) in order to receive warranty service and, also, deliver or send the Product item, transportation and insurance prepaid, to an authorized warranty service location. Warranty service will be provided by MOTOROLA through one of its authorized warranty service locations. If you first contact the company which sold you the Product (e.g., dealer or communication service provider), it can facilitate your obtaining warranty service. You can also call MOTOROLA at 1-800-927-2744 US/Canada.

V. WHAT THIS WARRANTY DOES NOT COVER:

- A) Defects or damage resulting from use of the Product in other than its normal and customary manner.
- B) Defects or damage from misuse, accident, water, or neglect.

- C) Defects or damage from improper testing, operation, maintenance, installation, alteration, modification, or adjustment.
- D) Breakage or damage to antennas unless caused directly by defects in material workmanship.
- E) A Product subjected to unauthorized Product modifications, disassembles or repairs (including, without limitation, the addition to the Product of non-MOTOROLA supplied equipment) which adversely affect performance of the Product or interfere with MOTOROLA's normal warranty inspection and testing of the Product to verify any warranty claim.
- F) Product which has had the serial number removed or made illegible.
- G) Rechargeable batteries if:
 - (1) any of the seals on the battery enclosure of cells are broken or show evidence of tampering.
 - (2) the damage or defect is caused by charging or using the battery in equipment or service other than the Product for which it is specified.
- H) Freight costs to the repair depot.
- I) A Product which, due to illegal or unauthorized alteration of the software/firmware in the Product, does not function in accordance with MOTOROLA's published specifications or the FCC type acceptance labeling in effect for the Product at the time the Product was initially distributed from MOTOROLA.
- J) Scratches or other cosmetic damage to Product surfaces that does not affect the operation of the Product.
- K) Normal and customary wear and tear.

VI. PATENT AND SOFTWARE PROVISIONS:

MOTOROLA will defend, at its own expense, any suit brought against the end user purchaser to the extent that it is based on a claim that the Product or parts infringe a United States patent, and MOTOROLA will pay those costs and damages finally awarded against the end user purchaser in any such suit which are attributable to any such claim, but such defense and payments are conditioned on the following:

- A) that MOTOROLA will be notified promptly in writing by such purchaser of any notice of such claim;
- B) that MOTOROLA will have sole control of the defense of such suit and all negotiations for its settlement or compromise; and
- C) should the Product or parts become, or in MOTOROLA's opinion be likely to become, the subject of a claim of infringement of a United States patent, that such purchaser will permit MOTOROLA, at its option and expense, either to procure for such purchaser the right to continue using the Product or parts or to replace or modify the same so that it becomes non-infringing or to grant such purchaser a credit for the Product or parts as depreciated and accept its return. The depreciation will be an equal amount per year over the lifetime of the Product or parts as established by MOTOROLA.

MOTOROLA will have no liability with respect to any claim of patent infringement which is based upon the combination of the Product or parts furnished hereunder with software, apparatus or devices not furnished by MOTOROLA, nor will MOTOROLA have any liability for the use of ancillary equipment or software not furnished by MOTOROLA which is attached to or used in connection with the Product. The foregoing states the entire liability of MOTOROLA with respect to infringement of patents by the Product or any parts thereof.

Laws in the United States and other countries preserve for MOTOROLA certain exclusive rights for copyrighted MOTOROLA software such as the exclusive rights to reproduce in copies and distribute copies of such MOTOROLA software. MOTOROLA software may be used in only the Product in which the software was originally embodied and such software in such Product may not be replaced, copied, distributed, modified in any way, or used to produce any derivative thereof. No other use including, without limitation, alteration, modification, reproduction, distribution, or reverse engineering of such MOTOROLA software or exercise of rights in such MOTOROLA software is permitted. No license is granted by implication, estoppel or otherwise under MOTOROLA patent rights or copyrights.

VII. GOVERNING LAW:

This Warranty is governed by the laws of the State of Illinois, U.S.A.



XPR Series Digital Mobile Radios

Quick Reference Card

Radio Controls

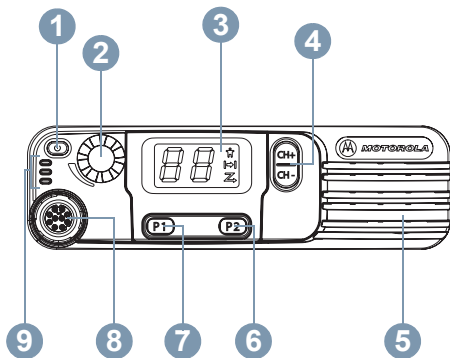

Record your radio's programmable button functions in the blanks provided. **SP** represents Short Press, **LP** represents Long Press.

- 1 On/Off Button
- 2 Volume Knob

- 3 Display
- 4 Channel Rocker
- 5 Speaker
- 6 Front Button P2 (Programmable)
SP: _____ LP: _____
- 7 Front Button P1 (Programmable)
SP: _____ LP: _____
- 8 Accessory Connector
- 9 LED Indicators

Display Icons

The following are the icons that appear on the radio's display.

 Indicates a Private Call in progress.

 In the absence of a repeater, radio is currently configured for direct radio to radio communication.

 Scan feature is activated.

Powering Up and Turning Off the Radio

Press the On/Off Button briefly to turn on the radio, and press and hold the On/Off Button to turn it off.

Adjusting the Volume

Turn the Volume Knob clockwise to increase volume or counterclockwise to decrease volume.

LED Indicators

Blinking red – Radio is receiving an Emergency transmission or has failed the self-test upon powering up.

Solid yellow – Radio is receiving a request for a Private Call, or monitoring a channel.

Blinking yellow – Radio is scanning for activity or receiving a Call Alert.

Solid green – Radio is transmitting.

Blinking green – Radio is powering up, receiving a non-privacy-enabled call or data, or detecting activity over the air.

Rapidly blinking green – Radio is receiving a privacy-enabled call or data. 



■ Audio Indicators for Programmable Buttons

Some programmable buttons use audio indicators to indicate the change as they alternate between two different choices.

Programmable Button	Positive Indicator Tone	Negative Indicator Tones
Zone	In Zone 2	In Zone 1
Repeater/Talkaround	In Talkaround mode	In Repeater mode
Scan	Start Scan operation	Stop Scan operation
Squelch 	Operating in tight squelch	Operating in normal squelch
Power Level	Transmitting at low power	Transmitting at high power
Horns and Lights	The horns and lights feature is on	The horns and lights feature is off
Tones and Alerts	All tones and alerts are on	All tones and alerts are off

■ Selecting a Radio Channel, Subscriber ID, or Group ID



- 1 Select the zone by pressing the preprogrammed **Zone** button to switch between zones.
- 2 Press the Channel Rocker to select the required channel, subscriber ID, or group ID.

■ Making a Group or Private Call

Press the preprogrammed **One Touch Call** button and proceed to step 2.

OR

Follow the procedure below.

- 1 Press the Channel Rocker to select the channel with the active group ID.
OR
Press the Channel Rocker to select the channel with the active subscriber ID. 
- 2 Press the **PTT** button to make the call. The green LED lights up.
- 3 Wait for the Talk Permit Tone to finish (if enabled). Speak clearly into the microphone.
- 4 Release the **PTT** button to listen.
- 5 If the Channel Free Indication feature is enabled, you will hear a short alert tone the moment the target radio releases the **PTT** button, indicating the channel is free for you to respond. Press the **PTT** button to respond. 
OR
If there is no voice activity for a predetermined period of time, the call ends.

 *For a Private Call, you hear a short tone when the call ends.*

 *Your radio must have the Privacy feature enabled on the channel to send a privacy-enabled transmission. Only target radios with the same Privacy Key as your radio will be able to unscramble the transmission.*

■ Making an All Call

Your radio must be programmed to allow you to use this feature. Users on the channel cannot respond to an All Call.

- 1 Press the Channel Rocker to select the channel with the active All Call group ID.
- 2 Press the **PTT** button to make the call. The green LED lights up.
- 3 Wait for the Talk Permit Tone to finish (if enabled). Speak clearly into the microphone.
- 4 If there is no voice activity for a preprogrammed period of time, the call ends.

*When you **receive** an All Call, you cannot use any preprogrammed button functions until the call ends.*

■ Making a Call Alert

- 1 Press the preprogrammed **One Touch Call** button to send the Call Alert to a predefined ID.

- 2 The green LED lights up.

- 3 Two chirps indicate that the Call Alert acknowledge is successfully received.

■ Sending a Quick Text Message

- 1 Press the preprogrammed **One Touch Call** button send a predefined Quick Text Message to a predefined ID.

- 2 The green LED lights up.

- 3 Two chirps indicate that the message is sent successfully.
OR
A low-pitch tone indicates that the message cannot be sent.

■ Sending an Emergency Alarm

- 1 Press the preprogrammed **Emergency** button.

- 2 The green LED lights up.

- 3 When an Emergency Alarm acknowledgment is received, the Emergency tone sounds. The green LED blinks.
OR
If your radio does not receive an Emergency Alarm acknowledgement, and after all retries have been exhausted, a low-pitch tone sounds.

- 4 Radio exits the Emergency Alarm mode.

If your radio is set to Silent, it will not display any audio or visual indicators during Emergency mode.

■ Privacy

Press the programmed **Privacy** button to toggle privacy on or off.



MOTOROLA

Motorola, Inc.
1301 E. Algonquin Rd.
Schaumburg, IL 60196-1078, U.S.A.

MOTOROLA and the Stylized M Logo are
registered in the U.S. Patent and Trademark Office.
All other product or service names are the property
of their respective owners.

© 2006 – 2008 by Motorola, Inc.
All rights reserved. Printed in the U.S.A.
April 2008

www.motorola.com/mototrbo



6880309T18-D