

Moxa AirWorks AWK-5222

User's Manual

First Edition, June 2009

www.moxa.com/product

MOXA®

© 2009 Moxa Inc. All rights reserved.
Reproduction without permission is prohibited.

Moxa AirWorks AWK-5222 User's Manual

The Moxa software described in this manual is furnished under a license agreement and may be used only in accordance with the terms of that agreement.

Copyright Notice

Copyright © 2009 Moxa Inc.
All rights reserved.
Reproduction without permission is prohibited.

Trademarks

MOXA is a registered trademark of Moxa Inc.
All other trademarks or registered marks in this manual belong to their respective manufacturers.

Disclaimer

Information in this document is subject to change without notice and does not represent a commitment on the part of Moxa.

Moxa provides this document “as is,” without warranty of any kind, either expressed or implied, including, but not limited to, its particular purpose. Moxa reserves the right to make improvements and/or changes to this manual, or to the products and/or the programs described in this manual, at any time.

Information provided in this manual is intended to be accurate and reliable. However, Moxa assumes no responsibility for its use, or for any infringements on the rights of third parties that may result from its use. This product might include unintentional technical or typographical errors. Changes are periodically made to the information herein to correct such errors, and these changes are incorporated into new editions of the publication.

Technical Support Contact Information www.moxa.com/support

Moxa Americas:

Toll-free: 1-888-669-2872
Tel: +1-714-528-6777
Fax: +1-714-528-6778

Moxa China (Shanghai office):

Toll-free: 800-820-5036
Tel: +86-21-5258-9955
Fax: +86-10-6872-3958

Moxa Europe:

Tel: +49-89-3 70 03 99-0
Fax: +49-89-3 70 03 99-99

Moxa Asia-Pacific:

Tel: +886-2-8919-1230
Fax: +886-2-8919-1231

Table of Contents

Chapter 1	Introduction	1-1
	Overview.....	1-2
	Package Checklist	1-2
	Product Features	1-2
	Product Specifications	1-3
	Functional Design	1-5
	LED Indicators	1-5
	Beeper.....	1-6
	Reset Button	1-6
	Relay (Digital Output).....	1-7
	Antenna.....	1-8
Chapter 2	Getting Started	2-1
	First-time Installation and Configuration.....	2-2
	Communication Testing	2-3
	Function Guiding Map.....	2-4
Chapter 3	Web Console Configuration	3-1
	Configuration by Web Browser	3-2
	Overview.....	3-4
	Basic Settings.....	3-4
	System Info Settings	3-4
	Network Settings	3-5
	Time Settings.....	3-6
	Wireless Settings.....	3-8
	Operation Mode.....	3-8
	WLAN1/WLAN2	3-10
	WLAN Security Settings	3-12
	Advanced Wireless Settings	3-22
	WLAN Certification Settings (for EAP-TLS in Redundant Client, Client or Slave mode only)	3-25
	Advanced Settings	3-26
	DHCP Server (for AP mode only)	3-26
	Packet Filters	3-28
	RSTP Settings (for Redundant AP or AP mode only)	3-31
	SNMP Agent	3-33
	Storm Protection	3-35
	Auto Warning Settings	3-36
	System Log	3-36
	Syslog	3-38
	E-mail	3-39
	Relay.....	3-41
	Trap	3-42
	Status.....	3-44
	Wireless Status	3-44
	Associated Client List (for Redundant AP, AP, or Master mode only)	3-45
	DHCP Client List (for AP mode only)	3-45
	System Log	3-46
	Relay Status	3-46

	DI and Power Status	3-47
	Maintenance.....	3-47
	Console Settings	3-47
	Ping.....	3-47
	Firmware Upgrade.....	3-48
	Config Import Export	3-49
	Load Factory Default.....	3-49
	Password.....	3-49
	Misc. Settings	3-50
	Save Configuration	3-50
	Restart	3-51
	Logout.....	3-51
Chapter 4	Other Console Configurations.....	4-1
	RS-232 Console Configuration (115200, None, 8, 1, VT100).....	4-2
	Configuration by Telnet and SSH Consoles.....	4-4
	Configuration by Web Browser with HTTPS/SSL	4-5
	Disabling Telnet and Browser Access.....	4-6
Chapter 5	References.....	5-1
	Beacon	5-2
	DTIM	5-2
	Fragment	5-2
	RTS Threshold	5-2
	STP and RSTP	5-2
	The STP/RSTP Concept	5-2
	Differences between RSTP and STP	5-3
Chapter 6	Supporting Information	6-1
	About This User's Manual	6-2
	DoC (Declaration of Conformity).....	6-3
	Federal Communication Commission Interference Statement	6-3
	R&TTE Compliance Statement	6-4
	Firmware Recovery.....	6-4
	Technical Support Contact Information	6-6

Moxa AirWorks AWK-5222 with dual-RF wireless capability allows wireless users to access network resources more reliably. The AWK-5222 is rated to operate at temperatures ranging from 0 to 60°C for standard models and -40 to 75°C for extended temperature models, and is rugged enough for any harsh industrial environment.

In this chapter, we cover the following topics:

- ❑ **Overview**
- ❑ **Package Checklist**
- ❑ **Product Features**
- ❑ **Product Specifications**
- ❑ **Functional**
 - LED Indicators
 - Beeper
 - Reset Button
 - Relay (Digital Output)
 - Antenna

Overview

The AWK-5222 Access Point/Bridge and AP Client is ideal for applications that need a more reliable solution, and are hard to wire, too expensive to wire, or use mobile equipment that connects to a TCP/IP network. The AWK-5222 can operate at temperatures ranging from 0 to 60°C for standard models and -40 to 75°C for extended temperature models, and is rugged enough for any harsh industrial environment. Installation is easy, with either DIN-Rail mounting or wall mounting in distribution boxes. The DIN-rail/wall mounting ability, wide operating temperature range, and IP30 housing with LED indicators make the AWK-5222 a convenient yet reliable solution for any industrial wireless application.

Package Checklist

Moxa's AWK-5222 is shipped with the following items. If any of these items is missing or damaged, please contact your customer service representative for assistance.

- 1 AWK-5222
- 2 Swivel-type Antennas (2dBi, RP-SMA, 2.4&5GHz)
- 1 Quick Installation Guide
- 1 Software CD
- 1 Moxa Product Warranty Booklet
- 1 Cable Holder with a Screw
- 2 Protective Caps



NOTE

The above items come with the AWK-5222 standard version. The package contents may vary in different a customized version.

Product Features

- IEEE802.11a/b/g Compliant
- Three-in-one design (AP/Bridge/Client)
- Dual-RF design for redundant wireless communication
- Advanced Wireless Security:
 - 64-bit and 128-bit WEP/WPA/WPA2
 - SSID Hiding/IEEE 802.1X/RADIUS
 - Packet access control & filtering
- STP/RSTP support for redundancy of system networking
- Long-distance transmission support
- Turbo Roaming™ enables rapid handover (Client mode)
- Dedicated antenna selection
- Free firmware update for more advanced functions
- RS-232 console management
- 2DI+1DO for on-site monitoring and warning

- Operating temperature ranges from -40 to 75°C (-T model)
- Power input by redundant 24 VDC power inputs or IEEE802.3af Power over Ethernet
- DIN-Rail or wall mounting ability
- IP30 protected high-strength metal housing

Product Specifications

WLAN

Standards	IEEE 802.11a/g/b for Wireless LAN IEEE 802.11i for Wireless Security IEEE 802.3u for 10/100BaseT(X) IEEE 802.3af for Power-over-Ethernet IEEE 802.1D for Spanning Tree Protocol IEEE 802.1w for Rapid STP
Spread Spectrum and Modulation	DSSS with DBPSK, DQPSK, CCK OFDM with BPSK, QPSK, 16QAM, 64QAM
Operating Channels (Central Frequency)	US: 2.412 to 2.462 GHz (11 channels) 5.18 to 5.24 GHz (4 channels) EU: 2.412 to 2.472 GHz (13 channels) 5.18 to 5.24 GHz (4 channels) JP: 2.412 to 2.472 GHz (13 channels, OFDM) 2.412 to 2.484 GHz (14 channels, DSSS) 5.18 to 5.24 GHz (4 channels for W52)
Security	64-bit and 128-bit WEP encryption, WPA /WPA2 Personal or Enterprise (IEEE 802.1X/ RADIUS, TKIP and AES)

Protocol

General Protocols:	Proxy ARP, DNS, HTTP, HTTPS, IP, ICMP, SNMP, TCP, UDP, RADIUS, SNMP, RTP ,PPPoE, DHCP
AP-only Protocols:	ARP, BOOTP, DHCP, dynamic VLAN-Tags for 802.1X-Clients, STP/RSTP (IEEE 802.1D/w)
Data Rates	802.11b: 1, 2, 5.5, 11 Mbps 802.11a/g: 6, 9, 12, 18, 24, 36, 48, 54 Mbps
Transmit Power	802.11b: 1 to 11 Mbps: Typ. 18±1.5 dBm 802.11g: 6 to 24 Mbps: Typ. 18±1.5 dBm 36 to 48 Mbps: Typ. 16±1.5 dBm 54 Mbps: Typ. 15±1.5 dBm 802.11a: 6 to 24 Mbps: Typ. 16±1.5 dBm 36 to 48 Mbps: Typ. 14±1.5 dBm 54 Mbps: Typ. 13±1.5 dBm
Receiver Sensitivity	802.11b: -92 dBm @ 1 Mbps, -90 dBm @ 2 Mbps, -88 dBm @ 5.5 Mbps, -84dBm @ 11 Mbps 802.11g: -87 dBm @ 6 Mbps, -86 dBm @ 9 Mbps, -85 dBm @ 12 Mbps, -82dBm @ 18 Mbps, -80 dBm @ 24 Mbps, -76 dBm @ 36 Mbps, -72dBm @ 48 Mbps, -70 dBm @ 54 Mbps 802.11a: -87 dBm @ 6 Mbps, -86 dBm @ 9 Mbps, -85 dBm @ 12 Mbps, -82dBm @ 18 Mbps, -80 dBm @ 24 Mbps, -76 dBm @ 36 Mbps, -72dBm @ 48 Mbps, -70 dBm @ 54 Mbps

Interface

Default Antenna	2dBi dual-band, Omni-directional antenna
Antenna Connector	RP-SMA (male)
Connection	10-pin Removable Terminal Block
Alarm Contact	1 relay output (capacity: 1A @24VDC)
Digital Input	2 electrically-isolated inputs <ul style="list-style-type: none"> • +3 to -30V for state "0" (OFF) • 13 to 30V for state "1" (ON) • Max. input current: 8 mA
Console	RS-232 (RJ45 type)
LAN Port	10/100BaseT(X) auto negotiation speed
LED Indicators	PWR1, PWR2, PoE, FAULT, STATE, Signal Strength, CLIENT MODE, BRIDGE MODE, WLAN, 10M, 100M

Power

Input Voltage	12 to 48 VDC, redundant dual DC power inputs or 48 VDC Power-over-Ethernet (IEEE 802.3af)
Input Current	800mA (@ 12 to 48 VDC)
Input Current (@ 24VDC)	0.3 A
Overload Current Protection	1.6 A
Reverse Polarity Protection	Present

Mechanical

Dimensions	62.05 x 135 x 105 mm (2.44 x 5.31 x 4.13 in)
Weight	880 g
Installation	DIN-rail, or Wall Mounting (with optional wall mounting kit)
Casing	IP30 protection, aluminum case

Environment

Operating Temperature:	Standard models: 0 to 60°C (32 to 140°F) Wide Temp Models: -40 to 75°C (-40 to 167°F)
Storage Temperature:	-40 to 85°C (-40 to 185°F)
Ambient Relative Humidity	5 to 95% (non-condensing)

Regulatory Approvals*

Safety:	EN60950-1, UL60950-1
EMC:	EN301 489-1/-17, FCC Part 15, EN55022/55024, IEC61000-6-2/-4
Environmental/EMC compliancy	EN50155, EN50121-1/-4

**Please check Moxa's website for the most up-to-date certification status.*

Warranty

5 years

Details: See <http://www.moxa.com/warranty>

**ATTENTION**

The AWK-5222 is NOT a portable mobile device and should be located at least 20cm away from the human body. The AWK-5222 is NOT designed for the general public. To deploy AWK-5222s and establish a wireless network safely, a well-trained technician is required for installation.

Functional Design

LED Indicators

The LEDs on the front panel of AWK-5222 allow you to identify the status and wireless settings quickly.

LED	Color	State	Description
Front Panel LED Indicators (System)			
PWR1	Green	On	Power is being supplied from power input 1.
		Off	Power is not being supplied from power input 1.
PWR2	Green	On	Power is being supplied from power input 2.
		Off	Power is not being supplied from power input 2.
PoE	Amber	On	Power is being supplied via PoE.
		Off	Power is not being supplied via PoE.
FAULT	Red	On	Relay is on.
		Quick Blinking	Cannot get an IP address from the DHCP server (interval: 1 sec)
		Slow Blinking	IP address conflict (interval: 0.5 sec)
		Off	Relay is off.
STATE	Green/Red	Green	Software Ready
		Blinking Green	The AWK has been located by AWK Search Utility (interval: 1sec)
		Red	Bootting or Error condition
WLAN1	Green/Amber	Green On	WLAN1 functions in Client mode.
		Blinking Green	WLAN1's data communication is running in Client mode (interval: 1 sec)
		Amber On	WLAN1 functions in AP/Bridge mode.
		Blinking Amber	WLAN1's data communication is running in AP/Bridge mode (interval: 1 sec)
		Off	WLAN1 is not in use.
WLAN2	Green/Amber	Green On	WLAN2 function is in Client mode.
		Blinking Green	WLAN2's data communication is running in Client mode (interval: 1 sec)
		Amber On	WLAN2 function is in AP/Bridge mode.
		Blinking Amber	WLAN2's data communication is running in AP/Bridge mode (interval: 1 sec)
		Off	WLAN2 is not in use.
TP Port (LAN1, LAN2) LED Indicators (Port Interface)			
10M	Yellow	On	TP port's 10 Mbps link is active .
		Blinking	Data is being transmitted at 10 Mbps
		Off	TP port's 10 Mbps link is inactive .
100M	Green	On	TP port's 100 Mbps link is active .
		Blinking	Data is being transmitted at 100 Mbps
		Off	TP port's 100 Mbps link is inactive .

**ATTENTION**

When the LEDs for **STATE** (Green), **FAULT**, **WLAN1** and **WLAN2** all light up simultaneously and blink at one-second intervals, it means the system failed to boot. This may be due to improper operation or uncontrollable issues, such as an unexpected shutdown during firmware update. To recover the firmware, refer to “Firmware Recovery” in Chapter 6.

Beeper

The beeper signals that the system is ready with two short beeps.

Reset Button

The **RESET** button is located on the top panel of the AWK-5222. You can reboot the AWK-5222 or reset it to factory default settings by pressing the **RESET** button with a pointed object such as an unfolded paper clip.

- **System reboot:** Hold the RESET button down for *under* 5 seconds and then release.
- **Reset to factory default:** Hold the RESET button down for *over* 5 seconds until the **STATE** LED starts blinking green. Release the button to reset the AWK-5222.

RESET button

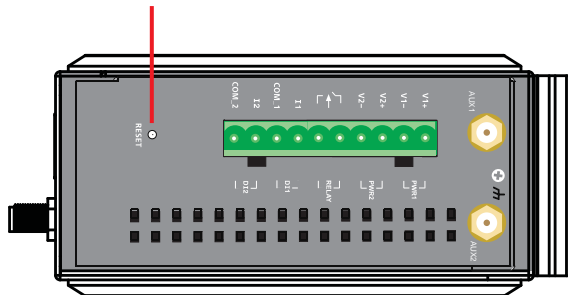

Relay (Digital Output)

The AWK-5222 has one relay output, which consists of the 2 terminal block contacts on the top panel, as shown below. These relay contacts are used to forward system failure and user-configured events.

The two wires attached to the relay contacts form an open circuit when a user-configured event is triggered. If a user-configured event does not occur, the relay circuit will remain closed. For safety reason, the relay circuit is kept open when the AWK-5222 is not powered.

The AWK-5222's relay status is summarized as follows:

Relay Status	Power off	Power on
No Event	OPEN	CLOSED
Triggered		OPEN

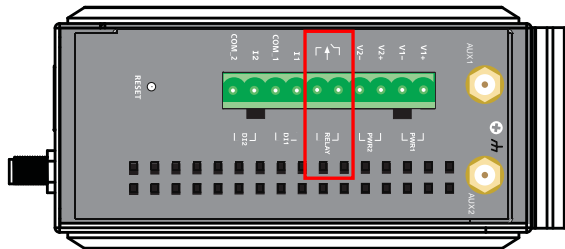

Antenna

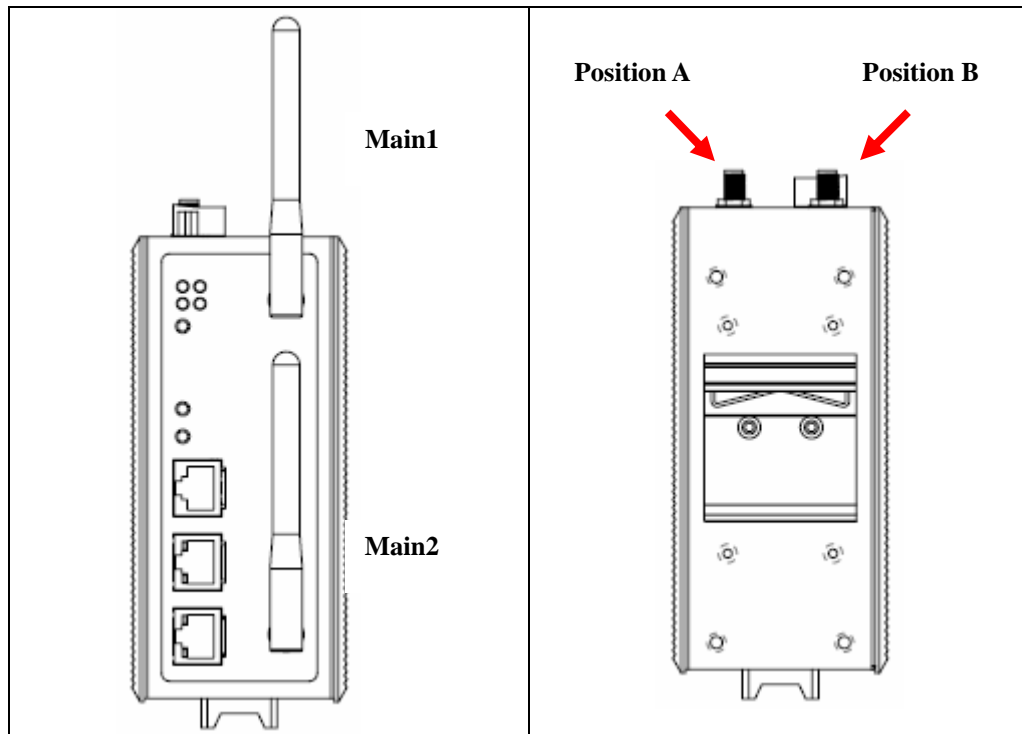

You can fit additional antennas to the sides of the AWK-5222 with an antenna cable (positions A and B). If you install the AWK-5222 in a cabinet, you must unscrew on reason restricted communication the antennas. In this case, the connection takes place through cable remote antennas, that you must install outside the cabinet. The default antenna for the AWK-5222 is a 2 dBi, dual-band omni-directional antenna, RP-SMA (male).

2

Getting Started

This chapter explains how to install Moxa's AirWorks AWK-5222 for the first time, and quickly set up your wireless network and test whether the connection is running well. With the function guide, you can find out the functions you need easily.

In this chapter, we cover the following topics:

- First-time Installation and Configuration**
- Communication Testing**
- Function Guiding Map**

First-time Installation and Configuration

Before installing the AWK-5222, make sure that all items in the Package Checklist are in the box. In addition, you will need access to a notebook computer or PC equipped with an Ethernet port. The AWK-5222 has a default IP address that you must use when connecting to the device for the first time.

Step 1: Select the power source.

The AWK-5222 can be powered by DC power input or PoE (Power over Ethernet). The AWK-5222 will use whichever power source you choose.

Step 2: Connect the AWK-5222 to a notebook or PC.

Since the AWK-5222 supports MDI/MDI-X auto-sensing, you can use either a straight-through cable or crossover cable to connect the AWK-5222 to a computer. If the LED indicator on AWK-5222's LAN port lights up, it means the connection is established.

Step 3: Set up the computer's IP address.

Set an IP address on the same subnet as the AWK-5222. Since the AWK-5222's default IP address is **192.168.127.253**, and the subnet mask is **255.255.255.0**, you should set the IP address of the computer to **192.168.127.xxx**.



NOTE

After you select **Maintenance** → **Load Factory Default** and click the **Submit** button, the AWK-5222 will be reset to factory default settings and the IP address will be also reset to **192.168.127.253**.

Step 4: Use the web-based manager to configure AWK-5222

Open your computer's web browser and type `http://192.168.127.253` in the address field to access the homepage of the web-based Network Manager. Before the homepage opens, you will need to enter the user name and password as shown in the following figure. For first-time configuration, enter the default user name and password and then click on the **Login** button:

The screenshot shows the Moxa Web Console Login interface. At the top, there is a green banner with the Moxa logo. Below the banner, the text 'Web Console Login' is displayed in blue. Underneath, there are two input fields: 'Username : admin' and 'Password :'. A 'Login' button is positioned below the password field. In the bottom left corner, there is a logo for 'goshead WEB SERVER'.



NOTE

Default user name and password:

User Name: **admin**

Password: **root**

For security reasons, we strongly recommend changing the default password. To do so, select **Maintenance > Password**, and then follow the on-screen instructions to change the password.



NOTE

After you click **Submit** to apply changes, you can see that the web page is refreshed, and the string “**(Update)**” and a blinking reminder will be shown on the upper-right corner of web page, as follow.



To make the changes effective, click **Restart** and then **Save and Restart** after you change the settings. About 30 seconds are needed for the AWK-5222 to complete its restart process.

Step 5: Select the operation mode for the AWK-5222.

By default, the AWK-5222's operation mode is set to Wireless redundancy. You can change the setting in **Wireless Settings → Operation mode** if you would like to use the Wireless bridge or AP-Client mode instead. Detailed information about configuring the AWK-5222's operation can be found in Chapter 3.

Step 6: Test communications.

We will describe 2 test methods to make sure the network connection has been established. Please refer to the following section for more details.

Communication Testing

After installation, you can run a sample test to make sure the AWK-5222 and wireless connection are functioning normally. Two testing methods are explained in the following sections. Use the first method if you are using only one AWK-5222 device, and use the second method if you are using two or more AWK-5222s.

Testing Method for one AWK-5222

If you are only using one AWK-5222, you will need a second notebook computer equipped with a WLAN card. Configure the WLAN card to connect to the AWK-5222 (NOTE: the default SSID is **MOXA**), and change the IP address of the second notebook (B) so that it is on the same subnet as the first notebook (A), which is connected to the AWK-5222.

After configuring the WLAN card, establish a wireless connection with the AWK-5222 and open a DOS window on Notebook B. At the prompt, type

```
ping <IP address of notebook A>
```

and then press **Enter** (see the figure below). A “Reply from IP address ...” response means the communication was successful. A “Request timed out.” response means the communication failed. In this case, recheck the configuration to make sure the connections are correct.

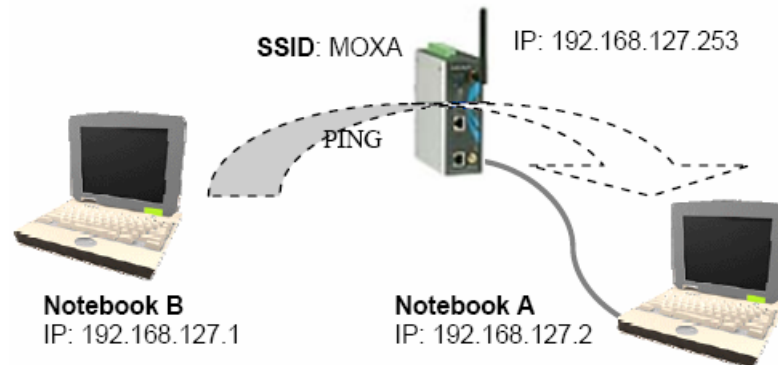

Testing Method for two or more AWK-5222s

If you have two or more AWK-5222s, you will need a second notebook computer (B) equipped with an Ethernet port. Use the default settings for the first AWK-5222 connected to notebook A and change the second or third AWK-5222 connected to notebook B to Client mode. Then, configure the notebooks and AWK-5222s properly.

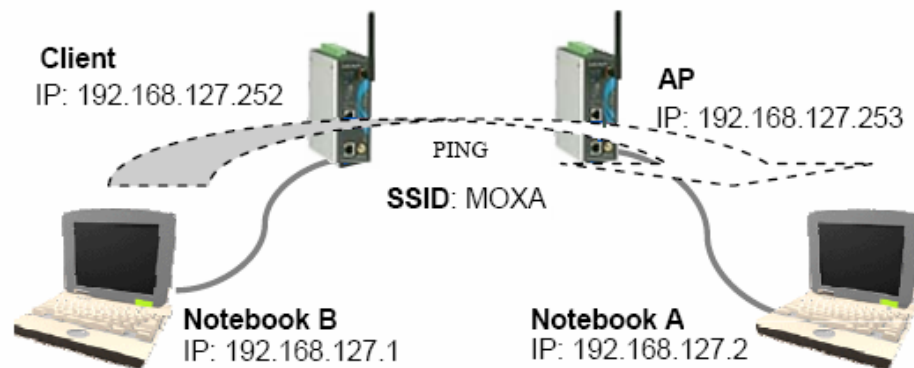

After setting up the testing environment, open a DOS window on notebook B. At the prompt, type

```
ping <IP address of notebook A>
```

and then press **Enter**. A “Reply from IP address ...” response means the communication was successful. A “Request timed out” response means the communication failed. In this case, recheck the configuration to make sure the connections are correct.

Function Guiding Map

The management functions are categorized in a tree and shown in the left field of the web-based management console. You can efficiently locate the function you need with the following guiding map.

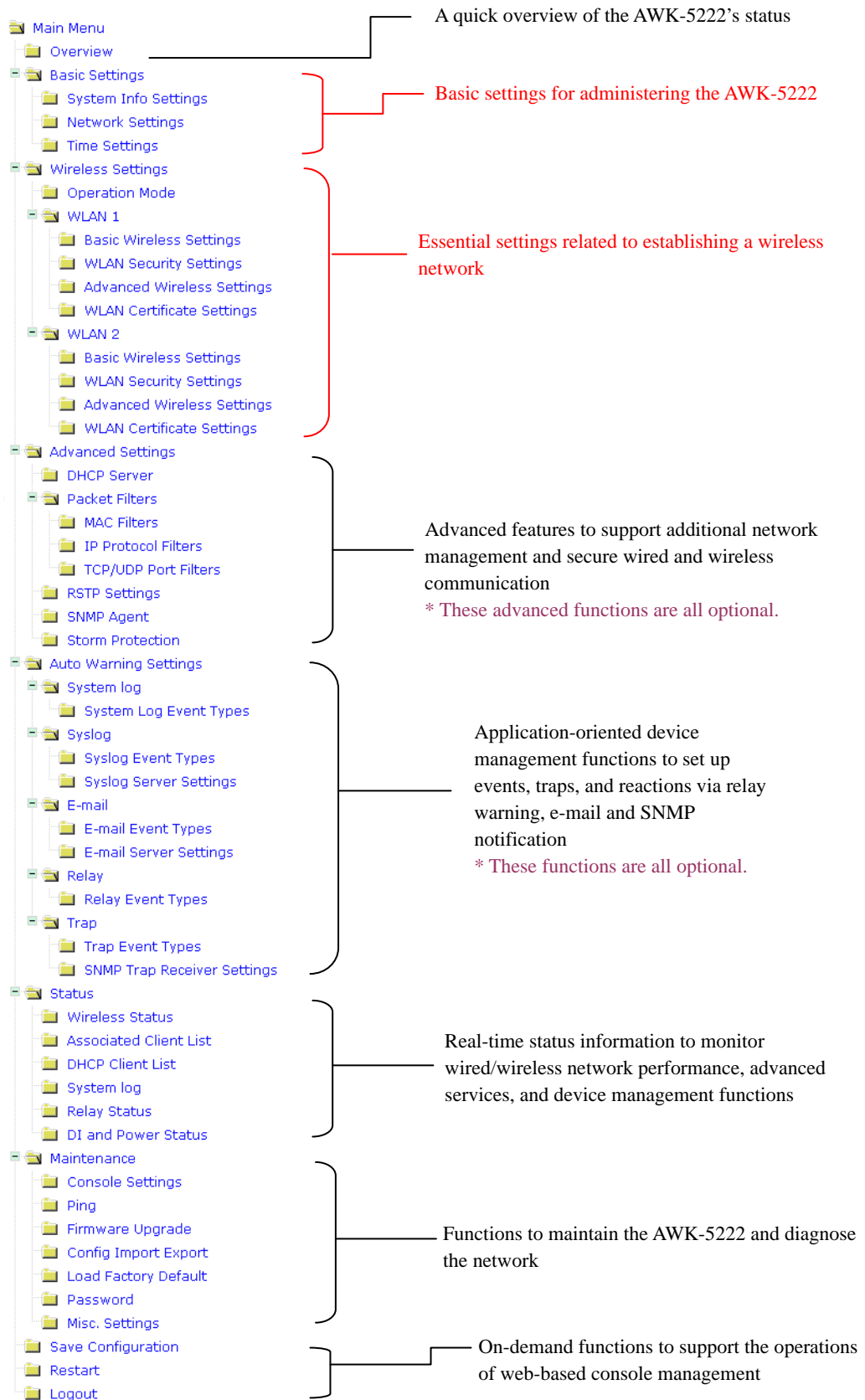

Web Console Configuration

In this chapter, we will explain each web management page of the web-based console configuration. Moxa's easy-to-use management functions will help you set up your AWK-5222, as well as establish and maintain your wireless network easily.

In this chapter, we cover the following topics:

- Configuration by Web Browser**
- Overview**
- Basic Settings**
- Wireless Settings**
- Advanced Settings**
- Auto Warning Setting**
- Status**
- Maintenance**
- Save Configuration**
- Restart**
- Logout**

Configuration by Web Browser

Moxa AWK-5222's web browser interface provides a convenient way to modify its configuration and access the built-in monitoring and network administration functions. The recommended web browser is Microsoft® Internet Explorer 5.5 or 6.0 with JVM (Java Virtual Machine) installed.



NOTE

To use the AWK-5222's management and monitoring functions from a PC host connected to the same LAN as the AWK-5222, you must make sure that the PC host and AWK-5222 are on the same logical subnet. Similarly, if the AWK-5222 is configured for other VLAN settings, you must make sure your PC host is on the management VLAN.

The Moxa AWK-5222's default IP is **192.168.127.253**.

Follow the steps below to access the AWK-5222's web-based console management.

1. Open your web browser (ex. Internet Explorer) and type the AWK-5222's IP address in the address field. Then press **Enter** to establish the connection.

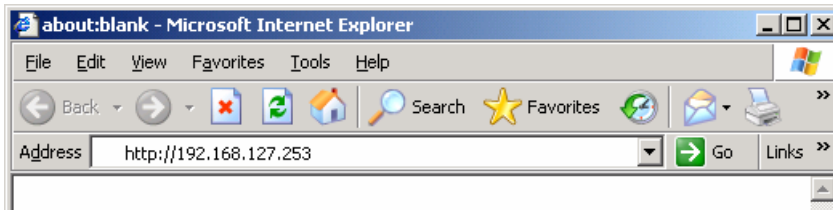

2. The Web Console Login page will open. Enter the password (User Name is set as **admin**; the default password is **root** if a new password has not been set.) and then click **Login** to continue.

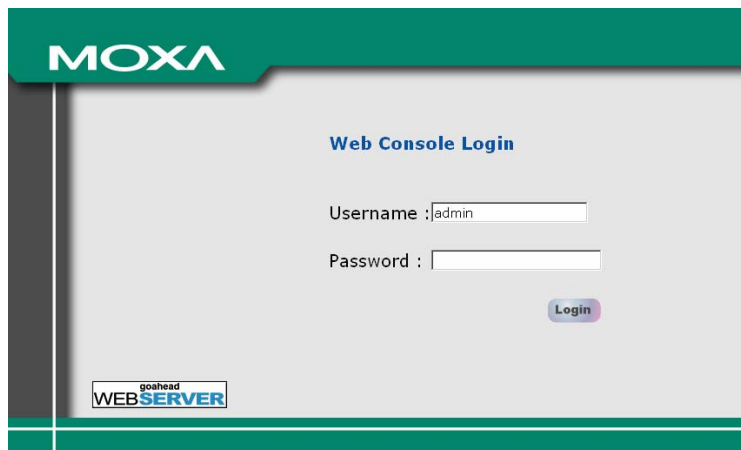

You may need to wait a few moments for the web page download onto your computer. Please note that the Model name and IP address of your AWK-312 are both shown on the title of the web page. This information can help you identify multiple AWK-5222s.

You can use the menu tree on the left side of the window to open the function pages to access each of AWK-5222's functions.

System info	
Model name	AWK-5222-US
Device name	AWK-5222_0013
Serial No.	13
System up time	0 days 00h:14m:19s
Firmware version	1.0 Build 09042201

Device info	
Device MAC address	00:90:E8:00:46:13
IP address	192.168.127.253
Subnet mask	255.255.255.0
Gateway	

In the following paragraphs, we will go through each of the AWK-5222's management functions in detail. You can also get a quick overview of these functions in the "Function Guiding Map" section of Chapter 2.

**NOTE**

The model name of the AWK-5222 is shown as AWK-5222-XX where XX indicates the country code. The country code represents the AWK-5222 version and which bandwidth it uses. We use **AWK-5222-US** as an example in the following figures. The country code of model name on the screen may vary if you are using a different version (band) AWK-5222.

**NOTE**

For security reasons, you will need to log back into the AWK-5222 after the 5-minute time-out.

Overview

The **Overview** page summarizes the AWK-5222's current status. The information is categorized into several groups: **System info**, **Device info** and **802.11 info**.

Overview

All information on this page are active values.

System info		
Model name	AWK-5222-US	
Device name	AWK-5222_0013	
Serial No.	13	
System up time	0 days 00h:14m:19s	
Firmware version	1.0 Build 09042201	
Device info		
Device MAC address	00:90:E8:00:46:13	
IP address	192.168.127.253	
Subnet mask	255.255.255.0	
Gateway		
802.11 info		
Country code	US	
Operation mode	Redundant	
	AP (WLAN 1)	AP (WLAN 2)
Channel	6	11
RF type	B/G Mixed	B/G Mixed
SSID	MOXA_1	MOXA_2

Basic Settings

The Basic Settings group includes the most commonly used settings required by administrators to maintain and control the AWK-5222.

System Info Settings

The **System Info** items, especially *Device name* and *Device description*, are displayed and included on the **Overview** page, SNMP information, and alarm emails. Setting **System Info** items makes it easier to identify the different AWK-5222s connected to your network.

System Info Settings

Device name	AP_011
Device location	Area 32, 5th Floor
Device description	No. 11 of ABC supporting system
Device contact information	John Davis, sysop@abc.com

Device name

Setting	Description	Factory Default
Max. 31 Characters	This option is useful for specifying the role or application of different AWK-5222 units.	AWK-5222_<Serial No. of this AWK-5222>

Device location

Setting	Description	Factory Default
Max. 31 Characters	To specify the location of different AWK-5222 units.	None

Device description

Setting	Description	Factory Default
Max. 31 Characters	Use this space to record more detailed description of AWK-5222	None

Device name

Setting	Description	Factory Default
Max. 31 Characters	To provide information about whom to contact in order to resolve problems. Use this space to record contact information of the person responsible for maintaining this AWK-5222.	None

Network Settings

The Network Settings configuration allows you to modify the usual TCP/IP network parameters. An explanation of each configuration item is given below.

Network Settings

IP configuration

IP address

Subnet mask

Gateway

Primary DNS server

Secondary DNS server

IP configuration

Setting	Description	Factory Default
DHCP	The AWK-5222's IP address will be assigned automatically by the network's DHCP server	Static
Static	Set up the AWK-5222's IP address manually.	

IP address

Setting	Description	Factory Default
AWK-5222's IP address	Identifies the AWK-5222 on a TCP/IP network.	192.168.127.253

Subnet mask

Setting	Description	Factory Default
AWK-5222's subnet mask	Identifies the type of network to which the AWK-5222 is connected (e.g., 255.255.0.0 for a Class B network, or 255.255.255.0 for a Class C network).	255.255.255.0

Gateway

Setting	Description	Factory Default
AWK-5222's default gateway	The IP address of the router that connects the LAN to an outside network.	None

Primary/ Secondary DNS server

Setting	Description	Factory Default
IP address of Primary/ Secondary DNS server	The IP address of the DNS Server used by your network. After entering the DNS Server's IP address, you can input the AWK-5222's URL (e.g., <i>http://ap11.abc.com</i>) in your browser's address field instead of entering the IP address. The Secondary DNS server will be used if the Primary DNS server fails to connect.	None

Time Settings

The AWK-5222 has a time calibration function based on information from an NTP server or user specified Date and Time information. Functions such as Auto warning can add real-time information to the message.

Time Settings

Date (YYYY/MM/DD) Time (HH:MM:SS)

Current local time / / : :

Time zone

Daylight saving time Enable

Starts at : (HH:MM)

Stops at : (HH:MM)

Time offset

Time server 1

Time server 2

Query period (600~9999 seconds)

Current local time shows the AWK-5222's system time when you open this web page. You can click on the **Set Time** button to activate the update after setting up the date and time parameters. An "(Updated)" string will appear to indicate that the change is complete. Local time settings will be immediately activated in the system without running Save and Restart.



NOTE

The AWK-5222 has a real time clock (RTC). Users are strongly recommended to update the **Local time** for the AWK-5222 after initial setup or long-term shutdown, especially when the network does not have an Internet connection for accessing the NTP server or there is no NTP server on the LAN.

Current local time

Setting	Description	Factory Default
User adjustable time	The date and time parameters allow configuration of the local time with immediate activation.	None (yyyy/mm/dd hh:mm:ss format; 24-hour format.)

Time zone

Setting	Description	Factory Default
User selectable time zone	The time zone setting allows conversion from GMT (Greenwich Mean Time) to local time.	GMT (Greenwich Mean Time)



ATTENTION

Changing the time zone will automatically adjust the **Current local time**. You should configure the **Time zone** before setting the **Current local time**.

Daylight saving time

Setting	Description	Factory Default
Enable/ Disable	Daylight saving time (also know as DST or summer time) involves advancing clocks (usually 1 hour) during the summer time to provide an extra hour of daylight in the afternoon.	Disable

When **Daylight saving time** is enabled, the following parameters can be shown:

- The **Starts at** parameter allows users to enter the date that daylight saving time begins.
- The **Stops at** parameter allows users to enter the date that daylight saving time ends.
- The **Time offset parameter** indicates how many hours forward the clock should be advanced.

Time server 1/ 2

Setting	Description	Factory Default
The 1st/ 2nd time server IP/Name	IP or Domain address of NTP time server. The 2nd time will be used if the 1st NTP server fails to connect.	None

Query period

Setting	Description	Factory Default
Query period time (1- 9999 seconds)	This parameter determines how often the time is updated from the NTP server.	600 (seconds)

Wireless Settings

The essential settings for wireless networks are presented in this function group. Settings must be properly set before establishing your wireless network.

Operation Mode

The AWK-5222 supports three operation modes that are used for different wireless network applications:

Wireless Redundancy

The wireless redundancy operation mode can be used to set up a redundant wireless connection between a redundant client device and a redundant AP device. The redundant structure involves using the AWK-5222's two RF modules to set up two independent wireless connections between the redundant client and redundant AP devices. If either of the two wireless connections fails, the other wireless connection will continue transmitting packets between the redundant client and redundant AP devices. In fact, one of the biggest advantages of the AWK-5222's wireless redundancy mode is that you can expect "zero data loss."

Operation mode

WLAN Operation mode

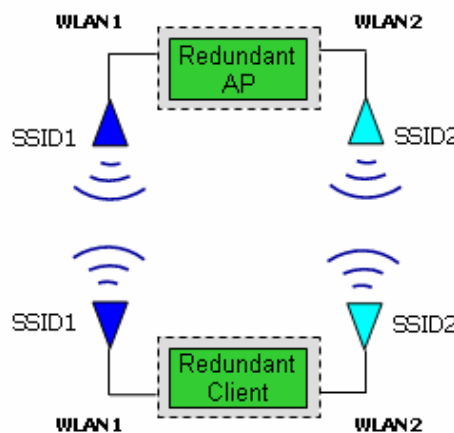

△ WLANs with same color must have identical RF type, SSID, and security settings.

Wireless Bridge

A bridge is a network component that connects two networks. A bridge's operation is based on the AP (master) and Client (Slave) concept. Both side connections must have the same RF type, SSID, and security settings.

Operation mode

WLAN 1 Operation mode

WLAN 2 Operation mode

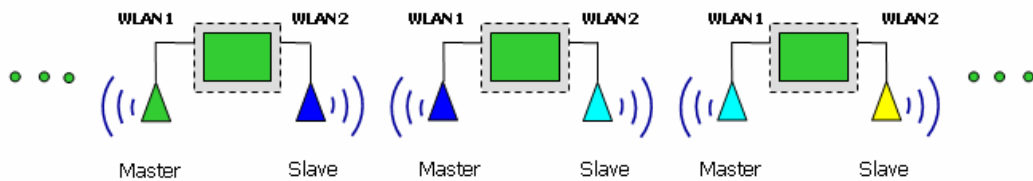

△ WLANs with same color must have identical RF type, SSID, and security settings.

AP-Client

AP mode is used for static LAN-to-LAN Bridging.

Client mode is used for dynamic LAN-to-LAN Bridging or Device-to-LAN applications. The Client automatically establishes bridge links with other APs.

Operation mode

WLAN 1 Operation mode

WLAN 2 Operation mode

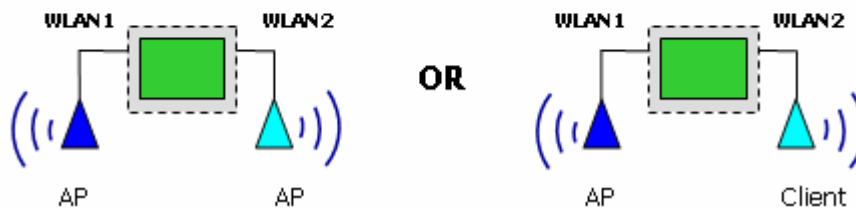

To establish a dynamic bridge link between an AP and a Client or a Master and a Slave, Redundant AP and Redundant Client, both devices must be configured with the same, channel, and security settings (see “WLAN Security Settings”).

When the AWK-5222 is configured to be in **Redundant Client, Client or Slave** mode, it can be used as an Ethernet-to-wireless (or LAN-to-WLAN) network adapter. For example, a notebook computer equipped with an Ethernet adapter, but no wireless card, can be connected to this device with an Ethernet cable for wireless connectivity to another AP.



NOTE

Although it is more convenient to use dynamic bridging, there is a limitation — the Client or Slave can only transmit IP-based packets between its wireless interface (WLAN) and Ethernet interface (LAN); other types of traffic (such as IPX and AppleTalk) are not forwarded.

WLAN1/WLAN2

The following figure shows the Basic Wireless Settings page. The parameters and options are described as follows:

WLAN 1 Basic Wireless Settings

Operation mode	AP
RF type	B/G Mixed <input type="button" value="v"/>
Channel	6 <input type="button" value="v"/>
SSID	MOXA_1 <input type="text"/>
SSID broadcast	<input checked="" type="radio"/> Enable <input type="radio"/> Disable

Operation mode: This operation mode is based on the operation mode that you select.



NOTE

When you switch to Wireless Redundancy or Wireless Bridge mode, you can find an additional Basic Setting Selection overview page. Please click on Edit to modify basic wireless settings.

WLAN 1 Basic Setting Selection

Status	SSID	Operation Mode	Action
Active	MOXA_1	Redundant - AP	<input type="button" value="Edit"/>
Disabled	MOXA_1_1	AP	<input type="button" value="Edit"/>



NOTE

When you switch to **Redundant Client, Client, or Slave** mode, you can find an additional **Site Survey** button on this page. It can support site survey and pop up a dialog box listing the information of available APs, as shown in the following figure. You can click on the SSID of an entity and bring the value of its SSID onto the SSID field of the Basic Wireless Settings page. Clicking on the **Refresh** button will re-scan and update the table.

Operation mode Client
RF type B/G Mixed
Channel 6
SSID MOXA_1
SSID broadcast Enable Disable

Site Survey

No.	SSID	MAC address	Channel	Mode	Signal
1	Home	00-18-84-81-CD-9A	1	BSS/WEP	■■■■
2	FON_AP	00-18-84-81-CD-99	1	BSS/OPEN	■■■■
3	default	00-15-F2-A2-07-6A	1	BSS/OPEN	■■■■
4	BLW-54PM	00-90-CC-D6-B5-20	6	BSS/WEP	■■■■
5	BLW-54PM	00-90-CC-D6-BC-EC	6	BSS/OPEN	■■■■
6	ZyXEL	00-19-CB-41-48-9A	11	BSS/WEP	■■■■
7		00-16-01-8C-11-7F	11	BSS/OPEN	■■■■
8	HJ-Wireless	00-16-01-ED-D0-61	2	BSS/WEP	■■■■
9	default	00-40-05-56-9D-B1	8	BSS/WEP	■■■■
10	hpsetup	52-BC-90-E2-84-14	10	Ad Hoc/OPEN	■■■■

Refresh Close



NOTE

If the **Gateway** field in **Basic Settings** → **Network Settings** is empty, a warning message will appear, reminding you to set the default gateway when **Client** mode is enabled. You can ignore this message if you are only planning a local network and no packet will be sent outside the network.

RF type

Setting	Description	Factory Default
A	Supports IEEE802.11a standard only	B/G Mixed
B	Supports IEEE802.11b standard only	
G	Supports IEEE802.11g standard only	
B/G Mixed	Supports both of IEEE802.11b/g standards, but 802.11g can be slowed down when 802.11b clients are on the network	

Channel (for Redundant AP, AP, or Master mode only)

Setting	Description	Factory Default
Available channels vary with RF type	AWK-5222 plays a role of wireless AP.	6 (in B/G Mixed mode)

SSID

Setting	Description	Factory Default
Max. 31 Characters	The SSID of a client and the SSID of the AP must be identical for them to communicate with each other.	MOXA

SSID broadcast (for Redundant AP, AP, or Master mode only)

Setting	Description	Factory Default
Enable/ Disable	SSID can be broadcast or not.	Enable

WLAN Security Settings

The following figure shows the WLAN1/2 Security Settings page. The parameters and options are described as follows:

**NOTE**

When you switch to **Wireless Redundancy mode**, you will see an additional **WLAN Security Setting** overview page. Please click on **Edit** to modify WLAN security settings.

WLAN 1 Security Setting Selection

Status	SSID	Operation Mode	Security Mode	Action
Active	MOXA_1	Redundant - AP	OPEN	<input type="button" value="Edit"/>
Disabled	MOXA_1_1	AP	OPEN	<input type="button" value="Edit"/>

The AWK-5222 provides four standardized wireless security modes: Open, WEP (Wired Equivalent Privacy), WPA (Wi-Fi Protected Access) and WPA2. Several types of security models are available in AWK-5222 by selecting *Security mode* and *WPA type*:

- **Open:** No authentication, no data encryption.
- **WEP:** Static WEP (Wired Equivalent Privacy) keys must be manually configured.
- **WPA/WPA2-Personal:** also known as WPA/WPA2-PSK. You need to specify the Pre-Shared Key in the *Password* field, which will be used by the TKIP or AES engine as a master key to generate keys that actually encrypt outgoing packets and decrypt incoming packets.
- **WPA/WPA2-Enterprise:** also called WPA/WPA2-EAP (Extensible Authentication Protocol). In addition to device-based authentication, WPA/WPA2-Enterprise enables user-based authentication via IEEE802.1X. The AWK-5222 can support three EAP methods: EAP-TLS, EAP-TTLS, and EAP-PEAP.

SSID MOXA_1

Security mode Open ▾

Submit

Security mode

Setting	Description	Factory Default
Open	No authentication	Open
WEP	Static WEP is used	
WPA	WPA is used	
WPA2	Fully supports IEEE802.11i with "TKIP/AES + 802.1X"	

Open

For security reasons, it is highly recommended that the security mode should be set to the options other than Open System. When the security mode is set to Open System, no authentication or data encryption will be performed.

WEP

According to the IEEE802.11 standard, WEP can be used for authentication and data encryption (confidentiality). **Shared** (or **Shared Key**) authentication type is used if WEP authentication and data encryption are both needed. Normally, **Open** (or **Open System**) authentication type is often used when WEP data encryption is run with authentication.

When WEP is enabled as a security mode, the length of a key (so-called WEP seed) can be specified as 64/128 bits, which is actually a 40/104-bit secret key with a 24-bit initialization vector. The AWK-5222 provides 4 entities of WEP key settings that can be selected to use with *Key index*. The selected key setting specifies the key to be used as a *send-key* for encrypting traffic from the AP side to the wireless client side. All 4 WEP keys are used as *receive-keys* to decrypt traffic from the wireless client side to the AP side.

The WEP key can be presented in two *Key type*, HEX and ASCII. Each ASCII character has 8 bits, so a 40-bit (or 64-bit) WEP key contains 5 characters, and a 104-bit (or 128-bit) key has 13 characters. In hex, each character uses 4 bits, so a 40-bit key has 10 hex characters, and a 128-bit key has 26 characters.

SSID MOXA_1
Security mode WEP ▾
Authentication type Open ▾
Key type HEX ▾
Key length 64 bits ▾
Key index 1 ▾
WEP key 1
WEP key 2
WEP key 3
WEP key 4

Authentication type

Setting	Description	Factory Default
Open	Data encryption is enabled, but no authentication	Open
Shared	Data encryption and authentication are both enabled.	

Key type

Setting	Description	Factory Default
HEX	Specifies WEP keys in hex-decimal number form	HEX
ASCII	Specifies WEP keys in ASCII form	

Key length

Setting	Description	Factory Default
64 bits	Uses 40-bit secret keys with 24-bit initialization vector	64 bits
128 bits	Uses 104-bit secret key with 24-bit initialization vector	

Key index

Setting	Description	Factory Default
1-4	Specifies which WEP key is used	Open

WEP key 1-4

Setting	Description	Factory Default
ASCII type: 64 bits: 5 chars 128 bits: 13chars HEX type: 64 bits: 10 hex chars 128 bits: 26 hex chars	A string that can be used as a WEP seed for RC4 encryption engine.	None

WPA/WPA2-Personal

WPA (Wi-Fi Protected Access) and WPA2 are significantly improved encryption methods of WEP. WPA is a security standard based on 802.11i draft 3, while WPA2 is based on the fully ratified version of 802.11i. The initial vector is transmitted, encrypted, and enhanced with its 48 bits, twice as long as WEP. The key is regularly changed so that true session is secured.

Even though AES encryption is only included in the WPA2 standard, it is widely available in the WPA security mode of some wireless APs and clients as well. The AWK-5222 also supports AES algorithms in WPA and WPA2 for better compatibility.

Personal versions of WPA/WPA2, also know as WPA/WPA-PSK (*Pre-Shared Key*), provides a simple way of encrypting a wireless connection for high confidentiality. A **Passphrase** is used as a basis for encryption methods (or cipher types) in a WLAN connection. The passphrases should be complex and as long as possible. The number of ASCII characters of the Passphrase must be at least 8 and can go up to 63. For security reason, this passphrase should be disclosed to the relevant users only and changed regularly.

<p>SSID</p> <p>Security mode</p> <p>WPA type</p> <p>Encryption method</p> <p>Passphrase</p> <p>Key renewal</p>	<p>MOXA_1</p> <p>WPA</p> <p>Personal</p> <p>TKIP</p> <p>TKIP</p> <p>AES</p> <p>Mixed</p> <p>3600 (60~86400 seconds)</p>
--	---

WPA Type

Setting	Description	Factory Default
Personal	Provides Pre-Shared Key-enabled WPA and WPA2	Personal
Enterprise	Provides enterprise-level security for WPA and WPA2	

Encryption method

Setting	Description	Factory Default
TKIP	Temporal Key Integrity Protocol is enabled	TKIP
AES	Advance Encryption System is enabled	
Mixed*	Provides TKIP broadcast key and TKIP+AES unicast key for some legacy AP clients. This option is rarely used. *This option is available in Redundant AP, AP, or Master mode only, and cannot support AES-enabled clients.	

Passphrase

Setting	Description	Factory Default
8 – 63 characters	Master key to generate keys for encryption and decryption	None

Key renewal (for Redundant AP, AP, or Master mode only)

Setting	Description	Factory Default
60 – 86400 seconds (1 minute to 1 year)	Specifies the time period of group key renewal	3600 (seconds)

**NOTE**

The value for *key renewal* instructs the wireless AP how often it should change the encryption keys. Usually the security level will be higher if you set this value shorter so that the encryption keys are changed more often. Default value is 3600 seconds (6 minutes). Longer time periods can be considered if traffic is not so busy.

WPA/WPA2-Enterprise (for Redundant AP, AP, or Master mode)

By selecting *WPA type* as **Enterprise**, you can use **EAP** (*Extensible Authentication Protocol*), a framework authentication protocol used by 802.1X to provide network authentication. In these Enterprise-level security modes, a back-end RADIUS (Remote Authentication Dial-In User Service) server is needed if IEEE 802.1X functionality is enabled in WPA /WPA2. The IEEE 802.1X protocol also offers the possibility of carrying out an efficient connection authentication in a large-scaled network. It is not necessary to exchange keys or passphrases.

WLAN 1 WLAN Security Settings

SSID	MOXA_1
Security mode	WPA2 ▾
WPA type	Enterprise ▾
Encryption method	TKIP ▾
Primary RADIUS server IP	<input type="text"/>
Primary RADIUS server port	<input type="text"/>
Primary RADIUS shared key	<input type="text"/>
Secondary RADIUS server IP	<input type="text"/>
Secondary RADIUS server port	1812
Secondary RADIUS shared key	<input type="text"/>
Key renewal	3600 (60~86400 seconds)

WPA Type

Setting	Description	Factory Default
Personal	Provides Pre-Shared Key-enabled WPA and WPA2	Personal
Enterprise	Provides enterprise-level security for WPA and WPA2	

Encryption method

Setting	Description	Factory Default
TKIP	Temporal Key Integrity Protocol is enabled	TKIP
AES	Advance Encryption System is enabled	
Mixed*	Provides TKIP broadcast key and TKIP+AES unicast key for some legacy AP clients. This option is rarely used. *This option is available in Redundant AP, AP, or Master mode only, and cannot support AES-enabled clients.	

Primary/ Secondary RADIUS server IP

Setting	Description	Factory Default
The IP address of RADIUS server	Specifies the delegated RADIUS server for EAP	None

Primary/ Secondary RADIUS port

Setting	Description	Factory Default
Port number	Specifies the port number of the delegated RADIUS server	1812

Primary/ Secondary RADIUS shared key

Setting	Description	Factory Default
Max. 31 characters	The secret key shared between AP and RADIUS server	None

Key renewal

Setting	Description	Factory Default
60 – 86400 seconds (1 minute to 1 year)	Specifies the time period of group key renewal	3600 (seconds)

WPA/WPA2-Enterprise (for Redundant Client, Client, or Slave mode)

In a client role, the AWK-5222 can support three EAP methods (or *EAP protocols*): **EAP-TLS**, **EAP-TTLS**, and **EAP-PEAP**, corresponding to WPA/WPA-Enterprise settings on the AP side.

WLAN 1 WLAN Security Settings

SSID	MOXA_1
Security mode	WPA2 ▼
WPA type	Enterprise ▼
Encryption method	TKIP ▼
EAP protocol	TLS ▼
	TLS
	TTLS
	PEAP

Encryption method

Setting	Description	Factory Default
TKIP	Temporal Key Integrity Protocol is enabled	TKIP
AES	Advance Encryption System is enabled	

EAP Protocol

Setting	Description	Factory Default
TLS	Specifies Transport Layer Security protocol	TLS
TTLS	Specifies Tunneled Transport Layer Security	
PEAP	Specifies Protected Extensible Authentication Protocol, or <i>Protected EAP</i>	

Before choosing the EAP protocol for your WPA/WPA2-Enterprise settings on the client end, please contact the network administrator to make sure the system supports the protocol on the AP end. Detailed information on these three popular EAP protocols is presented in the following sections:

EAP-TLS

TLS is the standards-based successor to the Secure Socket Layer (SSL). It can establish a trusted communication channel over a distrusted network. TLS provides mutual authentication through certificate exchange. EAP-TLS is also secure to use. You are required to submit a digital certificate to the authentication server for validation, but the authentication server must also supply a certificate.

You can use **Basic Wireless Settings** → **WLAN Certificate Settings** to import your WLAN certificate and enable EAP-TLS on the client end.

WLAN 1 WLAN Security Settings

SSID	MOXA_1
Security mode	WPA2 ▾
WPA type	Enterprise ▾
Encryption method	TKIP ▾
EAP protocol	TLS ▾
Certificate issued to	N/A
Certificate issued by	N/A
Certificate expiration date	N/A

You can check the current certificate status in *Current Status* if it is available.

Certificate issued to: shows the certificate user

Certificate issued by: shows the certificate issuer

Certificate expiration date: indicates when the certificate gets invalid

EAP-TTLS

It is usually much easier to re-use existing authentication systems, such as a Windows domain or Active Directory, LDAP directory, or Kerberos realm, rather than creating a parallel authentication system. As a result, TTLS (Tunneled TLS) and PEAP (Protected EAP) are used to support the use of so-called “legacy authentication methods.”

TTLS and PEAP work in a similar way. First, they establish a TLS tunnel, like EAP-TLS, and validate whether the network is trustworthy with digital certificates on the authentication server. This step is run to establish a tunnel that protects the next step (or “inner” authentication) so it is sometimes referred to as the “outer” authentication. Then the TLS tunnel is used to encrypt an older authentication protocol that authenticates the user for the network.

As you can see, digital certificates are still needed for the outer authentication in a simplified form. Only a small number of certificates are required, which can be generated by a small certificate authority. Certificate reduction makes TTLS and PEAP much more popular than EAP-TLS.

The AWK-5222 provides some non-cryptographic EAP methods including **PAP**, **CHAP**, **MS-CHAP**, and **MS-CHAP-V2**. These EAP methods are not recommended for direct use on wireless networks. However, they may be useful as inner authentication methods with TTLS or PEAP.

Because the inner and outer authentications can use distinct user names in TTLS and PEAP, you can use an anonymous user name for the outer authentication, while the true user name is shown only through the encrypted channel. Remember, not all client software supports anonymous alteration. Confirm this with the network administrator before you enable identity hiding in TTLS and PEAP.

WLAN 1 WLAN Security Settings

SSID	MOXA_1
Security mode	WPA2 ▾
WPA type	Enterprise ▾
Encryption method	TKIP ▾
EAP protocol	TTLS ▾
TTLS inner authentication	MS-CHAP-V2 ▾
Anonymous name	<input type="text"/>
User name	<input type="text"/>
Password	<input type="text"/>

TTL Inner Authentication

Setting	Description	Factory Default
PAP	Password Authentication Protocol is used	MS-CHAP-V2
CHAP	Challenge Handshake Authentication Protocol is used	
MS-CHAP	Microsoft CHAP is used	
MS-CHAP-V2	Microsoft CHAP version 2 is used	

Anonymous

Setting	Description	Factory Default
Max. 31 characters	A distinct name used for outer authentication	None

User name & Password

Setting	Description	Factory Default
	User name and password used in inner authentication	None

PEAP

There are a few differences in the inner authentication procedures for TTLS and PEAP. TTLS uses the encrypted channel to exchange attribute-value pairs (AVPs), while PEAP uses the encrypted channel to start a second EAP exchange inside of the tunnel. The AWK-5222 provides **MS-CHAP-V2** merely as an EAP method for inner authentication.

WLAN 1 WLAN Security Settings

SSID	MOXA_1
Security mode	WPA2 ▾
WPA type	Enterprise ▾
Encryption method	TKIP ▾
EAP protocol	PEAP ▾
Inner EAP protocol	MS-CHAP-V2 ▾
Anonymous name	MS-CHAP-V2
User name	
Password	

Inner EAP protocol

Setting	Description	Factory Default
MS-CHAP-V2	Microsoft CHAP version 2 is used	MS-CHAP-V2

Anonymous

Setting	Description	Factory Default
Max. 31 characters	A distinct name used for outer authentication	None

User name & Password

Setting	Description	Factory Default
	User name and password used in inner authentication	None

Advanced Wireless Settings

Additional wireless-related parameters are presented in this section to help you set up your wireless network in detail.

WLAN 1 Advanced Wireless Settings

Transmission rate	Auto	▼
Transmission power	Full	▼
Beacon interval	100	(40~1000ms)
DTIM interval	1	(1~15)
Fragmentation threshold	2346	(256~2346)
RTS threshold	2346	(256~2346)
Transmission distance	500	(500 ~ 10000m)
Transmission enhancement	Disable	▼
Antenna	Main	▼
EAPOL version	1	▼

Transmission Rate

Setting	Description	Factory Default
Auto	AWK-5222 will sense and adjust the data rate automatically	Auto
Available rates	User can manually select a target transmission data rate	

Transmission Power

Setting	Description	Factory Default
Auto	Specifies wireless signal coverage by automatically selecting the strength of Tx power	Full
Full	Equivalent to 100% of maximum Tx power	
High	Equivalent to 75% of maximum Tx power	
Medium	Equivalent to 50% of maximum Tx power	
Low	Equivalent to 25% of maximum Tx power	

Beacon Interval (for Redundant AP, AP, Master mode only)

Setting	Description	Factory Default
Beacon Interval (40-1000 ms)	This value indicates the frequency interval of the beacon	100 (ms)

DTIM Interval (for Redundant AP, AP, Master mode only)

Setting	Description	Factory Default
Data Beacon Rate (1-16384)	This value indicates how often the AWK-5222 sends out a Delivery Traffic Indication Message	1

Fragment threshold

Setting	Description	Factory Default
Fragment Length (256-2346)	This parameter specifies the maximum size a data packet before splitting and creating another new packet	2346

RTS threshold

Setting	Description	Factory Default
RTS/CTS Threshold (256-2346)	This setting determines how large a packet can be before the Access Point coordinates transmission and reception to ensure efficient communication	2346

**NOTE**

You can refer to the related glossaries in Chapter 5 for more detailed information about the above-mentioned settings. By setting these parameters properly, you can better tune the performance of your wireless network.

Transmission distance

Setting	Description	Factory Default
Distance or max. range for transmission (500-10000m)	The distance specifies the transmission distance or max. range between two AWK devices. This parameter should be set properly, especially for long-distance communication.	500

Transmission enhancement

Setting	Description	Factory Default
Enable/Disable	This setting can enhance communication by strengthening the AWK-5222's transmission power. It is quite useful for long-distance transmission or countering environmental interference. The user has to carefully evaluate and measure the transmission power of whole system, and make sure it is still below the regulative limitation.	Disable



NOTE

Make sure the same **Transmission distance** parameters are set in both **AP** and **Client** sides, and both **Master and Slave**. When this parameter is more than 500, an optimal algorithm will be enabled to support long-distance transmission.

Transmission enhancement is also recommended to enable communication at both ends when long-distance transmission is required. A high-gain antenna installed at a fixed antenna connector can also improve performance. (Select **Antenna** at MAIN or AUX.)

Antenna

Setting	Description	Factory Default
Auto	The AWK-5222 uses four antennas (two MAIN and two AUX) and enables the diversity function for reducing multipath effect.	Auto
MAIN 1 and MAIN 2	Diversity function is disabled. Only MAIN 1 and 2 antenna is in use.	
AUX 1 and AUX 2	Diversity function is disabled. Only AUX 1 and 2 antenna is in use.	

EAPOL Version

Setting	Description	Factory Default
1	EAPOL version 1 was standardized in the 2001 version of 802.1X, which is much more commonly implemented.	1
2	EAPOL version 2 was specified in 802.1X-2004.	

Turbo Roaming (for AP-Client operation mode's Client mode only)

Setting	Description	Factory Default
Enable/ Disable	Moxa's Turbo Roaming can enable rapid handover when the AWK-5222, as a client, roams among a group of APs.	Disable

When Turbo Roaming is enabled, RF type and Scan channels will be shown as follows. RF type shows the current **RF type**, which this client is using now. You can set up **Scan channels** for the APs among which this client is going to roam. There are three Scan channels available. Please note that the **Scan channels** may need to be modified when the **RF type** is changed. (For example, channel 36 is not available in **B**, **G** or **B/G Mix** mode.)

Turbo roaming

 Enable

RF type

B/G Mixed

Scan channels

1

Not scanning

Not scanning

WLAN Certification Settings (for EAP-TLS in Redundant Client, Client or Slave mode only)

When EAP-TLS is used, a WLAN Certificate will be required at the client end to support WPA/WPA2-Enterprise. The AWK-5222 can support the **PKCS #12**, also known as *Personal Information Exchange Syntax Standard*, certificate formats that define file formats commonly used to store private keys with accompanying public key certificates, protected with a password-based symmetric key.

WLAN Certificate Settings Import (for EAP-TLS in Client mode only)

Current status

Certificate issued to

Certificate issued by

Certificate expiration date

Current Status displays information for the current WLAN certificate, which has been imported into the AWK-5222. Nothing will be shown if no certificate is available.

Certificate issued to: shows the certificate user

Certificate issued by: shows the certificate issuer

Certificate expiration date: indicates when the certificate gets invalid

You can import a new WLAN certificate in *Import WLAN Certificate* by following these steps in order:

1. Input the corresponding password (or key) in the **Certificate private password** field. Then click **Submit** to set the password.
2. You can see the password displayed in the Certificate private password field. Then click on the **Browse** button in *Select certificate/key file* and select the certificate file.
3. Click **Upload Certificate File** to import the certificate file. If it succeeds, you can see the information uploaded in *Current Certificate*. If it fails, you may need to return to step 1 to set the password correctly and then import the certificate file again.

Step 1:

Certificate private password

Submit

Step 2:

Select certificate/key file

Browse...

Upload Certificate File



NOTE

The WLAN certificate will remain after the AWK-5222 reboots. Even though it is expired, it can still be seen on *Current Certificate*.

Advanced Settings

Several advanced functions are available to increase the functionality of your AWK-5222 and wireless network system. The DHCP server helps you deploy wireless clients efficiently. Packet filters provide security mechanisms, such as firewalls, in different network layers. Moreover, the AWK-5222 can support STP/RSTP protocol to increase the reliability across the entire network. In addition, SNMP support can ease the network management via SNMP protocols.

DHCP Server (for AP mode only)

DHCP (Dynamic Host Configuration Protocol) is a networking protocol that allows administrators to assign temporary IP addresses to network computers by “leasing” an IP address to a user for a limited amount of time, instead of assigning permanent IP addresses.

The AWK-5222 can act as a simplified DHCP server and easily assign IP addresses to your wireless clients by responding to the DHCP requests from the client ends. The IP-related parameters you set on this page will also be sent to the client.

You can also assign a static IP address to a specific client by entering its MAC address. The AWK-5222 provides a **Static DHCP mapping** list with up to 16 entities. Be reminded to check the **Active** check box for each entity to activate the setting.

You can check the IP assignment status under **Status** → **DHCP Client List**.

DHCP server

DHCP server (AP only)	<input type="button" value="Disable"/>
Default gateway	<input type="button" value="Enable"/> <input type="button" value="Disable"/>
Subnet mask	<input type="text"/>
Primary DNS server	<input type="text"/>
Secondary DNS server	<input type="text"/>
Start IP address	<input type="text"/>
Maximum number of users	<input type="text"/>
Client lease time	<input type="text" value="10"/> (1~10 days)

Static DHCP mapping

No	<input type="checkbox"/> Active	IP address	MAC address
1	<input type="checkbox"/>	<input type="text"/>	<input type="text"/>
2	<input type="checkbox"/>	<input type="text"/>	<input type="text"/>
3	<input type="checkbox"/>	<input type="text"/>	<input type="text"/>

DHCP server (AP only)

Setting	Description	Factory Default
Enable	Enables AWK-5222 as a DHCP server	Disable
Disable	Disable DHCP server function	

Default gateway

Setting	Description	Factory Default
IP address of a default gateway	The IP address of the router that connects to an outside network	None

Subnet mask

Setting	Description	Factory Default
subnet mask	Identifies the type of sub-network (e.g., 255.255.0.0 for a Class B network, or 255.255.255.0 for a Class C network)	None

Primary/ Secondary DNS server

Setting	Description	Factory Default
IP address of Primary/ Secondary DNS server	The IP address of the DNS Server used by your network. After entering the DNS Server's IP address, you can use URL as well. The Secondary DNS server will be used if the Primary DNS server fails to connect.	None

Start IP address

Setting	Description	Factory Default
IP address	Indicates the IP address which AWK-5222 can start assigning	None

Maximum number of users

Setting	Description	Factory Default
1 – 999	Specifies how many IP address can be assigned continuously	None

Client lease time

Setting	Description	Factory Default
1 – 10 days	The lease time for which an IP address is assigned. The IP address may go expired after the lease time is reached.	10 (days)

Packet Filters

The AWK-5222 includes various filters for **IP-based** packets going through LAN and WLAN interfaces. You can set these filters as a firewall to help enhance network security.

MAC Filter

The AWK-5222's MAC filter is a policy-based filter that can allow or filter out IP-based packets with specified MAC addresses. The AWK-5222 provides 8 entities for setting MAC addresses in your filtering policy. Remember to check the **Active** check box for each entity to activate the setting.

MAC Filters

Enable

Policy

No	<input type="checkbox"/> Active	Name	MAC address
1	<input type="checkbox"/>	<input type="text"/>	<input type="text"/>
2	<input type="checkbox"/>	<input type="text"/>	<input type="text"/>
3	<input type="checkbox"/>	<input type="text"/>	<input type="text"/>

Enable

Setting	Description	Factory Default
Enable	Enables MAC filter	Disable
Disable	Disables MAC filter	

Policy

Setting	Description	Factory Default
Accept	Only the packets fitting the entities on list can be allowed.	Drop
Drop	Any packet fitting the entities on list will be denied.	



ATTENTION

Be careful when you enable the filter function:

Drop + “no entity on list is activated” = all packets are **allowed**

Accept + “no entity on list is activated” = all packets are **denied**

IP Protocol Filter

The AWK-5222's IP protocol filter is a policy-based filter that can allow or filter out IP-based packets with specified IP protocol and source/destination IP addresses.

The AWK-5222 provides 8 entities for setting IP protocol and source/destination IP addresses in your filtering policy. Four IP protocols are available: **All**, **ICMP**, **TCP**, and **UDP**. You must specify either the Source IP or the Destination IP. By combining IP addresses and netmasks, you can specify a single IP address or a range of IP addresses to accept or drop. For example, "IP address 192.168.1.1 and netmask 255.255.255.255" refers to the sole IP address 192.168.1.1. "IP address 192.168.1.1 and netmask 255.255.255.0" refers to the range of IP addresses from 192.168.1.1 to 192.168.255. Remember to check the **Active** check box for each entity to activate the setting.

IP Protocol Filters

Enable

Policy

No	<input type="checkbox"/> Active	Protocol	Source IP	Source netmask	Destination IP	Destination netmask
1	<input type="checkbox"/>	All				
2	<input type="checkbox"/>	All				
3	<input type="checkbox"/>	All				

Enable

Setting	Description	Factory Default
Enable	Enables IP protocol filter	Disable
Disable	Disables IP protocol filter	

Policy

Setting	Description	Factory Default
Accept	Only the packets fitting the entities on the list can be allowed	Drop
Drop	Any packet fitting the entities on the list will be denied	



ATTENTION

Be careful when you enable the filter function:

Drop + "no entity on list is activated" = all packets are **allowed**.

Accept + "no entity on list is activated" = all packets are **denied**.

TCP/UDP Port Filter

The AWK-5222's TCP/UDP port filter is a policy-based filter that can allow or filter out TCP/UDP-based packets with a specified source or destination port.

The AWK-5222 provides 8 entities for setting the range of source/destination ports of a specific protocol. In addition to selecting TCP or UDP protocol, you can set either the source port, destination port, or both. The end port can be left empty if only a single port is specified. Of course, the end port cannot be larger than the start port.

The **Application name** is a text string that describes the corresponding entity with up to 31 characters. Remember to check the **Active** check box for each entity to activate the setting.

TCP/UDP Port Filters

Enable

Policy

No	<input type="checkbox"/> Active	Source port	Destination port	Protocol	Application name
1	<input type="checkbox"/>	<input type="text"/> ~ <input type="text"/>	<input type="text"/> ~ <input type="text"/>	TCP	<input type="text"/>
2	<input type="checkbox"/>	<input type="text"/> ~ <input type="text"/>	<input type="text"/> ~ <input type="text"/>	TCP	<input type="text"/>
3	<input type="checkbox"/>	<input type="text"/> ~ <input type="text"/>	<input type="text"/> ~ <input type="text"/>	TCP	<input type="text"/>

Enable

Setting	Description	Factory Default
Enable	Enables TCP/UDP port filter	Disable
Disable	Disables TCP/UDP port filter	

Policy

Setting	Description	Factory Default
Accept	Only the packets fitting the entities on list can be allowed.	Drop
Drop	Any packet fitting the entities on list will be denied.	



ATTENTION

Be careful when you enable the filter function:

Drop + “no entity on list is activated” = all packets are **allowed**

Accept + “no entity on list is activated” = all packets are **denied**

RSTP Settings (for Redundant AP or AP mode only)

AWK-5222 supports IEEE802.1D Spanning Tree Protocol and IEEE802.1w Rapid STP standards. In addition to eliminating unexpected path looping, STP/RSTP can provide a backup path recovery if a wired/ wireless path fails accidentally. The reliability and availability can increase because this fail-over function.

AWK-5222's STP/RSTP feature is disabled by default. To be completely effective, you must enable RSTP/STP on every AWK-5222 connected to your network. If AWK-5222 plays a **Client** role, which is connected to a device (PLC, RTU, etc.) as opposed to network switch equipment, it is not necessary to enable STP/RSTP. The reason is that it will cause unnecessary negotiation.

The following figures indicate which Spanning Tree Protocol parameters can be configured. A more detailed explanation of each parameter is given below the figure.

DHCP Server (for Redundant AP or AP mode only)

RSTP status	-----
Bridge priority	<input type="text" value="32768"/> ▾
Hello time	<input type="text" value="2"/> (1~10 seconds)
Forwarding delay	<input type="text" value="15"/> (4~30 seconds)
Max age	<input type="text" value="20"/> (6~40 seconds)

No	<input type="checkbox"/> Enable RSTP	Port priority	Port cost	<input type="checkbox"/> Edge port	Status
1 (LAN1)	<input type="checkbox"/>	<input type="text" value="128"/> ▾	<input type="text" value="200000"/>	<input type="checkbox"/>	---
2 (LAN2)	<input type="checkbox"/>	<input type="text" value="128"/> ▾	<input type="text" value="200000"/>	<input type="checkbox"/>	---
3 (WLAN 1 : Redundant AP)	<input type="checkbox"/>	<input type="text" value="128"/> ▾	<input type="text" value="2000000"/>	<input checked="" type="checkbox"/>	---
4 (WLAN 2 : Redundant AP)	<input type="checkbox"/>	<input type="text" value="128"/> ▾	<input type="text" value="2000000"/>	<input checked="" type="checkbox"/>	---

RSTP status

This field will appear only when selected to operate STP/RSTP. It indicates whether this AWK-5222 is the Root of the Spanning Tree (the root is determined automatically) or not.

Bridge priority

Setting	Description	Factory Default
Numerical value selected by user	You can increase the bridge priority by selecting a lower number. A higher bridge priority brings a greater chance of being established as the root of the Spanning Tree topology.	32768

Hello time

Setting	Description	Factory Default
Numerical value input by user (1 – 10 seconds)	The root of the Spanning Tree topology periodically sends out a "hello" message to other devices on the network to check if the topology is healthy. Hello time indicates how often the root sends hello messages.	2 (seconds)

Forwarding delay

Setting	Description	Factory Default
Numerical value input by user (4 – 30 seconds)	The amount of time this device waits before checking to see if it should change to a different topology.	15 (seconds)

Max. age

Setting	Description	Factory Default
Numerical value input by user (6 – 40 seconds)	As a non-root role, if the device has not received a hello message from the root longer than Max. age , it will reconfigure itself as a root. Once two or more devices on the network are recognized as a root, the devices will renegotiate to set up a new Spanning Tree topology.	20 (seconds)

The AWK-5222 comes with 10 “ports” for RSTP settings. Numbers 3-10 (WDS1-WDS8) are available only when WDS is enabled in AP mode.

Enable RSTP

Setting	Description	Factory Default
Enable/ disable	Enables or disables the port as a node on the Spanning Tree topology.	Disable (unchecked)

Port priority

Setting	Description	Factory Default
Numerical value selected by user	Increase this port's priority as a node on the Spanning Tree topology by inputting a lower number.	128

Port cost

Setting	Description	Factory Default
Enable/ Disable	Input a higher cost to indicate that this port is less suitable as a node for the Spanning Tree topology	2000000

Edge port

Setting	Description	Factory Default
Checked/ unchecked	Sets a port, which no BPDU expectedly goes through, as an edge port	unchecked, except AP port

**NOTE**

We recommend you set an edge port for the port, which is connected to a non-STP/RSTP sub-network or an end device (PLC, RTU, etc.) as opposed to network equipment. This can prevent unnecessary waiting and negotiation of STP/RSTP protocol, and accelerate system initialization. When an edge port receives BPDUs, it can still function as an STP/RSTP port and start negotiation.

Setting an edge port is different from disabling STP/RSTP on a port. If you disable STP/RSTP, a port will not deal with STP/RSTP BPDUs at all.

Port Status

Port Status indicates the current Spanning Tree status of this port. Use **Forwarding** for normal transmission, or **Blocking** to block transmission.

SNMP Agent

The AWK-5222 supports SNMP V1/V2c/V3. SNMP V1 and SNMP V2c use a community string match for authentication, which means that SNMP servers access all objects with read-only or read/write permissions using the community string *public/private* (default value). SNMP V3, which requires you to select an authentication level of MD5 or SHA, is the most secure protocol. You can also enable data encryption to enhance data security.

The AWK-5222's MIB can be found in the software CD and supports reading the attributes via SNMP. (Only *get* method is supported.)

SNMP security modes and security levels supported by the AWK-5222 are shown in the following table. Select the security mode and level that will be used to communicate between the SNMP agent and manager.

Protocol Version	Setting on UI web page	Authentication Type	Data Encryption	Method
SNMP V1, V2c	V1, V2c Read Community	Community string	No	Use a community string match for authentication
	V1, V2c Write/Read Community	Community string	No	Use a community string match for authentication
SNMP V3	No-Auth	No	No	Use account with admin or user to access objects
	MD5 or SHA	Authentication based on MD5 or SHA	No	Provides authentication based on HMAC-MD5, or HMAC-SHA algorithms. 8-character passwords are the minimum requirement for authentication.
	MD5 or SHA	Authentication based on MD5 or SHA	Data encryption key	Provides authentication based on HMAC-MD5 or HMAC-SHA algorithms, and data encryption key. 8-character passwords and a data encryption key are the minimum requirements for authentication and encryption.

The following parameters can be configured on the **SNMP Agent** page. A more detailed explanation of each parameter is given below the following figure.

SNMP Agent

Enable	Disable ▾
Read community	public
Write community	private
SNMP agent version	V1, V2c ▾
Admin auth type	No Auth ▾
Admin privacy key	Disable ▾
Privacy key	
Private MIB information	
Device object ID	enterprise.8691.15.1

Enable

Setting	Description	Factory Default
Enable	Enables SNMP Agent	Disable
Disable	Disables SNMP Agent	

Read community (for V1, V2c, V3 or V1, V2c)

Setting	Description	Factory Default
Read Community	Use a community string match with a maximum of 31 characters for authentication. This means that the SNMP agent can access all objects with read-only permissions using this community string.	public

Write community (for V1, V2c, V3 or V1, V2c)

Setting	Description	Factory Default
Read /Write Community	Use a community string match with a maximum of 31 characters for authentication. This means that the SNMP agent can accesses all objects with read/write permissions using this community string.	private

SNMP agent version

Setting	Description	Factory Default
V1, V2c, V3, or V1, V2c, or V3 only	Select the SNMP protocol version used to manage the switch.	V1, V2c

Admin auth type (for V1, V2c, V3, and V3 only)

Setting	Description	Factory Default
No Auth	Use admin account to access objects. No authentication	No Auth
MD5	Provide authentication based on the HMAC-MD5 algorithms. 8-character passwords are the minimum requirement for authentication.	
SHA	Provides authentication based on HMAC-SHA algorithms. 8-character passwords are the minimum requirement for authentication.	

Admin private key (for V1, V2c, V3, and V3 only)

Setting	Description	Factory Default
Disable	No data encryption	Disable
DES	DES-based data encryption	
AES	AES-based data encryption	

Private key

A data encryption key is the minimum requirement for data encryption (maximum of 63 characters)

Private MIB Information Device Object ID

Also know as **OID**. This is the AWK-5222's enterprise value. It is fixed.

Storm Protection

In general, one host should not be allowed to occupy unlimited bandwidth, particularly when the device malfunctions. For example, so-called "broadcast storms" could be caused by an incorrectly configured topology or a malfunctioning device. The AWK-5222 not only prevents broadcast storms, but can also be configured to a different ingress rate for all packets, giving administrators full control of their limited bandwidth to prevent undesirable effects caused by unpredictable faults.

Storm Protection

Storm protection

Enable Disable

Multicast & flooding

Enable Disable

Setting	Description	Factory Default
Enable/Disable	Enable or disable the Broadcast Storm Protection for multicast packet globally	Enable (for unknown multicast and unknown unicast packet)
	Enable or disable the Broadcast Storm Protection for unknown multicast and unknown unicast packets globally.	

Auto Warning Settings

Since industrial-grade devices are often located at the endpoints of a system, these devices will not always know what is happening elsewhere on the network. This means that these devices, including wireless APs or clients, must provide system maintainers with real-time alarm messages. Even when system administrators are out of the control room for an extended period, they can still be informed of the status of devices almost instantaneously when exceptions occur.

In addition to logging these events, the AWK-5222 supports different approaches to warn engineers automatically, such as SNMP trap, e-mail, and relay output. It also supports two digital inputs to integrate sensors into your system to automate alarms by email and relay output.

System Log

System Log Event Types

Detail information for grouped events is shown in the following table. You can check the box for **Enable log** to enable the grouped events. All default values are enabled (checked). The log for system events can be seen in **Status → System Log**.

System log Event Types

Event group	Enable log
System-related events	<input checked="" type="checkbox"/>
Network-related events	<input checked="" type="checkbox"/>
Config-related events	<input checked="" type="checkbox"/>
Power events	<input checked="" type="checkbox"/>
DI events	<input checked="" type="checkbox"/>

System-related events	Event is triggered when...
System restart (warm start)	The AWK-5222 is rebooted, such as when its settings are changed (IP address, subnet mask, etc.).
Network-related events	Event is triggered when...
LAN link on	The LAN port is connected to a device or network.
LAN link off	The port is disconnected (e.g., the cable is pulled out, or the opposing device shuts down).
Client joined/ left (for Redundant AP, AP, or Master mode)	A wireless client is associated or disassociated.
WLAN connected to AP (for Redundant Client, Client, or Slave mode)	The AWK-5222 is associated with an AP.
WLAN disconnected (for Redundant Client, Client, or Slave mode)	The AWK-5222 is disassociated from an AP.
Config-related events	Event is triggered when...
Configuration Changed	A configuration item has been changed.
Configuration file import via Web Console	The configuration file is imported to the AWK-5222.
Console authentication failure	An incorrect password is entered.
Firmware upgraded	The AWK-5222's firmware is updated.
Power events	Event is triggered when...
Power 1/2 transition (On → Off)	The AWK-5222 is powered down in PWR1/2.
PoE transition (On → Off)	The AWK-5222 is powered down in PoE.
Power 1/2 transition (Off → On)	The AWK-5222 is powered via PWR1/2.
PoE transition (Off → On)	The AWK-5222 is powered via PoE.
DI events	Event is triggered when...
DI1/2 transition (On → Off)	Digital Input 1/2 is triggered by on to off transition
DI1/2 transition (Off → On)	Digital Input 1/2 is triggered by off to on transition

Syslog

This function provides the event logs for the Syslog server. The function supports up to three configurable Syslog servers and Syslog server UDP port numbers. When an event occurs, the event will be sent as a Syslog UDP packet to the specified Syslog servers.

Syslog Event Types

Detail information for the grouped events is shown in the following table. You can check the box for **Enable log** to enable the grouped events. All default values are enabled (checked). Details for each event group can be found on the “System log Event Types” table on page 3-31.

Syslog Event Types

Event group	Enable log
System-related events	<input checked="" type="checkbox"/>
Network-related events	<input checked="" type="checkbox"/>
Config-related events	<input checked="" type="checkbox"/>
Power events	<input checked="" type="checkbox"/>
DI events	<input checked="" type="checkbox"/>

Syslog Server Settings

You can configure the parameters for your Syslog servers in this page.

Syslog Server Settings

Syslog server 1	<input type="text"/>
Syslog port	<input type="text" value="514"/>
Syslog server 2	<input type="text"/>
Syslog port	<input type="text" value="514"/>
Syslog server 3	<input type="text"/>
Syslog port	<input type="text" value="514"/>

Syslog server 1/ 2/ 3

Setting	Description	Factory Default
IP address	Enter the IP address of the 1st/ 2nd/ 3rd Syslog Server	None

Syslog port

Setting	Description	Factory Default
Port destination (1 to 65535)	Enter the UDP port of the corresponding Syslog server	514

E-mail

E-mail Event Types

Check the box for **Active** to enable the event items. All default values are deactivated (unchecked). Details for each event item can be found on the “System log Event Types” table on page 3-31.

E-mail Event Types

Event	<input type="checkbox"/> Active
Cold start	<input type="checkbox"/>
Warm start	<input type="checkbox"/>
Power 1 transition (On-->Off)	<input type="checkbox"/>
Power 1 transition (Off-->On)	<input type="checkbox"/>
Power 2 transition (On-->Off)	<input type="checkbox"/>
Power 2 transition (Off-->On)	<input type="checkbox"/>
PoE transition (On-->Off)	<input type="checkbox"/>
PoE transition (Off-->On)	<input type="checkbox"/>
Configuration changed	<input type="checkbox"/>
Console authentication failure	<input type="checkbox"/>
DI 1 transition (On-->Off)	<input type="checkbox"/>
DI 1 transition (Off-->On)	<input type="checkbox"/>
DI 2 transition (On-->Off)	<input type="checkbox"/>
DI 2 transition (Off-->On)	<input type="checkbox"/>
LAN 1 link On	<input type="checkbox"/>
LAN 1 link Off	<input type="checkbox"/>
LAN 2 link On	<input type="checkbox"/>
LAN 2 link Off	<input type="checkbox"/>

E-mail Server Settings

You can set up to 4 e-mail addresses to receive alarm emails from the AWK-5222. The following parameters can be configured on the **E-mail Server Settings** page. In addition, a **Send Test Mail** button can be used to test whether the Mail server and e-mail addresses work well. More detailed explanations about these parameters are given after the following figure.

E-mail Server Settings

Mail server (SMTP)	<input type="text"/>
User name	<input type="text"/>
Password	<input type="text"/>
From e-mail address	<input type="text"/>
To e-mail address 1	<input type="text"/>
To e-mail address 2	<input type="text"/>
To e-mail address 3	<input type="text"/>
To e-mail address 4	<input type="text"/>

Mail server (SMTP)

Setting	Description	Factory Default
IP address	The IP Address of your email server.	None

User name & Password

Setting	Description	Factory Default
	User name and password used in the SMTP server	None

From e-mail address

Setting	Description	Factory Default
Max. 63 characters	Enter the administrator's e-mail address which will be shown in the "From" field of a warning e-mail.	None

To E-mail address 1/ 2/ 3/ 4

Setting	Description	Factory Default
Max. 63 characters	Enter the receivers' e-mail addresses.	None

Relay

The AWK-5222 has one relay output, which consists of 2 terminal block contacts on the AWK-5222's top panel. These relay contacts are used to indicate user-configured events and system failure.

The two wires attached to the relay contacts form an open circuit when a user-configured event is triggered. If a user-configured event does not occur, the relay circuit will remain closed. For safety reasons, the relay circuit is kept open when the AWK-5222 is not powered.

Relay Event Types

You can check the box for **Active** to enable the event items. All default values are deactivated (unchecked). Details for each event item can be found in the "System log Event Types" table on page 3-31.

Relay Event Types

Event	Active
Power 1 transition (On-->Off)	<input type="checkbox"/>
Power 2 transition (On-->Off)	<input type="checkbox"/>
PoE transition (On-->Off)	<input type="checkbox"/>
DI 1 transition (On-->Off)	<input type="checkbox"/>
DI 1 transition (Off-->On)	<input type="checkbox"/>
DI 2 transition (On-->Off)	<input type="checkbox"/>
DI 2 transition (Off-->On)	<input type="checkbox"/>
LAN 1 link On	<input type="checkbox"/>
LAN 1 link Off	<input type="checkbox"/>
LAN 2 link On	<input type="checkbox"/>
LAN 2 link Off	<input type="checkbox"/>

Trap

Traps can be used to signal abnormal conditions (notifications) to a management station. This trap-driven notification can make your network more efficient.

Because a management station usually takes care of a large number of devices that have a large number of objects, it will be overloading for the management station to poll or send requests to query every object on every device. It would be better if the managed device agent could notify the management station by sending a message known as a trap for the event.

Trap Event Types

Trap Event Types

Event	<input type="checkbox"/> Active
Cold start	<input type="checkbox"/>
Warm start	<input type="checkbox"/>
Power 1 transition (On-->Off)	<input type="checkbox"/>
Power 1 transition (Off-->On)	<input type="checkbox"/>
Power 2 transition (On-->Off)	<input type="checkbox"/>
Power 2 transition (Off-->On)	<input type="checkbox"/>
PoE transition (On-->Off)	<input type="checkbox"/>
PoE transition (Off-->On)	<input type="checkbox"/>
Configuration changed	<input type="checkbox"/>
Console authentication failure	<input type="checkbox"/>
DI 1 transition (On-->Off)	<input type="checkbox"/>
DI 1 transition (Off-->On)	<input type="checkbox"/>
DI 2 transition (On-->Off)	<input type="checkbox"/>
DI 2 transition (Off-->On)	<input type="checkbox"/>
LAN 1 link On	<input type="checkbox"/>
LAN 1 link Off	<input type="checkbox"/>
LAN 2 link On	<input type="checkbox"/>
LAN 2 link Off	<input type="checkbox"/>

SNMP Trap Receiver Settings

SNMP traps are defined in SMIv1 MIBs (SNMPv1) and SMIv2 MIBs (SNMPv2c). The two styles are basically equivalent, and it is possible to convert between the two. You can set the parameters for SNMP trap receivers through the web page.

SNMP Trap Receiver Settings

1st Trap version	V1
1st Trap server IP/name	V1 V2
1st Trap community	alert
2nd Trap version	V1
2nd Trap server IP/name	
2nd Trap community	alert

1st / 2nd Trap version

Setting	Description	Factory Default
V1	SNMP trap defined in SNMPv1	V1
V2	SNMP trap defined in SNMPv2	

1st / 2nd Trap server IP/name

Setting	Description	Factory Default
IP address or host name	Enter the IP address or name of the trap server used by your network.	None

1st / 2nd Trap community

Setting	Description	Factory Default
Max. 31 characters	Use a community string match with a maximum of 31 characters for authentication.	alert

Status

Wireless Status

The status for **802.11 info** parameters, such as Operation mode and Channel, are shown on the **Wireless Status** page. The status will refresh every 5 seconds if the **Auto refresh** box is checked.

Certain values for **802.11 info** may not appear with different operation modes. For example, **Current BSSID** and **RSSI** are not available in Redundant AP, AP, or Master modes.

It is helpful to use the **continuously updated information** on this page, such as RSSI, to monitor the signal strength of the AWK-5222 in Redundant Client, Client, or Slave mode.

Wireless Status

Auto refresh

Show status of WLAN 1 (SSID: MOXA_1) ▼

802.11 info	
Operation mode	AP-Client - Client (WLAN 1)
Channel	Not connected
RF type	B/G Mixed
SSID	MOXA_1
Security mode	OPEN
Current BSSID	N/A
Signal strength	▬▬▬▬
Transmission rate	N/A
Transmission power	Full

Associated Client List (for Redundant AP, AP, or Master mode only)

Associated Client List shows all the clients that are currently associated to a particular AWK-5222. You can click **Select all** to select all the content in the list for further editing. You can click **Refresh** to refresh the list.

Associated Client List

1.	<00:13:ce:e1:ee:ef>
----	---------------------

Select all Refresh

DHCP Client List (for AP mode only)

When you enable the DHCP server, the DHCP Client List shows all the clients that require and have successfully received IP assignments. You can click the **Refresh** button to refresh the list.

DHCP Client List

	MAC	IP
1.	00:13:ce:e1:ee:ef	192.168.127.2

Select all Refresh

You can press **Select all** button to select all content in the list for further editing.

	MAC	IP
1.	00:13:ce:e1:ee:ef	192.168.127.2

Cut
Copy
Paste
Select All
Print

Select all Refresh

System Log

Triggered events are recorded in System Log. You can export the log contents to an available viewer by clicking **Export Log**. You can use the **Clear Log** button to clear the log contents and the **Refresh** button to refresh the log.

System Log

```
( 116) 2008/06/18,20h:46m:50s Power 1 transition (Off -> On)
( 117) 2008/06/18,20h:46m:50s LAN link on
( 118) 2008/06/18,21h:17m:01s System restart
( 119) 2008/06/18,21h:17m:10s Power 1 transition (Off -> On)
( 120) 2008/06/18,21h:17m:10s LAN link on
( 121) 2008/06/18,21h:19m:55s System restart
( 122) 2008/06/18,21h:20m:04s Power 1 transition (Off -> On)
( 123) 2008/06/18,21h:20m:04s LAN link on
( 124) 2008/06/18,21h:20m:21s Client 00:13:CE:E1:EE:EF joined
( 125) 2008/06/18,21h:21m:31s Client 00:13:CE:E1:EE:EF joined
( 126) 2008/06/18,21h:26m:05s System restart
( 127) 2008/06/18,21h:26m:14s Power 1 transition (Off -> On)
( 128) 2008/06/18,21h:26m:14s LAN link on
( 129) 2008/06/18,21h:26m:18s Client 00:13:CE:E1:EE:EF joined
( 130) 2008/06/18,21h:26m:33s Client 00:13:CE:E1:EE:EF joined
( 131) 2008/06/18,21h:27m:22s Client 00:13:CE:E1:EE:EF leaved
( 132) 2008/06/18,21h:28m:22s Client 00:13:CE:E1:EE:EF joined
( 133) 2008/06/18,21h:28m:51s Client 00:13:CE:E1:EE:EF joined
```

Export Log Clear Log Refresh

Relay Status

The status of user-configurable events can be found under **Relay Status**. The status will refresh every 5 seconds if the **Auto refresh** box is checked.

If an event is triggered, it will be noted on this list. System administrators can click **Acknowledge Event** when he has acknowledged the event and addressed it.

Relay Status

Auto refresh

Relay Status		
Power 1 transition (On-->Off)	---	Acknowledge Event
Power 2 transition (On-->Off)	---	Acknowledge Event
PoE transition (On-->Off)	---	Acknowledge Event
DI 1 transition (On-->Off)	---	Acknowledge Event
DI 1 transition (Off-->On)	---	Acknowledge Event
DI 2 transition (On-->Off)	---	Acknowledge Event
DI 2 transition (Off-->On)	---	Acknowledge Event
LAN 1 link On	---	Acknowledge Event
LAN 1 link Off	---	Acknowledge Event
LAN 2 link On	---	Acknowledge Event
LAN 2 link Off	---	Acknowledge Event

DI and Power Status

The status of power inputs and digital inputs is shown on this web page. The status will refresh every 5 seconds if the **Auto refresh** box is checked.

Din and Power status

Auto refresh

Input status	On / Off
Power 1 status	On
Power 2 status	Off
PoE status	Off
DI 1 status	Off
DI 2 status	Off

Maintenance

Maintenance functions provide the administrator with tools to manage the AWK-5222 and wired/wireless networks.

Console Settings

You can enable or disable access permission for the following consoles: HTTP, HTTPS, Telnet and SSH connections. For more security, we recommend you only allow access to the two secured consoles, HTTPS and SSH.

Console Settings

HTTP console Enable Disable
HTTPS console Enable Disable
Telnet console Enable Disable
SSH console Enable Disable

Submit

Ping

Ping helps to diagnose the integrity of wired or wireless networks. By inputting a node's IP address in the **Destination** field, you can use the **ping** command to make sure it exists and whether or not the access path is available.

Ping

Destination
 Ping

If the node and access path are available, you will see that all packets were successfully transmitted with no loss. Otherwise, some, or even all, packets may get lost, as shown in the following figure.

Ping

Destination

Ping

PING 192.168.127.2 (192.168.127.2): 56 data bytes

--- 192.168.127.2 ping statistics ---

4 packets transmitted, 0 packets received, 100% packet loss

Firmware Upgrade

The AWK-5222 can be enhanced with more value-added functions by installing firmware upgrades. The latest firmware is available at Moxa's download center.

Before running a firmware upgrade, make sure the AWK-5222 is off-line. Click the **Browse** button to specify the firmware image file and click **Firmware Upgrade and Restart** to start the firmware upgrade. After the progress bar reaches 100%, the AWK-5222 will reboot itself.

When upgrading your firmware, the AWK-5222's other functions are forbidden.

Firmware Upgrade

Select update image



ATTENTION

Please make sure the power source is stable when you upgrade your firmware. An unexpected power breakup may damage your AWK-5222.

Config Import Export

You can back up or restore the AWK-5222's configuration with **Config Import Export**.

In the **Config Import** section, click **Browse** to specify the configuration file and click **Config Import** button to begin importing the configuration.

Config Import

Select configuration file

In the **Config Export** section, click the **Config Export** button and save the configuration file onto your local storage media. The configuration file is a text file and you can view and edit it with a general text-editing tool.

Config Export

Load Factory Default

Use this function to reset the AWK-5222 and roll all settings back to the factory default values. You can also reset the hardware by pressing the reset button on the top panel of the AWK-5222.

Load Factory Default

Reset to Factory Default

Click **Activate** to reset all settings, including the console password, to the factory default values.

The system will be restarted immediately.

Password

You can change the administration password for each of the AWK-5222's console managers by using the **Password** function. Before you set up a new password, you must input the current password and reenter the new password for confirmation. For your security, do not use the default password **root**, and remember to change the administration password regularly.

Password

Current password

New password

Confirm password

Misc. Settings

Additional settings to help you manage your AWK-5222, are available on this page.

Misc. Settings

Reset button

Always enable Disable after 60 sec

Reset button

Setting	Description	Factory Default
Always enable	The AWK-5222's Reset button works normally.	Always enable
Disable after 60 sec	The AWK-5222's Reset button will become invalid 60 seconds after the AWK-5222 completes booting.	

Save Configuration

The following figure shows how the AWK-5222 stores the setting changes into volatile and non-volatile memory. All data stored in volatile memory will disappear when the AWK-5222 is shutdown or rebooted unless they are y. Because the AWK-5222 starts up and initializes with the settings stored in flash memory, all new changes must be saved to flash memory before restarting the AWK-5222.

This also means the new changes will not work unless you run either the **Save Configuration** function or the **Restart** function.

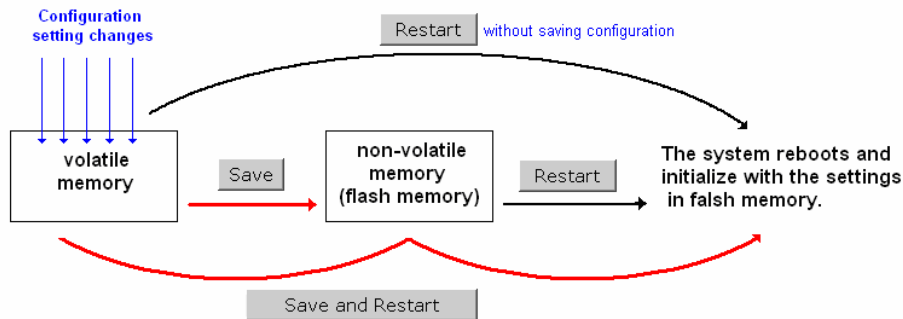

After you click on **Save Configuration** in the left menu box, the following screen will appear. Click **Save** if you wish to update the configuration settings in the flash memory at this time. Alternatively, you may choose to run other functions and put off saving the configuration until later. However, the new setting changes will remain in the non-volatile memory until you save the configurations.

Save Configuration

If you have submitted any configuration changes, you must save the changes and restart the system before they take effect. Click **Save** to save the changes in AWK-5222-US's memory. Click **Restart** to activate new settings in the navigation panel.

Save

Restart

If you submitted configuration changes, you will find a blinking string in the upper right corner of the screen. After making all your changes, click the **Restart** function in the left menu box. One of two different screens will appear.

If you made changes recently but did not save, you will be given two options. Clicking the **Restart** button here will reboot the AWK-5222 directly, and all setting changes will be ignored. Clicking the **Save and Restart** button will apply all setting changes and then reboot the AWK-5222.

Restart

!!! Warning !!!

Click "Restart" to discard changes and reboot AWK-5222-US directly.

Click "Save and Restart" to apply all setting changes and reboot AWK-5222-US.

Restart

Save and Restart

If you run the **Restart** function without changing any configurations or saving all your changes, you will see just one **Restart** button on your screen.

Restart

!!! Warning !!!

Clicking Restart will disconnect all Ethernet connections and reboot AWK-5222-US.

Restart

You will not be able to run any of the AWK-5222's functions while the system is rebooting.

Logout

Logout helps users disconnect the current HTTP or HTTPS session and go to the Login page. For security reasons, we recommend you logout before quitting the console manager.

Logout

Click **Logout** button to default Login page.

Logout

Other Console Configurations

This chapter explains how to access the AWK-5222 for the first time. In addition to HTTP access, there are four ways to access AWK-5222: serial console, Telnet console, SSH console, and HTTPS console. The serial console connection method, which requires using a short serial cable to connect the AWK-5222 to a PC's COM port, can be used if you do not know the AWK-5222's IP address. The other consoles can be used to access the AWK-5222 over an Ethernet LAN, or over the Internet.

In this chapter, we cover the following topics:

- ❑ **RS-232 Console Configuration (115200, None, 8, 1, VT100)**
- ❑ **Configuration by Telnet and SSH Consoles**
- ❑ **Configuration by Web Browser with HTTPS/SSL**
- ❑ **Disabling Telnet and Browser Access**

**ATTENTION**

1. You **CANNOT** connect to the AWK-5222 by two or more of these console configurations simultaneously.
2. You can connect to the AWK-5222 simultaneously by web browser and serial/ Telnet /SSH console. However, we strongly suggest that you do **NOT** use more than one connection method at the same time. Following this advice will allow you to maintain better control over the configuration of your AWK-5222.

RS-232 Console Configuration (115200, None, 8, 1, VT100)

The serial console connection method, which requires using a short serial cable to connect the AWK-5222 to a PC's COM port, can be used if you do not know the AWK-5222's IP address. It is also convenient to use serial console configurations when you cannot access the AWK-5222 over Ethernet LAN, such as in the case of LAN cable disconnections or broadcast storming over the LAN.

**ATTENTION**

Do not use the RS-232 console manager when the AWK-5222 is powered at reversed voltage (ex. -48VDC), even though reverse voltage protection is supported.

If you need to connect the RS-232 console at reversed voltage, Moxa's TCC-82 isolator is your best solution.

**NOTE**

We recommend using **Moxa PComm (Lite)** Terminal Emulator, which can be downloaded free of charge from Moxa's website.

Before running PComm Terminal Emulator, use an RJ45 to DB9-F (or RJ45 to DB25-F) cable to connect the AWK-5222's RS-232 console port to your PC's COM port (generally COM1 or COM2, depending on how your system is set up). After installing PComm Terminal Emulator, take the following steps to access the RS-232 console utility.

1. From the Windows desktop, open the Start menu and start **PComm Terminal Emulator** in the PComm (Lite) group.

2. Select Open under Port Manager to open a new connection.

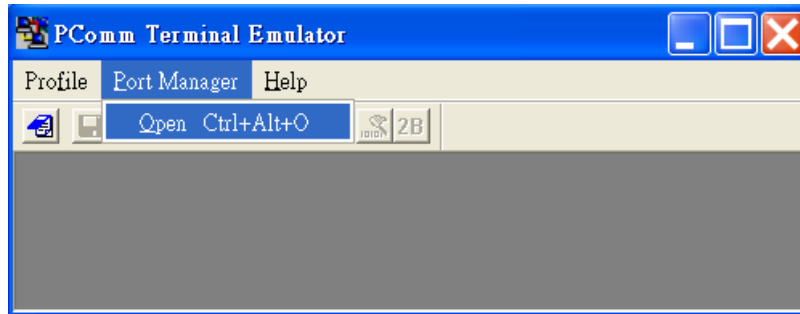

3. The **Communication Parameter** page of the Property window opens. Select the appropriate COM port for Console Connection, **115200** for Baud Rate, **8** for Data Bits, **None** for Parity, and **1** for Stop Bits.

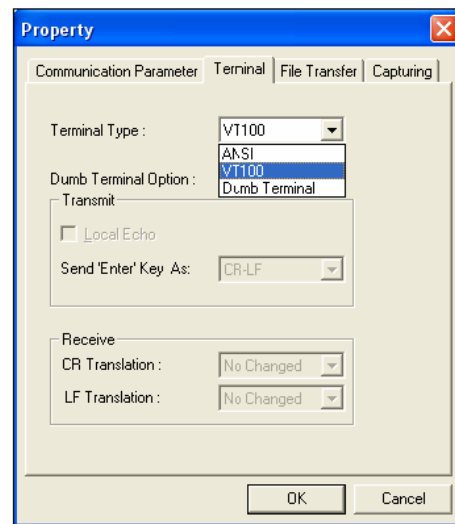
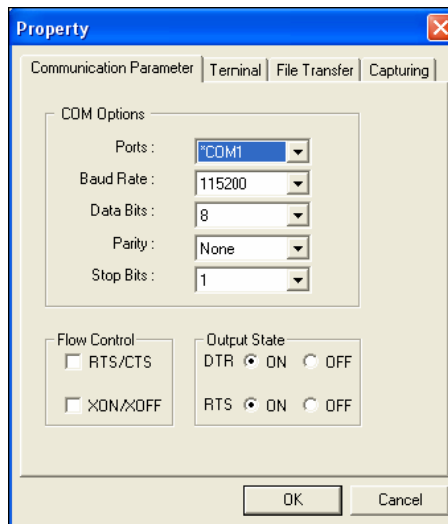

4. Click on the **Terminal** tab, and select **VT100 (or ANSI)** for Terminal Type. Click on **OK** to continue.
5. The Console login screen will appear. Log into the RS-232 console with the login name (default: **admin**) and password (default: **root**, if no new password is set).

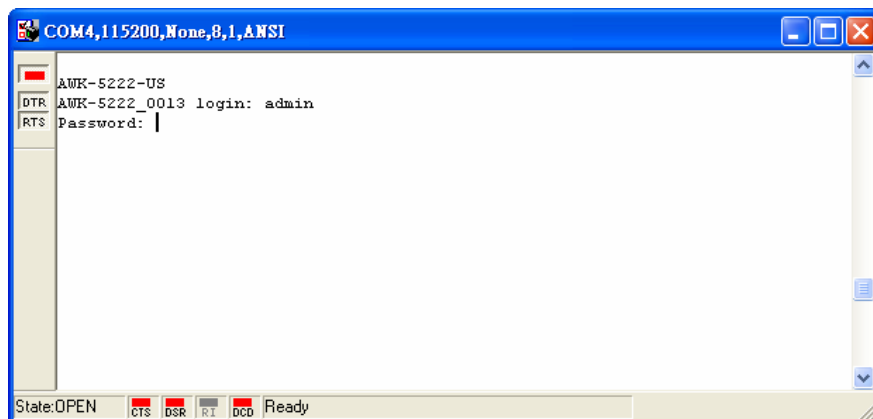

- The AWK-5222's device information and Main Menu will be displayed. Please follow the description on screen and select the administration option you wish to perform.

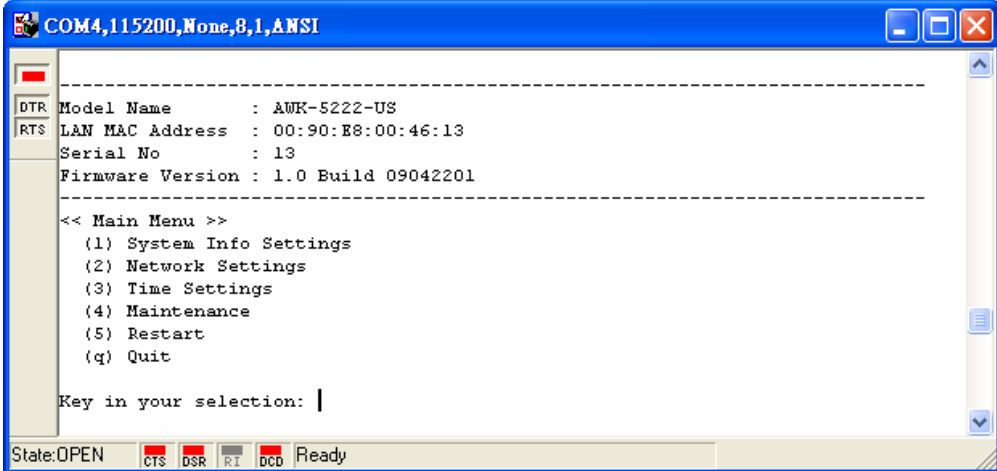

```
COM4,115200,None,8,1,ANSI
-----
DTR Model Name      : AWK-5222-US
RTS LAN MAC Address  : 00:90:E8:00:46:13
Serial No      : 13
Firmware Version : 1.0 Build 09042201
-----
<< Main Menu >>
(1) System Info Settings
(2) Network Settings
(3) Time Settings
(4) Maintenance
(5) Restart
(q) Quit

Key in your selection: |
State:OPEN  CTS DSR RT DCD Ready
```

**NOTE**

To modify the appearance of the PComm Terminal Emulator window, select **Edit** → **Font** and then choose the desired formatting options.

**ATTENTION**

If you unplug the RS-232 cable or trigger **DTR**, a disconnection event will be evoked to enforce logout for network security. You will need to log in again to resume operation.

Configuration by Telnet and SSH Consoles

You may use Telnet or SSH client to access the AWK-5222 and manage the console over a network. To access the AWK-5222's functions over the network from a PC host that is connected to the same LAN as the AWK-5222, you need to make sure that the PC host and the AWK-5222 are on the same logical subnet. To do this, check your PC host's IP address and subnet mask.

**NOTE**

The AWK-5222's default IP address is **192.168.127.253** and the default subnet mask is **255.255.255.0** (for a Class C network). If you do not set these values properly, please check the network settings of your PC host and then change the IP address to 192.168.127.xxx and subnet mask to 255.255.255.0.

Follow the steps below to access the console utility via Telnet or SSH client.

1. From Windows Desktop, run **Start > Run**, and then use Telnet to access the AWK-5222's IP address from the Windows Run window. (You may also issue the telnet command from the MS-DOS prompt.)

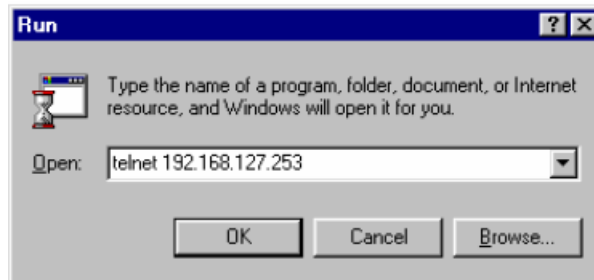

When using SSH client (ex. PuTTY), please run the client program (ex. putty.exe) and then input the AWK-5222's IP address, specifying **22** for the SSH connection port.

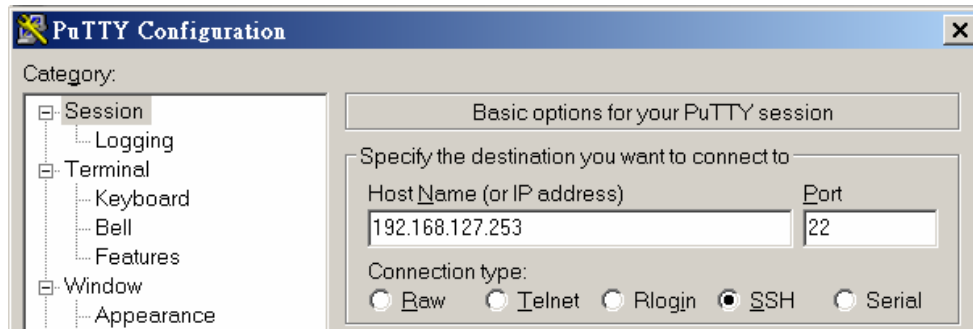

2. The Console login screen will appear. Please refer to the previous paragraph “RS-232 Console Configuration” and for login and administration.

Configuration by Web Browser with HTTPS/SSL

To secure your HTTP access, the AWK-5222 supports HTTPS/SSL encryption for all HTTP traffic. Perform the following steps to access the AWK-5222's web browser interface via HTTPS/SSL.

1. Open your web browser and type `https://<AWK-5222's IP address>` in the address field. Press **Enter** to establish the connection.

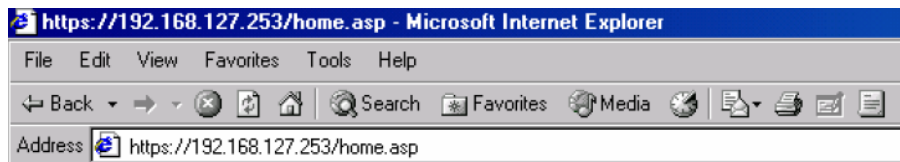

- 2. Warning messages will pop out to warn users that the security certificate was issued by a company they have not chosen to trust.

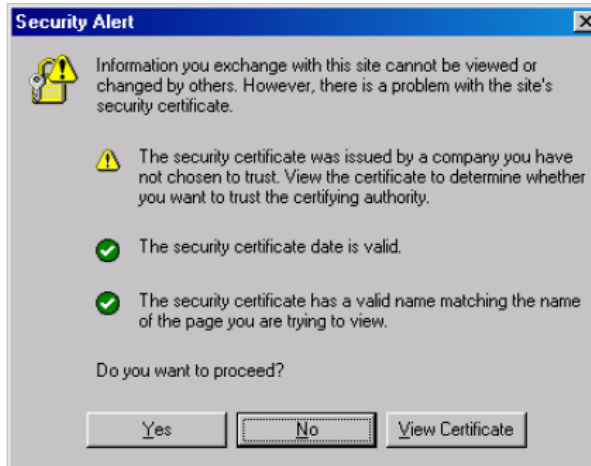

- 3. Select **Yes** to accept the certificate issued by Moxa IW and then enter the AWK-5222's web browser interface secured via HTTPS/SSL. (You can see the protocol in URL is **https**.) Then you can use the menu tree on the left side of the window to open the function pages to access each of AWK-5222's functions.

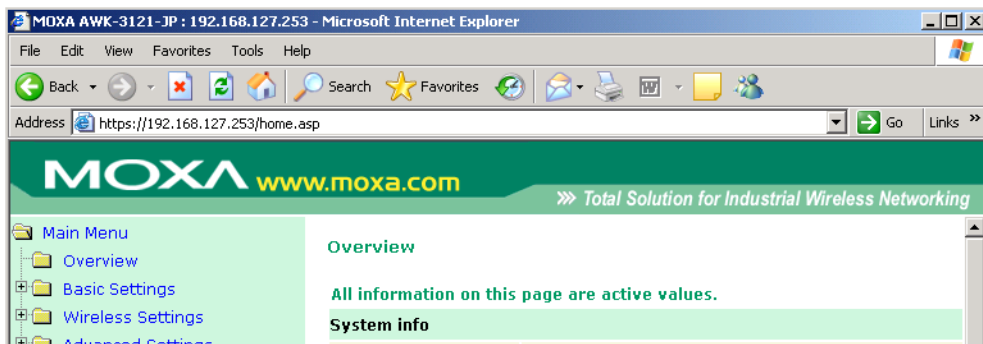

Disabling Telnet and Browser Access

If you are connecting the AWK-5222 to a public network but do not intend to use its management functions over the network, then we suggest disabling both Telnet Console and Web Configuration. Please run **Maintenance** → **Console Settings** to disable them, as shown in the following figure.

Console Settings

- HTTP console Enable Disable
- HTTPS console Enable Disable
- Telnet console Enable Disable
- SSH console Enable Disable

Submit

This chapter provides more detailed information about wireless-related technologies. The information in this chapter can help you administer your AWK-5222s and plan your industrial wireless network better.

The following topics are covered:

- ❑ **Beacon**
- ❑ **DTIM**
- ❑ **Fragment**
- ❑ **RTS Threshold**
- ❑ **STP and RSTP**
 - The STP/RSTP Concept
 - Differences between RSTP and STP

Beacon

A beacon is a packet broadcast by the AP to keep the network synchronized. A beacon includes the wireless LAN service area, the AP address, the Broadcast destination address, a time stamp, Delivery Traffic Indicator Maps (DTIM), and the Traffic Indicator Message (TIM). Beacon Interval indicates the frequency interval of AP.

DTIM

Delivery Traffic Indication Map (DTIM) is contained in beacon frames. It is used to indicate that broadcast and multicast frames buffered by the AP will be delivered shortly. Lower settings result in more efficient networking, while preventing your PC from dropping into power-saving sleep mode. Higher settings allow your PC to enter sleep mode, thus saving power.

Fragment

A lower setting means smaller packets, which will create more packets for each transmission. If you have decreased this value and experience high packet error rates, you can increase it again, but it will likely decrease overall network performance. Only minor modifications of this value are recommended.

RTS Threshold

RTS Threshold (256-2346) – This setting determines how large a packet can be before the Access Point coordinates transmission and reception to ensure efficient communication. This value should remain at its default setting of 2,346. When you encounter inconsistent data flow, only minor modifications are recommended.

STP and RSTP

The STP/RSTP Concept

Spanning Tree Protocol (STP) was designed to help reduce link failures in a network, and provide protection from loops. Networks that have a complicated architecture are prone to broadcast storms caused by unintended loops in the network. The STP protocol is part of the IEEE802.1D standard, 1998 Edition bridge specification.

Rapid Spanning Tree Protocol (RSTP) implements the Spanning Tree Algorithm and Protocol defined by IEEE802.1w-2001 standard. RSTP provides the following benefits:

- The topology of a bridged network will be determined much more quickly compared to STP.
- RSTP is backward compatible with STP, making it relatively easy to deploy. For example:
 - Defaults to sending 802.1D-style BPDUs if packets with this format are received.
 - STP (802.1D) and RSTP (802.1w) can operate on the LAN ports and WLAN ports (AP and WDS1-WDS8) of the same AWK-5222.

This feature is particularly helpful when the AWK-5222 connects to older equipment, such as legacy switches.

Differences between RSTP and STP

RSTP is similar to STP, but includes additional information in the BPDUs that allow each bridge to confirm that it has taken action to prevent loops from forming when it decides to enable a link to a neighboring bridge. Adjacent bridges connected via point-to-point links will be able to enable a link without waiting to ensure that all other bridges in the network have had time to react to the change. The main benefit of RSTP is that the configuration decision is made locally rather than network-wide, allowing RSTP to carry out automatic configuration and restore a link faster than STP.

6

Supporting Information

This chapter presents additional information about this manual and product. You can also learn how to contact Moxa for technical support.

The following topics are covered:

- ❑ **About This User's Manual**
- ❑ **DoC (Declaration of Conformity)**
 - Federal Communication Commission Interference Statement
 - R&TTE Compliance Statement
- ❑ **Firmware Recovery**
- ❑ **Technical Support Contact Information**

About This User's Manual

This manual is mainly designed for, but no limited to, the following hardware and firmware for the AWK-5222:

- Hardware Rev: **1.0**
- Firmware Ver: **1.0**

You are strongly recommended to visit Moxa's website (<http://www.moxa.com>) and find the latest product datasheet, firmware, QIG (Quick Installation Guide), UM (User's Manual) and related information.



NOTE

You can find out the hardware revision number of AWK-5222 on the side label.

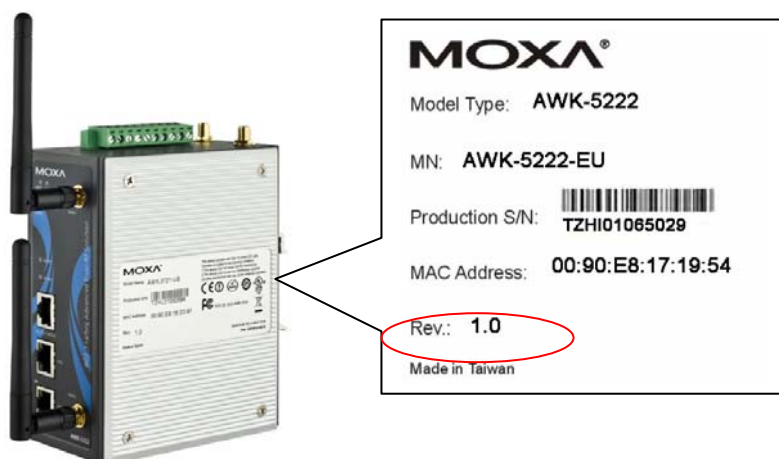

The firmware version number can be seen on the **Overview** page, as follow:

All information on this page are active values.

System info

Model name	AWK-5222-US
Device name	AWK-5222_0013
Serial No.	13
System up time	0 days 06h:02m:04s
Firmware version	1.0 Build 09042201

DoC (Declaration of Conformity)

Federal Communication Commission Interference Statement

This equipment has been tested and found to comply with the limits for a Class B digital device, pursuant to Part 15 of the FCC Rules. These limits are designed to provide reasonable protection against harmful interference in a residential installation. This equipment generates, uses and can radiate radio frequency energy and, if not installed and used in accordance with the instructions, may cause harmful interference to radio communications. However, there is no guarantee that interference will not occur in a particular installation. If this equipment does cause harmful interference to radio or television reception, which can be determined by turning the equipment off and on, the user is encouraged to try to correct the interference by one of the following measures:

- Reorient or relocate the receiving antenna.
- Increase the separation between the equipment and receiver.
- Connect the equipment into an outlet on a circuit different from that to which the receiver is connected.
- Consult the dealer or an experienced radio/TV technician for help.

FCC Caution: To assure continued compliance, (example – use only shielded interface cables when connecting to computer or peripheral devices). Any changes or modifications not expressly approved by the party responsible for compliance could void the user's authority to operate this equipment. This transmitter must not be co-located or operated in conjunction with any other antenna or transmitter.

FCC Radiation Exposure Statement

This equipment complies with FCC radiation exposure limits set forth for an uncontrolled environment. This equipment should be installed and operated with a minimum distance of 20 cm between the radiator & your body.

This device complies with Part 15 of the FCC Rules. Operation is subject to the following two conditions: (1) This device may not cause harmful interference, and (2) this device must accept any interference received, including interference that may cause undesired operation.

FCC 15.407(e): Within the 5.15-5.25 GHz band, U-NII devices will be restricted to indoor operations to reduce any potential for harmful interference to co-channel MSS operations.

R&TTE Compliance Statement

This equipment complies with all the requirements of DIRECTIVE 1999/5/CE OF THE EUROPEAN PARLIAMENT AND THE COUNCIL OF 9 March 1999 on radio equipment and telecommunication terminal equipment and the mutual recognition of their conformity (R&TTE).

The R&TTE Directive repeals and replaces in the directive 98/13/EEC (Telecommunications Terminal Equipment and Satellite Earth Station Equipment) as of April 8, 2000.

Safety

This equipment is designed with the utmost care for the safety of those who install and use it. However, special attention must be paid to the dangers of electric shock and static electricity when working with electrical equipment. All guidelines of this and of the computer manufacturer must therefore be allowed at all times to ensure the safe use of the equipment.

EU Countries Intended for Use

The ETSI version of this device is intended for home and office use in Austria, Belgium, Denmark, Finland, France (with Frequency channel restrictions), Germany, Greece, Ireland, Italy, Luxembourg, Portugal, Spain, Sweden, The Netherlands, and United Kingdom.

The ETSI version of this device is also authorized for use in EFTA member states Norway and Switzerland.

EU Countries Not Intended for Use

None.

Potential Restrictive Use

France: only channels 10, 11, 12, and 13.

CE Warning

This is a class B product. In a domestic environment this product may cause radio interference in which case the user may be required to take adequate measures.

Firmware Recovery

When the LEDs of **FAULT**, and **STATE** all light up simultaneously and blink at one-second interval, it means the system booting has failed. It may result from some wrong operation or uncontrollable issues, such as an unexpected shutdown during firmware update. The AWK-5222 is designed to help administrators recover such damage and resume system operation rapidly. You can refer to the following instructions to recover the firmware:

Connect to the AWK-5222's RS-232 console with **115200bps and N-8-1**. You will see the following message shown on the terminal emulator every one second.

```
Press Ctrl-C to enter Firmware Recovery Process.....
Press Ctrl-C to enter Firmware Recovery Process.....
Press Ctrl-C to enter Firmware Recovery Process.....
Press Ctrl-C to enter Firmware Recovery Process.....
Press Ctrl-C to enter Firmware Recovery Process.....
Press Ctrl-C to enter Firmware Recovery Process.....
Press Ctrl-C to enter Firmware Recovery Process.....
Press Ctrl-C to enter Firmware Recovery Process.....
Press Ctrl-C to enter Firmware Recovery Process.....
Press Ctrl-C to enter Firmware Recovery Process.....
Press Ctrl-C to enter Firmware Recovery Process.....
Press Ctrl-C to enter Firmware Recovery Process.....
```

Press **Ctrl - C** and the following message will appear.

```
Press Ctrl-C to enter Firmware Recovery Process.....
Press Ctrl-C to enter Firmware Recovery Process.....
=====
IP address of AWK-5222 : 192.168.40.155
Netmask of AWK-5222 : 255.255.252.0
Gateway of AWK-5222 : 192.168.43.254
IP address of TFTP server : 192.168.40.142
=====
1. Start to firmware upgrade using the above network setting immediately.
2. Change the network settings.
Enter your selection : (1-2,enter for abort): |
```

Enter **2** to change the network setting. Specify where the AWK-5222's firmware file on the TFTP server and press **y** to write the settings into flash memory.

```
=====
1. Start to firmware upgrade using the above network setting immediately.
2. Change the network settings.
Enter your selection : (1-2,enter for abort): 2

IP address of AWK-5222 : 192.168.1.2
IP address of TFTP server : 192.168.1.1
Netmask of AWK-5222 : 255.255.252.0
Gateway of AWK-5222 : 192.168.1.254
Update RedBoot non-volatile configuration - continue (y/n)? y
```

AWK-5222 restarts, and the "Press Ctrl-C to enter Firmware Recovery Process..." message will reappear. Press **Ctrl-C** to enter the menu and select **1** to start the firmware upgrade process.

```
Press Ctrl-C to enter Firmware Recovery Process.....
=====
IP address of AWK-5222 : 192.168.1.2
Netmask of AWK-5222 : 255.255.252.0
Gateway of AWK-5222 : 192.168.40.142
IP address of TFTP server : 255.255.252.0
=====
1. Start to firmware upgrade using the above network setting immediately.
2. Change the network settings.
Enter your selection : (1-2,enter for abort): 1
```

Select **0** in the sub-menu to load the firmware image via LAN, and then enter the file name of the firmware to start the firmware recovery.

```
=====
Load method select :
0. Load from LAN
1. Load from serial with Xmodem
q. Abort
=====
Please select item : 0
Please input file name.
Default file name : AWK-5222.rom
User Input file name : AWK-5222_1.0.rom|
```

Technical Support Contact Information

Customer satisfaction is our number one concern, and to ensure that customers receive the full benefit of our products, Moxa Internet Services has been set up to provide technical support, driver updates, product information, certification status, installation guide and user's manual updates.

The following services are provided:

- E-mail for technical support:
 - support@moxa.com (Worldwide)
 - support@usa.moxa.com (The Americas)
- World Wide Web (WWW) Site for product information:
<http://www.moxa.com>